

MINING - OTHER

1983 - 1984 JANUARY - DEC.

# Hope for uranium producers

27 Mercury  
11/1/83

**EMBATTLED** uranium producers can draw some solace from the continuing and increasing faith in their product shown by the South African Government.

In the face of a depressed and over-supplied market, and in spite of a stated commitment to constrain spending, the Department of Mineral and Energy Affairs has been allocated a 54,9 percent increase in funds for the Atomic Energy Research Fund, to R106 171 000 in fiscal 1983 from R68 526 000 previously.

The estimates of expenditure tabled by the Finance Minister, Mr Owen Horwood, in Parliament shows that current expenses on uranium enrichment

are expected to rise by 32,2 percent to R85 m from R64,3 m, while total estimated expenditure on uranium-related activities will jump to R315 558 000 from R250 235 000 in the year ended March 31, 1983.

## Research

An indication of the importance with which the Government views the future of nuclear power is that more than two-thirds of the total budget of the Department of Mineral and Energy Affairs for the current year is ab-

sorbed by uranium research.

However, it is incorrect to assume that this largesse on uranium extends to the producers of the raw material.

In a clear message to gold and uranium producers that the strongest in the industry would have to support the weakest, Mr Horwood described the increase in the tax surcharge on gold and diamond mines to 15 percent from 5 percent as a means of generating revenue to help finance the Gold Mines Assistance Scheme.

## State aid

While the increased tax is expected to raise an additional R115m in revenue, provision for State aid for the current year is R36,6 m compared with 1981's actual aid of R26,9 m (a Chamber of Mines figure).

It is perhaps significant that the disparity between the additional surcharge raised and total State aid of R78,4 m more than covers the R65 m increase in uranium research expenditure.

Meanwhile, the concept of State aid remains in a state of flux, with at least one major mining house advocating sweeping changes to the scheme.

Nine mines now qualify for State aid — Gencor's Stilfontein, West Rand Cons and Leslie, Rand Mines producers ERPM and Durban Roodepoort Deep, Anglovaal's ET Cons and Loraine, Goldfields' Venterspost and independent Wit Nigel.

## Outlook for uranium prices

Mercury Correspondent

**JOHANNESBURG**—Any material improvement in uranium prices is unlikely until new orders for nuclear reactors are placed and the perceived future oversupply situation diminishes significantly.

Mr Gerald Langton, chairman of the Afrikaner Lease, says in his annual review that forecast production from large mines planned in Australia and Canada is still responsible for the projected imbalance of supply over demand stretching throughout this decade.

'However, because of the rapid escalation of both capital and operating costs, a number of existing producers have already ceased or curtailed production and an increasing number of planned new production facilities will probably be shelved.'

It is unlikely that production planned from these operations will come about until there is a considerable strengthening in the market, says Mr Langton.

CONT

17/1/83

(217)

## Nuclear power

There are indications of a growing commitment to nuclear power as an economically and environmentally preferred energy alternative, and utility inventory levels, while still high, are unlikely to increase much further.

The uranium market continued to weaken in 1981, says Mr Langton, but the dramatic slide in spot prices seen during 1980 slowed considerably 'and there are indications that prices are close to bottoming out if they have not already done so'.

Early in 1981 continuing pressure on the uranium market was exerted by the enforced liquidation of surplus inventory by a number of power utilities, especially in the US.

'With contractual prices having risen well above spot prices and with the decline of dollar interest rates, especially in the second half of the year, the economic arguments favouring such inventory realisation by the utilities faded.'

Established producers with surplus production are also becoming increasingly unwilling to contract sales at what they see as unrealistic price levels, says Mr Langton

## Opposition

The argument against State aid in its present form is really opposition to subsidies in any form, or support of a free market, 'dog-eat-dog' approach.

Such a system, it is argued, would free the funds allocated for aid to further develop more profitable deposits.

It is felt that the expansion of these operations would absorb any labour retrenched from unprofitable mines, while at the same time increasing production to offset the loss of output from producers forced to close

While this is only one facet of the discussion on State aid, it is clear that the Government is concerned about the present form of the system, and last year appointed an inter-departmental committee to study the future of State aid.

## Oil search

As the development of uranium enrichment gains momentum, the search for oil has taken a back seat, and for the year to March 1983 Southern Oil Exploration Corporation (SOEKOR) has had its allocation cut by more than R10m, to R67 533 000 from R78 249 000, a decline of 25,8 percent in real terms if inflation is taken at 14 percent.

Another area to fall under the axe is the Cabora Bassa project, loans for which have been slashed by 47,6 percent to R2 880 000 from R5,5 m, while research on factors affecting present and future demand for energy is expected to cost R1 390 000 this year, against R628 000 in the year to March

# Settlement

reached

in asbestos  
Mercury  
dispute

Labour Reporter

A DISPUTE between the asbestos company Turnall Ltd and members of the South African Allied Workers' Union dating back to March last year was settled yesterday

A joint statement released by the union and the company said an out-of-court settlement had been reached

This was between the management of Turnall and certain workers formerly employed by the company following lengthy negotiations

'The settlement was reached with neither party conceding the validity of the case of the other,' the statement said

The dispute arose last March after a work stoppage when 33 workers formerly employed by Turnall Ltd alleged the company had refused to negotiate with them and was guilty of selective re-employment.

The company denied these charges, and the workers made a request to the Industrial Court to be reinstated



# Potential mine at Potgietersrus

217  
LOH  
15/11/83

Mining Editor

**RESULTS** from prospecting by Rustenburg Platinum near Potgietersrus indicate the possibility of setting up a low operating cost, open-cast mine with higher quantities of by-product metals than found at Rustenburg's other mines, says Mr Waddell.

"The capital expenditure involved would, however, be very high and given the present state of the market there would be no cause to increase production on the scale necessary to justify opening a mine at Potgietersrus," he told the annual meeting

Rustenburg Platinum was continuing to prospect in Lebowa in the area of Potgietersrus, and initial indications were there might be other more favourable deposits

One of the deposits being looked at in Lebowa was on the farm Maandagshoek where a small pilot operation was being set up by Rustenburg in conjunction with the Mining Corporation, a Government body set up to promote mining in the black national states

Rustenburg would spend the first R4-million on the project, after which funds needed would be provided pro rata by Rustenburg and the Mining Corporation. Rustenburg would hold 70% of the equity in any mine that might be started

About two to three years were needed to establish within what parameters the mining and treatment of the UG2 reef would be profitable.

Replying a question, Mr Waddell said the Maandagshoek deposit had sufficient potential to be of interest and it was important that Rustenburg have as much knowledge as possible about any platinum occurrence in the Bushveld Igneous complex

Any decision to set up a mine would not be considered for some time, and would depend on the view taken then of the market by Rustenburg and the Mining Corporation.

# Losing its shine

SA chrome ore exports have fallen 41% from the peak of 1,5 Mt in 1979. Despite production cuts of 47% in two years, producers have stockpiles of more than 1 Mt — bigger than last year's exports of 885 000 t. Exports this year could be even lower at about 850 000 t.

According to one producer, mines have been selling at little or no profit, a situation which could continue through 1983.

There is large overcapacity, and with more production cutbacks probable in 1983, the burden on the mines is expected to become heavier.

Prices on world markets have tumbled 36% since 1981. Only the falling rand has helped exporters but, as the rand hardens, an industry insider notes that forward cover is already becoming more problematic.

He complains that SA exporters, competing with each other for sales, have effectively been dealing in foreign exchange rather than chrome. "Prices have consequently fallen to an all-time low since 1977," he says. "It will take a tremendous effort over some years to get them up again."

The plight of the chrome industry in these markets contrasts with SA's image as a treasure house of strategic minerals. SA, Zimbabwe and the Soviet Union together hold 95% of world chromium reserves. One reason for the pressure on the SA industry

is that consumers overseas, concerned at potential instability in these areas, are diversifying their supplies.

SA's three main customers are Japan, the US and Europe, which each take about 30% of exports. Since 1979 their consumption patterns have changed. In that year, the metallurgical industry consumed 45% of SA ore, the chemical industry 31%, foundries 14% and refractories 10%. In 1982 the metallurgical industry took only 37%, the chemical industry 39%, foundries 15% and refractories 9%.

Sales have declined substantially to local ferrochrome companies which are leading world producers with an installed capacity of about 800 000 t/year. They are now said to be operating at only about 65% of capacity.

The Japanese have increased imports of ferrochrome instead of making it themselves, but they have taken higher tonnages from SA's competitors Zimbabwe (mainly exporting through Port Elizabeth), India and Brazil have increased ferrochrome capacities and Greece, the Philippines and Turkey are new producers. These countries have their own ore. Demand for the SA product, which is used in the production of ferrochrome, is thus reduced.

There is another danger. The industry is investing minimal new capital in its mines, another factor which will boost future pro-

duction costs.

SA supplies about 30% of total world output of chrome ore of 9 Mt/year. Local production fell from 3,8 Mt in 1980 to 3,3 Mt in 1981 and 2,4 Mt last year. Output this year will be 2 Mt or less.

The cutback involved several closures during 1982. The Union Carbide and Mining Corporation mines were closed and the Waterkloof and Samancor western Transvaal mines were placed on care and maintenance.

Negotiations for 1983 delivery were completed with US and European customers late last year. In March, talks will start with Japanese buyers on sales of ore for delivery in late 1983 and early 1984. One producer notes that the Japanese are now buying high grade, 3:1 ratio Albanian ore at about \$52 fob, the same price SA producers received for their lower quality, 1,5:1 ratio ore in firmer markets.

Albania used to route most of its ore exports to the Peoples Republic of China but, after a diplomatic break with that country, it is increasingly active in Western markets. A fairly high proportion of Albanian exports are bartered for fabricated goods, mainly seamless steel piping. This method of exporting raw materials is being adopted more often by countries with centrally planned economies but cannot readily be used by SA producers.

Other competition is coming from Turkey and Malagasy. A new producer, New Caledonia, an island north of Australia, is expected to increase its exports of high grade ore from 28 000 t last year to 100 000 t in 1983.

Prices for high-grade Transvaal ore used in chemical industries fell from the 1981 level of about \$61 fob Richards Bay to \$45-\$46 at last year's negotiations for 1983 deliveries.

Metallurgical ore prices declined from \$55 in 1979 to \$48 in 1981. The Japanese are said to be talking \$35 for ore to be delivered in 1983.

By the end of 1983, SA's share of Japanese chrome imports could have slipped from its accustomed 50% to about 30%-40%.

Until recently, SA producers operated probably the lowest-cost mines in the world. However, labour and other costs have climbed about 400% since 1977 and consequently SA mining costs now appear higher than those of some competitors.

A producer notes that fixed costs average R32-R34/t. Railage costs from Transvaal mines to Richards Bay nearly doubled from R12,60/t in April 1980 to R22/t in 1983.

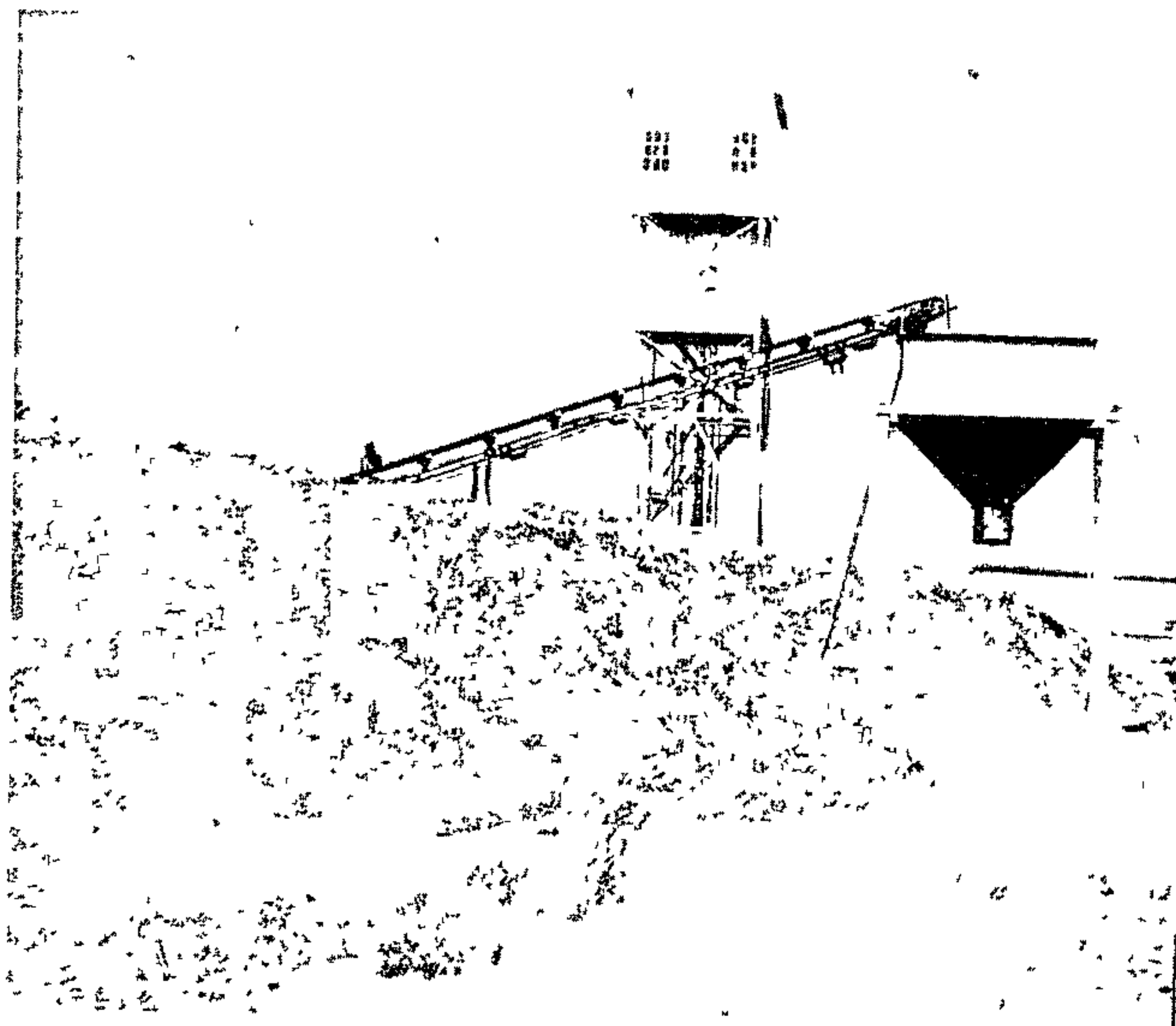

Chrome ore stockpile ... bigger than the sales



217 ROM 22/1/83

# SA PGM output dips, Soviets produce more

Year			
1970			
1971			
1972			
1973			
1974			
1975			
1976			
1977			
1978			
1979			
1980			

**WASHINGTON.** — World production of platinum group metals fell to 6 400 000 ounces last year from 6 810 000 in 1981, says the Bureau of Mines.

Output in South Africa fell to 2 600 000 ounces from 3-million Production in the Soviet Union rose to 3 500 000 ounces from 3 350 000

US imports of platinum group metals fell to 2 500 000 ounces last year from 2 850 000 in 1981 and exports dropped to 740 000 ounces from 867 000

Domestic stocks of platinum group metals at refiners, importers and dealers fell to 850 000 ounces at the end of 1982 from 947 000 a year earlier

Sales of platinum group metals to US industries fell 17% in 1982 to 1 600 000 ounces.

US demand for the metals, however, is expected to increase at an annual rate of 3% through 1990

\* \* \*

**WORLD** copper production dropped last year as the recession squeezed demand for metals in industrialised

countries, according to the bureau

World copper mines produced an estimated 7 800 000 tons in 1982, down from 8 200 000 tons in 1981 There were widespread mine closures and cutbacks in Africa, the United States, Canada and the Philippines

US copper demand in 1982 was the lowest in seven years, reflecting the slump in the car and housing industries, and Chile overtook the US as the world's largest copper-producing nation

The report was released as the two largest North American aluminium producers reported depressed results for 1982, with Alcan, the Canadian giant, saying it lost money for the first time in 50 years

Alcan, which announced a loss of \$58-million for 1982, said the price of aluminium ingots fell by an average 26% last year Alcoa, the largest US producer, announced a net profit of \$10 600 000 — down from \$296 200 000 in 1981

The bureau expects US demand for copper to increase at an annual rate of 3% up to 1990.

\* \* \*

Stocks at merchants totalled 40 000 tons against 69 000

Domestic demand for zinc is expected to increase at an annual rate of 1,1% through 1990

US mine output of lead in 1983 will be 525 000 tons, up from 510 000 in 1982 and 446 000 in 1981

US lead stocks at the end of 1982 fell to 155 000 tons from 195 000 a year earlier

US consumption of lead in 1983 will reach an estimated 1 100 000 tons, compared with 1 065 000 in 1982 and 1 037 000 in 1981.

Demand for lead is expected to go up at an annual rate of 2,5% through 1990, but the rate could be considerably lower if US consumption and the price of petrol and electricity do not increase significantly soon, says the bureau

\* \* \*

**WORLD** tin production fell to an estimated 238 000 tons last year from 253 000 in 1981

Production in Malaysia, the world's largest producer, dropped to 55 000 tons in 1982 from 60 000 in 1981. Output in the Soviet Union rose to 37 000 tons from 36 000.

The bureau put Bolivia's output at 26 000 tons against 29 800 in 1981, Indonesia's output at 32 000 tons against 35 000 and Thailand's at 30 000 tons against 32 000

US tin imports fell to an estimated 30 000 tons last year from 45 874 in 1981.

Stocks at consumers and dealers fell to an estimated 5 000 tons at the end of 1982 from 11 675 tons a year earlier

The bureau predicts US consumption of tin in 1983 will be 48 000 tons — up 2 000 from last year. US tin demand is expected to increase at an annual rate of less than 1% up to 1990 — Sapa-reuter.

Address: P.O. Box 978  
Pretoria  
0001

Officials: Secretary: J.A. van Wyk

Area of Operation:

Founded:

Registration: Yes

Du Toit  
+  
\*  
\*  
\*  
\$  
\$  
\$

# Manganese cut: SA warned

## Coal price may drop

By Geoffrey Murray  
Financial Correspondent

**TOKYO** — Japan's major manganese ore suppliers, including South Africa, are being warned to prepare themselves for marathan price negotiations for their fiscal 1983 contracts.

Industry sources say local ferro-alloy producers will be proposing radical price cuts to help them cope with collapsing business. None had been specific about price so far, but a trial balloon has been floated to check foreign reactions to a 20 percent cut.

To compete with low-priced imports of ferro-manganese, domestic producers are compelled to reduce their production costs.

Industry sources suggest the minimum requirement is a \$10 cut in the price of manganese ore a ton.

High-grade ore from Samancor and Assoman in fiscal 1982 cost \$79 by the time it landed in Japan.

### MARKDOWN

Japanese blast furnace steel-makers recently told their local ferro-alloy suppliers they must reduce their sales prices by about 20 000 yen in the next two years. If this cut was passed directly to the ore price, they said, this would require a markdown of \$40 a ton, which was impossible.

Many ferro-alloy producers are not optimistic about winning

South African and Australian approval for even a \$10 cut.

The Japanese are facing a difficult and contradictory situation. Ferro-alloy makers are unable to compete with low-price imports from South Africa and elsewhere, so they must try to cut production costs through lower ore prices.

But this encourages ore producers to start their own ferro-manganese production, which further depresses international prices and makes it more difficult for Japan to cope.

Another complication in forthcoming contract talks is that the Japanese have considerable stockpiles of manganese.

At the end of last year the 10 ferro-manganese producers held stocks of 569 000 tons, considered sufficient for them to continue production for six months without any further imports.

Their 1982 contract imports of 1,3 million tons includes 200 000 tons, being carried over into fiscal 1983 beginning April 1.

A seven to 10 percent reduction in steel production means less demand for ferro-manganese.

In calendar 1982 South Africa was a close second to Australia as a supplier of high-grade ore, with 374 498 tons. It supplied most of the low-grade ore (337 000 out of 399 000 tons)

Financial Correspondent

**TOKYO** — Japanese importers are predicting a drastic fall in thermal coal prices in the next fiscal year beginning in April, with South Africa leading the way.

Compared with this time last year, prices are about \$20 lower for most grades. Those not willing to accept this are losing their market share.

The Australians in particular are trying to hold on to higher price-levels, despite a world thermal coal glut.

Much of the slack has been taken up by South African mines, which almost doubled sales to Japan last year, compared with 1981 — Reuter



(217) (1/18) RWH  
28/2/83

# SA minerals on way for UK stockpile

By ADAM PAYNE

**MOST** of the South African tenders for strategic minerals and ferroalloys for the British stockpile have been closed and shipping is going ahead because the minerals have to be in the United Kingdom by March 31.

Manganese ore and chromite orders have been allocated, with Samamcor supplying 35 000 tons of manganese.

I am told that a separate consignment of 15 000 tons of manganese ore, not for the stockpile, will be supplied by Samamcor to the British Steel Corporation.

An order for 35 000 tons of chromite has been placed for the stockpile by the agents serving the British Government, Brandeis Instel, a commodity trading firm which is owned by the French conglomerate, Pechinery-Ugine-Kuhlman.

The name of the supplier is not disclosed and Brandeis

Instel in London and Johannesburg has issued no details of purchases for fear of being prosecuted under the British Official Secrets Act.

An order for 20 000 tons of ferrochrome has been placed and tenders for 40 000 tons of ferromanganese have been called for. This ferromanganese would be worth about R13-million.

It is not known whether a tender for silica manganese has been accepted.

The agents are also looking for vanadium supplies.

The tenders were to be closed by February 11, but the date for some of them was extended because of orders from consumers in Western Europe and elsewhere set off by news of the British stockpile programme.

The British have been secretive on the extent and cost of the programme, partly because any stated target would indicate Britain's strategic needs.

A House of Lords select committee on strategic stockpiling, in a report issued last October, said the four most important materials

were chromium, manganese, phosphate rock and the platinum group metals.

The next most strategically important, mainly because they were easy to substitute, were antimony, cobalt, molybdenum, nickel, niobium, tantalum, titanium and vanadium.

**Kaolin  
miners  
try for  
support**

*CAPE TOWN 1/3/83*  
*217*

**Staff Reporter**

THE kaolin mining company operating in the Noordhoek valley, Serina Pty Ltd, has launched a campaign to enlist support from the neighbouring communities

On Friday, officials from the Fish Hoek and Simon's Town town councils, the divisional council and a representative of the local weekly newspaper, the Fish Hoek Echo, were invited to Serina works to celebrate the launch of a new centre for endangered plant species

On the same day as the launch, the Fish Hoek Echo featured a story headed "Restoring the balance" on the mine and its future "environmental" intentions.

It quoted the managing director of Continental China, of which Serina is a subsidiary, as saying that mistakes had been made in the past and it was for these reasons that the company was now seeking advice.

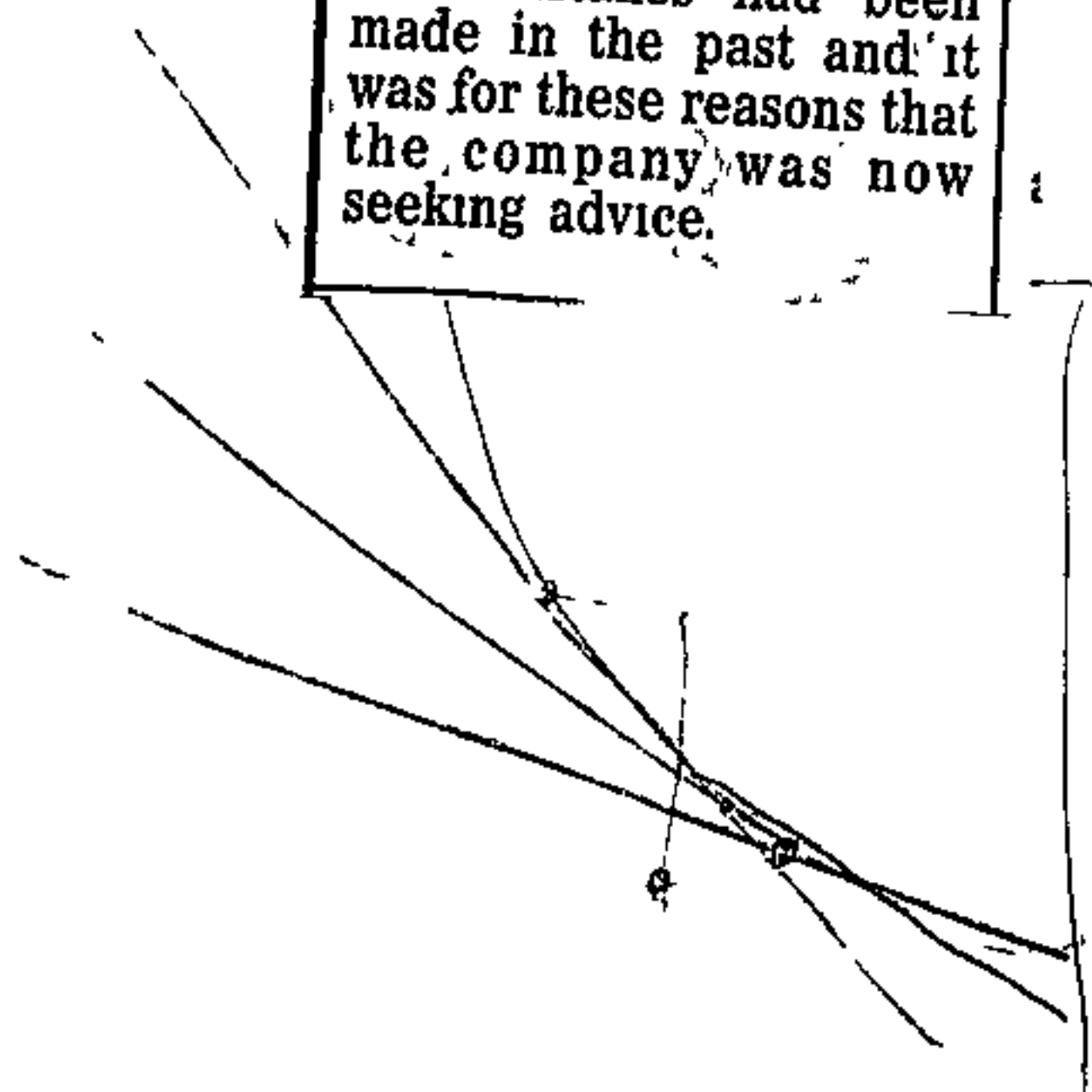

(217) Industrial Waste 2/3/83

# Uranium enrichment under fire

URANIUM enrichment in SA is a questionable and costly activity for at present there is a surplus of enriched uranium in the world.

The spot price of uranium was at its peak at 40 dollars a pound and recently it was 17 dollars a pound

Wally Grant, MD of the Uranium Corporation of SA dealt with this issue at the recent SA Energy Conference held at the CSIR in Pretoria

He said "SA is a major producer of uranium and

it is only natural that a nation will want to increase the value of the product by refining it and thus produce enriched fuel for the world market"

He added that with the passage of time research and development although all the more specialised, would make

SA not only self-sufficient but more competitive with overseas suppliers of enrichment technology

Grant is also keen to make SA self-sufficient in its enriched uranium requirements

He pointed out that uranium enrichment is a very sensitive issue

It could quite easily happen that by not satisfying these requirements due to some political demand or in the event of future wars or disturbances, enriched uranium may not be imported into SA and the nuclear power stations would come to a standstill

Grant acknowledged that there has been much comment and speculation on the costs of enrichment

He believes that the most important barometer is the US's Department of Energy's selling price

Since the 1970's other suppliers such as Russia, West Germany, the Netherlands, Britain, and France have produced enriched uranium and the enrichment is still rising



Wynand de Villiers

Wynand de Villiers, executive chairman of the Atomic Energy Corporation of SA said "It does seem that the uranium trade has reached a measure of maturity with consumers not insisting on unreasonably low prices and producers not insisting on unreasonably high prices"

Recently when the spot price was nearly 17 dollars a pound, long term contracts were honoured at well above this figure

He hopes that when the present "mining of stock-piles" is over the world will come to its senses as far as the unwarranted fear of anything nuclear is concerned

He believes that if governments stopped interfering in the market and avoided trying to control it for political reasons then perhaps a stable and healthy growing uranium market could be established

He concluded "Although predicting the future is notoriously hazardous, it does seem that the second half of this decade will see a return to normality with steadily rising uranium prices

"Just about all the important industrialised countries in the world are busy with enrichment activities in one form or another"

# 25% cut in mine

29/3/83

## labour

## force

217  
Mining Editor

o  
e  
i  
e  
n  
d,  
10  
Ar  
at  
to  
g  
in  
n-  
of  
ad  
i"  
is-  
ed  
f  
se  
be  
he  
di-  
tre  
ect  
the  
eq-  
ion)  
old-  
31  
t  
a  
ble  
lity  
lop-  
227-  
lion  
ar-  
of  
nty  
well  
am-  
As,  
ted  
to-  
and  
ase  
he  
are  
to  
ire

**MIDDELPLAATS**  
Manganese mine near Kuruman in the Northern Cape has reduced its work force by 25% after the halting of underground production in February

According to holding company SA Manganese Amcor (Samancor) the staff cut of about 110 workers was necessary to ensure the mine's operation. Further reductions are being made by not replacing workers who leave.

Dr John Muller, Samancor's general manager for marketing, said the company had gone through four years in which each year was worse than the previous in demand for manganese.

Manganese is used mainly in the steel industry and the slack demand reflects the world-wide depression affecting steel producers.

Dr Muller said underground production at Middelplaats was stopped so stockpiles of ore could be reduced.

The mine would resume operations underground in April at a rate of about 50% of production capacity.

"The situation varies from mine to mine, but if we did not have to reduce stockpiles of ore then operations averaging 50% of production capacity would be sufficient to meet present demand for manganese ore."

Samancor's Mamatwan and Wessel mines were also producing at reduced rates, but high-grade ore producers Hotazel and Lohatla mines were producing normally.

"The year ahead is expected to be as bad as any we have seen recently. However, we hope to see conditions improve slowly."

I  
I  
I  
E  
D'  
ov  
th  
m  
in  
he  
cc  
sa  
so  
th  
cr  
CC  
dr  
pi  
or  
th  
n  
ta  
n  
fr  
5,  
s  
d  
A  
E  
u  
s  
c  
r  
i  
t  
c  
r  
a  
b  
e  
n  
ti  
sa  
c  
n  
I  
g  
d  
v



7/11 217 RMM  
3/3/83

# Productivity up, costs down for asbestos duo

Mining Editor

GENCOR's two asbestos producers, Gefco and Msauli, expect improved results in 1983 from increased productivity and lower working costs.

Asbestos prices for the year ahead are not expected to rise to any extent because of intense market competition between producers and because of oversupply

Mr L. K. Jooste, chairman of amosite and blue asbestos producer Gefco, says in his annual review "Although consumer stocks have been drawn down to low levels the economic climate remains depressed and no significant improvement in demand is foreseen in 1983

"The temporary loss of Mexico as a stable market is

expected, to a large extent, to offset improvement in demand in third world countries

"No significant reduction in demand due to the health campaign has yet become evident and the main asbestos cement pipe market remains firm with no viable substitutes in sight"

Mr Jooste says Canadian and Zimbabwean producers recently announced price increases for 1983, but because of oversupply of asbestos it is doubtful these increases will hold.

"It is unlikely producers will achieve any worthwhile increases in 1983

"Taking into account the cost benefits of further intergroup rationalisation, improved productivity, a favourable exchange rate and lower capital expenditure envisaged for 1983, a better

year than 1982 can be expected

"Long-term prospects for a revival of the asbestos markets in line with an expected upswing in the world economy remain good"

In his capacity as chairman of chrysotile asbestos producer Msauli, Mr Jooste expects production will increase in 1983.

This will follow benefits from the modified mining method in the form of improved availability of uncontaminated ore and the elimination of the need to mill tailings

"Early indications are that the total output may be absorbed by the market. Although price increases will be difficult to achieve in view of the oversupply situation, profitability should however improve due to lower unit production costs at the anticipated higher production rate"

## COMPANIES TELL MORE

217 FM 8/4/83

In contrast to an increasingly secretive public sector, parts of the private sector are generally becoming more and more forthcoming. A few years back, for example, it was unusual for companies to disclose turnover figures — a percentage improvement sufficed. Now most industrial companies provide not only annual turnover figures, but also divisional contributions and, in some cases, interim balance sheets. A few even provide quarterly reports, and a growing number publish their candid forecasts for the year ahead.

On the other hand, the mining industry, which once led the way in disclosure standards, seems to be drawing the blinds, with a growing number of mines ceasing to provide operating information. The usual excuse is that publication of such information is detrimental to the company's marketing efforts and thus not in the interests of shareholders.

In 1976-1977, SA Manganese drew criticism for halting the publication of production figures. It was followed more recently, in December 1981, by Gencor's asbestos mines, Msauli and Gefco, and, last July, by antimony producer Cons Murch, which has ceased providing interim sales information. In all cases the rationale for less disclosure was that it blunts the edge enjoyed by competitors and clients.

Gefco and Msauli chairman Luther Jooste explains "We were the only asbestos mines in the world publishing costs and margin figures. We more or less know the production and sales figures of the leading producers, Russia, Canada and Zimbabwe, but not their

margins. The market is very competitive so we stopped publishing operating figures."

Msauli, which produces chrysotile asbestos, is a fairly small producer in total market terms — about 3%. But it exports about 90% of its output in competition with the world majors. So, the logic of not providing customers and competitors with margins seems compelling.

Gefco, on the other hand, controls the amphibole asbestos market. So it might seem pointless to clam up. Jooste argues that Gefco's product does suffer competition from chrysotile asbestos in some instances — such as in asbestos-cement pipe making. So the reasons for closing the books are similar to those in Msauli's case.

### Competitive battle

What of Cons Murch? Again, the market is very competitive and the mine has to battle against other producing countries. So the quarterly reports were truncated, leaving only the financial details. As in the case of the asbestos mines, the reasons appear cogent.

But are they? For a start, are competitors or customers really that ignorant? Probably not. In most industrial and mining markets major producers and leading customers know reasonably accurately what margins are available. So, perhaps it is naive to think that clamming up really helps the marketing effort. In fact, the proponents of the view that people will pay a premium for certainty might argue that providing the information does exactly the opposite — in other words, it helps since customers

believe the producer is not trying to earn super profits. This is an argument the platinum majors might consider.

There is another disadvantage in limiting disclosure. Often, too little information is seen as a management effort to cover up mistakes. Industrial companies which provide plenty of information are seldom penalised for botching their forecasts, if all the assumptions are known.

This all suggests that shrouding the operating details in secrecy will result in the price of the share trading at a discount to its real worth. Investors cannot make rational decisions if they are deprived of all the facts. Furthermore, it can leave a sour taste when majority shareholders in full possession of the facts change their holdings in subsidiaries. Anglo American, for example, recently added to its De Beers interests near the bottom of the market when it had far more information about the diamond company than minority shareholders.

So, perhaps these mining companies may not be acting in the best interests of their minority shareholders and are probably increasing their cost of capital.

Most industrial companies do not in fact provide unit volume or margin figures. The thought of, say, Pick 'n Pay publishing cost-of-sales data seems outlandish. But these details are not altogether vital in assessing the industrial share since efficiency can be gauged in other ways. This, though, simply underlines the fact that if it is to serve outside shareholders better, the mining industry needs more, not less, disclosure.



# SA chrome ore contracts battle due in Japan

By Geoffrey Murray

TOKYO — South African chrome ore producers will be battling hard over the next few weeks to hold the line on price and tonnage in crucial contract talks with Japanese buyers

Rand Mines is set to start the ball rolling about April 20, information here indicates. In the 1982 financial year, just ended, Rand Mines had a contract to supply 40 000 tons of low-grade chrome ore at \$46 a ton fob

Industry analysts say the price it offers for fiscal 1983 deliveries will significantly affect talks next month with other South African companies, like General Mining, Union Corporation and Waterkloof Mines. Japanese ferroalloy producers are in a tight spot

For one thing, they are unable to offer a competitive product, and their business has been badly eroded by cheaper imports pouring in from South Africa and other sources

The situation seems to have worsened. Industry analysts say chrome import prices are now about 20 percent lower than a year ago, when the local industry last sat down to negotiate ore deals with South Africa. As a result, the industry is up to its eyeballs in red ink and is seeking relief every possible way — meaning lower raw material prices in the present circumstances

There are moves to seek price cuts from the South African mines because prices of high grade ore from such sources as Albania and Russia have been dropping rapidly. But importers are far from a common position on prices.

Voices have been heard recently that the South African mines cannot realistically be expected to slash their prices again, because they accepted a \$2 reduction last year even though being forced to cut back hard on ore production

The position on tonnage is equally unclear. The Japanese have considerable stocks on hand or at the loading ports in South Africa and would certainly like to reduce contracted amounts this year if possible

EVERY CANDIDATE MUST enter in column (1) the number of each question answered (in the order in which it has been answered); leave columns (2) and (3) blank.

	Internal	External
(1)	(2)	(3)
1(A)	11	
2(A)	18	
3(B)	17	
Examiners' Initials		

(to be copied from the heading on the Examination Paper)

## NOTE CAREFULLY

1. The answers only on the right hand pages will be marked. The left hand pages may be used for rough work, but no credit will be given for such work.
2. Enter at the top of each page and in column (1) of the block on this cover the number of the question you are answering.
3. Blue or black ink must be used for written answers. The use of a ball point pen is acceptable. Red or green ink may be used only for underlining, emphasis or for diagrams, for which pencil may also be used.
4. Names must be printed on each separate sheet (e.g. graph paper) where sheets additional to examination book(s) are used.

## WARNING

1. No books, notes, pieces of paper or other material may be brought into the examination room unless candidates are so instructed.
2. Candidates are not to communicate with other candidates or with any person except the invigilator.
3. No part of an answer book is to be torn out.
4. All answer books must be handed to the commissioner or to an invigilator before leaving the examination.

Any dishonesty will render the candidate liable to disqualification and to possible exclusion from the University

14 April 1983

S

13-1

# SA chrome exports on increase

217 Industrial Week  
14/4/83

A FURTHER improvement in the demand for SA chrome by US and European sources has been registered with recent orders for "significant tonnages" placed with SA Manganese Amcor (Samancor).

Disclosing this to Industrial Week, Samancor's divisional head of chrome, John Vorster, said that improvements in the motor industries and interest rates on both continents were mainly behind the pick-ups.

But there was some speculation about whether the increased demand for chrome was partly attributable to a stocking up process.

"Business in chrome in the US and Europe is pick-

ing up and significant tonnages have been purchased from us. Japan is lagging about six months behind those two markets but that market should improve later this year," said Vorster.

"The silicon metal market, which has been depressed for several years, was starting to look up, but more improvement was needed," Vorster added.

Ray Davies, general manager of the manganese alloy division at Samancor, said that the US steel production was continuing to improve slowly, although the steel industries of Europe

and Japan indicated "little sign" of a recovery.

"It is speculated that some improvement will occur in the US in both selling price levels and tonnage sold of manganese alloys during the latter half of 1983, with the Japanese and European manganese alloy demand increasing slightly at the end of the year."

Davies added that the "triumvirate" of ferromanganese, silicomanganese and ferro-silicon coupled with the varied inventories of these alloys continued to influence the market price and buying pattern.

By Lynn Carlisle



By **BRENDAN RYAN**  
Mining Editor

**SOUTH** Africa dominates international platinum supplies to the extent of about 70% of the present level of demand, according to Mr Syd Newman, chief executive of Lonrho SA.

Addressing the Southern African Metals and Minerals conference in Johannesburg yesterday he said this resulted from the depressed nickel market and the surplus palladium situation

A vital factor in assessing the platinum supply situation was the percentage of other metals occurring with platinum in the orebody and which were produced as by-products, he pointed out

The minor producers to whom platinum is a by-product of nickel and, to a lesser extent, palladium can upset the price but obviously would only do so if nickel and palladium provided sufficient revenue, he said

"While nickel and palladium are relatively in the doldrums it would seem totally illogical to throw platinum on to a falling market price," he said

"In practical terms for an output of 100 000 ounces of platinum, South African will produce 1 400 tons of nickel and 43 000 ounces of palladium, Russia will produce 15 000 tons of nickel and 200 000 ounces of palladium, and Canada will produce 140 000 tons of nickel and 100 000 ounces of palladium," he commented

Uses of palladium world-

# Dominant SA supplies 70% of world's platinum

217  
ROOM  
22/4/83

wide are far below those of platinum Canada once supplied 80% of world nickel but now only 40% and their supply of platinum has been halved to less than 200 000 ounces

In recent years nickel production has been considerably curtailed with extensive shutdowns at Sudbury Even recommencement of operations will not put large amounts of platinum on the market, Mr Newman said

"Russia has in recent months been cagey about palladium supply and the price has firmed considerably

"With their palladium supply being twice that of platinum, logic would suggest that platinum must not be in oversupply, or, at best in short supply since it is a valuable earner of foreign exchange," Mr Newman said

"South African production is approximately 1 750 000 ounces a year Add to this Russian and Canadian supplies of about 500 000 ounces, recycling about 200 000 ounces and a total supply of about 2 440 000 ounces

emerges

"This is the production level but short term supply can obviously be altered by alterations to stock levels," he said

"The position therefore in my view is that because of the depressed nickel market and the surplus palladium situation, South Africa dominates the platinum situation and her output will be a reflection of demand and will be keyed to the price, were circumstances normal"

As platinum is a primary product from the South African mines, unlike the position in Canada and Russia, the supply of by-products such as palladium, rhodium and nickel would not be affected by price increases, even if these were the result of anticipated shortage

"A few years ago rhodium supplies were considered to be inadequate and the price was raised sharply in the USA South African producers were thankful for the extra profits but no extra supplies were forthcoming

"Palladium passed through the same phase and

even the current rise in palladium prices will not increase South African supply except to a minor extent from stocks," Mr Newman said

"Increase in supply of by-products will not in fact be forthcoming, without a corresponding increase in demand for the primary product, platinum

"In this regard an increase in production of 100 000 ounces per annum would not on a permanent scale be put on the market in under 2 to 2.5 years," Mr Newman said

Mr Newman said it is impossible to calculate from published reports what quantity of stocks are overhanging the market and he doubted the accuracy of reports from London saying a huge stockpile of platinum was hanging over the market

Each of the two major producers, Impala and Rustenburg values their stocks of platinum and by-products in radically different ways

"One producer has stocks of R118-million, the other R94-million but no quantities are revealed Western Platinum which is one tenth the size of Impala or Rustenburg has stocks valued at R45 million to give another comparison to these figures," Mr Newman pointed out

"Control of the price by South Africa would seem to be an exercise in skilful marketing It seems unlikely that the producers would engage each other in cut-throat competition as the chrome producers and, to a lesser extent, some coal producers are doing

"I believe that by controlling supply to what is a reasonably firm demand, 50% inelastic, price can be maintained

● See Page 13

# SA uranium future lies with America

217 RDM 23/4/83

By **BRENDAN RYAN**

Mining Editor

SOUTH African uranium producers will have to generate more business with United States utilities as most unfulfilled uranium requirements for the 1980s are in the United States.

Mr James Vaughan, vice-president of Nuexco, told the Southern African Metals and Minerals conference in Johannesburg yesterday that uranium prices for this business would have to be more related to the spot market than the long-term contracts favoured by South African producers.

"The South African producer will be looking at a somewhat unfamiliar future because South African uranium has generally gone to non-US buyers," Mr Vaughan said.

Reasons for this included litigation in the United States which South African producers had been anxious to avoid. American utilities had generally seen the United States as being self-sufficient in uranium and imports, if

needed, had come from Canada or Australia.

"There was, and unfortunately still is, an institutional bias within most US utilities against contracting for South African supply.

"I emphasise that the bias is institutional because individual utility fuel managers generally recognise South Africa's exemplary delivery record and high quality product."

Reasons for this were the business philosophy of risk avoidance followed by the utilities and among the risks they tended to avoid was political controversy.

"Contracting directly with a South African company might be viewed by US executives as setting themselves up for criticism by regulators, shareholders and the media, not because of any questions of reliability but simply for political reasons evolving around South Africa's racial policies as viewed by the US observer."

"It is quite possible that US users and South African producers will somehow be drawn together during this decade, either directly or, as before, indirectly, because of the dominance of US unfulfilled requirements through 1990."

Mr Vaughan said a factor increasing the importance of the spot market was the business philosophy of the US utilities and the existence in the US of the so-called fuel adjustment clause.

"If the utility fuel buyer pays more than the market price he is at best embarrassed in front of his management. Even worse, the company may be called to task by the usually politically motivated regulatory authorities.

"Worst of all, we have seen cases where the utility shareholders have had to absorb any price differential above market."

"Thus the utility policy of risk avoidance translates into a desire to buy fuel at

market price. Who can criticise you for paying the going rate, whatever it is?"

"As a result, US utilities now generally refuse to enter into contracts which might require them to pay more than the market price. Thus, we now see many long-term uranium contracts under which all deliveries actually made are priced on the basis of some spot market indicator."

Security of supply had dropped to a lower level of importance for US utilities, the theory being that, at some price, uranium could always be obtained, and under present existing conditions that cost could always be passed on to electricity users as long as it was "at market" or below.

World production of uranium was expected to fall between 1982 and 1983 mainly because of cutbacks in the US. Production would rise slightly until 1986 when it would level off for a few years at about 100-million lb of uranium oxide annually, said Mr Vaughan.



R450m project if demand improves

# New platinum mine planned

(217) ROOM 20/5/83

A R450-million platinum mine, Northern Platinum, could come on stream from the late 1980s if demand for the metal improves in the next few years.

The mine, 52% controlled by Gold Fields of South Africa at the outline stage, would have a capacity to produce nearly 250 000 ounces of platinum a year.

At present South Africa is producing about 1 400 000 ounces a year through Rustenburg and Impala and the much smaller Western Platinum.

GFSA is conducting a wide-ranging exploration programme in an area adjoining Rustenburg Platinum Mines Amandelbult section to evaluate the prospect of a mine

But GFSA says it is too early to talk of the opening of a mine — it is still exploring and considering the project

A joint study on the project by a geologist, Dr E S A Antrobus, and Mr David Gleason, a mining investment executive of stockbrokers Davis Borkum Hare, was presented at a platinum conference in London yesterday

They said the prospecting programme appeared to be reaching finality

Mr P W J van Rensburg, the deputy chairman of GFSA, said in Johannesburg last night "We are not mak-

By ADAM PAYNE and NEIL BEHRMANN

ing any announcement on the opening of a mine

"We are still drilling and there is a great deal of work to be done before we know whether we have a profitable platinum mining project on our hands"

A senior executive from another mining house doubted whether the market was ripe for a new platinum mine

He said "Rustenburg and Impala are now producing about 1 400 000 ounces of platinum a year, supplying a weak physical market

"When the market picks up they could expand production by up to 1-million ounces a year together A new mine, with high capital costs and higher working costs than those at Impala and Rustenburg, would enter a highly competitive market"

The Antrobus-Gleason report says the project would fall under GFSA, which would lead and manage it, and also under Hong Kong Investments SA, which is described as being Panama-based and Swiss-controlled

Since a private prospectus was issued in 1981, parcels of shares in Hong Kong Investments have been issued to several parties

GFSA came into the picture when its subsidiary, Gold Fields Mining & Development, agreed to evaluate the area

Under the agreement GFMD would emerge, after

spending substantial sums on exploration holding, with a 52% effective interest

Dr Antrobus, who was a senior geological executive at Anglo American Corporation, and Mr Gleason quote from a private paper of 1981, showing that the exploration programme is behind the timetable envisaged at that time

The paper looked to the flotation of a company and the beginning of shaft sinking in late 1982, with the work to be completed by late 1984 Development and production would begin in 1985 and full production of 285 000 oz of platinum would be achieved by 1988

Northern Platinum — a likely title for the company — would then be producing about 10% of South Africa's platinum production

Dr Antrobus and Mr Gleason say the intention appears to be to float a company and that the capital cost envisaged in the private paper was R300-million in 1980 money — about R450-million in current money

They believe that the mining operation, if launched, would be at a rate of about 2 400 000 tons a year producing about 410 000 oz of platinum group metals Platinum would total about 246 000 oz, palladium 103 000 oz and gold 24 000 oz

They say "Taking April's free market prices and escalating these to 1988, using a

1988 gold price of R850 an oz and then assuming that a new producer would offer a discount on PGM, we calculate that revenue in the first full year of production, 1988, would be R215-million

"On the cost side, from a base in 1983 of R35 a ton, allowing a prudent amount for refining and applying escalation to 1988, we arrive at total costs of R171-million

"This leaves a net surplus in the first full year of operation of R44-million before any provision for capital spending This assumes no tax because of a substantial assessed tax loss which would have accrued during construction, and that the mine's total production is sold"

The authors conclude

- A mineable property exists in the area adjoining Amandelbult
- The reef is deep and mining costs will be high
- Marketing will be a critical problem
- The UG2 Reef will be mined simultaneously with the Merensky Reef
- The venture appears likely to succeed

At the annual London Platinum Dinner last night, organised by Argos Metals, Ayrton Metals and Samuel Montagu, several dealers were doubtful that the mine could go ahead under present market conditions

These merchants who deal in physical metal in London, New York, West Germany and Switzerland stressed that physical demand for platinum remained flat

# Opportunity in US for SA uranium

217  
RUM  
24/5/83

By **BRENDAN RYAN**  
Mining Editor

**SOUTH African producers could be selling 10-million lb of uranium annually to the United States by 1995 compared with negligible amounts at present, according to Mr Bob Wolcott, chairman of Nuexco.**

He said in an interview in Johannesburg that if South African producers ignored the growing uranium shortage in the United States other sources would be found by US utilities

"If this happened and the South African producers had to sell their surplus production elsewhere it could put tremendous downward pressures on price again"

The market for uranium in the United States was being caused by high-cost US uranium producers dropping out of production

Nuexco, which acts as a consultant on uranium fuel and also as a broker for the commodity, estimates United States production will drop to about 13-million lbs by 1990 but consumption will rise to 38-million lbs

This leaves a deficit of 25-million pounds annually which must be filled by sources outside the United States unless uranium prices rise to the point where high-cost US producers come back

into the market

In 1980 when uranium was \$43 a lb United States companies produced 43-million lbs of uranium — double American requirements

Mr Wolcott said "With the fall in prices United States uranium production dropped to 27-million lbs in 1982 and is projected to be 15-million lbs in 1983"

Mr Wolcott does not believe uranium prices will return to levels which will bring US producers back

"Canadian, Australian and South African producers can take a much lower uranium price than American producers and still remain profitable

"They want as high a price as they can get — but not such a high price that the US producers will get back into action"

Mr Wolcott estimates the uranium price will need to reach \$35 a lb before the US producers return

Nuexco gets two-thirds of its revenue from brokerage on arranging uranium supply contracts

"We bring buyers and sellers in the market together. We can negotiate on their behalf if required or stand back let them negotiate their own deals"

Nuexco also consults with companies on uranium supply and price forecasts and produces a monthly report which is subscribed to by every major uranium producer and power utility company in the world

It keeps a close watch on the secondary market in uranium, which Mr Wolcott calls the world's most complex commodity market

"Transactions make the secondary market self-expanding. One move initiates others"

"For example, a user could purchase enriched uranium. He may then hold excess U308, UF6 conversion and enrichment services. He may even have surpluses of different enrichments. Disposal of excess material may involve a barter-like payment, or items may be disposed of individually

"A cascade of several transactions is thus sparked by that original transaction"



day May 26 1983

# Clash over Noordhoek kaolin

**Parliamentary Staff**  
THE Deputy Minister of Environment Affairs and Fisheries, Mr John Wiley, has warned Mr Ken Andrew (PFP Gardens) that legal action may be taken against him because of a speech he made at a Fish Hoek meeting concerning kaolin mining at Noordhoek

Mr Wiley and Mr Andrew clashed on the kaolin issue during the debate on the environment and fisheries budget vote yesterday

Mr Andrew said the Government's decision, announced last year, that three tracts of land at Noordhoek were to be reserved for future possible kaolin exploitation, had not stilled the fear of many people and organisations

"There is widespread

concern about the possibility of mining taking place in the near or distant future," he said

Another "source of dissatisfaction" was Mr Wiley's involvement as MP for the area he had chosen not to inform his constituents of his personal interest in the area for 15 months. This was "shocking and unacceptable"

Mr Wiley had told him to keep out of the controversy, and also had the "audacity" to refer to it as a delicate issue

It was not surprising that Mr Wiley had considered the issue delicate — he had had an option to buy 400 ha in the area at the time

He said he had suspected Mr Wiley's involvement for seven months, but had no written proof, thus had not stated his suspicions publicly



## Mr Ken Andrew

Mr Andrew appealed to Mr Wiley to declare publicly any personal financial interest that he may have in other property within or adjacent to the proposed Table Mountain and Southern Peninsula Mountain Chain nature area

Replying, Mr Wiley said he had publicly stated, since taking office, that he had no part in Cabinet decisions on matters involving kaolin

or the Peninsula Mountain Chain. He had indicated that he would refuse himself from discussions on such matters

Apart from living in a house in the area, his only other interest was that for some 20 years he had been a shareholder in a company that owned land above Simon's Town. This land was utilised by his family for recreation, but had never been developed

Mr Wiley warned Mr Andrew that a member of the Division Council was being summonsed after a tape recording of a speech he made at a Fish Hoek meeting had been analysed and found actionable

Mr Andrew had spoken at the same meeting, and a recording of his speech was also being analysed

13 Mr D W WAITIRSON In support Affairs—Reply standing over

14 Mr K M ANDREW asked the Minister of Mineral and Energy Affairs  
Kaolin 61 1442-143 1/6/83  
Howard

Whether he or his Department has received any requests since 1 January 1982 for permission to mine or quarry kaolin (a) in the Cape Peninsula and (b) elsewhere if so, (i)(aa) on what dates and (b) from what persons or organizations were these requests received, (ii) where was the mining or quarrying to take place in each case and (iii) what was his response to each of these requests?

The MINISTER OF DEFENCE (for the Minister of Mineral and Energy Affairs) (Reply laid upon the Table with leave of House)

(a) and (b) Yes

(i) (aa) and (hb) (ii) and (iii)

26 February 1982 from (i) a) Kaolin (Pty) Ltd at Burnetts Grant, Division Albany Permit issued on 10 February 1983

6 October 1982 from G and W Base and Industrial Mines (Pty) Ltd at Buffelstroom, Division Riversdale Application not yet finalized

6 October 1982 from G and W Base and Industrial Mines (Pty) Ltd at Vaalkraal, Division Mossel Bay Application not yet finalized

G and W Base and Industrial Minerals (Pty) Ltd at Smanskraal, Division Riverdale Application not yet finalized

21 December 1982 from Serena (Pty) Ltd at Serengeti area at Noordhoek in the

WEDNESDAY

1443

Cape Peninsula Since kaolin was mined on this land in the Noordhoek area before the Physical Planning Act, 1947 (Act No 88 of 1967) came into operation, a permit for the mining thereof is not required  
22 February 1983 from Crous (Pty) at Peyskraal, Division Albany Application not yet finalized

# Albania emerges as SA's main chrome competitor

By Neil Behrmann: London

**THE** South African chrome-ore and ferrochrome industry has taken a hammering during the past two years, but the industry remains the dominant supplier to the West.

In a review on the South African chrome industry, Metal Bulletin concludes that South Africa will remain the world's most important source of chrome-ore and ferrochrome supplies, even though most producers have cut back production and have been operating at a loss.

Metal Bulletin and other independent analysts say, however, that Albania is becoming a major competitor of South Africa.

It has increased its exports to Japan, largely at South Africa's expense, by bartering chromite for industrial machinery and steel pipes.

While Japan's imports dropped from 960 000 tons in 1980 to about 700 000 tons last year, the Albanians

have increased their chrome exports steadily, and are expected to sell around 1 700 000 tons to Japan this year.

Independent analysts estimate that Albania's chrome exports following an economic development plan will jump from around 1.1-million tons a year to around 2-million tons in 1990.

During the same period South Africa's exports will shrink by 40% to around 1-million tons. The analysts reason that South Africa is losing market share with its major trading partners.

Regardless of Albanian output and export estimates, however, a cloud overhangs the political situation of Albania, an extreme communist country which shies away from the West.

A Wall Street Journal report comments that this tiny country, bordered by Yugoslavia and Greece, "is cocooned in paranoia".

One of the paper's correspondents, David Brand, allowed in the country

because he has a British and not an American passport, "found a nation where private cars, religion and even singing in public are forbidden".

"Bomb shelters cover the countryside, gun turrets poke up behind distant hills and all young people are trained in weaponry.

"The authoritarian regime's aim is to convince its citizens that most outsiders must be viewed with fear, particularly those from the US — considered decadent — and the Soviet Union — considered a betrayer of Marxism and Leninism.

"A pugnacious refusal to have much trade or other dealings with the outside world has left Albania as Europe's poorest and least-developed country."

Although there have been some relaxations such as a thaw of "a ban on Western journalists and tourists with beards or long hair", Mr Brand's nine-day journey in Albania, a country of 2.7-million people, left the impression of a "bucolic version of Stalin's dictatorship of the 1930s and

1940s, transported through space and time to the Balkans".

A Western diplomat complained that Albania was "the most controlled country I've ever been in", and Mr Brand comments: "Albania is a land of no's — most people aren't allowed to own cars, or their homes, or farmland, or, except in a few mountainous areas, livestock."

The US Bureau of Mines calculates that the US, which is the largest chrome-ore consumer in the world, imported 44% of its material from South Africa. This amounted to 262 000 short tons of South African ore.

"This is down from 432 000 tons in 1980, but this is a result of a general decline in the US appetite for chrome rather than a decline in South Africa's share of the market," comments Metal Bulletin.

With the current political situation and attitude towards the United States, it is unlikely that Albania will gain a slice of this market.



porary rise and the market remains in a downward trend the steepness of the rates rise is such that some significant sectors of the market are not discounting that the interest rate increase may not be merely a hiccup in the downtrend. The latest developments could in fact represent a new higher "base" level.

### Wholesale rates

Month-end rates (wholesale) rose yesterday to 15,5 percent providing prime bank customers who were paying 15 percent or below a golden opportunity for roundtripping. And with the cost of a three months acceptance credit at 16 percent, a prime rate of 15 percent was out of line.

At least two banks were short, actively seeking month-end money in the market this week and building soci-

been cut to reveal the cost of Reserve Bank accommodation has also been decreased, there is little sign of Chruch Square easing the crunch.

The tightening liquidity also appears to be affecting the building society movement with two societies reportedly having stopped lending while several others are being highly selective in handling new loan applications. Bond queues are lengthening once again and there is renewed talk of matching deposits being required at some societies.

One major bank this week offered two-year fixed deposits at about 13,7 percent, which underscores a view that prime would remain at a minimum of 14 percent and could rise to 16 percent in that period.

In spite of the rate I understand there were few takers.

### Kruger rands

Cape Gold Coin Exchange			
	Buyers	Sellers	
1 oz	530 (525)	545 (530)	
1/2 oz	248 (248)	278 (278)	
1/4 oz	127 (127)	148 (148)	
1/10 oz	52 (52)	61 (61)	
Proofs	100%	110%	
Options	2%	2 1/2%	

Groenewald Gold Coins			
	Buyers	Sellers	
1 oz	530 (525)	545 (530)	
1/2 oz	248 (248)	278 (278)	
1/4 oz	127 (127)	148 (148)	
1/10 oz	52 (52)	61 (61)	

SA Gold Coin Exchange			
	Buyers	Sellers	
1 oz	537 (530)	538 (532)	
1/2 oz	262 (262)	282 (282)	
1/4 oz	134 (134)	145 (145)	
1/10 oz	60 (60)	61 (61)	

The board found that on the basis of franchises over 80

# Gefco to retrench 1 050 miners

CAPE TOWN 25/6/83 (217)

**Own Correspondent**  
JOHANNESBURG — Asbestos producer Griqualand Exploration (Gefco) is cutting back on production and laying off 1 050 workers.

A statement released yesterday said, "with no signs of an early upswing in demand for asbestos in sight, the group's current high level of production is resulting in an excessive stock build-up."

"In order to curb this tendency it has been decided to effect a slight production curtailment at the group's mines."

"Foreseen sales tonnages for this year and over the longer term, however, remain unchanged and barring unforeseen circumstances dividend prospects should not be unduly affected."

### Stocks

The chairman, Mr Luther Jooste, declined yesterday to give the tonnages of stocks which have been built up or Gefco's new production rates.

"We are unable to publish any production or sales statistics because of the highly competitive position we find ourselves in with other asbestos producers in Canada, Zimbabwe and Russia," he said.

The staff which have

been declared redundant include 50 white workers and 1 000 black workers.

Gefco intends trying where possible to find alternative employment for the redundant workers but cannot guarantee that it will find jobs for them.

"We will be looking to see if we can place the miners in jobs on other mines in the area around Kuruman such as the Samancor manganese mines."

### Alternative

"We will then try to find positions in the greater Gencor group for those workers who cannot get jobs on alternative mines near Kuruman," Mr Jooste said.

He admitted it could prove difficult to place redundant miners within the Gencor group as other Gencor mines have been laying off staff as well.

It was announced on Wednesday that Gencor's Hlobane colliery in Northern Natal was being forced to reduce its labour force by nearly 1 200 people and there was a possibility the mine might have to be closed within three months.

Hlobane's total workforce is some 5 500 people.

# WNERS

## MINISTRATION

# & CO

### OR 100 YEARS

1570 (14 lines)  
S. HOUT BAY, PAROW,  
S. TOWN.

# OUR INTEREST RATES CERTAINLY TAKE SOME

### FIXED DEPOSITS

As a leading bank, we specialise in certain services. Which is for your money and why you should use us as

### 6 MONTHS FIXED DEPOSITS

### 12 MONTHS

MR K URRY: CAPE TOWN (021) 43-0880 MRS D  
MR CHATFIELD: PRETORIA (012) 21-2382 MR  
MISS M LUXENBERG: JOHANNESBURG (011)  
MISS F RYDER: PORT ELIZABETH (041) 52-1675



# Gefco lays off 1 050 workers

By BRENDAN RYAN

ASBESTOS producer Griqualand Exploration is cutting back on production and laying off 1 050 workers

It said yesterday "With no signs of an early upswing in demand for asbestos in sight, the group's current high level of production is resulting in an excessive stock build-up. In order to curb this tendency it has been decided to effect a slight production curtailment at the group's mines

"Foreseen sales tonnages for this year and over the longer term however remain unchanged and barring un-

foreseen circumstances dividend prospects should not be unduly affected"

Gefco chairman Mr Luther Jooste declined yesterday to give the tonnages of stocks built up, or Gefco's new production rates

He said "We are unable to publish any production or sales statistics because of the highly competitive position we find ourselves in with other asbestos producers in Canada, Zimbabwe and Russia"

The staff been declared redundant include 50 white workers and 1 000 blacks

Gefco intends trying where possible to find employment for the redundant workers, but it cannot guarantee that it will find jobs for them

Mr Jooste said "We will be looking to see if we can place the miners in jobs on other mines in the area around Kuruman such as the Samancor manganese mines

"We will then try to find positions in the greater Gencor group for those workers who cannot get jobs on mines near Kuruman"

He admitted it could prove difficult to place redundant miners within the Gencor group as other Gencor mines had been laying off staff

It was announced on Wednesday that Gencor's Hlobane colliery in Northern Natal was being forced to reduce its labour force by nearly 1 200 people and there was a possibility the mine might have to be closed within three months

Hlobane's work force is 5 500 people

The manganese market is in a severely depressed situation, Samancor reducing production at several of its mines. They are unlikely to take on staff

## Record deficit

WASHINGTON — The US registered a record \$26 290-million Budget deficit in May, says the Treasury

Last month's shortfall compared with an \$18 930-million deficit in May 1982 and eclipsed the previous high of \$26 170-million in October last year.

In April, the deficit was \$3 310-million

For the first eight months of this fiscal year, which began last October, the deficit amounted to \$161 810-million compared with \$81 140-million in the same 1982 period

The Treasury also reported an off-Budget deficit for May of \$1 190-million, bringing the total deficit to \$30 480-million

In May 1982, the off-Budget deficit was \$2 490-million and the total deficit was \$21 420-million — Reuter

NEWS 15

# Asbestos - Msauli could be winner

By Insider

*Industrial Week 28/6/83*

FEW sectors have been pitch forked into such turbulence as the SA asbestos producers in recent years as production climbed to a peak above 380 000t in 1977 only to plunge to under 212 000t in 1982 and so thump down to the lowest level in more than a decade.

At first it seemed that Johannesburg brokers Simpson, Frankel, Kruser Inc has egg all over its face in the immediate months that followed the issue of a survey in August 1981 entitled "Asbestos - An assured future".

However, it now becomes interesting to track the accuracy of the forecast for the asbestos producer twins Griqualand Exploration and Finance Company (Gefco) and Msauli.

The researchers remarked nearly two years ago "We believe that Gefco has greater investment merit than Msauli at current prices" and that "we consider Msauli to offer somewhat less recovery potential than Gefco".

Was anybody listening? When the brokers took stock a couple of weeks

ago it was found that between times, Gefco had shown a price improvement of 164% (140 cents to 370c) while Msauli had stayed almost static.

So perhaps it is worth listening this time around when the team now reverses its valuations and puts Msauli as a better buy than Gefco. Why the turn about?

First, let's consider the brutal fact that SA asbestos exports to its main three export markets - Japan, the US and Britain - suffered a catastrophic decline between 1975 and 1981.

Bear in mind, too, that analysis and forecasting have been made all the more difficult since both producers decided early last year, for understandable strategic reasons because of the severity of global competition, to halt publication of quarterly re-

ports with precise details of production, grades costs and sales prices.

Even so, Simpson Frankel, Kruser, Inc insist they have spotted growing signs that the SA asbestos industry could well have reached its nadir in 1982 and that the second half of 1983 could see the first improvements in the outlook since 1977.

"Promising indications of economic recovery in the Western world have emerged which will result in a substantial improvement in asbestos consumption," says the research team.

They first eye prospects in the US, where the building industry, a major consumer of asbestos cement sheets, may have turned the corner to recovery, and where a rise

in government spending should increase the demand for asbestos cement pipes on public projects.

Gencor, parent of both Gefco and Msauli, expects US demand in 1983 to climb between 10% and 15% to be coupled with possible heavier demand from Western Europe and Japan as the economic motors restart.

It is also looking at the chances of better demand from the Third World and the Communist bloc and the specially high growth potential of South America, the Middle East and South East Asia.

'We believe that the South African asbestos industry stands at the threshold of a new era of growth as anticipated world economic recovery

and the housing demands of rapidly growing populations in Third World countries will lead to a reversal of the declining trend of sales and production experienced over the past five years", say the brokers with conviction.

Their forecast for Gefco earnings will move from 48,8c a share last year to 50,1c in 1983 and on to 66,3c next year, with dividends up from 17,5c to 25c and then 35c.

The snag may be that at current prices much of the anticipated improvement at Gefco has already been discounted on the JSE, putting limits on the scope for further substantial capital appreciation.

A better bet may be Msauli, where they see earnings pushing up from 16c in 1982 to 44,2c this year and 59,7c next year, with dividends, wiped out last year, being resumed at 10c in 1983 and rising to 30c in 1984.

The researchers thus put Msauli's prospective 1983 earnings and dividend yields at 26% and 59% respectively, compared with 13,5% and 6,8% for Gefco.

# Asbestos <sup>217</sup> slumps on <sup>ROM</sup> health fears <sup>2/8/83</sup>

By BRENDAN RYAN

ASBESTOS consumption in Britain dropped by 52% between 1975 and 1982, according to Johannesburg Stock Exchange stockbrokers EW Balderson Inc

The firm says in a report entitled Asbestos — an industry under siege — that this drop was largely a result of the health and environmental controversy over asbestos and the world recession

Over the same period asbestos consumption dropped by 37% in the United States and by 4% in Japan

The anti-asbestos movement has had a profound effect on Western asbestos use and the more developed and democratic a nation, the more vociferous is the environmentalist lobby, the report says

Asbestos use in third world countries has been increasing, but not enough to prevent the overall world decline

A further effect of the anti-asbestos campaign is increasing emphasis on a search for substitutes, which until now have been generally inadequate or too expensive

"Consumers appear to be prepared to sacrifice performance, quality and to a certain extent price to eliminate or minimise perceived health risks

"The long-term future of the asbestos industry is a race between the industry proving it has instituted suitable controls which make asbestos fibre and finished products 'safe' and the technological development of suitable fibre substitutes which are commercially viable or at least not commercially prohibitive"

The report says Canada's output of asbestos declined from 1 700 000 tons in 1975 to an estimated 880 000 tons in 1982

Reasons for this are weak world demand, mining problems associated with depth in

opencast mines, fires and strikes, the environmental issue and the ever-present threat of nationalisation of the mines by the Quebec state Government

Worldwide the asbestos industry is estimated to be operating at 65% to 70% of capacity, Canadian producers working at below 50% of capacity

The report forecasts earnings for SA's Gefco of 46.4c a share in 1983 and 44.2c in 1984 Total dividends are forecast at 25c in each year

Msauli's earnings are forecast at 50.7c a share in 1983 and 46c in 1984 Dividends are estimated to total 15c in each year

Neither Gefco nor Msauli publishes detailed mining statistics, such as grade and production, because of competition between producers

However, the report estimates Gefco has a crocidolite stockpile of about 50 000 tons and an amosite stockpile of 25 000 tons The stockpiles equal about six months' production from the group

The report estimates Msauli has a stockpile of 15 000 tons of chrysotile asbestos — equal to about two months' production



# UK to take tough stand on asbestos

Own Correspondent

LONDON — Tough new rules governing the use of asbestos are to be introduced in Britain following a decision by the Health and Safety Commission concerning asbestos-related lung disease and cancer.

The new rules will include a legal ban on the importation and use in manufacture of blue and brown asbestos, leaving white asbestos the only permitted substance. The ban will come into effect on June 1 next year.

South Africa is the world's major producer of blue asbestos — or crocidolite, as it is known.

The new rules will also provide for the mandatory licensing of companies engaged in asbestos insulation and coating work.

Trade unions in Britain have also been taking a close interest in the use of asbestos and the dangers it may pose to the health of union members who are brought into contact with asbestos.

Television films have been shown on asbestos hazards, including one which severely criticized conditions at an asbestos factory in the Cape Province.

The Health and Safety Commission decided at a day-long meeting in London to implement Common Market directives on asbestos, requiring labelling of all asbestos products, demarcation of asbestos areas in factories, assessment of asbestos risks in work places and other safeguards.

Dust-reduction regulations will apply to all types of asbestos, because although blue and brown asbestos are to be banned, they have been widely used for insulation in buildings.

This will mean stricter controls on building work involving removal of or interference with asbestos insulation.

The permitted dust level for white asbestos is to be reduced, requiring more stringent safeguards in asbestos factories.

CAPE TIMES 25/8/83

217

217 W/L ARGUS 27/8/8

# Asbestos und

## 1 Brokers warning

By Carolyn Dempster

SOUTH Africa's asbestos industry is "under siege" as a result of the powerful anti-asbestos health lobby in the West and the worldwide recession.

This is the claim of the authors of a comprehensive report released by Johannesburg stockbroking firm E W Balderson

The Balderson report, which highlights the profit sensitivity of national asbestos mining, recommends long-term investors to sell — as "the long-term future of the industry has a shadow over it"

The industry is also awaiting a medical study on the incidence of cancers in South Africa's asbestos-mining areas, due to be released this year

South African Government officials say strict dust controls are applied at asbestos mines. However, a visiting American international occupational health expert last week described conditions on the two mines he had visited as "archaic"

Mr Barry Castleman, a chemical engineer and consultant to a number of top environmental and government bodies on occupational health hazards, said South Africa was decades behind First World countries on stringent dust control.

It is now widely accepted that asbestos mining is a health hazard, but the argument between environmentalists and producers still rages over the acceptable level of asbestos fibre/dust in the working area (under and above ground).

South Africa, after Russia and Canada, is the largest asbestos producer and exporter and holds a monopoly of crocidolite (blue asbestos) and amosite

The asbestos "twins" of the national industry who together account for nearly all domestic production — the Griqualand Exploration and Finance Company Ltd (Gefco) and Msauli Asbes Beperk (Msauli) — are now operating near breakeven point, says the Balderson report.

"The anti-asbestos lobby is dealing with a highly emotional, graphically illustrative subject that makes for headlines and sensationalism. In our view there is still time for the industry to present its case, for it to be accepted and to stabilise or reverse the downwards sales trend."

It concludes that the long-term future of the industry rests on "the race between the industry to prove it has instituted suitable controls and the technological development of suitable fibre substitutes commercially viable"

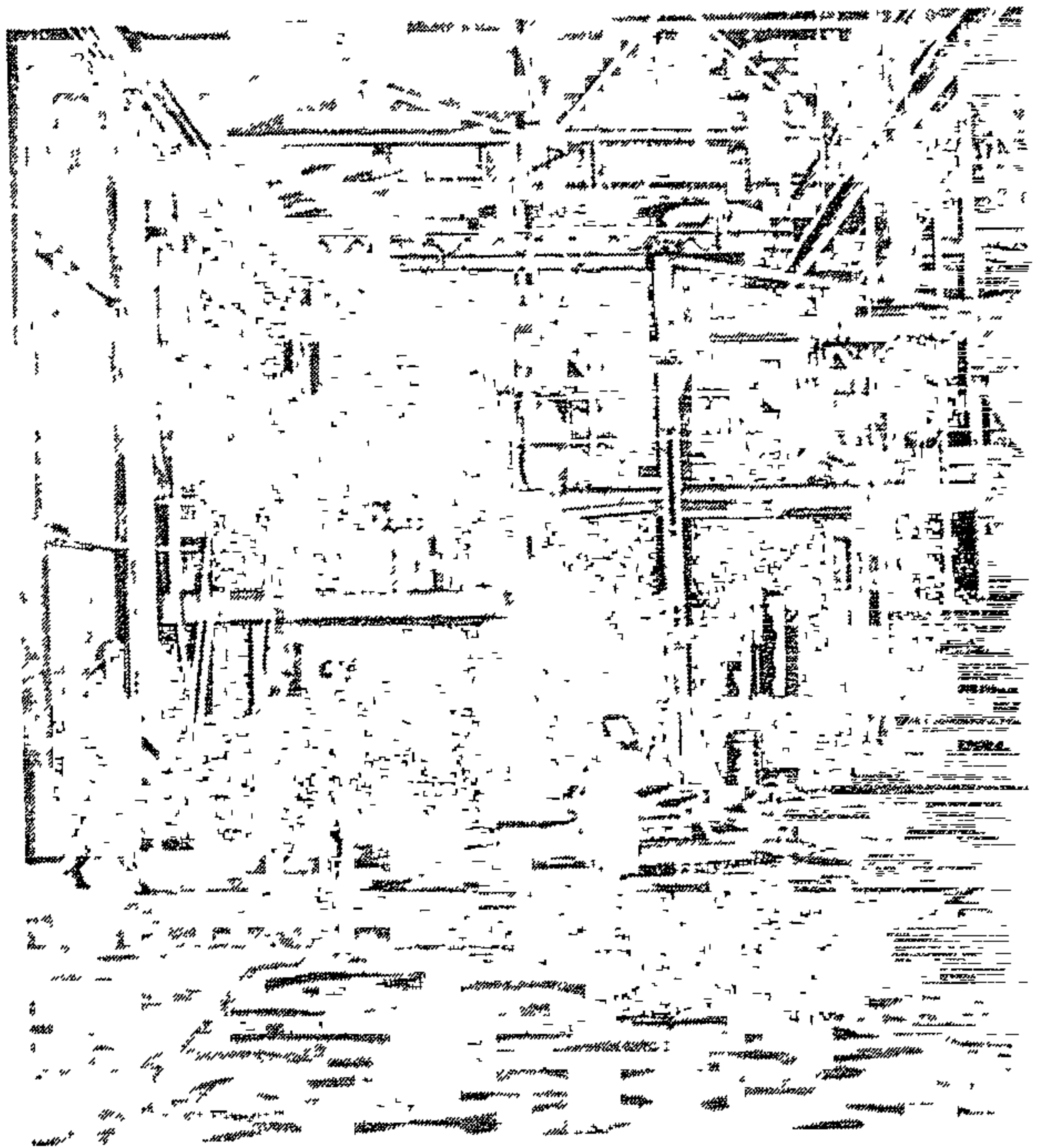

AN asbestos mill in the Kuruman district of the Nor



A worker wears a mask at an asbestos bag-filling station.

A workman near on ast-



ARGUS 27/8/83

217

193

# under siege

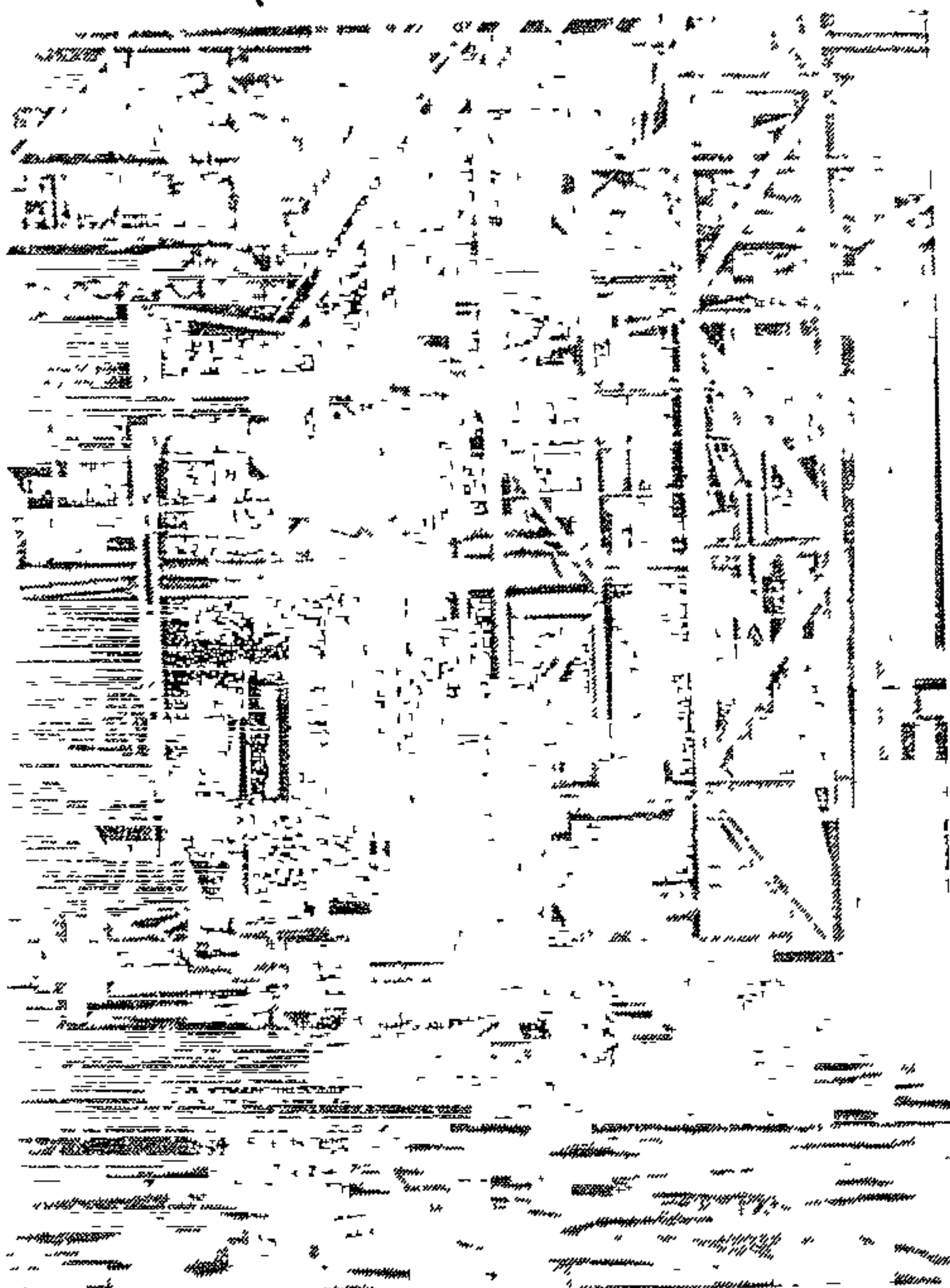

Kuruman district of the Northern Cape.



asbestos. A workman near Kuruman sprays water on asbestos dust.

## 2: Ban by Britain?

By GARNER THOMSON

Weekend Argus Foreign Service  
LONDON — "All medical doubts" about the safety of asbestos are officially over, and by next August Britain will have introduced tough new measures to limit the exposure of asbestos workers — and the public — to the cancer-producing fibres

This week the Health and Safety Commission imposed much more strict controls on the use of all types of asbestos in the United Kingdom, and recommended a complete ban on the two most dangerous types, brown and blue asbestos

The move will go a long way to allaying public fears about the dangers of lung cancer and asbestosis from even relatively low exposures to asbestos fibres — but not far enough for some

Unions are almost unanimous in wanting the industry to commit itself to a complete phase-out of asbestos and, as one workers' representative put it, "to make sure they are well in with the asbestos-substitutes before it is too late"

For some, it is too late. Many people suffered crippling and fatal diseases as a direct result of breathing in asbestos fibres. One, a woman known to the country simply as "Alice", the subject of an horrific television investigation into the effect of asbestos on people who had worked with it, was directly responsible for the outcry that led to this commission

Unfortunately, Alice did not live to see the victory

While the new restrictions will come into effect only in a year's time, the eight-man commission also agreed to hold immediate talks with the Department of the Environment to see what protective measures could be taken to limit the public's exposure to asbestos

Throughout the country, thousands of buildings are known to have asbestos roofing, insulation or ceilings. Its disposal remains a major health risk

The commission also recommended that the present limits to the amount of asbestos in the air in factories and loading bays should be reduced from one fibre to half a fibre per millilitre of air

This refers only to white asbestos. Brown asbestos will be cut from 0.5 to 0.2 and blue asbestos will remain unchanged at 0.2

"All medical doubts (about the safety of asbestos) are over and we've got to get the limits down as low as possible," said commission chairman Mr Bill Simpson

"I think that most people will feel that this important package of regulations will begin to meet the very serious problem facing asbestos workers"



# 3: SA Under the Spotlight to

25/4 27/8/83

(212)

PROJEC TED deaths from asbesto-related diseases in America alone range from 8 500 to 10 000 a year for the next 30 years — and that is if we stopped using asbestos today," says Mr Barry Castleman, international expert on industrial health.

South Africa, the major producer of blue asbestos (crocidolite) and amosite, has frequently come under the spotlight in the asbestos debate

It was in South Africa in 1960 that research conducted by Dr C A Steggs and Dr Chris Wagner produced sufficient medical evidence to show that blue asbestos caused or promoted asbestosis (a non-malignant lung disease) and a rare type of cancer of the lung lining — mesothelioma — among the miners and people who lived in communities near asbestos mines.

In their research, precipitated by the outbreak of the strange

lung diseases in Kuru-man in the Northern Cape, the doctors found "unbelievable conditions on the asbestos mines and mills"

Among the workers in the open-cast mines were women, often with babies on their backs, who separated the asbestos fibres from the serpentine rock by hand

Unlined hessian sacks were used as repositories and every time the load was moved, clouds of blue dust filled the air

Workers emerged from the mills covered with layers of the lethal dust, and asbestos waste was used for the roads in the communities

The result was that not only the miners, but people who passed through the area or lived there for short periods, were developing mesothelioma

The confidential report of the Pneumoconiosis Research Unit's mesothelioma survey of April 1962 stated: "Peo-

ple who live or have lived in the areas of Prieska, Koegas, Kuru-man and Penge are in danger of contracting asbestosis — even though they have no industrial exposure to asbestos dust inhalation.

"An alarmingly high number of cases of mesothelioma have been discovered among people who live or have lived in the North Western Cape... There is evidence to suggest that this condition is associated with exposure to asbestos dust, which again need not be industrial."

The report was never published in South Africa, allegedly as a result of pressure from business interests in the industry.

As a result of this

and other research conducted in First World countries, it is now scientifically widely accepted that blue asbestos is so dangerous that even the most stringent dust-control safeguards are not sufficient, and the mineral should rather be left below the Earth's surface

guards at certain mines.

The outcome was an inquiry by the Department of Mineral and Energy Affairs into health conditions at asbestos mining towns.

This was followed by an announcement that stricter controls to reduce health hazards would be introduced.

Among the controls scheduled to come into effect next year are:

- A reduction in the acceptable asbestos fibre concentrations at surface operations from five fibres to two fibres to a millilitre of air (The threshold limit value for blue asbestos has been set in Western countries and is 10 times lower — 0,2 fibres/ml).
- Modernising asbestos mills that are still regarded as antiquated.
- Phasing out sun-drying and double handling of asbestos materials

Less than a year ago two films, shot on site at South African asbestos mines and shown by the BBC overseas, caused an international outcry because of the lack of adequate safe-

the US, C rope are be felt by as a major

Consum bestos, n than 3 000 has drop than two- US over years.

As a re munity pr bestos-cen Canada have be schools wi tos-fibre it tent have down, and asbestos other fab ducts h banned.

The indi ing from 1 blows of lawsuits.

## Controls

Blue asbestos is now banned in England and Holland

Sweden banned all asbestos products more than 10 years ago

## Diseases

However, the fact remains that it can take up to 20 years before the asbestos-related diseases reveal themselves.

Activities of the powerful asbestos lobby in



# SA Under the spotlight too

25/6 27/8/63

217

**LECTED** lung diseases in Kuru-  
rom asbestos man in the Northern  
d diseases Cape, the doctors found  
ica alone "unbelievable condi-  
m 8 500 to tions on the asbestos  
ear for the mines and mills".

ars — and Among the workers  
we stopped in the open-cast mines  
bestos to- were women, often with  
Mr Barry babies on their backs,  
1, interna- who separated the as-  
ert on in- bestos fibres from the  
alth serpentine rock by  
hand.

ica, the ma- Unlined hessian  
r of blue as- sacks were used as re-  
dolite) and positories and every  
frequently time the load was  
r the spot- moved, clouds of blue  
e asbestos dust filled the air

**South Afri-** Workers emerged  
at research from the mills covered  
y Dr C A with layers of the lethal  
Dr Chris dust, and asbestos  
luced suffi- waste was used for the  
il evidence roads in the commu-  
blue asbes- nities. The result was  
-promoted that not only the min-  
non-malig- ers, but people who  
-case) and a passed through the area  
g — meso- or lived there for short  
- among the periods, were develop-  
eople who ing mesothelioma  
-minuties The confidential re-  
mines. port of the Pneumocon-  
research, iosis Research Unit's  
y the out- mesothelioma survey of  
- strange April 1962 stated: "Peo-

THE asbestos industry has been at the centre of international con-  
trovery since the 1960s when it was discovered that the refined  
fibre was a "killer dust" with an estimated 40 percent fatality rate  
among occupationally exposed workers. CAROLYN DEMPSTER  
reports.

ple who live or have  
lived in the areas of  
Prieska, Koegas, Kuru-  
man and Penge are in  
danger of contracting  
asbestosis — even  
though they have no in-  
dustrial exposure to as-  
bestos dust inhalation

### Lethal

"An alarmingly high  
number of cases of  
mesothelioma have  
been discovered among  
people who live or have  
lived in the North West-  
ern Cape ... There is  
evidence to suggest  
that this condition is  
associated with expo-  
sure to asbestos dust,  
which again need not  
be industrial"

The report was never  
published in South Afri-  
ca, allegedly as a result  
of pressure from busi-  
ness interests in the  
industry  
As a result of this

and other research con-  
ducted in First World  
countries, it is now scr-  
entifically widely ac-  
cepted that blue asbes-  
tos is so dangerous that  
even the most stringent  
dust-control safeguards  
are not sufficient, and  
the mineral should  
rather be left below the  
Earth's surface

### Controls

Blue asbestos is now  
banned in England and  
Holland. Sweden  
banned all asbestos  
products more than 10  
years ago.

Less than a year ago  
two films, shot on site  
at South African asbes-  
tos mines and shown by  
the BBC overseas,  
caused an international  
outcry because of the  
lack of adequate safe-

● A pre-employment  
information system to  
tell workers of the dan-  
gers of working with  
asbestos  
The government min-  
ing engineer, Mr G P  
Badenhorst, used the  
World Symposium on  
Asbestos in Montreal in  
1972 to support the  
State's stance. "The an-  
swer lies in the system-  
atic and concerted ap-  
plication of a rigorous  
and continual control in  
the mining industry,"  
he said

● A reduction in the  
acceptable asbestos fi-  
bre concentrations at  
surface operations from  
five fibres to two fibres  
to a millilitre of air.  
(The threshold limit  
value for blue asbestos  
has been set in Western  
countries and is 10  
times lower — 0.2  
fibres/ml).  
● Modernising asbestos  
mills that are still re-  
garded as antiquated.  
● Phasing out sun-dry-  
ing and double handling  
of asbestos materials.

### Diseases

However, the fact re-  
mains that it can take  
up to 20 years before  
the asbestos-related  
diseases reveal  
themselves  
Activities of the pow-  
erful asbestos lobby in  
the US, Canada and Eu-  
rope are beginning to  
be felt by South Africa  
as a major exporter  
Consumption of as-  
bestos, used in more  
than 3 000 applications,  
has dropped by more  
than two-thirds in the  
US over the past six  
years  
As a result of com-  
munity pressure, six as-  
bestos-cement plants in  
Canada and the US  
have been closed,  
schools with high asbes-  
tos-fibre insulation con-  
tent have been shut  
down, and in England  
asbestos heaters and  
other fabricated pro-  
ducts have been  
banned.  
The industry is reel-  
ing from the counter-  
blows of multiple  
lawsuits.

# Cautious optimism in face of <sup>217</sup> uranium stockpile <sup>RDH 2/8/83</sup>

By NEIL BEHRMANN

LONDON. — Delegates at an international uranium symposium here last week were guardedly optimistic about future prospects but they remained worried that the huge international uranium stockpile would continue to swamp demand.

"Since 1970, production has exceeded consumption by at least 50%," said Mr Michael Townsend, head of the British Civil Uranium Procurement Organisation. He was surprised at the scale of over-production and the fact that it had persisted for so long.

Even though prices are well below their peak of \$43 a pound, last seen in 1978, they improved sharply from their lows last year.

The free market cash price, calculated by Nuexco, an international consulting and broking firm, increased from \$17 last September to \$24 this month. Delegates said that uranium prices rose despite large stocks, because producers and utilities took advantage of "bargain basement" prices.

With quotes under the cost of production, producers, including South Africans, bought material on the free market and withheld supplies to support prices.

"The fall-out in the industry is over and the trend is now upwards," said Mr Barry Lloyd, general manager of marketing at Australian uranium producer Pancontinental Mining.

Since the "worst was over", he forecast that prices would rise towards the "psychological barrier" of \$30 a pound.

But Mr Pierre Verbeek, an engineer at the fuel supply department at Synatom in Belgium, said average European and US medium- and long-term contract prices ranged between \$30 and \$35 a pound.

"Less than 10% of global uranium requirements have been covered by short-term spot purchases for delivery of up to two years," he said.

Even though delegates thought the worst was over, they thought prices would stick at present ranges until stocks wound down.

"Supplies are assured — material in the hands of consumers alone amounts to some four years forward consumption," said Mr Townsend. But he added that consumption increased at a steady rate from 1980 to 1982 and was "becoming much closer to production".

He said the situation was confusing. If mines stopped excessive production and inventories were not used to meet new requirements, new production facilities would be needed to meet demand in 10 years.

But if production fell below consumption, new mines would be necessary in only five years.

"If, however, there was a greater distribution of inventory, plus a modicum of overproduction and perhaps further cancellations and delays of new nuclear generating capacity, then supplies would exceed demand beyond 1995," he added.

While the US slashed output, "considerable production" could emanate from Canada, Australia, South Africa and other countries.

"Several ore deposits can meet uranium needs well into the eighties," said Mr Paul Ammann, director of technology and engineering at Charles River Associates in the US.

He estimated that Australia's mining operating costs — excluding depreciation, amortisation, interest charges and return on capital — were less than \$10 a pound.

He estimated that Canadian and African producers could produce yellow cake at less than \$20 a pound, while US costs ranged from \$20 to \$50 a pound.



# Aluminium scrap exports are pushing up prices, says Afsa

By SIMON WILLSON  
Industrial Editor

ALUMINIUM scrap prices almost doubled in the first seven months of the year and would soon contribute to higher costs in the manufacturing sector, the Aluminium Federation of South Africa (Afsa) said yesterday.

Afsa executive director Mr Fame Malan said prices were being driven up by aluminium scrap exports which

South African industry could ill afford

Domestic demand for scrap exceeded supply and the exporting of scrap aggravated the local shortage and drove up prices, he said.

Prices were also inflated by the need to make up the shortfall in domestic supplies of aluminium scrap by buying more costly scrap imports

Afsa attributes this year's increase in scrap exports to the new, free-market philosophy sweeping through South

African trade policy, under which controls and protection for local industries are no longer as easy to come by as they once were

"The value of aluminium scrap to South Africa was recognised until earlier this year in the form of an agreement which was fundamentally acceptable to both merchant and consumer," Mr Malan said

But subsequently a "commitment to free trade on the part of the authorities eased the qualifications for the is-

sue of export permits, and the net result was a quite understandable opportunity for an outflow of valuable scrap to overseas markets"

Afsa wants "an orderly system" of control and inspection of scrap exports. Local scrap demand is estimated at 30 000 tons a year, while local scrap production is only about 20 000 tons a year. Scrap exports have this year risen from below 3 000 tons a year to more than 5 000 tons, according to Afsa figures

Prices have risen from 45c per kilo for cast scrap in January to 90c a kilo last month, while extruded scrap prices have risen from 80c to R1,40c

Scrap aluminium is re-smelted to manufacture cast items such as pistons in car engines, automotive wheel hubs and light industrial motor bodywork

Mr Malan said South Africa was losing high-value energy inputs by exporting aluminium scrap so freely

About 15 kilowatt/hours (kW/h) of electrical energy was needed to produce one kilogram of primary aluminium. Only 5% of that energy was required, however, to convert a kilogram of scrap aluminium back into usable metal

217

217  
US order  
against  
UK, SA  
S. Post  
asbestos  
firms 13/9/83

MARSGALL, Texas — A federal US judge yesterday ordered a British asbestos supplier and its South African subsidiary to pay \$12 million (about R13 million) to 160 Texas residents exposed to the mineral

US District Judge William Steger entered default judgments against the two firms, which have refused to accept court papers served on them

The plaintiffs, some of whom are dead, were each awarded \$75 000 (R82 500)

Mr Blake Bailey, an attorney for the plaintiffs, said the US State Department has agreed to collect the judgments from the two companies, Cape Asbestos Co of England and Egnep Proprietary Ltd of South Africa

"The US Government agreed to bear the cost of collection of default judgments against the companies," Mr Bailey said

He helped file medical summaries of 160 East Texas residents exposed to asbestos while working in or near two plants in Owentown

Egnep and Cape Asbestos shipped asbestos to several American companies who in turn supplied the Texas plants

Asbestos fibres have been linked to a fatal lung disease known as asbestosis — Sapa-AP

# Nature area proclamation welcomed

CAPE TOWN 8/10/83

217

Environment Reporter  
**CONSERVATIONISTS** yesterday applauded the proclamation of the Table Mountain and Southern Peninsula mountain chain as a nature area but were critical of moves to expand kaolin mining in the Noordhoek valley.

They expressed concern at what they said were loopholes in the proclamation that could permit development in sensitive areas such as Sandy Bay.

In terms of the proclamation, development in the nature area is still permitted but apart from going through existing channels the developer would have to obtain a special permit, sanctioned by a management committee for the area and approved by the Minister of Environment Affairs.

Professor Anthony Hall, chairman of the Co-ordinating Council for Nature Conservation in the Cape and of the Cape Peninsula Conservation Trust (Captrust) said the greatest aspect of the proclamation was that it recognized that the Peninsula was of national park status

## 'Unique'

He said it was unique in the Southern Hemisphere for such a major nature area to be proclaimed on the fringe of a large metropolitan unit.

However, he believed there were possible loopholes in the permit granting procedure and said moves to develop the Sandy Bay area, in particular, would be watched "very carefully".

He was also "deeply worried" about kaolin mining in Noordhoek in the long-term as the valley was of high environmental quality

He said it was important now to ensure that all the recommendations of the Hey Commission were carried out.

Among the urgent priorities was alien vegetation clearing, the prevention of erosion, general mountain care and protection of the

rare and endangered plants on the Cape Peninsula

The president of the Habitat Council, Professor R C Bigalke, described the move as a significant step but said he was "extremely upset" about expanded kaolin mining areas so close to natural and residential areas in Noordhoek.

He expressed the hope that expansion in areas like Sandy Bay would be tightly controlled and said the council eagerly awaited efficient machinery for management of the area to swing into motion.

The chairman of the Western Cape branch of the Wildlife Society, Mr Barry Low, said it was particularly significant that Sandy Bay had been included in the nature area, but warned that the society would be watchful for any renewed efforts to develop the area

## Concern

Mr Low also expressed concern about the potential future exploitation of kaolin as it "was not consistent with a nature reserve area"

The chairman of the flora conservation committee of the Botanical Society, Mr Dale Parker said it was a major step forward that the fynbos vegetation of the Cape had been given national recognition.



# Dark cloud over SA asbestos

CAPE TIMES 10/10/83 (217)

A DARK cloud hangs over the South African asbestos industry

Overseas, alarm over the deadly asbestos fibres — which have been proved to cause asbestosis, mesothelioma and lung cancer — has led to a steady tightening of controls to protect people who work with the substance

Sweden and Norway have banned asbestos-based production. In Britain this year, the Health and Safety Commission found that "no medical doubt exists that workplace controls on asbestos should be as tight as possible"

A serious challenge to the South African asbestos industry was issued seven weeks ago by Mr Barry Castleman, a visiting American expert on occupational health

## Death hazard

He charged that thousands of South African workers faced death and many might already have died as a result of contact with asbestos

In the United States, he said, between 8 500 and 10 000 people were expected to die in the next 30 years as a result of contact with the substance

While some scientific controversy still surrounds the safety of the asbestos industry, even spokesmen for the industry agree that asbestos is a potentially hazardous substance

The difference of opinion is between those who believe there is no safe level and those who believe there can be acceptably-safe

By PHILLIP VAN NIEKERK

levels if controls are applied

Professor A M Coetzee, head of the Department of Community Medicine at the University of Pretoria and a consultant to an asbestos company, wrote to a Johannesburg newspaper

"I am convinced that due to stringent precautionary measures instituted by the mines and the asbestos cement industry, the likelihood of workers contracting diseases today is minimal"

This is countered by experts such as Mr Castleman who have found that even marginal exposures to blue asbestos can cause mesothelioma, a rare type of cancer of the lung, and that there is no safety limit for lung cancer. And lung cancer is not a recompensable disease in terms of the Workmen's Compensation Act

Clearly, South Africa is lagging behind the standards of the developed world

## UK import ban

The British Commission's recommendations on asbestos, to be enforced next year, include a ban on the importation and manufacture of blue and brown asbestos

Workplace limits for brown asbestos are to be reduced from 0,5 fibre to 0,2 per ml of air for brown asbestos and from 1,0 fibre to 0,5 per ml for white asbestos. The blue asbestos limit

is to remain at 0,2 per ml of air

In South Africa, a change in the job-safety laws from early next year will limit the permissible level of all fibres to 2,0 per ml of air — 10 times higher than the current UK standard for blue asbestos, regarded as the most dangerous fibre

Mr Castleman believes that large corporations are exporting industrial hazards to countries where there are few or no regulations or controls

## Factory transfer

When West Germany announced in 1980 that they would be phasing out asbestos, the machinery and equipment of an asbestos textile factory was dismantled and moved to Cape Town, where a new factory, Kapasit Asbestos, was set up

A spokesman for Everite, which has the largest share of the domestic asbestos cement market, said that though they had consistently improved on control standards since the early sixties, they were searching for alternative fibres to replace asbestos

This was because they recognized that fine asbestos dust was a danger and wanted to eliminate it "where humanly possible", the control mechanisms were costly in economic terms, it was very demanding for management and workers to conform to the control procedures and, finally, asbestos reserves in the ground would not last forever

R  
01  
O  
24  
  
T  
h  
ur  
th  
"  
th  
  
T  
a  
r

# Everite seeks substitute for asbestos in fibre-cement

ARGUS 13/10/83

~~13/10/83~~  
217

EVERITE has been carrying out research on the use of alternatives to asbestos in fibre-cement products and some promising developments are in sight, its chairman, Mr H Thoeni, says in the annual report

He says meanwhile the company shares public concern about the effect on health of breathing in asbestos fibres

It has invested heavily in measures to control respirable asbestos fibres at all work places in the fibre-cement division to international safety standards

#### NO RISK

"Everite is convinced that, under present safety and health conditions and providing recommended precautionary measures are observed, there is no abnormal risk to employees in the fibre-cement industry nor to contractors who use fibre-cement products containing asbestos"

Mr Thoeni expects the recession to continue until at least mid-1984

But in spite of this and the effects of the drought he expects profits to be close to the past year's performance

The group lifted after-tax profit for the year to June by 16 percent to R15,4-million and turnover by 7 percent to R176,1-million

#### SURPLUS CASH

"The improvement in profit is mainly due to increased investment income arising from surplus cash, a lower Lifo stock adjustment and fees earned for participation in lessor trusts formed for the lease of certain manufacturing facilities

"A further contributing factor was tight cost and staff complement control"

Dividends were maintained at 50c a share

Audrey d'Angelo



Cape Times 25/10/83 (217) ~~217~~

# Western Platinum profits soar by 73%

Own Correspondent  
JOHANNESBURG. —  
Western Platinum  
(Westplat) increased its  
working profit by 73 per-  
cent to R24,845m in the  
year ended September  
from R14,362m the pre-  
vious financial year.

The Lonrho-con-  
trolled producer had an  
excellent year from  
both the operating and  
financial aspects

The mine is a relative-  
ly small producer and  
because of its size has  
been left unscathed by  
the depressed condi-  
tions which dominated  
the platinum market  
over the last two years.

## Production

Since 1981 Wesplat  
has increased its pro-  
duction by nearly 50  
percent to 125 000  
ounces of platinum a  
year from 85 000 ounces

Marketing of West-  
plat's production is han-  
dled by Falconbridge  
and is apparently large-  
ly sold on contracts but  
at free market prices.

Westplat milled  
1,949m tons (previous  
year 1,592m) in the year  
to end-September.

Platinum production  
increased to 3 796 kg  
(3 224 kg), palladium  
production to 1 660 kg

(1 392 kg) and produc-  
tion of other precious  
metals to 1 200 kg  
(820 kg)

Westplat's production  
of base metals was gen-  
erally lower

Nickel production  
dropped to 1 943 tons  
(2 004 tons), copper pro-  
duction to 1 210 tons  
(1 239 tons) and cobalt to  
21 tons (22 tons)

Working costs for the  
year rose 21 percent to

R22,59 a ton milled from  
R18,67 a ton milled pre-  
viously

Sales, net of commis-  
sions, rose to R85,018m  
from R48,051m previous-  
ly, while cost of sales  
jumped 78 percent to  
R60,173m (R33,639m)

Westplat's capex for  
the year dropped to  
R5,375m (R14,628m) and  
the company paid divi-  
dends totalling R8,470m  
in the year

CAPL TINKS 25/10/83

# Black Mountain turns loss to R1,334m<sup>(217)</sup> profit

JOHANNESBURG. — Black Mountain has marked time over the last six months earning profits of only R156 000 in two quarters. The September quarter results from the Gold Fields of South Africa (GFSA) controlled base metal producer show the company made a net profit of R1,334m. This follows a loss of R1,178m in the quarter to end-June and compares with profits of R5,081m in the March quarter.

For the nine months to end-September Black Mountain showed a net profit of R5,237m. The September quarter results also reveal that while Black Mountain's total debt remains unchanged the cost of financing it increased by 16,7 percent. The instalment of R9m due to the Bank Consortium and short-term bills of R20m, which were payable on September 30, have been rolled over until March 31 next year. Rooiberg Tin's sales revenue a ton fell to R13 405, from R14 020. The mine sells both tin in concentrates and tin metal but does not publish separate prices for each type of commodity. Gross profit dropped to R1,491m (R2,193m). Taxed profit fell 30,8 percent to R1,146m from

R1,656m in the June quarter. Union Tin's sales revenue dropped to R12 149 a ton from R12 920 a ton in the March quarter. Union Tin pushed up its sales to 94 tons from 75 tons previously. However lower revenue and higher costs slashed the profit margin to R128 a ton sold from R1 293 in the March quarter. Gross profits on tin sales consequently fell to R12 000 from R97 000 which with sundry revenue of R32 000 (R28 000) gave Union Tin profits before and after tax of R44 000 (R125 000). Zinc Corporation's results boomed in the September quarter with pre-tax profits soaring to R1,336m (R74 000) on virtually unchanged sales of 20 437 tons (20 382 tons).

Taxed profits were R952 000 (R260 000). Apex Mines, GFSA's coal producing arm, held its own in the September quarter but a 10 percent jump in costs robbed the company of any benefits from improved sales levels. Apex mined 752 000 tons (645 000 tons) but sales were 520 000 tons (515 000 tons). Total sales revenue was R11,352m (R10,765m) but cost of sales rose 10 percent to R8,745m (R7,930m) which left gross profits of R2,607m (R2,835m). Taxed profit was R2,887m (R3,364m) which after capex of R815 000 (R906 000) left distributable earnings of R2,072m (R2,458m). Apex plans to spend a further R2,1m in capex in the December quarter.

T... ..



# Economist forecasts platinum price of \$3 000 an ounce

ARGUS  
25/10/83

217

JOHANNESBURG — The platinum price, fueled by rising industrial and investor demand, could well outpace even the most optimistic forecasts for gold in the precious metal boom, according to Roger Gidlow, Associate Professor of Economics at the University of the Witwatersrand.

In a paper prepared for a Johannesburg gold and platinum dealer, Professor Gidlow said "This could indicate prices in excess of \$3 000 an ounce over the coming years and certainly into the later half of the 1980s"

Professor Gidlow said industrial consumption should rise 10 percent this year and more in 1984, cancelling out the

surplus of supply over demand for the first time since 1979

While industrial demand was boosted by a general economic recovery, Professor Gidlow said supplies from South Africa and the Soviet Union were unlikely to grow much over the next few years.

## STOCKPILES

Looking at new sources of demand, he said the effect of platinum group metal catalysts should be felt from 1985 but cautioned on the possibilities of either strategic stockpiles or platinum jewelry significantly stimulating offtake.

He also cited a number of reasons why investment demand was likely to increase over the next few years, in-

cluding the effect of a higher gold price, inflation worries and the absence of large stocks in the hands of investors.

## CARTEL

He said that because of their vastly different political outlooks, it was difficult to see South Africa and the Soviet Union forging a cartel in the foreseeable future.

But he added: "The dominance of these two producers does strongly suggest that some form of co-operation in the marketing of the metal would be in their common interests."

Together South Africa and the Soviet Union accounted for more than 80 percent of world platinum supply last year. — Reuter.

# Cheaper ore call by Japan's steel makers bound to hurt Iscor

By Duncan Collings

Reports that the major Japanese steel manufacturers are seeking a cut in the price of imported iron ore next year do not bode well for Iscor's troubled Sishen iron ore mine.

The Star's Tokyo correspondent, Geoffrey Murray, reports that Japan's top steel producer has issued an early warning that the price of imported iron ore will have to be cut in fiscal 1984 beginning next April.

This emerged from preliminary contract talks yesterday between Nippon Steel Corporation and two top Australian iron ore producers, Hammersley Iron and Mount Newman.

Nippon Steel executives warned that the Japanese steel industry faced a stringent situation.

They said that the five major blast furnace mills had reported their combined losses in the April-September period at about R500 million.

In order to rationalise their business to assure survival, the mills were compelled to cut raw material costs as much as possible, the Nippon Steel officials were quoted as saying.

They noted that electric furnace mills now accounted for almost 27 percent of Japan's total steel production, compared to 17 percent in the past.

This important change was due mainly to the fact that steel produced by the blast furnaces was almost R50 a ton more expensive, caused by a widening gap in the cost of steel scrap used as the mainstay in blast furnaces,

the officials explained.

Concrete negotiations for fiscal 1984 iron ore contracts are expected to begin in early January.

Iscor, which is a major exporter of iron ore to Japan's steel industry, has already been hard hit by the world steel slump brought on by the recession.

In the year to June 30 1983 iron ore exports by Iscor from Sishen were worth R221 million, a drop of 14 percent over the previous year's R257 million.

Last year's sales represented export sales — both to the Orient and to Europe — of 8.1 million tons of iron ore.

At the time of the annual report in September, Iscor said the disparity between supply and demand of iron ore was assuming ever-increasing dimensions.

It had already resulted in intensified competition among world iron ore producers, which in turn had resulted in US dollar price reductions of some 12 percent on average being applicable to iron ore exporters in general and also to Iscor.

It was expected that the imbalance in the iron ore market could continue up to the 1990s.

If this happened, the already reduced rate of production at the Sishen mine would be affected further and exporting of the ore through Saldanha Bay might become even more unprofitable.

The news today from Tokyo appears to bear out Iscor's fears.



# Cape mine to axe half its labour force

12/12/83  
17665

Staff Reporter

THE O'okiep Copper Com-  
pany in Namaqualand is to  
lay off half of its 3 000 la-  
bour force next year be-  
cause of the worldwide cop-  
per market depression.

This was announced today by  
Mr T P Phillip, general man-  
ager of the company, in a si-  
multaneous announcement in  
New York and South Africa.

He said the O'okiep labour  
force of 3 000 would be reduced  
to 2 000 by mid-1984 and to  
1 500 by the end of next year.

"Both support staff and mine  
production workers will be af-  
fected and all employees will  
receive special separation  
benefits," he said.

A significant portion of this  
reduction in manpower levels  
was scheduled to have taken  
place in any event a year from  
now under long-term mine  
planning, the company stated.

Mine development at the  
Hot's Mine will be suspended  
immediately and will be se-  
verely curtailed at the Speta-  
kel and Carolusberg deep  
mines.

Production from Hot's and  
Spetakel will continue at cur-  
rent rates until the developed  
reserves have been exhausted  
in about April and December  
respectively.

Production previously  
planned for Carolusberg next  
year will be reduced below the  
planned level but will exceed  
this year's levels.

## Reduce costs

The tonnage of copper pro-  
duced by the company next  
year will be about the same as  
that produced this year be-  
cause of the availability of de-  
veloped reserves at Carolus-  
berg.

The measures have been de-  
scribed as austerity moves in-  
tended to reduce costs and  
minimise the outflow of cash.

The company's losses have  
been significant because of the  
depressed worldwide copper  
markets.

At current metal prices and  
with the austerity measures,  
the company's existing lines of  
credit will be exhausted early  
in the first quarter of 1984. The  
company has reached agree-  
ment in principle with its lend-  
ers to increase its credit and to  
re-schedule repayment of bor-  
rowings.

# Copper mine to retrench 1 500

**RIAAN DE VILLIERS**  
THE O'Okiep Copper Company yesterday announced its intention of retrenching 1 000 workers by the middle of next year and another 500 by the year's end

The retrenchments — which will cut the workforce at the company's mines from 3 000 to 2 000 — are expected to have a serious impact on the Namaqualand communities involved

The lay-offs are part of a "series of austerity moves" due to the depressed state of the world copper market, according to a statement issued by the company's general manager, Mr T Philip, yesterday

He said both support staff and mine production workers would be

affected and all employees would receive special separation benefits

Mr Philip was not available for further comment yesterday and it is not known when the retrenchments will begin

Spokesmen for trade unions believed to have members at the company's mines were also not available for comment

The "austerity moves" were aimed at reducing costs and minimizing the outflow of cash, as the depressed copper markets continued to cause the company to sustain "significant losses", the statement said

Development at the Hoits mine would be suspended immediately

and would be severely curtailed at the Spektakel and Carolusberg Deep mines

Mine production from Hoits and Spektakel would continue at current rates until developed reserves had been exhausted, which was expected to take place in April and December next year

## Reserves

The rate of mine production previously planned for 1984 from the Carolusberg mine would be reduced but would exceed 1983 levels, and even with this revision the tonnage of copper produced by the company next year would still approximate production this year, the statement said

It added that at current metal prices and with the austerity measures in place, the company's existing lines of credit would be exhausted early next year

However, it had reached agreement in principle with its lenders to increase its credit line and to reschedule the repayment of its outstanding borrowings



# Mine lay-off 'disaster' for Namaqualand

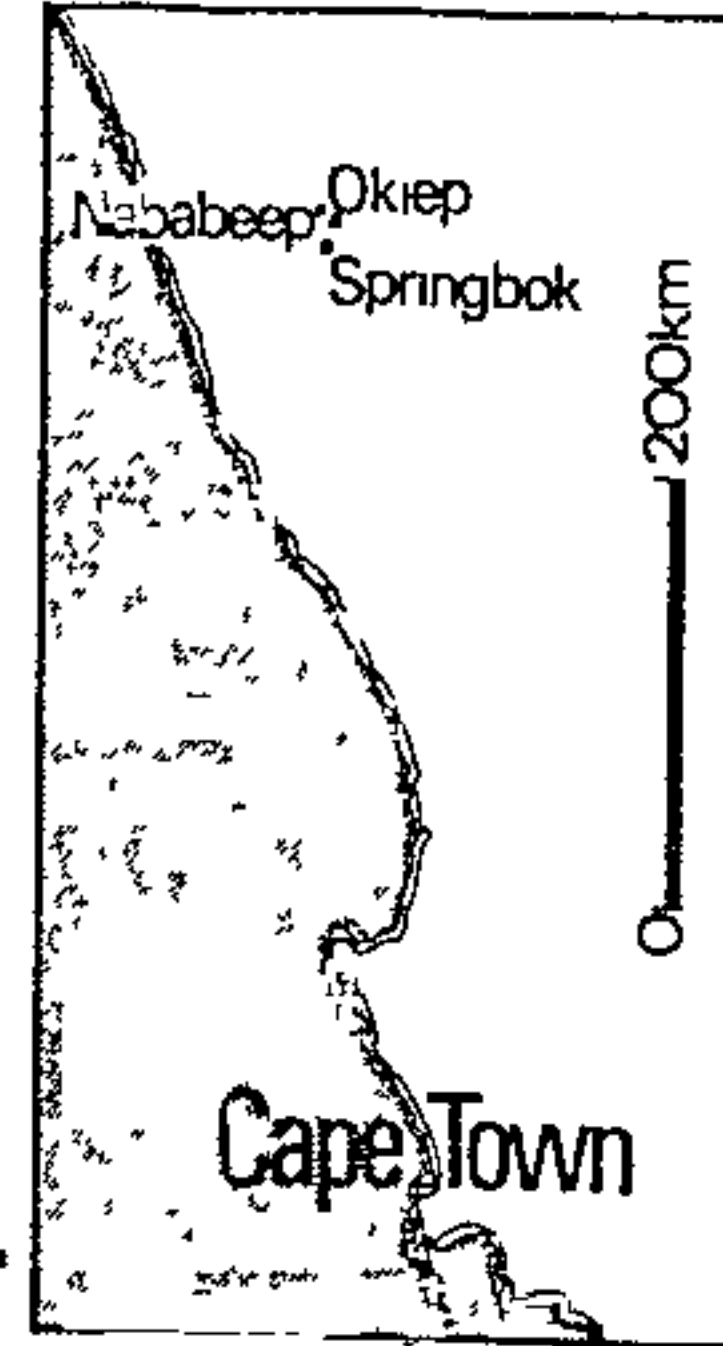

By ANDRIES DU  
TOIT  
Staff Reporter

THE decision by the O'Okiep Copper Company to lay off half its workforce next year has been described as an "economic disaster" for Namaqualand.

Namaqualand depends on the mining industry for most of its revenue and the decision is expected to hit the whole community.

The company says the cause is the worldwide depression in the copper market.

Of the 3 000 workforce 1 000 will be laid off by mid-1984 and 500 in the second half of the year. All employees will receive special separation benefits.

## "All scared"

Mr B J Jones, branch chairman of the Amalgamated Engineering Union, said people in the company's development branches, such as geology, exploration and diamond-drilling, had been told they would be retrenched, but others in branches such as administration did not know their position.

An employee who did not want to be identified said "We are all scared

Nobody knows what is happening I don't know whether I will have a job next year"

Mr P A Joseph, area secretary of the Engineering and Industrial Union, which represents coloured workers, said the lay-offs would cause havoc in the community.

Husbands would have to seek work in other towns and this would spell disaster for family life, schools and churches.

"We knew they would lay people off, but we did not know it would be this bad"

Mr Stephanus Cloete, a Nababeep businessman, said the lay-offs were "very sad".

"Where can the people go? It does not help to look for work somewhere else. Everywhere people are being laid off"

Businessmen in the area agreed that the retrenchments were "an economic disaster". But opinions about their own prospects varied.

Businessmen in Springbok, the largest business centre, said they thought they could survive, but those in smaller communities such as Okiep, Carolusberg and Nababeep, as well as car and furniture salesmen, thought they had been dealt a crippling blow.

Some entrepreneurs said they would have to give up.

Mrs Helen Hudson, of Ons Winkel, Nababeep, said times were already hard. She did not think her business would survive the lay-offs. "We will have to close our shop."

Other proprietors were cautiously optimistic. They felt conditions would improve "after a few years" and that they could stick it out until then.

A car salesman in Springbok said the lay-offs were "a disaster to the whole community", but could be survived.

## "Sit it out"

The only thing to do was to "take stock and sit it out"

Mr J H Kotze, also a car salesman, said "We will just have to work harder. Then we will survive."

Mr G E Olivier, a general dealer in Nababeep, said he knew hard times were ahead, but he intended to weather the storm.

"I've done well in this town and it would be wrong of me to leave now," he said.

"Things will get better"

ARGUS

13/12/83

217

~~211~~ 31

# State aid saved mines from closure

AKGUS  
16/12/88  
ZIT

Staff Reporter

THE O'Okiep Copper Company, which is to lay off 1 500 workers next year, would have had to close its mines entirely had the Government not passed emergency legislation to give it economic assistance.

This was disclosed this week by Mr Eli Louw, the Deputy Minister of Finance.

The Finance Bill, which provided for the Government to guarantee a R40-million loan to the company by Barclays Bank, was rushed through Parliament during the all-night sitting on the last day of the 1982 session.

The company, whose largest shareholders are two huge American companies, Newmont and Amex, needed to develop a deeply-situated ore body at Carolusberg mines because existing reserves were becoming depleted. For this they needed R40-million.

## Would have closed

Mr Louw said when he introduced the legislation that without the loan the parent companies would have to close the mines and reopen them again only when copper prices improved.

If they could develop the deposit at Carolusberg the life of the O'Okiep Copper Company would be extended by a further 10 or 12 years.

Mr Louw told Parliament the closing of the mine would spell economic disaster for the area and that the copper industry was vitally important to the economy of Namaqualand.

If the mines closed more than 3 000 people, whose earnings amounted to R19-million, would lose their jobs.

## Lives of 13 000

The closing of the mine would have affected the lives of 13 000 people living in the area, he said.

The mine consumed water and electricity worth about R6,5-million. Without this market, the provision of Escom power and Orange River water would not have been practical in the region.

All other businesses, light industries, education, health and other services would have been directly or indirectly affected. Even the farming community, dependent on the jobs provided by the copper industry in times of scarcity, would have been devastated by such a decision.

To avert this, the Government passed the special legislation so that it could guarantee the Barclays loan.

In terms of the legislation, if O'Okiep Copper Company did not fulfil its obligations to Barclays Bank, or if Barclays Bank demanded the money, the loan would have to be paid by the Government out of the State revenue account.

Mr Louw said this week he had met top management of O'Okiep Copper Company, who had promised to lay off the workers only gradually and to do everything possible to find work for them elsewhere.

The Department of Manpower in Pretoria had also promised to send officials to Okiep to help with unemployment insurance.

Mr Louw said he was aware that lay-offs would still have a negative influence on the economy. He was confident, however, that a much larger economic disaster had been averted. If the mines had closed, "things would have been very terrible".

Mr Louw said he regretted the necessity of the redundancies.

licat  
with  
teac  
mor  
exp  
Dun  
J  
Am  
stu  
no  
N  
tri  
la  
le  
ve  
te  
e  
n  
b  
u  
b  
s  
p  
t  
e  
b

Hundreds  
WIN JOSE 324



# SA able to meet world demand for ferrochrome

By Duncan Collings

Deputy Financial Editor

South African ferrochrome producers should have no trouble meeting world demand for their product in 1984, says Mr John Hall, chairman of Middelburg Steel and Alloys.

He said that this would be despite a rapid increase in offtake expected in the first six months of next year as the world economic recovery gets into top gear.

Mr Hall was reacting to a report from The Star's correspondent in Tokyo, Geoffrey Murray, that Japanese steel mills are facing the very real prospect of a shortage of high-carbon ferrochrome at least in the first six months of next year.

Their key concern is whether South Africa will be able to supply sufficient tonnage to make up for a planned reduction in domestic ferrochrome production.

If not, local ferro-alloy makers may have to revise their plans for a continued scale-down of production.

Unable to compete with low-priced imports, particularly from South Africa, local producers have been gradually reducing operations to cut their crippling business losses and stay out of the bankruptcy court.

Several electric furnaces were scheduled to be shut down in 1984, and this was expected to cut output by a further 50 000 tons. Production this year has already been cut by about the same amount — from last year's 322 000 tons to 272 000 tons.

The steel mills accepted this as they anticipated making up the shortfall by extra purchases from South Africa.

But according to well-informed industry sources, such a plan is now in doubt.

According to the sources, American buyers have been most active in taking up South

African output well into 1984, and there are doubts in Tokyo whether even the planned production increase in the Republic will be sufficient to meet Japan's extra needs.

There is little hope that Zimbabwe can fill the gap. Producers will need most of next year to develop its capacity.

The Japanese mills also miscalculated what they could get from the Philippines, which has also been actively signing 1984 supply contracts with the United States, which has no domestic ferrochrome production.

As a result, industry sources see the prospect that ferroalloy makers in Japan will be compelled to reconsider their production cutback plan.

Some firms, in fact, have already begun this process, especially in looking for a good source of low-priced chrome ore that will enable them to maintain a reasonably viable operation and keep their steel mill customers happy.

Mr Hall said that while South African chrome exporters have to date only been requested to maintain their normal level of shipments to Japan, the expected increased demand next year is symptomatic of a market turnaround.

But he warned, there is inevitably an overreaction as buyers tend to overorder when it is clear that demand for end-products is increasing. For this reason the first six months of next year could be a period of fluctuating orders as the demand/supply situation settles down.

However, Mr Hall said that South African suppliers should be able to keep pace with demand and pointed out that some local producers in 1983 operated as low as 40 percent of capacity.

"If there are any delays in meeting demand this will simply be a period of gearing up production to the increased offtake," he said.



Mr Owen Dinsdale, managing director of Barlows Manufacturing Co, has been appointed to the board of Barlow Rand Industries Earthmoving, Motor and Appliances division

# JCI lifts profits — interim div up 38%

CAPE TIMES 17/1/84

By BRENDAN RYAN

217

**JOHANNESBURG.** — Johannesburg Consolidated Investment's (JCI) attributable profit is up 15,2 percent to R56,1m (previously R48,7m) for the six months to end-December.

However, the group's directors say it is unlikely a similar increase in attributable profits will be achieved in the second six months of the financial year to end-June

JCI has increased its interim dividend by 38 percent to 180c a share from the previous interim of 130c a share

Key factors in the group's improved performance for the first

six months of its 1984 financial year were the dividends from Randfontein Estates gold mine and Rustenburg Platinum Holdings

JCI's profit before preference dividends rose to R60,3m from R53,0m of which the major contribution came from investment income

### Investment income

For the six months to end-December investment income was R46,7m compared with R35,3m previously.

In the year, JCI received 532 842 new shares in Randfontein for the mineral rights it sold to the mine to set up a mining operation in the new Doornkop section.

Randfontein paid dividends totalling R12 last year bringing in an additional R6,466m to JCI.

The increased final dividend from Rustenburg last year was brought to account in the first half of JCI's 1984 financial year and contributed another R4,1m in additional income

These two sources together totalled R10,566m in extra income and the remainder of the R11,4m improvement in dividend in-

come came from better payouts from Western Areas and also a dividend from antimony producer Consolidated Murchison which contributed nothing to JCI's previous interim results

### Subsidiaries

JCI's attributable earnings from operating subsidiaries rose slightly to R7,6m from R6,3m previously

According to the general manager of JCI's finance division, Mr Vaughn Bray, the improvement came from the group's Lennings industrial arm which has remained profitable.

Lennings lost money in the previous interim period but the group was restructured, recapitalized and returned to profitability in the second half of the year to end-June 1983

Mr Bray said income from Tavistock colliery was down this year compared to last year, reflecting the overall depressed conditions in the international coal markets

JCI's other net revenue dropped sharply to R6,0m (previously R11,4m) This was a major source of income to the group in the previous financial year when it was particularly successful in its money market operations

Mr Bray said the drop was the result of a lower level of interest received, certain exceptional costs associated with investments including the group's acquisition of its stake in Premier, and a R2m provision for tax

Mr Bray said JCI had worked off the tax loss on its own operations and would soon have to pay tax on its income

from interest and management fees

The R8m (R6,1m) tax paid by JCI in the six months relates to the operations of the group's subsidiaries

He said the increase in the interim dividend was intended to reduce the difference between the levels of the interim and final dividends

JCI's investment in SA Breweries is now held through its stake in the Premier group which pays out more at the interim stage compared with the final dividend than SA Breweries used to

"I believe that JCI's earnings for the year to end-June will show a modest improvement on those of the previous year but not as much as the 15,2 percent of the first half

### Final dividend

"I cannot say at this stage whether the final dividend will be maintained, but we are looking for second half results to be better than those of the second-half of the 1983 financial year," he said.

JCI's net asset value at December 31 was R253 a share compared with R213 at June 30 and R180 on December 31, 1982

**Comment:** A repeat of last year's second-half for JCI would yield earnings of 739c to make a total of 1505c for the year to end-June, seven percent up on the previous year's 1405c

Given this outlook and the expectation that JCI could do better, the maintained final looks a safe bet with a chance of some improvement to the final depending on the gold price and the platinum market



# Strike: Refinery

## workers fired

CAP/ Times 20/1/86  
217

JOHANNESBURG — Almost the entire black work force of Impala Platinum Holdings' refinery in Springs has been dismissed following a strike, according to a statement yesterday from Gencor, the owners

The mass dismissal would not affect the company's ability to meet its contractual commitments, the statement said. Steps were being taken to replace about 1 400 workers dismissed at the weekend after an illegal strike. The men refused to report for work on January 11, in protest against the dismissal of seven fellow-workers.

Discussions were held between management and representatives of the striking workers, "who intruded several other issues into the discussions".

Gencor said management had on January 13 "made an offer which included an invitation to the seven dismissed workers to make representation".

The offer was conditional on the strikers returning to work, and had been refused, the statement said. An ultimatum was then issued to the strikers to return to work or face dismissal — Sapa

# Ingested asbestos fibre poses 'low risk' to health

ARGUS  
13/2/86

Staff Reporter

THE health risk from ingesting asbestos, particularly through drinking water, appears to be zero or very low, a British environmental scientist and consultant says

Dr B T Commins, a former member of the British Water Research Council and now an independent consultant on air and water pollution, is on a lecture tour of South Africa at the invitation of the South African Fibre Reinforced Cement Manufacturers Association

He is addressing water engineers, medical officers of health and others on asbestos fibres in drinking water and the use of fibre-reinforced pipes, based on a report which he published last year

He indicated that it was a comprehensive report with worldwide implications

At a Press conference today, Dr Commins said that specifically carcinogenic effects on health of ingested asbestos appeared to be "sensibly zero" or "very low indeed"

He also said it appeared to be "perfectly OK" to use fibre-reinforced cement pipes, and he expected the use of these pipes to increase, especially in Third World countries

He drew a distinction between the ingestion and inhalation of asbestos fibres and referred to a foreword to his report which said his findings on health risks of ingestion were in sharp contrast to

the problems of inhaled asbestos

Dr Commins said his conclusions were based, among others, on scientific experiments on rats which, if extrapolated to the weight of a man, indicated he could ingest up to 15.6 micrograms of asbestos fibres a day without affecting his health. The normal dose a man would ingest a day was about 0.02 micrograms



# Gencor profits higher raises dividend

Own Correspondent

**JOHANNESBURG** — Increased contributions from all sectors except coal and minerals helped to lift General Mining Union Corporation, Gencor's earnings by 14 percent for 1983, and the final dividend has been raised to 135c from 120c.

The profit improvement is somewhat higher than the market expected, and the dividend increase is even more of a surprise, although it will serve to ease the path of the coming rights issue.

An analysis of Gencor's divisional contributions for the year to December shows that commerce and industry 37,1 percent of attributable income was again the main contributor, followed by gold and uranium 29,2 percent, with the financial division in third place, 16,8 percent.

In the minor placings were platinum 7,2 percent and coal 7,2 percent, with minerals contributing 2,5 percent.

## Asset value

Assets under Gencor's control at December 31 amounted to R7,255 billion, compared with R5,871 billion at the end of 1982, and the net asset value at the year-end amounted to R41,04 a share (R40,24).

Gencor's turnover rose to R4,659 billion last year from R3,959 billion in 1982, operating

income rose to R528,0m from R366,0m, investment income increased to R186,5m from R169,1m and the surplus on realization of investments fell to R3,7m from R13,6m.

Interest soared to R180,5m from R129,3m, exploration costs rose to R16,5m from R14,9m and amounts written off investments and assets rose to R34,3m from R25,9m.

The higher interest payment is a reflection both of higher rates and of substantially increased borrowings, which saw the loan capital balance rise to R1,262 billion at December 31 from R748,4m a year before.

## Dividends

The tax charge almost doubled to R84,7m from R47,1m and after deducting minorities and preference dividends of R93,8m (R64,1m) attributable profit amounted to R305,4m compared with R267,4m for 1982.

Earnings rose to 382c a share from 335c and the final of 135c (120c) takes the total for the year to 190c (175c).

Reviewing the year to December, Gencor's chairman, Mr Ted Pavitt, highlighted the drop in the rand/dollar exchange rate, which had led to an improvement in the rand-denominated gold price.

"This is another reminder of the fact that a significant improvement

in the rand exchange rate can have a serious effect on exports, especially of raw materials."

On the industrial side Mr Pavitt singled out the turnaround by Darling & Hodgson and the improved results from Sappi, and in the financial sector, township development "had a very successful year".

## Economic upturn,

For 1984, Mr Pavitt said the prognosis for the year was "more of the same", with little prospect for an economic upturn, and drought conditions persisting.

However, Gencor was looking for a repeat of 1983's earnings this year, said Mr Pavitt.

He said the improved result for 1983 was achieved in spite of several negative factors prevailing in the South

To page 13

# Gencor

C.T. 6/30/84

From page 12

African economy

- The worst drought for many years
- High interest rates.
- High inflation rate.
- Continued weakness in the economy, which indicated a decrease of 3,2 percent in gross domestic product this year after a fall of 1,2 percent in 1983

## Positive factors

Mr Pavitt said positive factors for Gencor were the acquisition of a controlling interest in Tedex, filling a gap in the group's distribution of interests, last year's agreement with Iscor, which led to the acquisition of a substantial stake in Samancor, and the Beatrix gold mine, which will be brought to full production this year.

Asked to comment on exchange losses incurred by Tedex, Mr Basil Landau, Gencor's executive director, commerce and industry, said the gross losses amounted to R9m, and after tax the loss was about R4m.

He stressed, however, that the losses were in respect of long-term loans, and might never be realized, but they had been fully provided for in Gencor's accounts.

# Gencor asbestos prospects

(217) D. Dispatch  
3/4/84

JOHANNESBURG — Msauli Asbestos expects that its 1984 distributable income will not differ much from its 1983 results, according to the chairman, Mr Luther Jooste

In his annual review he says Msauli's production will improve moderately in the year to end-December and the mine will be able to sell the higher production

However the favourable trend in the rand-dollar exchange rates is expected to reverse during 1984 and Mr Jooste says it will be difficult for the mine to maintain its rand income per ton of asbestos fibre sold

Msauli is planning capital expenditure of R2,7 million in 1984 to be spent on the tertiary incline shaft system and on dust control measures which will reduce available income

Capital expenditure should drop off sharply from 1984 when the tertiary shaft system is complete

Msauli increased its taxed income to R3,334 million (51,68c a share) in 1983 compared with R1,029 million (15,95c a share) and paid dividends totalling 10c after passing its dividends

during 1982

Msauli produces chrysotile asbestos fibre from its mines in the KaNgwane homeland in Eastern Transvaal

The company's product is high-quality and its principal customers are in the Far East

According to Mr Jooste, sales increased significantly during 1983 but he provides no sales or production figures to back up his comments

Both Msauli and its sister mine, the other Gencor-controlled asbestos producer, Gefco, ceased to publish detailed mining information in 1982 when Gencor decided this was detrimental to the companies, given the competitive nature of the asbestos markets

Msauli suffered severe mining problems during 1982 which adversely affected production but Mr Jooste says these have now been solved

Mr Jooste says the weak economic climate led to a world-wide oversupply of chrysotile fibre

In his annual review of Griqualand Exploration and Finance (Gefco), Mr Jooste says profitability could drop during 1984

and further production cutbacks may be necessary

The group produces amosite and crocidolite types of asbestos from mines in the northern Cape and the eastern Transvaal and has a world monopoly on production of both commodities

Mr Jooste says group sales dropped by 10 per cent during 1983 because of the weak economic climate and health and environmental pressures against both types of asbestos produced by Gefco

He says environmental pressures are particularly hitting the market for crocidolite asbestos and some customers have either reduced consumption or replaced their requirements with equivalent grades of chrysotile asbestos

Mr Jooste says European manufacturers are confident they can operate within the new health limits imposed by the European Economic Community

"The situation is more critical in the United States, where the authorities are contemplating action which could result in a partial ban on the manufacture

of certain asbestos products

"These proposals are, however, being strongly contested by industry in the United States courts on the grounds that there is no new scientific evidence to prove that asbestos cannot be used safely"

Marketing of Gefco's products was also hit by the shortage of foreign exchange in some developing countries which are the most important growth areas for the group's types of asbestos

Gefco's earnings rose to R21,706 million (60c a share) in 1983 from R17,532 million (49c a share) in 1982 and the group increased its dividends to 25c a share from 17,5c, largely because capital expenditure was cut back during 1983

Mr Jooste says a recent, positive development concerning asbestos was the adoption of a code of safety on the use of asbestos by the International Labour Organisation in Geneva

He says this and the upswing in some overseas economies point to a modest improvement in demand for asbestos during 1984 — DDC



ABC

RSM 3/4/84 (217)

# Australian threat to SA iron ore trade

By MARSHALL WILSON  
MELBOURNE. — A Perth-based mining entrepreneur, Mr Lang Hancock, has been given the go-ahead to develop a R600-million iron ore project in Western Australia which could significantly affect South Africa's long-term market potential.

After lobbying the idea for 20 years, Mr Hancock said this week he had been given the nod by Labour Party state premier, Mr Brian Burke.

"If nothing goes wrong the first ore will be shipped out in three years," said the hoary 74-year-old magnate who is one of Australia's most eccentric millionaires.

Mr Hancock will undertake a five-week trip starting on May 2 which will put him in touch with steel producers in Europe and the Middle

East which are considered Australia's "traditional" trading partners. But Mr Hancock is refusing to say exactly to whom he will be speaking while away.

The Middle East will be his first port of call "because I have letters of intent there", and Italy his second, with the emphasis after that of endeavouring to open up new markets.

One key to the Hancock success plan is the proposed new deep-water port to be built at a place called Ronsard, about 80km south-west

of the remote Pilbara mining community of Port Hedland.

Mr Hancock already owns the iron ore mine at Mulga Downs, now being extensively developed as a result of Mr Burke's go-ahead signal, and indications are that a railway will be built to transport the ore to Ronsard which will be able to handle giant container ships all year round.

"I have been promised contracts and the banks are lined up," said Mr Hancock yesterday. "They have been lined up for years."

"All I was waiting on was

the go-ahead from the state government Mr Burke has given me permission to negotiate with anyone I choose I can deal anywhere now."

The Ronsard harbour facilities about 1500km north of Perth will make it the largest deep-water port of its kind. It will mean iron ore can easily be shipped from Australia to Japan, Taiwan or in fact any of the potential buyers South Africa sells to.

And if Mr Hancock's guess is right, he'll be able to supply it cheaper than either South Africa or Brazil, which

already have large shares in the Japanese market, because of lower transport costs.

Mr Hancock says that apart from the Japanese, he would prefer to break away and sound out new clients.

"The Japanese say the maximum they can consume is 120 million tonnes a year," he said yesterday.

"The world consumes 1100 million tonnes a year. Between 120 million and 1100 million tonnes there is an enormous gap I am preparing to fill that gap."

# Western Area to lengthen shaft life

CAPE TOWN 5/4/80 (217)  
Own Correspondent

JOHANNESBURG. — Although Western Areas gold and uranium mine faces a difficult time in the short term, an application for dewatering a dolomitic area, if successful, could lengthen the life of the North Shaft by up to 10 years

This is disclosed by Mr George Nisbet, chairman, in his annual review in which he reports that uranium commitments require additional uranium oxide production of about 60 tons a year over the next three years from the mine

Discussing the application to dewater the dolomites overlying the northern part of the lease area, he says that if approval is granted, dewatering will be undertaken over the next three years but no benefits will accrue to the mine for about five years

If the dewatering application is successful, additional ore reserves should become available. The lengthening of the life of the North Shaft and mining of these reserves would provide extended employment opportunities and would reduce the ever-increasing cost of pumping

However, capital spending would be incurred should there be a need to buy the freehold of land affected by the dewatering

Discussing the mine's prospects, he says the company faces a difficult period ahead pending the

completion of the No 2 and No 3 subvertical shaft systems and the development of sufficient ore reserves, particularly on the VCR horizon, to provide the needed flexibility of operations

In the longer term these projects should result in an improvement in the tonnage and grade of ore available

During the 18 months to June 30 next year, the treatment of surface dump material will further reduce, in spite of the fact that viable accumulations at South Shaft will replace the depleted North Shaft dump

Additional tonnage is planned from underground sources so that the milling rate should not change significantly during this time

The filtration section of the North Shaft gold plant will shortly be replaced by the carbon-in-pulp plant, which is at present treating gold plant residues, without affecting general plant efficiency

This change should reduce treatment costs. Recovery grades during the next 18 months are expected to be maintained at the present level

During the next 18 months, the development rate will be maintained at the level achieved during the last quarter of 1983

Underground exploration west and north of the lease area will also be undertaken

● More reports, page 15



Cart Times 5/4/84 (217)

# Western Deep may convert plant for gold

Own Correspondent

JOHANNESBURG — Western Deep Levels gold mine is considering converting its uranium plant to a gold treatment plant, according to chairman Mr Peter Gush

In his annual review he says a proposal for

the conversion is to be put to the mine's board of directors in April

He says, "uranium remains a small contributor to profit, having earned R2,7m (R2,2m 1982) in the year

"Although the plant is highly efficient, the production of uranium is expensive, as only small amounts of uranium are present in the ore

"Studies indicate the conversion of the plant into a gold treatment facility would greatly increase the plant's contribution to profits

"Uranium-bearing gold plant residues could be reclaimed should conditions favour uranium production at some future date," Mr Gush says

He makes no comment on the estimated cost of the conversion or on how this proposed extra gold plant at Western Deep Levels would relate to the existing plant and the development of the No 1 shaft project where a new 160 000 tons a month gold plant is being built

The mine's uranium plant treated 1,88m tons of material in 1983 to produce 174 tons of uranium oxide

Western Deep Levels No 2 uranium plant came on stream in 1980 and the older No 1 uranium plant was shut down the next year

The No 2 uranium plant has a capacity of 200 000 tons a month which, with the use of radiometric sorting to upgrade feed material to the plant, is sufficient to treat the mine's full production from the uranium bearing Carbon-leader reef, rendering the No 1 plant redundant

If the No 2 uranium plant is converted to gold production it will be the second closing of a major uranium plant this year

### Closing plant

Harmony is closing its Merriespruit uranium

plant at the end of March

The moves reflect the poor state of the uranium market and predictions that no recovery can be expected until the end of the century

Forecasts of a slow but steady recovery in uranium spot prices towards the end of the decade have been shaken by the recent setback in the market which knocked prices back to \$17,5/lb from levels of more than \$20/lb

Looking at prospects for 1984 Mr Gush says a conservative view is being taken on the level of the mine's gold output

### 38 000 kg

Planned production for 1984 is 38 000 kg of gold from 3,5m tons milled at an average grade of 10,85 g/t

This compares with 1983's production of 39 455 kg of gold from 3,522m tons milled at an average grade of 11,2 g/t

The lower forecast is a result of the fire in the high-grade lower Carbon Leader longwalls at No 3 shaft which will be sealed until the end of this month

The mine will maintain production but with lower-grade material

"The speed with which full production can be resumed from these high-grade areas will depend on the extent of the damage to these longwalls," Mr Gush says

### R117m on shaft

Western Deeps' capital expenditure for 1984 is estimated at a record R191m of which R117m will be spent on the No 1 shaft complex

Mr Gush says the remaining debenture funds of R72,3m represent 88,5 percent of the estimated remaining after-tax costs to the start of production of the No 1 shaft

Capital expenditure for 1983 totalled R152m of which R83,5m was on the No.1 shaft

# Randfontein to treat higher grades

By ADAM PAYNE  
JOHANNESBURG —  
Randfontein gold and uranium mine, which is expanding from a treatment capacity of 400 000 tons a month to an eventual 550 000 tons a month, is likely to produce more gold this year than last because of an expected marginal increase in the recovery grade

This will occur as the treatment of surface material is phased out alongside an increase in the treatment of underground ore which has a higher grade than the dump material

Mr George Nisbet, chairman, in his annual review says that during the next 12 months the reduction in tonnage treated — because more ore will be treated and less dump material — together with additional costs associated with underground mining, will result in an increase in unit working costs

“However, any such increase will be offset

to some extent by the expansion of underground operations and further improvements in productivity”

He says uranium profits during the current year will be affected by a further reduction in the contractual price as well as by a reduced off-take by the consumer

Outlining the mine's expansion, Mr Nisbet says the present capacity to treat ore of 400 000 tons will increase by 50 000 tons a month with the commissioning of the Millsite plant extension at the end of 1984 and by a further 1000 000 tons a month to 550 000 tons at the end of 1985 on the completion of the Doornkop plant.

Capital spending last year amounted to R138m, an increase of 42,4% over the previous year

Present estimates are that apart from R157m to be spent on the Doornkop section, a further R72m will be needed for the Cooke and Randfontein sections, making a total capital expenditure of R229m for the period ending June 1985

With a view to the long-term future of the company, an agreement was entered into with Johnnies, whereby Randfontein participates in a joint exploration programme aimed at determining new areas of gold and/or uranium potential in the Transvaal and the Free State

The terms of a continuation of the joint venture are being negotiated

Initial drilling results on two farms in the Theunissen district in the Free State have been “distinctly encouraging” says Mr Nisbet.



# Uranium loss for St Helena

Own Correspondent

JOHANNESBURG — St Helena's net loss from uranium last year increased to R22,1m, compared with R0,6m in 1982

Disclosing this in his annual review, Mr Ted Pavitt, chairman, says the sharp increase was due mainly to the fact that, as a result of the lower-than-planned recovery grade, the mine had to buy uranium from other concerns at substantially higher prices than in 1982 to meet its contractual commitments

Mill throughout this year is expected to be maintained at the same level as last year. Due, however, to the continuing decline in yield, gold production will not be maintained at the 1983 level

Income before tax and State's share of income amounted to R110,8m last year compared with the previous year's R117,6m, while tax and the State's share of income totalled R55,7m against R6,7m in 1982

This resulted in income after tax of R55,1m which was 50% down on the figure for 1982

The steep rise in tax occurred because in 1982 no tax was payable when the company had an assessed loss, the result of buying the Beisa assets

This loss has now been absorbed and only current capital expenditure and operating losses in the Beisa division will in future affect the tax payable

This increase in tax last year was in turn offset by a decrease of R59,6m in capital ex-

penditure, leaving funds available for distribution at R55,3m compared with R55,5m in 1982

Gold working revenue increased by 9% to R125,2m mainly because of the increase in the gold price received from R13 269 to R15 255 a kg

A lower gold production was largely compensated for by an increase in production from the Beisa division. However, there was a net decrease of 43kg in gold produced

Discussing the effect of the operations of the subsidiary mine — Beisa — on St Helena's finances, Mr Pavitt says that St Helena's shareholders, although not yet deriving any benefit from the inclusion of the Beisa division, are in no worse position than would have been the case had the agreement with Beisa not been entered into

At Beisa the performance of both the mining and metallurgical sections continued to improve throughout the year and 1 060 000 tons were milled compared with 611 000 tons in 1982

**GROOTVLEI:** This mine, for which analysts had predicted a possible extension of life on the Black Reef horizon, is not likely to get such a life boost from that reef

Mr C Netscher, chairman, says development on this reef at No 8 Shaft indicates that there will not be any material extension to the ore reserves from this source

Working costs on the

mine increased by 18% last year to R37,73 a ton. If the effect of stockpiling of ore is taken into account the increase in costs was 14%

Mr Netscher says that the substantially higher unit costs are exerting an increasing constraint on the tonnage that can be profitably mined

**STILFONTEIN:** The decline in gold values — from a yield of 7,5g/t in the first quarter last year to 6,4g/t in the last quarter — could continue this year, says Mr J C Fritz, the chairman, in his annual review

Mr Fritz reports "Overall development results indicate that the decline in gold values could continue for the current year, while development in certain areas on the Ventersdorp Contact Reef continues to add limited tonnages to the ore reserves"

He says that the higher gold price last year compared with 1982 resulted in an increase in working income of 15%, from R57,5m to R66,2m

Tribute payments at R6,1m were 35% down on the 1982 figure of R9,4m due to a lower production from the tribute areas coupled with a lower yield

Tax and State's share of income at R33,3m was 43% higher than in 1982 because of the higher income

This resulted in profit after tax of R40,8m compared with R38,4m in 1982

**MARIEVALE:** This old gold mine on the East Rand, which increased production last year, has a limited life

with a decrease of 30 000 in its ore reserves which at the year-end totalled 350 000 tons at a gold price of R16 336 a kg

Mr C Netscher, the chairman, says the mine's life is limited because of the depletion of the ore reserves

However, the future of the mine depends entirely on payable ore reserves being exposed in the No 3 Shaft area. These reserves are limited in extent.

Gold production rose by 110 kg last year to 1 225 kg. This, combined with a higher gold price, resulted in income before tax increasing by R2,4m to R5,4m

Because of the higher income, tax increased by 98% to R2,8m. This resulted in after-tax income of R2,6m compared with R1,6m in 1982

**WEST RAND CONS:** The continued stagnation of the gold price during the latter half of last year had serious consequences for the profitable operation of this mine, and is a cause for concern, says Mr Fritz, the chairman

In his previous review, he said that, despite the withdrawal of State aid indications were that the mine was likely to remain viable at a gold price of R16 000 a kg

In the event the average gold price received at R15 424 fell short of this target but in spite of this the mine had a satisfactory year

The financial result with after-tax income at R5,1m (R4,4m) was mainly attributable to the increase in the average gold price

# Nippon in move to curb reliance on SA

217 Stan 11/4/84

TOKYO — Japan's top steel-maker Nippon Steel has bought small shipments of charge grande ferrochrome from Brazil and India recently in a move to diversify its imports away from dependence on South Africa,

company sources say  
It bought 500 tons from Brazil and 600 tons from India  
Last year, Nippon Steel imported 24 000 tons from General Mining Union Corp and Middelburg Steel and Alloys, taking up

24 percent of its total purchases  
Sources said the company anticipated the ferrochrome supply market would remain tight this year and one reason for diversifying was to protect itself from price increases

1  
1  
2  
C



# RTZ's income from Rossing drops 55 pc

Argus Foreign Service

LONDON — Profits from the Rio Tinto-Zinc Corporation's Rossing Uranium subsidiary have dropped by 55 percent

This was disclosed at a Press conference here when RTZ issued its preliminary statement of results for 1983

Group profits rose significantly

Operating profit was up from R705-million in 1982 to R1 091-million in 1983, net profit up from R181-million to R302-million and earnings a share up from 67c to almost 104c

But income from Rossing dropped from R56,5-million to R25,5-million

#### 46,5 pc STAKE

RTZ has a 46,5 per cent stake in Rossing

Spokesmen for RTZ said the smaller contribution from Rossing was caused by lower uranium prices, reduced deliveries and the fact that the mine was obliged to pay taxes for the first time last year

Rossing Uranium was formed in 1970 and started producing in 1976

By 1978 it was contributing R3,5-million to the parent company's earnings

This increased to R22-million in 1979, R36,75-million in 1980, R37,45-million in 1981 and R56,5-million in 1982

Asbestos:  
CARE TIME 2/18/82  
No safe  
level (217)

Staff Reporter

NO SAFE level of exposure to asbestos fibres had been discovered, Professor Hans Weill of the School of Medicine at Tulane University in the United States said yesterday

He delivered a paper on "Natural and Man-Made Mineral Fibres" at the International Symposium on Environmental Pollution and Man at a Sea Point hotel.

Because scientists had been unable to show that any level of exposure was safe, "it is assumed there is no threshold", he said.

However, certain risks were regarded as reasonable or acceptable

Over the years, public authorities all over the world had been tightening control over the asbestos industry by introducing more stringent measures

In South Africa, the acceptable level had also declined, but at 2,0 fibres a millilitre it was far higher than the acceptable US level



# Some mining shares lose attraction

ARGUS 2/5/84

252  
257  
217

By DEREK TOMMEY, Financial Editor

TWO news items today show that some mining shares are no longer the attractive investments they were thought to be.

The Liberty Life group has announced that it is selling its stake in Clydesdale Collieries to Gold Fields of South Africa, and Gencor has announced that it is shutting down its Beisa gold and uranium mine in the Free State

Liberty Life's sales of its controlling interest in Clydesdale to Gold Fields seems a sensible move for both parties

It is seen as a sound protective move by Liberty Life. Selling its major stake in Clydesdale will stop the value of its investments being dragged down if the coal market should weaken and coal share prices drop

With export coal prices falling, there seems a strong possibility of this happening

It also a good acquisition for Gold Fields. This group has only a small stake in coal and gaining control of Clydesdale will rectify that shortcoming

#### R146-MILLION

Gold Fields is paying just over R146-million for control of Clydesdale by offering 50 preference shares at a price of R29 a share for every 100 Clydesdale ordinary shares

This values Clydesdale shares at R14,50 each.

The preference shares carry a dividend of R2,90 a year and will be automatically converted into Gold Fields shares when Gold Fields' dividend reaches this amount.

#### URANIUM WEAK

The closure of Beisa should not be a surprise. The mine is predominantly a uranium producer with gold produced as a by-product.

The uranium market is known to have been weak for some time, and in the first nine months of last year the mine had an operating loss of almost R5-million.

As the mine is not eligible for state assistance, and with production costs rising, Gencor's decision to cut its losses and close down Beisa seems the right decision.

The move should help ease slightly the shortage of skilled labour in the industry and, in depriving suppliers of a customer, may perhaps help stabilise mining costs

Beisa, a subsidiary of St Helena, was financed mainly out of St Helena's tax savings, so its closure will not greatly affect shareholders

The real loser would seem to be the Government, which through tax concessions put up the finance for Beisa and will not get any return on these concessions.

## BUSINESS

# Gencor to close uranium mine <sup>2/5/84</sup> <sup>335</sup> <sup>217</sup> star

### Financial Staff

Gencor is to close its Beisa uranium mine before the end of this year as a result of the worldwide slump in demand and price for the metal

Gencor chairman Mr Ted Pavitt said this decision was necessary because the uranium market showed no sign of recovering in the foreseeable future.

It had been compounded by the stagnant gold price, produced as a by-product at Beisa.

The directors said that, after careful consideration, they had concluded there was no prospect that Beisa would be able to operate profitably under these circumstances.

Gencor's St Helena acquired Beisa's mining rights and certain assets from January 1 1981 from Beisa Mines Limited, a subsidiary of Gencor.

In terms of an agreement, St Helena operated the mine in return for a share of its distributable profits

The uranium market was already weakening in 1981 and contract prices for future deliveries were negotiated downwards at the time.

The lower contract prices still left Beisa viable

Since then the price of uranium under long-term contracts had continued to weaken, and consumers had again requested a renegotiation

Although the contract price which had now been agreed was not significantly different from that negotiated in 1981, Beisa

has had to contend with three years of cost increases with no upward movement in the new contract price

Mr Pavitt said that the closure of Beisa would not affect the operations or distributable earnings of St Helena. But shareholders would not in the medium term share in any potential income from Beisa.

If the circumstances which had necessitated the closure changed materially, consideration would be given to resuming operation at the mine

In a statement made at the same time as the Beisa announcement, Gencor has said that an arrangement has been made with Nuclear Fuels Corporation

### INVESTMENT AMORTISED

Under the agreement Nuclear Fuels has agreed in principle to accept assignment of all obligations under the 1978 uranium supply agreement.

Proceeds from the sale of mining assets, including housing, are expected to cover the major portion of the remaining liabilities relating to Beisa.

The closure would not have a significant effect on Gencor shareholders, Mr Pavitt said, as the investment had been amortised substantially in line with the weaker uranium market

It should be possible to place Beisa mine employees elsewhere within the Gencor group. Beisa mine now employs about 5 000.

201 3/7/84 (217) (217) (217)

# Chrome workers in recognition dispute

**Mall Reporter**

ABOUT 500 workers at the Montrose chrome mine in the North Eastern Transvaal went on strike late last week demanding recognition for the Black Allied Mining and Construction Workers' Union (Bamcwu).

A spokesman for the union said the company had agreed to open negotiations on recognition and wage increments with the union.

He added that police had

been called to the mine during the strike — which lasted for a day — and that one worker had been charged under the Intimidation Act.

A spokesman for the mine, which is owned by Gencor, said yesterday that they would only recognise Bamcwu once they had proof that the union had majority representation.

He said the National Union of Mineworkers (NUM) also had representation at the mine.



# 500 miners decide to go back . . .

ABOUT 500 workers at the Montrose chrome mine have agreed to return to work after management had decided to hold talks on recognition with the Black Allied Mining and Construction Workers' Union.

The workers went on strike last week demanding that management should recognise the union and wage increases.

A spokesman for the union told The SOWETAN that management had agreed to negotiate with the union. It was on this proviso that the workers went back to their jobs.

He added that police had been summoned to the scene and one union organiser had been charged under the Intimidation Act. The man is expected to appear in court today.

"Once the mine management has recognised the union, we shall represent our members on various issues, especially on wages," the union spokesman said.

A company spokesman said that they were prepared to recognise the union once they had proof that it had majority representation. The National Union of Mineworkers also has representation at the mine.

Sowetan 4/7/84 ~~27~~ 27 ~~27~~ ~~27~~

# Country has enough bauxite for 70 years

Slaw  
217  
9/7/84

By Russell Gault

Bauxite — one of the last two minerals needed to make South Africa strategically independent — has been found to be available in potentially payable deposits

The mineral, which is the raw material that becomes aluminium, has always had to be imported

But now, long-term studies by the Department of Mineral and Energy Affairs, show that deposits, first found some years ago, are in sufficient quantity to be recoverable.

Oil remains the only significant mineral yet to be found in quantities sufficient to make the country independent of overseas suppliers.

The gas finds off Mosel Bay this year will take the country part of the way down this road but substantial finds still need to be made.

It is estimated that bauxite deposits in northern Natal and the Mooi River-Underberg regions total 150 million tons — enough to last up to 70 years

But the reserves are unlikely to be exploited while the world glut of aluminium remains. That could be for years to come

It is the strategic value of the reserves which make them so important

With threats of trade boycotts South Africa's independence in minerals has been considered a paramount objective

The latest annual report of the department says that the relatively low quality of the bauxite ore can be raised considerably by simple processes

The assistant director of the department's geology survey, Dr J Bre-



dell, said a major expense in developing the reserves would be the construction of a plant to turn the bauxite into alumina

The alumina could then be converted into aluminium at a smelter which was already available at Richards Bay.

"At this stage we can best use the cheap aluminium being produced overseas and consider our own reserves to be a potential strategic resource.

"Latest indications are that our bauxite compares favourably with the ore mined in Western Australia. It is encouraging for the country to know it has this mineral. Even if it isn't in vast quantities, it is exploitable"

Spokesmen for the California-based mineral consultants, Nuexco, and Diemont Alusaf at Richards Bay felt an alumina plant would cost up to R500 million and be a difficult proposition for the country unless it could create overseas markets.

They were sceptical of trade boycotts in the future in spite of obvious concern by the Government in years past.

# Striking miners get ultimatum

MORE than 1 700 striking black miners at Penge Asbestos mine in the Northern Transvaal were yesterday given an ultimatum to return to work or face dismissal.

Mr Phandelam Nefolovhodwe, the general secretary of the Black Allied Mining and Construction Workers' Union representing the workers said that the

workers went on strike in protest over pay rises

Meanwhile the threat for a legal strike by over 70 000 miners still looms in the mine industry as a result of a wage dispute between the National Union of Mineworkers (Num) and the Chamber of Mines.

The Minister of Manpower, Mr P T C du Plessis, has until the end of the month to appoint

By JOSHUA RABOROKO

conciliation boards in the dispute

If the boards fail to resolve the disputes—covering the union's members on both gold and coal mines—the way will be open for legal strikes.

However several strikes over wages have

occurred in the mines in the past weeks resulting in the shooting of miners.

Mr Nefolovhodwe said that the union's representatives have asked to address the miners on the issue, but management has refused them permission to do so

"Our members have since been given an ultimatum to return to work by 7 am today or face dismissal. We are trying hard to persuade management to listen to workers' demands."

## Wages

He accused management of acting harshly on the union following the withdrawal of their right to recruit and rep-

resent the miners at the plant

A company spokesman confirmed the strike, but declined to comment further.

Meanwhile about 900 workers in the Alfa Romeo plant in Brits downed tools in demand for better wages yesterday. The workers demand a 50 cents a hour across the board and negotiations of working

conditions, including overtime payments, long service bonus, attendance allowance and holiday pay

A spokesman for National Automobile and Allied Workers' Union representing the workers said management has refused to have discussions with the union. Management was not available for comment.



## LABOUR NEW

1700

# Lebowa asbestos workers sacked

By PHILLIP VAN NIEKERK

ABOUT 1700 mineworkers at the Penge asbestos mine in Lebowa have been dismissed after failing to meet deadlines to return to work.

However, Mr Pat Hart, the managing director of Gefco, owners of the mine, said yesterday that they had not yet started recruiting new workers.

The workers went on strike late last week in protest against this year's pay increases which range from 12 to 13%.

This is slightly lower than the annual increase for coal and gold mineworkers, announced by the Chamber of Mines.

These increases have been rejected by the National Union of Mineworkers which is in dispute with the chamber.

A spokesman for the Black Allied Mining and Construction Workers' Union (Bamcwu) said yesterday he was not aware that all the workers had been fired.

The union has claimed the workers were also striking over a demand that the union be recognised.

● Almost 900 motor workers at the Alfa Romeo assembly plant, Brits Engineering, at Brits continued their strike yesterday in support of higher wages.

A spokesman for the National Automobile and Allied Workers' Union (Naawu) said there was no production at the plant yesterday.

The managing director of Alfa Romeo SA, Mr N Bianco, has denied there had been any stoppage.

Workers downed tools on Monday after wage talks between Naawu and Alfa Romeo became deadlocked last week.

Naawu is demanding a 50c an hour across-the-board increase and the company is offering 11c across-the-board.

Negotiations between union officials and management continued on Monday and yesterday.

Save for 215 (217)

## Union in battle to resolve dispute

THE Black Allied Mining Construction Workers' Union was yesterday still battling to negotiate with Penge Asbestos Mine management concerning striking workers.

The union's general secretary, Mr Phandelani Nefolovhodwe, said that since the strike started they have tried to meet management to resolve the matter, but in vain.

The workers went out on strike in protest against wage increases announced by the Chamber of Mines and over the recognition of their trade union.

Management has given workers an ultimatum to return to work or face dismissal, but by late last night no workers had been dismissed, according to Mr Nefolovhodwe.

### Committee

A management spokesman said that they had been holding negotiations with the workers' committee. The strike was over wages, but not related to those offered by the Chamber.

Meanwhile Alfa Romeo management, where about 900 workers have been on strike since Monday, has announced that they were trying to finalise the wage issue with the workers.

The National Automobile and Allied Workers' Union representing the workers has announced that the workers went on strike over pay and that the management refused to hold discussions with union representatives.

### SOWETAN REPORTERS

**MORE than 1 700 black mineworkers at Penge Asbestos Mine in the Eastern Transvaal yesterday defied their management's order to leave the mine grounds and remained in their dormitories.**

The situation remained peaceful but tense at the mine following the dismissal of the miners.

Trade unionists and management have appealed for calm at the mines following rumours that workers were forcefully moved from the premises and put into vans.

The general secretary of the Black Allied Mining and Construction Workers' Union (Bamcwu), Mr Phandelani Nefolohodwe, warned management to keep police away from the scene as their continued presence could spark off violence.

However Mr Part Hart, the managing director of Gefco, owners of the mine, said that management had specific instructions not to allow police to enter the mines' grounds.

Meanwhile a delegation of Bamcwu is to meet management today in an attempt to negotiate the withdrawal of their right to recruit miners, according to Mr Nefolohodwe yesterday.

"We also intend seeking legal advice to fight for the reinstatement of our members."

Mr Hart said management would meet the union representatives only on the restructuring rights and not the dismissal of the workers.

The miners were given an ultimatum to return to work by Tuesday morning or face immediate dismissal.

Yesterday, workers were still conferring in their dormitories and the meeting was characterised by chanting and speeches pledging solidarity. Plainclothes police with dogs were outside.

Production had ground to a halt. Only workers employed in the mine canteens, hospital and water pump station were allowed to report for duty by the strikers since the strike began last Wednesday.

# MINERS

# STAY

**Strikers at Penge defy management**

# PUT

Yesterday, their spokesman, who did not want to be identified, pointed out that the workers would not be "intimidated and frightened" back to work. **Advice** Only two things could make them return to work. Management acceding to their demands; Or advice from the Black Allied Mining and Construction Workers' Union (Bamcwu) executive in Johannesburg to return to work. The miners are demanding a minimum across-the-board wage increase of R10 per shift for all employees. The miners, most of whom come from villages in Lebowa and Gankulu, refused to collect their severance pay from mine officials who came to the hostel carrying trunks containing money. The workers emphasised that they were not seeking violent confrontation. This is the fourth strike to hit the mine since 1981.



ROM 12/7/84 217/117

# Fired Penge workers given hostel deadline

By PHILLIP VAN NIEKERK

ABOUT a third of the 1 700 sacked Penge asbestos mineworkers were still at their hostels yesterday and had been given until the weekend to leave, Mr Pat Hart, the managing director of Gefco, owners of the Lebowa-based mine, said yesterday.

The workers were fired this week after failing to meet management deadlines to return to work after going on strike in protest against the company's annual wage increases.

A spokesman for the Black Allied Mining and Construction Workers' Union (BAMCWU) said yesterday that they had briefed their lawyers and were considering legal action against the company over their dismissals.

Mr Hart denied reports that police were called in against the strikers, though he said he had contacted the South African Security Police and the Lebowa authorities to inform them of the strike "as a matter of routine".

He said the police who stood guard around the compound during the strike were the usual mine police and that they had not requested other police.

Mr Hart said he had refused to speak to

BAMCWU because they were not recognised at the mine, though he conceded that during the strike the workers had requested he speak to the head office of the union.

The BAMCWU spokesman said the workers were holding a mass meeting with union officials last night where they would plan a course of action against the company.

He said according to his information all the workers — who were paid "poverty" wages of about R150 a month — were still at their hostel.

● The National Automobile and Allied Workers' Union (Naawu) and Alfa Romeo appeared close to resolving their pay dispute yesterday which has prevented any production at their Brits plant for three days.

Mr N Bianco, managing director of Alfa Romeo South Africa, said the union was taking an improved company offer back to their members and he would know by today whether this had been accepted or not.

Workers downed tools on Monday in protest against the company's offer of 11c an hour across the board, but Mr Bianco said yesterday this had been improved to 16c an hour.

# Miners plan court action

THE Black Allied Mining and Construction Workers' Union is to bring an urgent application in the Supreme Court to compel the Prage Asbestos Mine management to allow them to address and represent dismissed workers.

More than 1 700 black miners have continuously refused to leave the company's grounds and maintained that they wanted their representatives to talk to them, according to the general secretary of the union, Mr P Nefolovhodwe yesterday.

Mr Nefolovhodwe told The SOWETAN that the management has promised to review their recruiting rights shortly because they contended that "we did not have members at this stage" — their entire membership ceased with the dismissal of the strikers.

But, he added, the union was proceeding with the legal action because "we feel our members were dismissed without our knowledge and without representation."

The management has refused to discuss the question of dismissed workers with the union on grounds that they went on an "illegal strike". They were demanding a pay increase and the recognition of the BAMCWU.

The management does not have any recognition agreement with the union and "we may discuss that as soon as they have proof of their membership."

DOM 13/2/81 27

## Strikers refuse to leave

Mail Reporter

A LARGE number of sacked workers at the Penge asbestos mine were still refusing to leave their hostels at the mine, in Lebowa in North-Eastern Transvaal, yesterday.

A spokesman for the Black Allied Mining and Construction Workers' Union (Bamcwu) gave that information yesterday.

The company has said "less than a third" of the workforce of more than 1 600, who were sacked this week for striking to support demands for higher annual wage increases, were still at the hostels and had until the weekend to get out.

However, the union claimed yesterday that virtually the entire workforce was still at the mine, refusing to move.

The union spokesman said they had met company representatives yesterday but had not been allowed to discuss the issue of the strike.

The union, meanwhile, has threatened the company with legal action as a result of the mass dismissals.



Union says angry mood prevails as 1 600 sacked miners are told to leave

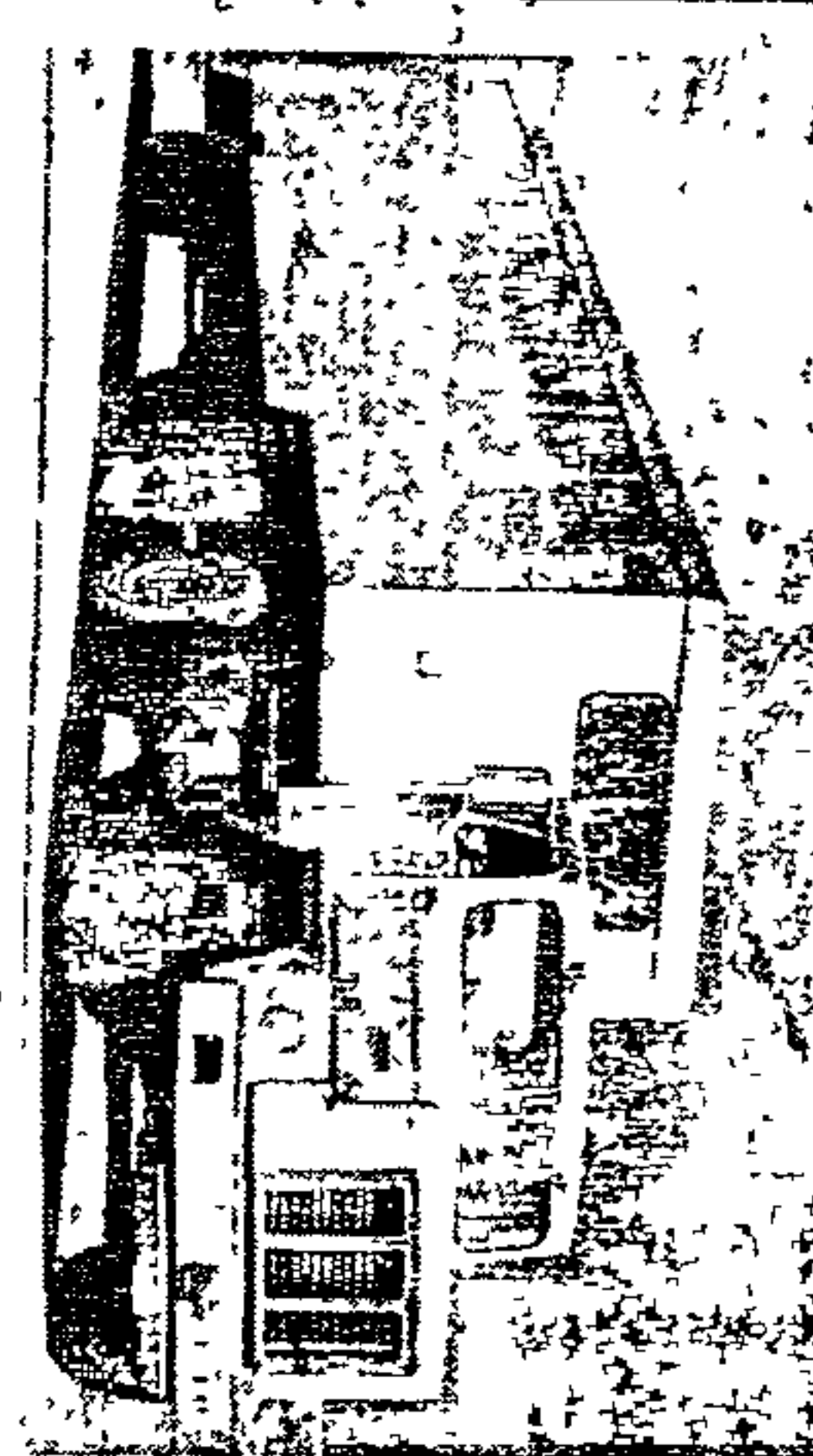

● A truck packed with new recruits makes its way down to the Penge asbestos mine (centre) where 1 800 workers were fired. Mr Hennle Neuwehof (right) is the mine administration manager

# Recruits move into Penge

## 'No food, no hostel but we will not go'

MR MBOLELO Nkosi, not his real name, has worked at the Penge asbestos mine for 24 years. This week he and hundreds of fellow workers lost their jobs.

Until last week Mr Nkosi was earning R10,97 a day — about R200 a month. He supports his wife and four children who live in the Transkei.

"Now I have to tell my wife that the children must leave school," the 45-year-old miner said in a roadside interview this week.

"This is a painful time. We have no food, no hostel, nothing. Now they tell us we must pack and go. They

think if we have no food then we will go home. But we will not go."

Mr Nkosi did not want to give his real name — he hopes he will get his job back.

Since 1960 — when he was paid 31c a day — he has worked in the asbestos mine. Every year he had about 14 days' leave. And every day he started work at 5.30am.

And now there is no work. "I don't know what I can do — there is no work in this place," he said.

"We just wait to hear from our union what is going to happen."

The mine had cut off their food rations since Thursday. But the Lebowa Minister of the Interior, Mr Kgosi Marishana, said yesterday he would advise that the workers remain in the compound and "work it out with the management".

The workers are being fed by union officials.

According to officials of the Black Allied Metal and Construction Workers Union (BAMCWU), about 50 new recruits were brought in from surrounding areas on Thursday.

Union officials said they did not report for work after being told of the dismissals.

However, Mr Pat Hart, managing director of Gefco, owners of the mine, said: "No problems have been reported with the new recruits. So far we've brought in about 200 from the Lebowa area.

"As far as we're concerned the other miners no longer work for us and there will be no further negotiations on this issue."

As sacked workers sat tight yesterday, the general secretary for BAMCWU, Mr Pandelani Nefolovhodwe, described the situation as potentially explosive. "Management has created a situation which may become uncontrollable.

### Angry

"The atmosphere is extremely tense and the workers are very angry," he said.

Staff at the local hotel, about 50 km away, said a group of white miners' wives from Penge fled to the hotel on Wednesday night, fearing a "blow-up" at the mine.

And villagers in the nearby town of Burgersfort, said managements from surrounding mines were "waiting for reaction from their own workers".

The miners downed tools last week over the annual wage increases of between 12% and 13% which workers felt did not improve their "poverty wages" of around R150 a month.

Mr Hart said. "We felt the increase was reasonable and it was the best we could do. Workers rejected it outright and were then given a deadline to return to work.

"When they failed to do so

they were dismissed (on Monday) and told to vacate their hostels.

"Good communication channels have always existed between management and workers' committees," said Mr Hart.

BAMCWU claimed the workers' committees, which are appointed by management, were not recognised by the workers.

"Management continually refused to discuss issues with us," said Mr Nefolovhodwe.

"The wage increases were completely unacceptable to the workers — some are getting less than R100 and they have to keep families.

"They cannot cope now with the increased GST and inflation."

### Management

BAMCWU officials said almost the entire workforce was still in the hostel. Gefco management said only about a third were left.

Gefco does not recognise BAMCWU, but, in accordance with their access agreement, union officials have been allowed to recruit at the mine.

Said Mr Hart. "Until they can prove membership we

cannot take it any further. They have never proved their membership — the ball's in their court all the way"

BAMCWU claims to have at least 90% representation in the mine, but officials said they were recently denied access to their members. Mr Hart said that union officials were only refused access for about "half a day"

Mr Hart denied any meeting between legal representatives from Gefco and BAMCWU had taken place — although the meeting was reported in the Press yesterday.

HUNDREDS of new recruits were trucked into the Penge asbestos mine this week after the management fired about 1 600 workers for failing to end their strike.

Sacked workers who have refused to leave the mine were given until today to vacate the mine hostels

BY SARAH CROWE

### Dismissals

He would not discuss the effects of the strike and dismissals had had on production.

Reports that police had been guarding the hostels, were also denied by Mr Hart.

When told Lebowa police vans had been seen driving in and out of the Penge border posts, he said management had not called them.

Comments among villagers ranged from a criticism of management's "harsh measures" to saying that the workers "didn't appreciate what they had".

People in Burgersfort also believed that one of the workers' demands leading to the strike was that they wanted the mine manager, Mr A Fouché, removed. He was accused of not communicating with the workers, but Mr

HART said he believed the strike was only over wage increases.

Mr Fouché said: "We have a beautiful place here — full time we have a holiday resort and part-time we have a mine."

"We hope the situation will return to normal as soon as possible."

Mr Fouché would not discuss allegations that the workers wanted him out, but said he was "too young to retire".



# defiant rol levy



father of horse dressage in South Africa, said farewell to the Johannesburg yesterday.

Picture: ROBERT TSHABALALA

## champ bids farewell

outside  
manch  
sta-  
a last  
public  
ounds  
ig on  
first  
the  
Sun-

Born in Poland, it was only when he saw the grace and beauty of dressage riding in Germany after the Second World War that he really became interested in the sport.

"I was hooked. When I got to South Africa, I started building up the team and started riding Lipizzaner horses myself," he said.

Maj Iwanowski won the South African dressage cham-

ionships six times

Although he feels sad about leaving, he believes he is a "nomad" and that his work in South Africa has been completed.

"I'm looking for a new country, new people and perhaps even new horses," Maj Iwanowski said in his charming Polish accent.

"At my age I'm still interested in schooling young horses and am enjoying every minute of it."

## e slates gression'

South Africa continues to support them with weapons and training with

## 18 killed in bomb attack

NEW DELHI — About 18 people died after Soviet warplanes and helicopter gunships dropped fragmentation bombs on the Afghan town of Istalef, a Western diplomat

## Asbestos disease hits hard

By PHILLIP VAN NIEKERK

IN a 10 month period to June this year, up to 134 workers at the Penge asbestos mine were paid workmen's compensation after being found to be suffering from asbestosis, a lung disease caused by asbestos dust.

And workers found to be suffering from the disease were regularly paid off by the mine, according to a medical consultant to Gencor and officials of the Black Allied Mining and Construction Workers Union (Bamcwu).

The mine — which employs about 1 700 black workers — has been in the news recently because of a strike over wages and the refusal of dismissed workers to leave the mine hostel.

Files at the magistrate's office in Praktiseer, near Penge in Lebowa, show that between August 3 last year and June 11 this year there were 134 workmen's compensation payouts for "occupational disease". The vast majority of these were for asbestosis, a scarring of the lung tissue.

A physician who acts as a consultant to Gencor told the Mail yesterday that the high incidence of lung disease at the mine was restricted to older, long-serving workers. He said stricter control in the industry in the past five years had made the risk of asbestosis damage remote.

See Page 11

By EMELIA JAROSCHEK  
Crime Reporter

POLICE have released the first sequence of photographs — taken by a secret surveillance camera — during a R10 600 bank holdup in Johannesburg this week.

These pictures may provide a vital clue to the identity of the robbers and detectives have made an urgent appeal to the public to be on

## Sol drops R3m casino claim

By GEOFFREY ALLEN

SOL Kerzner's Sun International group of gambling hotels has withdrawn its R3 400 000 civil action against former Sun City casino staff who allegedly stole the money over the tables.

The thieves admitted to having taken R133 752.

The Sun City "scam" came to light after an American had been mugged in Braamfontein, Johannesburg and his briefcase, which contained a diary listing the names of people working the fiddle and the various amounts they had taken, was stolen.

Mr Kerzner established a meeting with the mugger and paid thousands of rands for the list of names.

There has been an on-going dispute between Sun International and a consortium of insurance companies as to the exact amount the casino staff stole.

the lookout for, snapped by the

The series of "c era" shots were three robbers — up a cashier at Bank in Grant A wood on Tuesday

The three men masked and one balaclava, ordered Lanzi — in the three clients — to tic bag. They had filled it with

But the "secret surveillance" clicking away every move on

Late yesterday Murder and detectives released the pictures the

The young man tures is wanted to with their robbery tion.

He is about 32 has a light complexion, 1,65m tall. He was during the he had gold rimmed tinted white shirt and a suit.

Police said the ing the balaclava holdup was about and the third beard, had a dark ion and was dressed.

The robbers are to have escaped, yellowish/lime

A reward of been offered by " Bankers' Association information arrest and convicted robbers

Anyone who asked to contact police at 837-4114.

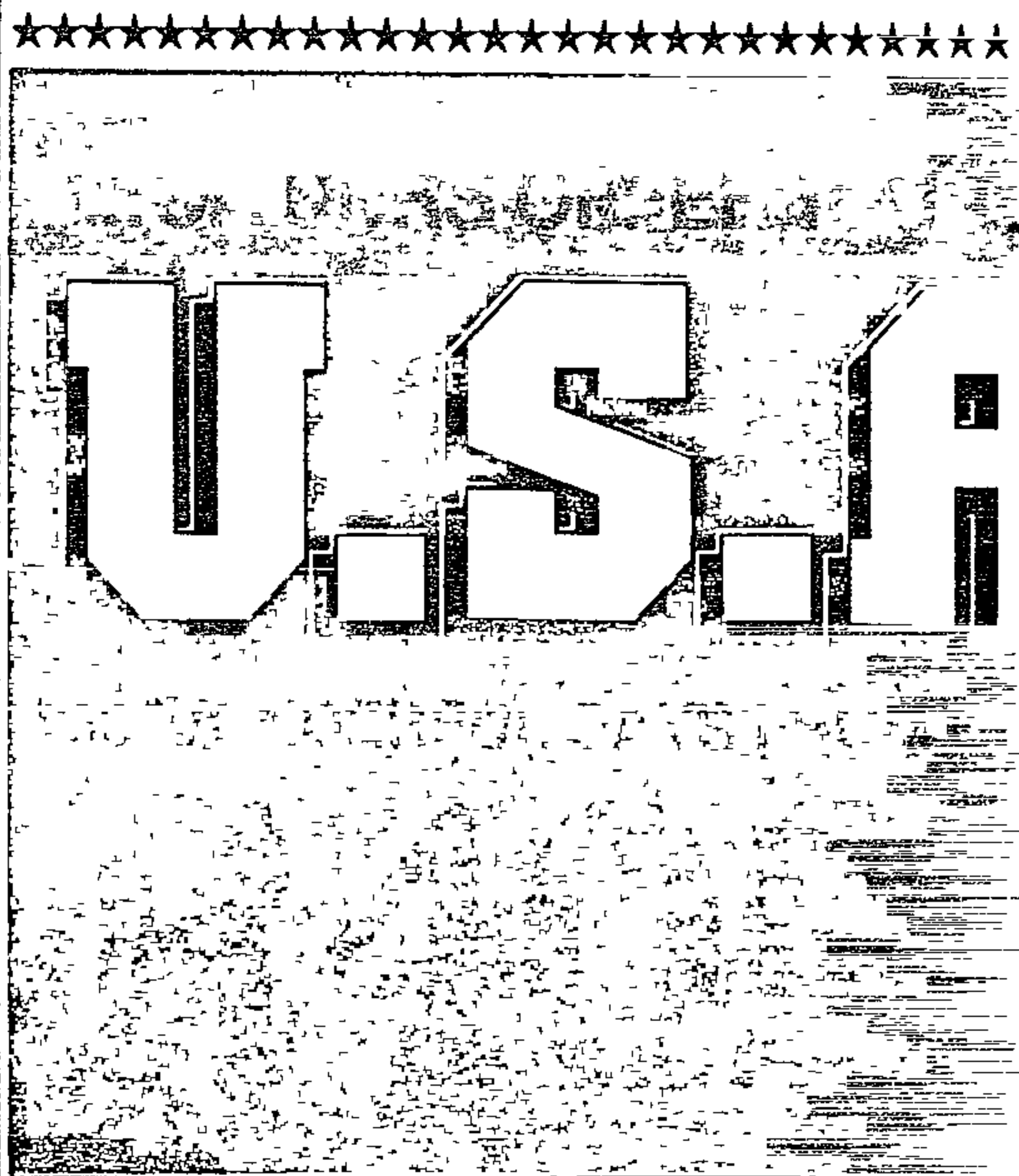

On the West Coast, this amazing tour visits



# We won't budge, say Penge's fired miners

EVERY evening more than 1 500 mineworkers from the Penge asbestos mine in Lebowa gather in a large circle in the centre of their hostel grounds.

For a few minutes they join together in songs which can be heard at the white miners' and manager's houses about a kilometre away, ending their service with a sermon and a prayer — that they will be listened to.

It has been more than a week since the workers were fired for striking over higher wages and a demand that the company negotiate wages with their union, the Black Allied Mining and Construction Workers' Union (BAMCWU).

In that week they have embarked on a form of passive resistance — they have refused to budge from their hostels or accept that they have been dismissed.

"We are refusing to leave because we never suggested to management that we were tired of working at Penge," workers said this week. "We never wanted to be dismissed."

Notices to the workers to leave and pleas to BAMCWU have so far failed and now the owners of the mine, Gefco, have applied for a court order to evict the workers from the hostel.

The case is to be heard in the Pretoria Supreme Court on Tuesday.

Ironically, while the workers — who face a bleak future of unemployment if they have to leave — are determined to remain at the mine, it could be in their best health interests to leave.

According to files at the magistrate's office at Praktiseer, 134 Penge workers (almost 10 % of the workforce) were paid out lump sums of workmen's compensation for "occupational disease" in the 10 months between August last year and June this year alone.

Almost all cases were of the disease asbestosis — scarring of the lung tissue caused by asbestos dust.

The district is dotted with thin, coughing men who were dismissed from the mine once they were found to have the disease.

In any crowd outside a trading store or the magistrate's offices there are usually two or three men with the disease.

To workers at the mine the three-monthly x-ray screenings of their lungs are feared — less because they could be found to have



An asbestosis victim — employed in a "soft" job at the mine.

## PHILLIP VAN NIEKERK

asbestosis, and more because it could mean the loss of their jobs.

Mr Klaas Mashabela was dismissed in May this year after working at Penge for 24 years. He received a workmen's compensation payout of R1 790 plus notice pay of R425. He gets no pension.

Some of the asbestosis-stricken workers are kept on at the mine by being moved from underground to "soft jobs". One of the striking workers, who worked underground for 16 years, now cleans the mine's swimming pool.

A physician who acts as adviser to Gencor said the disease mostly afflicted long-service mineworkers and that conditions in South African asbestos mines had improved tremendously over the past decade.

But while management attitudes towards the health of mineworkers may have improved over the past decade, workers do not believe that management's attitude to negotiating with them has changed.

The workers struck over the demand that the company pay an extra R10 a shift — in some cases a 200% increase over and above the annual pay increase brought in by the company in July.

"From the beginning the workers were prepared to go back, providing the company was prepared to commit itself to discussing the pay issue with the union," one worker said.

"We are trying to change the situation where we are faced with hunger and poverty because of the wages we are earning. We felt nothing would be done until the workers stood up and voiced their grievances."

However, the unilateral wage increases, the company method of communicating information through pamphlets and the sackings had convinced the workers that management was not really prepared to listen to them.

Approached for comment yesterday, a spokesman for the company said he was not prepared to say anything in view of the pending court action.

However, Mr Pat Hart, managing director of the company, said in an earlier interview that the reason the company was not prepared to negotiate wages with the union was because it had not yet been recognised.

This was because — while the company had granted BAMCWU access

to the mine some time ago to organise the workers — they had not yet proved they were representative.

Mr Hart described this year's wage increases — which are slightly lower than the Chamber of Mines' increases for gold and coal mineworkers — as "generous", particularly if one took into account the improved service increments.

In addition, he said, there had been repeated meetings with the works council and the company had gone out of its way to try and communicate with the workers before the dismissals.

What makes the Penge dismissals different from other mines is that it is in the middle of a "homeland."

The people at the hostel, who include some women, are free to come and go at the mine and are constantly moving backwards

and forwards to their villages.

Apart from supplies coming from the union and a shop opposite the hostel, the mineworkers are receiving their food and support in the villages.

Many of the workers are key people in the community, and have approached the Lebowa government to support them. They have also been in contact with chiefs in the surrounding area to prevent them from sending in new recruits.

Some chiefs approached by the mine to supply workers from their areas have co-operated and about 250 workers have been shipped in to do surface work to keep the mine operating.

They are being housed at an old hostel on the other side of the mine and there is little contact between them and the workers they have replaced.

But at least one chief, who asked not to be named, has refused. Explaining why, he said: "I told the mine we can't be expected to get people to work for you. These fired people are part of our community."

Union organisers say the company has warned them that if they can't get replacement labour in Lebowa, they will recruit via the Chamber of Mines' recruiting arm, Teba.

This would bring into Lebowa workers from other territories such as Transkei or Lesotho.

Meanwhile the situation at the hostel is calm though there is a constant presence of Lebowa police vans and mine security patrolling through the mine's grounds.

The workers — whose spirits appear remarkably high — say that after all this they are still committed to talking to the company.



# Portrait of a little boy who may be dicing with death

CHILDREN who play on the asbestos dumps in the Penge mining area are dicing with death, according to an occupational health specialist.

"In 30 years time some of those children will show signs of having contracted asbestos-related diseases," said the specialist.

He said cases of mesothelioma — cancer of the lining of the lung — had been found among people who had holidayed in the area of an asbestos mine in the north-western Cape.

"The only known cause of mesothelioma is

exposure to asbestos and it may only be for a few months. It takes about 25 to 30 years to surface and is therefore very difficult to trace the origins," he said. "It has a short contraction and a long 'lag' period."

"Even people living in the area of an asbestos mine are at risk of contracting the disease — depending on the dust factor," said the specialist.

There are three main asbestos mines in South Africa — Penge, in the north-eastern Transvaal, one in the Eastern Transvaal and another in the north-western Cape.



● Motheyelele Phogole on the asbestos dumps. In 30 years he may have a fatal lung disease.

# Probe into asbestosis at Penge

By SARAH CROWE

fused this week to comment on the issue of working conditions in the mines

The mine manager at Penge, Mr A Fouche, referred all questions put to him to the head office in Johannesburg

At head office, Mr Hart was said to be unavailable for comment.

The administration manager, Mr Vernon Carr, said management had been advised not to comment.

A spokesman for the company's lawyers said. "We cannot comment at this stage about anything relating to the case — which may include working conditions.

"We don't know how the other side is going to play it."

A MEDICAL expert will visit the Penge asbestos mine this week to investigate more than 100 suspected cases of lung disease

The Black Allied Mining and Contract Workers' Union (BAMCWU) intends to submit the results of the medical screenings to the Medical and Dental Council should that become necessary.

The union's legal advisers will also investigate this week the possibility of taking legal action against Gefco, the owners of Penge mine, over compensation paid to the black miners

Under the Occupational Diseases in Mines and Works Act, white mineworkers get R18 000 if an "occupational disease" is contracted and R26 000 if they can prove disability.

Black workers receive R1 490 if they contract asbestosis and R1 790 if tuberculosis and asbestosis are contracted.

"Cases of asbestosis are too frequent at the mine," said the general secretary of the union, Mr Pandelani Nefolovhodwe. "We have given case histories to medical specialists and they are compiling a dossier."

The Lebowa-based Penge mine has not disputed information that emerged this week that 134 workers — almost 10% of the work force — were "paid out" over a period of 10 months after having contracted asbestosis

The issue of mine conditions and compensation emerged after workers downed tools two weeks ago because of dissatisfaction with an offered salary increase of between 11% and 13%.

When they refused to meet management deadlines to return to work they were sacked.

Last week hundreds of new recruits were trucked into the mine to keep it running

The managing director of Gefco, Mr Pat Hart, said at that time he believed the offered salary increase of 11% to 13% was "generous"

The profits before tax for Gefco for 1983 were R24-million — more than double the pre-tax profits of 1981

This week management applied for a court order to have the workers evicted from the premises and the hearing continues in the Pretoria Supreme Court on Tuesday.

About 1 600 workers are still on mine property

Gefco management re-

RDM 23/7/84

□□□

134 370 217

PERHAPS the most important development in the continuing dispute at Gencor's Penge mine is the revelation that 134 workers received Government compensation over the past 10 months after contracting asbestosis

Admittedly, Penge employs about 1 700 workers, but a nearly 10% incidence of a debilitating disease over 10 months is pretty high.

Gencor notes that asbestosis takes years to manifest itself and says the victims are all long-serving workers. Tougher controls in the mine over the past few years mean the incidence of asbestosis will drop, it adds

But there is no way of verifying this — new workers would not exhibit asbestosis symptoms yet and continuing questions are likely to be asked about the safety of asbestos.

□□□



# Union to sound health alarm

By Carolyn Dempster,  
Labour Reporter

The Black Allied Mining and Construction Workers' Union will launch a health awareness campaign among asbestos mineworkers and in rural communities used as a source of labour for asbestos mines.

The announcement follows last week's disclosures that 134 mineworkers at Penge asbestos mine in the Eastern Transvaal have been laid off and compensated for the lung disease asbestosis during the past 10 months.

"As far as we are concerned, people recruited in the rural areas to work in these mines do not know of the enormous

hazards they are being exposed to," explained Mr P Nefolovhodwe, president of Bamcwu.

"Our intention is to go all out, distributing pamphlets if necessary, to alert these communities to the dangers of working with asbestos. We owe nothing to the mine managements, but we do owe something to the people who are dying because they were not told and not protected from exposure to the asbestos fibre."

"Mines and factories overseas have been

closed as a result of the anti-asbestos campaign," he said.

The union was also sending a team of medical doctors to the mine to investigate the extent of asbestosis and compile a dossier to be used as part of the campaign, he added.

Mr Nefolovhodwe said it was up to the mines to institute safety measures and provide workers with protective equipment.

Investigations by The Star revealed last week that women recruited at

Penge as supplementary labour were paid R2,50 a shift (up to 10 hours) and were taken on to sort waste material from the asbestos.

In interviews with the women it was found that they were not given any protective gear and, as their job involved handling raw asbestos on conveyor belts, they were constantly exposed to asbestos dust.

Medical examinations, in terms of regulations, are carried out on the mine every six months to check for signs of lung disease.

Although asbestosis is disabling it need not be fatal. But the mineworkers also run the risk of contracting mesothelioma, the fatal lung cancer caused by inhalation of asbestos fibres.

24/7/84 Skw  
217

# Court orders 1 300 Penge miners to be kicked out

By JOHN MOJAPelo  
Pretoria Bureau

MORE than 1 300 mine workers at the Penge asbestos mine, who have been on strike for higher wages, are to be ejected from the mine hostel by order of the Pretoria Supreme Court.

Mr Justice D J Curlewis yesterday refused an application by the striking miners to stay the execution of the ejection order.

Leave to appeal to the Appellate Division or a full bench of the Supreme Court was refused.

The Black Allied Mining and Construction Workers Union, the trade union involved in the dispute, has been ordered to pay the costs of the case.

Egnep Limited, the owners of the asbestos mine in the Praktiseer district in the North-Eastern Transvaal, brought an urgent application against 1 377 mine workers, the trade union and two workers, Mr Z Malatjie and Mr Nkosana Nzwane.

The miners went on strike on July 2. They were dismissed by the mine management for participating in an illegal strike on July 10.

The miners refused to vacate the Matshona Hostel on the mine premises.

The judge said the mine workers had been warned through notices that they were on an illegal strike and might be dismissed.

The mine management made an "overwhelming" case against the miners.

"There was no explanation nor justification for the workers to have refused to work," the judge said.

The judge dismissed the argument by miners' counsel that the dismissal notice was invalid because the miners were not medically examined in terms of the law before they were told to leave the mine premises.

Mr Isaac Maisels QC, who appeared for the mine management, said the case was a simple matter of workers withholding their labour without legal grounds from July 3, they were dismissed and were not entitled to remain on the mine premises.

Mr Maisels said there was no lock-out on the part of management.

The workers had not followed the correct procedure of submitting their case to a Conciliation Board before they acted.

"It is an unfortunate situation where the union did not do what any union would do, by applying for a Conciliation Board," said Mr Maisels.

The law in the country did not allow employers to force workers to work if the workers did not want to, Mr Maisels added.

Mr D A Bregman SC, for the miners, said the dismissal of the miners was invalid because the mine management had not complied with the occupational diseases in the Mines and Works Act by medically examining the miners before they were dismissed.

"They should have been X-rayed on the date of discharge or within 30 days

after," Mr Bregman said.

Mr L J Snyman, the manpower manager of the mine, said in papers before court that the strike by the miners was illegal.

The miners had demanded an increase of R10 across the board.

The miners were told that the mine management could not afford the wage demand because of the prevalent economic condition in the country and the surplus of asbestos, said Mr Snyman.

Mr Snyman told of several attempts by the management from July 2 to get the miners to go back to work.

The miners refused to work or to vacate the mine hostel they had occupied.

Mr Snyman said the management had started recruiting new labour and the hostel was needed for occupation by 400 new workers.

The strike has resulted in a financial loss to the mine.

"The workers are not working. They are indulging in what may popularly be called a sit-in strike and have no right whatsoever to be on the premises," Mr Snyman said.

Mr Nkosana Nzwane, an employee at the mine, denied that the miners had taken part in an unlawful strike.

The workers were not responsible for their dismissals.

The miners still regarded themselves as employees of the mining company.

Mr Nzwane said during negotiations the miners were told that if they continued with higher wages the company was going to retrench about 300 workers.



ADM 28/7/84 (217) ~~217~~ ~~119~~

# Mine's offer to workers

Mall Reporter

THE Penge mine — scene of a three-week-long strike by workers who refused to vacate their hostels after they were fired — will start re-employing workers on Monday, Mr Pat Hart, managing director of Gefco, said yesterday

More than 1 300 workers went on strike early this month in protest against their annual wage increases

Mr Hart said between 700 and 800 workers had indicated they wanted to be considered for re-employment

He said the workers had voluntarily left the hostel late this week following the court order

won by the company in the Pretoria Supreme Court on Wednesday requiring the workers to leave

"The workers lined up peacefully for their medical examinations and left voluntarily," Mr Hart said

A spokesman for the Black Allied Mining and Construction Workers' Union (Bamcwu) said the workers were still planning a mass meeting to decide whether to accept the jobs

The Bamcwu spokesman said they had heard from the company they were prepared to re-employ about 1 000, but many of the workers were demanding that all or none be re-employed

Sowetan 20/7/80 (217)

# Strikers to be replaced

THE management of Penge Asbestos Mine in the Eastern Transvaal will go ahead with recruiting new workers, despite the refusal by about 1 700 dismissed workers to re-apply for the jobs.

Mr Pat Hart, managing director of the mine, said they will start employing workers today because production had been affected by the work stoppage

The workers went on strike demanding a R10 working shift increase and the recognition of their union, the Black Allied Mining and Construction Workers' Union (Bamcwu).

They were subsequently dismissed and ordered to leave the company's premises, but they refused. Their refusal was followed by a Supreme Court order which compelled them to leave.



## Penge miners reject offer

THE TRADE union representing the black mineworkers fired from Penge Mine in the Eastern Transvaal says the workers were offered their jobs back — but at a lower rate of pay.

The 1 700 workers were dismissed by the mine three weeks ago after refusing to work at the new pay rates which came into effect on July 1 and which are based on the new rates being applied by members of the Chamber of Mines

Mr Pandelani Nefolohodwe, general secretary of the Black Mining and Construction Workers' Union (Bamcwu) in Johannesburg, said yesterday the "affected workers," numbering about 1 400, had rejected the mine's offer to re-employ them

"They were offered the rates which are offered to new recruits, which is less than what they had been getting before. They turned it down. Obviously the mine is not serious about its offer," he said

### **Benefits**

The remaining 300 or so workers, he said, had "never been dismissed" as they were not present at the mine at the time of the dispute and subsequent dismissal.

Mr Pat Hart, managing director of the Griqualand Exploration and Finance Company (Gefco), owners of the mine, confirmed that the dismissed miners had been offered re-employment at recruitment rates. This generally meant they would earn less than they did previously because their service benefits were lost. However they were being paid according to their work experience

Mr Hart, whose company has refused to negotiate with Bamcwu on the strike issue, said, "Several hundred" of the dismissed workers were signed on yesterday morning — Sapa

See for 3/7/80

~~217~~ ~~217~~ 217

# Sacked miners head home

AFTER more than three weeks of uncertainty, the 1 700 dismissed employees at Penge Asbestos Mine in the north-eastern Transvaal have accepted their fate and have left the mine grounds.

The Pretoria Supreme Court last week granted the mine an order permitting it to eject the miners from the compound in which they had been assembling since they went on strike on July 4

Last Friday the miners held a mass meeting at a small village of Bothashoek, where they decided to spurn management of-

By JOSHUA RABOROKO

fers of re-employment. They said management had said those willing to be re-instated should report at the mine yesterday.

They feel if they do not go back, the company will be forced to employ inexperienced recruits and in this way production will suffer

## Power

Freedom songs were chanted and black power signs displayed as the more than 1 400 sacked mineworkers present at the meeting

tried to keep their unity intact

All have collected their severance pays from the mine and most complained they had been given nine days' wages, which ranged between R30 and R60, and they had not been given their pension money or long service benefits

After the meeting, the Black Allied Mining and Construction Workers Union (Bamcwu) — which claimed to have commanded a membership of 90 percent in

the mine — organised buses to take the dismissed workers home, most of whom are from Lebowa and Gazankulu

Bamcwu's senior vice president, Mr Mbulelo Rakwena, urged the workers to take their UIF cards to their nearest Commissioner's office to qualify for unemployment benefits

Bamcwu is to engage union doctors to examine the dismissed workers and determine whether or not any of them contracted diseases related to the inhalation of asbestos or mine dust



# Lebowa children play happily on the dumps of death

217  
~~111~~

WHEN THE children of Mahlajeni run outside to play, they invariably head for the big dump. It's fun. You can build little houses with the sand. You can slide down it, racing your friends to the bottom. You can dig in it, and bury things, mould small animals with it if you mix in a bit of water.

You can also die because of it.

The dump is comprised of asbestos, and every time the children — or anyone — goes near it, they risk contracting asbestosis or mesothelioma (a cancer of the lung lining) and lung cancer.

Asbestos mining — which once brought prosperity to the remote North Eastern Transvaal — also brought with it a hazard which today still threatens the health of entire communities.

A Rand Daily Mail investigation this week revealed the presence of a number of dumps of abandoned mines — uncovered and full of deadly asbestos fibres — next to villages and schools in Lebowa.

This is in addition to the number of former asbestos mineworkers in the area who have contracted asbestosis as a result of working in the mines.

The people living next to the dumps are not aware of the health risks of asbestos.

Several doctors whom the Mail consulted about the situation said the people exposed to these dumps stood a high risk of contracting cancer — probably only 20 to 40 years from now.

Most of the abandoned



Asbestos fibres found caked in the ground, right, and a piece of asbestos from an old house. Both were found next to a school playground at Krom Elmboog.

Picture: DANIEL SIMON

## PHILLIP VAN NIEKERK

dumps are found in Lebowa, between Pietersburg and Burgersfort in the North Eastern Transvaal.

At one village, Mahlajeni, people have to climb over a path on the dump to get to their huts and children view the dump as a large sand-pit.

The surrounding veld is littered with abandoned dumps.

When the big dump close to the village, known as the Baboon Mine, closed recently, a lot of local people found themselves without jobs, adding to the severe poverty in the village.

One man, Mr Selathole Thobojane, a former Modderfontein migrant worker, has turned the asbestos waste into a business by mixing it with river water to make bricks for sale.

A few months ago he contracted a serious lung disease, his feet swelled up and he cannot move far from his hut.

There is another asbestos waste brickworks a few kilometres away at the village of Mafefa, where the local people are exposed to the dump and have no idea it is a health hazard.

Many people in these vil-

lages are now living in houses made with fibres of blue asbestos, or crocidolite, which is generally regarded as the most dangerous form of asbestos.

At Krom Elmboog the headmaster of the Lekubosha Community School has appealed for funds to move his school of 555 children away from the shadow of a giant dump of brown asbestos, or amosite, waste.

Krom Elmboog is close to the Penge mine and, like Penge, is owned by the Griqualand Exploration and Finance Company (Gefco).

The now-closed mine's worker compounds have been added to the school. The buildings are made of asbestos, loose fibres of

which are clearly visible on the walls.

The ground near the dump is caked with asbestos fibres.

The headmaster, Mr Caphas Mahlaba, said he was not aware the dump was a danger until early this year when tests were conducted on dust in the school playground.

"They installed a borehole, pipes and a hose and asked me to wet the playground every day. They told us it is very dangerous if we inhale the dust," he said.

"We're trying to get the children to sprinkle every morning but when it's hot the ground becomes dry again after a few minutes.

"Now the community





on an asbestos dump, unaware of the possible dangers to their lives.

Picture: PHILLIP VAN NIEKERK

feels we must move this school because its too dangerous."

Mr Pat Hart, the managing director of Gefco, pointed out that the area around the dump had been fenced off, that they kept normal checks on pollution in the area and the company was not aware of any abnormal asbestos fibre counts

He said they had provided the means for the people to keep the area damp.

However, none of the dumps visited by the Mail this week resembled the description of old asbestos dumps in the 1982 report of the Director-General of Mineral and Energy Affairs.

"Old tailing dumps are

covered with soil or broken rock to prevent the dispersion of dust into the atmosphere"

In the United States there are tight controls over environmental waste and toxic waste is fenced off and covered.

While people of Mahlanjani, Krom Elmboog and other villages risk contamination by asbestos in their environment, there are also many former mineworkers in the villages suffering — and often dying — from asbestos-related diseases

This was highlighted by facts which emerged during the recent strike at Penge.

According to figures at the Praktiseer magistrate's court, 134 Penge workers

were paid Workmen's Compensation for asbestosis in a 10-month period to June this year

A physician, who acts as a consultant to Gefco, said the mine had rigidly tightened up its dust controls and workers who had started in the past five years had little chance of contracting the disease

However, there are many new cases being diagnosed all the time

Half of the asbestosis sufferers will die with a cancer in the lung, though not necessarily of cancer, according to Dr Anthony Seaton, a well-known British occupational health specialist

In its early stages, asbestosis sufferers will experi-

ence, at most, breathlessness, but medical experts are in agreement that asbestosis is a disease that often worsens with time

Towards the end of their lives many asbestosis sufferers will be too short of breath to put on their shoes or walk a few steps without stopping

If a black mineworker contracts asbestosis or mesothelioma, the lump sum compensation payout (in terms of the Occupational Diseases of the Mines and Works Act) is R1 490, though he receives R200 extra if he has tuberculosis as well

A white worker receives R17 889 for the same compensation

Though the company says

it attempts to find alternative employment in non-dusty areas for workers with asbestosis, many are laid off simply because there are no vacancies for them

They do not receive monthly payouts thereafter. In the words of one retrenched mineworker "We must go home and wait for death."

Ironically, the number of jobs in the asbestos mining industry has declined largely because the stringent asbestos health regulations overseas have led to a decline in world demand

Penge mine alone has tailored its workforce from more than 6 000 a decade ago to about 2 000 today.

BY PHILLIP VAN NIEKERK  
**SHOCK** figures revealing how asbestos has endangered the health of workers at a mine in the North Eastern Transvaal are contained in documents leaked to the Rand Daily Mail this week

A report by the manager of the Penge mine, Mr H E Fouche, shows that between 1973 and 1983, about 780 of the mine's employees contracted the lung disease asbestosis

And a mill dust report reveals that asbestos counts up to 65 times higher than the local recommended fibre limit and 260 times higher than the British legal limit, were recorded as recently as 11 months ago

The dust report shows readings for the mine's entire surface plant on September 28 and 29 last year

It records several counts of more than 100 fibres per millilitre, with the highest being a count of 134 fibres/ml

The current recommended limit of the Government Mining Engineer is two fibres/ml, though up to the end of last year it was five per ml

In Britain, where the links between asbestos and lung cancer and mesothelioma have led to more stringent safety regulations, the legal limit is 0,5 fibres/ml

There is a growing lobby overseas — which has already had some success in Scandinavian countries — to have the substance banned completely as the belief is that there is no safe level of asbestos

The vast majority of Penge's readings were more than two fibres/ml while the

8/8/84

217

# Shock figures that tell of asbestosis

average of all readings was 3,9 fibres/ml

Two weeks ago a consulting physician to Penge's owners, the Griqualand Exploration and Finance Company (Gefco), told the Mail that conditions at Penge had been rigidly tightened up over the past five years.

The mine manager's report listing the number of cases per month notes that there is a steady increase in the incidence of asbestosis, with 1983 having the highest average for the decade

Industrial health experts said yesterday this could simply mean that the tests were stricter

The mine's internal figures are higher than — and in conflict with — those issued publicly in the annual report of Gefco's owners, Gencor, or by the Government Mining Engineer

According to the manager's report, there were 79 cases in 1982, compared to 13 stated in Gencor's annual report to shareholders

The average age of the asbestosis victims since 1980 is about 44 years while there

are 10 cases between 1980 and 1982 of workers under the age of 30 contracting the disease

About 58% in 1980, 53% in 1981 and 41% in 1982 had worked for less than 10 years in the industry

Among those listed as having contracted the disease are security guards, drivers, telephone operators, estates labourers and a caddie — people whose work at the mine should not normally expose them to asbestos.

Mr Pat Hart, the managing director of Gefco, yesterday did not dispute the authenticity of the documents

He said that the mine was "pulling its socks up and improving all the time" and that one plant which had particularly high readings in the report had been redesigned.

"In our figures to the Government Mining Engineer (GME) we've found that 95% of all our staff at the mine are working in areas where there is less than two fibres/ml," he said

● More labour news — See Page 8



# Penge not charged for illegal fibre levels

(217) ~~217~~ Star 17/8/84

By Carolyn Dempster

Penge asbestos mine-workers have been exposed to high and illegal levels of hazardous asbestos dust since 1976, yet the mine has so far not been charged with contravention of regulations by the Government mining engineer

This was revealed this week when documents detailing the levels of asbestos dust and fibre in the north-eastern Transvaal mine from 1976 to 1982 and during August, September and November last year were handed to *The Star*

A graph depicting fibre counts in the Penge mill shows a considerable tightening up as from 1981 when there was a change in mine management

However, quarterly samples since then have on occasion still exceeded the limit

Among the documents is an inspection report by the district inspector for the Department of Mineral and Energy Affairs, Mr JHE Celliers dated November 8, 1983

He obtained an asbestos fibre average of 4,965

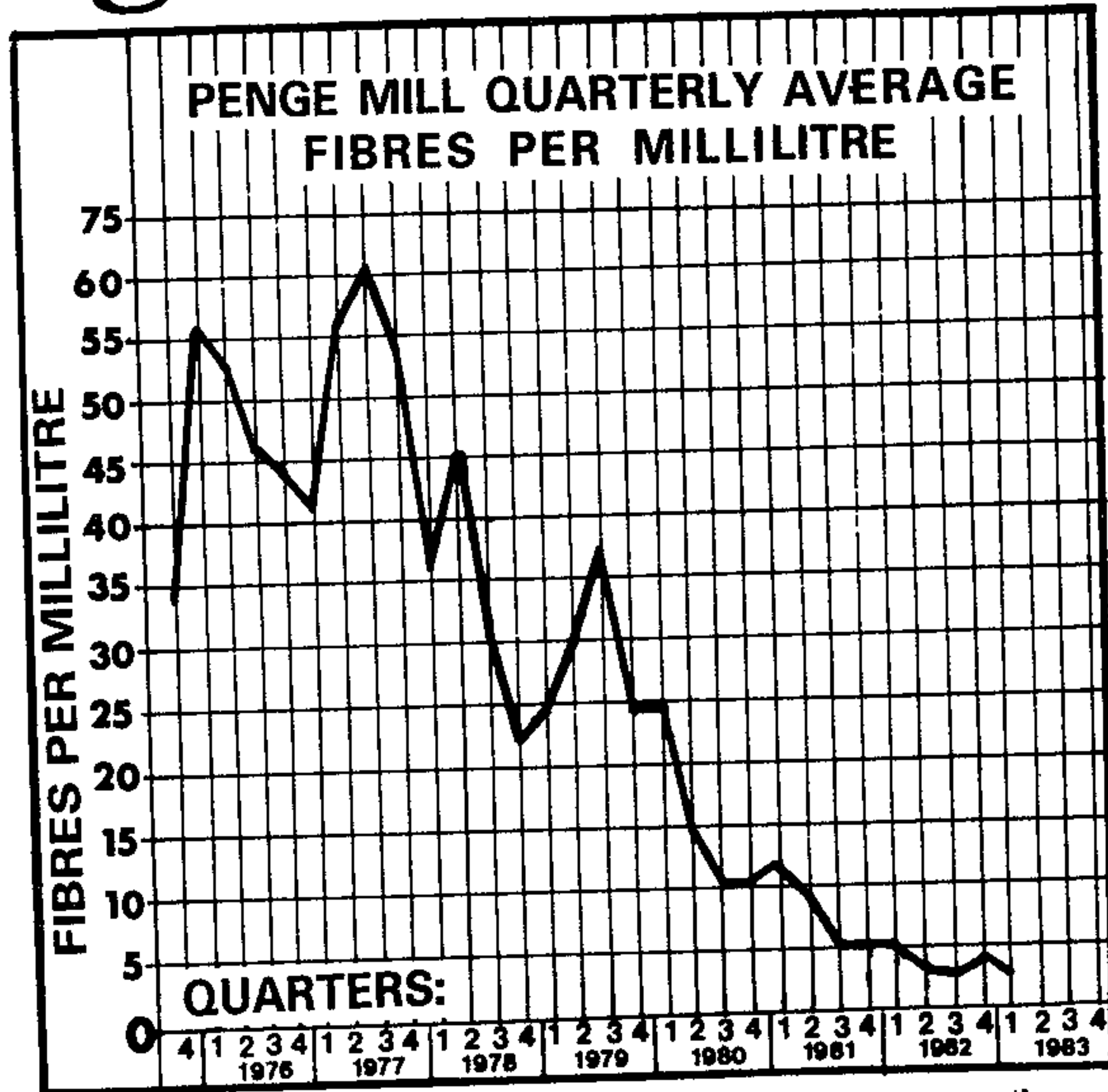

fibres per millilitre (4,965 f/ml) from underground samples, which is twice as high as the limit of 2 f/ml set by the Government mining engineer for controlled South African mines and 24 times higher than the limit set in the United Kingdom

Just two months prior to the inspection, the

mine's ventilation officer recorded spot fibre samples of 134 f/ml and 130 f/ml in particularly dusty areas of the mine mill - 65 times higher than the limit. The information is contained in an internal dust report

Mr DM Morris, deputy Government mining engineer, said the mine had been visited and inspected five times during the past year. Fibre counts had exceeded the stipulated limit in only three samples taken, he added.

"In each case, the mine manager was told of the results and action was taken immediately on the problem."

"According to the chief inspector governing the northern Transvaal, Penge has been very cooperative over the past five years

It is crucial to the health of the asbestos mineworkers that dust levels be kept as low as possible as it has been estimated that one out of every 10 heavily exposed asbestos workers will get

asbestosis - the crippling lung disease caused by the inhalation of asbestos fibres

An analysis of asbestosis and tuberculosis cases at the Penge mine shows that 788 mineworkers contracted asbestosis between 1973 and 1983

Penge mine manager, Mr HE Fouche remarked in the analysis that the figures show a "marked increase in the percentage of pneumoconiosis cases" with the number of asbestosis and TB cases rising from 45 in 1979 to 114 last year

The Griqualand Exploration and Finance Company (Gefco) which is owned by the General Mining Corporation (Gencor) took over Penge in 1981 from Transvaal Consolidated Land and Exploration Co Ltd - a member of the Barlow Rand Group.

Mr LK Jooste, chairman of Gefco was in hospital and unable to comment on the reports and the company's managing director Mr Pat Hart was overseas



# Sent home — to a lingering death

PAUL DUNN'S disability is part of the legacy of asbestos mining in the North Eastern Transvaal.

Unable to walk a few steps without stopping for breath, 54-year-old Mr Dunn spends his days in an armchair in the darkened lounge of his Randfontein home

Two years ago he was pensioned off from Penge mine suffering from "asbestosis" . . . what medical people call "pneumoconiosis" and what miners call "pthisis".

He is one of the more than 800 victims of asbestos dust who have been compensated for the disease at Penge mine since 1973

These figures — which only became public knowledge after they were leaked to the Press — have led to widespread concern at the dust levels in the mine

They have also sparked calls for the figures of asbestos-related and other occupational diseases to be made public and subject to scrutiny

As one of the victims, Mr Dunn speaks with a characteristic asbestosis croak in his voice when describing the mine "The pthisis was on the surface," he says

He pauses between sentences to catch his breath

"I was lazy and used to sit on the stoep . . . Hell, when the trucks went by they used to raise a lot of dust"

Yet Mr Dunn believes the company (Gencor, which controls Gefco, which owns Egnep, which owns Penge) has been good to him



Mineworkers at Penge wait in a corridor of the mine hospital to be medically examined

As a white miner, he was paid R24 000 workman's compensation and receives a monthly pension of R400

Had he been black — like the vast majority of compensation cases — he would

have received R1 490 workman's compensation and returned to his village in Lebowa, without a pension, to die.

Mr Pat Hart, managing director of Gefco, says the mine has sought to provide jobs in the non-dusty areas on the surface for compensated workers

But less than 10% of the mine staff works on the surface. There are not enough jobs for asbestosis sufferers, and the rate of cases has shot up this decade.

In 1980 there were 116 cases, 122 in 1981, 118 in 1982 and, in 1983, more than 148

## PHILLIP VAN NIEKERK

This year there have been 45 confirmed cases, with another 22 "suspicious" cases

A senior medical officer summed it up "They're like plastic syringes. You use them and when they're damaged you throw them back to the homelands"

Asbestosis is a disease that gets progressively worse

When he was first found to be suffering from it, Mr Dunn was switched from shaft foreman to banksman. Three years later, an X-ray test ended his working career by revealing he had second phase asbestosis

Two years later, Mr Dunn walks with difficulty, supporting himself on the wall and stopping frequently as he slowly goes down the passage

He is glad of one thing he does not have cancer

Both lung cancer and mesothelioma, the rare cancer of the lung lining, are promoted by contact with asbestos. In fact, about half the asbestosis sufferers will die with lung cancer

According to Professor Tony Davies, director of the National Centre for Occupational Health, more than

100 people die in Africa every year from mesothelioma

At least 15 of them worked with asbestos, were exposed to it in the environment.

Mesothelioma can occur after very low exposure to the substance . . . a fact which is often cited in the debate over whether there is a safe level of exposure to asbestos

Industry spokesman . . . as Mr Hart believe that the present level of two fibres per cubic centimetre (2 fibres per cubic metre) is "socially acceptable" standard

An educational pamphlet handed out to employees starting work at Penge says present disease cases are related to working conditions that prevailed 20 to years ago

However, though in the past two years there has clearly been vast improvements both in environmental as well as workplace dust control at the mine, this statement has been seriously disputed.

Mr Jean Leger, a chemical engineer and research officer at Wits University

**'In view of the vast experience gained on the Rand in the treatment and prevention of miner's pthisis there is every hope the disease (asbestosis) will be wiped out before long'**

SUNDAY TIMES, November 2, 1941

**'I am satisfied that with the intensive precautionary measures now in existence, the risk of contracting asbestosis can, proportionately speaking, today be said to be slight'**

Dr CAREL DE WET, Minister of Health and Planning, September 23, 1965



# ie — to a death

## PHILLIP VAN NIEKERK

This year there have been 45 confirmed cases, with another 22 "suspicious" cases

A senior medical officer summed it up "They're like plastic syringes. You use them and when they're damaged you throw them back to the homelands"

Asbestosis is a disease that gets progressively worse

When he was first found to be suffering from it, Mr Dunn was switched from shaft foreman to banksman. Three years later, an X-ray test ended his working career by revealing he had second phase asbestosis

Two years later, Mr Dunn walks with difficulty, supporting himself on the wall and stopping frequently as he slowly goes down the passage

He is glad of one thing he does not have cancer

Both lung cancer and mesothelioma, the rare cancer of the lung lining, are promoted by contact with asbestos. In fact, about half the asbestosis sufferers will die with lung cancer

According to Professor Tony Davies, director of the National Centre for Occupational Health, more than

100 people die in South Africa every year from mesothelioma

At least 15 of them never worked with asbestos, but were exposed to it in the environment.

Mesothelioma can occur after very low exposure to the substance — a fact which is often cited in the debate over whether there is a safe level of exposure to asbestos

Industry spokesman such as Mr Hart believe that the present level of two fibres a cubic centimetre (2-million fibres a cubic metre) is a "socially acceptable" standard

An educational pamphlet handed out to employees starting work at Penge says present disease cases are related to working conditions that prevailed 20 to 40 years ago

However, though in the past two years there have clearly been vast improvements both in environmental as well as workplace dust control at the mine, this statement has been seriously disputed

Mr Jean Leger, a chemical engineer and research officer at Wits University,

said after a tour of the mine last week that management was only now introducing dust control technology that had been available for decades

The implication is that if the industry had acted on what was available at the time, it could have substantially cut down the level of disease.

Mr Leger said the present Government Mining Engineer's requirement of 2-million fibres a cubic metre had been introduced in Britain in 1969 and found to be inadequate in preventing asbestosis and lung cancer

At Penge today, more than 80% of the workforce still work in levels above the current British limit of 200 000 fibres a cubic metre

As recently as 1980 the average fibre levels at the mine's mills was 64-million per cubic metre

Even in 1984, the mine has not been able to bring all its levels to below the GME's 2-million limit and has had to be granted an exemption for about 8% of its staff

Industrial health experts believe that disease levels could have been reduced substantially if the public had been kept properly informed of the dangers of asbestos

Prof Davies said that he "lamented the fact that the figures of asbestos disease are not nailed to the wall of factories and mines"

Since 1941 the public has been told not to be alarmed, that the situation is under control.

These statements have been disproved, sometimes only decades later by the continuing high rate of disease. Disease from the current levels will only be diagnosed in years to come.

For this reason, the National Medical and Dental Association (Namda), last week called for the setting up of emergency statutory limits for exposure to asbestos

They believe that South Africa workers are being exposed to risks which would be unacceptable in



PAUL DUNN ... "Hell, when the trucks went by they used to raise a lot of dust"

other industrialised countries

While it is too late to help Paul Dunn or the hundreds of diseased mineworkers

who have returned to their villages in Lebowa, mounting pressure is building up to protect those who have not yet gone that way

**'I am satisfied that with the various intensive precautionary measures now in existence, the risk of contracting asbestosis can, proportionately speaking, today be said to be slight'**

Dr CAREL DE WET, Minister of Mines and Planning, September 23, 1967

**'We know conditions were bad in the Sixties. There has been a tremendous improvement in our dust counts over the last decade ... the risk of asbestosis for a miner who's entered the industry in the past five years is remote'**

CONSULTANT PHYSICIAN to Gefco, July, 1984

... not 700 ... El ... fie ... lem ... if ... A ... W ... that ... the ... nes ... cles ... mous ... tors ... F ... plac ... luc



# The asbestos battle in US

**ELAINE DURBACH  
in New York**

**THE THREAT** to health posed by asbestos in buildings is very much more serious in the United States than was previously realised

According to new figures gathered by the Federal Environmental Protection Agency (EPA), hundreds of thousands of public and commercial buildings, blocks of flats and private homes contain asbestos in a form that could possibly be inhaled or swallowed

The New York Times recently quoted a United States government study, not yet published, that said there were as many as 700 000 such buildings with asbestos in an easily crumbled or powdered form

The National Institute of Environmental Health Sciences was investigating evidence that as many as another 200-million homes could contain the insulation material — mainly in air-conditioning systems — the paper said.

The new findings intensified concern and brought new discussion on the problem it presents.

Schools across the United States were earlier this year threatened with fines if they did not begin to remove asbestos

According to Mr Mark Wein, a spokesman for the association of companies that used to manufacture building materials with asbestos, the process of removing the asbestos could release the damaging particles into the air, causing more of a health risk.

There were few contractors qualified to do the removals safely, he said

Earlier studies focused mainly on schools and work places. This is the first time there has been a nationwide

assessment of asbestos risk in public and private places

According to a new study on schools, about 15-million children and 1.4-million school employees are at risk in buildings containing asbestos

For private companies the cost of removing asbestos can be prohibitive. An insurance company said it was going to spend more than R30-million to clear one 52-storey building in Boston

A leading researcher in the health impact of asbestos — Dr Irving Selikoff, of Mount Sinai Medical Center in New York — estimates that there is at present about 30 tons of asbestos in buildings across the United States

He describes this as the "third wave of exposure to asbestos hazards". In an interview with the New York Times he explained that the first involved those who mined or milled asbestos, then came those who worked with it in construction, transport and chemical businesses

Now those at risk are the occupants of buildings with asbestos and those involved in removing or maintaining it.

He said that within the next few years victims of asbestos could claim between R35 000-million and R100 000-million from industry

American unions are currently fighting to gain compensation for slow-developing diseases, such as those caused by exposure to asbestos

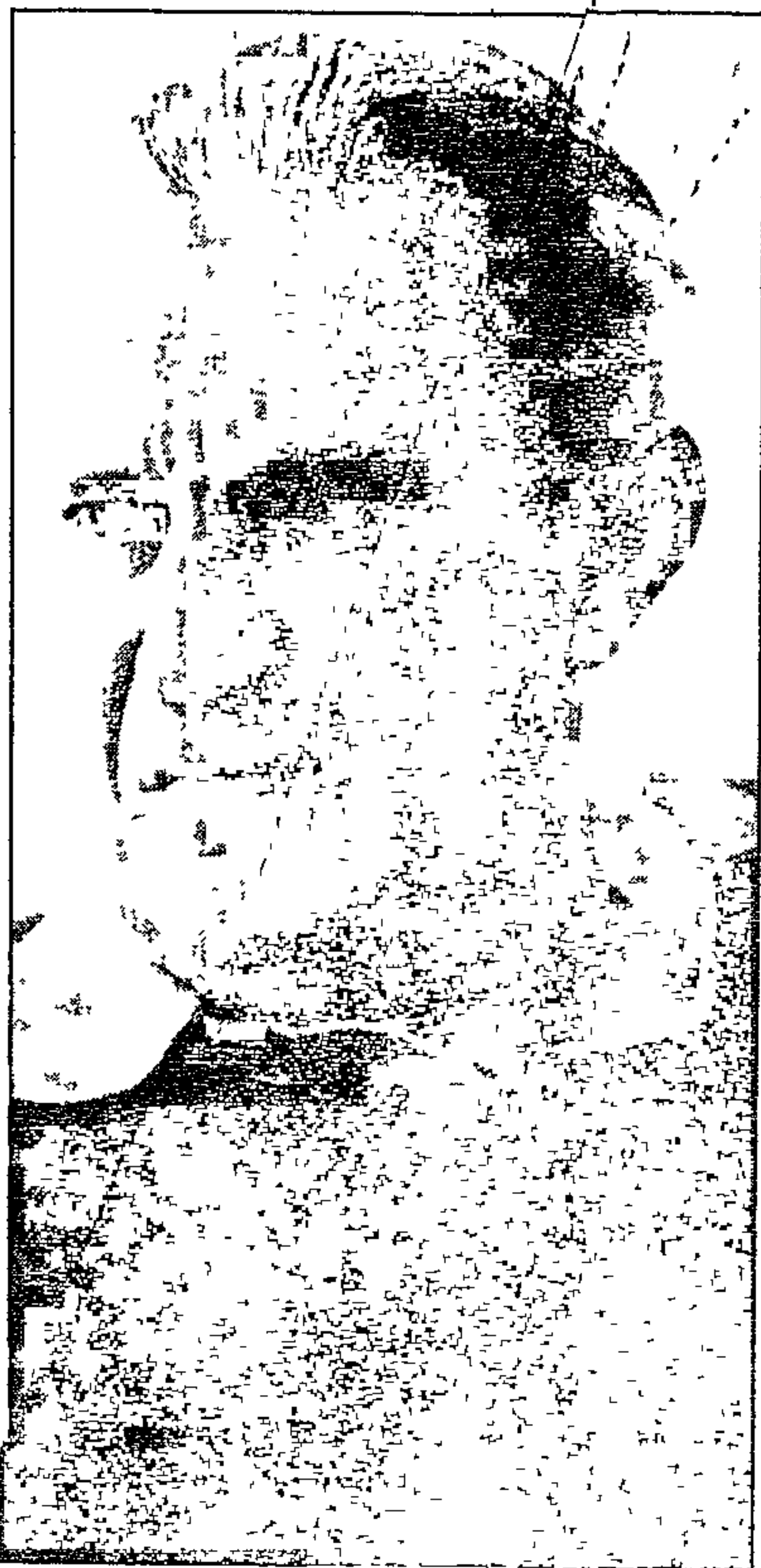

**PAUL DUNN ... "Hell, when the trucks went by they used to raise a lot of dust"**

other industrialised countries who have returned to their villages in Lebowa, mounting pressure is building up to protect those who have not yet gone that way

**'We know conditions were bad in the Sixties. There has been a tremendous improvement in our dust counts over the last decade ... the risk of asbestosis for a miner who's entered the industry in the past five years is remote'**

CONSULTANT PHYSICIAN to Gefco, July, 1984

after a tour of the mine week that management only now introducing control technology that been available for dec-

The implication is that if the industry had acted on was available at the time, it could have substantially cut down the level of

Mr Leger said the present government Mining Engineer's requirement of 2-million fibres a cubic metre had been introduced in Britain in 1969 and found to be adequate in preventing asbestosis and lung cancer

At Penge today, more than 80% of the workforce work in levels above the current British limit of 1000 fibres a cubic metre. As recently as 1980 the average fibre levels at the mine's mills was 64-million fibres a cubic metre.

Even in 1984, the mine has not been able to bring its levels to below the MME's 2-million limit and had to be granted an exemption for about 8% of staff

Industrial health experts believe that disease levels could have been reduced substantially if the public had been kept properly informed of the dangers of asbestos

Prof Davies said that he lamented the fact that the figures of asbestos disease are not nailed to the wall of factories and mines

Since 1941 the public has been told not to be alarmed, but the situation is under control

These statements have been disproved, sometimes by decades later by the continuing high rate of disease. Disease from the present levels will only be recognised in years to come.

For this reason, the National Medical and Dental Association (Nmda), last week called for the setting up of emergency statutory limits for exposure to asbestos

They believe that South Africa workers are being exposed to risks which will be unacceptable in



argus 28/8/84 (217)

# Asbestos rush brought death legacy

## Miners swarmed to mountains

Argus Correspondent

JOHANNESBURG — The "asbestos rush" which transformed the scenic Strydpoort Mountains of north-eastern Transvaal into a hive of mining activity from 1940 to 1970, brought with it a legacy of death

Blissfully ignorant of the health hazards of asbestos fibres, thousands of get-rich-quick white prospectors swarmed to the kloofs to carve out their fortunes after the end of World War 2

Today, the hills stretching from Donkerkloof through to Mmafefe are pockmarked with hundreds of old asbestos adits (mine entrances) and waste dumps litter the valleys

Mr Gideon Nieman, whose family owned Skeiding Farm within the 100km-wide asbestos mining region, recalled how the brown (amosite) and blue (crocidolite) asbestos was extracted

"The black labourers were issued with a tin of dynamite doppies and sent into the hills. When they had collected a couple of drums of asbestos fibre they would sell it to the white entrepreneurs at £1 a drum. These white 'entrepreneurs' would then make a profit by selling it to one of the main asbestos mining companies," he said

### Labour force

For every white asbestos miner who settled or set up a tent in the area there was a labour force of some 200 black workers — from Malawi, Mozambique, Zimbabwe and Zambia

"The local Bapedi were never miners", states Mr Nieman, which explains why the local black population today knows little or nothing of the dangers of

Asbestos fibre is mixed with cement and water to make bricks at Mmafefe



asbestos fibre

Mr Nieman whose knowledge of the area goes back 58 years, was fully aware of the health threat even though mining asbestos might have meant overnight wealth

"I never worked on those mines — I saw what the asbestos did to your lungs. I was present at four post mortems and it looked like gangrene," he said. "Even amosite is dangerous"

Among the major companies which moved into the area were Associated Asbestos, Voorspoed Asbestos, Anglo American Cape Blue Asbestos and Egnep, later taken over by the Griqualand Exploration and Finance Company (Gefco)

An American doctor who made a radiological and clinical survey of the mines in 1949 — at least 15 years after it was discovered that inhalation of asbestos fibres caused the lung disease asbestosis — found 'deplorable' hygienic conditions in one of the large mills

### Young children

Writing in the Annals of the New York Academy of Science, Dr G W H Schepers states: "I found young children completely in large shipping bags trampling down fluffy amosite (brown) asbestos. X-rays revealed several to have asbestosis with cor pulmonale (failure of the right side of the heart) before the age of 12"

Why, Dr Sluis-Cremer (a prominent South African medical researcher) did not see them 10 years later is fairly evident. There was probably not one of them still alive

In the valley where the mill was located, asbestos dust rolled through like the morning mist. Even the food in the local hotel was gritty with dust



Asbestos dumps loom behind a child standing in a road in the Strydpoort Mountains.



ROM 11/8/84 (62) (217)

# US Steel holds interests in asbestos dumps

By PHILLIP VAN NIEKERK

UNITED States Steel — one of the wealthiest and most powerful corporations in the world — holds investment interests in abandoned asbestos dumps which are polluting large areas of the North Eastern Transvaal and creating a health hazard to thousands of people, a Rand Daily Mail investigation has disclosed.

Also holding extensive land and mineral rights in the area is the British asbestos multinational, Turner and Newall.

The Mail has established that several farms in the area littered with asbestos dumps have been sold to the South African Development Trust in the past 18 months for incorporation into Lebowa.

At present sparsely populated, these contaminated farms are soon to be the scene of large-scale settlement by blacks

The sales could be in contravention of a provision of the Atmospheric Pollution Prevention Act that a mine-owner cannot dispose of any asset of that mine unless he has taken the necessary steps to prevent dust pollution

The Mail was the first to report the existence of numerous uncovered dumps in the area four weeks ago. Since then researchers have estimated that at least 200 000 people living there could be exposed to the pollution

Only one tailing dump in the entire asbestos area running along the Strydberg mountains, which includes densely-populated sections of Lebowa, shows signs of attempts to cover it and prevent environmental contamination

The main companies still owning land and mineral rights in the area are Associated Asbestos, Lagerdraai Asbestos, Dublin Consolidated Mines and Egnep, alongside numerous other small owners.

Dublin Consolidated is owned by Turner and Newall, while Egnep is owned by the Griqualand Exploration and Finance Company (Gefco), which is controlled by the mining giant Gencor.

Associated Asbestos and Lagerdraai Asbestos are wholly owned subsidiaries of Associated Ore and Steel which is controlled by Oresteel Investments in which U S Steel has a 49 % share and is the largest single shareholder.

An Italian company, Italiani Prodotti Minerali, also holds a substantial interest in Associated Ore.

Mr Robert E'sperance, a director of Oresteel based at U S Steel's headquarters in Pittsburgh, Pennsylvania, told the Mail yesterday that he was "totally unaware" of the situation

"We are minority shareholders," he said, adding "I can't comment on the environmental situation, though U S Steel is very, very concerned about environment all over."

Three farms contaminated by asbestos dumps and in which U S Steel, through Associated Ore, holds a major shareholding have been sold in the past 18 months to the S A Development Trust.

They are Piezangsdraai, Lagerdraai and Beesthoek. On Lagerdraai there is an old mill and a tailing dump with a family living right on top of it.

Mr Guido Sacco, the chairman of Associated Ore and Steel, admitted that they had taken no steps to cover the dumps on their properties.

"We stopped mining asbestos a long time ago, about 15 years," he said. "We were a very, very small producer. At the time we did not know asbestos was injurious to the health"

According to company reports, there were mining operations on both Lagerdraai and Piezangdraai as recently as the early seventies

The Turner and Newall-owned Dublin Consolidated — which has maintained substantial base mineral rights in the area — has been gradually selling off its farms with old mine dumps on them.

All the farms have been sold in the past five years, and the dumps show no signs of having been covered up

At Bewaarkloof — which Egnep sold to the SA Development Trust in May for almost quarter of a million rand — vegetation has been planted on the dump but fibres have continued to spill into the road despite a wall being built around it.

Mr C Good, the group finance executive for Turner and Newall Holdings, said that as far as he knew the mines on Dublin property had been worked by tributors

"To the best of my knowledge — and I must concede its scanty — the Government Mining Engineer's approval was granted for the sale of the properties"

However, according to an old newspaper report Dublin Consolidated employed 15 000 workers in 1968 working mines in the Bewaarkloof valley alone.

# Govt expected to back R40-<sup>(217)</sup>m plan to rescue O'Okiep mine <sup>Stan</sup> <sup>6/9/84</sup>

By Stan Kennedy

The Government is expected to announce a R40 million rescue operation to avert closure of the O'Okiep copper mine in the north-west Cape.

A decision is expected later today.

"There doesn't appear to be any doubt that the Cabinet will approve the plan since it is guarantor to some of the mine's debts, which are mainly borrowings from the banking sector," Mr Bernard van Rooyen, an executive director, Gold Fields of SA, told The Star.

"Government would not like to see the mine close because of the considerable losses it would incur. This apart, about 1 950 people are employed at the mine and there is no possibility of alternative work being found for them in the area."

O'Okiep, which is controlled by Newmont Mining Corporation of the US, has agreed in principle with O'Okiep's major creditors, the South African Government and its two major shareholders on the proposed new lease of life.

Newmont and the Gold Fields of SA group, which together own 74 percent of the company's stock, have agreed to arrange a capital infusion of at least R20 million, which will probably be via an ordinary share right issue underwritten by the two companies.

The Government will assume up to R40 million of the company's indebtedness to a finan-

cial institution in connection with the Carolusberg mine joint venture

It was in 1979 that O'Okiep undertook the development of a new deep-level copper mine, which was financed by borrowings. But with low copper prices and high interest rates, the mine's position became progressively tighter

Gold Fields became involved last year when it jointly underwrote a rights issue with Newmont, and it ended up with a 25 percent shareholding in the company

At the time it was hoped at the time that would be the end of the problem. This was not to be, and a fuller reconstruction of the company's affairs is now recommended. In essence, it will comprise a further rights issue to bolster the company's balance sheet

Mr van Rooyen said Government acceptance was subject to Parliamentary approval "In the meantime, we will go forward with the scheme," he said.

O'Okiep says that the final maturity date of its debts assumed by Government will be extended to January 1991 from March 1987.

The Government has also undertaken to arrange for the maturity date of about R8 million in debentures to be extended to January 1989 from January 1986

Details of the rescue plan are expected to be released by the end of the month.



# Concern over asbestos heaps in Lebowa

By PHILLIP VAN NIEKERK

LEBOWA'S Director of Health, Dr A M Makunyane, has expressed extreme concern at the danger to people caused by abandoned asbestos dumps littering vast sections of the homeland east of Pietersburg.

Dr Makunyane told the Mail yesterday the dumps should be covered up by those responsible as soon as possible.

He said his health officials had inspected the dumps after newspaper reports on them had appeared.

"They recommended (either) that the dumps be covered with soil or the people from the schools be advised to move as soon as possible. Something has to be done."

Dr Makunyane said the companies involved — which the Mail has established include large multinationals such as United States Steel and Turner and Newall — could afford to pay.

"Unfortunately, the big fellows have done this to us. They have just come here to dig out the money, leaving the consequences with the people."

He said many people in isolated areas were assumed to have died of natural causes and simply buried. Few post mor-

tems were performed, which meant there was no accurate record of the number of people dying because of asbestos dust.

● An entire community of people living in mobile-home trailers in Globe, Arizona, in the United States, was evacuated last year because of contamination from a nearby asbestos dump.

Local newspaper reports said the people were living near to an old mine with a dump next to it which had initially been covered with soil.

The people were moved out by the United States Environmental Protection Agency (EPA).

Experts said this was only the second time the EPA had taken this action to evacuate people at its own cost: the first time was from a dioxin spill area in Missouri.

The dump at Globe consisted of white asbestos — the least harmful — while the dumps in Lebowa and the North Eastern Transvaal consist of blue asbestos, regarded as the most dangerous.

The total number of people affected in the Globe move was 130, whereas researchers have estimated that at least 200 000 people could have been exposed to asbestos in the North-Eastern Transvaal

Argus 27/9/84

NATIONAL

217

# Killer asbestos disease described

Staff Reporter

A survey has shown that people in mining, building, marine-engineering or even working on the country's railways may be exposing themselves to a deadly asbestos-related disease.

A DEADLY asbestos-related disease, malignant mesothelioma, is contracted by about 100 South Africans each year, according to the latest edition of the South African Medical Journal.

The article says while asbestos miners are at risk, it is not possible to estimate how many other people face a similar risk from occupational or environmental exposure.

However, each year about 100 new cases of mesothelioma — or a national incidence of 7.2 a million — each year are confirmed by the South African Asbestos Tumour Reference Board.

## True incidence

The article says this statistic underestimates the true incidence of mesothelioma in South Africa because it excludes certain types of tumours.

A study undertaken at the National Centre for Occupational Health between January 1977 and June 1983 of the clinical and epidemiological features of 80 cases of malignant mesothelioma showed a positive history of asbestos exposure in 89 percent of the cases.

The average survival time from diagnosis to death was about eight months and from onset of symptoms to death about 13 months.

Average duration of asbestos exposure for patients was about 13 years, but the time ranged from one week to 47 years. Average time from first exposure to diagnosis was about 34 years.

## Mining industry

Of the 68 people who reported occupational exposure, 22 percent had worked in the mining industry, 22 percent on the railways and 12 percent in the construction industry.

Others worked in marine-engineering industry, the primary asbestos manufacturing industry and other assorted industries.

Most of those exposed had been involved in lagging boilers and pipes, (34 percent), drilling, cutting and sawing asbestos products, (16 percent), underground mining, (12 percent) and surface mining jobs (7 percent).

Other activities included transport of raw asbestos and the use of asbestos gloves, blankets and aprons.



ROM 3/10/84 217

# Asbestos campaign launched

Mall Reporter

THE Black Allied Mining and Construction Workers' Union (Bamcwu) has launched a national anti-asbestos campaign following investigations held in the wake of the strike at the Penge mine in the North Eastern Transvaal.

A spokesman for Bamcwu said yesterday they would be holding a Press conference later in the week to spell out the details of their findings.

"As a result of these findings the union felt that a national campaign to help all people affected by this deadly dust should be launched."

The strike — in which several hundred members of Bamcwu were dismissed — sparked much interest when the fact that hundreds of workers had been compensated for asbesto-  
sis over the past decade came to light

5/10/84

# Bamcwu wants asbestos mines closed

By NKOPANE MAKOBANE

THE BLACK Allied Mining and Construction Workers' Union (Bamcwu) yesterday launched a national anti-asbestos campaign following its recent investigations on asbestos mineworkers in the north eastern Transvaal.

Addressing a Press conference in Johannesburg yesterday, Mr Pandelani Nefolovhodwe, the union's general secretary, said the launching of the campaign has been prompted by the high incidence of asbestos-related diseases

The diseases were mesothelioma and asbestosis (lung cancer), which communities living near asbestos mines and dumps are in danger of contracting. In the north eastern Transvaal alone, 500 000 people could be affected

"The closure of asbestos mines is going to be our priority because the health and safety of black workers comes first. We would rather starve than sell our labour plus our lives," he said

"Our campaign shall be geared at alerting the entire community to the dangers they are subjected to in their daily toil for the enrichment of the capitalist minority. It shall also make the rural masses aware of the looming death as a result of the system's intransigence," Mr Nefolouhodwe said

ST  
—  
HJ  
set  
qu  
th  
e  
inc  
  
fac  
pic  
dy  
u  
re  
pir  
s  
pid  
o  
e  
w  
n  
  
ve  
na  
pd  
q

ST  
—  
HJ  
set  
qu  
th  
e  
inc  
  
fac  
pic  
dy  
u  
re  
pir  
s  
pid  
o  
e  
w  
n  
  
ve  
na  
pd  
q



Secretary of State on their employment prac- next year

# Cinema change

Mall Reporter

THE Vistarama cinema in Johannesburg, opposite the Carlton Centre, is to change hands next month

Romay Films managing director, Mr Heinz Kallenbach, announced yesterday his company was selling the cinema to Captive Films with effect from November 1

Vistarama will remain in being, though probably not as an "art house" featuring Continental films, with which Romay has made its reputation

His own company, said Mr Kallenbach, would continue to distribute its product through Ster-Kinekor and independent outlets

# Asbestos company to lay off 537 staff

Mall Reporter

THE Griqualand Exploration and Finance Company (Gefco) is to cut back on production at their asbestos mines in the north-western Cape, resulting in a reduction of about 537 jobs

Announcing this yesterday, Mr Pat Hart, the managing director of Gefco, said the company would do "everything possible" to find the

workers — 500 blacks and 37 whites — jobs elsewhere in the group

Mr Hart said the 10% cut in production resulted from the failure of world demand for asbestos to improve

"Latest indications are that the demand has remained static and the very high holding cost of fibre stocks has compelled us to make this cutback," he said.

# Ethiopia gets European aid

ADDIS ABABA — Ethiopia has signed an agreement with European aid donors under which it will receive

10 000 tons of wheat for drought-stricken regions in southern Ethiopia, government officials said yesterday

MR & MRS HOLIDAYMAKER  
**SAVE MONEY**

See the latest in  
Camping and Outdoor  
Equipment at the

## Caravan, Camping and Living S

**MILNER PAI**

Fri 5 — Sat 13 Oct  
10h00 — 21h00



### Fun and Entertainment for the whole family

South Africa's biggest outdoor show, with many new exhibits, will again provide fun in the sun for the whole family

### Win a R10 000 Caravan, plus many other prizes daily.

Win big, big prizes like a fully fitted out caravan worth R10 000, a luxury holiday for 6 in December in a cabana at Long Beach plus many other exciting prizes. Also treasure hunts, deck chair erecting competitions and archery demonstrations daily. Mechanical Bull, Farmyard for the children. Fun and more fun. Meet the Radio Highveld DJ's and join in the braai competitions



White metal could earn up to R550m more for SA

S. Express 7/10/84 217

# Platinum poised to be star export

ND  
 (217)  
 RUSTENBURG  
 PLATINUM  
 TO BE  
 STAR  
 EXPORT

## Platinum could earn R550m more for SA

The long-standing practice has been for the bulk of platinum supplies to be sold by the South African mining companies at a fixed producer price under supply contracts. The current producer price, in force since 1980, is \$475 an ounce.

However, it has become increasingly meaningless. With the free market price well below this there is believed to have been substantial price discounting by the mining companies, and Rustenburg moved the bulk of its output on to the free market price at the beginning of 1983.

Rustenburg and Impala have reported impressive performance improvements for the year to June 30. Impala's turnover rose 37% this year after a 34% gain last year, and consolidated profit before taxation and lease consideration was up 54%.

From PAGE 1

platinum from industrial consumers in the western world is estimated to have grown by some 10%.

"It would appear as if industrial consumers turned largely to the South African primary metal producers, who have adjusted production and stock levels in an endeavour to meet the sharp increase in demand."

Rising demand has been counteracted to some extent by falling prices — though as with other mineral exports, the rand value of the sales has been buoyed by the depressed state of the rand.

Rustenburg chairman Mr Gordon Waddell noted that the American automobile industry continued to recover throughout the year. The first of Rustenburg's major contracts with automakers ends next March, and although a renewal has not been negotiated, "Rustenburg is in a position to sell its platinum elsewhere and on better terms."

Japanese consumption of platinum, which fell 14% last year, has jumped back up again, mainly thanks to increasing demand by the automobile and electronics industries.

SOUTH Africa could earn an extra R400-million to R550-million this year from platinum, which looks like being the star performer of the mineral industry in the next 12 months.

Estimates of export revenues this year range from R1-billion to R1.3-billion, compared with last year's R600-million to R750-million. (Exact figures are not provided in South African statistics because platinum is considered a strategic metal.)

In addition, earnings from palladium (a platinum group metal) could be R260-million.

Last year, according to one estimate, Rustenburg Platinum and Impala Platinum exported 1.6-million ounces which, at an estimated average price of around R470, pulled in about R750-million. This year demand has firmed, and although the dollar price has declined the rand price has risen because of the exchange rate.

The main uses of platinum are in catalytic converters (air pollution control devices) for the motor industry, and in jewellery — mainly in Japan. It is also used in electrical and electronic components, as a catalyst in oil refining, and in glass production.

"The industry could be exporting 2.5-million ounces this year at an average price of R520, which would earn R1 300 million," said Mr Ian Hamilton, senior financial analyst of Max Pollak & Freemantle.

Mr Hamilton said non-communist world demand during 1984 was expected to be almost 3.1-million ounces — 3% higher than the previous peak of 2.99-million ounces in 1979 and 23%

By TONY KOENDERMAN  
 Financial Editor

up on last year's 2.49-million ounces. However, brokers J D Anderson, who recently produced a research report on platinum, are more cautious. They estimate last year's export revenues at R600-million, and expected this year's figure to be about R1-billion.

"I don't think everything that is being produced is being exported," said an analyst. "There is a long lead time for exports."

### Bullish

In a yet more conservative, but still bullish, outlook report for 1984 and 1985, the Minerals Bureau has forecast that only gold and coal are likely to have greater foreign exchange earnings.

During the first six months of 1984, export volumes rose 22.5% and earnings 36.2% compared with the same period of 1983.

"This trend is likely to continue through the second half of 1984, giving rise to a 22% increase in revenue for the year," said the bureau. "During

FREE WORLD PLATINUM DEMAND (Millions of ounces)

	1979	1980	1981	1982	1983	1984
USA	1,30	1,10	0,68	0,78	1,12	1,57
Japan	0,92	0,94	1,15	1,09	0,95	1,00
Other	0,77	0,68	0,41	0,42	0,42	0,51
Total	2,99	2,72	2,43	2,09	2,49	3,08

● To PAGE 2

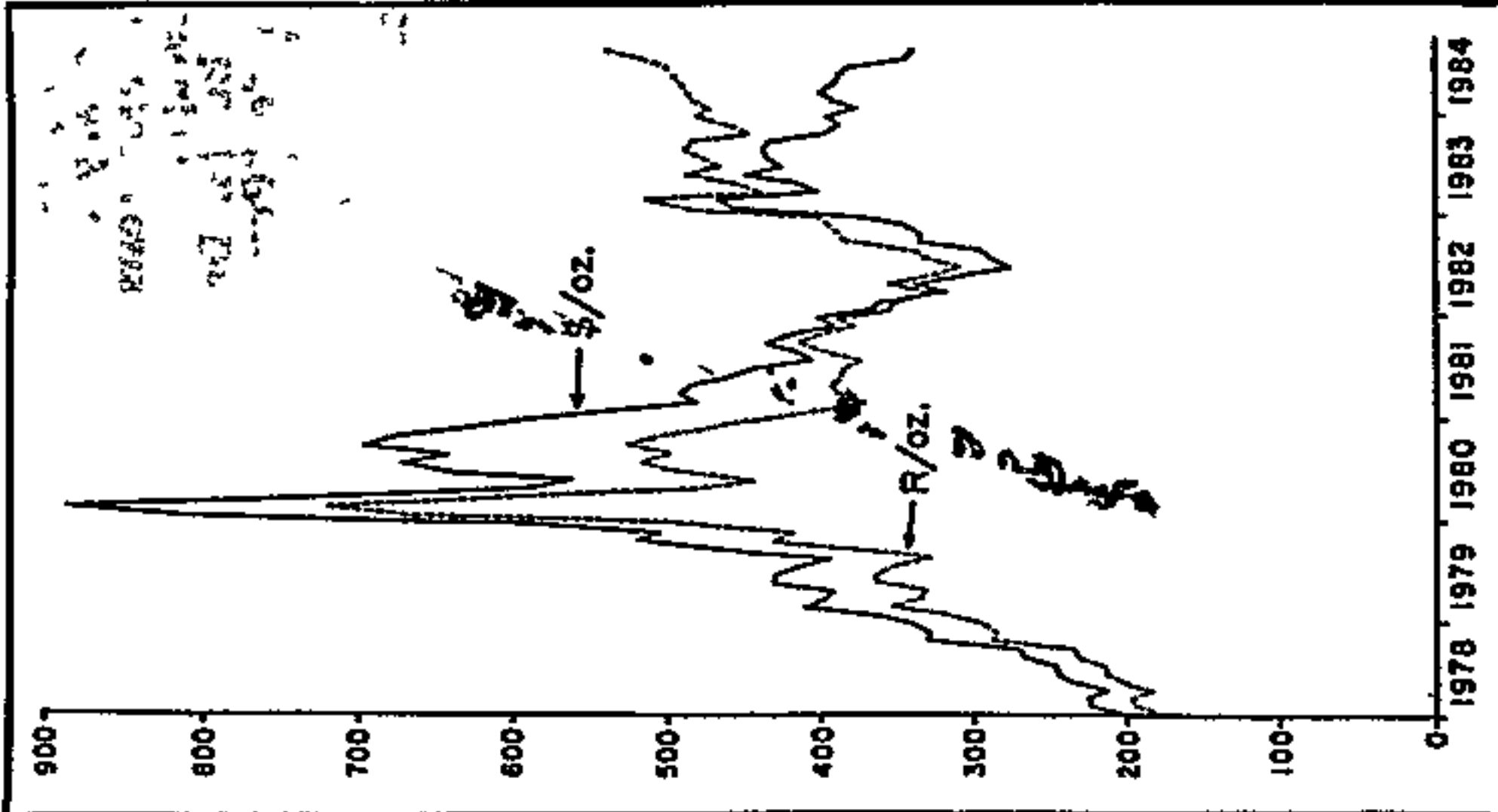

● Graph shows monthly averaged London fixings of platinum price 1985, a further increase in earnings of no less than 33% is expected.

Two interesting trends are the apparent fall in Soviet production and hence its sales to the West, and the fact that the United States has not imported much from Russia.

An inhibiting factor for the platinum price is its linkage to gold by speculative buyers. With gold on the wane, the platinum price has ebbed too. "But," Mr Hamilton said, "platinum must eventually break away from gold and be treated as a commodity rather than a precious metal. This probably will not happen this year, but it could happen in 1986-7."



# Union calls for boycott of asbestos products

By PHILLIP VAN NIEKERK

THE Black Allied Mining and Construction Workers' Union (BAMCWU) yesterday launched the country's first anti-asbestos campaign with the avowed aim of closing down the South African asbestos industry.

At yesterday's campaign launch, BAMCWU produced figures showing that 5 140 mineworkers had been compensated for asbestosis in South Africa since 1967, 212 had been compensated for mesothelioma and 57 for lung cancer.

The figures — which BAMCWU officials said "under-estimated" the problem — were taken from official Mines Bureau of Occupational Diseases (MBOD) statistics.

A BAMCWU statement said they wanted to mobilise

the community against the product and that the final aim of the campaign was closure of asbestos mines.

Asked whether this might mean they were campaigning for something which would mean a loss of jobs for their members, Mr Pandelani Nefolovdhe, a BAMCWU spokesman, said it was a question of life and death.

"We don't envisage a situation where we would choose to die in order to earn very little. We'd rather starve than sell our lives."

The Azanian People's Organisation (Azapo) issued a statement at the Press conference calling for a ban on asbestos because "even though we may be classified as Third World, our citizens deserve First World treatment".

Dr Abu-Baker Asvat, Azapo's Health Secretary, called

for better protection for workers as the banning of the substance could not happen overnight.

He called on the Government and mine managements to increase the compensation paid to black workers suffering from asbestosis from R1 490 to R15 000.

In addition, black workers who suffered from "this irreversible and permanently disabling disease" should get a permanent monthly pension to bring them in line with white workers, he said.

BAMCWU invited doctors, other trade unions and concerned individuals in the community to lend whatever support they could. They would also be writing to foreign countries to make the international community aware of what was happening in South Africa.

# Palamin, O'Okiep in the pound seats

14/10/84 217 S. Lina

By Roy Bennetts

**PALABORA** Mining and Gold Fields of SA's O'Okiep mine, the only two significant South African copper producers, could benefit from President Reagan's reluctance to give the US copper industry protection.

Because he will not protect US producers, one mine after another is closing. Already a third of US copper mines have closed.

## Chile

The main source of US copper imports is Chile, which leads the world with production of 1 240 000 tons a year.

The Reagan Administration has made it known that it will frown on any collusion aimed at controlling the price of imports.

At the time of the Carter Administration, the International Trade Commission recommended that import quotas of 272 000 metric tons a year be imposed. This recommendation was rejected, and according to the current petition, the injury caused by imports has worsened since then.

The irony is that in 1983 the

Inter-American Development Bank lent the Chilean Government an additional \$268-million to expand copper production. The lion's share of this loan was contributed by the United States.

To add insult to injury, the governments of Zambia and Zaire are asking the World Bank for multi-million dollar loans to stimulate their copper production.

The rate of closure of copper producers may not be matched by a rise in imports. Third World producers, such as Zambia and Zaire, as well as Chile, are running at al-

most capacity, and South Africa expects to lower its exports in the coming year.

The London Metal Exchange is estimated to have stocks of only 165 000 tons against a desired 400 000 tons, and the US Comex possibly holds another 300 000 tons.

South Africa is fortunate because it produces more copper than required for home consumption, but the scheduled closing of the Prieska mine in 1985, and an estimated increase in domestic demand, may produce a 4% fall in export tonnage.

With copper selling on the London market at about £1 036 a ton the South African producer is receiving R2 100 a ton.

sult in a 13% reduction in earnings to R188-million for 1984.

The outlook for Palabora Mining, which produces 66% of South African copper, appears healthy, and one can even expect O'Okiep, with an 11% share of the market, to produce an improved balance sheet after its recent financial problems.



Union 27

## warns of asbestos dangers

**Mall Reporter.**

**THE Black Allied Mining and Construction Workers' Union** has sent letters to the governments of six Southern African states warning them of the dangers of asbestos to which their nationals are subjected to in South African mines.

The states include Botswana, Zambia, Lesotho, Mozambique, Swaziland and Malawi.

The letters have been sent as the next step in BAMCWU's national anti-asbestos campaign, the first such campaign in South Africa, which was launched last week.

BAMCWU has "vowed" to close down the asbestos mines and it has said that workers would rather "starve" than sell their lives for very little.

A statement released yesterday by BAMCWU's publicity secretary, Mr Motsoni Makhine, said that extensive public support was being galvanised in the campaign by the union's members.

Local organisations, institutions, trade unions and groups were being contacted.

Letters have also been sent to international labour movements in Sweden, Canada, Norway and Denmark to make them aware of the campaign and to request them to pledge solidarity with it.

Mr Makhine also said that BAMCWU's lawyers were studying legislation with a view to taking companies mining asbestos to court "for gross negligence".

At the campaign's launch last week BAMCWU produced figures which showed that 5 140 mineworkers had been compensated for asbestosis since 1967 and that 212 had been compensated for mesothelioma and 57 for lung cancer.

The figures, which BAMCWU said "under-estimated" the extent of the asbestos-related diseases, were taken from the official Mines Bureau of Occupational Diseases statistics.





TWO-AND-A-HALF months after the Rand Daily Mail first reported the widespread asbestos pollution caused by abandoned dumps near Pietersburg in the North Eastern Transvaal, little has been done to clean them up.

The Government Mining Engineer has warned local brickmakers to stop making their bricks from asbestos dust. The Egnep mining company — owned by the Griqualand Exploration and Finance Company (Gefco) — has taken down its signs in the Bewarkloof valley. For the communities living next to the blue and

brown asbestos dumps in the villages of Lebowa — who have learned for the first time that they are threatened by a potentially deadly health hazard — it has been a trying time. In recent weeks they have been visited by doctors, journalists and television crews. By all sorts of official testing for dust levels and in one case by a

# Just who's in charge of these dumps of death?

PHILLIP VAN NIEKERK

mysterious group wearing white jackets and masks.

Children have been warned to stop playing on the dumps, the brickmakers now make their bricks from red clay brought in from other areas, and attempts have been made by school teachers in particular to educate the villagers and find ways of dealing with the problem

A teacher at Mahlapani, one of the small villages polluted by blue asbestos dumps, summed up a dilemma which has arisen in the community over the hazard

"Some people say we've been here a long time with these dumps and nothing has happened. Others said yes, a lot of people of the older generation are dead because

of this dust. There's little we can do. We can agree to stop using the dumps but we can't cover the dumps. We don't have the money."

Some children still play on the dumps, people have continued to plaster their homes with asbestos

Mr Samson Moyaletfa, a teacher at the village of Maete, said many people were angry because they believed the mining companies and the Government had evaded their responsibilities. The community had simply

been left with the dumps without ever being informed of the hazard. "The government must do something," he said. But no one has yet accepted responsibility for the situation which could cost millions to clean up.

According to Mr S P Badenhorst, the Government Mining Engineer, the asbestos fields of the North Eastern Transvaal are not in a "proclaimed area" so there is no legislation providing for the covering of dumps.

Most of the land no longer belongs to the big companies who, until recently, owned substantial property in the area, so it is not seen as their responsibility.

But in terms of the Atmospheric Pollution Prevention Act, there is an obligation on the GME to ensure that the owner of a mine has taken "all the necessary steps" to prevent dust pollution before

he sells the mine or the land it is on. Most of the land littered with asbestos dumps in the Bewarkloof valley and would soon inspect months to the South African Development Trust — with no attempt to clean up.

Only the farm, Bewaar-kloof, sold by Gefco for R250 000, has a wall around the dump and attempts have been made to grow vegetation, although the fibres still spill into the road.

Apart from Gefco, the sellers include Turner and Newall's Dublin Consolidated Asbestos and two companies in which United States Steel has a large shareholding. Associated Asbestos and Lagerdraai Asbestos.

All still have mineral rights in the area and Dublin still owns some property in the valley with uncovered asbestos dumps. This week Mr C Good, the

group financial executive of Turner and Newall Holdings South Africa, said his company was working on the situation and would soon inspect the property.

What makes the sale of these properties significant is that, while at present they are sparsely populated, they are soon to be opened up for settlement by thousands more people before being incorporated into Lebowa.

In recent years there has been a vast influx of people into the whole area. According to official census figures, the population doubled between 1970 and 1980, a result of forced resettlement and influx control.

Despite the GME's denials that the health hazard is serious, people are flooding into an area contaminated by what, in western countries, is recognised to be a highly toxic substance.

In the United States last year, an entire community at Globe, Arizona, was evacuated by the US Environmental Protection Agency because they were found to be living near an exposed asbestos dump.

On the other hand, people in the town of Cerrillos, Turkey, have used asbestos outcrops in the mountains to make whitewash and stucco for their walls and roofs, leading to an exceptionally high rate of chest disease and cancer.

Inadequate health facilities have made it difficult to determine the extent of disease in the villages of Lebowa.

The territory's director of Health, Dr A M Makubane, has pointed out that people die and are buried at home, without going to hospital and without having post mortems to establish causes of death. In addition, the long latency period for the asbestos-associated cancer of the lung lining, mesothelioma — which can be up to 40 years — makes the actual effect of the dumps almost impossible to measure.

And for many of the people of the area, the problems of unemployment and starvation are more immediate than what they see as the far-off dangers of asbestos.

In May this year George Mogeles's farm was sold by Lagerdraai Asbestos, in which United States Steel has a major shareholding, to the South African Development Trust for R71 000.

Farther down the valley there are more men suffering from the disease. And more uncovered dumps.

Farther down the valley there are more men suffering from the disease. And more uncovered dumps.

Farther down the valley there are more men suffering from the disease. And more uncovered dumps.

## They don't know that they are doomed ...

Bewarkloof valley, where he now lives. An interpreter translated the old man's Tswana words. "He came with his boss, Hans van Wyk, from the Kimberley diamond mines in 1951. Hans van Wyk bought a small mine up there that one. "Those mines up there closed a long time ago. The men who worked them are dead. Many had phthisis. Hans van Wyk is dead. He had the same phthisis." All that is left of Lagerdraai's mining days are an old mill, asbestos dumps

FIFTEEN elderly men in the former asbestos mining areas of the North Eastern Transvaal interviewed last week all showed signs of suffering from asbestosis.

All had worked on the mines. Most had been compensated for the disease, while some did not know that their difficulty in walking without losing their breath, their rasping coughs and their hoarse voices probably meant they were suffering from the disease. One who was compensated is George Mogeles who — when asked about asbestos mining — supported himself with his stick and pointed to a row of worked-out mines in the mountains. He was standing near an old asbestos dump on the farm, Lagerdraai, in the

GEORGE MOGELE, an asbestosis sufferer, points to the mine in the mountains where he used to work. In the background is an old mill which is still littered

X



(217)

## Foskor miners strike

Staw Labour Reporter 24/10/89

About 2 000 workers at the Foskor phosphate mine outside Phalaborwa continued a two-day strike today in support of a shop steward who was suspended for allegedly sleeping on the job.

A spokesman for the National Union of Mineworkers (NUM), which claims a membership of 1 800 at the mine, confirmed that strike began early yesterday. Workers would continue their protest for as long as the shop steward remained suspended, he added. Union representatives and shaft stewards are negotiating with the mine management.

ADW 24/10/74 (210/213) (217)

## 2 000 phosphate workers out on strike

**Mail Reporter**

**MORE** than 2 000 workers at the Foskor phosphate mine near Phalaborwa in the Eastern Transvaal went out on strike yesterday.

A spokesman for the National Union of Mineworkers (NUM) said

the workers were striking over the alleged intimidation of union shop stewards by the company

The union spokesman said tension had been developing for some weeks before the workers elected to go out yesterday morn-

ing. No decision to go back to work had been taken yet.

He said the union was in the process of being recognised at the plant, where it claims a membership of 2 471, and that virtually the entire membership were out on strike.

The Rand Daily Mail was

unable to reach the company for comment yesterday evening.

Foskor, the full name of which is the Phosphate Development Corporation, is a quasi-state company set up by the Industrial Development Corporation.



ABM 25/10/84 (217)

# Shock asbestos dust figures

By PHILLIP VAN NIEKERK  
A SAMPLE from the Government Mining Engineer's (GME's) dust survey in the area of abandoned asbestos dumps in the North Eastern Transvaal far exceeded the GME's own recommended limit for the environment

This contradicts a statement by the GME, Mr S P Badenhorst, to the Rand Daily Mail several weeks ago that, on the basis of the survey, fibre pollution was low.

The sample readings were revealed this week by Mr L W Isserow, chief inspector of mines in the air quality section, when he answered questions at the Council for Scientific and

Industrial Research's conference on air pollution

Mr Isserow said that out of six samples of the general atmosphere in the area, most were around the GME's limit of 20 000 fibres per cubic metre while one was "quite a lot higher"

The 20 000 fibres a cubic metre readings — a fibre count which in some countries is regarded as unsafe for the general atmosphere — are in a densely populated area

In a recent paper, Dr R S du Toit, of the GME's air quality section, pointed out that a figure of 1 000 fibres per cubic metre — 20 times smaller than these counts — had been recommended

by experts as a safe level. And a count of 11 000 fibres per cubic metre at a mine hostel was described by Mr D J Selles, the environmental engineer of the Griqualand Exploration and Finance Company (Gefco), at the conference as "very high".

Both Mr Isserow and Mr Selles presented papers — one of them jointly — to the conference

The papers set out to show that fibre levels in the air at and around asbestos mines had improved substantially and compared favourably with conditions in other countries

Mr Selles said "Although we are accused of polluting

the air, the picture is not so bad and we compare favourably with overseas"

Out of six samples taken 100 metres away from an asbestos mill, two showed exceptionally high counts — one of 600 000 fibres and another of 300 000 fibres a cubic metre

Although the paper said this could have been caused by a "still unprotected tailings dump" in line with the mill, Mr Selles conceded at question time that it was most likely caused by the mill

The paper said "high" readings in some mine hostels were caused by "workers who still disregard company rules on hygiene"

Morning 30/11/84 (21) (22) (27)

# Safety limit key to survival of asbestos industry

JOHANNESBURG— The most important aspect of the asbestos health issue is the establishment of a scientifically-determined threshold for the safe use of the mineral, Mr Luther Jooste, chairman of the South African Asbestos Producers' Advisory Committee, said yesterday

Mr Jooste, addressing the Asbestos International Association here, said it was essential to the survival of the asbestos industry that permissible safety limits should be based on the 'threshold concept', and not on the notion that the 'only safe limit is zero'

The three-day session is being attended by more than 100 delegates from 17 countries. It will focus on the latest developments in asbestos dust measurement techniques, as well as biological results of the latest experiments on asbestos dust exposure

'The result of this lack of precision is evident today in the uncertainty and variations in limit values proposed or already in force throughout the world

'The approach of "when in doubt, play safe" has had a marked effect on regulations and while we

fully support this approach as a temporary necessity, it would be a sad loss to mankind if the benefits of a better quality of life arising from the use of asbestos were to be denied to millions of people for lack of a solid scientific basis for limit setting' — (Sapa)

## Health

'There are indications that the epigenetic character of asbestos will find general acceptance in the near future and this would mean that a reasonable threshold limit could be established,' Mr Jooste said

Mr Jooste said it was unfortunate that the standard dust measurement procedure in use was not available 20 to 40 years ago

'All the limit values being applied today are based on health problems stemming from exposures many years ago when exposure levels either were not, or could not be recorded, or where techniques used were unscientific and therefore completely unreliable,' he said



# Asbestos may not be cause of cancer — expert

By PHILLIP VAN NIEKERK  
ASBESTOS might not initiate cancer — it might only promote it.

This was said by Professor E Beck, director of the Hygiene Institute of the Justus Liebig University of Giessen in West Germany, at the conference of the Asbestos International Association in Johannesburg this week.

The association is made up of asbestos producers, whose industry is being threatened by a growing anti-asbestos lobby concerned over the health effects of the substance.

Prof Beck said. "So far there is no concrete evidence that asbestos is an

initiator of lung tumours, and there is increasing evidence that it acts only as a promoter"

He said fibres posed a risk only when they were inhaled and were of no significance when taken in with liquids or food.

Research was still required to provide conclusive answers to a number of questions relating to asbestos and health

These included the significance of the size and chemical properties of fibres, whether a single fibre was enough to cause a tumour and whether there was a specific fibre concentration beyond which there was no risk.

RDM 1/11/84 (217)

## Asbestos-cancer link 'firm'

By PHILLIP VAN NIEKERK

IT WAS "playing with words" to say asbestos only promoted and did not initiate cancer, says Dr Jonny Myers, of the University of Cape Town's Industrial Health group.

Dr Myers said there was conclusive evidence to show asbestos was closely linked to various forms of lung cancer as well as a number of other cancers.

He was responding to claims by Professor E Beck, director of the Hygiene Institute of the Justus Liebig University of Gies-sen in West Germany, that there was no concrete evidence that asbestos was an initiator of lung tumours.

Prof Beck told the conference of the

Asbestos International Association in Johannesburg that there was increasing evidence that asbestos acted only as a promoter of cancer.

But Dr Myers said the link between asbestos and cancer was as clear and as medically beyond doubt as that between smoking and cancer.

It was a "dubious distinction" to say asbestos did not "initiate" cancer.

Dr Myers also rejected a claim by Prof Beck that asbestos fibres only posed a risk when they were inhaled.

"Some studies have shown that ingesting asbestos fibres leads to cancer of the organs of the digestive system," he said.



5/11/94

# Bamcwu steps up asbestos campaign

217

THE BLACK Allied Mining and Construction Workers Union (Bamcwu) has reaffirmed its commitment to the closing down of asbestos mines in South Africa

This assurance was

## SOWETAN REPORTER

given to The SOWETAN yesterday by the union's publicity secretary, Mr Motshumi Mokhina, who said they will intensify their anti-asbestos

campaign

He was reacting to a conference that was called by the South African Asbestos Producers Advisory Committee and the Asbestos Inter-

national Association in Johannesburg last week

The union said that the conference was a step to draw attention away from the campaign, which was gaining momentum in most parts of the country

## World's richest find could jolt SA

# Canada in position to rule uranium market

(217)

Star

8/11/80

By Bill Levitt

A Canadian uranium find reputed to be the world's richest has jolted the already sagging industry and may damage South African producers, says a representative of Nuexco, a California-based mineral broking and consulting firm

South Africa is now the world's second largest producer but "Canada will control the market and make a lot of money," says Mr Chris von Christierson, whose firm sets the monthly world spot price for the mineral. "Canada will be able to cut the market and get most of the business"

Mr David Sinclair-Smith, GM of the Nuclear Fuels Corporation which markets uranium for the Chamber of Mines, did not dispute the richness of the find. Although he refused to discuss the matter in detail, he said the Canadian case may have been "over-emphasised".

The Canadian project engineers must still figure out how to mine it and then get it on stream, but he admitted that "we clearly do not welcome a high-grade-deposit of that size"

The development of the Cigar Lake deposit in Saskatchewan

— estimated to contain more than 100 million kilograms — comes when worldwide demand is at record lows and output continues to exceed consumption as US utilities that have ceased operations liquidate inventories.

To make matters worse, the spot price has dropped to \$16 a pound from last month's \$17.50 and could fall as low as \$13 in the next few months — placing SA producers in a tight squeeze, said Mr von Christierson

SA companies prefer long-term contracts at higher prices and, with demand low, have been stockpiling what they cannot sell under high interest rate conditions. Industry sources estimate SA has about one year's supply stockpiled, which amounts to over 14 million pounds

But their contracts are re-negotiated each year and the sagging spot price — which peaked at \$43.40 a pound in mid-1978 — could force lower prices and reduced revenues, Mr von Christierson said in an interview

SA companies have traditionally been reluctant to sell on the cheaper spot market because of the "feedback effect" where

countries on longer contract resent seeing SA uranium being sold at cut rates.

But Mr von Christierson said Nuexco's view is that SA's traditional customers might use the spot price ruthlessly to get concessions on contracts anyway

South Africa's existing markets are fast becoming fully supplied and producers here will soon have to decide whether to sell in the US, where most of the new business lies at low spot-related prices.

The alternatives include longer-term contracts with the US, stockpiling or closing high cost facilities as — Gencor did recently with its Beisa mine in the Free State Goldfields.

If South Africa waits too long, the spot price will be too depressed and the Canadian uranium will be available for the highly competitive US market — factors which could adversely affect SA producers

The rich Canadian uranium can be produced cheaper — although industry sources could not say by how much — than SA gold and copper mines that get uranium as a byproduct.



### 217 ###

# Death in the walls of a rural home

*D. D. Ruffen* 21/11/84

MAFEFE — The man seems proud of his almost-complete thatched home in the remote mountains of Lebowa and oblivious to the possibility it could turn into his family's death chamber

The round hut is plastered with asbestos waste, dumped by mining companies in the middle of black communities as developed countries grow increasingly fearful about the health hazards of the mineral

"The thatch and asbestos are strong, the house will last for 20 years," the man said as he put the finishing touches to the hut.

Medical opinion is that in 20 years his family, constantly exposed to the fibrous material, could be fighting a losing battle against lung cancer

The numerous dumps littering the lush countryside are the target of environmentalists who accuse mining companies, among them until recently multinationals based in the United States and Britain, of disregard for the life of blacks in the impoverished homeland

The Black Allied Mining and Construction Workers' Union (Bamcuru) has launched a campaign to close the entire asbestos industry

in South Africa, saying hundreds of miners have died of asbestos-related diseases

The union, supported by medical experts, said that though official statistics were being kept under wraps, many more residents of mining communities had suffered lung damage caused by the mineral

Research over the past 20 years has established direct links between inhalation of asbestos fibre and lung cancer and developed nations have ordered massive reductions in its use

In Lebowa, mining continues and uncovered dumps are still used by villagers to build homes and pave roads

South Africa, which sold 187 000 tons last year, is the world's third largest asbestos producer after the Soviet Union and Canada

Health organisations say up to 200 000 blacks live dangerously close to mines in Lebowa and that measures taken so far are insufficient to cope with the problem

In Krom Ellenboog, 500 children study at a primary school in the shadow of a huge dump created by the now-abandoned mining process

Local villagers say the only attempt to remove health hazards was

advice that the school's playground be hosed every morning to reduce the amount of dust. Water pumps have been out of order for weeks

Mr Pat Hart, managing director of Gefco, which bought the dormant mine in 1981, said his company had embarked on a programme to eradicate the danger

"I expect the dump will be completely covered within a couple of months," he said

Elsewhere in Lebowa, local chiefs have instructed brick producers to stop using asbestos, traditionally a major source of building material — and the cost of building houses has risen dramatically

For the local population, struggling to eke a meagre living in the under-developed area and more concerned with feeding families today than with health problems many years away, the campaign against asbestos poses a dilemma

In an area with high unemployment, people are reluctant to see jobs lost because of scientific evidence many of them cannot understand

Mr Pandelani Nefolovhodwe, secretary-general of the union, says economic considerations should be removed from the debate about asbestos "The choice we have is between jobs and life" — SAPA/RNS

# Plan to overgrow asbestos dumps

By Gavin Engelbrecht

The Griqualand Exploration and Finance Company (Gefco) has approached ecological experts at Potchefstroom University for advice on covering its asbestos mine dumps with vegetation

The managing director of Gefco, Mr H P Hart, confirmed last week that Gefco was entering into a consultation agreement with the university's Institute for Ecological Research

The move by Gefco comes in the wake of widespread publicity concerning the health hazards of abandoned dumps in the North-eastern Transvaal and Northern Cape

Mr Hart said the request for research had nothing to do with the controversy but was part of Gefco's policy of covering all its dumps — many of them inherited in a takeover

Mr Hart added that Gefco's immediate priority would be the covering of dumps near settlements in the North-eastern Transvaal and Northern Cape.

A spokesman for the Ecological Research Institute said that all the dumps had been visited and assessed.

Experiments with various grass strains, fertilisers and other plants would be carried out but he could not say when research would be completed.



30/11/84 (217)

## Support for asbestos campaign

ALL OF THE seven black unregistered trade unions which formed an alliance to help each other, have supported a campaign by the Black Allied Mining and Construction Workers'

Union to ban asbestos mines in South Africa

The alliance's co-ordinator, Mr Phandelani Nefolovhodwe, told The SOWETAN after a meeting that the unions have agreed to inform and advise their members about the campaign, which was gaining momentum

The campaign was launched by Bamcwu following numerous incidents of people who died or contracted asbestosis in the mines, espe-

cially at Penge in the Northern Transvaal

Union sources have argued that most miners who went on retirement after working at these mines were lowly paid or received very little money in terms of the Workmen's Compensation Act

They also contended that white miners received large sums of money whereas the black, who do most of the work at these mines, received only a pittance

# Asbestos-plagued school to be moved

By PHILLIP VAN NIEKERK

A SCHOOL housed in an old hostel next to an abandoned asbestos mine in the north-eastern Transvaal — and found to be contaminated by deadly fibres — is being moved to a new site.

The Griqualand Exploration and Finance Company (Gefco) announced this yesterday.

The school — which the Rand Daily Mail found to be contaminated by deadly asbestos fibres in the ground, air and buildings when it first publicised its existence five months ago — is situated at Kromelmsboog, which is owned by Gefco.

In a Press release yesterday, Mr Pat Hart, Gefco's managing director, said the removal of the school had been decided upon with the agreement of the

Lebowa authorities

The company has decided to demolish the buildings, some of which are made of asbestos, from the beginning of the December holiday, and to cover the nearby asbestos dump and the surrounding area.

Construction of a new school, being built to Lebowa Education Department standards has already started on a site off the mine property, the statement said.

Gefco said it was assisting the school committee in the supervision of the new project, and would provide free building materials and skilled labour.

Mr Hart said the school was already housed in the hostel when Gefco bought Penge Mine from the previous owners, Transvaal Consolidated Lands, in 1981.

"We did not regard the situation we had inherited as ideal," he said, "but having taken a number of additional safety measures, and having satisfied ourselves through dust surveys that the proximity of the hostel to the dump presented no real threat to the health of the 500 pupils, we allowed it to continue."

● Gefco was yesterday condemned by the Black Allied Mining and Construction Workers' Union (Bamcwu), which has called a national anti-asbestos conference early next year to press for the closure of all South African asbestos mines.

Bamcwu said unless Gefco accepted that labour leaders had a right to represent their members in matters affecting their health and safety, such "unilateral" good intentions would not bear fruit.



Parents remove sheets of asbestos roofing from the primary school, situated at a disused mine at Kromelmsboog, which is being demolished and rebuilt at another site off the mine property

DISCUSSURE O



Star 14/12/84 (217) (22)

By Kashvina Jaga

Asbestos will no longer pose a health hazard to 500 schoolchildren who study in the shadow of the dormant Kromellenboog asbestos mine, near Penge Mine in the Eastern Transvaal

The school, previously housed in old mining quarters, is being moved and rebuilt at a site about 2 km away from the asbestos mine, said Mr Pat Hart, managing director of Griqualand Exploration and Finance Company (Gefco)

Gefco took over the mine in 1981 when the school had already been established

Mr Hart said it was decided to move the school as its site was obviously undesirable in the long term

The decision comes

# Children to be freed from asbestos hazard

only months after *The Star* highlighted the environmental health hazard posed by disused asbestos dumps in the North Eastern Transvaal

Asbestosis (a crippling lung disease), mesothelioma (a cancer of the lung lining), and lung cancer are three of the possible effects of inhalation of fine asbestos fibres

Because the diseases become manifest only after a period of 20 to 30 years, the seriousness of exposure to asbestos dust

is not commonly realised in the rural areas

The new school will be ready for the 1985 school term and is being rebuilt conforming to the Lebowa education department's regulations

Labour and building materials will be provided by the General Mining Corporation (Gencor), said Mr Hart

He said a constructive clean-up programme at the Penge Mine and surrounding areas was virtually complete, and the

company was now concentrating on the dormant mines

"Kromellenboog, being such a mine, is receiving top priority" The extensive safety measures already in operation at the Penge Mine mill and village have reduced the dust levels to below the legal limit of two fibres per millilitre of air, said Mr Hart

These measures include

- Wet mining methods
- Ore washing plant

● Improved dust extraction and pneumatic fibre conveying in the mill

● Dust-proof packing

● Constant monitoring and the use of respirators in emergencies and when dust is created during repair or maintenance

Mr Hart said that, although health risks associated with asbestos could be controlled with proper care and attention, the need to examine means of further reducing the risk could not be over-emphasised

# MINING — OTHER

1985

studio couch covers and component parts; etc.			
Assembling, knocking or hooking on woven wire mesh and chain spring meshes to frames for bedding; etc.			
Slipstitching, sewing and / or joining covers, etc.		11	F
Application and/or spreading of glue and glue hardeners by hand, brush or machine; etc		13	G
Construction of spring interiors and/or spring units and the manufacture of their component parts.	14	(9)	H
4. NES Refers to employees not elsewhere specified.			
5. Office Empl Until March 1974 qualifying period 5 years for males and four years for females. Thereafter no experience specified.			
6. Operation G (1) Refers to labourers.			
7. Operation G (2) Refers to boiler attendant.			
8. Packer Becomes part of operation G from February 1976 agreement.			
9. Parties to Agreement National Association of Furniture and Allied Workers of South Africa also party to agreement until May 1982.			
10. Removal of Sex Differentiation From March 1974 no wage differential for male and female office employees.			
11. Storeman Includes timekeeper.			
12. Watchman Includes caretaker.			



# Council of Unions urges asbestos mining ban

By Carolyn Dempster,  
Labour Reporter

The 150 000-member Council of Unions of South Africa (Cusa) has thrown its support behind the campaign to ban asbestos mining and manufacture in South Africa

The campaign was launched by the Black Allied Mining and Construction Workers' Union last year after it was re-

vealed that thousands of Lebowa residents and mineworkers in the North Eastern Transvaal asbestos mining region of the Strydpoortberge were at risk.

Inhalation of fine asbestos fibres in the form of asbestos dust can result in the crippling lung disease asbestosis, the fatal and rare cancer of the lung lining, mesothelioma, and lung cancer.

The old disused dumps in the NE Transvaal pose a severe health hazard to the local community, who, *The Star* found, were using the waste asbestos material to make bricks

It was also established that dust levels during 1980 to 1982 often exceeded the safety limits recommended by the Government Mining Engineer.

In the latest issue of *Izwilethu*, the Cusa newsletter, the union federation states that the campaign to ban asbestos in South Africa "cannot be dismissed as a case of political opportunism. Asbestos has already ruined the lives of many people".

Official statistics compiled by the Medical Bureau for Occupational Diseases reveal that

there were 5 140 asbestosis victims between 1967 and 1983, 212 compensated cases of mesothelioma and 57 cases of bronchogenic carcinoma

But because the asbestos-related diseases take between 20 to 30 years before the symptoms become manifest, Government and health officers admit that the official records are unreliable indicators of the full extent of the health hazard

**LETTERS**

The Editor, Rand Daily Mail,  
Box 1138, Johannesburg 2000

RAM 17/1/85 (217) ~~131~~ ~~212~~ ~~85~~  
**Asbestos — lack of  
concern for public**

IN a letter published on December 21, Mr L B Lewis, the Marketing Manager of Everite Ltd, a large asbestos product company, has once again underrated the deadly hazards associated with this mineral.

Mr Lewis claims that asbestos cement products do not liberate significant amounts of respirable fibres

Numerous studies show that the effects of the weather, pollutants such as acid rain and handling of the products do cause considerable fibre release

For example, a concentration of 1 000 fibres per cubic metre was measured in the surrounding air of a wall faced with asbestos cement tiles (Studies in Environmental Science Vol 8).

Secondly Mr Lewis remarks that, in the photograph, the removal of the asbestos roofing from the Kromellemboog school is being done under adequate supervision. This comment further shows the lack of concern for the South African public displayed by the asbestos industry

The only supervision shown are two men wearing overalls. No equipment for dust

level measurement can be seen nor are any of the standard safety precautions visible

While moving the school is welcomed the ongoing presence of a large asbestos dump remains a health hazard for the nearby communities

Finally Mr Lewis claims that consumers of asbestos products are encouraged not to do their own cutting or drilling, however there is little consumer warning of the health hazards associated with asbestos.

Nowhere in two of the catalogues issued by Everite — "A Guide to (asbestos) Container Gardening" and "Handmade (asbestos) Plant Containers" — is mention made of how deadly this dust can be

The barest minimum exposure to asbestos can kill. A recent tragic example involved two sisters who both developed an asbestos cancer after cleaning a white asbestos cement roof (BMJ June 1984)

Evaluation of all available human data provides no evidence for a threshold for a "safe" level of asbestos exposure (US Department of Labour) — ASBESTOS RESEARCH GROUP, Berea, Johannesburg



# Black Mountain star of GFSA base metal mines

217  
22/11/85  
CAPE TOWN

**Own Correspondent**  
JOHANNESBURG — Black Mountain Mineral Development was the star of the GFSA base metal mines in the December quarter with a 43 percent rise in net profit.

Production and sales of lead rose strongly and sales of zinc were higher.

Sales revenue jumped 25 percent to R34,652m (R27,806m) and costs of sales were up 26 percent resulting, after lower finance costs of R4,190m (R5,102m) in net profit of R11,687m (R8,142m).

Total borrowings at December 31 had been reduced to R65m (R72,110m).

**Apex Mines:** Sales were higher with sales revenue up at R16,185m (R15,066m).

Other coal mining revenue dropped to R832 000 (R2,453m). This included a loss of R706 000 incurred in the year at Middelburg Steam. After lower tax, net profit rose to R5,270m (R3,929m).

Earnings a share after capex were 118c (123c).

**Clydesdale Collieries.** Results were marginally down after lower production and sales. Sales revenue was virtually unchanged but costs of sales were higher and after-tax profit was down at R2,951m (R3,520m).

**O'okiep Copper:** With GFSA taking over management from Newmont Mining, the company has issued a quarterly report for the first time.

The results show a great switch of nearly R8m from profit in the September quarter to a loss in December.

Tonnage milled dropped to 322 210 (361 970) and copper recovery in concentrates was therefore down at 4 795 tons (5 412 tons).

Although sales of blister copper were virtually unchanged, sales revenue rose to R13,757m (R12,345m) but an unexplained rise in costs of sales to R16,108m (R12,842m) resulted in a working loss of R2,351m (loss of R497 000).

Sundry revenue dropped sharply to R1,105m (R6,766m) and the company sustained a net loss of R3,217m against a profit of R4,734m in September.

Loans repaid dropped to R16,050m (R54,648m) but loans raised were only R3,175m (R48,317m).

Outstanding loans totalled R39,445m, a reduction of R12,875m.

# Palamin lifts profits 76% — dividend soars

By BRENDAN RYAN *one time 14/2/85*

**JOHANNESBURG.** — Palabora Mining's taxed profit before extraordinary items soared 76 percent to R56,169m for the year to December from R31,943m the previous year.

The final dividend has been increased by 82 percent to 50c a share (previous final 27,5c) which nearly doubles the total distribution for the year to 110c (60c)

The extraordinary item was a R9,8m deferred tax rate adjustment which brought profit after extraordinary items down to R46,465m from R31,943m the previous year

## Share price

Palamin's results justify the run-up in the share price on the Johannesburg Stock Exchange over the last six weeks from about R14,5 at the start of January to yesterday's closing price on the Johannesburg Stock Exchange of R18

The managing director, Mr Al Leroy yesterday attributed the improved results to three factors

"The first is the beneficial effect of the depreciation of the rand on our sales revenues

"Secondly our working

costs were held down because the increase in the amount of waste stripping in the pit was capitalized. These costs will be capitalized until 1992 and then written off over the next seven years

## Exchange losses

"Finally, Palamin had another successful year in controlling costs. The electrified haulage system allowed direct energy savings of R8,4m last year," Mr Leroy said

The results show that Palamin's interest payable and foreign exchange losses on loans more than doubled to R17,768m from R8,428m the previous year while Palamin also made foreign exchange trading profits of R3,418m (1983 nil)

The loans have been raised to finance the widening of the open pit which, from 1992 to 2000, is expected to produce a further 833 000 tons of copper which would not otherwise have been

mined by open cast methods

Peak borrowings for this project should be reached in 1988

Mr Leroy said he was not perturbed by the forex losses because the company was "self-insured" as its sales were denominated in dollars or pounds sterling

He said the foreign exchange profits had "just happened" because of timing and the company did not speculate in the foreign currency markets

Palamin does not take forward cover on its expected export revenues

## Prospects

Mr Leroy said there was a shortage of copper metal on world markets at the moment and the prospects were that this could continue and 1985 could therefore be a reasonable year for copper

He said, however, that prospects for Palamin in particular depended on a number of factors

"We already know costs are going up but we don't know for sure that the copper price will as well," he said

Comment Palamin has proved once again why it is rated as perhaps the finest copper company in the world in which investors can buy shares

Palamin has made profits when other major producers have gone to the wall or been nationalized and kept going by governments for foreign exchange reasons in spite of the huge losses run up by the operations

Palamin's share price may well advance further from its present levels

The life of the mine as an opencast operation is slated to go to 2000 but management is already looking at the feasibility of extending it beyond that

When the pit can no longer be enlarged then management will have to consider mining the deposit through underground methods



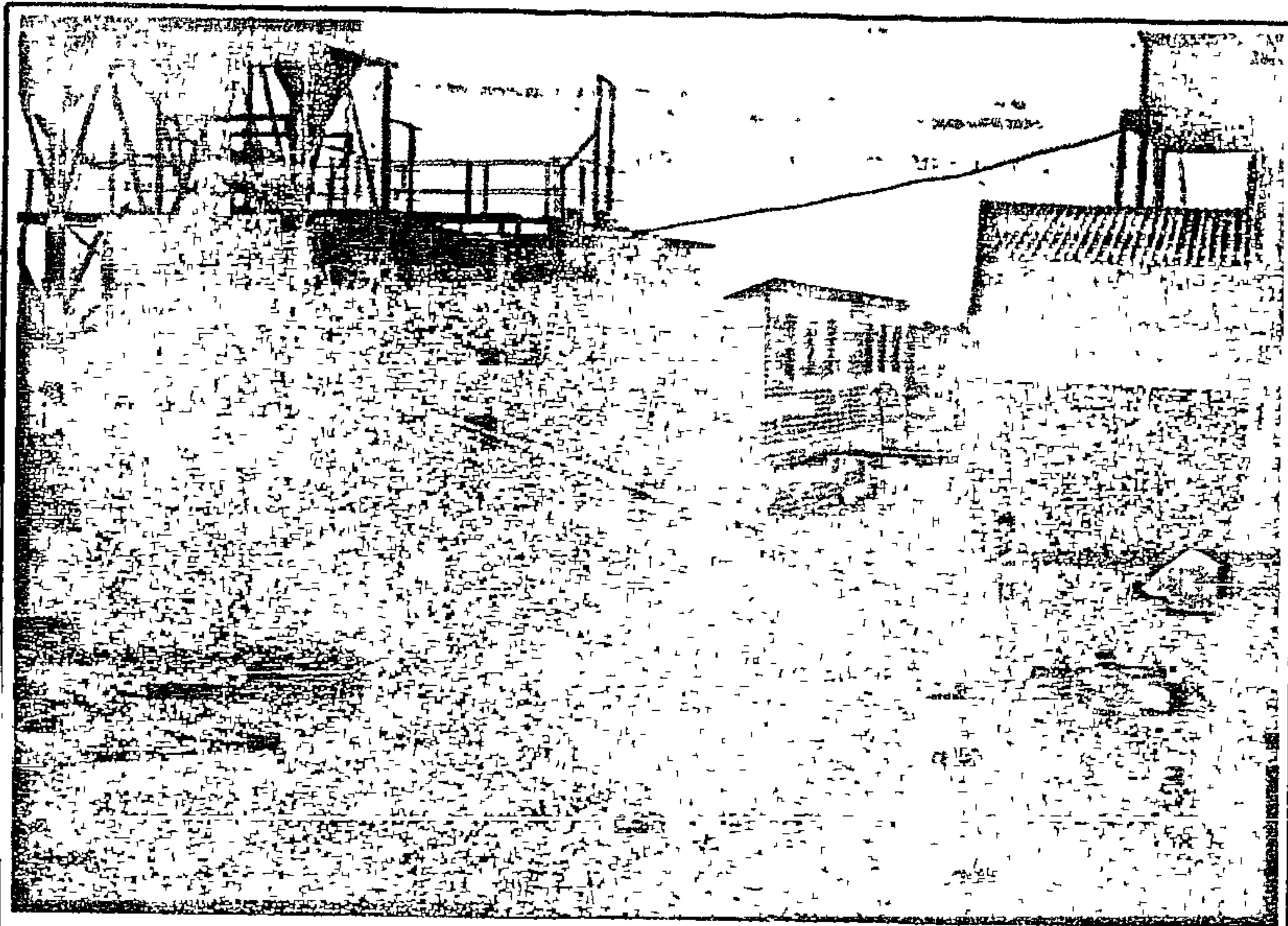

Not much like the entrance to Sun City ... but the money gambled on Bophuthatswana's first proper gold mine rivals any of the table stakes at the Pilansberg casino

# Bophuthatswana strikes more than Sun City gold

*217 S. Times 24/3/85*

**BOPHUTHATSWANA will soon get another gold mine — the first was Sun City.**

The mine is 40km west of Brits and is close to the platinum mines in the Rustenburg area.

Developer of the mine, Anthony Pannous, is the owner and managing director of a group of Volkswagen dealerships in the Western Transvaal.

Approval to explore the farm Waarkraal and the Old Waarkraal mine workings for mineral deposits was obtained by Mr Pannous from the Bophuthatswana Government in 1982.

Mr Pannous claims that gold yielding a gram a ton was found in the soils. Extensive underground exploration produced values of 38g/t, which will mill down to an average of 9g/t.

Assaying of the ore was carried out by one of the major mining houses, says Mr Pannous. He will not name the house.

Additional options were granted to Mr Pannous by the owners of the Old Waarkraal mine for underground exploitation, and for the mineral rights on the farms Losperfontein and Berseba.

The area under these options measures 10 000 hectares, says Mr Pannous.

By Roy Bennetts

The Old Waarkraal mine was worked by Bushveld Gold Mines, but closed in 1938 when the fixed gold price failed to match production costs.

The new mine, which will trade under the name of Bethany Mining & Exploration, is in a remote area of the Bushveld. It will mine the Bushveld Reef.

## Capital needs

Mr Pannous says the expected capital expenditure of R10-million has been exceeded by a large amount because of the need to build a road to the workings and a dam wall in the nearby river.

Electricity and a graded surface runway, as well as surface and underground equipment, have thrown the original development budget way out of balance.

Mr Pannous says 85% of this expenditure has come from his pocket and the rest from banks loans.

He puts the break-up value of the mine's assets at between R30-million and R40-million.

The management contract of the

mine has been awarded to Pieter Nel, managing director of Geocapro Services in Klerksdorp.

Gold recovery will begin with the soils at the Waarkraal mine and then a system of winch-stopping will be used to gain the underground ore.

If this is successful, work will start at Losperfontein and Berseba.

Milling rate for the soils is planned at between 20 000 and 30 000 tons in the first two months and will increase by 20% in the following months.

Milling of the underground ore is planned at 20 000 tons a month in the initial stage.

Mr Pannous says the mine will not be listed, but he will make an offer of partnership to interested parties.

Attorney for any transaction regarding the mine is said by Mr Pannous to be Piet Scholtz, of Orkney.

Reopening of the Old Waarkraal mine follows the trend set by Egoli with its Waverley and Minador mines, Golden Dumps and its highly successful Cons Modder and Cyril Heever's plans to reopen the Modder B mine.

Although the big boys continue to bemoan their lot, entrepreneurs are sneaking in under their lofty gaze, and should be able to make a killing when the price of gold swings upward.

h 24, 1985

# Lean burn good for SA platinum

217 S-Twist  
24/3/85

SOUTH African platinum producers are relying on increased production more than higher prices to raise revenue.

Platinum dealers and analysts say the mines have raised production to meet demand. Higher output and large stocks in the hands of platinum users and speculators, however, have lowered prices and platinum is about a 15% discount to gold. It normally trades at a premium.

## Rapidly

Platinum sources estimated that output of the South African producers Rustenburg, Impala and Western rose from about 1.7-million ounces in 1983 to 2.15-million ounces this year.

Rosemary van Muschen-

By Neil Behrmann, London

broek, a precious-metals analyst with a US commodities merchant, says "South African producers have learnt to match demand with supply. But there are more than 1-million ounces of metal in the hands of international dealers and speculators. Platinum users are also carrying large stocks."

A platinum dealer says that the market could turn around rapidly as the dollar falls. Industrial demand is brisk. Japanese imports, for example, rose from 942,000 ounces in 1983 to 1.18-million ounces last year and in January imports were 148,000 ounces.

Platinum is flagging even though dealers expect a new wave of demand from the European motor industry from the late 1980s. They be-

lieve that other European motor industries will follow West Germany's example and begin introducing catalytic converters containing platinum, rhodium and palladium to clean motor exhaust fumes.

## Divided

But European Economic Community environment ministers are divided on the timing of the measures and technology to purify exhaust fumes. They have agreed that clean air standards matching those in the United States could apply for vehicles of more than two litres engine capacity from the end of 1988.

In the medium range, which accounts for most European sales, West Germany is prepared to accept a delay until October 1990. But Britain, backed by Belgium, objects to the timing.

Britain wants to introduce a "lean-burn" engine which will reduce noxious exhaust fumes.

But platinum agents say that cars with lean-burn engines would still need platinum catalysts to meet US anti-pollution standards.

"It is a feeling of déjà vu,"

Brian Nathan, managing director of Ayrton Metals, platinum merchant and a subsidiary of Impala Platinum, says "They talked about lean-burn engines in the United States 10 years ago, but where are they?"

"The US motor industry argued for about three to five years, but eventually they introduced catalysts containing platinum group metals."

Other platinum dealers expect West Germany to go ahead with its anti-pollution plans. Austria, Switzerland, Sweden, Norway, Denmark and the Netherlands intend to follow Germany.

A platinum dealer says "The German car market is huge. If British, French and Italian car manufacturers want to sell vehicles there they will have to begin introducing cars with catalysts. When this happens, they will have to go all the way. Production of the types of cars will be uneconomic."

"In the United States, for example, California was the first to introduce car catalysts and manufacturers soon followed in other states."

Peter Emmell, general manager of Johnson Matthey Chemicals auto catalyst division, is confident that the European motor industry will be using 500,000 ounces of platinum group metals by the early 1990s.



# My life with death

By Arlene Getz

DOT WILSON was seven when she and her family moved to an asbestos mining town in the Northern Cape

Today she is a 34-year-old Pretoria mother — dying because her family made that move in 1958

Mrs Wilson is suffering from mesothelioma, an incurable cancer caused by her exposure to asbestos as a child in the mining towns of Koegas and Pomfret

A vivacious secretary, she knows exactly what this diagnosis means

Only four months ago her mother died after a painful battle with the same disease. The previous year her father died from lung cancer with underlying asbestosis, another asbestos-related disease

"I feel very bitter," Mrs Wilson said in Johannesburg this week

Speaking after a Press conference to launch Asbesta, a research group aimed at helping other victims of asbestos-related diseases and campaigning against the use of asbestos, Mrs Wilson told of her battle against her illness

In December 1980 fluid began to build up in one of her lungs. A biopsy was performed and she was told she had tuberculosis. A year of treatment followed, but she failed to respond to the medication

Eventually mesothelioma was diagnosed and Mrs Wilson underwent a major operation to remove the lining of her affected lung

She knew, however, this was not likely to help. Most mesothelioma victims die within two years, and Mrs Wilson considers herself lucky to be alive three years after diagnosis

"I've been a lucky patient," she said. She has chemotherapy every three weeks



■ Dot Wilson (left) and Ina Penderis with a sample of the asbestos-bearing rock which has sentenced them to death ■ Asbestos victim Dot Wilson and her husband Rath ... behind the smiles lies tragedy

## Her parents died of the cancer caused by asbestos — now Dot Wilson waits her turn

Her hair has fallen out and she is losing weight, but she says she and her husband, Air Force technician Rath, derive comfort from their faith as reborn Christians

"One must try and live with it," said Rath, his eyes clouding over as he spoke

"It's very unfair, but my wife doesn't sit at home and mope"

Until two months ago the Wilsons played tennis regularly. They had to stop when Mrs Wilson found one game of tennis caused her three days of pain

"We've been open with our daughters about it," she said. Aged eight and ten, the girls had been brought up with the awareness that their mother was a dying cancer victim

Another founder member of Asbesta, Ina Penderis, also knows she is living on borrowed time

Now 42, she lived in the asbestos mining

towns of Koegas and Prieska since she was three

Unlike Mrs Wilson, who attended boarding schools and was only exposed to asbestos during her holidays, Ms Penderis came into direct contact with the substance

As a teenager, she helped weigh asbestos rocks at her parents' trading store and paid the miners who brought them in

Her mesothelioma — which followed the common pattern of taking years to surface — was diagnosed last May

The following month her affected lung and lung lining were removed

Her remaining lung is healthy, but the cancer is expected to resurface in another part of her body

With her days marked by a continuous struggle to breathe, Ms Penderis still works as a labora-

tory supervisor for a pharmaceutical company

The remaining asbestos sufferers in the group were too ill to attend this week's launch

Margeritha Kearney, 68, was "too old and sickly to attend anything any more", said Ms Penderis

Mrs Kearney's exposure to asbestos began when she moved to Kuruman in her late teens. The store in which she worked as a cashier bought cobbled asbestos from the local inhabitants

Close to the store was a shed in which asbestos fibre was manually removed from the ore

This exposure ended when Mrs Kearney moved to Johannesburg in 1936

The youngest founder of the group was Francois van der Heever, 28. The son of a doctor, his parents moved to Pomfret shortly after he was born

They lived there for four years and last year Mr van der Heever was also found to have mesothelioma

Too ill to work, the unmarried Mr van der Heever has had one lung removed and undergoes regular chemotherapy

A Gaborone father of two was the fifth sufferer to help form the group

Jacob Ramalepa, 39, went to school in a prefabricated building made of asbestos/cement bricks and worked near the subsidiary of an asbestos-processing company

His mesothelioma has affected the lining of his abdomen and he is receiving treatment

None of the group is entitled to compensation from the owners of the asbestos mines — which still operate in the north-western Cape and the north-eastern and eastern Transvaal — because they did not work in the mines themselves

"Miners are not the only people at risk," Ms Penderis stressed.

Families were equally vulnerable, she said, citing the British case of Millie Toms, who died from asbestosis caught from washing her husband's asbestos-containing clothes

Consumers were also in danger, as household products ranging from hair dryers to toasters to floor tiles all contained the deadly dust

Although such products as asbestos pots might be safe when new, exposure to the elements could chip or crack them, causing the release of thousands of invisible fibres

Brake pads also contained asbestos, said Ms Penderis

One school of thought in the United States believed one mechanic dies every day because of contact with asbestos-containing brake pads

"There are 3 000 uses

for asbestos in the world," said Ms Penderis. "We must encourage people to search for alternatives"

Ms Penderis was anxious to contact all sufferers of asbestos-related diseases in southern Africa

These diseases included asbestosis — a fibrosis of the lungs caused by considerable exposure to airborne asbestos — and mesothelioma, which could develop after limited exposure

• Victims and their friends and families should write to Asbesta, P O Box 479 Garsfontein, 0042, for further information

### AUTHORS WANTED BY N.Y. PUBLISHER

Leading subsidy book publisher seeks manuscripts of all types fiction, non-fiction, poetry, juvenile, scholarly and religious works, etc. New authors welcomed. Send for the free booklet J-55, Vantage Press, 516 W 34th St, New York N.Y. 10001



# BID TO CONTROL ASBESTOS POISON

By JOSHUA RABOROKA

report stresses  
Moreover, ILO comparisons of legislation and regulations in different countries covering work with asbestos show an extreme imbalance in the type, extent and string-

ency of measures taken  
All this underscores the urgent need for an attempt to create international standard based on the participation and constructive contributions of

representatives of government, employers and workers  
Bamcwu has welcomed the notion of the conference and says it will support any move aimed at fighting the killer disease

BAMCWU: Mr Phandellani Nefolohodwe

The report stresses the importance of technical control measures such as prevention of formation of dust, effective control of dissemination of dust at the site of its formation and adequate ventilation of the workplace.

Attention also must be given to the control of possible secondary sources of airborne asbestos, such as dust settling on surfaces in the working environment or contaminating work clothes.

Medical supervision of all workers is also essential.

Workers should be informed about the dangers of the mineral dust and should also participate actively in the application of protective measures, the

Over two-thirds is utilised in asbestos cement and their remainder as an ingredient for some 1 000 other industrial products.

"Why not replace this potentially dangerous substance by one which is harmless or less harmful? Or even better, why not ban asbestos in particularly hazardous conditions," the report says.

This view has been supported by Bamcwu in its campaign which is finally aimed at banning all asbestos mines in South Africa, according to the union's publicity secretary, Mr Motshumi Mokhele

## Hazards

The ILO report says such principles are generally accepted and put into practice whenever possible. But unfortunately no technologically suitable alternative materials have been suggested for the majority of industrial uses of asbestos.

The report notes that threshold limits vary from country to country as do methods of monitoring. The various methods need to be harmonised internationally in terms both of strategy and technique to ensure comparability in the establishment and implementation of basic protection measures

ing up around asbestos dumps also face death within the next 20 years from inhaling the mineral's fibres

The union has since started an anti-asbestos campaign which it claims has gained momentum when it was supported by most emerging black trade unions

In its bulletin, the ILO says that the risk of lung cancer has shown to be particularly high in cigarette smokers among workers exposed to asbestos.

"It is its insidious nature that makes the asbestos hazard particularly dreaded. The clinical signs or related diseases may develop many years after exposure to asbestos has ceased

Occupationally, millions of people are at risk of inhaling a significant amount of asbestos dust in their work. Such exposures occur mainly in asbestos mining, processing the mineral, manufacturing asbestos products, and demolitions or removal of insulation material containing asbestos," the report says.

The scope of the problem can be gauged by the rise in world production of asbestos which increased from 675 000 tons in 1940 to well over 5 million tons today.

THE International Labour Organisation is to propose new standards, specially designed to protect workers exposed to asbestos, against its harmful effects, when it meets in Geneva in June this year.

Asbestos dust has been identified as a cause not just of asbestosis, a crippling illness which harms the lungs, but also of bronchial cancer and of mesothelioma (cancer of the pleura and peritoneum), maladies which are usually fatal

In South Africa, trade unions have reacted strongly to the diseases which they claim have caused the deaths of many workers. They maintain that the occupational exposure to its dust may, in some instances, present a serious health hazard.

The general secretary of the Black Allied Mining and Construction Workers Union, Mr Phandellani Nefolohodwe, has claimed that hundreds of families close to asbestos dumps in rural northern Transvaal villages are ignorant of the possible death they face from inhaling asbestos fibres

## Crippling

Many are unaware of having already contracted the crippling lung disease and thousands of children grow-



CAT Traits 25/4/85 (217)

# Palabora maintains copper sales and production levels

Own Correspondent

JOHANNESBURG. — Palabora Mining's copper production and sales were virtually unchanged in the March quarter compared with the March quarter of 1984

Copper production was 30 647 tons (1984 March quarter 30 625 tons), while sales were 34 888 (34 811 tons)

However, production

was maintained only by a jump in ore milled to 7,122m tons (6,981m tons) because average grade dropped to 0,48 percent (0,53 percent)

Sales of other products show a sharp jump in magnetite to 23 694 tons (19 604 tons) but vermiculite sales dropped to 20 943 tons (42 735 tons)

Palabora sold a single shipment of 227,5 tons of uranium in the March quarter of 1984

The company sold no uranium in the March 1985 quarter and expects to sell only a single shipment in the fourth quarter of this year.

Recent moves in the copper price on the London Metal Exchange (LME) have been closely linked to currency fluctuations according to Mr G A Macmillan, the chairman of Palabora Copper

Addressing the general meeting in Johannesburg yesterday he said that since the end of 1984, the market had been extremely volatile with the cash copper price reaching a high of £1 303/ton on February 19 after having been R1 134 on January 3

"Market reaction has been predominantly linked to currency fluc-

tuations and, although the LME warehouse stocks are currently at their lowest levels since September 1974, the gradual strengthening of sterling against the dollar in recent weeks has seen cash copper prices receding off their higher levels and falling to £1 150/ton

"Also, for the first time in 12 years, base metal prices are in a material backwardation situation with the spread between cash copper quotations and the three-month quotations yesterday amounting to some £53/ton

"These two factors of low LME and Comex inventories, where stocks are standing at 32 percent and 55 percent respectively of the levels pertaining a year ago, and the price backwardation presently being experienced should, in themselves, be bullish for the copper market yet are outweighed by currency-dominated influences," Mr Macmillan said.

Turning to the shutdown of the two autogenous ore mills at the Palabora mine Mr Macmillan said it is anticipated both mills will be out of service for about 60 days

As a result the mine's milling rate will drop by about 30 percent in this period

"To maintain smelting and refining rates in the repair period existing stocks of concentrates are being drawn down and ore mining activity is being concentrated in the higher grade areas of the pit

"It is not anticipated that there will be any material reduction in the production of copper in 1985 provided the repairs are completed as planned

"Engineering studies have also been initiated to determine whether these repairs will provide a permanent solution to the problem or whether replacement shells will be required in the longer-term," he said

The mills were taken out of service in March when routine inspections revealed cracks in the shells

Mr Macmillan told the meeting that Palabora would not, as it usually does, declare the first interim dividend at the annual meeting

He said this was the result of the dates of company board meetings being rescheduled

(217) B Day  
3/5/85

# US group to sell stake in SA giant

US MINING group Phelps Dodge is putting its 44,6% stake in giant South African base metals producer Black Mountain on the market for about \$75m, according to a senior group source.

A deal could be resolved within the next two months.

A spokesman for Gold Fields of South Africa — which owns the remaining 55,4% of the equity — last night described Black Mountain as “the leading company of its kind in the world today”.

He added “Not too many base metal companies are making such profits”.

The mine was the star of the GFSA base metals mines in the December quarter with a 43% rise in net profit.

Sales revenue jumped by 25% to R34,7m for the period (1984 R27,8m) and net profit moved from R8m to R11,7m.

The chairman of Phelps Dodge, Mr George Munroe, said five “interested parties” — all groups outside the US — were looking to buy the interest in the north-west Cape mine.

According to mining industry observers, Phelps Dodge has been desperately short of cash for some time and is having a torrid time in the US copper market.

Mr Munroe declined to reveal the identities of the suitors or the price being asked, although he said that it was “well over R100m”.

He said Black Mountain had been an excellent undertaking from the beginning and had operationally always made good money.

By PATRICK McLOUGHLIN

His company discovered the ore body and in the late 1970s entered into an agreement with GFSA which then became majority stockholders and managers of the project.

“Black Mountain was highly geared from the start (initial development costs were pegged at about R190m) but when South African interest rates began rising it had a lot to cover.”

“It’s now making money so presumably that will be reflected in the price we get.”

Mr Munroe said that there was no question of GFSA — which in terms of the original shareholders’ agreement has first right of refusal — being able to match the offers of the other interested mining groups. But it was a question of GFSA’s evaluation of the selling price.

Asked if another South African mining house were among the suitors, Mr Munroe said “It’s possible”.

Mr Dru Gnodde, chairman of Black Mountain and deputy chairman of GFSA, said his group was not negotiating with Phelps Dodge, but was waiting for the group to “come to us”.

“Black Mountain has been in and out of profits for a long time. In the last two quarters it made just under R12m a quarter.”

“We would hope it will make significant profits this year if base metal prices remain where they are in rand terms,” he said.



# Ferro-chrome muscles into fourth place in mineral export league

Star 7/5/85 (18) 217

By Stan Kennedy

With South African exports of ferro-chrome reaching more than 800 000 tons last year — up from the 580 000 tons in the previous year — chrome has become the country's fourth largest export item after gold, platinum and coal

Given export prices of \$450 a ton, ferro-chrome exports were worth about R480 million. Coupled with exports of chrome ore worth about R50 million, total exports were probably valued at nearer R530 million

Writing in the Bank of Lisbon's *Economic Focus*, Professor Roger Gidlow says the on-going expansion in demand for stainless steel has important positive implications for ferro-chrome

South African producers are working at full capacity. With ferro-chrome prices likely to reach US 50c this year, together with the dramatic fall in the rand against the dollar, further expansion in the industry can be expected this year

He says ferro-chrome exports could well reach 900 000 tons. This would

yield about R675 million, even assuming an average price of \$450 a ton. With export of chrome ores expected to reach 1.2 million tons this year, at an average price of R50 a ton, total exports of ferro-chrome and chrome ores could be worth about R850 million this year

Production costs for chrome ores in South Africa are reputed to be the lowest in the world and at the current rate of mining of around 3.5 million tons a year, reserves are sufficient to last for centuries

In the case of ferro-chrome, electricity costs for production are a third lower than those in Japan and lower than in most parts of the world. At the

same time, ferro-chrome capacity is the largest in the world

Also used in basic steel-making is ferro-manganese of which South Africa is again a major producer

Manganese prices have improved slowly since 1983 and South African exports were probably about R365 million last year. Professor Gidlow sees a further rise in exports this year, if only because of the fall in the value of the rand against the dollar

Unlike the chrome producers, the manganese industry is not working at full capacity. In fact, some ferro-manganese facilities have been switched to the production of ferro-chrome

# World platinum demand surged 19% last year

From NEIL BEHRMANN

LONDON. — Western platinum demand surged by 19 percent to 2,59m ounces last year, but the rise in consumption was matched by higher output in South Africa and other platinum producing countries.

Executives of Johnson Matthey Plc said that speculative sales rather than production increases had kept platinum prices cheaper than gold. Platinum at \$279 is trading at a \$43 discount to gold, whereas in the past it stood at a premium.

"Industrial demand is good and the producers have easily placed their platinum," said Mr Alan Austin, the manager of Johnson Matthey's platinum department.

The poor price performance was "an enigma".

Gold was more popular because investors had bought it for thousands of years. But investors and speculators only began buying platinum in recent years and were selling the metal in a very small market.

Mr Austin estimates that total investment stocks at the New York Mercantile Exchange, precious metals vaults in

London, Zurich and elsewhere were around 1,25m ounces.

The platinum was being passed around like a football, he said, that was probably why the market remained weak.

"Sentiment remains obstinately bearish," said Mr David Viollet, director, platinum market at Johnson Matthey.

He believes that platinum should outperform gold.

Over and above its precious metals qualities, the metal has wide industrial uses, he said.

Europe, for example would need more platinum, palladium and rhodium catalytic converters from the late 80s onwards.

The converters would reduce noxious emissions from automobile exhaust pipes in line with stricter European Economic Community anti-pollution standards.

An extensive report by Johnson Matthey says that even without the coming wave from Europe, the platinum market is growing.

Western demand of platinum rose from 2,18m ounces in 1983 to 2,59m ounces last year, said the report. This compares with peak consumption of 2,85m ounces.

Recently Volkswagen announced that it would

choose platinum catalysts because it would take some years to perfect "lean burn" engine technology.

The report said that while demand improved producers, notably South African mines Rustenburg Platinum, Impala Platinum and Western Platinum, stepped up production by 22 percent to 2,31m ounces between the years 1981 to 1984.

Johnson Matthey executives disagreed with dealer reports that the Russians had stepped up platinum sales recently.

The report says that the United States and Japan account for 77 percent of the Western market. Placement of platinum in autocatalysts and jewellery was responsible for nearly 60 percent of consumption with Japanese manufacturing jewellers taking around a quarter of platinum used in the West.

## Van Leer profits soar 34%

JOHANNESBURG — Royal Packaging Industries Van Leer BV, the Netherlands packaging group with operations in South Africa, increased

**FABULOUS CALAMARI**  
**METROPOLE HOTEL**  
38 LONG STREET  
TELEPHONE 23 6363



FORCED REMOVALS

**Courts pre-empted**

217

In a move likely to spark a major political row, Parliament has been asked to approve a measure which could retroactively endorse the forced removal last year of a black community and effectively negate a pending Appeal Court judgment which might have embarrassed government

According to political and legal authorities, a relatively obscure clause in the Laws on Co-operation and Development Amendment Bill published in Cape Town this week could be used to retroactively validate the forced removal last year of 171 black families living at Magopa near Ventersdorp, about 150 km west of Johannesburg

The community is currently awaiting an Appeal Court decision on their removal. Their lawyer, Nicholas Haysom, was confident the ruling would have been in their favour, giving them the right to move back to Magopa from Pachsdraai in nearby Bophuthatswana

They were moved in terms of Section 5(1)(b) of the Black Administration Act which prescribes certain procedures for such removals

Although the particular section of the Act was designed to facilitate the "banishment" of black individuals or groups, it was used in the Magopa case to force the community to move to an independent homeland

Haysom said this week government's apparent attempt to circumvent proceedings in the Appeal Court was "one of the most extraordinary breaches of the rule of law I have ever encountered"

Even though the Magopa community's challenge of the validity of their removal had been rejected by the Supreme Court, there was a "better than 50%" chance that the appeal would succeed, he said

The Magopa removal on February 14 last year was the focus of international media and diplomatic attention

After being surrounded by about 200 armed policemen at 4.30 am, the community was forced to board buses and move to Pachsdraai. The doors of their houses were smashed and the roofs were ripped off

White journalists — and even Haysom — were barred from entering the area or from going to Pachsdraai

Haysom said his argument was that the necessary procedure for obtaining Parliament's endorsement of the State President's proclamation for the removal, following its rejection by the community, had not been correctly followed, and the removal was therefore invalid

He said "If that Bill becomes law, our legal action effectively falls away. We can't be heard"

He believed government was determined not to lose face on the issue which had already caused it considerable embarrassment both domestically and overseas

Haysom contends that in terms of the law the procedure for the removal should have been proclamation, rejection by the community, the seeking of the endorsement by Parliament and then the removal

Instead, in 1973 Parliament endorsed — in advance — the removal at some future date of a number of communities, including Magopa. The 1973 endorsement was considered by the government as sufficient to go ahead with the Magopa removal last year in spite of the community's opposition, without referring the proclamation back to Parliament for re-endorsement

Opposition MPs this week slammed the government's new move and set the scene for a major confrontation that could test to the limit "consensus politics"

For the Bill to be approved as it is, it must be endorsed, in separate sittings, by the majority of members in the three racially separate houses of Parliament

It seems unlikely that either the coloured or Indian MPs, totalling 130 members, will approve the move

Endorsement by the "white" house, where the National Party holds 125 of the

178 seats, is a foregone conclusion

If "consensus" between the three houses is not reached, the State President may refer it to the President's Council

The Council can effectively approve the Bill on behalf of the dissenting MPs, and it could become law

Peter Soal (PFP Johannesburg North), who closely monitored the Magopa removal, said "Government is obviously determined not to be beaten by the Magopa community

and will even resort to this type of tactic to ensure against the possibility of the Appeal Court ruling against it"

Sources in the coloured and Indian houses of Parliament indicated the majority of MPs in the two houses would oppose the Bill

The Magopa removal occurred after four-and-a-half years of opposition by the community. Some families did move to Pachsdraai under government pressure before the forced removal last year of the remaining 171 families

The people were compensated in cash for their houses and other buildings, but no payment was made for their freehold land which the government claimed was tribal trust land which was swapped for new land at Pachsdraai

Government claimed "every possible effort" had been made to make the resettlement "development orientated and voluntary"

UNION UNITY TALKS

**Fosatu's new moves**

The Federation of SA Trade Unions (Fosatu) has initiated moves which could lead to the inclusion of more unions in the proposed new "super federation" of emerging unions. However, serious differences between the "unity" unions and the others will need to be resolved before such a plan comes to fruition

Fosatu is engaged in unity talks with the Council of Unions of SA, the General Workers' Union, the Commercial, Catering and Allied Workers' Union, the Food and Canning Workers' Union and the Cape Town Municipal Workers' Association. The federation has sent circulars to its partners proposing that copies of the new federation's draft constitution be sent to "all independent unions"

This is taken to refer to unions linked to the United Democratic Front (UDF), the black consciousness (BC) Azanian Confederation of Trade Unions (Azactu), and possibly ex-Trade Union Council of SA unions like the SA Boilermakers' Society, the Engineering Industrial Workers' Union and the Motor Industry Combined Workers' Union

The FM understands that Fosatu has also suggested these unions be invited to a meeting of the "unity" unions scheduled for June 8 and 9. The meeting was called to ratify the draft constitution and set a date for the inaugural congress of the new federation. However, Fosatu's new proposal, which is still being considered by the other "unity talks" unions, lays down certain conditions



Lawyer Haysom ... "a breach of the rule of law"

Handwritten scribbles and signatures at the bottom right of the page, including what appears to be a date "27/5/85" and other illegible marks.

(217)  
REUTERS

## S A Govt rescues O'Okiep

CAPE TOWN — The South African Government said it has paid the Barclays Bank Group R32,77m in a deal to rescue the troubled O'Okiep Copper Company.

The money, paid in September 1984, is regarded as a loan to Okiep, which will be retrospectively authorised by a clause in the second finance bill introduced in Parliament on Monday.

In 1982, the Government guaranteed a R40m Barclays loan to Okiep, which could not repay it as agreed by September 30, 1984. The new loan replaces the 1982 agreement.

The controlling shareholders of Okiep are Gold Fields of S A and Newmont Mining Corporation.

### Security

As security for the Government's R32,77m loan, Okiep has ceded to the Government its entire shareholding in the Tsumeb Corporation and the Gamsberg Zinc Corporation, according to a memorandum attached to the bill.

Mortgages have also been registered on some of Okiep's fixed and movable assets. The bill says terms of the loan have been set out, but it gave no details in

The memorandum said Okiep's mining activities, hit by the low price of copper, were vital to part of the north-western Cape.

Since 1981, Okiep has received a R17m loan from Barclays, followed by the further R40m, as well as cash from rights issues bringing in R50m. — (Reuter)





Dr Gerrit Viljoen



Mr Harry Schwarz

COPPER MINING

ARGUS 11/6/85 917 278

# Bid to secure future of O'Okiep

## Parliamentary Staff

A Bill enabling the Minister of Finance to enter into a formal financial agreement with the O'Okiep Copper Company in Namaqualand was read for a second time in Parliament

Motivating the Bill at a joint sitting, the Deputy-Minister of Finance, Mr Kent Durr, said a dramatic decline in the copper market in 1981 threatened to close the mine at Carolusberg if additional funds could not be found

The copper company, which has retrenched thousands of people in recent years, approached the Government for aid

"It bears noting that some 13 000 people, mostly coloured, are dependent, either directly or indirectly, for their livelihood on the continued operation of the mine and that very little alternative economic ac-

tivity is available in the region," Mr Durr said

In addition, three villages and their infrastructure were managed by O'Okiep

In order to ensure social stability in the area the Government issued a guarantee of up to R40-million on a new loan to the company by Barclays Bank

However, the copper market "remained in the doldrums" and the Government was obliged to pay Barclays R32,8-million, now regarded as a loan to the company repayable to the Government by 1990

Mr Durr said adequate security had been put up for the loan

The action was a "positive step in combating the de-population of the rural areas in line with Government policy of regional economic development," Mr Durr said

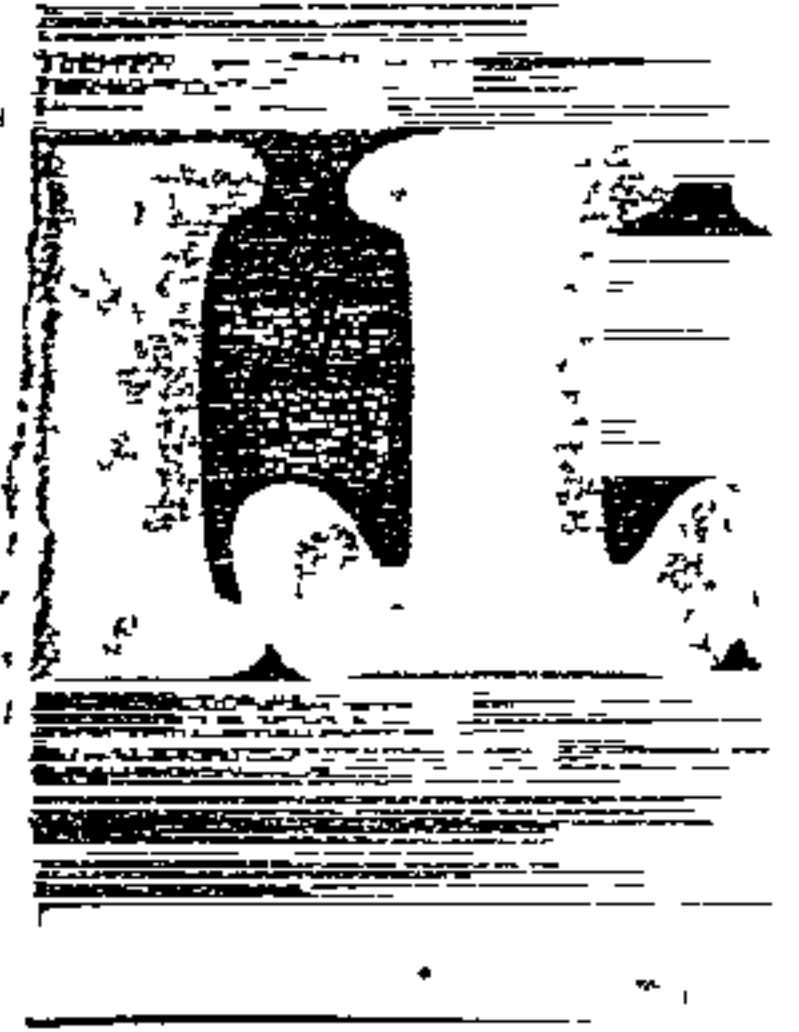

SE OFFERS W

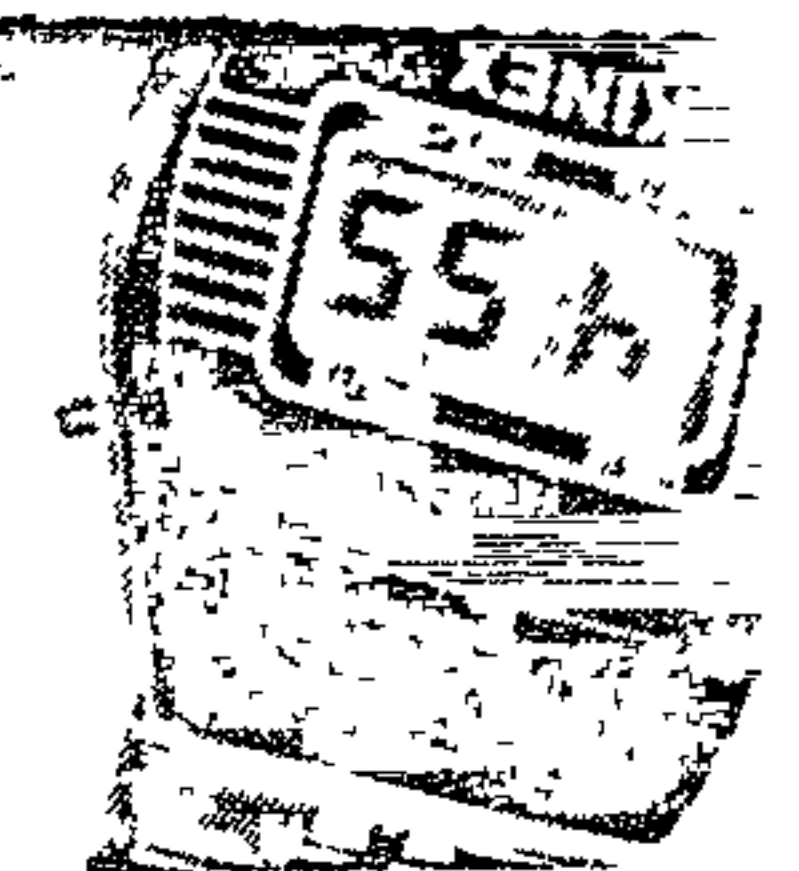



at  
Sishen's  
south  
mine  
stands  
idle. Iscor  
officials  
say  
R22,5-  
million of  
equip-  
ment is  
gathering  
dust.

CHRIS WHITFIELD

Weekend Argus Correspondent  
SISHEN, once the thriving centre of Iscor's Northern Cape mining operations, has turned into a ghost town with more than 300 houses empty and R22,5-million of mining equipment gathering dust.

"Blunders" by the corporation have forced it to shut down the mining plant at the Northern Cape town and move out its employees

And the future of Sishen, itself built over a massive iron ore reserve, is in the balance.

The town, which once boasted a population of about 1 500, is now home for about 30 people.

The last Iscor employeés moved out on January 31 this year after the mining plant at the "south mine", flanking the town, had been closed.

Most of the employeés were moved to and housed in Kathu, 16km away and now the main ore producing centre in the area. Iscor's senior general-manager for mining, Mr Ben Alberts, said the corporation had been forced to close the plant because demand for exports had dropped.

He said the corporation had decided to "rationalise" its operations in the area and decided the "north mine", with a plant at Kathu, could meet both domestic and export demands

# Sishen now ghost town

way line. The Government has announced that taxpayers will have to bear the costs of this scheme.

The chief Opposition spokesman on finance, Mr Harry Schwarz, said the Sishen project "came into exist-

tence only because of lack of forward planning".

"I imagine the total cost of that mine would be very substantial," said Mr Schwarz.

The 300 empty houses are still in fairly good condition. Most are medium-sized three-bedroomed houses and could probably fetch more than R50 000 each in a normal market.

The first signs of Sishen's demise came in 1974 when it was discovered that Iscor had built the town in the wrong place.

The town, founded in 1953, had been placed right on top of one end of the estimated 4 000 million-ton iron-ore field.

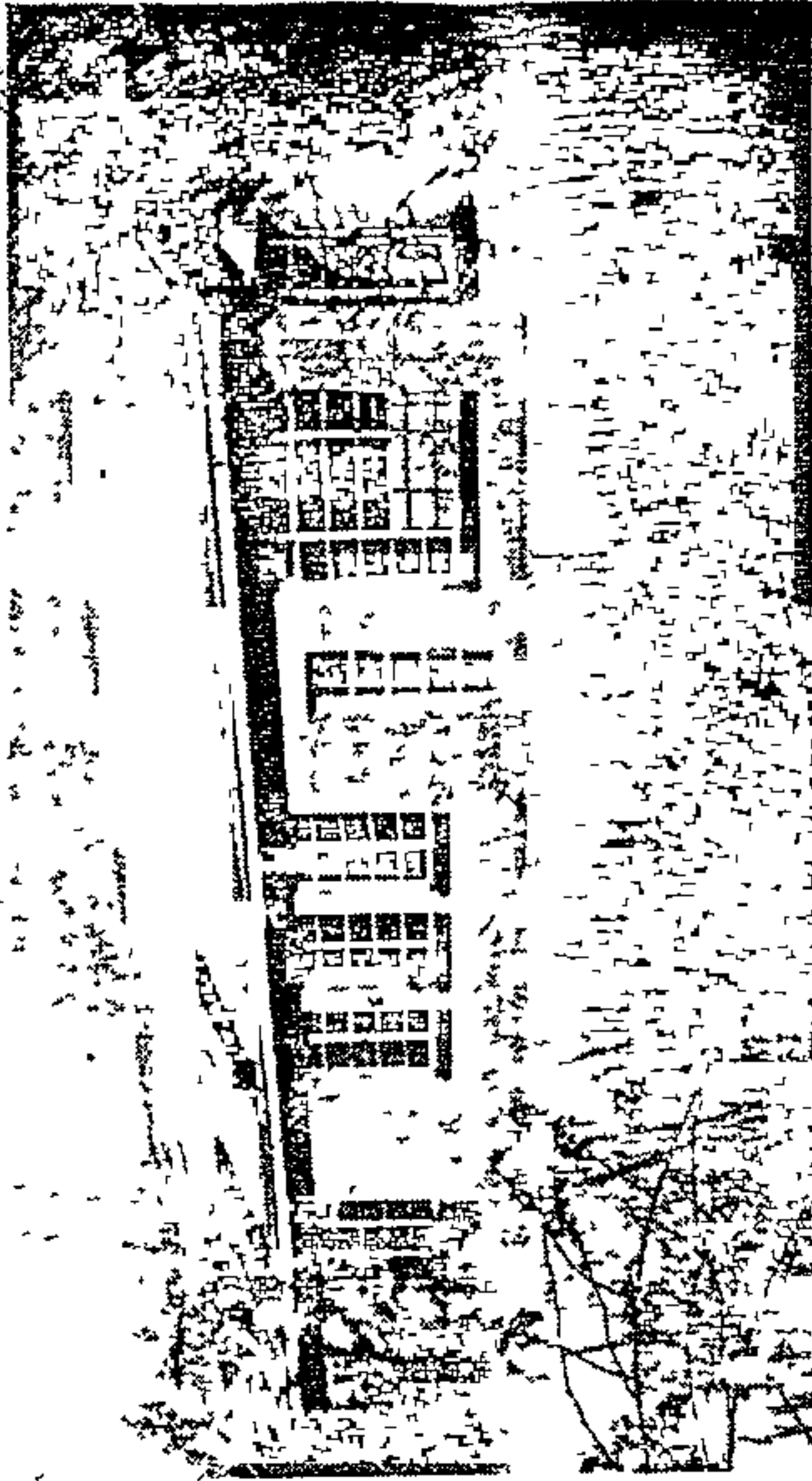

One of the abandoned Iscor homes in Sishen

W/E Argus  
22/6/85  
217



Wolke's  
**Wolke's**  
**WARRANTY**  
**LOW PRICES**  
 for you and me!

FACE CLOTHS  
 100% COTTON  
 SIZE. 28 x 28 cm

OUR NORMAL  
 LOW PRICE

**29c**

3 killed, 4 hurt in fighting at mine

From COLIN HOWELL

JOHANNESBURG. — Three miners died and four were injured, one critically, in violence at the Western Platinum mine near Rustenburg yesterday

Police fired rubber bullets and teargas and used sjamboks to disperse hundreds of miners involved in "faction fighting" and later arrested 14 workers, a spokesman for the police public relations division said last night

The violence is believed to have started after a work stayaway call was ignored by some miners

"The police were called in when the rioters started destroying mine buildings," the police spokesman said

"After dispersing the rioting miners, police found the bodies of three miners, who had been killed by their fellow workers, and four men were found injured, one critically," he said

Damage at the mine, part of which is in Bophuthatswana, is understood to run into millions of rands. The platinum mine is owned by the British company Lonrho

The general manager of the mine, Mr A A Saffy, said late last night "I have no comment to make"

The 14 arrested men were apparently being held in terms of the Internal Security Act.

# Blanket of secrecy over dispute

1701  
Authorities at the Western Platinum Mine, near Rustenburg in the Western Transvaal have thrown a blanket of secrecy over the unrest that hit the mine earlier this week, leading to the deaths of three workers.

A mine spokesman, who refused to be identified, told *The Star*: "No one is going to tell you anything because it concerns only the mine."

Western Platinum is part of the Lonrho group.

A spokesman for the group in Johannesburg said the person who could speak to the Press was Mr Richard Wagner, who was not available.

Yesterday, a significant pro-

217 By Sol Makgabutlane *Star* 5/7/85

portion of the workforce remained in their dormitories.

The Press was denied access into the mine grounds, while a large contingent of anti-riot personnel kept watch.

Workers interviewed said trouble flared on Wednesday at 3 am when workers assembled in the Wonderkop Hostel to protest against wage increases.

They said the mine had offered to increase wages by an average of R1 a shift. Workers are demanding at least R10.

At the meeting trouble apparently ensued and mine security officials tried to quell it.

When the situation got out of control, police were called to the mine and used tearsmoke, rubber bullets and sjamboks to dispel the mineworkers.

One of the men who died was said to have been fatally injured when a bus, commandeered by striking mineworkers, ran out of control.

The driver was allegedly dragged out of the vehicle and beaten up by angry men. He is receiving treatment at the mine hospital.

It could not be ascertained how the other two workers died. Workers at the mine said they did not belong to any union.



# Cause of reef mineworkers strikes baffle management

W/C  
ARBUS  
6/7/85  
23  
27

Weekend Argus Correspondent

JOHANNESBURG. — The cause of strikes by 27 000 black workers at five Gencor gold mines during the past week is a mystery to the company

The climate of excitement which precedes wage increases is one reason suggested by the management

At a Press briefing in Johannesburg yesterday, the senior executive of Gencor's gold and uranium division, Mr Bruce Evans, said. "We don't have the faintest clue what really caused the strikes and unrest"

When asked if it was then only coincidence that unrest followed the implementation of their annual increases, Mr Evans said the atmosphere of excitement might have played a role

## Positively

The unrest claimed the life of one black mineworker.

According to Mr Evans, the wage announcements were positively received by the majority of the 83 000 mineworkers on Gencor gold mines

The increases range from 16,9 percent for the lower categories to 12,2 percent for the higher categories. On average, these increases are about two percent lower than the final Chamber of Mines offer

Mr Evans said "We regard the wage increases very fair. Although it goes against the grain, these increases are much higher than productivity improvement"

He said many of Gencor's increases were higher than those recommended by the Chamber of Mines

# Report shows world needs S A minerals

Finance Editor Jon Beverley re-examines the role of South Africa as a supplier of strategic minerals to the Common Market

IF THE politicians of Strasbourg really had the sort of common purpose which the founders of the Common Market desired so many years ago, then the rhetoric that surrounds the issues of apartheid, minerals, South Africa and politics would most likely have resulted in embargoes and sanctions years ago.

But Western Europe finds it needs South Africa's minerals, as a comprehensive document of the S A Institute of International Affairs (SAIIA) clearly demonstrates.

The individual governments are quite happy for assorted politicians, whether at home or in the Common Market 'legislative' capital at Strasbourg, to sound off on the South African question.

They are happy to subscribe to the EC Code of Conduct for businesses (similar to the American Sullivan Code) and make appropriate noises if some companies fail the criteria.

But when it comes to stopping their industries from ordering antimony (24 percent from SA in 1983), chrome (59 percent), ferrochrome (40 percent), manganese ore and metal (47 percent), ferro-manganese (40 percent), nickel (seven percent) and the platinum group metals (four percent), there are no signs of any bans.

The only problem has been an economic one.

Europe, coming out of a long recession, together with a shift in world manufacturing bases and the consequences of the oil-shocks of a decade ago, have changed the picture.

Strikes have also helped the non-strategic metal picture. South African coal flowed into Britain, via other countries, during the months-long pit strikes.

The Metal Bulletin Handbook which quotes the percentages above shows changes in the supply picture over five years.

For example, France has increased its reliance on South African antimony ore from seven percent in 1979 to 24 percent in 1983.

Or, the United Kingdom once took 62 percent of platinum group metals from SA but now takes only two percent.

That means one of two things — the U K is buying from Russia, which produces more than 50 percent of world supplies, or it is getting its metal through intermediaries from South Africa, which produces about 42 percent.

With the exception of platinum the other strategic metals still occupy the same percentage supply levels, or a little more, as they did five years before.

Europe does have to cope with its responsibilities under the Lome Three Agreement — which includes the countries of Africa, the

Caribbean and the Pacific (ACP)

This boils down to giving massive subsidies to agricultural produce, of which sugar is one.

But, curiously, Europe has not managed to agree to the Stabex fund, which was aimed at doing the same sort of thing for metals imported from the ACP.

It would seem that the South African prices are more attractive than the political kudos of signing Lome.

The SAIIA study goes over the various positions taken by the Common Market and the principal members over the past few decades in respect of South Africa's mineral trade.

It concludes that the minerals supply position does not wholly determine the relationship between the EC and SA.

But, as the lack of concrete Community action demonstrates, economic pragmatism predominates.

## SA link

'In spite of its growing trade with the ACP countries, the EEC is not yet prepared to minimise its economic links with South Africa.

'In the uncertain economic climate of the 1980s, Community member-States are unwilling to risk the inevitable structural dislocations (such as a rise in unemployment) that would result from such actions.

(A recent article stated

that unemployment was of more importance than pollution, nuclear disarmament, inflation and crime to European voters)

Lome Three, signed last year, included a clause singling out South Africa for its apartheid policy and brought Angola and Mozambique into the accord.

The relationship thus becomes a delicate political balance, says the SAIIA, between what the South African Government does positively and negatively and the domestic policies of European countries ever conscious of the vast and costly queues of unemployed voters.

'It would certainly be in the best interest of the private sector to make (the South African) Government aware of this when formulating policy.

As a senior official in the (Economic) Commission recently pointed out. 'The very fact that we're working on (sanctions) will put the frighteners on businessmen in South Africa.'

It seems that neither the ACP countries nor the EC is in the market to ban South African minerals but the SAIIA detects a subtle shift in the provisions of Lome Three which 'however, point to possible policy shifts in EEC mineral supply access in the long-term, given its growing commitment to its ACP partners.'

19.85

21.79



# US Congress votes ban on imports of SA coal, uranium

By Neil Lurssen

WASHINGTON — The US House of Representatives has agreed to ban the importation of uranium and coal from South Africa and Namibia

But the ban, an amendment to an appropriations bill, will not become US law unless it is also approved by the Senate

The measure was introduced in the House by Democratic congressman Mr Bill Richardson of New Mexico who said uranium imports from South Africa increased by 350 percent between 1981 and 1983

He said a top American uranium broker had estimated that the US could be importing as much as 6 million kg of SA uranium by 1995

Mr Richardson said 347 of the existing 362 US uranium mines were not operating now — but it was possible for American suppliers to make up the shortfall to replace the SA product

"South Africa is the largest

exporter of coal to the US," Mr Richardson added "We imported 612 447 tons of coal from SA in 1984"

In the last two years, SA had obtained almost \$43 million in foreign exchange from coal exports to the US

These figures had to be seen in the context of a stagnating US coal industry with between 60 000 and 100 000 US coal miners out of work

The amendment was supported by liberal congressmen who were behind the sanctions legislation recently approved by the House

One of them, Mr Howard Wolpe of Michigan, said: "The uranium imports sanction would strike at the fourth largest SA import into the US

"While US jobs in the uranium industry are disappearing, uranium produced by cheap labour in SA and SA-occupied Namibia is being exported to the US in increasing amounts"



One of the many incidents in which police used tear-gas to disperse crowds of youths who had gathered on the outskirts of the Edendale township. A SAAF helicopter, monitoring activities in Pietermaritzburg's black townships, kept in constant contact with police units on the ground.

**Police and mobs clash**  
*NM 19/7/85*  
 Pietermaritzburg Bureau

POLICE used tear-gas and rubber bullets and arrested an unconfirmed number of people during sporadic incidents of stone-throwing in black townships in and around the capital yesterday

Estimates were that 60 percent of the black workforce stayed at home, almost bringing the city to a halt.

Business was reported to be 'very, very slow' throughout the day

The situation in and around the townships remained tense throughout the day and there were several skirmishes between police and small mobs of black youths who stoned private vehicles and police who patrolled all the main routes in and around the townships

A South African Air Force helicopter, which was on standby all day, was used by police to monitor trouble spots from the air

A contingent of soldiers was also on standby in some township areas

A senior police spokesman said the first sign of trouble was shortly after

## Several skirmishes with police and mobs

*NM 19/7/85*

◆ FROM PAGE 1

near Edendale Hospital. No one was injured during the incident

### Arrested

Later in the day there were several more stone-throwing incidents in Edendale as well as in Imbali township and Mpophomeni in Howick

During these incidents police used tear-gas and in some case rubber bullets to disperse the crowds

According to a report from the police headquarters in Pretoria rubber bullets were used in one stone-throwing incident at Edendale

A senior police spokesman said yesterday afternoon that a number of people had been arrested in connection with public violence in the townships but was unable to estimate the number of arrests

The spokesman said several policemen had suffered slight injuries during the incidents and some police vehicles had been damaged

The S A P divisional commissioner for Natal, Brig Mulder van Eyk, said late yesterday afternoon he felt police had 'everything under control'

the scene immediately and they arrested seven people inside the store and another four outside, a senior police spokesman said

Most of the stolen goods were recovered

It has also been reported that an administration block in Mpophomeni near Howick was burnt down after being set alight by a mob after 4 30 pm. Details of the incident are not yet known

### Dispersed

A senior police spokesman said during the same incident two KwaZulu Government vehicles had been destroyed by fire. One of them was a bakkie and the second a Bedford tanker, he said

Last night there were

still several incidents of violence in the townships in which motor vehicles and homes had been burnt

Police confirmed at least three homes in Mpophomeni were burned down by mobs of youths who were dispersed with tear-gas

One of the homes belonged to a Sarmco employee Mr Samuel Buthelezi, and a mini-bus belonging to his brother, Mr P Buthelezi, was also destroyed. A third home owned by Mr Emmanuel Thalane was burned down

There was an unconfirmed report that an attempt was made to set a beer hall in the township alight



217 *WKA*

# Rusplat profit soars 57%

JOHANNESBURG — Increased sales volumes of platinum, palladium, gold and base metals, plus the higher rand prices due to the weakness of the rand against the dollar, resulted in Rustenburg Platinum Holdings increasing its net profits for the year to June by 57 percent

After-tax profits were R156,9m, compared with R100,1m the previous year, equivalent to earnings a share of 125,2c (79,9c)

The company has declared a final dividend of 55c a share (42,5c), thus increasing distribution for the year by 50 percent from 60c to 90c

Gross sales revenue increased 32 percent.

from R807,3m in the previous year to R1 063,1m in the year under review

Profit before provisions was up 62 percent at R378,9m (R233,4m)

The directors state in the preliminary profit statement that the average dollar prices achieved of sales of platinum, palladium and gold were substantially lower in the year under review than the previous year

The rand prices of all metals were higher due to the weakness of the rand against the dollar and sales volumes of platinum, palladium, gold and all base metals increased — Sana



Mr J P Velthuisen has been appointed area manager, Western Cape, of Frasers Ltd and Southern Wholesale division.

# R5 550-m offer over health problems from asbestos

Argus Foreign Service

NEW YORK — An American asbestos producer has offered to pay R5 550-million to claimants in what is the largest health settlement yet made by a private company.

The company, Manville Corporation, once the largest asbestos producer in the world, has been grappling with the case for 15 years.

In 1982 it declared itself bankrupt to get around 16 500 lawsuits which

Argus 5/8/85 (217)  
were filed against the company for asbestos-related health problems.

If the offer is accepted Manville will set up a fund and shareholders will surrender half the value of their stock. The company will also have to surrender much of its projected earnings over the next 25 years.

Asbestos, widely used in insulating materials, ships, clothing, appliances, and other products, has been the cause of fatal or debilitating lung

cancer. The disease takes up to 20 years to develop and the company had expected 60 000 claims, mainly from shipyard workers.

Manville used the bankruptcy as a tactic to protect the company financially while settlements were worked out, although it was still solvent. However, the plan backfired.

It will not be able to pay off the claims over time as it had hoped. Instead the bankruptcy court requires

that the company make provision for all future cases, based on statistical evidence.

The offer still has to be approved by shareholders, unsecured creditors, co-defendants, current health claimants as well as the bankruptcy court.

The largest fund previously set up by a company for health claims was R360-million for damage caused by an intra-uterine birth control device called the Dalkon shield.

Argus Foreign Service  
NEW YORK — An American asbestos producer has offered to pay R5 550-million to claimants in what is the largest health settlement yet made by a private company.  
The company, Manville Corporation, once the largest asbestos producer in the world, has been grappling with the case for 15 years.  
In 1982 it declared itself bankrupt to get around 16 500 lawsuits which were filed against the company for asbestos-related health problems.  
If the offer is accepted Manville will set up a fund and shareholders will surrender half the value of their stock. The company will also have to surrender much of its projected earnings over the next 25 years.  
Asbestos, widely used in insulating materials, ships, clothing, appliances, and other products, has been the cause of fatal or debilitating lung cancer. The disease takes up to 20 years to develop and the company had expected 60 000 claims, mainly from shipyard workers.  
Manville used the bankruptcy as a tactic to protect the company financially while settlements were worked out, although it was still solvent. However, the plan backfired.  
It will not be able to pay off the claims over time as it had hoped. Instead the bankruptcy court requires that the company make provision for all future cases, based on statistical evidence.  
The offer still has to be approved by shareholders, unsecured creditors, co-defendants, current health claimants as well as the bankruptcy court.  
The largest fund previously set up by a company for health claims was R360-million for damage caused by an intra-uterine birth control device called the Dalkon shield.



# Platinum cut-off (217) will hit STAR West hard

The Star Bureau 7/19/85

LONDON — Disruption of supplies of South African platinum and its exotic relatives could hit the West harder than losing its gold.

So says Michael Prest of *The Times*, reviewing the rare metals market in the light of the troubles in South Africa.

Prices would rise and the West would be in a pickle — not least because the alternative supplier is the Soviet Union.

Prest notes that South Africa has more than 80 percent of world platinum reserves and 60 percent of palladium. Its market share in both metals is proportional.

"Finding substitutes for these metals in exhaust catalysts, the chemical and petroleum industries and specialised electronics is almost impossible," he writes. "Stocks, moreover, are small.."

## HUGE STOCKS

Notwithstanding the ramblings of gold bugs, says Prest, the yellow metal is probably of least strategic value.

As Shearson Lehman points out in its metals Markets Weekly Review, gold stocks are huge.

But not all of this is readily available — and quite a lot is behind the Iron Curtain. Nevertheless, gold is not thought rare enough for the US to include it in the strategic stockpile.

But Prest adds that rudely removing half the annual supply of gold must affect prices, if only for a while.

## CRUCIAL

The position of chromite and manganese is more complicated than that of platinum, he says. South Africa produced 3 million tons of chromite last year, almost a third of world output. Reserves are even bigger relatively, being put at 83 percent of the world total.

The crucial point, however, is that South Africa supplies more than 40 percent of the metallurgical-grade chromite,

of *The Times*, reviewing the rare metals market in the light of the troubles in South Africa.

Prices would rise and the West would be in a pickle — not least because the alternative supplier is the Soviet Union.

Prest notes that South Africa has more than 80 percent of world platinum reserves and 60 percent of palladium. Its market share in both metals is proportional.

"Finding substitutes for these metals in exhaust catalysts, the chemical and petroleum industries and specialised electronics is almost impossible," he writes. "Stocks, moreover, are small..."

#### HUGE STOCKS

Notwithstanding the ramblings of gold bugs, says Prest, the yellow metal is probably of least strategic value.

As Shearson Lehman points out in its metals Markets Weekly Review, gold stocks are huge.

But not all of this is readily available — and quite a lot is behind the Iron Curtain. Nevertheless, gold is not thought rare enough for the US to include it in the strategic stockpile.

But Prest adds that rudely removing half the annual supply of gold must affect prices, if only for a while.

#### CRUCIAL

The position of chromite and manganese is more complicated than that of platinum, he says. South Africa produced 3 million tons of chromite last year, almost a third of world output. Reserves are even bigger relatively, being put at 83 percent of the world total.

The crucial point, however, is that South Africa supplies more than 40 percent of the metallurgical-grade chromite, which is essential for making stainless steel, a basic requirement of modern industry.

Yet prices may be little influenced, because the United States has an enormous stockpile of ferro-chromium.

By contrast, says Prest, a price which could move briskly is that of manganese. Like chromite, it is critical to the steel industry, where its main function is to remove sulphur from the steel.



# Waddell cautious on platinum

Financial Staff Demand for platinum and platinum group metals is satisfactory, and it is likely that the main determinant of Rustenburg's results for next year will be the US dollar prices received and the value of the rand against the dollar.

Mr Gordon Waddell, chairman of Rustenburg Platinum Holdings, says in his review to June

that these two variables reflect a multitude of factors throughout the world and in South Africa, and it is "extremely difficult" to predict the outcome

He says the group is in a sound financial position. The balance between supply and demand is better, and in the absence of unforeseen significant changes he believes that rand profits of

the group next year will be the same as this year or even slightly higher

In the year under review, rand profits after tax were R156,9 million and were the highest attained in rand terms. This was an increase of 56,7 percent over the R100,1 million in the previous year

Dividends declared increased by 50 percent to 90c from the 60c in 1984

Mr Waddell says the free market price of platinum in dollars unfortunately reached its peak of \$371 a troy ounce on the second day of the financial year under review. It subsequently fell away, and today it is no higher than \$284 a troy ounce — the lowest it has been many years

"This is a cause for concern for, with the exception of Japan, there is little credible evidence that the demand is in any sense price-elastic

"Given the better balance between demand and new supplies to the market from producers, I would have hoped that

the dollar price would have done better"

In fact, the average free market price for the year to end-June declined substantially to \$300, a fall of 25 percent, compared with the \$401 in the previous year

## CURRENT DEMAND

In the year to December 31, 1984, platinum imports to Japan increased by 25,7 percent and in the first five months of this year, they rose by 57,8 percent over the corresponding period in 1984

He says current demand is now probably in excess of the present supplies coming forward from the producers

Says Mr Waddell "That the average dollar price for the year fell, and has yet failed to respond to this significant improvement in the balance of demand and supply, can still only be explained by the liquidation of excess inventories or by disharding or by the perception that precious metals remain relatively unattractive compared to other forms of investment"



**COLD WATER DISPENSERS FOR OFFICES & FACTORIES VERY CONVENIENT**  
 Can be moved anywhere No plumbing  
 Rental R7,50 pm excl GST Minimum 1 year  
 (Hire Reef, Pretoria area only)  
 Outright purchases country wide

**AQUACOOLERS (PTY) LTD**  
 608-1563, 608-1473  
 PO Box 11433, Jhb 2000  
J93/D004575



# Waddell: Remove export bars

THE platinum-mining industry could make an even larger contribution to the country's foreign-exchange earnings if it were treated in similar fashion to other exporters, according to Rustenburg Platinum chairman Gordon Waddell.

In the company's annual review for the financial year to June Waddell says the decision to remove export allowances from the producers of precious metals was based on the grounds that producers had no alternative but to export most of their products.

While this is true, Waddell believes the country's need to have a consistent and adequate ability to provide the funds required to open and develop new markets has been ignored completely.

He says this constraint — coupled with the cyclical nature of the platinum industry, which determines levels of annual expenditure — has limited Rustenburgh's endeavours.

The company has made a submission to the Margo Commission for the reinstatement of at least some of the export allowances to the platinum-mining industry. Taxed profits for the year to June of

## ROY BENNETTS

R156.9m were the highest yet attained in rand terms, but Waddell says that without the 15% tax surcharge imposed on mines — other than gold and diamond mines — taxed profit would have been R12.6m higher.

Waddell says Rusplats' marginal rate of taxation and lease is now no less than 66%, which he claims to be inordinately high given the character and past history of platinum mining.

Rusplats paid out R63.8m (R50.7m in 1984) in commissions and discounts to sole marketing agent Johnson Matthey and other customers.

The trend in the free-market dollar price of platinum, with the average market price for the year to June substantially down at \$300 (\$401) a troy ounce, is not to Waddell's liking.

Market price for the metal reached a peak of \$371 on the second day of the financial year under review and declined to a low of \$245 in March 1985. Liquidation of excess inventories and dis-hoarding are blamed by Waddell for the low price compared with the increase in demand for the metal from Japan.

Sales to the Japanese market rose by 25.7% in the year to December 1984, with further increases in the first five months of the current year.

Demand in the first half of 1985 was 57.8% above the comparative months of 1984.

Waddell says demand for the metal is now probably in excess of supplies from producers and this is likely, sooner or later, to bring about a change for the better in platinum's dollar price.

Use of the metal as a fuel catalyst ties its immediate future to the activities of the automobile industry.

Waddell says the momentum of the last two years has been maintained in the US, with the production of cars up by 3% at nearly 8-million units compared with the previous year. The US car industry is reported to have bought 722 000 ounces of platinum in the year to March 1985.

The Japanese sold more than 3-million cars in Japan and exported nearly 4-million cars during the year.

The European Economic Community appears to have reached a compromise over emission-control standards required for cars of different engine sizes. Waddell believes this will lead to a

major expansion in demand for platinum and rhodium to meet the requirements of West European car manufacturers.

Last year demand in Japan for platinum for use in jewellery increased by 15% to 650 000 ounces.

This increase appears to have been sustained during the first five months of this year and is expected to continue for the remainder of the calendar year, says Waddell.

Rusplats commissioned a survey to find the potential for platinum jewellery in the US. There appears to be indications of considerable potential, which could be developed over a five-year period.

Waddell says that, owing to the absence of export incentives, Rusplats has come to the conclusion that it would be imprudent to take on additional commitments for the time being.

Industrial demand for platinum presents a mixed picture, says Waddell. Demand from the chemical industry improved in comparison with the previous year but decreased from the petroleum-refining industry.



of manufacturers' price-cutting moves, outside the usual discounts on fleet sales "We're not in the banking business," affirms marketing director Brand Pretorius



**Whitfield**

Nissan chairman Peter Whitfield says that jugular marketing to make sales is likely to leave dealerships in worse shape when the discounting ends Even Toyota has been largely powerless to stop its dealers discounting heavily to shed stock quickly

The split in strategy on discounts and special incentives between makers has created a "hawks" and "doves" rift in the troubled industry.

Alfa Romeo (AR), which fired the first public shot, is extending its sales blitz for another month. Samcor, however, will not say when

its Mazda 323 promotion ends

The doves, who oppose discounts, say cut prices will merely delay the inevitable fall in AR and 323 sales They expect Naamsa's monthly new-sales figures to show the discounters rapidly losing market by the fourth quarter of the year, as a result of bringing sales forward

There may, however, be other motives for the apparent madness The current Mazda strategy appears to be designed to clear stockyards before a new model 323 is launched, towards the end of the year. Samcor is banking on the current sales drive to give the new 323 an extra push.

Clearly, the industry's troubles are far from over, and a very different manufacturer-dealer scenario is expected to emerge in the next year It will certainly be a leaner industry, but whether it will be healthier only time will tell

FM 16/8/85

**MANGANESE**

**Ex unitate . . .**

The merger last week of the world's two largest manganese metal producers — Delta Manganese and the Electrolytic Metal Corporation (Emcor) — creates a new company which carries heavy clout in world markets for the metal

The new company, the Manganese Metal Company (MMC), exports 98% of South Africa's production which, in turn, meets 75% of the West's demand for electrolytic manganese — a high-purity metal used for

high-strength, low-alloy (HSLA) steels and aluminium and copper alloys, particularly in the motor industry

Delta Manganese is a subsidiary of the UK's Delta Group Delta Manganese and Gencor-controlled Emcor have worked together in the past, following each other's price leads

But the new deal will lead to rationalisation benefits, and inevitably strengthen the producers' bargaining power in overseas markets

Delta's Nelspruit plant, with a rated capacity of 26 000 t/year, will operate at full capacity while Emcor's smaller Krugersdorp facility will absorb the overflow and the smaller runs

MMC stresses that there are no moves to close Krugersdorp "The main thrust behind the merger was to rationalise plants and pool resources and shipping arrangements to avoid duplication," says MMC MD John Jacobs "We are not carteling," he adds

Although the Delta plant is bigger, Jacobs explains that it was agreed that Gencor would have the majority shareholding Emcor now owns 51% of the merged operation

The move is in line with most of Gencor's acquisitions, which tend to give it a majority stake.

Emcor is to pay R8m to Delta's shareholders in an immediate down payment, and a further tranche may be paid on a performance-related basis in 1988

Abroad, the depressed state of manganese markets has triggered a spate of mergers to combine resources and establish corporate ties with consumers — the SA Manganese Corporation, for example, owns a ferro-alloy plant in the US

Elkem, the major Norwegian ferro-alloy producer, recently acquired a minority shareholding in Gabon's Comilog It also manufactures electrolytic manganese in the US, along with Kerr-McGee

The manganese industry has suffered from stagnant demand, tumbling prices and the fact that manganese is a virtual hostage to the steel industry.

Electrolytic manganese has fared rather better, but virtually static demand in the Seventies and early-Eighties mothballed the Foote plant in the US and squeezed Yamagata of Japan out of the market altogether

Currently, manganese metal prices are buoyant, but there are storm clouds on the horizon.

Competition for the SA producers will increase when Brazil's Metallur electrolytic manganese plant comes on stream with possible production of around 20 000 t/year This is likely to upset the market unless

demand picks up

In April, Delta MD Langham Carter told a minor metals conference in Paris that a new plant coming on stream "will provoke aggressive retaliation from producers," which will severely dampen prices

Since SA producers currently control 60% of world market sales it is hoped the newly-formed MMC will be a potent force in counteracting the Metallur threat

Already the industry is shouldering the financial penalties of excess capacity Although world sales increased from 44 000 t to 58 000 t between 1981 and 1984, installed capacity is around 76 000 t/year

"Merging the two plants," says Jacobs, "will undoubtedly help us take up the slack"

Other SA exporters, particularly of strategic materials, are bound to look increasingly at similar moves to strengthen their bargaining position in world markets as the sanctions threat grows



**REPORTS in the United States claim South Africa has threatened to stop the sale of 'critical materials', including gold, to any country imposing economic sanctions on the republic.**

**This week Dr Brian Clark, chief director of the National Institute for Materials Research at the CSIR, discussed the implications of the dominance of gold when he delivered a paper at the Senate Special Lectures at the University of the Witwatersrand. He believes South Africa's days of playing the role of 'a contented minerals supplier to the world' are over.**

**Here are excerpts from the lecture.**

# Whither, now, South Africa?

**AN ANALYSIS of South Africa's minerals industry shows one product is dominant — gold. During 1984 gold export sales accounted for 72 percent of all mineral export sales. However, herein lies one of South Africa's greatest dilemmas**

The gold-mining industry is known to be a passing phase in South Africa's history. From the time mining started in the early 1870s to the end of 1984 some 39 544 tons of gold have been produced. In 1970 annual production peaked at 1 000 tons and the present production is only two-thirds of that volume.

Current predictions are that the number of producing mines will steadily decline, and terminate somewhere round 2020. Against this trend of falling production volumes the gold share of South Africa's total export revenues has increased. In 1950 it was less than 30 percent and in 1984 about 50 percent.

Thus, in spite of everything said and done in the past and all the investments made to broaden the base of our economy, in 1985 we are more dependent than ever on one commodity — gold.

## Gloomy

On the surface, this trend presents a gloomy picture and it is important to ask the questions: Has the minerals industry been stagnant and why are we in this position? Closer examination shows the situation is a complex one. Key issues include the following:

● The mining and minerals industry has shown significant development. Over a period of 100 years the industry has undergone enormous changes. Initially there was a maverick, entrepreneurial situation dominated by a number of small companies headed by characters with enormous courage and drive.

*MERCURY*  
Special  
Correspondent  
JOHANNESBURG

this analysis is the lack of major new ventures since 1980. After many years of rapid growth we seem to have paused or run out of steam — almost as if we have lost our way.

● The dominance of gold is obviously due largely to fluctuations in the dollar price in international markets and, of late, to the very sharp decline in the value of the rand. This latter trend boosts the dominance of gold even further.

Concern is voiced in the Western world that, given South Africa's dominant position (and the even more serious situation that in many cases the Soviet Union is the major alternative supplier) the Western world is particularly vulnerable to potential disruptions of supply.

In the case of South Africa, concern is voiced that:

● From the perspective of the Western world an unstable political situation could result in the termination of supplies.

● Recent reports in the United States have gone further, and claim South Africa has threatened to stop the sale of these critical materials to any country imposing economic sanctions on the republic.

## Short-sighted

On the other hand, we in South Africa have been quick to point out the dominance of our position and even call international attention to the fact on an ongoing basis.

*24/8/85*  
grammes aimed at replacing certain minerals or elements — for example, chromium in critical materials, thus reducing the dependence of the Western world.

So far there have been no dramatic breakthroughs that are about to change our position radically, but the writing is on the wall.

Just how serious is the so-called South African threat to impose embargoes of our mineral exports, reported in the United States recently without reference to source? 'Almost ridiculous' should be the response.

First, embargoes of this kind would be trivially easy to break. An excellent example of this was the American decision not to buy chrome from Zimbabwe (Rhodesia) during the 60s and 70s. It is well known that Zimbabwean chrome ore continued to be sold to the United States via a number of other countries, including the Soviet Union. All that happened was that it cost the US a little more.

## The key

This is really the key — the market-place will adjust to the problem. Secondly, South Africa has to continue selling its minerals as they constitute 67 percent of export earnings. They are the major wealth-generators that provide the opportunity to develop and prosper.

Where to, now, South Africa?

The mineral life-cycle is an excellent way of understanding the linkage between different industrial sectors. Materials move round the life-cycle



● The mining and minerals industry has shown significant development. Over a period of 100 years, the industry has undergone enormous changes. Initially there was a maverick, entrepreneurial situation dominated by a number of small companies headed by characters with enormous courage and drive.

In a recent publication James (Mr Henry James, newly elected president of the S A Institute of Mining and Metallurgy) reviews the major projects and highlights the activities surrounding the move from solely mining operations to where we are today, which includes mineral beneficiation industries.

The single most disturbing factor shown in

country imposing economic sanctions on the republic.

### Short-sighted

On the other hand, we in South Africa have been quick to point out the dominance of our position and even call international attention to the fact on an ongoing basis. Unfortunately our approach has been extremely short-sighted and is tantamount to severe abuse of our resource position.

The effect of this public debate in the Western world has heightened awareness of South Africa's position of dominance and led to the aggressive promotion of stockpiling and research-and-development pro-

percent of export earnings. They are the major wealth-generators that provide the opportunity to develop and prosper.

Where to, now, South Africa?

The mineral life-cycle is an excellent way of understanding the linkage between different industrial sectors. Materials move round the life-cycle curve from the beginning as minerals, through to processed minerals or raw materials to basic materials and, finally, engineering materials that surround us daily.

The one factor that dominates the movement of a specific material through its life-cycle is technology.

One crucially important point to realise is that materials and their availability are controlled by society's needs and experience. There is constant competition between the various material types, eg metals, ceramics, plastics, composites etc to fill a particular need. The competition is fierce and never-ending.

Clearly, the bulk of our industrial muscle and investment lies in the mining and minerals-processing area.

### Pressure

It is important to note South Africa has a positive trade balance for only the more traditional metal-based materials. In the newer and new-generation materials such as ceramics, plastics, synthetic rubber and certainly also for electronic materials and components, the situation is reversed.

Basic iron and steel exports are under severe pressure in view of international oversupply. Therefore greater emphasis will be needed on the development of high-alloy steels, polymers, new-generation ceramics etc, if a positive balance of trade is to be maintained in the materials sector over the longer term.

The development of specific materials to meet specific international market demands (a market-niche strategy) will be the key to sustained and increasing exports of materials produced locally.

What is required now is a dedicated national strategy to use our strengths and exploit them in the international market-place through advanced/specialty materials and associated final products.

# SA minerals vital to US defence build-up

IF UNITED STATES economic sanctions against South Africa prompted retaliatory action American industry would quickly discover how dependent it is on South African minerals to keep its production lines open.

South Africa is the United States' biggest supplier of chromium — needed to harden steel for aircraft — and platinum, used to refine petrol.

The second biggest US supplier is the Soviet Union, but it is not regarded as reliable in time of crisis.

The United States, reports Sapa-Reuter, has a strategic minerals stockpile for military needs in war but none designed to withstand a peace-time economic boycott.

A recent Commerce Department study on South African mineral resources said a continued supply was vital to President Ronald Reagan's military build-up and US industrial preparedness in the event of a national security crisis.

It said Pretoria appeared to have no intention of imposing retaliatory sanctions — South Africa depends on world mineral sales for vital foreign exchange — but warned it had amassed 'growing potential leverage over

EDITORIAL comment in this issue by JO McMillan, MC Mattson, A GM Fishley, NG Elliott and B Parkes. Political headlines and sub-editing by RJ MacMillan, contents bill by R Hawkins, cartoon by P Lessing, all of 12 Devonshire Place, Durban

Special Correspondent  
NM 11/9/85 WASHINGTON

217

the US economy.

Mr Robert Wilson, head of the department's Office of Strategic Resources, which made the study, said industry had sought a government stockpile for private business, similar to the military stockpile.

But the reply, he said, was 'If they thought it should be done, they should do it themselves.'

He added that while some companies were building strategic stockpiles private industry remained vulnerable to any interruption of the flow of raw materials from South Africa.

The study concluded that the decline of US mining and mineral processing, along with pressures to reduce the US stockpile, had led to the increasing possibility of South African influence over the American economy.

It said the United States depended on South Africa for 48 percent of its chromium for toughening steel and industrial equipment and there was no substitute for many of its uses.

It added that South Africa's neighbour, Zim-

babwe, was also a source for chromium, but its ore was exported over South African railways and through South African ports.

The report cited these other US mineral imports from South Africa:

- Manganese, also used for steel-making, 33 percent of US needs. Gabon is a second US source, but the Soviet Union is the world's biggest producer.

- Platinum, used as a catalyst to react with other metals, in the production of electronic and electrical equipment and for emission-control devices in cars as well as in petrol-refining, 67 percent. There are substitutes for platinum but only at additional cost and loss in performance.

- Vanadium, used to make steel alloys for aircraft and machinery, 54 percent. Canada is the second US supplier.

The Commerce Department study showed South Africa had the greatest concentration of vital materials and minerals in the Western world, lacking only bauxite and petroleum.



# Poor outlook for uranium

By Stan Kennedy

217  
STAR 7/9/65  
Oversupply, the cancellation or postponement of several large power stations, the liquidation of excess inventories and the poor price outlook for other energy/fuel sources are the major reasons for the falling price of uranium

In his annual report to end-June, the chairman of Harmony gold and uranium mine, Mr Clive Knobbs, says spot and contract prices of natural uranium fell steadily from the \$18 a lb range to \$14.55 a lb in May this year. Since then, the price had stabilised in the \$15 to \$16 a lb range.

Transaction volume had also been depressed and had not exceeded six million tons on a monthly basis.

"The downward drift in the price of hydro-carbon fuels has decreased the urgency of switching, both in present operations and future capacity, to nuclear power," Mr Knobbs says

"A large amount of inventory liquidation, particularly in the US by producers and utilities needing to generate cash, has also put downward pressure on prices."

Apart from South Africa, production from other major producing areas either increased or remained at a present high level. In the US, more nuclear power stations were cancelled than began commercial operation. In Europe, while no plants were cancelled, orders for new nuclear power stations declined.

Looking ahead, he does not see any

major upward price correction although he believes there is potential for some gradual improvement.

Installed nuclear capacity in the Western world is expected to double by the end of the decade, with the largest increases in the Far East and Asia. Good gains are also expected in North America and Europe despite the risks.

"Demand for reactor fuel should reinvigorate the market within two to three years," he says.

"Based on current projections for mines in production, under construction and on the drawing boards, the market should return to balance by the end of the decade. Unless any new major sources of supply are discovered, there should be a positive price appreciation after allowing for inflation."

He points out, however, that risks remain with regard to nuclear power commercialisation, especially in North America. Areas of concern include anticipated growth rates in energy demand, costs and environmental aspects.

● Harmony's uranium production is geared to meet the company's long-term committed sales. Total slime treated during the year was 5 595 000 tons, down 15.9 percent from the 6 650 000 tons last year.

The uranium oxide yield was 0.082 (0.083) kg a ton treated, resulting in 458 300 (549 280) kg of uranium oxide being produced.

Br Day

~~217~~

~~217~~

217

# Weak rand insulates SA asbestos industry

2/10/85

STEPHEN CRANSTON

ONLY a year ago, the prospects for the South African asbestos industry were gloomy

In June 1984 the operating income of asbestos producer Msauli fell from R1,8m to R822 000 for the first six months of the year, a fall of more than 50%, and production at the mine declined by 20% as a result of Cyclone Domoina

The other main producer, Griqualand Exploration and Finance (Gefco), experienced a fall of 24% in income

Worse seemed to follow as the United States Environmental Protection Agency (EPA) began a campaign to ban asbestos from that country

In October 1984 the Black Allied Mining and Construction Workers Union (BAMCWU) called for an end to asbestos mining because of the hazards of occupational and environmental exposure to the material

This year, however, there has been a turnaround in fortunes

Most importantly, the Msauli mine overcame its underground difficulties with a considerably expanded capital expenditure programme

In February the EPA called off its

banning campaign which had threatened the major market for blue asbestos. By May there was talk of a possible repeat of the spectacular growth of 1974/76, when Msauli shares went up from 33c to 540c and Gefco from 110c to 1 450c

However, a Gefco spokesman warned of too much false optimism

"There is still a glut in the world supply of asbestos," he said "The turnaround can largely be attributed to the weak rand/dollar exchange rate. Although in our June figures we were slightly ahead with profits, our sales were down in volume

"The dollar price itself is under pressure and we cannot be sure that all our orders will materialise. I think though that we are seeing the bottoming out of the decline"

The company has no fear that artificial substitutes such as sisal will pose a major threat to asbestos

"The main market for asbestos is in underground areas. Sisal will never be able to compete in that area as it is known to be perishable while asbestos is effectively indestructible"

1  
2  
3  
4  
5  
6  
7  
8  
9  
10  
11  
12  
13  
14  
15  
16  
17  
18  
19  
20  
21  
22  
23  
24  
25  
26  
27  
28  
29  
30  
31  
32  
33  
34  
35  
36  
37  
38  
39  
40  
41  
42  
43  
44  
45  
46  
47  
48  
49  
50  
51  
52

the total...  
AND WESTERN RIVER  
now to...  
17



# SA turmoil: US Congress urged to plan to ensure mineral supply

11/10/85 -  
WASHINGTON - The United States does not face mineral shortages in the near future because the political turmoil in South Africa does not threaten exports of the products US officials told Congress yesterday.

But several officials said the US would be wise to make long range plans.

"The danger in the region is not so dramatic as to threaten in the short run our capacities to import minerals," Deputy Secretary of State Mr Frank Wisner told a House of Representatives subcommittee.

The US however, did not control the situation in South Africa so it should be certain it "has the abilities to assure the smooth functioning of our economy", he said.

The question of US dependence on South Africa's minerals had not been adequately discussed in the American debate over Pretoria's racial policies according to Mr Robert Wilson director of the Commerce Department's office of strategic resources.

Mr Wilson said the US obtained the following amounts of

its imports from South Africa chromium, 55 percent platinum, 49 percent vanadium, 44 percent and manganese 39 percent. Also 61 percent of the US cobalt consumption flowed through South African ports.

These minerals were considered "strategic and critical" for industry as well as defence. He noted that the Soviet Union was

217 STAR  
much less dependent on imports than the United States.

Mr Wilson said there was no indication that South Africa would retaliate against US sanctions by withholding minerals as they played a large role in South Africa's economy.

Mr Robert Horton director of the Interior's Bureau of Mines said South Africa was a "highly reliable" trading partner and he believed "a revolution would be very difficult because of the strength of the army."

To protect against mineral shortages in a national emergency or military conflict the US had a minerals stockpile - Sapa-Associated Press

cap. TMS 21/10/81  
21%

# Samancor lifts earnings 295%

JOHANNESBURG — Samancor's earnings have continued to surge ahead, and the company's attributable income for the half-year ended August 20 was higher than for the preceding full financial year

The interim results show earnings per share of 75,70c for the half-year, up 295 percent on the 19,19c for the comparable period last year and 14 percent higher than the 66,38c for the previous full year

Attributable income for the half-year was R113,3m against R28,7m for the previous half-year and R99,3m for the full year, while turnover rose 40 percent from the previous half-year to R333m

The directors expect profits for the second half of the year to accrue at the same rate, provided there is no marked strengthening of the rand.

In their comment on the results, the directors note that Samancor's major facilities all operated at a high level and made a satisfactory contribution to profits. The company also benefited considerably from the continuing weakness of the rand

They point out, however, that several markets softened during this period and the effect that the high rate of inflation is having on costs continues to be a matter of concern.

Dealing with the major products, the directors noted:

● Manganese ore: sales continued at a relatively high level and dollar prices have generally remained steady

● Manganese alloys the market has moved into oversupply and prices in dollar terms have weakened

● Chrome alloys the market has moved into oversupply and one of the furnaces at Ferrometals has been taken off production to prevent a stock build-up.

● Chrome ore: domestic demand eased but the export market remained firm. Export prices have, however, come under pressure.

● Silicon: certain markets for silicon metal have weakened and prices in these markets have softened. Silicon Smelters is, however, producing at maximum capacity

The company has declared an interim dividend of 30c per share. This represents an increase of 200 percent on the 10c interim paid last year — Sapa



Fears SA cut-off could hit hard

24/10/85

# US studies P.W.'s chromium threat

217 B. Deary

WASHINGTON — President P.W. Botha's threat to suspend chromium exports in retaliation for anti-apartheid sanctions has sparked disagreement among US experts over the impact of such a move.

The Australian government reacted warily. Trade Minister John Dawkins suggested some form of trade retaliation might be considered if Pretoria carried out the threat.

Citing US dependence on SA as a supplier of chromium, Botha said this week

"By digging a hole for SA, they could end up harming themselves."

Chromium is one of several strategic materials, along with manganese, cobalt and platinum, of which southern Africa is a primary supplier for the US and other Western nations. Chromium has a myriad of metal applications including aircraft, vehicle and everyday consumer products.

US Representative Don Fuqua, chairman of the House Science and Technology Committee, said Botha's threat should be taken seriously because a cut-off of chromium could have serious economic consequences. Sudden and prolonged loss of supplies could hurt the car industry in particular, he said.

"It could have a great deal of impact. This is as critical as petroleum products in the long run."

Some US experts doubt that Pretoria would retaliate against US economic sanctions with a chromium cut-off because of the importance of the mineral to the SA economy.

But Fuqua said Pretoria might forgo the income and jobs because chromium amounted to only about 1% of SA's gross national product.

By law, the US maintains a stockpile of as much as three years' supply of chromium for national security uses. Industry, however, has no more than a one-to-two-month supply stockpiled. In 1982, the US bought 48% of its chromium from SA, which produced 34% of the world total, and only 12% from the Soviet Union, which produced 33%.

Marshall Watson reports that Botha's remarks sparked the *Melbourne Herald* headline "Trade war looms over S Africa" and that *The Australian* treated "S Africa's staines" steel ransom.

Opposition foreign affairs spokesman Andrew Peacock said Botha's reaction to the threat of Commonwealth sanctions highlighted what the opposition had warned was the problem with trade embargoes — they work both ways — Sapa-AF

## Zimbabweans rush to choose citizenship

Own Correspondent

HARARE — With the deadline for renouncing foreign citizenship only a week away, hundreds of Zimbabwean dual citizens are jamming the registrar-general's office in Harare seeking to "regularise" their nationality.

More than 8,100 have already officially handed over a foreign passport, in most cases a British.

Renunciation of British citizenship is valid only if made in a British court. The British High Commission in Harare has promised to return the passports if their previous owners ask for them. But it may be a while before it is in a position to do so.

Zimbabwe is obliged to give the passports to the High Commission but appears to be in no hurry to hand them over.

Zimbabwe banned dual citizenship last year after constitutional protection lapsed. Dual nationals have been given until October 31 to choose between Zimbabwe and their second country.

Dot Wilson, left, is still working, but her fellow sufferer Ena Penderis has died since this picture was taken.

# Victim of the killer asbestos

Argus 22/11/85 (217) (123)

**KATE MCKINNELL**  
in Johannesburg

MRS Dot Wilson is dying from cancer caused by a substance she never handled — asbestos

Both her parents died from asbestos-related diseases. Her two brothers fear they too will be victims.

Recently, Mrs Wilson, of Pretoria, heard of the death of Ina Penderis, a friend with whom she formed Asbesta, an organisation for asbestos victims

The dark rings around Mrs Wilson's eyes are the only clues to her illness. There is no self-pity, just steadfast acceptance — she refuses to make her cancer a major issue

But she is determined to warn the public about the dangers of asbestos, and she is angry with company directors who claim that safety precautions have removed the deadly threat of the mineral

## Protection

"I don't see how asbestos mining could ever be safe — asbestos affects the whole environment. It is not only people in direct contact with it who need protection

"The fibres are barely detectable and the effects insidious," she says

Her account of how asbestos infiltrated her life sounds like a science fiction horror movie.

Mrs Wilson's father was a mine supervisor. Her family first moved to an asbestos mine at Koegasbrug in the northern Cape when she was eight. Later they moved to another mine at Pomfret.

Mrs Wilson went to school in Kimberley, and only stayed in the mine home during school holidays. During the Christmas holidays the family would go to the sea.

## Distinctive

"I don't think I ever touched the mineral. I never played on the dumps or went to the mine. When my father came home, he always had a distinctive smell.

"But the fibres in the air are hardly noticeable, although I remember seeing them mingling in the soil and sticking to fly traps hanging in homes."

In 1979 when routine tuberculosis tests were done at the Pretoria office where Mrs Wilson worked as a secretary, she was told she was suffering from TB and was treated for the disease for over a year

"I cannot remember how often I told doctors I had lived on an asbestos mine, but I suppose they just

weren't tuned in to the implications of this.

"When TB treatment didn't help, I was referred to a thoracic surgeon, and after doing tests, the first thing he asked me was whether I had lived on an asbestos mine"

## Mesothelioma

In 1981 she was told she was suffering from mesothelioma, an incurable cancer of the lung lining directly caused by asbestos

"I seem to have lasted longer than most. I've even been able to work, although I do get very tired. I need a week to recover after cobalt treatment every month," says Mrs Wilson

Her daughters, aged eight and 10, know their mother has cancer. Mrs Wilson says they and her husband are a great support

Last year she met Ina Penderis and they formed Asbesta, to create public awareness about asbestos and to help sufferers from asbestos-related diseases

They have heard from people who have had contact with asbestos and are now doomed with directly related illnesses. Not all have lived near mines — some are laboratory workers, others transporters who loaded the asbestos.

"Most of the response has been from people who need financial help. Mining companies only pay compensation to people they have employed — a small proportion of those who have been exposed to asbestos

## Alternative

"I wish we could create more awareness among people working at asbestos mines — how can those mothers take their children to live in places like that?"

Mrs Wilson says claims that safety standards have been improved and asbestos is safe to handle can only be proved after 20 years — the effects of asbestos can take decades to manifest themselves

Asbesta is campaigning for alternative materials to be found for manufacturing items like heaters, plant pots, hairdryers and toasters.

"Who knows the danger of asbestos in these items? A report from overseas showed asbestos-related disease in someone who lived near a stop street — she had been affected by the asbestos fibres from car's brakes," says Mrs Wilson

Asbesta's appeal for alternative materials aims to reduce mining of the material and therefore the number of people handling it.



... in Durban that during a cent o which had fewer than happy

# Black Mountain exports 1m tons

**TOM HOOD**

THE millionth ton of lead concentrate from Black Mountain mine in the Northern Cape is on its way to Saldanha Bay for shipment overseas on a bulk ore carrier.

This milestone will be celebrated at Saldanha on Monday, December 9 when top executives of Black Mountain and its majority shareholder Gold Fields of South Africa will thank suppliers of services as-

sociated with the exports including South African Transport Services Southern Shipping Reinforce and Freight Services.

Export earnings have been boosted by the weak rand and Black Mountain has been able to repay more than R15 million of its outstanding loans this year.

In the September quarter a R5 million repayment reduced borrowings to R40 million.

Net profits have risen dramatically with more than R38 million being reported over the last four quarters.

Earnings reached R9.8 million in the September quarter a 44 percent improvement on June's R6.8 million.

Sales of lead and silver raised revenue by R1 million to more than R25 million while the mine benefited from lower costs including a R2.5 million saving in finance charges in that quarter.

BUS DAY 6/12/85

# Palabora set to sink costly, new shaft soon

217

ROY BENNETTS

PALABORA Mining is expected to advance the date of its plans to sink a shaft below the present open-pit operation.

The expenditure could be financed internally, by retained income or by going to the market for fresh funds.

At this stage, it is not clear if an announcement is imminent.

In line with the greater depths required for the recovery of the copper ore body, the circumference of the pit has widened to the point where it is encroaching on the lease area of neighbouring Foskor.

Palabora is said to be the second-largest open-pit mining operation in the world.

As the depth of mining increases, the shelving spiral of access roads need to lengthen by the depth plus the extra width. The additional expenditure of transporting rock to the surface is causing a significant change in the cost structure.

Palabora, which has a large fleet of heavy trucks and uses a considerable amount of power, is particularly vulnerable to the recent increases in

electricity tariffs and the fuel price. But Palamin has developed a trolley-assist haulage system to reduce its use of diesel.

Palabora is riding on the crest of the high rand exchange rate for electrolytic copper at R3 613 a ton now, but physical demand for the metal on the London Metal Exchange is reported to be on the wain, with prices falling.

This scenario leaves Palabora exposed to a lowering of income, from either a strengthening of the rand or a drop in the international copper price.

Galloping increases in power and energy costs could cause Palamin's profits to narrow sharply.

The sinking of a shaft to exploit an ore body below an open-pit is not a new venture in the mining industry.

In 1980 Botswana's copper/nickel producer, Selebi-Pikwe, developed a shaft under its pit operations, as did diamond producer Koffiefontein.

The cost of sinking a shaft will run into a nine-figure amount.



# Bright future for platinum this year

CME Trade 6/12/85

## — Shearson

(217)

LONDON — The platinum market is expected to improve, in relation to gold, for the rest of this year and in 1986 with its premium to gold rising further, broker Shearson Lehman Brothers said in its weekly metals markets review

The premium is currently around \$20 to \$25 compared with an average \$41 discount in the first half of 1985 and a \$4 discount for the whole of 1984.

Platinum's superior fundamental and strategic importance to the Western world should enable it to outperform other major precious metals which are suffering from lack of investor

interest due to low levels of inflation, Shearson said.

The importance of South Africa as the West's major platinum supplier, relatively low above ground stock levels and platinum's strategic importance in the chemical and petrochemical industry has prompted substantial buying from trade sources looking to secure future supplies

Longer term investors are also tending to maintain their holdings in platinum in case the situation in South Africa should deteriorate sharply, Shearson said

The chart outlook is currently constructive, pointing to \$425 in the

longer term, but gold is expected to continue to encounter heavy resistance in the \$330/343 range

In its non-socialist world supply/demand forecast for 1985, Shearson puts the platinum market in a small surplus of 0,8 tonnes which, coming after 1984's 2,2 tonnes deficit, shows the market is reasonably tight in spite of an increase in South African mine production to a forecast 71,3 tonnes from 65,1 tonnes in 1984.

Total supply, including Soviet sales, is forecast at 91,5 tonnes in 1985 against 82 in 1984 while demand is put at 90,7 tonnes against 84,2, Shearson said.— Reuter

bus 207 11/2/86

# Sishen-Saldanha back on tracks

SHIPMENT from Saldanha Bay yesterday of the one-millionth ton of metal-concentrate from the Black Mountain Mine, at Aggeneys, has highlighted an upsurge of activity on the controversial Sishen-Saldanha railway line

The poor performance of the rand has injected new life into the line which has incurred huge losses in the 10 years of its existence

The one-millionth ton of metal-concentrate forms part of a 13 689-ton consignment from Aggeneys, in the north-west Cape, loaded into the Greek bulk-

carrier George, which sailed for Antwerp yesterday

The Black Mountain Development Company is a lead, zinc, copper and silver-mining joint venture by Goldfields of SA and Phelps Dodge Corporation of the US

Neels Hubinger, area manager of SA Transport Services, said the carriage of ores, including concentrates from Aggeneys, on the 861km Sishen-Saldanha line had recently increased to 60% of the line's full capacity — Sapa



# Rand's decline boosts ore traffic

By ROGER WILLIAMS  
Chief Reporter

SHIPMENT from Saldanha Bay today of the one-millionth ton of metal-concentrate from the Black Mountain mine at Aggeneys has highlighted an upsurge of activity on the controversial Sishen-Saldanha railway line

Ironically, the poor performance of the rand against other currencies is having the reverse-benefit effect of injecting new life into this "white elephant" line, which has incurred huge losses in the 10 years of its existence

The one-millionth ton of metal-concentrate forms part of a 13 689-ton consignment from Aggeneys, in the north-west Cape, loaded into the Greek bulk-carrier George, which sails for Antwerp today

The Black Mountain Development Company is a lead, zinc, copper and silver-mining joint venture started six years ago by Gold Fields of SA and Phelps Dodge Corporation of the US

● A "very optimistic" Mr Neels Hubinger, area manager of SA Transport Services for the North-West Cape, said the carriage of ores including concentrates from Aggeneys, on the 861km Sishen-Saldanha line, had recently increased to 60 percent of the line's full capacity — 18 million tons a year

Mr Hubinger said three 120-truck ore trains a day were now using the line and that 10,5 million tons would be moved in the 1985/6 financial year. This figure was expected to increase by two-million tons next year

# Fired NUM strikers in hostel row

*Stow* *NUM* *217*  
*19/12/81* *217*

About 1 000 members of the National Union of Mineworkers (NUM) yesterday barricaded themselves in their hostels after being fired by the Phosphate Development Corporation (Foskor) in Phalaborwa last Thursday, a union spokesman said

The spokesman said last night management had agreed to refer the dismissals to mediation

The strike was to back a demand for the reinstatement of 389 colleagues fired for striking last December

The spokesman said workers had staged a three-hour stoppage on Thursday. Management promised to look into their grievance, but when workers tried to return to work they were harassed, he said

Foskor's managing director, Mr John Stanbury, confirmed workers had been dismissed after going on an illegal strike. He said the union had informed management of the reason for the strike only after it had taken place. He said the company was negotiating a recognition agreement with the NUM



# Sacked miners occupy hostel

217 (13) 152 151

From PHILLIP  
VAN NIEKERK

JOHANNESBURG — About 1 500 miners fired from Foskor's phosphate mine near Phalaborwa in the Eastern Transvaal have occupied their hostels in Namakgale, Lebowa, and are refusing to budge

A spokesman for the National Union of Mineworkers (NUM) said yesterday the workers had barricaded themselves into the single-men's quarters and were being fed and supported by local township residents

This was confirmed by Foskor's managing director, Mr John Stanbury, who said the workers had closed the gates with wire and shaft stewards were in control of the quarters

The workers were fired last week for refusing to go underground and demanding the reinstatement of 391 workers sacked a year ago for striking in protest against the detention of NUM general secretary Mr Cyril Ramaphosa

Mr Stanbury said the company had agreed to refer the dismissal of the 1 500 to mediation between Foskor and the NUM. He said that the mine — which has a workforce of 2 800 — was still operating at "full capacity" and that "those reporting for work have done a magnificent job"

Mr Stanbury said management would weigh up the forceful eviction of workers from the hostel very seriously

"We are trying at all costs to avoid confrontation which could spill into violence," he said.

MINING - OTHER

1986

JA - DEC.



ARGUS 7/1/86

## Platinum price soars after firing of miners

The Argus Correspondent

217

JOHANNESBURG — The firing of virtually its entire workforce by Gencor's Impala Platinum has sent shock waves through international markets, and the price of the metal has soared

In London the metal was fixed at \$349,74 — about \$8 up on the previous day, while in New York the price gained about \$15.

On the stock market yesterday Impala's share price rose 125c to 3 150c in reaction to the platinum price rise, rather than news of the sackings

Three of Gencor's platinum mines in Bophuthatswana yesterday fired 20 000 striking employees

According to Gencor no union has been involved as the National Union of Mineworkers is not recognised in Bophuthatswana.

The NUM claims it has 50 percent membership at Impala and said the strike was against low wages, long hours and Gencor's refusal to give the union recruiting facilities.

as a New year

# Record 20 000 workers fired

7/1/86 Mercury

**JOHANNESBURG**—In the largest-ever mass dismissal by a South African corporation, Gencor yesterday fired 20 000 workers from its Impala Platinum Mine near Rustenburg in Bophuthatswana

The jobs of a further 10 000 workers at the mine are also at stake if they fail to meet a deadline to return to work today

The mass dismissals have caused shock waves within the South African labour movement

The president of the Congress of South African Trade Unions Mr Elziah Bhebe yesterday called Gencor to reinstate the workers immediately and said he would discuss national action with his executive

The workers were fired for participating in strike action since New Year for pay rises and shorter working hours.

### Ultimatum

The acting chief executive of Impala Mr Gary Maude told a Press conference yesterday that the dismissals followed a warning to the workers to the effect that continued participation in an illegal strike would be in breach of their employment contracts

The workers fired were from Wildebeestfontein North and South and Bafokeng South Those from Bafokeng North and Mineral Processes have been given an ultimatum to return today

About 65 percent of the workers are from Bophuthatswana and the rest are from various South African territories, but nearly all live in company hostels from which they were being evicted yesterday

Mr Maude said the com

### Mercury Correspondent

pany had attempted to negotiate with elected representatives of the workers but 'you run into a point where they get completely unreasonable

He added The alternative is to get rid of the whole labour force and replace them There is a condition of massive unemployment in the country and this has encouraged us to take this sort of action

Mr Maude denied that recognition of the NUM which as a South African union is outlawed by Bophuthatswana labour law had been raised as an issue by the workers

Mr Barayi, himself a mineworker threatened 'Gencor must reinstate immediately or Cosatu will take action I shall have to call my executive immediately and we even have to consider national action

Gencor's dismissal is the largest ever by a South African corporation beating the previous highest by Anglo American's Vaal Reefs mine which fired 14 000 workers in April last year

### Kim's on the ball at Expo

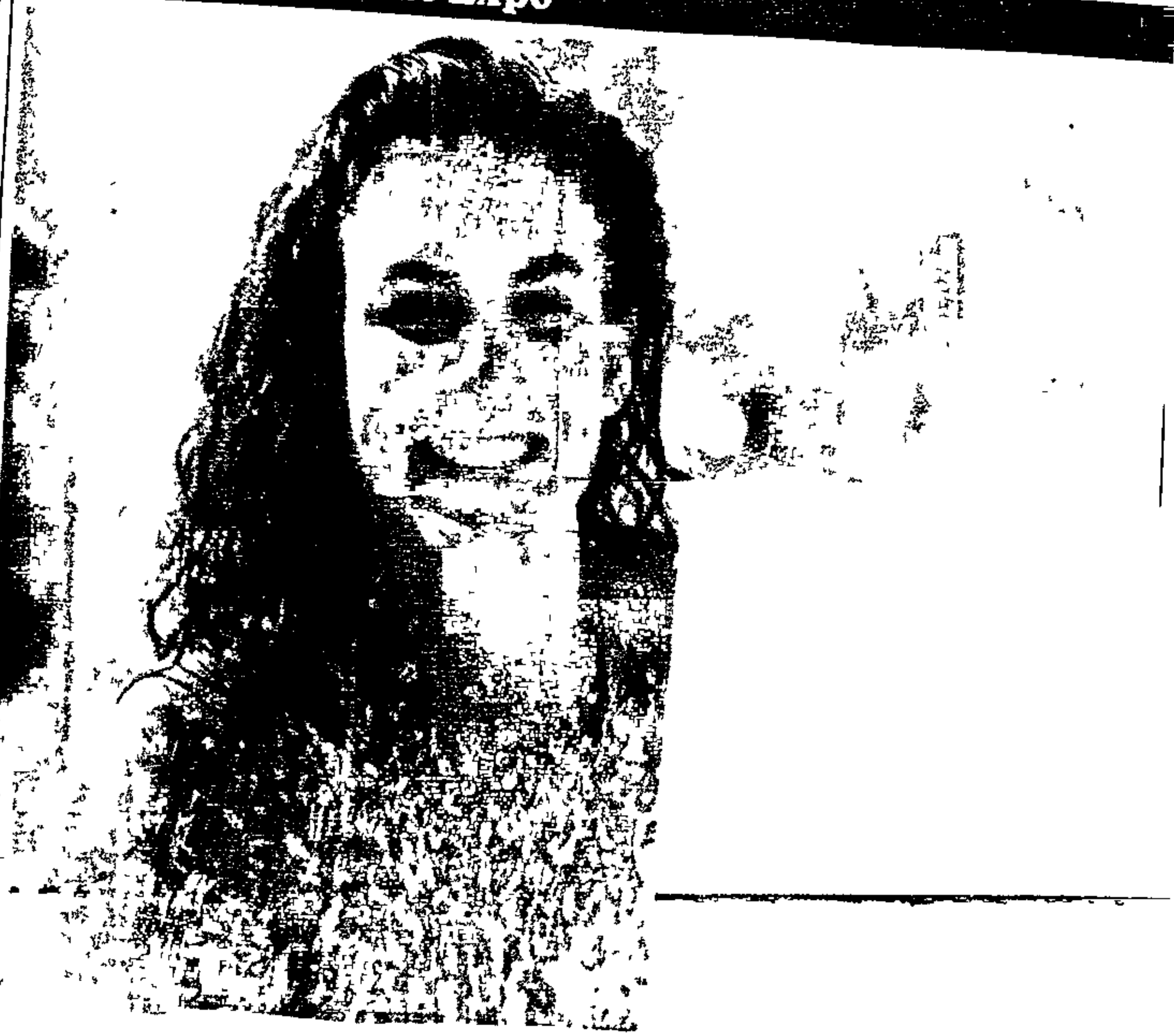



# 20 000 sacked: mine union seeks Govt help

7/1/86  
D17

MAFIKENG — The Bophuthatswana National Union of Mine Employees, Bonume, is to hold a meeting at Tlhabane near Rustenburg on Friday, in an attempt to solve a dispute between employees and management of the Impala Platinum Mine in which 20 000 workers have been dismissed.

The Bonume secretary, Mr Edwill Phosisi, said they would also draft a resolution asking the Bophuthatswanan Manpower Co-ordination Minister, Mr S.L.L. Rathebe, to establish a conciliation board and to appoint a commission of inquiry to investigate alleged assaults on black mineworkers by whites.

He said the matter had been reported to the Bafokeng police many times, but nothing had been done.

The Bophuthatswanan Government had not been notified about the dismissal of 20 000 employees of the Impala Platinum Mine, Mr Rathebe, said last night.

He and senior Government officials had visited the mine yesterday to assess the situation and at the time they left the mine, at about 3pm, only 30 miners were to be have been dismissed, he said.

The Government would comment again after con-

tacting Gencor today, he added.

The affected workers were employed at three of the Impala mines — Wildebeestfontein North, Wildebeestfontein South and Bafokeng South.

Management has also issued an ultimatum to the remainder of the black work force, who are employed at Bafokeng North Mine and Mineral Processes, to return to work today or also face dismissal.

The dismissal of workers at Wildebeestfontein North mine, Wildebeestfontein South mine and Bafokeng South mine is proceeding in orderly fashion. It is expected that it will take several days to complete discharge formalities.

At Bafokeng North Mine and Mineral Processes about 2 000 workers have returned to work and this trend is continuing.

The situation at all four mines and mineral processes remains peaceful.

The strike, over a variety of grievances including wages and working conditions, began on January 1.

At a Press conference in Johannesburg yesterday, Mr Gary Maude, Impala's acting chief executive, said

every effort had been made by management, as well as the Bophuthatswanan Government, to sort out the workers' grievances.

Political factors also appeared to be at work as there had been a pattern in negotiations during the strike where worker representatives displayed an unwillingness to resolve the dispute, he said.

Several meetings had been held with worker elected representatives since the illegal strike began but to no avail.

After the work stoppage on January 1 when most of the workforce went out on strike about half the workforce returned on January 2, Mr Maude said.

The situation had deteriorated since then and yesterday all the workers with the exception of a few hundred were out on strike.

However with many experienced black gold miners out of work in Bophuthatswana and elsewhere at present, management hoped to be able to replace a large proportion of the dismissed workforce with experienced workers.

Mr Maude said there was very little likelihood of any of the dismissed workers being re-employed.

BU) DAT (40) (855)  
8/11/86  
Gencor starts  
paying off (217)  
20 000 miners

SIPHO NGCOBO and  
CLAIRE PICKARD-CAMBRIDGE

THE Gencor-controlled Impala platinum mines in Bophuthatswana began paying off 20 000 miners yesterday amid unconfirmed reports that 19 workers had been taken to hospital after mine security had shot at them with rubber bullets.

Gencor said yesterday the dismissal of striking workers at three of its mines — Wildebeestfontein North, Wildebeestfontein South and Bafokeng South — was proceeding peacefully and orderly.

However, workers alleged considerable violence and their reports varied as to whether clashes with mine security at the three mines had taken place on Sunday or Monday.

Workers at the Bafokeng South mine yesterday said 19 workers had been seriously injured and taken to mine hospitals after clashes with mine security.

They said another 20 had been injured after mine security had used tear gas, gun butts and batons in an attempt to force them to return to work.

Gencor said about 2 000 workers at the Bafokeng North mine and Mineral Processes had returned to work yesterday after receiving an ultimatum.

The workers had gone on strike over wages and working hours, among other grievances.

Worker representatives yesterday said Gencor had been informed of worker grievances before the strike began on January 1.

Bafokeng South mine was like a war zone yesterday as thousands of miners queued for paypackets and were escorted to nearly 100 buses by heavily-armed security personnel.



# Mine workers paid off



8/1/86.  
THOUSANDS of dismissed black mineworkers at the Gencor-controlled Impala Platinum Mines in Bophuthatswana were yesterday paid off and transported back to their respective "homelands".

This was confirmed by the company's acting chief executive officer, Mr Gary Maude, who said the dismissal of workers was proceeding in an orderly fashion.

The dismissed workers were mainly from the Transkei, Lesotho, Zimbabwe, Swaziland and other neighbouring states. They worked at Wildebeesfontein North Mine, Wildebeesfontein South and Bafokeng Mine.

At Bafokeng about 2 000 workers returned

to work yesterday morning after an ultimatum to return or face dismissal.

**SOKEETAN**  
The workers went on strike over working and wages-related issues since January 1 this year.

Meanwhile the 600 workers employed at the Lewisham engineering yard of the Department of Posts and Telecommunications near Krugersdorp who staged a walk-out in protest against poor wages and alleged unfair dismissal yesterday returned to work after management made certain promises.

A spokesman for the department in Pretoria said workers returned after management had promised to investigate their grievances.

HR 695 8/11/80 217

## All quiet at Gencor strike mines

JOHANNESBURG. — The situation at all four Gencor mines and minerals processes in Bophuthatswana — where 20 000 workers were dismissed this week following a strike — is peaceful, according to a Gencor statement

“No person has been seriously injured by either security personnel or striking workers. Teargas and rubber bullets were used to disperse a crowd, but there were no serious injuries,” the statement said.

### UNDECIDED

The Bafokeng North mine and mineral processes had a “good turn-out to work today”.

However, about 3 000 workers were apparently undecided whether to return to work.

About half the labour force had been paid off at the three mines, and most transported home — Sapa



# Platinum soars to \$361,25 after Impala strike

From MARTIN HAYES

LONDON. — News that Impala Platinum had dismissed 20 000 workers, two thirds of its workforce, lifted prices in the platinum market here to highest levels since early July 1984.

The metal rose to \$361,25 a troy ounce last night on speculative and fund buying, compared with an afternoon fix of \$349,75

Earlier in the day speculative selling in fairly active nervous conditions pared gains slightly, and platinum was fixed at \$356,75, before renewed buying lifted prices over \$361, dealers said

## Premium

Since the beginning of the year, when the strike at Impala's four South African mines began, platinum has risen from just under \$342

Its premium over gold has similarly advanced

Platinum is more vulnerable to supply disruptions, as South African output accounts for some 80 percent of total world non-communist production, dealers said

By comparison, South Africa mines only around 60 percent of non-communist world gold output, and this metal consequently tends to react less to fears of supply difficulties than the more thinly-traded platinum mar-

ket. Buoyed by strong platinum prices gold rose to the highest levels for six weeks yesterday afternoon, when the price touched a high around \$331, before settling back slightly to the fix, dealers said

Activity quickened yesterday afternoon, after a generally quiet morning, with some commission house buying absorbing scale-up trade selling

Prices also rose on the Nymex futures market on Monday, closing just below fresh contract highs

## Monitoring

Dealers said although most of the activity in London appears to have been speculative, industry-based business has risen over the last week

Traders will be monitoring the Impala situation closely over the next few weeks to see if the dispute continues

Impala is likely to be able to utilize its stocks in the short-term, and also hire experienced replacement labour, thus having little discernible effect on supply, they noted

However, should inventories decline significantly, further price gains will be prompted by fears of a supply shortage

In New York, Comex gold futures stood at six-week highs on sympathetic buying from a strong platinum market, analysts said

The key February gold delivery added \$2,30 to \$333 an ounce, the strongest level since November 27

## Buyers

Analysts said commission houses and fund traders were net buyers, with platinum soaring for the second day to new contract highs on worries over possible output losses resulting from the recent labour problems at South Africa's Impala Platinum mines Dealer houses sold into the rally, they said

● Silver bullion also moved higher yesterday afternoon, tracking the pattern of the other dominant precious metals it rose to around 590c an ounce from a midday fix of 584,50c — Reuter

CAPT TINTS

217

Handwritten scribbles and initials

Handwritten vertical text

F

JO

Th

the

rie

ing

ag.

clo

eri

l

qu

the

ly

abl

this

pre

T

and

ref

pri

wit

and

pot

boo

clo

JO

Th

the

rie

ing

ag.

clo

eri

l

qu

the

ly

abl

this

pre

T

and

ref

pri

wit

and

pot

boo

clo

\$0,

its

on

A

cut

clo

US

UK

Ger

Swi

Net

Fra

Jap

—

1

217  
~~217~~  
~~1/2/86~~

CAPE TIMES 9/1/86  
**Gencor sacks  
another 3 000**

From PHILLIP VAN NIEKERK

JOHANNESBURG — Gencor fired 3 000 more workers at its Impala Platinum mine in Bophuthatswana yesterday — bringing to 23 000 the total axed

The workers, from Bafokeng North, were described by the company as having "voluntarily" decided to return to their homes after they failed to meet an ultimatum to return to work yesterday

At the Wildebeesfontein North section of Impala, mine security arrested 48 miners and handed them over to the Bophuthatswana authorities at Phokeng after teargas and rubber bullets were fired

A spokesman for the National Union of Mineworkers, Mr Marcel Golding, said 27 workers had been shot and 26 hospitalized

The union believed the workers were arrested because they were suspected of being "activists"

Lieutenant-Colonel Dave George of the Bophuthatswana police confirmed that the men had been arrested by mine security

The acting chief executive of Impala, Mr Gary Maude, said strikers surrounded a security vehicle and were dispersed by rubber bullets and teargas

He said no serious injuries resulted though "two or three" workers had been hospitalized

Mr Maude said that by mid-afternoon yesterday 14 000 out of the original 20 000 fired on Monday had left the mine

"The next step will be a decision to start employing again. I'm surprised how quickly we could properly discharge people," he said



Gencor has been criticised for handling industrial relations problems with heavy handedness. Some describe Gencor as the mining house with the most hardline labour policy. What is your response to this?

Fritz: I do not believe this perception is correct. The National Union of Mineworkers (NUM) reportedly said the dismissal of workers at Impala Platinum was "characteristic of Gencor's despotic manner" of dealing with workers' grievances. But anybody who believes this is unfounded.

We have a fundamental interest in our employees, find their problems important and give them important consideration. If one is to have a sense of security and a feeling of belonging, you want to know exactly where you stand. We believe we are just as fair and do not vacillate unnecessarily. It is my experience with people I've worked with that they appreciate a clear position.

Gencor has the top safety and productivity record in the industry and could not have achieved this with unmotivated workers who've been handled heavily handedly.

We also have a large number of long service employees and believe our turnover situation in black labour is lower than in the industry generally.

We have always had a principle of placing our people within the Gencor group in the event of changes and an example is the fact that we did not put anyone on the road following the closure of our Beisa Mine in the Free State.

We've been firm and definite, but this headline perception probably arose when we did not change our position after deadlocking with the NUM in the Chamber of Mines negotiations last year. We

# Collision course not our intention — Gencor boss

CLAUDE PICKARD-CAMBRIDGE

IMPALA Platinum in Bophuthatswana is presently in the centre of a storm following the largest-ever mass sacking of 20 000 striking workers from the company's mines, in which Gencor has a major interest. *Business Day* interviews Gencor's executive mining director Johan Fritz on the company's labour policy.

mean we are cast in concrete and do not realise things are changing in SA. It means we must look at ourselves more critically and if we can find anything which can be regarded as unfair we'll address the problem.

A wide gap existed between Gencor's wage levels and labour policies and those of Anglo American, Johannesburg Consolidated Investments (JCI) and Rand Mines after last year's annual wage negotiations. Does Gencor wish to move closer to these mining houses on those issues in future?

SA has a shortage of skilled people and an oversupply of the unskilled. Gencor has a steep wage curve to encourage people to try and climb up the ladder. We have a large training programme for this purpose. While our unskilled workers are on rates below the top payers in the industry, our more skilled workers are practically in line with them. It would be far easier if we were to be closer to the three mining houses. We are relatively close to other houses and usually act in unison with them through the Chamber of Mines.

I believe our present wage gap is largely due to the 11th hour decision by these three mining houses to improve their offers during last year's wage negotiations, while we stuck to our guns.



GENCOR'S Johan Fritz talking to Claire Pickard-Cambridge

The NUM claims Gencor has set itself on a collision course with the union and is trying to teach the union that strike action will consistently result in dismissals. Is this justified?

This claim is definitely not true. We have not set ourselves on a collision course with the union and have no intention of union bashing. We want to act in the best interest of our customers, shareholders and employees and welcome unions as a means of improving communication with workers.

What is Gencor's attitude towards Bophuthatswana legislation which effectively prevents freedom of association by prohibiting SA unions from operating there?

And what is Gencor's response to news of proposed Bophuthatswana legislation which will grant mining workers in the territory?

We are operating in an independent state. This would be the same as operating in Brazil, Australia or elsewhere and our attitude is to act responsibly in the host country, whatever their laws should be.

who have just been sacked? I do not believe this. If I refer this to the case at Impala Platinum the problem is not one of worker-millicance but of very definite intimidation. Intimidation was so strong that our own employees were disappointed in our ability to protect them.

But I don't want to comment on Impala Platinum because although Gencor has a major interest in it we see Impala as an independent unit with its own spokesman.

Does Gencor believe that dismissing and rehiring workers is often a useful tactic to break a stalemate, or that workers eventually regard dismissal threats less seriously if they believe they will be rehired?

We consider every situation on its merits. But I'm sure people will not take warnings seriously if they expect to be rehired. I am not a game-playing person. We make well thought-out moves, are sincere and honest and make decisions after thorough deliberation.

Gencor was found guilty of an unfair labour practice when it fired legally striking workers under specific circumstances at Marikwa last year. Has this led Gencor to consider amending any of its labour policies?

We do not agree with the finding and have taken the Marikwa matter under review with the Supreme Court. It has not led us to believe we need to change our labour policies. This does not

Strike action will not consistently result in dismissal. Dismissals will only result if circumstances are appropriate.

If we are invited to comment on these laws we do so. Have you been invited to comment on these laws in Bophuthatswana?

We've had the opportunity to comment on various laws, but I would not like to elaborate on this. We are not involved in government decisions.

Does Gencor believe an entirely new labour force will necessarily be less militant than workers rehired?

We are probably the most widely based mining house in the country and are involved in many different industries which are competitive in world markets. We can not make a wage decision outside these realities.

Is Gencor more concerned about the effect of its actions on the local and international community in the present delicate political and economic situation in SA? Yes, we are more sensitive now and everyone should be, but this cannot be at the expense of our basic principles.



# Dismissals: Labour law discrepancy blamed

The dismissal of 20 000 striking miners in Bophuthatswana has sent shock waves through the international platinum market. SHERYL RAINE looks at some of the issues underlying the strike.

THE strike by 30 000 black miners at the Gencor-controlled Impala Platinum mines in Bophuthatswana has shattered expectations in the mining industry that the platinum sector would be left largely unscathed by labour unrest which has recently troubled gold and coal mines in South Africa.

Predictions by some financial advisers that Impala would remain protected by Bophuthatswana's labour laws and safe from disruptions in production for at least two years while the government-approved Bophuthatswana National Union of Mine Employees (Bonume) became established, have proved to be unfounded.

Scratch the surface of the strike debacle and a host of issues tumble to the fore.

Firstly, and what many observers believe is at the root of the trouble, is the discrepancy which exists between labour legislation in South Africa and that in the homelands.

Research has shown that without exception workers in the homelands are subject to more repressive labour legislation than in South Africa and that the Wiehahn reforms have largely failed to trickle over the borders into the national and independent states.

Labour unrest, however, is trickling over the borders, as this week's dispute seems to indicate.

In Bophuthatswana, the Bophuthatswana Industrial Conciliation Act of 1984 governs collective bargaining, places a ban on "foreign" unions from South Africa and lays down a strike procedure which legal experts believe effectively blocks legal strikes.

Despite the fact that it is a "foreign" union which is not registered in Bophuthatswana, the National Union of Mineworkers claims considerable support at Impala and says workers have been approaching the union for membership.

The NUM contends that the



Mineworkers prepare to go home after the dismissal of 20 000 workers at the Impala platinum mines in Bophuthatswana

Impala dispute centred not only on wages and working conditions, but on "a denial of workers' rights to join a union of their choice."

"Any question of registering

in Bophuthatswana is unacceptable to the NUM because of our rejection of the homeland

"In future a large proportion of Bophuthatswana citizens will be employed and that will change the whole complexion of the situation on the mine."

land system. We believe Bophuthatswana is part of South Africa," said the spokesman.

In keeping with the "one industry, one union" policy of the Congress of SA Trade Unions, to which the NUM is affiliated, the union wants to represent all miners in South Africa, and that includes the homelands.

The NUM has accused companies which operate in the homelands of using their laws as a shield of protection against workers legitimate grievances.

The strike at Impala started on January 1, coinciding with the week in which a recruitment drive was to have started by Bonume. The union has as yet, very few, if any members at Impala, but has the blessing of the homeland government.

This raises a dilemma for Impala and reflects the dilemma

ma of all companies which operate in Bophuthatswana or any other homeland.

Mr Gary Maude, acting chief executive of Impala Platinum, explained his company's position.

"The company would like to work with a union representative of its workers and which operates within the law. Bonume and the NUM are the two union possibilities at present," he said.

"There is a legal compulsion on an employer in Bophuthatswana to deal with any union which is registered. It is not a question of recognition."

"Bonume is in the process of becoming a registered union. It has already completed the first step in the process."

Mr Maude was optimistic at the prospect of labour peace in the future at Impala.

"After dismissing so many workers we are going to have to get workers back to the mine. Our policy is to give jobs to local people. The problem in the past has been finding enough experienced workers locally."

# More platinum miners leave

and at Mineral Processes.

Workers went on strike over a variety of wage and work-related issues and the National Union of Mineworkers' (NUM) said workers wanted NUM recognition

The NUM said yesterday 27 workers had been shot with rubber bullets in violent clashes with mine security forces and that 26 had been admitted to the mine hospital.

The NUM said clashes resulted in the arrest of 48 workers at Wildebeestfon-

tein North mine. They were handed over to the Bophuthutswana police and were due to appear in the Phokeng Regional Court today.

Impala Platinum's acting executive officer Gary Maude yesterday confirmed workers would appear in court today on charges of committing criminal offences.

← From page 1

(217)



# Mass sackings: it's grimmer in Bop

THERE is one question to ask about Gencor's mass dismissal of 23 000 Impala Platinum mineworkers this week and that is: How was it possible? A sacked 32-year-old underground locomotive driver thought about this question for about 12 seconds before answering:

"Management does not have sympathy for people. They don't listen to what we have to say. They regard us as animals. That is why it is possible for them to do this."

The acting chief executive of Impala, Gary Maude, responded to the same question at a press conference

this week by saying: "You run into a point where they get completely unreasonable. The alternative is to get rid of the whole labour force and replace them. There is a condition of massive unemployment in the country and that encourages us to take this kind of action."

National Union of Mineworkers press officer Marcel Golding, answering the same question but in a different sense, said: "Gencor used Bophuthatswana legislation — which makes workers powerless against their atrocious wages and living and

How does a company get away with sacking all its workers? Gencor succeeded this week with the help of Bophuthatswana's labour legislation, far harsher even than South Africa's. PHILLIP VAN NIEKERK reports

working conditions — as a shield."

All three aspects — Gencor's heavy-handed approach to industrial relations, chronic unemployment; and Bophuthatswana's labour laws — appear to have facilitated the sackings and have been highlighted by the sackings

But while Gencor and unemployment are perennial problems which crop up frequently in disputes on the mines, the Bophuthatswana Industrial Conciliation Act has lent an added edge to this dispute

The Impala dismissals are a cruel reminder that the homelands policy not only strips people of their South African citizenship but of their rights as workers

Under Bophuthatswana law, workers are denied freedom of association — the right to join the union of their choice — and the ability

to challenge unfair labour practices in the industrial court

These are rights now upheld in law for workers in South Africa

Thus, there can be no repeat of last year when Gencor emerged from its encounter with the NUM at Marnevale with a bloody nose and an industrial court demand that they reinstate the workforce they sacked

It is crucial to note that historically the NUM started organising on the mines before this legislation was introduced in 1984. In fact, workers went on strike at a Union Carbide vanadium mine in Bophuthatswana in January, 1984, demanding to be represented by the union of their choice — the NUM.

There is certainly reason to suspect that the outlawing of unions with head offices in South Africa was done to keep out more militant unions.

These could provide both a political challenge as well as make wage demands which would lessen the attraction of the homeland to investors

Certainly, Gencor has accepted the situation without raising too much of a fuss or going out of its way to assist the NUM

This is unlike one leading retail company, which has extended its wage agreement with Ccawusa to include its depots in Bop — and the position of the all-white Mine Workers Union, which has not been barred from representing its members at both Impala and Rustenburg Platinum

On being approached by the NUM in November last year for access to the mine for recruiting purposes, Impala's general manager J G Cockburn said

"As your trade union does not comply with these (Bophuthatswana) requirements, I am not in a position to enter into discussions with you regarding access or any other matter"

Which is a pity, because it might have helped Gencor with the "communication problems", to which they ascribe the strike, to have a representative union around

Even still, worker organisation was surprisingly strong, as more than 23 000 workers struck for almost a week, setting clear demands mainly revolving around wages and working conditions

Impala denied that the issue of the NUM had been raised, but workers produced lists of demands which they said were forwarded to management right at the beginning of the strike, demanding that the NUM be given an office at the mine

For the union, the dismissals represent an almost insurmountable challenge — how to represent mineworkers when your organisation is banned

And it could be the first trial of strength for the Congress of South African Trade Unions (Cosatu) — due to hold an urgent executive meeting to discuss the issue

Cosatu pledged at its inaugural congress to organise in the homelands, despite the restrictions and the hostility of nearly all of the Bantustan governments to trade unions

It will be difficult to avoid fighting an issue which at once involves a recalcitrant employer, the issue of mass dismissals and the denial of rights to workers as a result of the Bantustan policy

48 <sup>10/11/86</sup> ~~10/11/86~~ ~~10/11/86~~ ~~10/11/86~~  
miners  
charged

From PHILLIP  
VAN NIEKERK

JOHANNESBURG — A total of 48 mineworkers dismissed from the Impala Platinum mine this week were released on R100 bail yesterday when they appeared in the Mogwassie Regional Court on charges of public violence

A spokesman for the prosecutor's office said he was unable to disclose the charges, but a spokesman for the Bophuthatswana police said they were appearing for public violence

The workers appear again on February 10

They are among the 23 000 men dismissed from Impala this week, and were arrested after clashes between workers and mine security at the Wildebeesfontein North hostel.

The entire workforce at three sections of the mine — Wildebeesfontein North and South, and Bafokeng South — were sacked along with 3 000 workers from Bafokeng North

More than 90 buses stood empty at the mine yesterday, destinations chalked on their front windscreens, some sending workers as far afield as Malawi, Mozambique, Lesotho and Transkei

There was a heavy security presence on the still-tense mine as men carried out their few possessions

Journalists found at one of the hostels were threatened with arrest for trespassing and were accompanied out of the mine by mine police



# PLATINUM

A treasure chest buried under the bushveld ...

11/1/86 STAR  
217

The labour rumpus (which crippled production at the Impala mine complex outside Rustenburg) has cast new light on the growing role of platinum in the vast armoury of precious metals which underpin the South African economy.

The spectacular leap in the world price of the metal — now even more expensive than gold at around US\$350 or R875 an oz — in turn accelerated the investor rush into platinum shares

Investors at home and abroad, always on the look-out to make a fast buck out of bad as well as good news, were holding thumbs that a disruption in deliveries from South Africa would add impetus to the platinum price spiral under the simple laws of balance between supply and demand.

What makes the supply route to international buyers so crucial is South Africa's domination of world platinum markets.

Four decades ago, when Canada and the Soviet Union ruled the roost, South Africa held less than 20 percent of the overall world supply of 310 000 oz a year.

At the latest count made by the multi-national Johnson Matthey bullion dealers and refiners, the annual production of platinum was running at 2,75 million oz — almost a nine-fold increase — and the South African share had soared to 84 percent of the global total.

On the basis of a market price of US\$350 an oz, that means platinum is now bringing more than R2 billion into South Africa a year.

Moreover, the entire SA operation is packed into a relatively tiny stretch of the bushveld which starts around Rustenburg, goes across to Lydenburg, and spreads north to Potgietersrus and beyond

The two giants are Rustenburg Platinum Mines, controlled by Johannesburg Consolidated Investment, and Impala, run by the Gencor group. Precise production figures are rarely published, but it is believed that each one produces about 1 million oz of the metal a year.

In the long term, the potential

The labour rumpus at the Impala mines in Bophuthatswana has generated intense interest on the role of platinum in the Southern African economy.

Fears of interruptions in supplies of the precious metal to world markets has boosted global prices on overseas commodity markets and accelerated an investor rush into platinum shares on the stock market.

South Africa is now by far the biggest supplier of the wonder metal, which has become even more expensive than gold.

The growing importance of platinum — a treasure chest buried under the bushveld — is explained by MICHAEL CHESTER in this article.

of the bushveld complex is astounding.

Researchers at Johnson Matthey estimate that the platinum reserves there amount to no less than 930 million oz — 94 percent of all the known reserves on earth — within a depth of a kilometre or so

That, using today's market prices and exchange rates, is worth a mind-boggling R815 billion

Not surprisingly for so scarce and so costly a metal, the biggest consumer of platinum is the jewellery trade. But it is in higher technology that the metal has scored its biggest successes in recent years.

Ten years ago, jewellery accounted for nearly 50 percent of an annual global demand that

had swelled to 2,5 million oz. By 1984, the proportion going to jewellers had slipped to less than 30 percent — the bulk going to Japan, now by far the largest single market and where platinum has rocketed to the throne as the *ichiban* (No 1) slot among precious metals

The new gluttons are the overseas motor industries, where platinum has proved to be the key element in new exhaust devices capable of meeting the stringent anti-pollution laws multiplying around the world

Car exhaust emissions have been controlled by law in the United States and Japan since the late 1960s and autocatalysts relying on platinum group metals were first introduced in

## SOURCES OF PLATINUM GROUP METALS

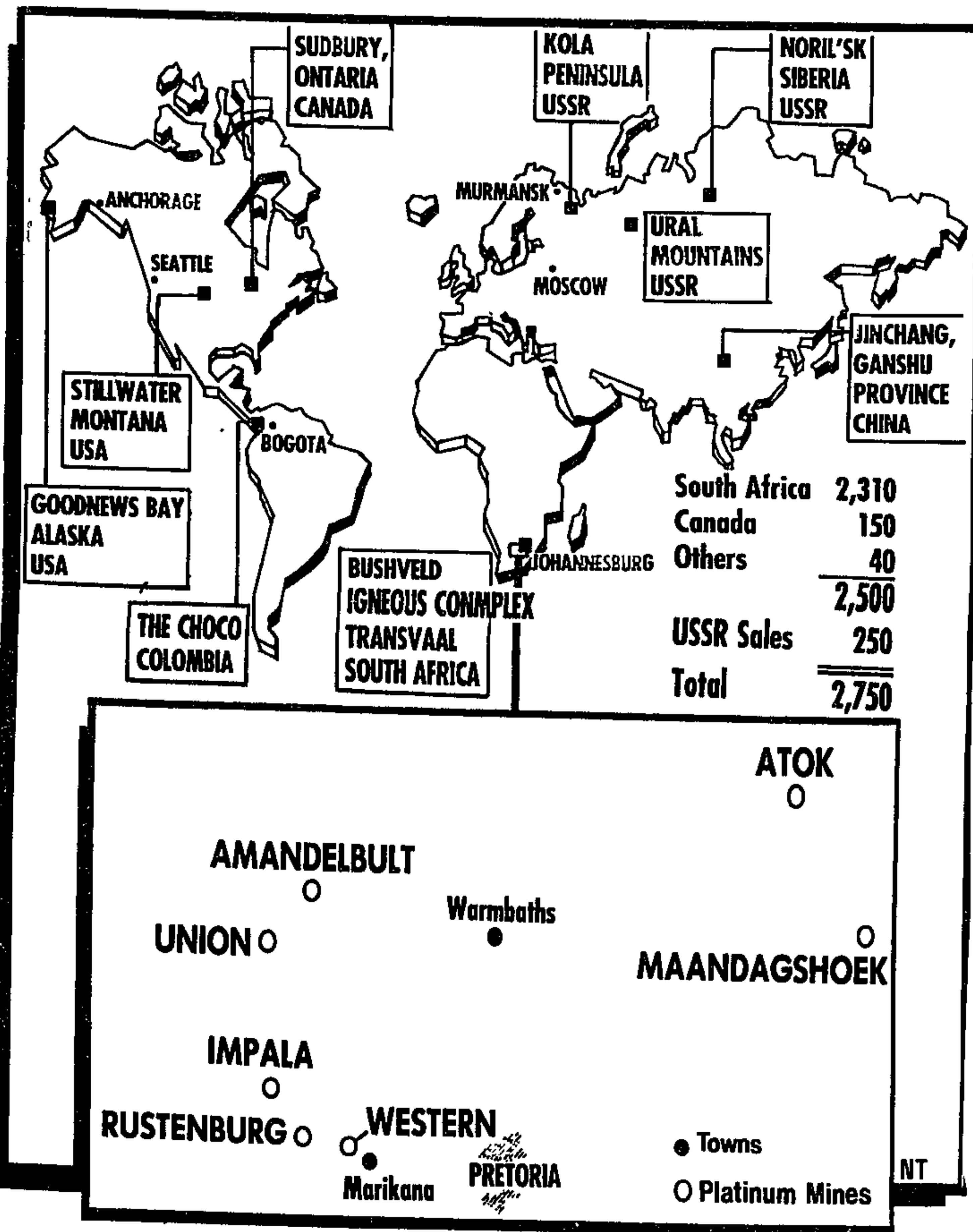

1974.

The two huge motor producers are now consuming platinum at a rate calculated at 690 000 oz a year. The US alone had packed more than 3 million oz of the metal into passenger cars and trucks by 1984.

Yet that may be only the start. A 1985 review of platinum prepared by Johnson Matthey reports that similar anti-pollution laws are due to be enforced in Australia in 1986, in South Korea inside the next two years, and in the 12-nation European Economic Community (EEC), starting in 1988

And it is not only the international motor industries which are discovering the unique properties of platinum in cracking hi-tech puzzles. World-wide

chemical and electronics companies have also found the metal to be vital to modern processes

Platinum is also now in wide use in oil refineries, as an active agent in upgrading the octane level of petroleum, among dentists, who use it as a hardener for gold alloys in crowns and bridges, by fertiliser manufacturers, who set it to work in the production of nitric acid. It even helps in making glass and glass fibres

Peering into the future, Johnson Matthey finds the potential new uses of platinum to be virtually boundless

Researchers are at work looking for new ways to exploit the success of platinum in cancer chemo-therapy

In the field of solar energy, complex platinum compounds may be used as catalysts in the conversion of water — under irradiation by sunlight — into hydrogen and oxygen, which many regard as the main pollution-free fuel of the future

Boffins are also experimenting with platinum as a catalyst inside combustion chambers of car engines where it can aid ignition and simultaneously achieve clean exhaust and low fuel consumption

"The horizons are constantly extending for the platinum group metals," says a Johnson Matthey researcher. "There is much we do not yet know about how, why and where these remarkable and versatile metals will be used in the future"

## PLATINUM DEMAND IN THE WESTERN WORLD

Western Europe	410
Japan	1,140
North America	870
Rest of Western World	170
	<hr/>
	2,590

JEWELLERY	30%
OTHER	11%
PETROLEUM	1%
GLASS	5%

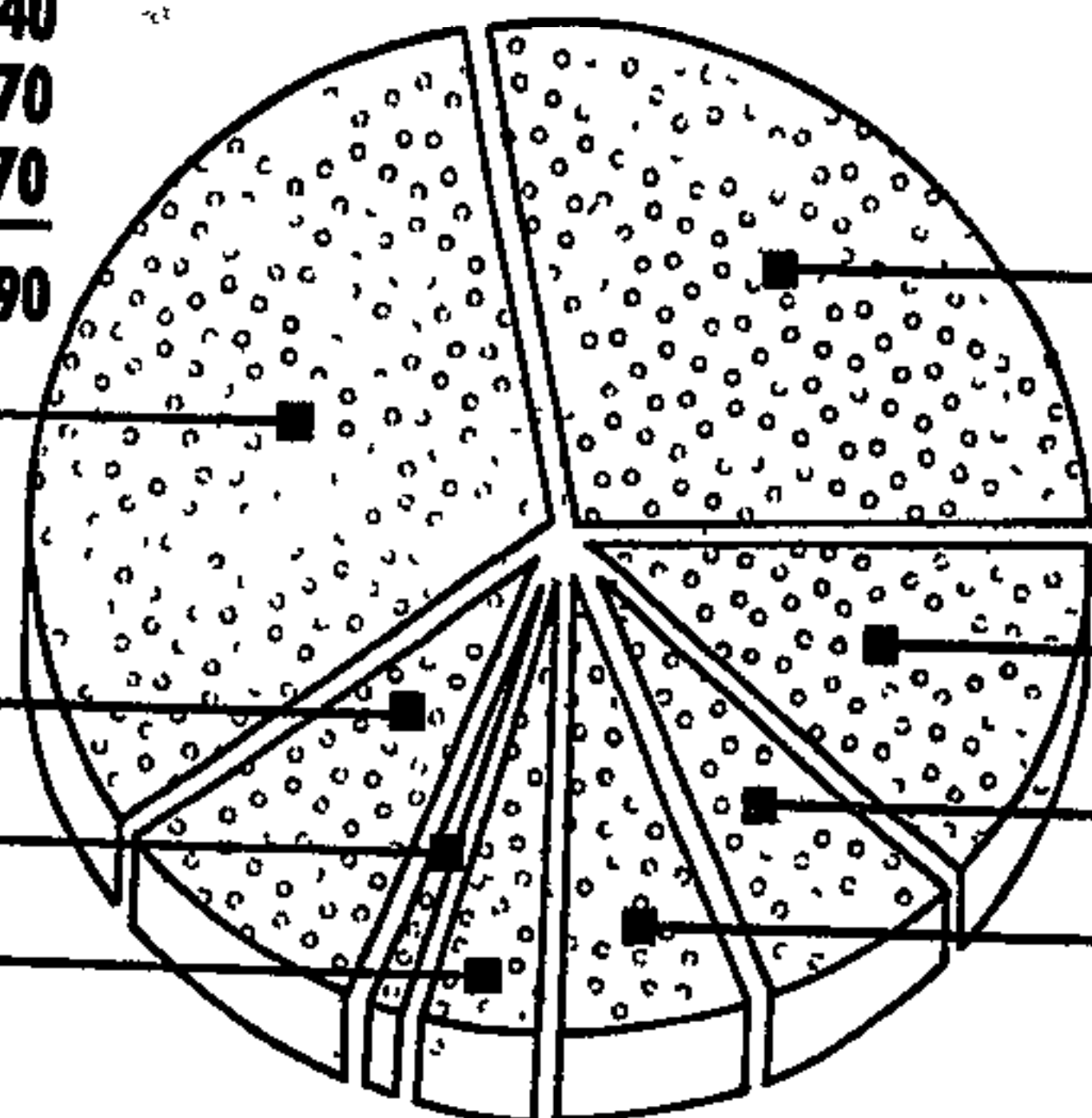

AUTO CATALYST	28%
CHEMICAL	11%
ELECTRICAL	7%
HOARDING	7%

TOTAL DEMAND = 2 590 000

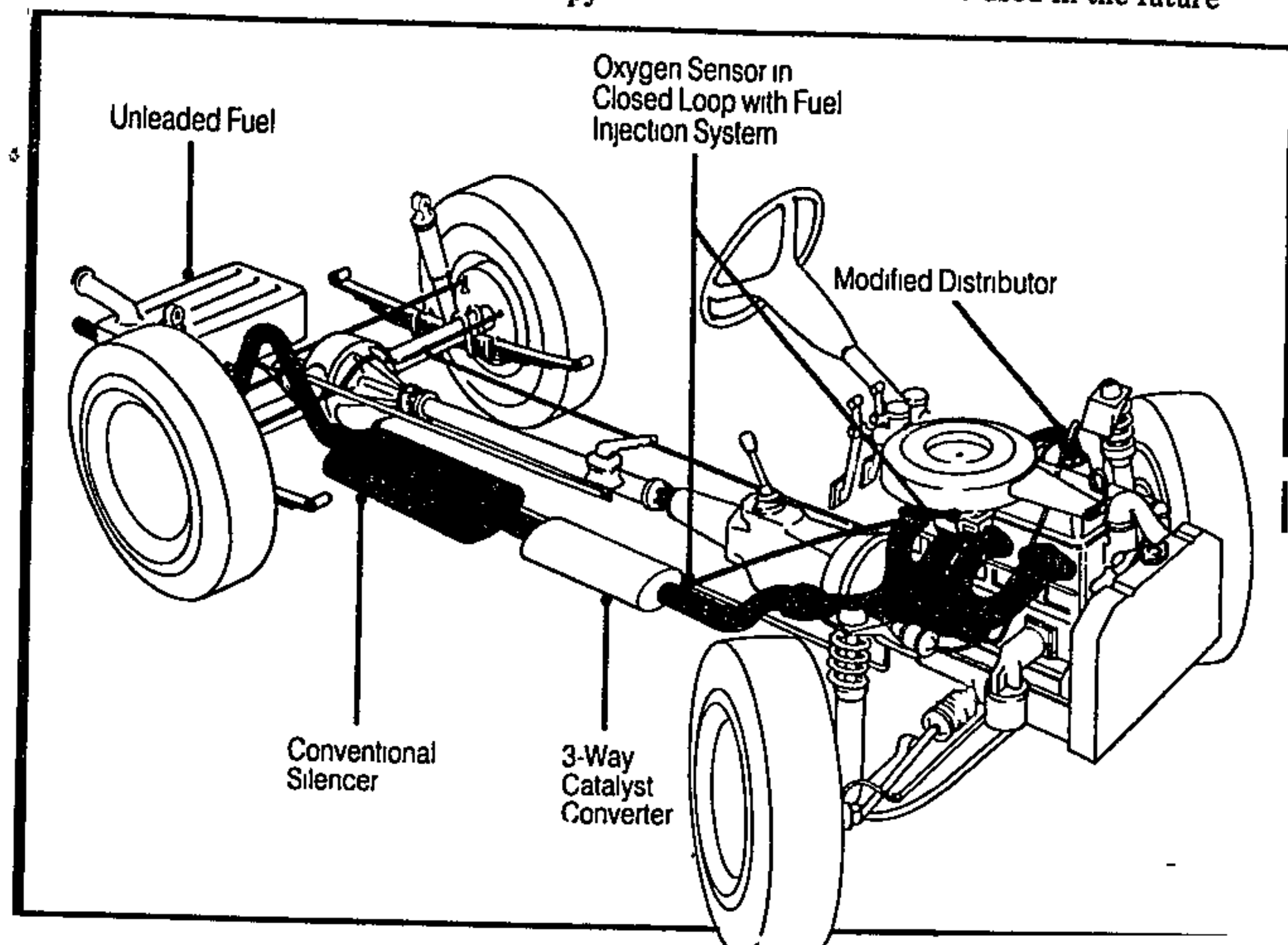



# Business

## Rusplats sparkles

ROY BENNETTS

*Bus Day* *217*

RUSTENBURG PLATINUM soared above market expectations for the six months to December by declaring an interim dividend of 52,5c a share (35c).

Earnings a share almost doubled to a record high of 83,5c (47,5c) in line with taxed profits of R104,6m (R59,5m).

In spite of a mainly unchanged sales volume of metals in the PGM group for the quarter, gross sales revenue jumped to R720,3 (R466,4m) boosted by the weak rand.

In world market terms the average price achieved for all metals sold, with the exception of rhodium, nickel and cobalt, was lower.

However, due to the decline in the average value of the rand against the dollar, the local price received was higher, consequently profit before provisions for renewals and replacements increased by 80,4% to R285,7m (R158,4m). This last item increased from R32,7m

### STEEP CLIMB RUSTENBURG PLATINUM

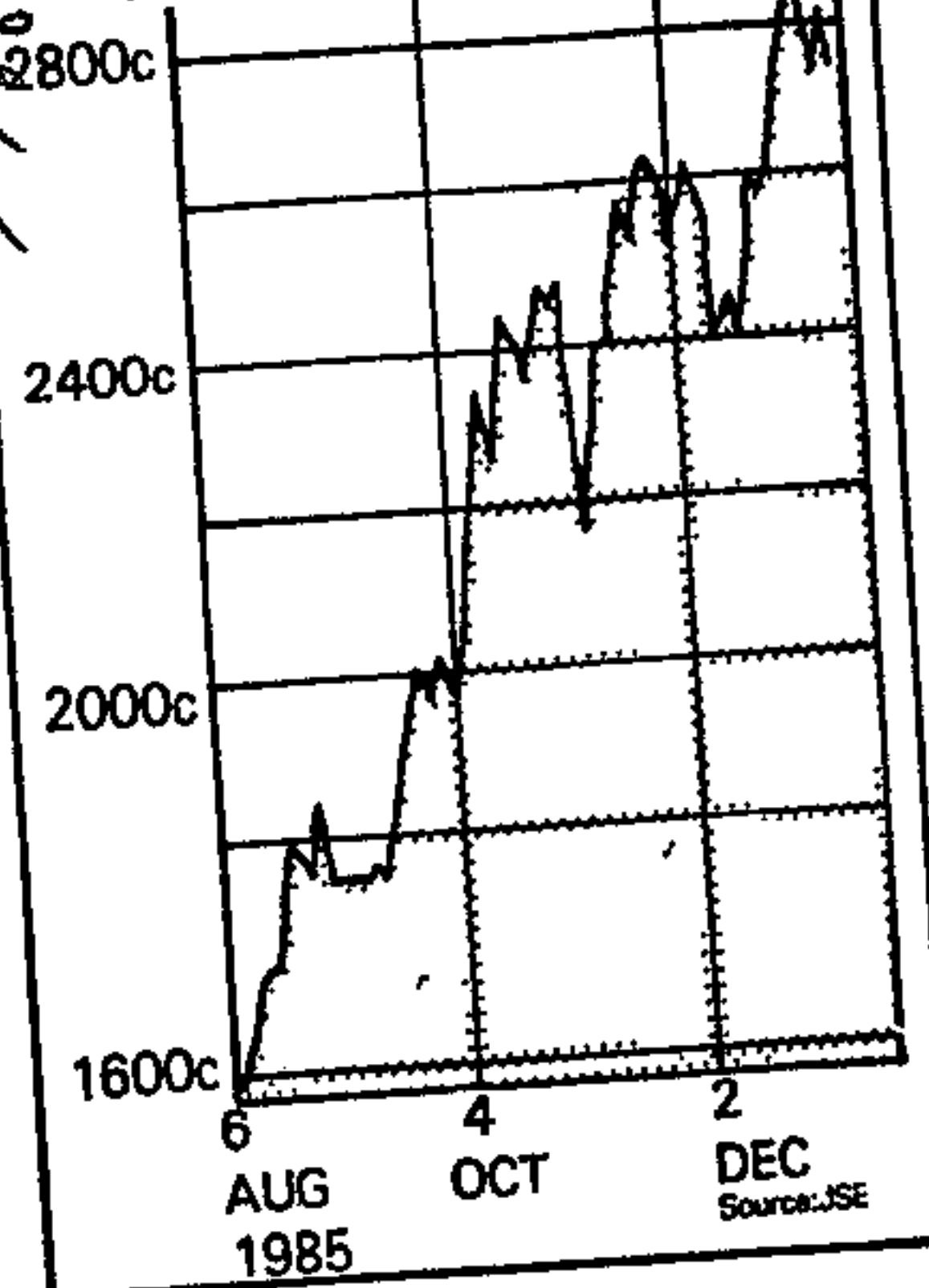

● To Page 2 →

## Weak rand boosts Rusplats

*217* *Bus Day*

in the previous six months to nearly R40m, to leave the mine with pre-tax profits of R245,7m (R125,7m).

Tax and lease payments maintained the pace set by sales revenue, to rise from R64,2m to R140,1m.

Managing director Ken Maxwell says that if the high current rand price for platinum and other metals persist for the next six months, then, in the absence of unforeseen circumstances, profits in the second half of the current financial year will also show a substantial increase compared with earnings in the six months to June 1985.

However, the improvement is likely to be less than the increase recorded for the first half of the current financial year.

Capital expenditure for the six months amounted to R53,2m (R34,1m) of which R51,6m was charged to the renewals and replacements reserve as ongoing capital expenditure.

Rusplats is known to be selling all the metal it can produce to take the maxi-

imum advantage of the weak rand

Stockpiles at the mine are believed to be either non-existent or at their lowest levels for some time

Platinum is presently trading at an 18-month high on the London free market at \$362/oz, triggered by labour problems at the Gencor-managed Impala Platinum mine

This is not expected to cause an immediate shortage of supply as the size of the Impala stockpile is likely to be able to meet short-term requirements

However, an eventual shortfall is expected, to the advantage of Rusplats, which is more closely linked to the platinum free market price than the Gencor producer

Rusplats shares were traded ahead of the results at 2725c a share, with the interim dividends showing a yield of 5,2% a share

*from page 1 21/11/85*



# Chance to get into vanadium

By Peter Farley  
Investment Editor

A newcomer to the mining boards of the JSE will shortly offer investors the opportunity to participate for the first time directly in a vanadium mine

A wholly owned subsidiary of ER Cons, Vansa Vanadium SA is to be separately listed next month after a rights issue by ER Cons. The object of the listing is to raise fresh funds (R30 million) to re-start a vanadium mine on Kennedy's Vale farm near Steelport

In the longer-term platinum may also be mined at the farm — but that cannot be considered in valuing this listing

ER Cons is controlled by the UK-based Marshall family who have renounced their rights in the Vansa issue in order to make shares available for investment opportunities here

The Marshalls will remain in effective control of Vansa through the ER Cons stake — which will hold over 50 percent

STAR  
20/2/86 (217)  
of Vansa after listing. According to the prospectus, Vansa plans to re-open a mine once worked by Anglo's Highveld Steel under tribute from ER Cons

Initially the mine will be an open-cast operation, the Vanadium deposit is in a small hill. But there are plans to extend underground once the operation is fully underway.

ER Cons shareholders are being offered as a package two Vansa shares at 300c each, plus the option to buy another Vansa share at a later date — for every five ER Cons shares currently held

Though referred to as a "linked unit", the ordinary shares and the options will be separately listed. However, prior to the rights being taken

up, nil paid letters will trade on the JSE, giving shareholders the opportunity to sell their rights and outsiders to buy in.

Three "independent" reports — by the mine management, sponsoring brokers and merchant bank — all strongly favour the scheme and suggest that, though pitched at 300c, the shares should come on the market between 350c and 450c.

Certainly the prospectus looks solid, with the only possible hiccup in the equation being a reversal of vanadium prices or the grade of the ore body

But with the international price of the metal looking well balanced, and the worldwide supply/demand situation achieving an equilibrium, Vansa should be protected

The mine is expected to start

production in 1988 and have a life of around 17 years

After the start-up period about three quarters of earnings are forecast to be paid in dividends, with the balance ploughed back towards the possible exploration of platinum. But it seems another rights issue may have to be contemplated

ER Cons share price has risen sharply in the last two years, from below 50c to 245c, mostly on speculation about an entry into platinum production

That the platform is to be created through the vanadium mine is unimportant. As it stands, Vansa should offer a good return. Judging by institutional interest shown, it should command a reasonable premium over the issue price

IMPLATS

The deepest cut

Impala Platinum (Implats) and Randfontein Estates gold mine showed this week how industrial relations confrontations between management and mineworkers can hit investors right where it hurts.

Impala has put an estimate of R45m on the loss in attributable earnings caused by the mass dismissal of 23 000 workers early in January following a work stoppage. And as a result of labour unrest near Randfontein's Cooke 2 shaft, the mine's recovered grade is expected to drop 17% to 4 g/t in the current quarter to end-March, from 4,8 g/t in the December quarter. Randfontein's management hopes to have underground production back to normal only by the end of the June quarter.

That works out to a potential revenue loss of about R30m for just the March quarter on current gold prices and at the December level of milled production, which is unlikely to be increased this quarter. The bottom-line effect on Randfontein is difficult to calculate at this stage because of tax considerations and the lower working costs of treating material from surface dumps.

Impala Platinum is taking a financial thumping and shareholders will lose out for the second year in a row on the benefits of the boom in the platinum market which, by

contrast, have flowed through to investors in Rustenburg Platinum. In the year to end-June 1985, Impala level-pegged with earnings and dividends at 1984 levels, because of a R59m stock loss incurred on trading in platinum contracts on the New York Commodity Exchange

The forecast for the 1986 year is for repeat performance, with Impala's official forecast that. "It is unlikely the results for the full year to 30 June 1986 will be significantly better than for the previous financial year."

Full production at Impala is not expected to be reached again until mid-March at the earliest. The platinum refining pipeline is some four to five months long, so the brunt of the lost production will come through in the second half of the year to June.

For that reason Impala has pegged its interim at an unchanged 35c and is holding back 142c in retained earnings, following the jump in interim profits to R101,8m (177c a share) from the R50,2m (87c a share) earned in the six months to December 1984. The R45m loss of attributable earnings amounts to 31% of what the group made in the year to June 1985

MD Don Ireland will not quantify the loss in terms of physical output Nor will he comment on estimates in overseas mining journals that Impala could have lost about 300 000 oz of platinum production, which is about 33% of its estimated annual production capacity of between 900 000 and 1m ounces of platinum. Neither Impala nor Rustenburg Platinum disclose production figures.

Ireland says the R45m figure is the best estimate that can be put on the loss at this stage He says the group is doing all it can to improve the situation and hopes the loss will be less than estimated

He also declines to specify the numerous steps which Impala is taking These, however, will probably include going for higher-grade areas and cutting-back on development work to concentrate on production. There is some leeway in trimming the capital expenditure bill, but excessive cuts here could adversely affect the mine's longer-term prospects. Impala was having problems meeting consumer demand before the dismissals and significant capex cuts seem unlikely

Trading subsidiary Ayrton Metals will buy platinum to meet Impala's contractual commitments so customers will not be affected, but the cost of the purchases will feature prominently in Impala's estimated loss of earnings.

The Impala share price came off only slightly on Tuesday after release of the results. The general reaction from JSE analysts was that anyone with Impala shares should hang on to them rather than sell out, but anyone wanting to buy into platinum shares should go for Rustenburg.

Comments one analyst: "So much has gone wrong with Impala that one wonders what else can and therefore the long-awaited recovery should come about in the 1987 year."

However, this week's announcement by National Union of Mineworkers' leader Cyril Ramaphosa that his union had singled out

the Gencor group, of which Impala is part, for particular attention this year is not exactly good news — depending on how thoroughly Impala weeded out its labour force in the dismissals and selective re-hirings

Brendan Ryan



# Analysts begin to enthuse about platinum

STAR. 22/2/86 27

By Charles Johnstone of  
Holcom Commodity Brokers

Gold attained a low level of \$328 last Friday, again bowing to the weight of speculative and fund selling that was originally instigated by the sharp fall in oil prices

But just as the disillusioned bulls feared another precipitous decline, the rescue came in the form of the platinum market which rocketed higher on Wednesday, stopping just short of the \$400 mark, dragging with it gold, and to a lesser extent, silver

Gold's rally to \$342 was hardly proportional to platinum's rise but the correction served as a timely stop-gap

Platinum had a fairly volatile year, rising from last September's lows of \$300 an ounce to current prices around \$395

Much of this volatility can be attributed to the wave of unrest that has swept South Africa

### STRIKES, UNREST

Of the 80 tons of annual world platinum production, South Africa produces some 74 percent, so news of possible mine strike action and reports of continuing unrest tends to set the platinum market in motion

Monday's news that Impala could lose as much as 300 000 ounces of production due to their current labour problems, was the catalyst for further

sharp gains and to some extent rescued gold

Analysts are beginning to enthuse about platinum in particular, firstly because the supply/demand ratio could now be forming an imbalance due to these production problems and second, the longer term prospects for increased demand look healthy

The likelihood of the EEC introducing exhaust emission controls through the use of platinum-based catalytic converters, which already accounts for 28 percent of usage, is one reason for improved demands

Jewellery, which accounts for 30 percent of demand, remains steady, especially in Japan, while investor interest and

hoarding has increased significantly since the introduction of the 99.7 percent-pure platinum coin the "Noble" in 1983

Through successful marketing and improved public awareness of platinum's investment potential, demand could well increase in this sector

### COMPARISON

Comparing the outlook for gold to platinum, the emphasis tends to fall more on the latter

However, while we are witnessing exhausting activity on the platinum exchange for the present, should accounts of South Africa fade from the newsreels, so too could the speculative flair for platinum

12/3/86. STAR

# Impala comes under fire for its forward selling 217

By Gareth Costa

The forward selling of platinum by Impala in long-term contracts has deprived the company of the benefits of the weaker rand and the current higher dollar price of the metal, says an analyst at broker Lewer and Co

A statement by the company's chairman in the interim report said "A substantial part of the company's output is sold under long-term contracts where revenue is protected by cost escalations and is not subject to exchange rate fluctuations"

However, says the analyst, the statement implies that long-term contracts have been entered into in rand terms and the benefits of the rand and platinum prices are, and will be, materially less than that which Rustenberg has achieved and is expected to achieve

A comparison of the two mines shows the earnings growth of Rustenberg for the last six months to December of 1983, 1984 and 1985 as being R78,7 million, R110 million and R234,6 million, a growth of 198 percent

Impala's comparative growth is far less impressive, the figures are R119,4 million, R71,7 million and R165,9 million, a growth of 39 percent. These figures have been adjusted to account for different accounting policies relating to stock valuations and provisions for renewal and replacements of capital expenditure.

Another factor which could also hinder the mine's profit revolves around the rumour that a shift has been made from the Merensky reef to the UG2 reef

"Such a shift would materially impact upon future earnings prospects as the unit output of platinum and base metals will be reduced as the UG2 reef has a lower head grade, lower platinum and base metal ratios, as well as lower concentrator recoveries"

The analyst concludes by saying that the longer-term prospects for increased earnings will be materially constrained by NUM's "declaration of war" on the Gencor group, by rand-based contracts and the reliance on the UG2 reef



# GFSA platinum decision soon

By Neil Behrmann

13/3/86  
LONDON — Gold Fields of South Africa seems set to open its new mining project Northern Platinum this year.

(217)  
In London Rudolph Agnew, chairman of Consolidated Gold Fields which controls GFSA, said that he expected a decision on the mine to take place this year.

GFSA executives were "very close to making up their minds" about the mine, said Mr Agnew.

The mine would have to start operations

soon to take advantage of the growing platinum market.

Rustenburg and Western Platinum have raised production. But for labour problems, Impala's output would be higher too.

GFSA holds more than 60 percent of Northern Platinum and Consolidated Gold Fields has a 14 percent stake, said Mr Agnew.

Dr Fred Collendar, an eminent geologist and consultant to London stockbrokers Strauss Turnbull, saw that Northern's platinum resources had potential and sold the prime stake in the mining area to the Gold Fields group.

BUD DAY

23/4/86

# Palamin: <sup>(217)</sup> 8% copper sales fall

Investment Staff

**PALABORA Mining (Palamin) reports copper sales falling nearly 8% to 32 133 tons in the three months to end-March, compared with 34 888 tons in the first quarter of last year, while production dropped by 21% to 24 147 (30 647) tons.**

The drop in recovery of the metal was mainly attributable to a six-day shutdown of the smelter for scheduled maintenance, which resulted in an increase in the concentrate stockpile.

Sales of sulphuric acid were also affected by the shutdown.

Ore milled increased marginally in the period from 7.1-million tons in 1985 to 7.4-million tons.

However, sales of nearly all other by-products improved.



B DAT  
11/23/86

LETTERS

217

NUM replies

Dear Sir,  
REGARDING editorial ("Gencor's Impala Stew," *Business Day*, January 9, 1986).

Editorials directed at South Africa's decision makers should at the very least uphold elementary accepted principles of journalism, namely, factual accuracy and informed comment. To have permitted such trite to pass as an editorial is an utter disgrace to the noble intentions you have as a newspaper and the audience you wish to serve. Two issues are most disturbing and deserve clarifying.

You allege the union has been "growing like Topsy (and some might say has been lead by Topsy)". You provide no substantial evidence for your claim except spurious anecdotes and vague generalisations. In fact your remarks are contrary to the general opinion forwarded by respectable and authoritative analysts on labour. Among these views are the following:

1. That the union has been growing steadily in the mining industry and is certainly the most representative voice for black mineworkers.
2. The union leadership is responsible, democratic and renown for pursuing, to the letter of the law, the channels of collective bargaining.

If anything, the judgement in the Marievale case (if you have read it) is adequate testimony of the union's reasonableness, and can certainly not be accused of being "Topsy".

To allege that the NUM has suffered two bloody noses is nonsense. If anything, it is Gencor who has suffered a bloody nose in the Marievale case.

On the Impala strike, it is said the "reasons are vague, to say the least, long working hours, wages, etc... many of them minor... nothing is easily verifiable."

To suggest the reasons are vague is to ignore historical and long standing grievances of black mineworkers which the mineowners have yet to address. If the grievances were so minor why were they not remedied when workers brought them forward. And lastly, if you suggest that "nothing is easily verifiable", it is absurd to comment with such authority without ascertaining the facts.

One can only deduce that on the subject of labour and industrial relations you are out of your depth and have no inkling of what is at stake. Consequently it can only be presumed that your editorial is based on ignorance. If that is the case, it is wise to refrain, lest the reputation of your newspaper declines even further than it has as a "sensitive" commentator for the nation's decision makers.

MARCEL GOLDING

National Union of Mineworkers' Press Officer

□ AT THE NUM's request, this letter is unedited. — Editor.

# Oversupply makes copper a bad bet for the investor

STAR 20/3/76 (217)

By Gareth Costa

The Western copper market seems destined to remain in oversupply, or at least with an overhang of "moth-balled" capacity for a while and investors should stay away from copper investments, say brokers EW Balderson in an analysis of the market

"The recent years of difficulty experienced, particularly by the North American producers, has resulted in a streamlining of operations, closure/moth-balling of high-cost production units and greater production efficiencies

"This has, ignoring currency movements, lowered the overall cost of a unit of 'Western copper', thereby marginally increasing the potential oversupply."

However, the report states that the international price should be more sensitive to traditional factors such as industrial production and mine strikes because of lower levels of stock than in recent years and what appears to be a more balanced supply and demand situation

A summary shows the major negative factors influencing the market to be firstly, the dominance of world trade by Third World producers, whose primary aims are more political, namely employment and generation of foreign exchange goals, rather than being profit motivated

Second, the intensity-of-use of copper in its traditional markets has been eroded and producers need to find new applications for the metal Thirdly, the lack of a concerted, co-ordinated and marketing orientated effort by the primary producers to reverse the downward consumption trend

Last, the increasing importance of the secondary or scrap market is reducing the take-off for newly mined lower-grade copper.

The report states that Palabora Mining Company, at a share price of R22 and a prospective yield of 6,8 percent and historic yield of 8,2 percent "represents a fair return from a commodity producer and a strategic investment against a further depreciation in the rand"

"Unless the rand is in for a major appreciation above \$0,50 good results and dividends will continue to be produced by the company"

116



# Beneficiation is key to future prosperity

21/3/86 STAR (217)  
By Stan Kennedy

If a major steel producer were to convert half of the ferro-chrome produced in South Africa to stainless steel in sheet form, the country could satisfy 15 percent of world demand and earn R3-6 billion in the next 10 years

Ironically, South Africa dominates the production of diamonds and platinum yet it is a net importer of jewellery

If the country were to manufacture only 10 percent of the world's jewellery, it could also earn, in the same period, up to R4 billion a year at a modest 250 percent markup

These and other figures were given to delegates at the Capex in Mining conference in Johannesburg yesterday by Mr AM Edwards, president of the Council for Mineral Technology (Mintek)

He said it was a simple and logical thing to expect that a country would beneficiate its minerals to get the maximum financial benefit from its raw materials

"But it is surprisingly illogical that South Africa has trod so warily and has been relatively unsuccessful in the realm of added value. It has remained, principally, an exporter of basic raw materials that are enhanced in value at some foreign location

"South Africa, the most richly endowed mineral supplier in the world, continues to hand over its natural heritage to the benefit of others while, at

the same time, experiencing the highest unemployment in its history"

If the country was to drag itself out of its inertia, it would have to further exploit its minerals. In the early 1950s, mineral sales represented about 30 percent of its foreign exchange earnings. Today, the figure is around 80 percent

He gave other examples on how South Africa could exploit a strength already on its doorstep

The country supplies half the world's needs of ore for conversion to chromium chemicals. If 20 percent of world demand for pigment and metal were satisfied, the country could earn about R40 million a year in foreign exchange

A doubling of current production of ferro-manganese to achieve 20 percent of world needs would bring in another R20 million

Reserves of platinum were greater than those of gold, yet only two million ounces a year were produced, compared with the 22 million ounces of gold

Mr Edwards said success in the marketing and development of new products could generate about R1 billion by 1996

He said if South Africa looked more closely at what already belonged to the country and, at the same time, developed expertise in international marketing, it could double its foreign exchange earnings and create new job opportunities

# Tin collapse puts SA mines at risk

SUN TIMES  
217  
6/4/86

By Kerry Clarke

**SOUTH African tin producers face a battle for survival as a price war looms in the wake of the collapse of efforts to save the International Tin Council.**

Mike Fuller-Good, chairman of Gold Fields companies Rooiberg Tin and Union Tin, SA's largest tin producers, says there is world overproduction. Without control of output, a price war is inevitable.

Union Tin is contemplating stopping mining operations because of low ore grades at the mine and the sharp fall in prices since the council's failure last October.

## Bank refusal

The price of tin received by SA producers rose from about R23 000 to R30 000 in late September, but has been about R17 000 since the suspension of dealing on the London Metal Exchange.

The International Tin Council, which previously supported prices, crumbled as a result of the fall in the price of tin on the LME.

Low prices meant a decline in the value of tin offered as collateral to creditor banks. Some banks refused to lend the ITC more money. When it became apparent that financial support from its members was not forthcoming, the ITC admitted it was incapable of continuing to support the tin price. Trading in tin was suspended on the LME.

At the time of its collapse, the ITC owed banks and brokers £900-million.

Negotiations by ITC member nations were aimed at setting up a company to assume the council's debts and its 85 000 tons of buffer stock. The stock was one of the ITC's methods of regulating the tin price. The other method was to set export quotas.

## Indonesia

Most ITC members were thought to have approved a rescue plan, but Indonesia, the second-largest producer in the council, pulled the plug by saying it could not afford its estimated £15-million share of the capital needed to set up the new company.

Now the market has been thrown open, and with large

stockpiles of tin in most of the producing countries, and export quotas no longer applicable, a price war seems inevitable.

Mr Fuller-Good says: "There is far too much tin in the world. Production has to be reduced to a point where the stockpiles are driven down."

## Closures

There are so many stockpiles that it is difficult to say how much tin is available.

"To start with there is the 85 000 tons associated with the ITC. Half of this is probably held by the banks as it was lodged as collateral by the ITC. The rest is more than likely held by the brokers with whom the ITC had dealings.

"Now that the attempt at agreement has failed, this stock and other stockpiles could be offered on the market any day.

"Tin producers will all be involved in a fight for survival, and some mines will be forced to close. We are facing a tough few years."

Mr Fuller-Good says Rooiberg and Union Tin will fight to remain profitable and attention will be focused on productions.

According to Rooiberg's report, unit working costs soared in the year to December 1985 as a result of the

decline in tonnage mined. A major factor was the cost of black labour.

An effort will be made in 1986 to bring down operating costs. It will involve retrenchment, particularly at the lower levels.

Retrenchments have taken place at Union Tin.

Mr Fuller-Good says in Rooiberg's annual report: "The high level of inflation present in the economy will counteract efforts to reduce operating costs in the short term. Thereafter, if it continues, it will seriously reduce the company's capacity to cope with prolonged weakness in the tin price.

"In addition, the technical advisers point out that tin output should remain at the current level at least in 1986. As a result, a very difficult year lies ahead."

## Grades fall

Rooiberg and Union were both hit by declining grades of ore. If grade cannot be raised at Union to counteract the lower tin price, underground mining may be stopped.

Ore grade fell from 0,47% to 0,42% at Union and from 0,42% to 0,39% at Rooiberg in the year to last December.

Rooiberg's share price has dropped from R16 last October to 8,70 and Union's from R1,20 to 92c.



## COMPANIES



# Battling Gefco still confident

GEFCO, which operates one amosite and two Cape blue asbestos mines, currently faces rapidly rising costs and a static market.

Chairman Luther Jooste says in his annual review: "Any further decline in sales volume must inevitably result in further rationalisation of production.

"There is, however, a small margin of exchange-rate benefit to be derived and, in the absence of unforeseen circumstances, it

ADAM PAYNE

is expected the group will remain profitable in the year ahead."

He says that until world supply and demand are brought into line and there is a more rational perception of the health issue, selling prices will remain under pressure.

Gefco performed well last year, mainly because of the weak rand. Taxed profit rose to R16,8m (R10,9m) and dividends

totalled 25c (20c) a share.

Because of low sales, blue fibre stock levels remained excessively high.

In an effort to reduce the high cost of finance, another production cut of 15% at end-December was unavoidable.

Larger increases in unit costs can be expected this year than last, with only one amosite and two crocidolite mines in operation, all working well below capacity.

Prices of the group's fibre

have had to be reduced substantially over the past few years because of competition.

Jooste, in a comment on the anti-asbestos lobby, says more scientific evidence is becoming available showing that asbestos can be and is being used safely.

Evidence based on laboratory tests is proving that claims that crocidolite and amosite fibres are more dangerous than chrysotile are unfounded, taking into account current strict levels of dust control.

at 1.01 and the close of business on Friday, 11 April 1986.

Investors uneasy about supply situation as strikes close mines

# Platinum may soon hit \$450

217 SPAN 23/4/86

By Gareth Costa

A \$450 an ounce platinum price is within easy reach as foreign investors get more nervous about supplies being cut off

Investors have become uneasy what with the current climate of racial unrest and strikes that are hitting the gold mines and which recently crippled Gencor's Impala Platinum mine for two months

A year ago platinum was about \$230 an ounce, but it is now trading around \$415 with good prospects of a rise past the \$450 level in the near future, or even further if supplies are disrupted again

Japanese jewellers love it, 93 percent of US analysts are bullish about it, European cars will be banned unless they use some of it and demand for it should exceed the supply of three million ounces by about 8.5 percent in 1986

Platinum has come of age as it performs a solo concerto on the mainstage at the New York Mercantile Exchange (NYMEX)

It has filled the hearts of investors and speculators with new hope as gold and silver remain in the doldrums and platinum breaks free of its close association with bullion

Analysts here and overseas say the major concern, for industries that is, is a disruption of mine production by strikes, as happened in January on Impala when an estimated 150 000-200 000 ounces was lost over a three month period, or about five percent of world supplies

The problem is that 80 percent of all supplies come from SA, with the bulk of that from both Impala, at an estimated 900 000 ounces, and JCI's Rustenberg, with a production estimate of about 1.3 million

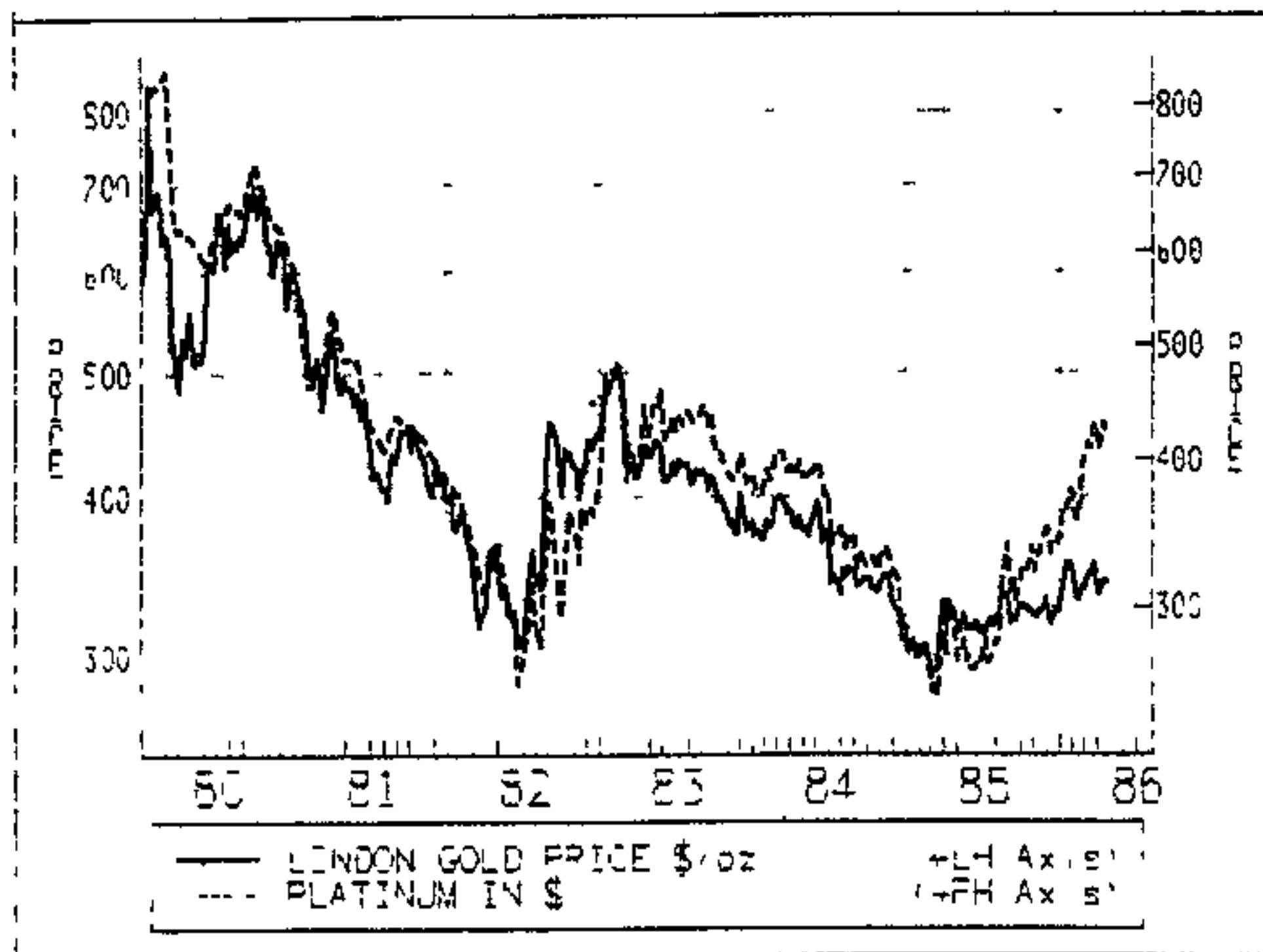

From the third quarter of 1985 platinum broke away from gold in dollar terms and is currently trading at its greatest premium since 1980 Graph by Simpson Frater

ounces, and then Russia, with about 10 percent

As there is little or no stockpile a strike could seriously upset world supplies and prices could take off

US investors and speculators are well aware of this fact as can be seen in many publications where the unrest problem is used as a major argument in bullish reports

Platinum is becoming more and more important in world industry, which uses about 65 percent of all supplies, especially the motor industry with over 35 percent of total usage, where it is used as a catalytic converter to control the emission of exhaust fumes

Presently all US cars have to make use of these convertors and a move is afoot in Europe to introduce them there as well, but the advent of lean-burning engines could upset demand projections to some extent

In a report by brokers J Aron/Goldman Sachs, mine pro-

duction is expected to fall by about 2.5 percent this year, with total supply at about 2.75 million ounces and total demand up by 3.4 percent to about 3 million ounces, so a deficit of about 250 000 ounces arises

The largest single user is the US auto industry which is expected to use 811 000 ounces, and jewellery in Japan is second with an expected 627 000 ounces to be consumed this year

Investor demand has rocketed from the 1982 amount of 50 000 ounces to last year's 250 000 ounces and latest figures indicate that it could be over 400 000 ounces this year

Even if one percent of the 13.6 million ounce gold investments is switched to platinum, a 136 000 ounce increase will arise in platinum, pushing the price even higher This is quite possible as marketing in the US and Europe is moving towards this goal and even a two percent switchover is not impossible, given correct marketing

In the event of this happening, the situation of investors and industrial manufacturers chasing the metal and competing with one another could arise, with both chasing after a rising price.

The physical metal is available as ingots or as a one ounce coin called the "Isle of Man Noble", which is an Impala-supplied coin minted on that island, which sells at about a \$10 premium to the daily metal price Sales are estimated to be about 150 000 ounces, or just less than a quarter of Impala's production

Platinum futures also provide investors with opportunities to speculate on the NYMEX as they deal in 50 troy ounce contracts, and some days as much as 10 000 contracts, or about 500 000 ounces are traded

However, as speculators push the price up and down in the relatively small market on NYMEX, analysts warn that if the price rises too rapidly a fall to earth could occur as demand slackens off Analysts suggest that a safe enough level at this stage would seem to be about \$500

JD Anderson analyst Mr Dave Russel says "Platinum's potential is strong because it is used in high-tech industry and doesn't just lie in vaults, but the price must not be allowed to run away because it will necessitate a search for alternative sources and recycling will become more viable and so the price will collapse with the reduced demand"

Platinum is about 10 times more scarce in production terms than gold and so it should maintain its "most precious of precious metals" status for a long time There are however still large deposits in the Transvaal ground and analysts estimate that in reserve terms it is only five times as scarce as gold



NEW YORK TIMES 18 APR 1986 18 APR 1986 18 APR 1986

# Dealers bearish on platinum price

25/4/86 SPAR 217

In contrast to views held by various local analysts published Wednesday, Neil Behrmann, writing from London, reports that despite the labour disruptions at the second largest platinum producer in the world, dealers contend that prices are too high.

He says London and New York precious metals dealers and analysts estimate that Impala Platinum could lose between 150,000 ounces and 300,000 ounces of platinum this year. Normal annual production is around 1 million ounces. New York precious metals dealers J Aron/Goldman Sachs believe there "is a real possibility" that platinum prices could fall in the second half of the year.

The firm says that industrial users have sufficient platinum inventories. Demand could slow in the months ahead, especially since the automobile industry has experienced a decline in sales.

Platinum prices surged from \$244 an ounce in the middle of last year to present levels of \$425 because of labour disruptions at Impala Platinum Mines and an increase in orders from consumers and investors.

J Aron estimates that Impala's production losses will be around 150,000 to 210,000 ounces, but the setback occurred in the first quarter and the flow of the mine's platinum will increase over the next few months.

J Aron contends that platinum prices have peaked even though it projects that demand at 3 million ounces this year will

exceed supplies by 250,000 ounces.

Metals & Minerals Research Services, a consulting firm, says that Impala could have lost as much as 300,000 ounces. Rustenburg's production of around 1.35 million ounces is close to capacity, but so far there are no signs that the mine intends expanding, says the firm.

It predicts that a supply deficit of around 80,000 ounces will keep platinum in a range of \$350-425 this year.

Edwin Arnold, metals analyst of Merrill Lynch Pierce Fenner & Smith expects platinum to trade between \$375-475 because "fundamentals are very encouraging."

## INVESTMENT

But Impala's problems "are probably fully discounted in the price."

Mr Arnold notes that investment in platinum has soared from 45,000 ounces in 1981 to 261,000 ounces last year. But he would advise buying only if the price dips.

At the European Watch and Jewellery Fair in Basle, Platinum Guild International, a marketing organisation, said that about 800,000 ounces of platinum was being used in the jewellery industry. The value of its sales accounts for about 11 percent of total jewellery sold.

The Guild says that platinum has become established in the upper price segment of the jewellery market. Japan, which buys 10 times more than Germany, is the most important market for platinum jewellery.

# Platinum's sheen charms investors

6/15  
MEXAS  
26/10/86

From GARETH COSTA

JOHANNESBURG. — A \$450 an ounce platinum price is within easy reach as foreign investors get more nervous about supplies being cut off with the current climate of racial unrest and strikes that are hitting the gold mines and which recently crippled Gencor's Impala Platinum mine for two months

A year ago platinum was about \$230 an ounce, but it is now trading at around \$415 with prospects extremely good that it could rise through the \$450 level in the near future, or even further if supplies are disrupted again

Japanese jewellers love it, 93 percent of US analysts are bullish about it, European cars will be banned unless they use some of it and demand for it should exceed the supply of three million ounces by about 8.5 percent in 1986

Platinum, which has until recently played second fiddle to gold and silver as a precious metal has come of age, as it performs a solo concerto on the mainstage at the New York Mercantile Exchange (NYMEX)

It has filled the hearts of investors and speculators with new hope as gold and silver remain in the doldrums and platinum breaks

free of its close association with bullion

Analysts here and overseas say the major concern, for industries that is, is a disruption of mine production by strikes, as happened in January on Impala when an estimated 150 000-200 000 ounces was lost over the three months, or about 5 percent of world supplies

The problem is that 80 percent of all supplies come from South Africa, with the bulk of that from both Impala, an estimated 900 000 ounces, and JCI's Rustenberg, with a production estimate of about 1.3 million ounces and then Russia, with about 10 percent

Therefore a strike could seriously upset world supplies since there is little or no stock pile available and prices could take off US investors and speculators are well aware of this fact as can be seen in many publications where the unrest problem is used as a major argument in bullish reports

Platinum is becoming more and more important in world industry, which uses about 65 percent of all supplies, especially the motor industry with over 35 percent of total usage, as it is used as a catalytic converter to control the emission of exhaust fumes

Presently all US cars have to

make use of these convertors and a move is afoot in Europe to introduce them there as well, but the advent of lean burning engines could upset demand projections to some extent.

In a report by brokers J Aron Goldman Sachs, mine production is expected to fall by about 2.5 percent this year, with total supply at about 2.75 million ounces and total demand up by 3.4 percent to about 3 million ounces, and so a deficit of about 250 000 ounces arises

The largest single usage is the US auto industry which is expected to use 811 000 ounces, and jewellery in Japan second with an expected 627 000 ounces to be consumed this year

Investor demand has rocketed since the 1982 amount of 50 000 ounces to last year's 250 000 ounces, and latest figures indicate that it could be over 400 000 ounces this year. Even if one percent of the 13.6 million ounce gold investments is switched to platinum, a 136 000 ounce increase will arise in platinum, pushing the price even higher

This is quite possible as marketing in the US and Europe is moving towards this goal, and even a 2 percent switchover is not impossible given correct marketing



217 STARC 30/4/86

# Uranium price finally shows sign of improvement

By Gareth Costa  
Uranium, the element with earth-shattering potential when in its most refined form, is not about to perform similar antics on the world market. Nevertheless the world price is still expected to improve from around \$17.25 a pound, in oxide form, to \$20 by the end of the year.

The benchmark "exchange value" of uranium collapsed after the Three-Mile Island has-co, when the price was around \$42 a pound, and with it plans for many new nuclear power stations in the US not a single new plant has been commissioned. However, the uranium price is now climbing slowly upwards from the low of just over \$14 in

April 1985, and could reach about \$20 by the end of this year, say industry sources.

The demise of Gencor's Beisa uranium mine also found its roots at this time as the price fell following worldwide public fears of radioactive fall-out. Gencor sold off R225 million worth of plant instead of moth-balling it for future use, realising about R14.5 million on the sale.

In rand terms the uranium price has now improved, and the gold mines are believed to be making reasonable profits on this by-product.

According to the NUREXCO annual review, considered to be the most reliable source of information regarding uranium in the world, this country is the second largest producer, with about 12.2 million pounds of uranium oxide, less than half of Canada's 28.3 million pounds and followed closely by the US with 11.1 million pounds.

However, in terms of the Atomic Energy Act the country's mines may not divulge prices received, actual contracts, amounts sold and working costs. All South Africa's production

is derived as a by-product of gold mining, with Vaal Reefs considered to be one of the most efficient producers, along with Randfontein and Harties.

One of the cheapest producers in Southern Africa is Rio-Tinto Zinc's Rossing Mine in Namibia, which recently produced a profit growth of 489 percent in rand terms, from R16.8 million to R98.9 million.

Rossing is the largest open-pit uranium mine in the world and mining there is cheap, but some of the Canadian and Australian mines have such high grades that

they are far more profitable.

The mine produced an estimated nine million pounds in 1985, a slight drop over 1984, but in line with world production figures which have been in a steady decline, down about 22 percent since 1980 to a total 89.6 million pounds and 10 percent over 1984. SA's 1985 production was down 15 percent over 1984, mainly because of the cessation of operations at Beisa and Blyvooruitzicht. Blyvooruitzicht was the only mine to make a significant increase.

NUREXCO says that in general, the uranium industry has shut

down its unprofitable plants and has curtailed productions to match current contract commitments.

Despite these production cut-backs, supply is outstripping demand at a faster rate than a year ago. Almost three times current world needs are being produced this year, against an average production last year of just over double world requirements.

Figures are seasonal, because of the northern hemisphere's demands for power, dropping to parity last January and rising to almost seven times demand in

July.

London brokers, Rowe & Pritchard, believe there will be an upturn in demand in the late 1980's. But this could be optimistic since most power stations have adequate stockpiles, while production is increasing in Canada and Australia.

"In contrast we feel that increasing pressure will be brought on the uranium producers to narrow the gap between contract prices which are over \$30 and spot prices which are at \$17."

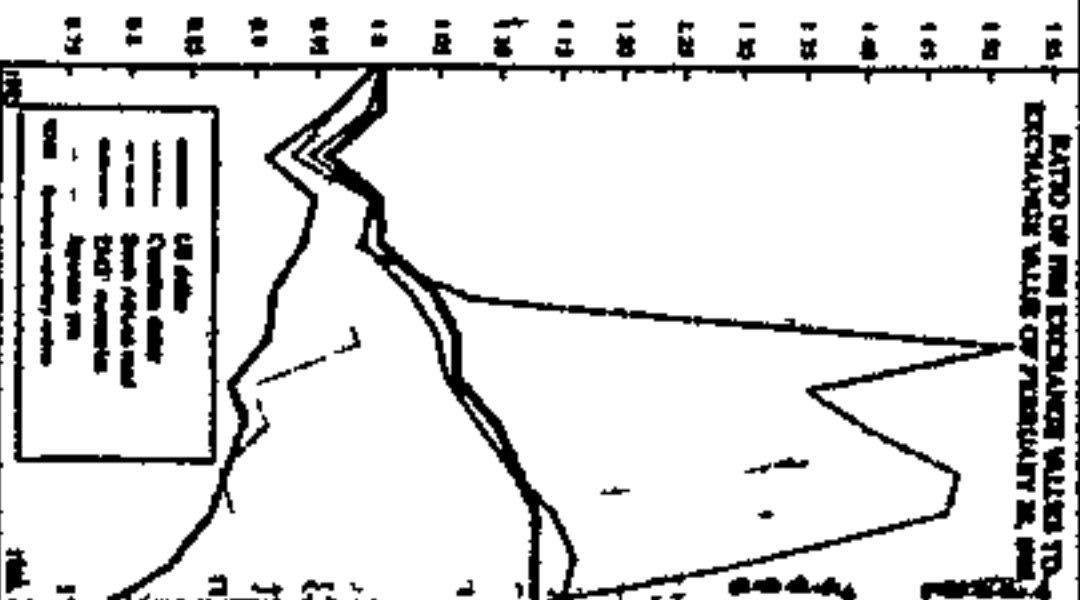



# Platinum hoarding on the increase

## Demand outpaces supply

While world platinum demand is still outpacing supply, hoarding of the metal mainly in the United States and Japan could add new dimensions to the price on international markets

This emerges from Johnson Matthey's annual review *Platinum 1986*, which states that speculative hoarding absorbed 260 000 oz, or almost 10 percent of the total supply in 1985

A surge in US and Japanese hoarding in 1985 was the main factor which contributed to a six-fold increase in hoarding since 1986

There are fears that the release of this surplus on to the market might bring down the price of platinum, which at the moment is rising steadily as a result of limited supply of the metal

The review, however, expects that this will not happen in the near future, as the scope for an uplift in the dollar price of platinum is greater than the prospect of a decrease in 1986, which probably means a continuation of investor interest

The main reason for the expected price rise is concern that a disruption of mine production by strikes could drastically cut back the already reduced supplies from South Africa

The three months strike at Impala resulted in losses of almost 200 000 oz, more than five percent of world supplies. This forced the company to buy in the market to fulfil its contractual obligations

The largest producer, Rustenburg, had sales in the second half

### By Sven Lunsche

of 1985, that were actually lower than a year earlier but it may succeed in raising the level of supply again this year "by squeezing every last ounce out of its present facilities"

The review says that these two mines are almost certainly working close to capacity and are unlikely to be sitting on much above-ground stock

In addition sales of platinum by the USSR, the second largest producer, fell and are not expected to increase significantly in 1986

### Western demand

It is therefore expected that demand will outstrip supplies again as in 1985, when Western demand was about 2 810 000 oz

While this represented only a seven percent increase on the 1984 figure, it was sufficient to exceed supplies, estimated by Johnson Matthey at 2 740 000, by more than 100 000, if Western sales to Comcon countries were taken into account

Demand for platinum will also receive a tremendous boost with the prospect of autocatalysts becoming compulsory in Europe, the US and Japan, within a year or two. The review believes demand for autocatalysts will continue to hold up this year

Use in autocatalysts represented the most buoyant sector of industrial demand for platinum with worldwide sales to the automobile

industry moving ahead by ten percent, with the result that this sector absorbed 875 000 oz or 31 percent of the metal's 1985 sales

US motor manufacturers alone made purchases representing 23 percent of the year's total worldwide demand, raising prospects of an upcoming European market, once the EEC can agree on a uniform policy towards introducing autocatalysts

This hesitation by the EEC government has raised fears that other industries could make advances into the market, especially since substitution techniques have always been prominent in the autocatalyst industry

Says Mr Ken Davies, MD of Johnson Matthey SA "The longer there is indecision about officially introducing autocatalysts other sources have a chance to develop clean burning engines, as Ford have done in the United States"

The third big area of demand is the jewellery industry which took 810 000 oz or 29 percent of sales and thus not far short of the autocatalyst figure. Japan's jewellery industry was the largest single user of platinum last year accounting for 675 000 oz, 24 percent of world demand

Commenting on the overall outlook for platinum, the review points to its fundamental strength as a critical industrial metal which can act as a mainspring for further steady progress

It is suggested that there will be slow but steady expansion of demand and that the scene is set to remain bright

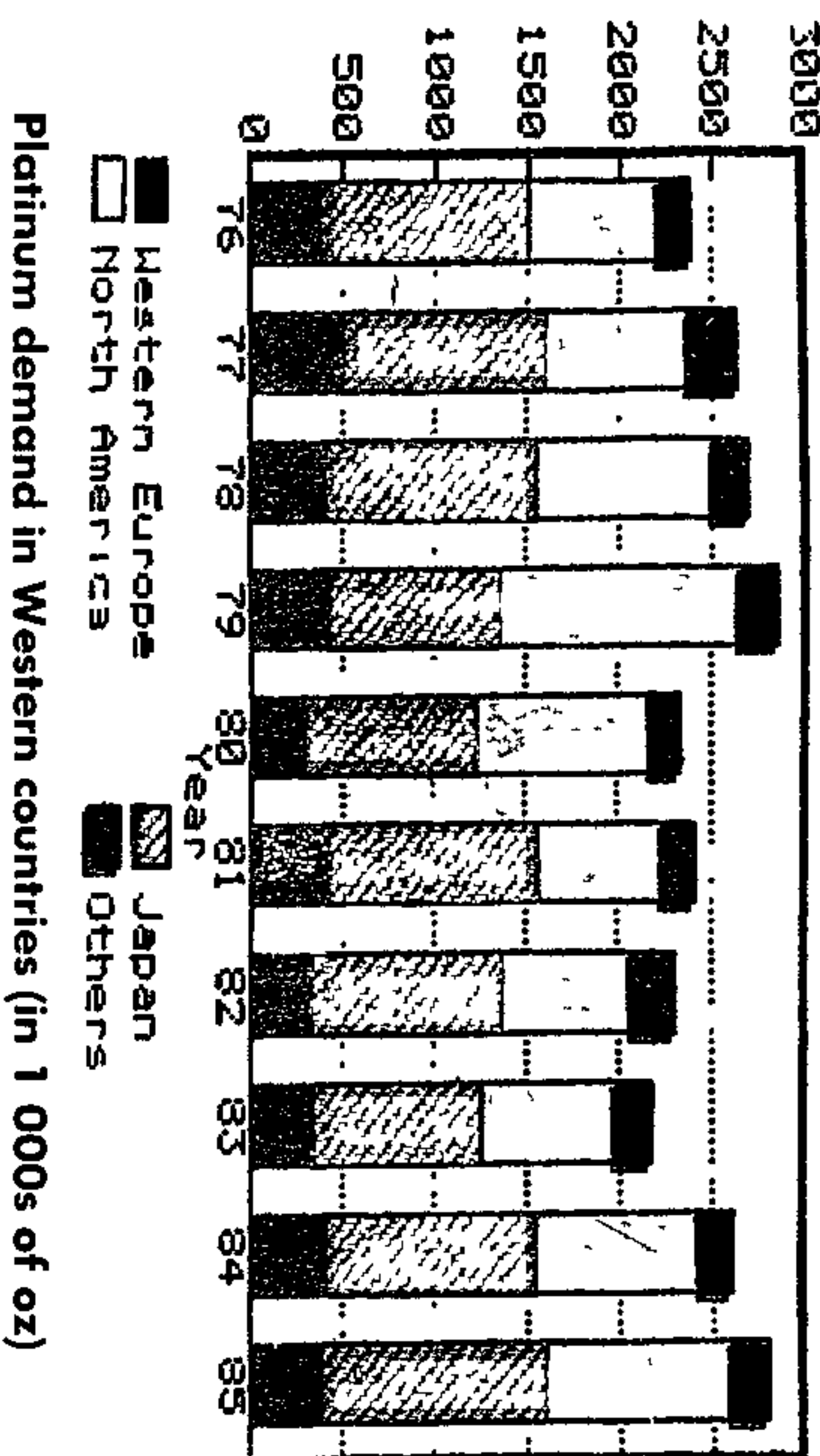

## Market is confused

**By Neil Behrmann**  
LONDON — Opinions differ sharply on whether platinum can continue to maintain its upward momentum this year

During a week in London where platinum producers, consumers and dealers from all over the world discuss the future outlook for the metal, the market is confused

Some like Johnson Matthey, the precious metals refiner, distributor and agent of Rustenburg, believe that the price will continue to rise

Others fear that large speculative positions and a huge hoard of platinum bars and coins could threaten platinum prices if the market fails to meet expectations

Precious metals analysts fear that a hoard of around 600 000 ounces of platinum coins and bars accumulated by investors in the past few years is overhanging a thin volatile market

"Hoarding can work both ways, it could be the Achilles heel of the platinum market," says Edwin Arnold metals specialist at Merrill Lynch Pierce Fenner & Smith (Brokers and Dealers)

Prices surged to a peak of \$415 an ounce from \$244 in only a year because of disruptions on the mines last summer and a strike in the first quarter this year at Impala Platinum, the second largest producer in the world

Now that prices are around \$415, investors may want to take profits, says Mr Arnold

Hoarding and speculative demand is waning, says Brian Nathan managing director of Ayrton Metals, platinum merchants. He says that demand from Japan has slackened in recent weeks because Japanese prices have been falling in tandem with the appreciation of the yen



2/25/86 SMM

217

# Speculators hesitant on palladium

By Sven Lünsche

While South Africa took advantage of a drop in palladium supplies from the USSR, the gloom in the market caused the price of the platinum group metal to decline to a three-year low in 1985.

Demand for palladium declined by almost 7.5 percent to 2 740 000 oz and contrary to platinum, which is in huge demand as a result of the surge in the autocatalyst industry, shed most of its 1984 increases in the process.

According to Johnson Matthey's publication, *Platinum* 1986, palladium was traded down to \$90 in December 1985 compared with \$139 a year earlier. Speculators were unenthused by a drop of 16 percent in the volume of palladium futures traded on the New York Metal Exchange.

Demand is conditioned to a large extent by technological

developments in dentistry and certain electronic components and as the year turned, a few long-awaited signs of recovery in these sectors began to appear. As a result the palladium price touched \$110 in mid-January 1986, aided also in part by the strength in platinum.

As the demand from both the electronics and the dentistry sector continued to recover throughout 1986, the price was maintained around these levels and is currently trading at \$108.

The improvements early this year was also helped by the news that the USSR was changing its selling methods for 1986 and had abandoned its monthly option or 'frame' price arrangements. During 1985 the Soviet traders frequently pitched their option prices well above market levels, so much so at times as to be almost academic.

Nonetheless, in their three-year history Soviet option prices have generally had the effect of

Palladium supply, 1980-85

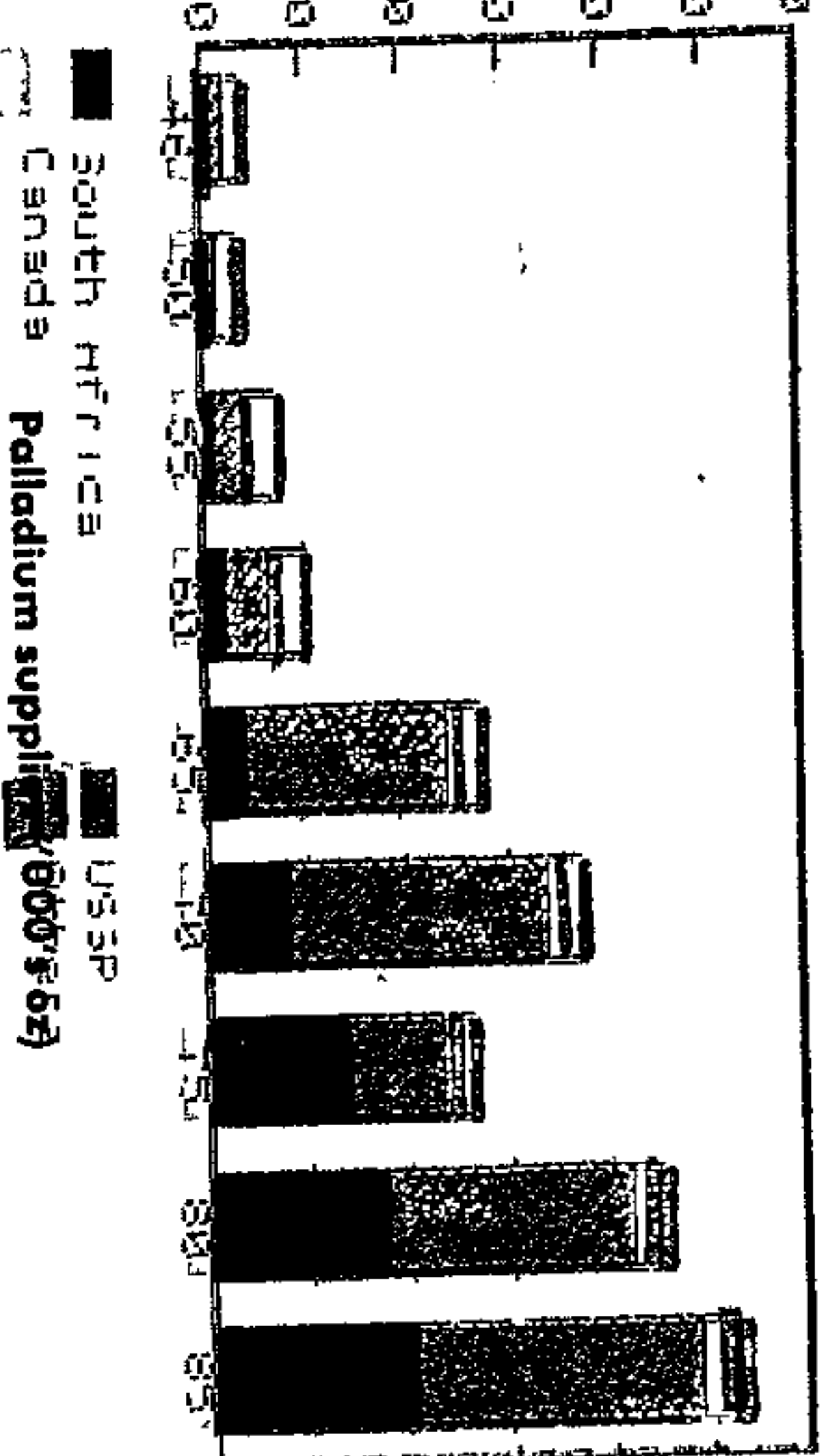

putting a ceiling on the market, although in the poor fundamental conditions of 1985 it is questionable whether the market would have been capable of rising much, option or no option.

In 1986 the USSR intention is to sell palladium above normal contract quantities only to merchants holding such contracts and at market-related prices,

but Johnson Matthey does not expect a great deal of change in prices, as the Soviets are likely to regulate the flow of the metal for its own purposes.

Palladium shipments from South Africa in 1985 rose by about 33 000 oz (four percent) compared with 1984, reaching a record 1 010 000 oz. More pgn

ore is now being extracted from the UG2 reef, where, on average, platinum and palladium are found in closer balance than in the Merensky reef, although pgn distribution is not uniform throughout.

More palladium could therefore become available for sale if the producers were to take a higher proportion of ore from UG2. The effect would be very gradual, but was probably not noticeable in 1985.

Supplies from the USSR dropped to 1 440 000, 15 percent below the 1984 figures and the review expects Soviet traders to keep out of the spot market unless the price is right for them, as annual contract quantities are also believed to be lower this year.

It remains likely that reduced Soviet sales have less to do with a possible need to conserve palladium for the home market than with the poor returns that were available for much of 1985.

ment of the equipment  
give campaign to market it worldwide.  
The only problem to solve might be

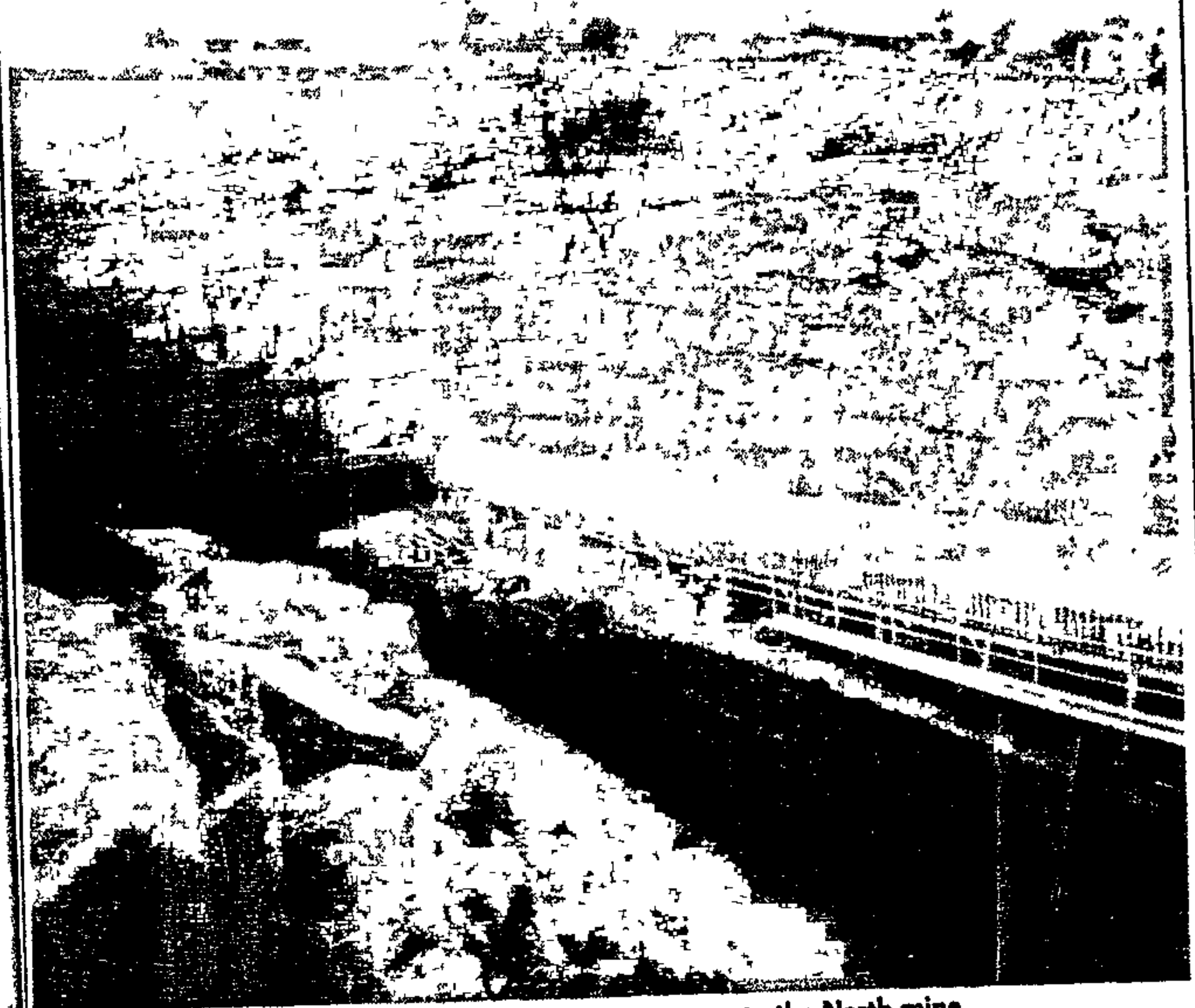

The conveyor system at the entrance to the North mine.

W.  
sa  
So  
cu  
sq  
ca  
  
Co  
si  
Ho  
ap  
  
sal  
dot  
sio  
spe  
  
pr  
19  
to  
all

## New anthracite mine opened in KwaZulu

By Stan Kennedy.  
Zululand Anthracite Colliery, completed at a cost of R86 million by Trans-Natal Coal Corporation, was officially opened on Friday by the Minister of Mineral and Energy Affairs, Mr Dame Steyn.  
Anthracite makes up only two percent of South Africa's reserves but it is in great demand overseas. Last year, the country exported 3,8 million tons or 8,5 percent of its total coal exports.  
Total value of all anthracite sales was more than R315 million or six percent of the value of all coal sales. The mine started production in June last year and has an expected life of 22 years. Situated in the heart of KwaZulu, 48 km from Ulundi, it will produce 875 000 tons a year,

of which 700 000 will be exported to the United Kingdom, Europe and the Far East.  
Anthracite is currently being produced from two shafts and provision has been made for more shafts in the next 10 years.  
Water is supplied from the nearby Black Mfolozi river. Because it is frequently affected by drought during winter, water is pumped in the rainy season to a 320 000 cu m dam, ensuring that the mine has nine months' supply in the event of a dry winter.  
To provide facilities to the mine, 15 km of roads were constructed and 45 km of power lines and 50 km of telephone lines were erected. A rail siding was also built.

## Fixed interest

Interest rates have been moving substantially upwards since the 1970s, especially with the advent of higher inflation rates.  
Consequently corporate borrowers have been faced with severe problems in so far as one of their major instruments to fund the various corporations is long-dated fixed interest stock. The market has become increasingly volatile and within a trend large moves can occur.  
Whilst it is true that some of the stocks issued in the 1970s and early 1980s and with regard to inflation can be seen as cheap financing, this is a situation which may not necessarily continue in the future.  
The fact remains that most public borrowers have a fixed borrowing programme and have to go to the market for certain fixed amounts every year.  
There are two alternatives available to the borrower; they can either make the choice to just borrow as and when their time comes up to borrow, or al-

In  
lie  
Jo  
th  
ra  
w,  
to  
pr  
ce  
re  
of  
  
te  
th  
  
ro  
in  
lo  
  
fu  
pa  
pe  
pa  
hu  
  
na  
to  
co  
ty  
ra  
pr



~~BW DA/29/171~~

**Anthracite  
colliery (27)  
in Zululand  
is opened**

**ROY BENNETTS**

**GENCOR'S new R86m anthracite colliery in Zululand has opened officially.**

The coal producer will supply 875 000 tons/year for both the domestic and overseas markets such as the United Kingdom, Europe and the Far East

During its expected 22-year life, the colliery will recover a high quality low sulphur anthracite to augment last year's total export of 3,8-million tons of this sought-after commodity.

In 1985, the total value of all anthracite sales in South Africa amounted to R315m, or 6% of the value of all coal sales.

To provide facilities for the mine, 15km of road had to be constructed and 45km of Escom power lines and 50km of telephone lines erected.

mature on August 29, are mainly to help ease mining houses' August tax payments

The average rate at the weekly Treasury bill (TB) tender rose five points to 11% as liquidity tightened. The average rate at Monday's Land Bank tender was down a point at 11,17%. The tenders were well subscribed — the TB attracted R166m for the R60m offered while R136m was bid for R50m of Land Bank bills. This reflects the scarcity of private-sector assets.

The three-month bankers' acceptance (BA) rate has been around 11,25% since last Monday while call rates have firmed 25 points to 11%-11,5%. On this basis BAs offer the highest return. Small wonder banks are holding on to BAs.

Negotiable certificate of deposit rates were virtually unchanged ■

SILVER PLIN MAIL 30/5/86

**Four-year low** (217)

The London silver bullion market has reached its lowest level in nearly four years.

While there are no fresh factors to explain the fall, which has been going on sporadically for months since the levels above 450p/oz reached in February, the market continues to

suffer from chronic over-supply. It is demonstrating once again that the silver price is effectively separated from those of gold and other precious metals.

"There's just too much silver around," says a leading bullion house. "The market is suffering from an intense attack of apathy."

Oversupply has been a factor for years, but in the past that slack has been taken up by speculators, including the famous Hunt brothers, who accumulated about 500m oz in the early Eighties. What marks the latest slump out is that speculative buying is almost absent.

"The only speculators in the market are those selling short," says a trader. "Ironically, the only thing that's stopping the market going down further is that there are a lot of short positions. Silver has come to be seen much more as a commodity pure and simple, rather than a hedge against inflation."

Consumption in the photographic and jewellery industries, among others, is at only 75% the level of the early Seventies.

The oversupply is aggravated by the fact that the two biggest producers, Peru and Mexico, desperately need foreign exchange — even more than the two main producers of gold, SA and the Soviet Union. "They can't afford to finesse the market," says a dealer.

According to Drexel Burnham Lambert,

**Still falling**

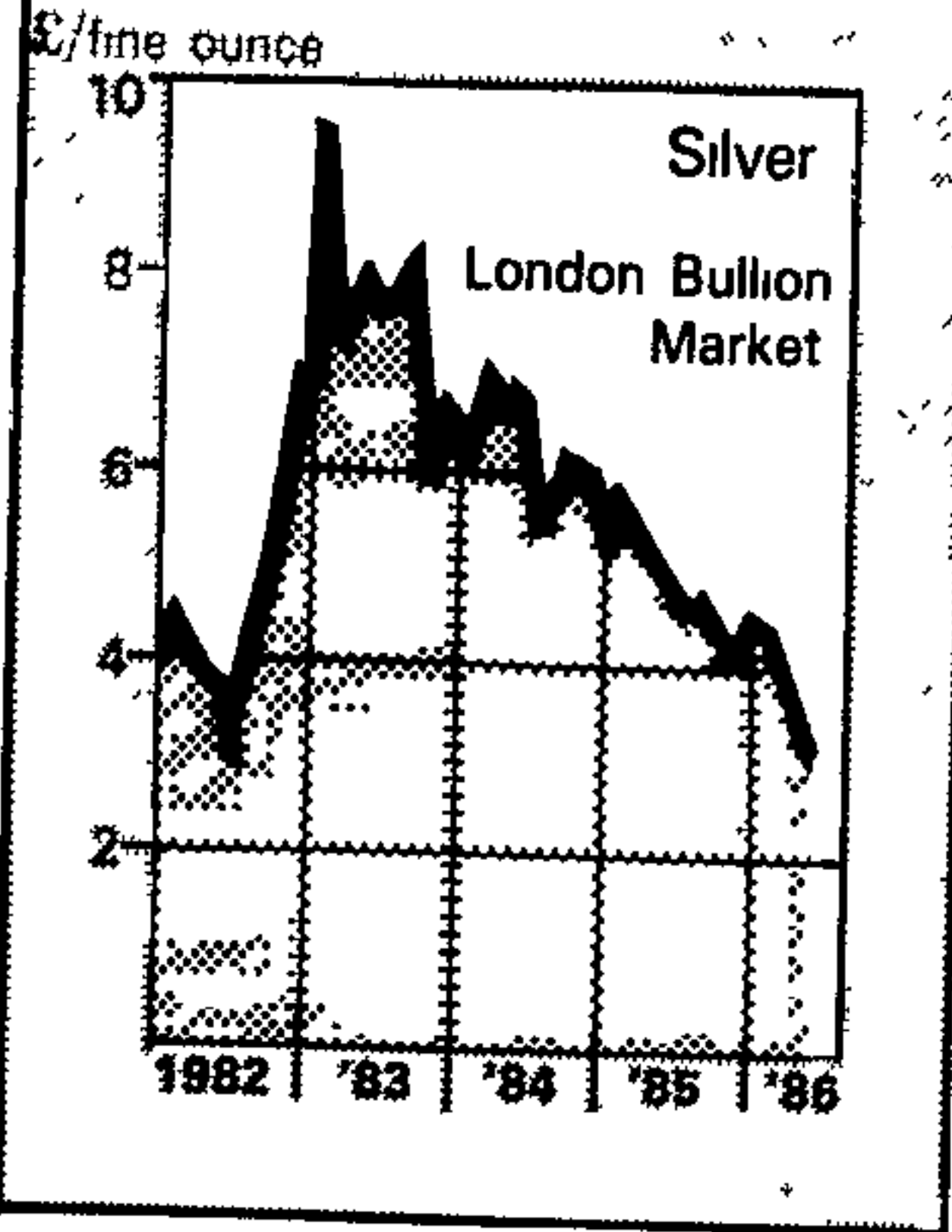

excess supplies were running at about 115m oz a year in the first half of the Eighties.

According to pessimists, one of only three things could reverse the price decline:

- A huge increase in industrial consumption of silver, which seems unlikely,
- A resurgence of inflation, or
- A decrease in supplies from smaller producers like the US, Australia and Canada as a result of declining profitability. That, too, will take some time to filter through. ■



# Platinum gains \$8 on the day

*CMC Times 31/5/86*

LONDON. — Gold held steady in fairly light trading, while platinum broke through what was considered a resistance area to gain about \$8 on the day, dealers said

Gold closed at \$343,40/80, a little up on its fixing prices of \$343,20 in the afternoon and \$343,35 in the morning, and on the opening \$342,90-\$343,40

But interest in the precious metals sector was concentrated on silver, which rallied for a second afternoon running but gave back some of its gains at the close, and also on platinum, which was around \$422

an ounce by London's close after a \$417,50 afternoon fix and \$416,35 morning setting

Dealers said platinum had moved through the \$418 to \$420 resistance area after repeatedly failing to do so earlier in the week.

Over the last few days, a series of platinum-buying spates in New York have been turned back at the \$417-mark, they noted.

They said the fact that platinum had held above \$420 late in the London afternoon instead of easing in line with silver was perhaps an indication of its bullish fundamentals, notably the massive dependence on SA for supplies

Concern about the situation in SA is perhaps more immediate in New York than it is in London, a dealer added

● In Zurich, gold ended slightly higher in quiet trading in spite of the firmer dollar, dealers said

Gold ended at \$343,40-\$343,80, \$1 above the previous close and \$0,55 above the opening

# There's a fortune in those sand hills

By Stan Kennedy

A rich source of foreign currency for South Africa is being recovered from sand dunes near Richards Bay in the form of rutile, zircon and limonite. Gangco, which has a 25 per cent interest — the balance is held by overseas interests — says in its annual report that 1985 was a record year in all respects for the company. High sales volumes were achieved which, together with higher rand prices, gave record revenues. The net result was a substantially improved profit

with a R60 million dividend distribution to shareholders. Richards Bay Minerals has been mining the sand dunes near Richards Bay for the past 10 years, using dredgers which float on man-made fresh-water ponds. The sand is sucked up by the dredger and pumped to a floating gravity concentrator where the minerals are extracted into a concentrate. They are then taken away for separation by smelter.

The rutile and zircon are sold on the international market, while the limonite is processed further to produce a high titanium slag and a high purity pig iron. Expansion plans have been approved for a third smelter, a slag re-grind plant and an increase in mining capacity. To uprate the extraction of minerals, BTR Sarmcol has designed and developed a corrosion-resistant rubber dredge and tailings hoses.

The dredge hoses are 100 mm in diameter and free of wires and cable reinforcement, which has been a drawback in the past because of corrosion problems in the severe coastal conditions. Though of soft-wall construction, they can withstand the normal suction pressure conditions without collapsing. A particular advantage, says BTR Sarmcol, is the ease with which a dry clog can be detected and freed.

The tailing hose is 381 mm in diameter and both have been designed for little or no movement under pressure. This is an important feature as it helps to stabilise the floating platform on the pond. Rehabilitation is an important environmental aspect of the mining operation. Mined-out land is re-covered with topsoil and the dunal vegetation is quickly re-established. It eventually shows no sign that a major mining operation had been undertaken.

A further feature of the new hose is that a 65 percent higher longitudinal pull can be exerted on it without damage to the fittings. As a result, the hoses can be used to stabilise the barge during high winds. **RICHM** The dredger at work on the sand dunes at Richards Bay



subject, estimated that Western bought directly from their



RusPlats

1968  
daily pay

to rise 19 pc

The Rustenburg Platinum Mine has agreed to increase the wages of all its daily paid workers by 19 percent under an agreement with the Federated Mining Union (FMU)

In a statement, the FMU said monthly paid employees and nursing staff would receive a 15 percent increase while security staff would get 18 percent

"Management also agreed to increase the holiday leave allowance from 75 percent to 100 percent or a 13th cheque," an FMU spokesman said.

Employees' living-out allowance has been increased from R80 to R120 for married and single employees who choose not to live on mine property.

The improved wages and conditions of service apply to all workers on the mine, not only union members

The new agreement becomes effective on July 1

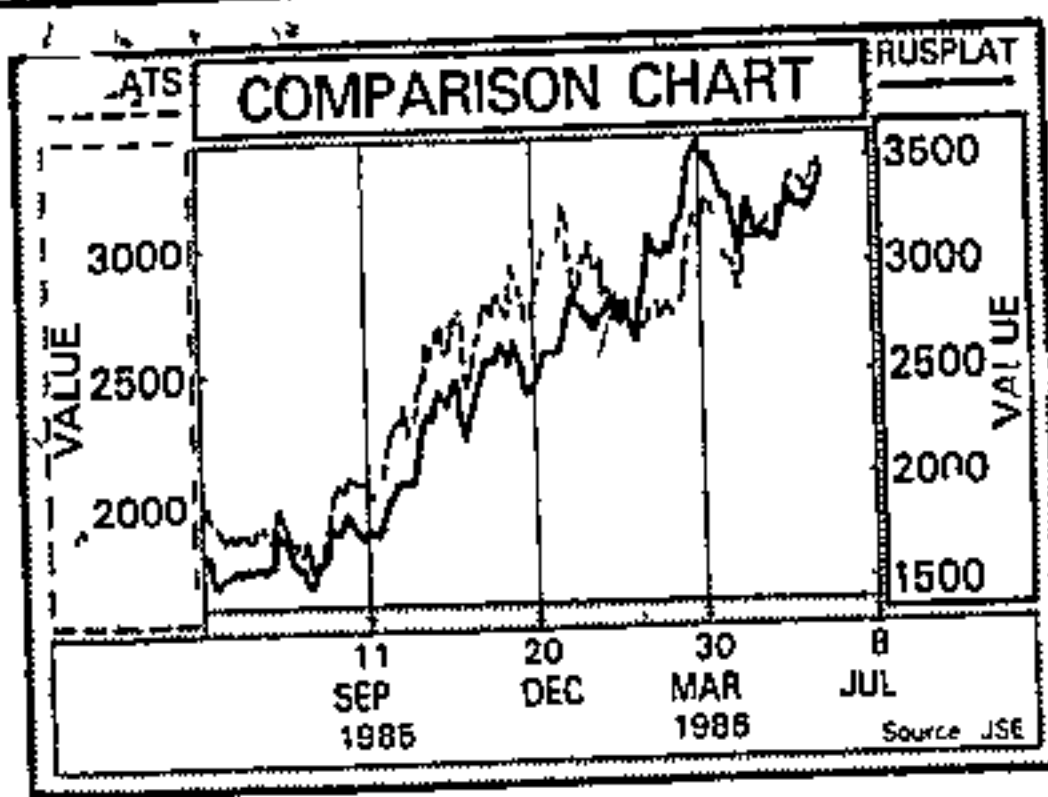

**RUSTENBURG** Platinum is regarded as offering better value during economic recessions, while rival producer Gencor's Impala is considered to be more attractive during boom times.

Accepting that the task of comparing the performance of these companies is not an easy one, stockbrokers Menell, Hyman and Rosenberg use several qualitative arguments concerning the feasibility of the two producers.

Analysts Gad Ariovich and Phil Ward believe that actual platinum output by Impala and Rustenburg is 950 000 oz and 1.3-million oz respectively, while the cost of production is lower at Impala because of shallower mining levels.

Impala's share provides a higher dividend and earnings yield than Rustenburg, with both gross and net profits a share higher for the Gencor producer due to Rustenburg's allocation of a high portion of its profits to reserves.

Rustenburg has little or no control over the marketing of its platinum as this is handled by British-based

# Merits of platinum firms explored 217

**ROY BENNETTS**

Johnson Matthey. On the other hand, Impala enjoys lower marketing costs because of its 100% control of Ayrton Metals.

The analysts believe that Rustenburg pays as much as 5% commission on sales to Johnson Matthey.

However, they concede that the marketing of platinum by a reputable foreign company is not without advantages.

Johnson Matthey is said to enjoy close connections with end-users, and during lean times can be more effective in its marketing than a company located in South Africa.

This can also be advantageous in

the light of the prevailing hostile business environment overseas for South African products.

Close foreign connections are seen as an edge when it comes to gaining European supply contracts during the enforcement of the new anti-pollution standards.

Historically, Impala's shares have traded at a premium to the JCI producer. But Rustenburg has now become more expensive.

The analysts conclude that while Impala might provide a better opportunity in the short-term, Rustenburg has the ability to expand its production capacity to a greater extent, providing a better investment over the long-term.

## T & N protects its interests

**CAREFUL** balance of its operations has protected Turner and Newall, which lists its shares on the JSE tomorrow, from the worst of the recent downturn.

T and N has succeeded in holding its taxed profit at around R7.5m for the past two years despite the mar-

**Investment Staff**

kets in which it operates being hard hit by the recession.

The company controls businesses in the automotive components, building and pipe products, industrial products, chemicals and plastics industries.



10/6/86 BowDAI (217)

# Platinum leads surge in price of precious metals

NEW YORK — The price of precious metals, especially that of platinum, soared in the United States in anticipation of further unrest in South Africa

Traders fear the escalating turbulence could disrupt supplies.

The dollar closed higher in New York and on European markets after falling in Tokyo. It was buoyed by a surge of technical trading by speculators.

The precious metals rally began in the morning. Platinum for current delivery jumped \$25, the maximum allowed, to close at \$445.70 an ounce on the New York Mercantile Exchange.

The gain pushed the price of platinum to its highest level since the third week in March when it closed near \$450 an ounce, according to American Precious Metals Advisors of New York.

Gold was quoted at \$351 an ounce at 16h00 EDT at Republic National Bank of New York, up \$9.50 from Friday's late bid.

On the Commodity Exchange in New York, gold for current delivery gained \$9.60 to \$351.10 an ounce. And silver rose 21 cents to \$5.377 an ounce on the Comex.

This morning in Hong Kong, however, gold retreated slightly at \$347.87.

"We had quite a rally, led by platinum. It was clearly the result of anticipation of unrest," said Mr. John Norris, Citibank's head trader for precious metals. "It's been a few months since we've seen any rally like that."

Mr. Jeffrey Nichols, of American Precious Metals Advisors, attributed the precious metals rally to other factors as well.

Precious metals prices also moved up in anticipation of higher inflation, he said.

Currency traders bought dollars to cover short positions taken at the end of last week, dealers said.

Late dollar rates, compared with late rates on Friday, were

● 2,2470 West German marks, up from 2,21875,

● 168,375 Japanese yen, up from 167,275,

● 1,85225 Swiss francs, up from 1,8310,

● 1,3893 Canadian dollars, down from 1,3965,

● 7,15250 French francs, up from 7,0845.

Sterling fetched \$1,49775 versus \$1,50725 in New York — AP.

CP 7/21/80 11/6/80 (20) (21) (22)

# Gold, platinum prices surge Exhibition attendance drops 8%

LONDON. — Platinum and to a lesser extent gold should continue volatile, with the possibility of further significant gains, ahead of the June 16 anniversary of the Soweto riots in SA, dealers said.

Gold closed at \$348,70-\$349,10, slightly up on its sharply firmer opening of \$348,30/70, and \$6,50 ahead of Monday night's close here.

The opening reflected a strong rally in New York on Monday that was fuelled by the SA crisis.

Platinum was fixed in the afternoon at \$440,25, \$17,25 up on the previous afternoon fix, but was starting to come off as the London market closed.

Dealers said that if New York's platinum price for July delivery could break through resistance around the \$448 to \$450 area, it could easily reach \$460 and then the way could be clear to \$500 in the fairly near term.

While movements in the platinum price are expected to be choppy, no operator wanted to go short, given that troubled SA accounted for over

80% of supplies.

Gold could make further gains if the New York market took August delivery through resistance around the \$357 level.

But the existence of extensive gold stocks outside SA could put a damper on any advances.

Dealers said that while the New York market was focussing on the near-term possibility of civil unrest in SA at the time of the Soweto anniversary, London operators were equally concerned at the prospect of Commonwealth sanctions on Pretoria.

The precious metals market opened here with light follow-through buying, which quickly turned to selling as feeling grew that movements had been overdone and profits should be taken. This pattern repeated itself after New York opened.

Gold was fixed at \$347,55 in the morning and \$347,70 in the afternoon. Dealers detected some producer selling of gold and possibility platinum.  
— Reuter

ATTENDANCE at this year's Cape Town Chamber of Commerce's Design for Living exhibition at the Good Hope Centre was about 8% down on last year at 97 000 people.

Exhibition manager Roger Haupt, however, notes that a public holiday fell on a traditionally busy Saturday. The mid-week attendance figure was broken last Thursday with 11 800 visitors.

More than 200 exhibitors participated, although five companies pulled out at the last minute. Their stands were taken up by others on the waiting list.



11/6/86.  
S. [unclear]  
(217)



victims of the blast at the Rustenburg Platinum Mine arrive at the Johannesburg Hospital by helicopter last night

## Two burnt in platinum mine blast

By Sue Dobson and Craig Kotze

Two electricians were badly burnt yesterday in what was apparently an accidental blast at the Rustenburg Platinum Mine in the Western Transvaal.

Mr M Oosthuizen (43) and Mr M Bornmann (46) were injured while working on an electrical transformer.

Both men were admitted to the Rustenburg hospital but were airlifted by emergency helicopter to the Johannesburg Hospital last night

A mine spokesman said the Department of Mineral and Energy Affairs had launched an investigation

Mr Oosthuizen sustained burns over 11 percent of his body, while Mr Bornmann suffered 90 percent burns. A hospital spokesman said Mr Bornmann's condition was critical

Mrs Susie Oosthuizen said last night her husband had told her the blast had been caused by the power being turned on while they had been working on the transformer

The mine spokesman said it was thought that the men had been injured when transformer oil caught alight.

# Rusplat to build new refinery

RUSTENBURG PLATINUM (Rusplat) is to go ahead with construction of a R250m precious-metals refinery in Bophuthatswana, on a site near the mine's existing metallurgical installations.

Parent company Johannesburg Consolidated Investments has been appointed principal contractor, while contracts for project management and design services have been awarded to Edward L Bateman.

Construction of the Saref plant is expected to commence shortly, with commissioning estimated for the first half of 1989.

After this, all Rusplat's platinum refining will be moved from existing plants in Royston, England, and in Wadeville to the new refinery.

Both these plants are managed by Matthey Rustenburg Refiners, which is owned jointly by Johnson Matthey and Rusplat.

BUS DAY  
217  
11/18/85  
ROY BENNETTS

This will mean that — with Gencor's Impala mine and Western Platinum already refining locally — all SA-mined platinum will, in future, be processed locally.

Saref is to use a new precious-metals process based on solvent extraction technology, which has been used successfully at a pilot plant in Royston.

Rusplat expects it will derive significant benefit from a reduction in future operating costs — compared with present outgoings at both Wadeville and Royston — by using this process.

Financing of the new plant will be offset against tax as capital expenditure. Rusplat will be in a position to afford the outgoing, as its closing cash balance at the last financial year stood at R234m.



Bus Day 11/6/88

270 265

**Business Day Reporter**

ISCOR has branded a report alleging abuse of mining concessions at its Imcor Zinc mine in Namibia as "drivel" and said it is preparing a detailed response to the territory's government.

*Business Day* understands the submission contends that allegations of pricing irregularities for zinc concentrates and other mineral sales were based on poor understanding of the international metal market

The Grote Report into Imcor Zinc's pricing activities — framed within Mr Justice Pieter Thirion's Commission of Inquiry — alleged the mine failed to declare R64m in a transfer-pricing tax dodge between 1979-1983.

The report calculated that the mine's zinc, lead and silver sales over this period amounted to R84,4m.

The report concluded that Imcor Zinc was selling large amounts of minerals to Iscor at prices well below LMB levels.

"Grote supplied incorrect information to the commission from which the wrong conclusions have been drawn," said Iscor Senior GM (Mining) Ben Alberts

He said the mine's sales had

**Iscor says  
Namibian  
zinc report  
is 'drivel'**

always been linked to international prices: "Imcor Zinc has never resorted to transfer pricing.

"But to assume LMB prices can be applied to the metal content of a concentrate is as ludicrous as to expect that the price of wheat supplied by a farmer should be directly derived from the price of bread," Alberts said.

Iscor will deliver its submission to a "White Paper" Commission of Inquiry into the Thirion Report

"But the report has already done great harm to the Namibian mining industry, Imcor Zinc and Iscor on a local and international level. No amount of corrections will restore the tarnished image," Alberts said

# BUSINESS DAY

(45c + 5c tax) For other prices, see Back Page  
Western Province, Eastern Province 80c (71c + 9c tax)

**MAZDA 323'S**  
**FROM R59,92 P.W.**  
Nobody understands City Motor Group of Nobby  
20 Elton St JHB 331-0351  
**CITY MOTOR GROUP**  
Ten steps for a step ahead

"THE VITAL VIEWPOINT"

217

## GFSa reveals grand plan for new R559m platinum mine

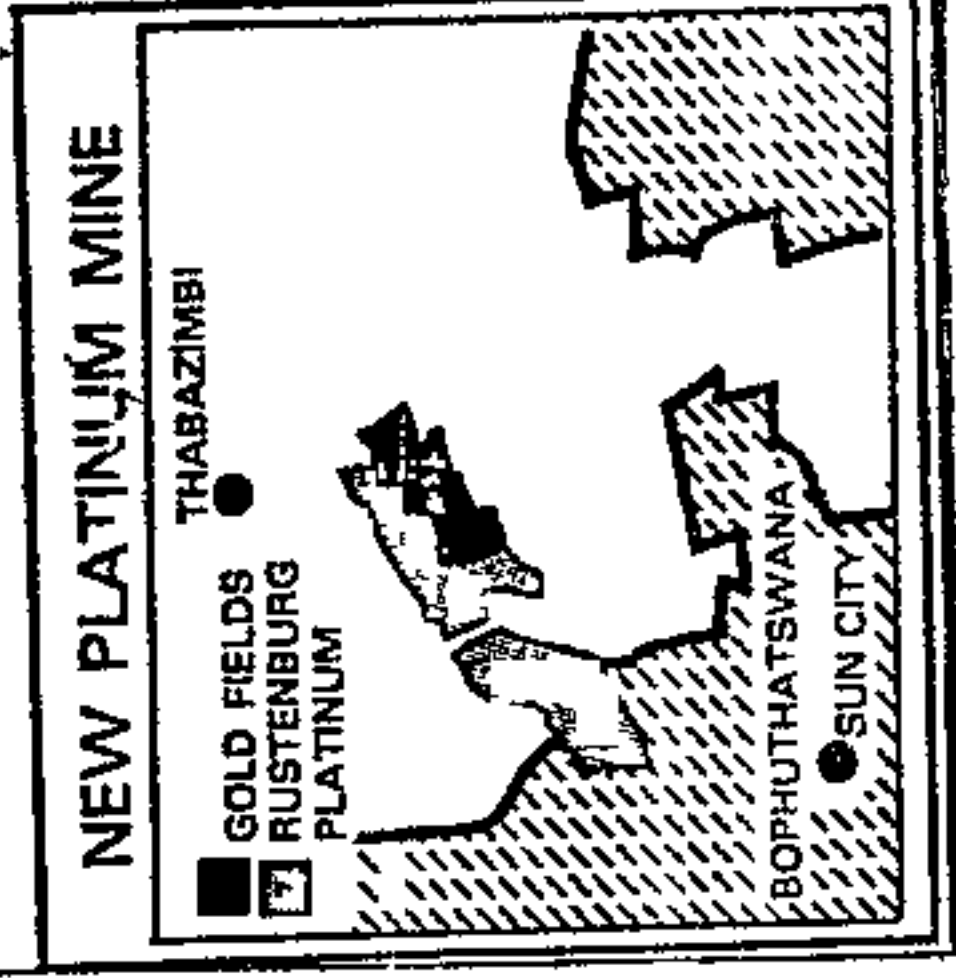

PLANS to establish a new R559m platinum mine, adjacent to Rustenburg's Amadibult property, were announced yesterday by Gold Fields of SA (GFSa). An application has been made to the Minister of Mineral and Energy Affairs for the precious metals lease. It is expected that production will start in five years.

Construction will start immediately on the 10 314ha property between the towns of Northern and Thabazimbi in the north-western Transvaal and down to Amadibult.

The initial output will be 150 000 tons a month from the Merensky Reef, about the same scale of operations as Western Platinum's.

Total reserves on the Merensky reef,

which reach a depth of 2 700m, are estimated to be 163-million tons at an average grade of 10,1 grams a ton of platinum group metals (PGMs) with gold as a by-product.

In addition, 319-million tons of the lower UG2 Reef are available with a grade of 6,6 grams a ton of PGMs and gold as a by-product.

GFSa will provide the bridging finance for the proposed new mine but permanent capital will be raised by means of a rights offer to Northern shareholders.

GFSa has a 78% stake in subsidiary Northern and Cons Gold Fields PLC, has about 12,7%, according to GFSa chair-

man Robin Plumbidge. The remaining equity is held by a London syndicate headed by geologist and analyst Fred Colender and includes a London stock-broking firm and a merchant bank.

Plumbidge said discussions were taking place with the exchange control authorities about the offshore shareholders being permitted to subscribe through the financial rand.

Northern will seek stock exchange listings.

The initial R559m capital expenditure provides for the sinking of two shafts, housing and related infrastructure. The ultimate plan envisages a further two shafts.

Although a strong emphasis has been placed on mechanisation, the new mine

will create about 5 200 new jobs. Future plans are to refine the metals in SA, currently supplies 85,3% of the world's platinum output.

Northern will be a deep mine by platinum-mining standards. Starting at a depth of 1 600m, it will reach down to 2 700m, compared with the mining depths of Rustenburg Plats Amadibult which are between 300m and 600m.

Plumbidge said that "depth is not a technical problem on our gold mining standards, it is a cost factor."

Rock temperatures at these depths are very high.

At 1 500m on Northern the temperature is estimated to be 54°C compared with 35°C at West Wits

Transvaal in as 3 more die



# Gold Fields to work the rich Merensky Reef (217) R560-m platinum project

By Gareth Costa

The first new SA platinum mine in more than a decade was yesterday given the go-ahead by Gold Fields, after extensive exploration in the Rustenburg area proved the viability of the R560 million project. It will be Gold Fields' first major investment in this area.

GFSa subsidiary Northam Platinum announced that it has applied for a precious metals lease, so that it can begin development on the new mine — which will work the rich Merensky Reef.

The lease area is situated next to Rustenburg's Amandelbult section, between Thabazimbi and Northam, and will cover a surface area of about 10 000 hectares.

Construction begins immediately, but the mine is only expected to come into production in five years. Analysts' initial estimates of the mine's life are between 80 and 90 years, based on ore reserve of 163 million tons down to 2 700 metres of Merensky reef being worked at the initial milling rate of 150 000 tons a month.

It will be about the same size as Lonrho's Western Platinum but significantly smaller than Gencor's Impala and JCI's Rustenburg. The 90 prospecting holes drilled since 1981 have revealed an in situ grade of 10.1 g/ton of platinum group metals on the Merensky Reef, while the secondary UG2 reef has deposits of 6.6 g/ton and an estimated 319 million tons of ore.

The mine will be much deeper than other platinum producers in the Bushveld complex — 2 000 metres at the number one shaft and 1 670 metres at the number two — so fears are that costs will be high. But GFSa chairman Mr Robin Plumbridge says that other platinum producers should be down to that depth in five years, so working costs will be more comparable.

The finance for the mine will be raised through a rights issue to Northam shareholders, which comprise GFSa, Cons Gold Fields in London with 12.5 percent and sundry others.

Mr Plumbridge says that GFSa will contribute its share of the capital from internal funds. He does not expect the outlay to affect the group's cash position, and dividends will still be maintained at current distribution ratios.

GFSa will provide bridging finance. As part of the rights issue, Northam will seek a JSE listing.

Mr Plumbridge says that drilling of the number two shaft should begin in about six months, but they have not decided whether Shaft Sinkers or outside contractors will do the work. The collar work will begin immediately.

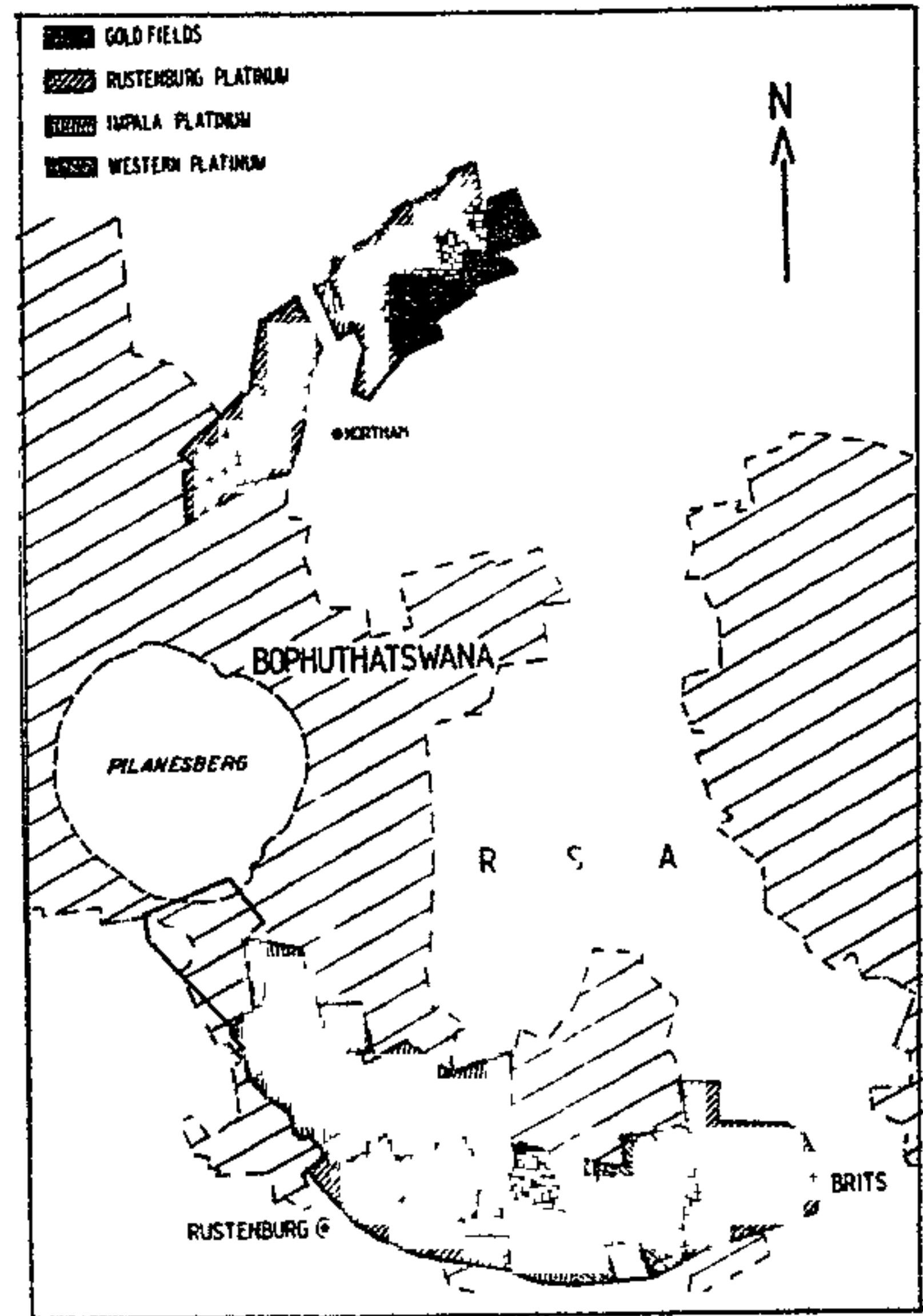

The new mine will be situated just north of Northam in the area shaded black on the map.

## in electronics

Bureau

will save electronics companies developed by the British electrical

years' research and has been have relied for decades on gold for not wear and is non-corrosive properties as a full gold contact — one of the platinum family — by one tenth of the thickness now have a big impact on the electron-

## Floating exchan

By Dr Roger Gidlow  
The floating exchange rate system for the major currencies has been in operation for more than a decade, and in recent years several other countries besides South Africa have adopted floating currency arrangements.

pressures on their currencies which have reflected balance of payments problems which in turn have partly stemmed from external influences. Like South Africa they have found that a weak currency is a mixed blessing. It has imposed costs in

of the sharp fall in the Secondly, the Austri-

for a large-scale expansion of Foskor's export business to 2 Mt of concentrates by 1989. Secondly, greater exposure to the export market would help keep down increases in the cost of phosphate rock to local consumers who process it into phosphoric acid and will otherwise end up funding Foskor's operations through hefty price increases. These are some of the findings of a detailed report on the privatisation of Foskor published by stockbroking firm Mathison & Hollidge (MHI).

MHI suggests the phosphate producer be privatised through the Industrial Development Corporation (IDC) listing it on the JSE, and not by selling the company to a mining house. Researcher Nic Dinham suggests Foskor's worth is some R150m, and with the IDC initially holding back up to 30% of the equity, the market participation might be around R100m. Based on an expected dividend yield of between 8% and 10%, an initial listing price of between R8 and R10 a share is indicated.

The Director General for Trade and Industries, Sarel du Plessis, says he has read the firm's report on Foskor, but is not able to comment on its findings and proposals at this stage.

Foskor MD John Stanbury says "The report is correct in its main thrust that Foskor could expand in a major way onto export markets given the necessary funds. My personal opinion is that Foskor should be privatised, because this would be advantageous to all concerned. A key point, however, is the timing of such a move. As the report points out, the last five years have been quite rough for Foskor, and it would be better to go for a listing when the company has shown decisively that it has turned around."

MHI suggests Foskor could push its concentrate exports to 2 Mt by the end of 1989 from present levels of about 700 000 t to meet keen consumer demand. The high grade of Foskor's concentrates is matched only by production from Russia's Kola Peninsula, where output is subject to erratic marketing tactics.

Dinham says Foskor is currently getting about \$43/t CIF Europe (R98 at R1/\$0,44) in what appears a highly profitable trade. He estimates Foskor's breakeven point is about

FIN MAIL 13/6/86 - Neville Glaser

FOSKOR (491) (23/82) (217)

### Privatisation benefits

The long-mooted privatisation of the Phosphate Development Corporation (Foskor) is looking an increasingly logical step, although it is probably unlikely to happen soon. Privatisation could provide funds needed



\$32/t CIF Europe (R73) when revenue from by-products is taken into account. That is much lower than the price at which many of Foskor's competitors could offer lower-grade phosphate concentrates, so Foskor is extremely cost-competitive. Stanbury comments that the breakeven figure is the analysts' own estimate and is on the low side.

Foskor does not mine ore, but obtains it in three different forms from neighbouring Palabora copper mine (Palamin) at low cost. This will change from about 1999 when the report estimates that the economic life of Palamin's openpit will end. That date could vary, depending on Palamin's plans, but when the openpit is mined out, mining operations will have to go underground. Once that happens, Foskor will no longer receive the large tonnages of ore mined from the openpit. This ore has high phosphate grades, but Palamin regards it as waste because of the low copper content.

Foskor will then have to restart its own mining operations. This, MHI says, will involve a large openpit operation south of the Palamin pit, recovering some 28 Mt of ore annually at a grade of about 6,8% phosphate. Capital costs of this project are estimated at about R400m in current money.

Foskor's published figures over the last five years show that the company was able to keep making operating profits despite the drop in demand for phosphate fertilisers in SA. Demand was depressed by the drought, financial conditions in the agricultural sector and the collapse of the phosphoric acid export market. Companies like Triomf were

producing phosphoric acid from Foskor phosphates.

However, the brokers' report says the published figures hide the true financial picture, which it describes as "little short of disastrous." When Foskor's internal cash flows, excluding external financing and short-term loans, are assessed, it appears the company has been unable to make profits from its operations during the period 1980-1984. Foskor has consequently been forced to use external financing, which reached R89,7m at the end of the 1985 year, this was more than four times Foskor's 1985 net operating income before non-cash items, interest and tax.

MHI believes this situation is changing for the better. Foskor stands to make estimated earnings of R23m this year, and R45m in 1987 on higher exports boosted by the weak rand, and on higher prices locally, following the lifting of government control on phosphate prices.

Foskor's immediate need is to strengthen its balance sheet by repaying loans. There could therefore be opposition to plans to invest in large-scale expansion to get further into the export market. MHI says the expansion would be much easier if the funds came in from equity financing via privatisation and a stock exchange listing. If the expansion does not take place, Foskor will have to reduce export tonnages when it is forced to meet higher domestic demand as soon as its present stockpiles of material are reduced, this is expected to happen in 1988.

"There is no doubt that the sustained

expansion of Foskor's export trade is the key to its long-term growth. Indeed, broad export sales equivalent to 3 Mt/year by 1990 are limited only by infrastructural capacity at Richards Bay and by the company's financing abilities," concludes MHI. *Brendan Ryan*

NEI

## Gearing up

Two recent acquisitions from US-based Eaton Corporation will provide NEI with a better spread of activities. In 1985 International Combustion Africa Limited (ICAL) contributed 47,8% of group operating profits, but recent acquisitions may reduce the group's reliance on profits from this source. Although capital expenditure cutbacks by Escom and the projects sector have not yet hampered ICAL's output, longer-term profits could come under pressure.

With effect from June 1, NEI has bought the entire issued share capital of electric control and distribution equipment manufacturer Cutler-Hammer (SA), as well as the distribution service rights for Fuller Transmissions and Eaton Axles, through NEI's subsidiary Propower Automotive Products (formerly International Harvester). MD Blitz Bieber will not disclose terms of the acquisition but confirms that combined annual turnover of the companies acquired will be about R25m.

"Cutler-Hammer (C-H) will fit in extremely well with subsidiary Reyrolle Par-

FCN MAIL 15/3/86 13/6/86

## GFS A PLATINUM MOVES

217

As the AM went to press, it appeared that Gold Fields of South Africa (GFS A) was set to announce that it intends going ahead with the development of its Northam platinum mine prospect. There were strong rumours on the JSE on Tuesday that the announcement would be made this week, although a GFS A spokesman would not confirm that Northam was going ahead or that the announcement was coming.

Mining industry sources say GFS A intends keeping the development in-house at this stage. The present shareholders will finance it internally from their own funds and there will be no immediate move to raise funds by listing Northam on the Johannesburg or London stock exchanges.

GFS A holds 51% of Northam, while GFS A controlling shareholder Consolidated Gold Fields (Cons Gold) holds another 21%. Both companies have the financial resources to fund their shares of the project easily.

If Northam is to be listed, it may be done when the mine is well underway, and GFS A and Cons Gold can maximise

their returns through higher listing prices. In that way, they would have to sell fewer shares to the public to raise the required funds.

The Northam area lies down-dip of the Amandelbult section of Rustenburg Platinum Mines. That poses a number of problems for GFS A. Northam will be deep, with mining taking place from about 1 500 m below surface. That implies high working costs because of the high temperature gradient on the Bushveld Igneous Complex where, at 1 500 m, the heat is comparable with that experienced at 3 000 m on a Witwatersrand gold mine.

Northam also faces heavy competition from Rustenburg, which can boost production rapidly and cheaply from Amandelbult by sinking a series of shallow incline shafts to mine the Merensky Reef at depths of about 300 m.

GFS A has released no technical information on Northam, but analysts' reports have put production in the 150 000 oz-250 000 oz a year of platinum ballpark, with the cost of the development at around R700m.

*Brendan Ryan*



# Boom for precious metals and minerals?

LONDON — The state of emergency declared in South Africa has deepened uncertainty over the future of the vast mineral wealth which helped put South Africa among the richest countries on the continent, dealers say.

Analysts agree that precious metals and other minerals would appreciate "if the world thought supplies were going to be disrupted," as one put it.

Yesterday, platinum, vital for the car industry, surged to its highest price for three years, reaching \$450.50, although one analyst saw it as likely to retreat.

## GOLD

Gold has been less volatile, but has gained strongly this week to \$347.40 at around mid-day yesterday from \$341.65 a week ago. Large world stocks of the metal have made it more resistant to developments than platinum.

South African Government officials are reluctant to dwell on the leverage the country holds through its mineral wealth for fear that such talk will increase overseas calls for alternative sources — Reuter.

Argus 16/10/86 (JRP)

# Gefco closing asbestos mine

## Argus Correspondent

JOHANNESBURG — Griqualand Exploration and Finance Company (Gefco) is to suspend operations at its Pomfret asbestos mine in the North Western Cape from July 1.

About 90 percent of the 850 workers will lose their jobs.

The mine produces about 15 percent of Gefco's crocidolite fibre, for which world demand has slackened.

The decision to moth-ball the mine was prompted by the continuing slackening of world demand for crocidolite fibre, due to economic and political problems in certain export countries as well as the health issue.

The company says every effort will be made to place the redundant employees elsewhere in the group.

The mine accounts for about 15 percent of Gefco's total production of

crocidolite and amosite, and for some 25 percent of its crocidolite sales

The company said the continuing slackening of world demand for crocidolite fibre was due to economic and political problems in certain export countries as well as the health issue

It would have been uneconomical to scale Pomfret's production down further, particularly as the mine had substantial fibre stocks and as the Kuruman mine had spare capacity which could be used to supplement these stocks if necessary

As these sources were enough to meet the anticipated level of demand for this year, the closure of Pomfret would not materially affect Gefco's results in 1986, which were still expected to be in line with those of the previous year, said the company.



# Platinum the top mineral

PLATINUM has become the new "rush" mineral with a price of about \$450/oz compared with gold's \$347/oz

World production of the metal is clouded due to the classified nature of the platinum-group metals and the estimated level of recovery by the Soviet Union.

South Africa, including Bophuthatswana, is the world's only major primary producer, while the other main producing countries recover platinum as a by-product of nickel mining.

Estimates of production tend to place the USSR marginally ahead of SA, but this will change when recovery from Gold Fields' new Northam mine reaches the market.

Also in the pipeline is the planned platinum production from the Vansa vanadium mine.

Last year SA supplied the Western world with 2.3m ounces while the Soviets

217  
BUS DAY 1/6/66  
ROY BENNETTS

sold 230 000 ounces from a falling recovery level

The new Northam mine is expected to reach a recovery similar to Western Platinum, which produced nearly 146 000 ounces last year.

While main SA producer Rustenburg and second-placed Impala are believed to be almost at full capacity, the additional recovery from Northam should push SA into a clear lead as the world's major producer

Platinum mining in Canada, the world's third-placed producer, is normally overshadowed by the country's new "gold rush", but of late there has been speculation of increased activity.

At least three new mining projects are in the pipeline to boost the present estimated recovery of 170 000 ounces a year, of which 150 000 ounces is placed on the world market.

20/6/86  
NORTHAM PLATINUM *FINANCE*  
**Bold venture** *(217)*  
Key unresolved issues for Northam platinum mine, which received the official go-ahead from Gold Fields of South Africa (GFSA) last week, concern GFSA's plans to refine



the mine's production of platinum group metals (PGM), and estimates on world platinum demand in 1991, when the mine starts production. The refining plan could affect the capital cost, budgeted at R559m in current money.

GfSA chairman Robin Plumbridge has left the issue of the refining of Northam's PGM wide open. He said no decision had been taken on the location of the PGM refinery or the technological route to be followed, pointing out the group had time in hand for a decision. He said the budgeted cost included provisions for setting up a refinery costed on the classical refining route involving leaching and smelting.





The alternative technology involves a process called solvent extraction (solvex), one version of which was developed by the Council for Mineral Technology (Mintek) for Impala Platinum. Another version has been developed through pilot plant test work at Rustenburg Platinum's (Rusplat) Royston refinery in England, this system is to be used in the R250m Saref refinery to be built by Rusplats for treatment of its entire production from early 1989.

Rusplats' new refining plans raise another possible option for Northam to buy the Wadeville refinery and refurbish it. When Saref is operating, Rusplats' Wadeville PGM refinery will be closed down and there will be a two-year gap between the start-up of Saref in 1989 and the start of production from Northam in 1991. Asked about this, Plumbridge repeated GfSA was looking at all options. A Rusplats spokesman commented "We are unlikely to help competitors."

Plumbridge would not disclose information on the mine's expected recovered grades and, therefore, PGM production. However, ballpark analysis, based on published Mersky reef values from other mines, and counting on the known uniformity of the reef, is that Northam could initially produce about 280 000 oz of platinum annually. Expansions would depend on market conditions.

The *in-situ* grade at Northam on the Mersky is 10,1 g/t, of which 60% should be platinum, 25% palladium, 8% ruthenium, 3,2% gold, 3% rhodium, 1% iridium and 0,8% osmium. Overall recovery efficiency should be about 80%, which suggests an annual output of about 280 000 oz of platinum, 117 000 oz of palladium, 37 000 oz of ruthenium and 15 000 oz of gold. That would make Northam the country's third largest PGM producer after Rusplats (about 1,3m oz of platinum annually) and Impala (about 1m oz of platinum annually), Wesplats, the only producer in SA to publish production figures, produced 146 000 oz of platinum in its year to end-September, but is

## GfSA's Northam platinum

-  Gold fields
-  Rustenburg platinum
-  Impala platinum
-  Western platinum

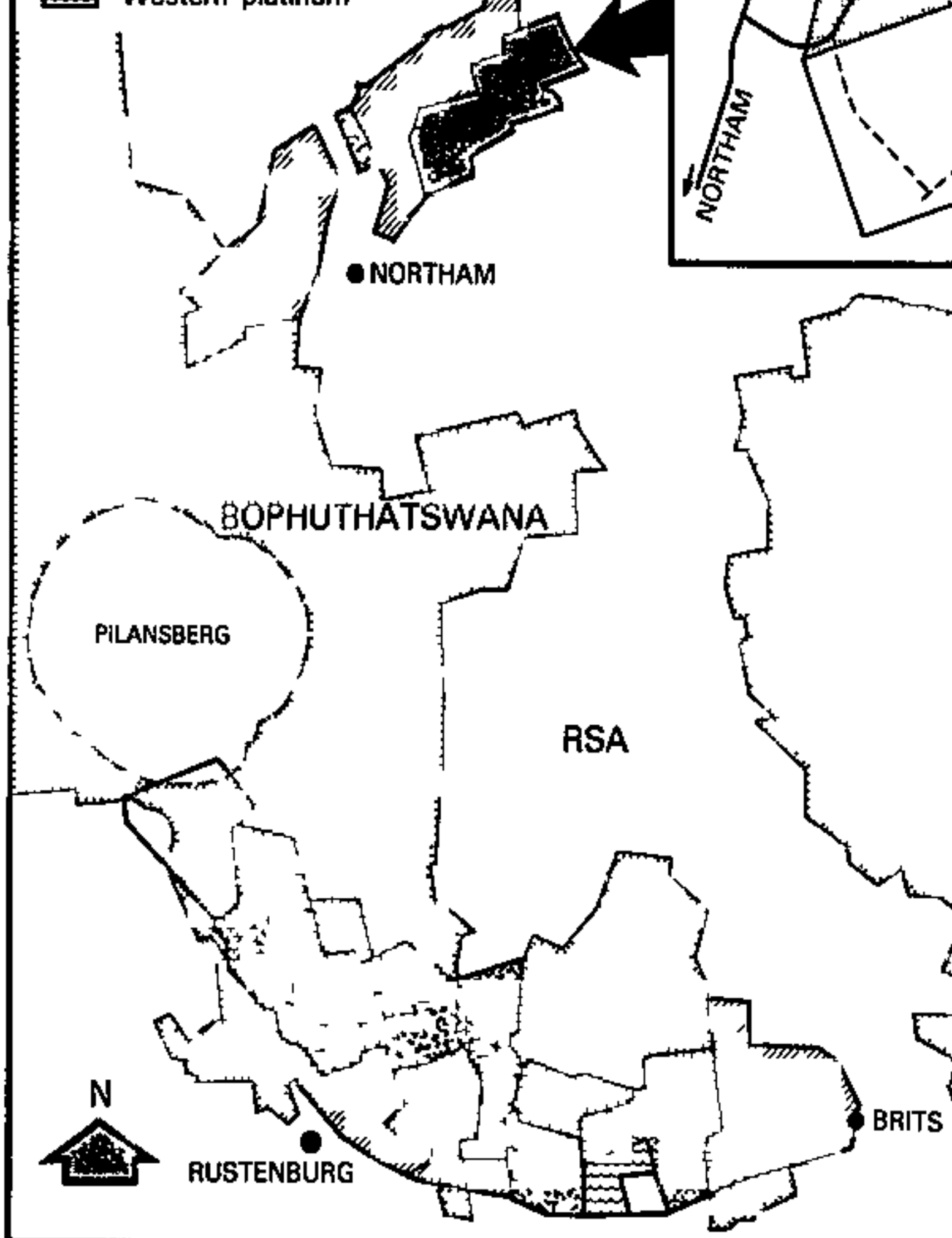

expanding to about 165 000 oz of platinum for 1986.

Relatively rich grades are important to Northam, as working costs will not be low. Mining operations are planned from 1 100 m down to 2 700 m, deeper than Rusplats or Implats. The rate at which virgin rock heats up on the Bushveld Igneous Complex (BIC), where the platinum mines are situated, is double the rate on Witwatersrand series gold mines. That temperature, at 2 000 m at Northam, will be 65 degrees Celsius, a level reached at 4 000 m on a gold mine.

Northam will use the scatter-mining method on shallower levels and longwall mining at deeper levels. All recent technological breakthroughs in deep-level mining will be used to boost productivity and offset the effect on working costs of high temperature gradients. Backfilling will be used extensively to provide better support than conventional methods and reduce heat flowing in from old workings. Chilled water from surface refrigeration plants will be used to cool stopes, while there will be smaller underground refrigeration plants and in-stope cooling units.

Hydro-power will be used underground. This involves harnessing energy in the head of pressure built up by the chilled water dropping down through pipes in the shafts to drive drilling machines, winches and other equipment. Mining will be mechanised as far as possible, using rubber-tyred load haul dumpers and drilling rigs, in a modified version of methods used at the Cooke section of JCI's Randfontein.

Reaction from JSE analysts has been

mixed. Some see the development as a winner, but Mathison & Hollidge analyst Nic Dinham is more cautious, pointing to the risky nature of Northam's marketing arrangements. Plumbridge said Northam had not arranged contracts for the future sale of PGM's and indicated sales would be largely on spot at free market prices. Platinum requirements by European motor manufacturers will be into full swing as Northam starts production.

Northam will be a tightly-held share when listed. Plumbridge indicated that GfSA, which holds 78% of Northam, and Consolidated Gold Fields, with about 12%, will finance their costs from internal funds, there will be no related rights issue to GfSA and Cons Gold shareholders. The remaining 10% is held by a syndicate led by gold analyst and geologist Fred Collender. Collender, a partner at London stockbroker Strauss Turnbull, initially offered the Northam mineral rights to GfSA. A small private placing is expected to achieve the spread of shareholders required for stock exchange listings.

### Emission control legislation

The introduction of emission control legislation in Europe is a complex issue, with various members of the European Community disagreeing over what should be done in terms of last June's overall EC Directive. Forecasts are complicated by loopholes concerning engine size and the introduction of new models. Britain and France are pushing an alternative technology, the lean-burn engine, which could minimise use of PGM-based autocatalysts in vehicles.

Johnson Matthey's (JM) 1986 platinum report estimates that annual demand for all PGM from autocatalyst by 1994 will be about 375 000 oz higher than at present. The increase will come from European car manufacturers and manufacturers currently using catalytic converters, mainly in the US and Japan.

Dinham is more cautious. He believes the JM figure is on the high side and estimates new demand from European car manufacturers at 50 000 oz of platinum annually by 1989, maybe reaching 100 000 oz in 1992. He believes that much of the new business for converters will be sourced through metal trading firms which have arrangements with existing platinum producers, JM, for example, is tied into Rustenburg. If this line of argument is correct, it could pose problems for Northam.

Plumbridge

Bynd in Ryan

217

BUS DAY 23/6/82

THE VITAL VIEW

# Matthey-Rustenburg sues Bowring-Barclays for R4m over theft

PLATINUM refinery Matthey-Rusten- burg is suing its insurance brokers, Bowring-Barclays, for a loss of R4m after the theft of platinum from the Waverille refinery in 1982.

The legal action stems from allegedly unsatisfactory payment of an insurance claim for the loss of the platinum, estimated to be worth about R17m and

mined at the Rustenburg Platinum Mines (RPM).

Summons has been issued and Bowring-Barclays has given notice of its intention to contest the matter. Both parties have confirmed the legal action but have refused to comment further.

The R4m loss is claimed to have been the result of inadequate insurance cover.

LESLEY LAMBERT

According to the summons, Johannesburg Consolidated Investment (JCI) instructed its brokers, Bowring-Barclays, to increase the limit of fidelity guarantee insurance cover — insurance against theft by employees — for its subsidiaries, including Matthey-Rustenburg, before

the platinum was stolen

However, the brokers allegedly failed to inform the plaintiff that its underwriter, Protea Insurance, refused to increase the overall limit from R3m to R9m during the period that the thefts occurred. The plaintiff mistakenly believed that the brokers had arranged the extra cover.

The plaintiff, allegedly paid out R5m,

is suing the brokers for R4m which it claims it lost because it thought it was covered for R9m. Losses suffered as a result of the thefts were estimated to be about R13m when controlling company JCI reported the huge discrepancy revealed by the results of the March 1982 stock-take.

However, more recent estimates have put the losses at about R17m



26/5/86 (217) BUD DAY

# Ergo battles against rising costs

EAST Rand Gold & Uranium (Ergo), which hit record profits in the past year, faces ever-increasing costs and decreasing grades

Chairman Peter Gush says in the annual report these factors will have a negative impact on profit margins this year. But additional production from the carbon-in-leach (CIL) plants at both Ergo and Daggafontein will assist in increasing revenue and minimising increases in unit costs

A slightly higher tonnage throughput of slimes and sand is planned. However, lower grades are forecast and gold production

LIZ ROUSE

should be at a similar level to last year's.

Capital expenditure will remain high at R65,4m (R72,7m in the year to March). About R52m is earmarked for the Daggafontein division project, while the Ergo division is likely to spend R11,5m.

Consideration is being given to increasing the Simmergo division's plant capacity by 20 000 tons a month. R1,6m has been set aside for this. The addition would enable a throughput of about 200 000 tons a month to be achieved.

Gush says all targets on the

Daggafontein project — a 1-million tons a month plant — have been achieved to date. The current programme is to commission the first 500 000 tons a month stream in early 1987, followed shortly by the second stream.

However, the rate of expenditure will be reviewed from time to time in the light of the gold price and company earnings.

Ergo achieved record taxed profits of R94,6m in the year to March, compared with the previous year's R74,2m. The profit surge was attributed mainly to the 32% higher average gold price received of R24 074/kg a 20% increase in gold production at 8 310kg.

Turnover was at peak of R236,2m, but cost of sales increased by R53,8m to R139,2m. Tax remained light at R5,2m because of high capital expenditure. The dividend total was lifted by 20c to 85c.

Gold production from Ergo division increased by 22% to 6 616kg as the newly commissioned CIL plant was in full production, thereby increasing overall gold recovery to 55,4% from 45,6%.

The plant operated at a cost of R22m.

## UK Charter group gets a big lift

CHARTER CONSOLIDATED, the UK-based group engaged in manufacturing, construction, mining, finance and investment, has lifted earnings a share by 88% to 18,8p (10p) in the year to March.

An increased final dividend of 7,75p is recommended by the directors to make a total of 11,5p for the year.

Pre-tax profits jumped 74% to

Investment Staff

£28,7m (£16,5m) and with the effective tax rate falling, taxed profits more than doubled to £19,8m from last year's £9m.

The directors say the improved profits reflect continued progress in reshaping the group, reducing the level of borrowings and seeking higher returns on capital.



Press highlights SA minerals

Bus DAY  
217

# SA sanctions may be costly for US defence

26/6/86

MAJOR new US sanctions proposals, aimed at severing trade links with SA, could prove costly for Washington's defence build-up.

A sustained cut-off of strategic metals from SA might jeopardise national security and force the US to rely on the Soviet Union for supplies, said Robert Greenberger in a recent *Wall Street Journal* report.

A batch of recent US news articles was made available to the SA media at the Bureau of Information's security briefing in Pretoria early this week by the US Information Service.

Greenberger's article highlighted Washington's reliance on SA-sourced minerals and metals used in military applications.

"Without exports from Pretoria, the US would have to turn to Moscow, which, after SA, has the largest reserves of platinum and manganese and the world's third-biggest chromium supply," he wrote.

Washington's mineral procurement bill from SA last year was \$1.3bn.

The US Commerce Department's Office of Strategic Resources maintained that the free market access to SA's minerals was "vital for continuing US defence build up . . . in the event of a

Business Day Reporter

national security emergency".

"I'd be fairly sure the Soviets would step in and sell us the minerals in the event of an SA cut off," said Charles Bennet, chairman of the US House Armed Services sub-committee on sea-power and strategic and critical metals.

"But that puts us in the hands of potential enemy as far as immediately acquiring things. And they'd cut us off when they wanted to."

President Ronald Reagan, however, has said the US could still source strategic minerals and metals from SA as a matter of national security.

Some political observers feel this could turn the congressional sanctions bill awaiting Reagan's approval into a dead letter.

Congressional critics say stockpiles have already fallen below the three-year supply target — government's inventory for chemical-grade chromium stands at 242 000 tons against the strategic reserves official goal of 675 000 tons.

Without SA shipments to the US, the stockpile was sufficient to tide the country over a conventional war that might last several years, concluded a congressional aide.



# Profit shine

217 FIN MAIL 27/6/86

Palamin remains one of the world's more efficient copper producers and has achieved large savings by cost cutting measures. The share is seen as a sound rand hedge stock.

Take a high-risk commodity like copper and what do you get? Palabora Mining (Palamin), one of SA's most successful mining ventures. International copper prices are under pressure, owing to global over-capacity, but Palabora has carved out an assured market for its supply of high-grade copper. Its success stems from tight cost control and solid technology, which enables Palamin to turn low-grade copper ore deposits into some of the highest quality cathode on the world market. With the rand sharply weaker in the last financial year to end-December, earn-

savings. The trolley assist haulage is probably the most impressive measure. Trucks hauling ore/waste out of the pit are connected to overhead lines, which feed electricity directly to the motors. This allows the diesel engine to tick over and dramatically cuts fuel demand. Palamin MD Al Leroy says the net energy saving in 1985 was R14,2m, or R30,5m since 1983.

Other cost measures include last year's phasing-in of a computer despatch system to improve fleet usage, manufacturing truck main frames locally, improved truck maintenance, and the use of cost-efficient emulsion explosives for primary blasting. The possible switching of primary crushing from surface to the pit is under consideration, which would slash the size of the truck fleet.

One problem is that Palabora has no control over its largest cost inputs, and is a victim of such factors as high inflation and the exchange rate. Leroy notes that the average cost of cathode produced in 1985 rose by 27% to R2 012/t. Energy prices (electrical power and diesel fuel) are the largest cost contributor, as the mine relies almost entirely on Escom for power. For its part, the falling exchange rate pushes up the cost of spares. The matter is of

concern, as cost control is vital to any future decision to expand the mine underground.

Vermiculite is Palamin's main by-product. It occurs in thin, flat flakes, and is recovered by feeding the crushed ore through an air stream which winnows off the flakes. When heated, vermiculite expands into a product of excellent thermal and sound insulating properties. Palamin accounts for some 33% of the Free World's production. Demand is strong, particularly for finer ranges, and an enlarged plant will be commissioned in the second half of 1986.

However, back to copper. The crushed ore undergoes a process of flotation, and copper

is extracted by chemical reagents. The residue or tailings contain magnetite, which is removed on revolving magnet drums. Further treatment extracts uranium and zirconium, and the high phosphate tailings are then pumped to nearby Foskor. At the smelter, the copper concentrate is melted in a rever-

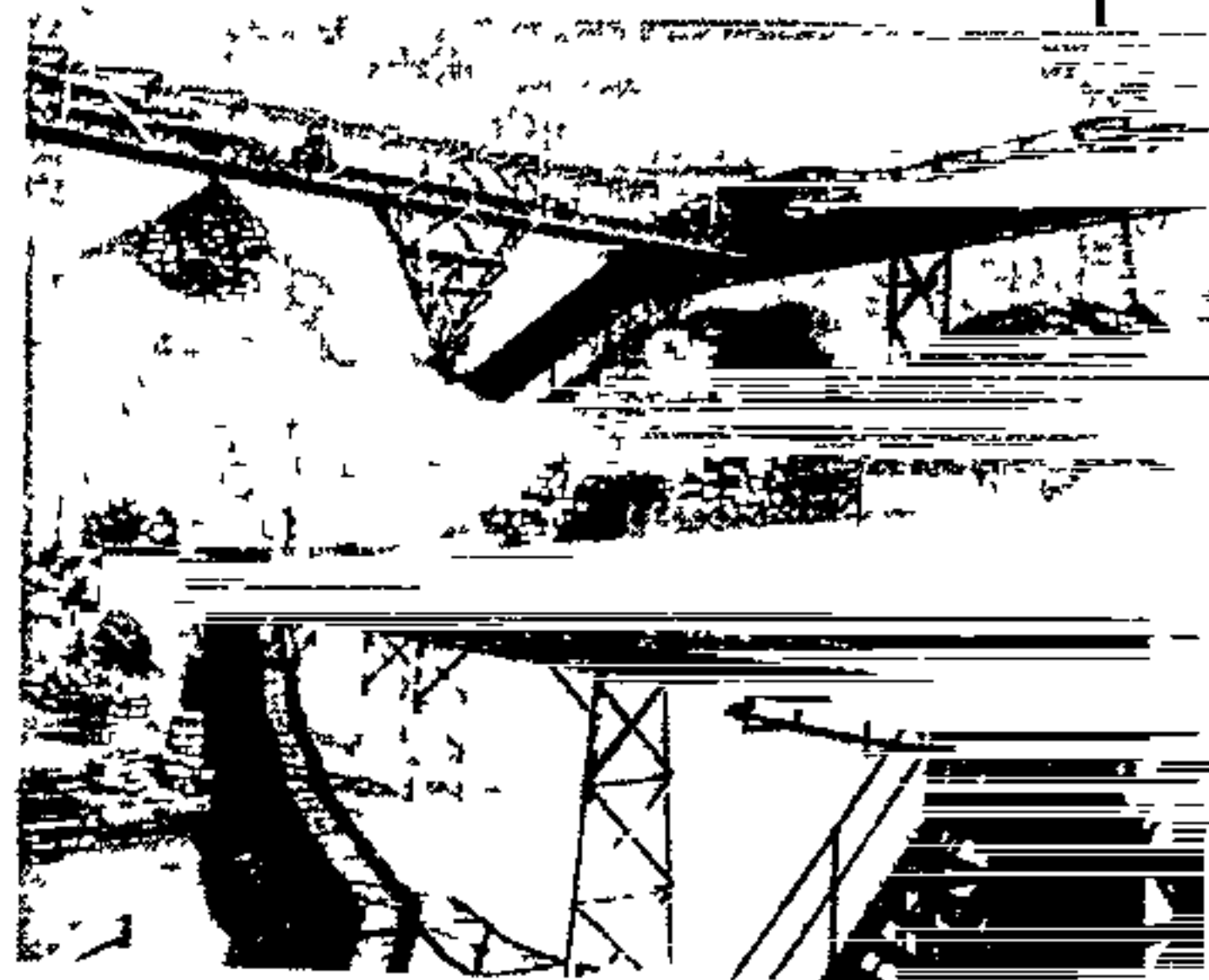

Ready for mineral extraction

batory furnace, and separates into two distinct layers: copper matte and slag. The copper matte is blown with air through three converter furnaces, in a process which oxidises the iron and sulphur.

Molten copper is then cast into an anode of 99,5% purity. By intensive electrolytic refining, copper ions are then transferred from the anode onto a cathode of 99,997% purity. The smelter process also yields sulphur dioxide, which is converted into sulphuric acid for sale to Sentrachem's Fedmisa. A R35m sulphuric acid plant is due for completion this year to increase the capture of the smelter's sulphur emissions. Anode slimes from the refining stage are treated abroad to extract precious metals such as gold, silver and PGM. Leaving costs aside, present business conditions are favourable. Borrowings slid in 1985, and the debt equity ratio fell from 0,44 to 0,31. This has allowed for a more liberal dividend policy, and earnings this year may be held. Palamin sells its copper at the London Metal Exchange (LME) sterling prices. LME copper prices in the first five months of 1986 have dropped some 12% compared with the 1985 average, and could fall further. But the rand is weaker, production should increase in 1986, and costs are budgeted not to rise by more than 7%.

This year's dividend should be maintained, placing the share at R22 on a favourable 8,2% dividend yield and a p.e ratio of 7,4. The income yield is attractive, but an investment in rand hedge stocks involves taking a view on the volatile exchange rate. If you believe the rand is headed inexorably lower, Palamin must have investment appeal. If the rand firms, the share could still offer short-term gains. Whatever the case, Palamin has plenty of go left.

Christopher Marchand

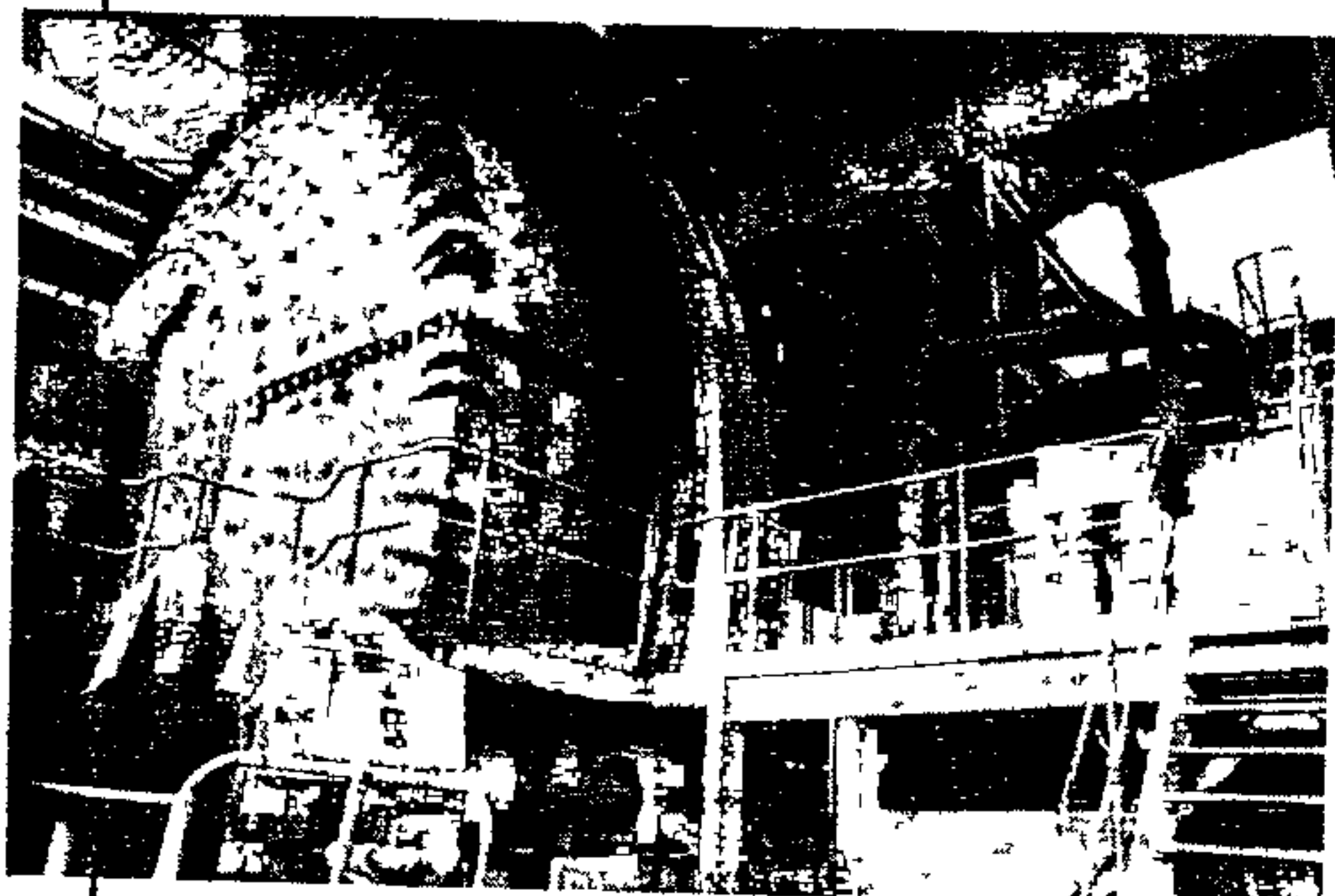

Autogenous milling circuits

ings rose by 51%, and the dividend by 64%.

How did it begin? The Palabora mine was made possible by a geological process which began 2 000m years ago. A series of massive volcanic upheavals tore the earth's crust, forcing millions of tons of magma up from great depths. On cooling, a "treasure house" of minerals was left, now known as the Palabora Igneous Complex. Copper apart, phosphates, vermiculite, magnetite, uranium oxide, zirconium, nickel, gold, silver and platinum group metals (PGM) are extracted. Vermiculite is mined separately. By-products contribute 20% of Palamin's sales revenue.

Since 1966, the complex has been mined by Palamin, controlled by both Rio Tinto and Newmont Mining. Foskor has the rights to the phosphates, which Palamin mines in the same open cast pit as the copper. At a mining rate of 100 Mt/year, Palamin is the second largest open cast operation in the world. The pit is centred on a vertical ore body 1,9 km by 1,54 km in size. Rock is loaded onto haulage trucks and driven to the surface for crushing and milling, which is done in conventional and autogenous circuits.

At this point, we see the operation of cost

The open cast mine





# EC threat to uranium exports not a problem

The Star Bureau

LONDON — The possibility of a European Community ban on imports of South African uranium in a package of economic sanctions is not likely to cause President Botha to lose much sleep, it is said in London

Stefan Wagstyl of the *Financial Times* points out today that uranium accounts for only a small proportion of the Republic's total exports of \$16 billion

last year

Moreover, he says, any ban would take years to bite, since it would most probably affect only new contracts in an industry in which producers and their consumers (electricity concerns) are locked together in long-term agreements, running for five or 10 years

South African production has in any case been falling in recent years in response to a steep decline in prices in the 1980s

27/6/86  
STAR  
from a peak of more than \$40 a pound for uranium oxide in the spot market to a low last year of \$14,25. It is now trading at \$17,25 a pound

However, the reduction in prices and output has hardly been catastrophic because South Africa's uranium is a by-product of gold mining, argues Wagstyl

"It follows then that these companies could easily cope with the complete loss of their

217  
export markets, although one or two marginal mines would find their profits uncomfortably squeezed"

Rossing, the Rio Tinto mine in Namibia, would be hit much harder, assuming the sanctions also applied to that territory

However, given time, the producers could almost certainly find alternative markets for the uranium now sold in Europe. One possibility would be to sell more to Japan

**Mixed bag for minerals**

*FIN MAIL*  
*27/6/86*  
*(210)*  
*(210)*  
*(217)*

Whatever the overall effects of sanctions on SA's economy, earnings from export of precious metals are likely to be boosted, at least in the short term. That, at any rate, is the positive view of Aiden Edwards, president of the Council for Minerals Technology (Mintek), a government-private sector body investigating beneficiation.

He tells the *FM* that the platinum price could double, and the gold price increase by between 10% and 50%, depending on the strength of the international sanctions packages.

"Subject to world perceptions of the seriousness of the South African situation, foreign exchange earnings from these two important commodity exports would appreciate considerably," says Edwards.

SA is responsible for about 90% of annual world platinum production and supplies some 50%-60% of the West's gold. Sales of gold accounted for 45% of the country's total exports of R33 billion in 1985. Given international demand and the many devious trade routes, particularly for gold, it would be virtually impossible to embargo exports of the two metals.

But, adds Edwards, there is a danger that users of platinum as a chemical catalyst in the motor, petroleum, nitric acid and other chemical industries would look for cheaper alternatives if prices shoot through the roof.

Conversely, investment in platinum as a precious metal — Japanese jewellery purchases make up roughly a quarter of all sales — could increase.

"What we are looking at here is a short-term boom and thereafter, possible serious damage to the industry," says Edwards.

He points to the sudden jump in the gold price in the days preceding June 16 to illustrate the effect political uncertainties can have on the price of SA's single most important foreign exchange earner. Sanctions would increase this uncertainty, placing a solid platform beneath the international gold price.

"Gold is also an excellent instrument for international barter deals. It would be a



Mintek's Edwards ... fine for gold

as they are mostly easily identifiable bulk exports. Alternative producers would be quick to fill any gap left by SA's absence from international markets.

SA has about 75% of proven world chromium reserves and produces some 50% of the world's ferrochrome, which is essential for stainless steel manufacture.

A short-term price boom could be followed by degeneration of this important industry, in spite of the fact that SA is the world's cheapest producer.

"Zimbabwe, India, Brazil, Sweden, the Philippines and Turkey are all ready to step into the breach, and it could take the industry between 10 and 20 years to recover from imposition of sanctions," Edwards notes. But chrome, although an important export, provided only 4% of SA's foreign exchange earnings last year and a collapse would not be catastrophic for the economy, he adds.

Another option for SA is to increase

local production of stainless steel. "Although most stainless steel producers jealously protect their own industries, the alternative does exist," says Edwards.

SA has the world's greatest reserves of vanadium, used in production of speciality steels and in the chemical industry. The 1985 earnings of R300m made up about 1% of total export receipts, but producers could be forced to ride the same rough road as chrome producers.

Alternative producers in Brazil, China and Russia are already waiting in the wings. But again, beneficiation, already

successfully done by Highveld Steel and Vanadium, could provide some relief.

"The immediate effect of sanctions would therefore be an increase in foreign exchange earnings as world prices shoot up," Edwards sums up. "But this would be followed by the gradual deterioration of several industries as substitutes are developed or other producers take over SA's markets."

The sobering thought must be where does this leave the workforce?

**MAKING NEW MARKETS**

If sanctions force South African platinum out of world markets for catalysis, new hi-tech development, particularly in the use of platinum fuel cell electricity production, could yet save the industry.

Although fuel cell development is still at an embryonic stage, its international application in an increasingly pollution-conscious world would provide a massive boost for the platinum industry, claims Mintek president Aiden Edwards.

"The use of the fuel cell would completely eradicate air pollution from electricity generation. This would prevent acid rain and the so-called greenhouse effect and protect the environment," he says.

Current fuel cell electricity generation costs are roughly double those of thermal power generation, but economies of scale

would bring down the cost dramatically. "New Mintek technology for exploiting the UG-2 reef in the next decade would ensure that extraction from SA's massive reserves could be doubled to meet increased demand from the rest of the world," says Edwards.

He says, however, that SA, the world's premier producer, should become more active in fuel cell research. A major research and development project for the advancement of a fuel cell pilot plant would cost some R40m.

"Historically, we have given too little attention to the beneficiation of our minerals," he adds. "A modest application of fuel cell power generation worldwide could double the market for platinum and earn us an extra R2 billion a year. What a return on a R40m investment."

major trade weapon in SA's arsenal," says Edwards.

Diamonds provided some 3% of the country's foreign exchange earnings in 1985, and it is difficult to project the effect of sanctions while De Beers' Central Selling Organisation virtually controls the international market.

Producers of other strategic minerals — chromium, manganese, vanadium and titanium — would probably not be as fortunate,



# Rossing mine contributed 17% of Namibia's GDP last year

S.A.P.R. (217)  
28/6/86

The Star's Africa  
News Service

Namibia's massive and controversial Rossing uranium mine last year accounted for 17 percent of the total Gross Domestic Product of the territory

During the period 1981 to 1985, the mine contributed 34 percent by value of all the exports from Namibia, according to its chairman, Dr Zedekia Ngavirue

Addressing more than 2 000 company workers at the mine yesterday, Dr Ngavirue said the company was proud of its major contribution to the economy of Namibia and it would continue to create the wealth the country needs to improve its social conditions

The gathering at the mine — which is situated east of the coastal town of Swakopmund — was held to commemorate the tenth anniversary of the production of the first batch of uranium oxide.

During that time, Rossing has churned out more than 40 000 tons of the product, which is exported overseas for enrichment into uranium fuel for nuclear power stations

Over the past decade, Rossing — which is majority-owned by the Rio Tinto Zinc group — has been the target of much adverse criticism for alleged discriminatory labour practices and the fact that it is min-

ing in Namibia in defiance of the United Nations

● Under the South African Atomic Energy Act it is illegal to publish details about the mine's grade of ore, the names of its customers, the price the product is sold for, the total ore reserve or the method or transport used for exports.

## Gold lower

Financial Staff

Gold shares closed slightly lower from yesterday's closing levels, but little changed from the opening after dull day's trading, dealers said.

Month-end and quarter-end factors, together with a continued lack of incentives, heavily dampened activity

Heavyweight Vaal Reefs ended R3 down at R225 and Loraine 25c lower at R12,50, but Bracken firmed 10c at 570c against the trend. At the close 24 gold shares were easier, only eight firmer and 14 unchanged, while the Krugerrand lost R7 at R960.

In mining financials, Anglos eased 25c at R47,50 in sympathy but Gencor held firm at R50, while diamonds and platinum had De Beers down 30c at R27,40 and Implats down 25c at R35,25.

3/7/80 BU...  
Cornish tin miners think things over

# Row erupts over SA offer

LONDON — A row erupted yesterday after more than 100 redundant Cornish tin miners were offered jobs in SA

The miners were among more than 300 sacked last month after the Geevor Mine at Pendeen, near Land's End, was refused government cash aid

SA mining group Gencor has offered jobs to 110 former Geevor employees but Mick McArdle, Transport and General Workers Union shop steward at Geevor, said "I could not go out there and know people I worked with were

Own Correspondent

being treated in such an inhuman manner

"I dare say some Geevor men will take it up, but this is another example of people in the deprived regions having to make choices which they do not always like to make."

Earlier this year, Gencor sold its 18% stake in Geevor for about R1m and the job offer to miners, engineers, fitters, electricians and technicians was made

through Geevor's deputy chairman Ken Gilbert, who advised the men to consider the opportunity.

Gencor PRO Harry Hill said the company was constantly looking out for people with specialised skills and management potential

Enquiries had been made to Gencor management about whether anyone would be interested in accepting a job in SA, but no contact had been made with the workers nor had any offers been made to them



# Platinum shares get a boost

Financial Staff

Platinum shares moved strongly firmer on the JSE yesterday, albeit on small volumes, on UK rumours that Britain was no longer selling strategic minerals from stockpiles.

If this is the case, demand will begin to outstrip supply, forcing the metal's price even higher on world markets as the gap will no longer be made up from accumulated stockpiles.

The metal is currently trading on the New York Metal Exchange at about \$439

10/7/86  
STAR  
217  
an ounce while in rand terms, it will vastly increase revenues for the mines

Platinum is volatile in times of unrest and threatened strikes, as around June 16 when it surged to \$450.

Despite the favourable conditions in the platinum market, brokers report that nervous foreign investors have sold out of the market in the last year, reducing their holdings in the South African mines from 20,3 to 19,9 percent of the shares in issue, mostly in the last six months

MINERAL EXPORTS

# Adding to the appeal

The sanctions threat to mineral exports has, it seems, achieved something years of warnings and encouragement could not. It has at last spurred the industry to take a long, hard look at mineral beneficiation.

In addition to the massive boost added value would give export earnings, there is the belief that the production of more highly refined and specialist products would make SA's exports much more attractive in world markets. Beneficiation also reduces bulk, an important aid to sanctions evasion.

At the same time, there is growing realisation that it might be desirable to move away from traditional links with the West towards an "eastern option".

Quick to take advantage of the new appreciation of the dangers of relying on traditional products and markets, the Council for Mineral Technology (Mintek) recently led a high-powered delegation of public and private sector mining men to the Republic of China (ROC) to drum up support for added value ventures.

Four major areas for joint SA-ROC investment in mineral beneficiation have been identified: chromium chemicals, vanadium pentoxide, titanium pentoxide and jewellery. Negotiations could lead to the definition of other areas. Some 150 Taiwanese delegates attended the meetings, which were described as "successful," and the prospects seem good.

"The vanadium project is well under way and should take the vanadium slag and pentoxide currently produced to a far more sophisticated form," Mintek president Aiden Edwards tells the *FM*.

SA is the world's major vanadium producer, earning some R200m a year from exports. However, while vanadium is sold as pentoxide at about \$2,60/lb it could realise about \$12/lb as ferrovanadium.

Edwards says that beneficiation of a wide range of minerals could boost foreign exchange earnings by billions of rands, setting off a major growth cycle that would end dependence on gold (see Mintek Survey).

"SA and Bophuthatswana possess 73,9% of world chromite ore reserves and produce 33% of world supplies," says Edwards. "If a major steel producer converted just half the ferrochromium production to stainless steel in sheet form, SA would satisfy 15% of world demand and earn an additional R3 billion-R6 billion a year."

A major chromium pigment, chemicals and metal export operation could satisfy 20% of world demand for pigment and metal and earn a further R330m a year, he adds.

Other minerals have similar potential. SA holds 78,3% of world manganese reserves,

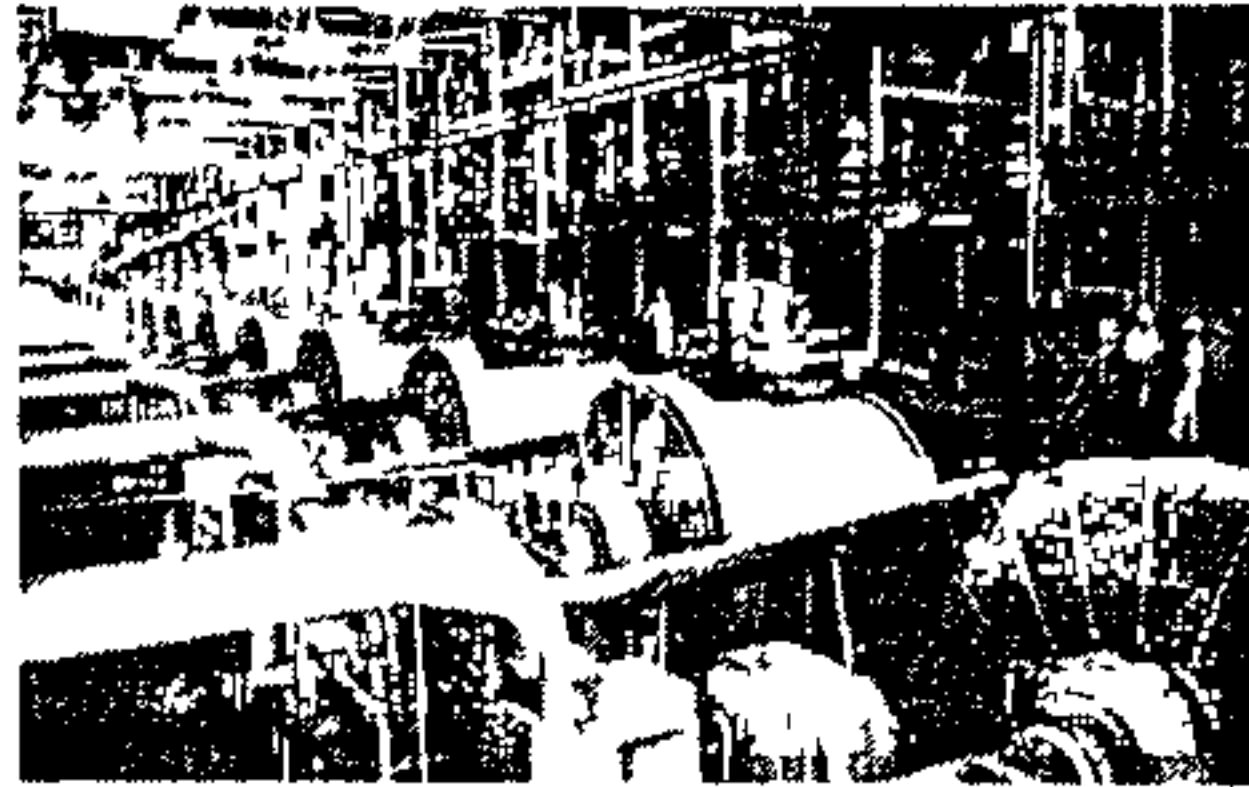

Platinum ... greatest export potential

but satisfies only 13,4% of its needs. The promotion of new applications of the metal and expanded ferromanganese production could earn an extra R200m per annum. Another R80m could come from manganese chemicals if SA provided just 15% of world needs, according to recent Mintek studies.

Potential earnings from titanium oxide exports are some R330m a year, while titanium metal and ferrotitanium could increase earnings by a further R200m a year.

Platinum, however, has the greatest potential, says Edwards. With 78,7% of Western world reserves, SA should undertake research into the application and marketing of platinum group metals before other countries are forced to seek substitutes. SA's domination of world platinum should lead to additional earnings of between R1 billion and R2 billion a year, says Edwards.

"And why must we be a net importer of gold jewellery?" he asks. "If we provided only 10% of world demand, we could increase foreign exchange earnings by R4 billion a year. And we've still done hardly any research into industrial uses for gold."

Added value operations could ensure the economic future. However, particularly in the political climate which has blighted the private sector's view of long-term investment risks, the State will have to play a major role, probably through the Industrial Development Corporation (IDC).

"The private sector would never have made investments like Iscor, Sasol, or Alusaf. Today, these are not only strategically important, but also serve to spur further diversification, job creation and increased sophistication of SA's economic base." ■

FIN MAIL GREAT  
MEAT DEREGULATION  
11/3/86  
**More is needed**

This week's move to reduce control over SA's R1,75 billion a year abattoir industry is a step in the right direction. But much more is needed to see the industry come right, be-

lieves the free market-orientated Organisation for Livestock Producers.

"While we welcome the trend towards freer marketing, the industry requires radical steps to really free the market. Modifying control — a process of controlled decontrol — is not opening the market," says executive director Roy van der Westhuizen.

Government has accepted the following recommendations of the committee of enquiry into the abattoir industry:

- Control over slaughter and abattoir tariffs will be lifted from October 1, allowing owners to set their own charges,
  - No State assistance will be granted to public abattoirs operating in uncontrolled areas;
  - The National Marketing Council and the Meat Board will investigate ways of ensuring a freer two-way flow of meat between uncontrolled and controlled areas,
  - Re-inspection fees, now levied at uncontrolled abattoirs, will be abolished from October 1,
  - Privatisation of abattoirs is to be encouraged,
  - Approval for new municipal abattoirs will be granted only in "highly exceptional" cases, and
  - Expansion of abattoirs will only be allowed if existing facilities are fully used.
- Van der Westhuizen says that with some 60% of the industry under its direct control, the Abattoir Corporation (Abakor) has "site monopoly" in the major markets.

"And while we welcome government's commitment to the privatisation of abattoirs, this will have little practical effect unless specific sales proposals are put on the table. Prohibitive building costs for abattoirs mean the private sector will not find it economic to buy these meat palaces, even at cost," he tells the *FM*.

What is needed is "rapid and sensible" privatisation and the free movement of meat, says Van der Westhuizen. Government should actively encourage private sector participation.

He says the recommendation that capacity extension only be permitted if existing capacity is fully used will protect Abakor's surplus capacity in certain controlled areas. It also goes against the principle of allowing free flow of meat between uncontrolled and controlled areas.

"This boils down to further intervention in the market place and is totally unacceptable. Private-sector abattoirs in rural areas will be prevented from competing with these protected abattoirs. That is directly against the principle of free competition," he argues.

He summarises radical steps needed to put



# Interest in platinum as an investment on the increase

## Three countries plan coin issues

16/2/86 • SOME 217

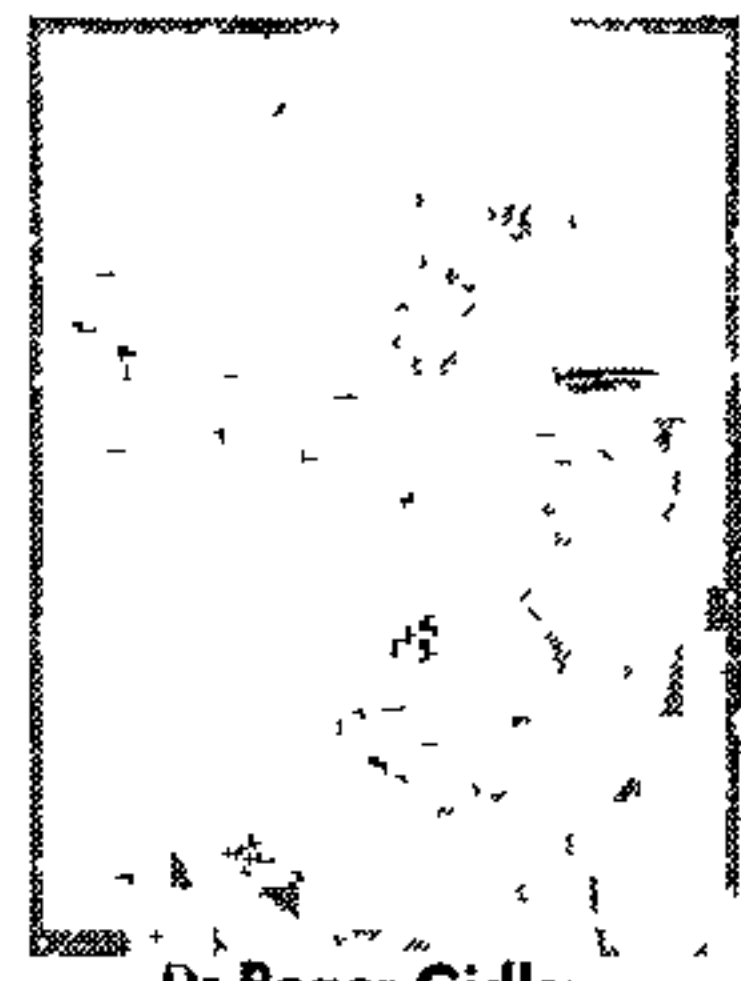

Dr Roger Gidlow

By Dr Roger Gidlow

At least three countries are considering introducing a legal tender platinum coin, according to industry sources, and the ramifications for South Africa, which produces nearly 85 per cent of the world's production would be very significant.

Platinum has surged in recent times on the automobile off-take, and any new demand from a totally different area could boost demand substantially.

It would appear that attitudes towards platinum on the part of some governments are in the process of modification, and industry reports suggest that Canada, Mexico and China are all contemplating the introduction of platinum coins which would presumably have legal tender status.

These changed attitudes would seem to be a by-product of the growing popularity of the metal with investors.

The quantity of platinum sold for investment purposes in the form of small bars and coins rose by 50 per cent last year to 260 000 ounces, according to Johnson Matthey.

While commodity markets in general remain weak, the platinum market remains strong with the price now around \$440 an ounce compared with roughly \$240 an ounce early in 1985.

### Investment demand

One important influence which has contributed to this boom in platinum prices has been the growth in investor demand which has occurred in line with an improvement in industrial demand.

This substantial increase in investment demand in turn could now usher in an important mutation to the platinum market in the form of an expansion in the number of legal tender platinum coins which are available. In this respect the platinum market could complement the gold market where an increasing variety of gold coins

are being marketed.

Only one country, namely the tiny Isle of Man, currently markets a platinum coin which has legal tender status. This is called the Noble. The reluctance of governments to market such a coin has reflected several considerations.

South Africa has been reluctant to monetise such a coin, while hardly any other country produces platinum in such quantities to make a platinum coin seem an obvious vehicle to promote.

It has also been argued that a decision to monetise platinum by any country would set a precedent, and could lead to pressure being exerted on such a government to recognize coins based on other metals.

Even the idea of platinum being used as a coin in general circulation and used, if necessary to pay for goods and services, has not been easily accepted.

### Not suitable

In addition, central banks appear to have been reluctant to hold platinum as part of their reserves. Platinum is not a traditional international reserve asset, and it is not as usable in the international monetary system as gold.

These arguments have never been fully convincing. For instance, like platinum silver does not possess the same status as gold as a reserve asset, but this has not prevented important silver-producing countries such as Mexico and Peru keeping part of their foreign reserves in the form of silver.

Moreover, opposition to platinum coins with legal tender status on the grounds that they are not suitable as a medium of exchange would appear to be a pedantic argument.

In reality legal tender gold coins such as the Kruggerand are not employed for every day transactions, and the same would apply to platinum coins which are classified as legal

tender coins.

This offtake was equivalent to nearly 10 per cent of total supplies last year which amounted to 2.75 million ounces. Investment demand has increased six-fold since 1982, and rose still further during the first half of 1986.

Some analysts are anticipating further gains in the price of platinum, and several countries may well capitalise on the growing popularity of the metal as an investment medium by issuing platinum coins at a premium, and thereby garner foreign exchange income.

### Positive influence

China, Mexico and Canada are already marketing gold coins. Their expertise in this area could be helpful if they launched their own platinum coins, while Canada has the added advantage of being a small producer of the metal.

Any new coins are highly likely to exert a positive influence on the market for platinum. The purchasers of gold coins tend to keep them as a long-term in-

vestment, and the same is probably true of buyers of platinum coins.

The absence of a variety of different national platinum coins in the past has meant that the coin market has not been segmented. This weakness could now be eradicated. Whereas many investors may not be keen to acquire the Isle of Man coin they may well be prepared to buy a coin which is issued in their own country.

The presence of more platinum coins would also mean that the total promotional expenditures directed towards their sale would increase, and this again should kindle greater interest on the part of investors.

Several platinum medallions are available on the market, but they do not have the same status as legal tender coins. While legal tender status does not add to the intrinsic value of platinum coins, it does enhance their credibility, and therefore their appeal.

In some countries, moreover, such coins would be free of sales or value-added taxes — unlike platinum medallions.

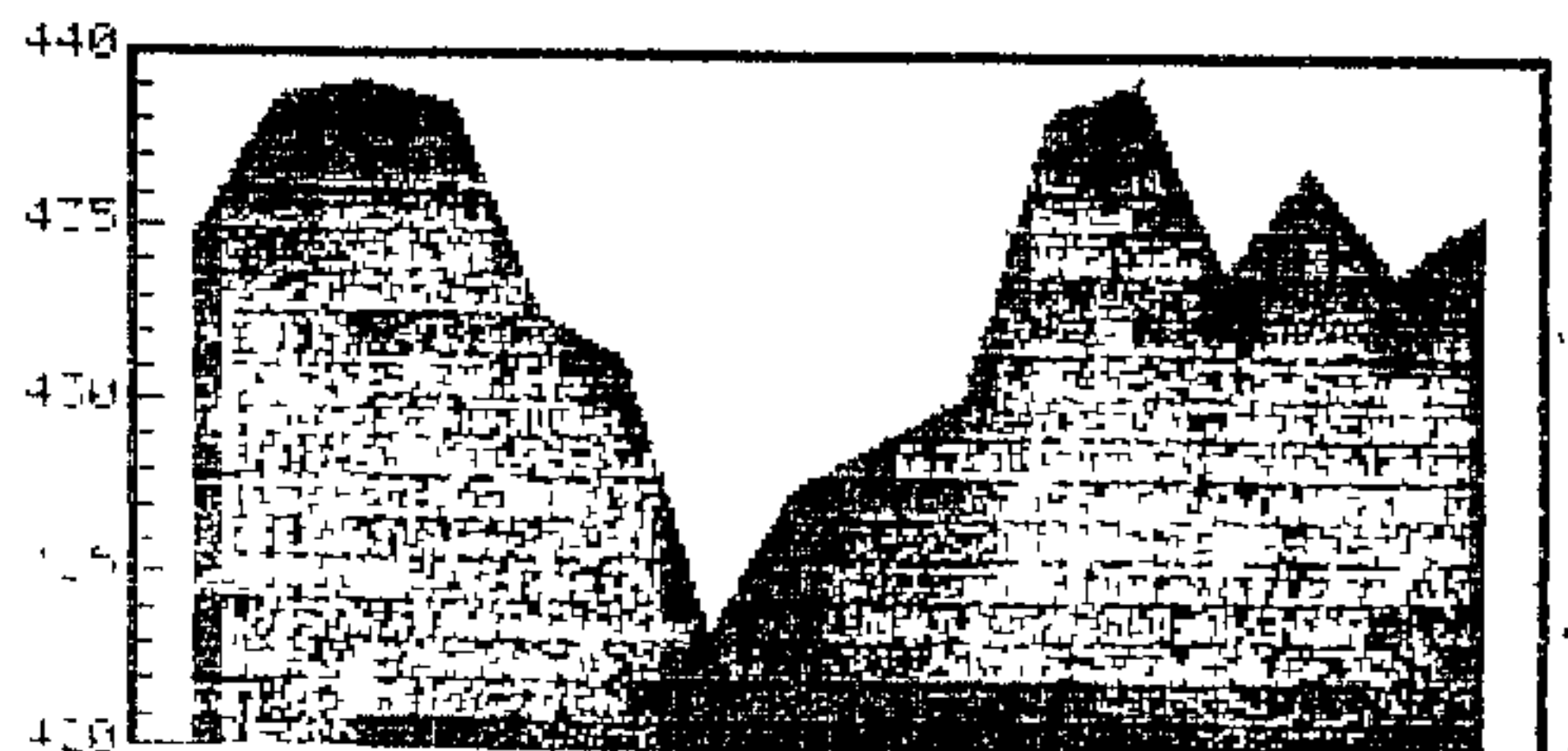

Platinum price in dollars for the past four weeks

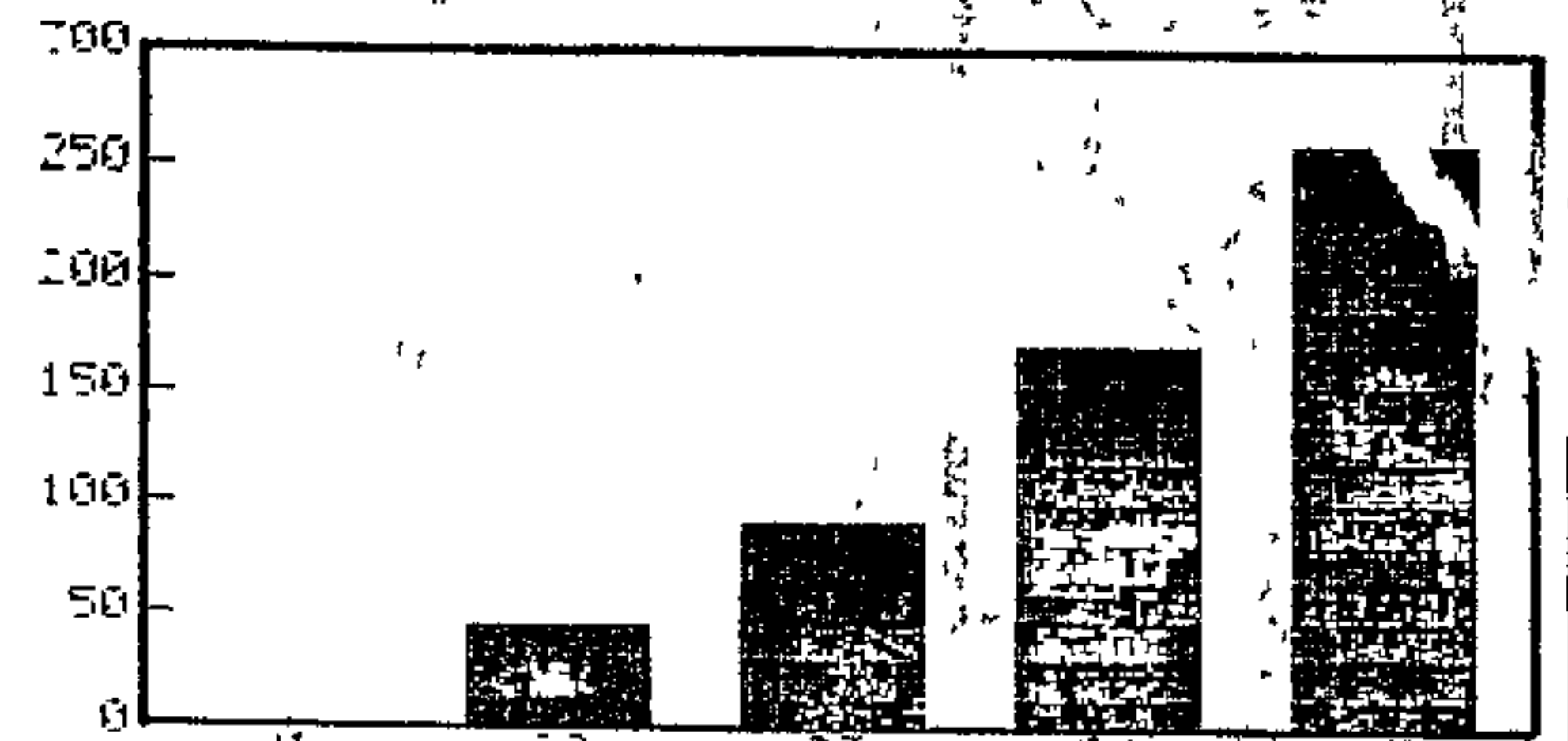

Hoarding demand for platinum in 000's ounces

# Gold and platinum back on centre stage

23/8/80 5 PM  
214  
217

## Financial Staff

Gold and platinum resumed centre stage on international investment markets yesterday with strong finishes to what had otherwise been a lacklustre week's trading.

Gold was fixed yesterday afternoon in London at \$386.25 an ounce, while the free market price of platinum climbed even closer towards the magical \$600 mark with a fix at \$585.50 an ounce.

Both metals had huge surges in price at the start of the week before last, with platinum leading the way and solid Japanese buying of gold underpinning the bullion market.

But the next 10 trading days saw the market threaten to crack on the downside as speculators took profits. But the rally towards the end of this week has dispelled fears the gold, particularly, would not be able to consolidate after its recent rally.

With many of the optimistic analysts now pointing the gold price towards the \$420 an ounce market, and even the more

cynical suggesting a consolidation around \$380 is on the cards, the price looks to have achieved a substantial re-rating.

Sanctions against South Africa form the backbone of both investment and speculative interest in the two precious metals. But an absence of the Soviet Union as a seller of either and the presence of Japan as a substantial buyer of both seem to have assured their immediate future.

Some market analysts now estimate that Japan may end up taking close to 600 tonnes of gold this year - for both gold coin production and jewellery manufacture - which would be almost equivalent to an entire year's production from South Africa.

Already this year confirmed purchases by Japan have passed the 300 tonne mark and, with the price still rising, more buying interest could be on the cards. Some expect resistance from Japan should the price move through \$400, but with enough speculators around a further upward spiral should not be ruled out.

1 1 0 1 • 1 • 1



COMMODITIES

ARGUS 24/7/86

217

# Platinum price expected to soar

## The Argus Foreign Service

LONDON. — Platinum is the only metal with real potential for sharp price rises in the near-to-medium term.

So says the Shearson Lehman Brothers commodity trading group in a generally gloomy mid-year review of the major metals markets.

It says platinum should continue its recent strong performance into 1987 with industrial demand, particularly from European car makers who use the metal in pollution control devices, exceeding supplies for the fourth consecutive year.

In addition, demand from investment and speculative sources has grown with the recent introduction of the "Noble" coin and the political turmoil in South Africa, which is responsible for about threequarters of the world's platinum supply

The review predicts an average platinum price of \$475 an ounce in the second half of this year, rising to \$500 next year, compared with \$403

in the first six months of this year.

The gold price is also expected to move slightly higher but its momentum is expected to be slowed by a weak investment climate for the metal

However, Mr David Williamson, director of metals and mining research at Shearson, says investors might be more attracted to gold when equity markets appear to have ended their bull phase

The review predicts that the gold price will average \$375 in the second half of the year and \$400 in 1987

But the review says there is little hope of a sharp upturn in demand for the five major base metals.

Prices of copper and aluminium are expected to show little change with demand almost stagnant.

There is a slightly brighter outlook for prices of lead and zinc over the next 18 months as well as an improvement in the nickel market from September because of production cuts

# Platinum is sole prospect in gloomy metal market

The Star Bureau

LONDON — Platinum is the only metal with real potential for sharp price rises in the near-to-medium term, says Shearson Lehman Brothers commodity trading group in a generally gloomy mid-year review of the major metals markets.

It says platinum should continue its recent strong performance into 1987, with industrial demand, particularly from European car makers, exceeding supplies for the fourth consecutive year.

In addition, demand from investment and speculative sources has grown with the recent introduction of the "Noble" coin and the political turmoil in South Africa, which is responsible for about three quarters of the world's platinum supply.

The review predicts an average platinum price of \$475 an ounce in the second half of this year, rising to \$500 next year, compared with \$403 in the first six months of this year.

The gold price may also move slightly higher but its momentum is expected to be slowed by a weak investment climate.

However, Mr David Williamson, director of metals and mining research at Shearson, says investors might be more attracted to gold when equity markets appear to have ended their bull phase.

The review predicts that the gold price, currently \$344 an ounce, will average \$375 in the second half of the year and \$400 in 1987, but the review says there is little hope of a sharp upturn in demand for the five major base metals.

Prices of copper and aluminum are expected to show little change. There is a slightly brighter outlook for prices of lead and zinc over the next 18 months as well as an improvement in the nickel market from September because of production cuts.



# Rusplat increases dividend by 50% as earnings surge

25/7/12 SNAK 217

By Gareth Costa  
Rustenburg Platinum produced excellent results with earnings a share surging by 65 percent to 206c for the year to end-June. With the improved earnings came a 50 percent increase in dividend payout to 135c

However, some analysts suggest that total earnings should have been about 250c a share, which could have been achieved had the mine not indulged in hedging operations

They calculate that there would have been a further R60 million in after-tax profit if all the estimated 1,3 million ounces of platinum produced had been sold at spot prices. Although these prices doubled during the year to around R100 an ounce, hedging by Rustenburg meant that it was often locked in at lower levels and not able to take advantage of the rising prices.

Rusplat's management says that the price of other metals within the platinum group were all significantly higher, apart from ruthenium

Mr Brian Gilbertson,

newly appointed head of the platinum division at JCI, said that the results were good due to the weak rand, strong platinum price and contained working costs. He declined to comment on hedging operations.

The cost of sales was 26 percent up at R819 million. This is made up of on-mine costs, which were 26 percent up at R628 million, treatment and refining costs 23 percent up, and other expenses nearly double at R62 million

Profit on metal sales was 93 percent up at R675 million, while profit before provisions was R717 million — after R41 million came from other income.

Commenting on the results, one leading analyst said that the company's conservative approach, combined with a concern over the maintenance of a high positive cash flow and an aversion to debt, was stifling potential earnings

Tax and lease payments of R354 million were 57 percent of profits, and distributable re-

serves were R258 million. R89 million was transferred to reserves, which analysts now believe are in excess of R400 million.

Mr Gilbertson would not confirm the figure, but said that the money was a comfortable cushion in times of trouble since the platinum market could be volatile

Analysts now suggest that the share may be overpriced, after a 262 percent lift in the past 12 months to from R16 to R42 a share

However, given the increased dividend the share now offers an historic yield of 3,2 percent against 2,6 percent on the previous distribution.

**A.D.E.  
PARTS  
LESS 25%  
IMMEDIATE  
DELIVERY  
TEL: AL VENTER  
813-2033, A/R 973-3946**

D065623

# Rusplat lifts its dividend by 50%

BUDAY 217 25/7/86

BRIAN ZLOTNICK

**RUSTENBURG** Platinum's blistering 65% advance in earnings to 206,1c a share in the year to June is at the top end of the scale of analysts' forecasts

Moreover, the final dividend was lifted by a half to 82,5c a share to make a total of 135c, up 50% on the previous year.

The share has moved ahead fast this year with analysts generally having to upgrade their forecasts in the wake of sharply higher platinum free market prices and the weak rand which boosted profits.

Ahead of results, and despite the firmer financial rand, Rusplat gained 50c to close at R42, after touching a low of R40,50, in heavy trade with more than R1m worth of shares changing hands.

At the pre-tax level profits more than doubled to R620,5m (R307,4m) after net sales revenue rose 50% to R1,5bn with the mine operating at close to its upper production limits.

RUSTPLATS SHINES BRIGHTLY

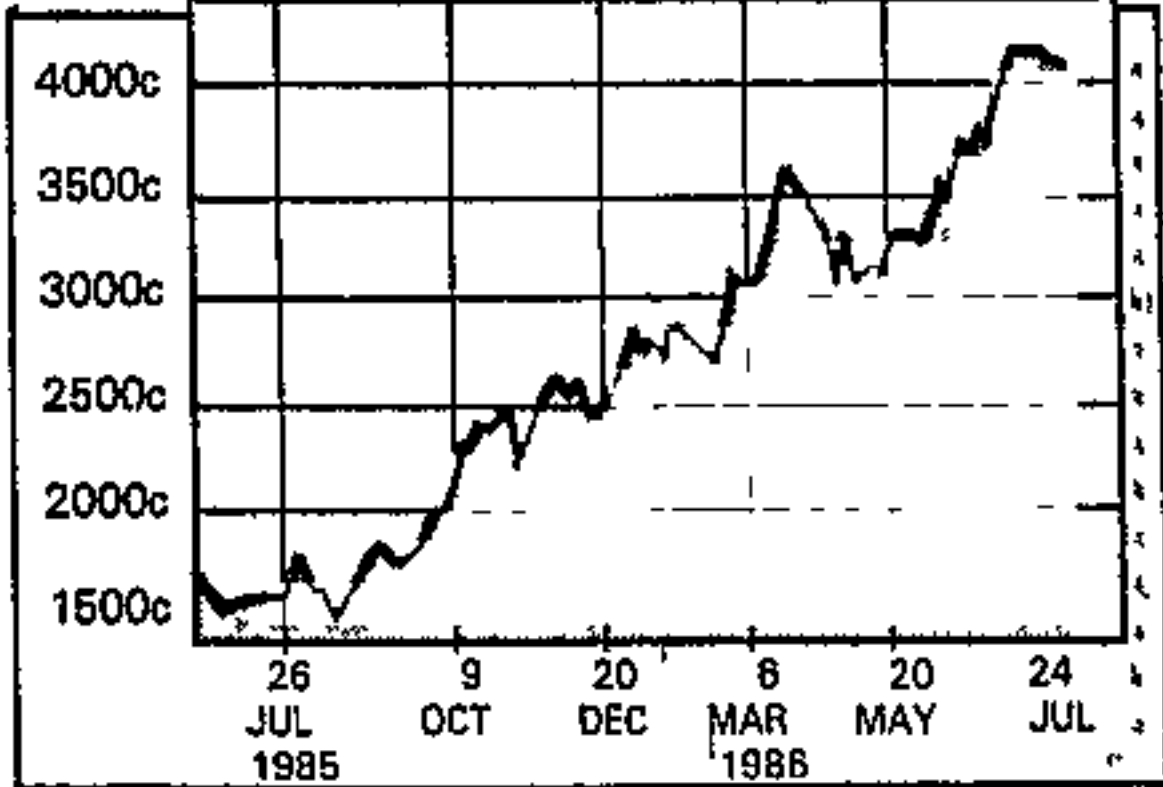

However, the tax and lease bill shot up by almost 150% to R354,6m (R146,5m), with capex only R32,5m up at R136,3m. The advance in earnings was blunted.

Significant tax relief is expected to accrue from the R250m cost of constructing a precious metals refinery in Bophuthatswana.

With the cash pile now probably about R300m, Rusplat should have no problem in financing the refinery and in lifting

● To Page 2 →

## 50% hike for fast-moving Rusplat

this year's dividend by at least a quarter.

To protect itself against cyclical movements in the platinum metals market and any labour disruptions Rusplats, however, needs a solid cash pile.

The dramatic rise in Rusplats share price from R15 a year ago to the current R42, only 50c off its recent all-time high of R42,50, largely reflects the fact that rand prices of most of the platinum group metals (pgms) are currently at record levels.

Furthermore, it reflects the increased world-wide demand for pgms in the wake of sanction fears, the UK's decision to stop selling from its strategic stock-

pile and the fact that Japan is set to boost its stockpile.

Opinion is divided among analysts as to whether Rusplats, now 50c off its all-time high of R42,50 and on a thin dividend yield of 3,2% is fully priced.

With the rand weakening and the dollar platinum price rising progressively over the past year, it is not altogether surprising that the directors expect this year's results to show a further improvement — provided current rand prices are maintained

BUDAY 217 25/7/86 ● From Page 1



25/7/86

COMPANIES

FUN NUM  
SAMANCOR

217

# The best may be past

**Activities:** Manganese and chrome mining and the production of a wide range of ferro alloys. The group also produces a number of silica, dolomite, phosphorous, fertiliser and serpentine products

**Control:** Gencor has control with 50% of the equity

**Chairman:** Steve Ellis, managing director Colin Officer

**Capital structure:** 149,6m ords of 4c each  
Market capitalisation R1,3 billion

**Share market:** Price 855c Yields 11,7% on dividend, 17,7% on earnings, PE ratio, 6,0, cover, 1,5 1985-1986 high, 935c, low, 665c  
Trading volume last quarter, 3,2m shares

**Financial:** Year to February 28

	'83	'84	'85	*'86
<b>Debt</b>				
Short-term (Rm)	55,4	87,8	108,5	59,3
Long-term (Rm)	43,8	46,8	54,1	55,8
Debt equity ratio	0,37	0,43	0,45	0,24
Shareholders interest	0,64	0,6	0,52	0,86
Int & leasing cover	2,6	0,97	7,0	21,8
Debt cover	0,30	0,36	0,83	2,4

**Performance**

	'83	'84	'85	*'86
Return on cap (%)	8,1	2,3	19,8	64,0
Turnover (Rm)	293	350	533	803
Pre-int profit (Rm)	37,1	11,9	136,8	352,0
Pre-int margin (%)	11,5	3,4	25,7	43,7
Taxed profit (Rm)	13,3	(4)	95,5	264
Earnings (c)	4	26	61	152
Dividends (c)	5	5	37	100
Net worth (c)	226	216	243	314

\* 13 months to March 31

The annual report repeats the message thumped out in the preliminary statement for the 13 months to March — last year's exceptional results are not going to be repeated. Warns chairman Steve Ellis "With lower sales tonnages and prices forecast for some major products, and higher costs resulting from the high rate of inflation and the possibility of a higher average rand/dollar exchange rate, a reduction in profits from the exceptionally high level experienced during the 13 months ended March 31 1986 must be expected."

Management underlined that message in the 70c final dividend, which consisted of a

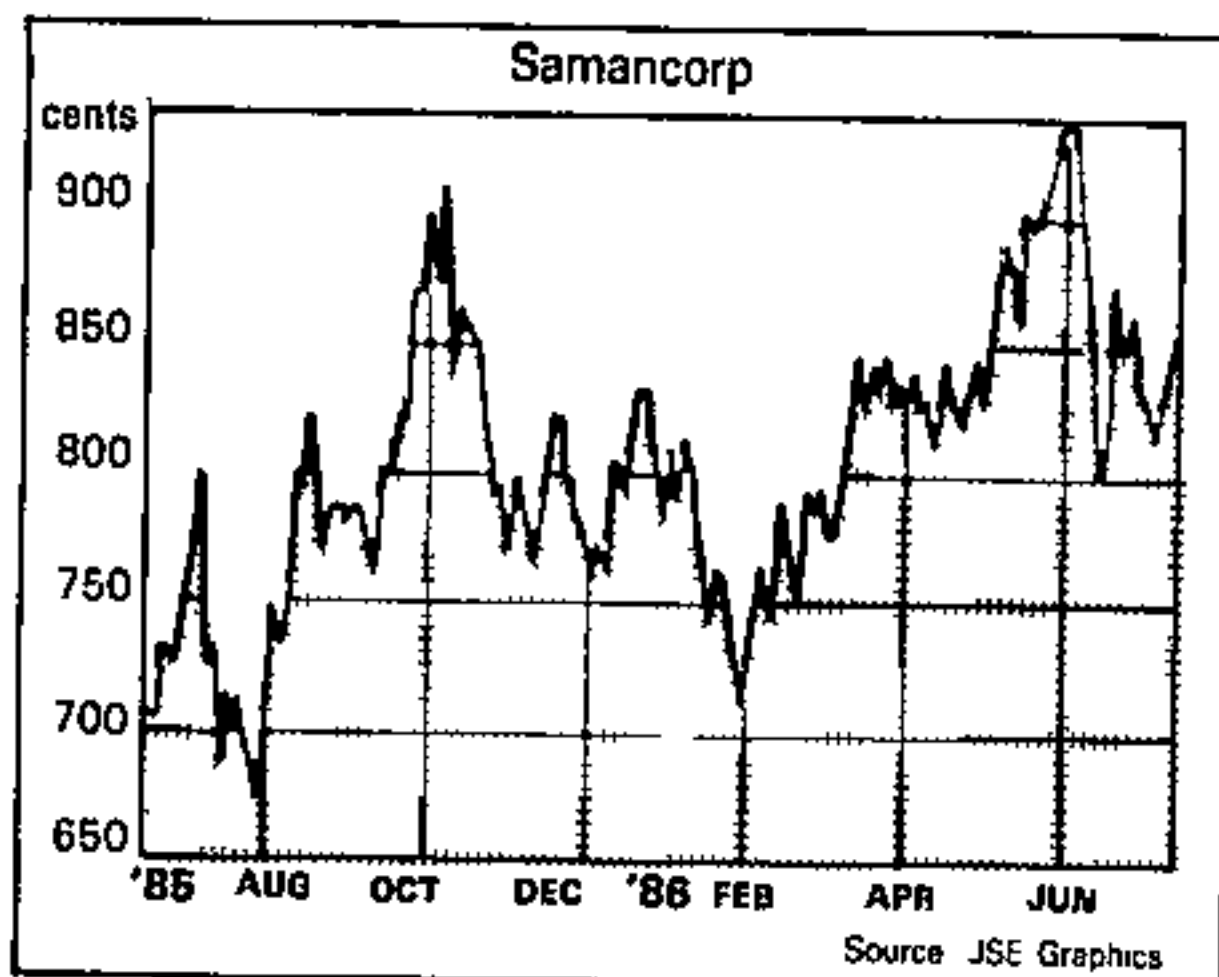

Ellis ... profits must drop

45c normal plus a 25c "extraordinary" dividend

Analysts are divided on just how badly results will be hit. The most optimistic view holds that Samancor could maintain 100c dividends, depending, however, on what happens to the value of the rand.

In April and May, when the year-end statement and annual report were put together, the prospect of a firmer rand seemed stronger than it does now. From the heady heights of US50c earlier this year, the rand is back below 40c and showing every indication of staying there. If the rand stays weak and group sales remain at last year's level, Samancor could hold the drop in earnings and dividends to a minimum.

The contrary view holds that, with lower expected revenues, higher costs and hefty capex commitments, this year's dividend will amount to 75c at best. Ellis says capex could hit R100m from R35,8m last year, when delays caused the group to underspend. Management intends catching up. The tax rate should also increase, although the capex programme may soften the blow.

On the operating level, Samancor has been hammered with hefty increases in electricity and rail freight charges. The rail charges hit both raw ores railed to Samancor's various plants and ferro-alloy products railed to the coast for export.

The outlook is for more of the same, given Sats' determination to index rail tariffs to inflation. As Ellis points out, this erodes SA's competitive advantage in world markets on

relatively low-value exports such as manganese and chrome ores. In the absence of improved dollar commodity prices, the only compensation has come through further weakening of the rand — and so the cost spiral continues.

Samancor increased sales of manganese ore last year by 8% to 3,3 Mt, but Ellis expects a drop in physical sales this year because of lower projected Japanese steel production. Revenues could be further depressed by lower dollar contract prices, which are between 5%-6% down on last year.

Manganese alloy sales tonnages rose 35% in 1985, prices, while previously weak in dollar terms, started firming early this year. The group expects to maintain sales tonnages of manganese alloys.

Sales of charge chrome dropped to 280 000 t in 1985 from 300 000 t the previous year, as new capacity coming on stream from northern hemisphere producers, particularly Finnish producer Outokumpu, which took market share by hefty price cutting. Ellis believes charge chrome prices could increase, while the group should benefit also from its acquisition of 49% of Tubatse Ferrochrome. He expects Western world stainless steel production to increase marginally this year to 8 Mt from last year's 7,9 Mt.

Ellis notes that chrome ore export tonnages rose by 5% last year, but dollar prices weakened. Samancor took over Union Carbide's chrome ore interests, including the Jagdlust chrome mine. Ellis says attempts



are being made to increase the dollar price of chrome ore

A (possibly pessimistic) 70c payout would put the share on a forward yield of 8,8% at the current 855c, where it could rate a buy — depending, of course, on how pessimistic you are on the rand's performance over the rest of the year

Brendan Ryan

## BOLAND BANK

### Fiercely independent

**Activities:** Provides comprehensive range of banking and trust services

**Control:** No shareholder may own more than 9,9%

**Chairman:** P B B Hugo, managing director G Z Liebenberg

**Capital structure:** 6,7m ords of 25c Market capitalisation R33,5m

**Share market:** Price 500c Yields 7,6% on dividend, 23,0% on earnings, PE ratio, 4,4, cover, 3,0 12-month high, 610c, low, 450c Trading volume last quarter, 47 000 shares

**Financial.** Year to March 31

	'83	'84	'85	'86
Total assets (Rm)	739	904	1 101	1 249
Total deposits (Rm)	644	791	958	1 098
Loans against mortgage bonds (Rm)	141	137	138	195
Acceptances on behalf of clients (Rm)	28,0	28,6	44,4	51,0

#### Performance

	'83	'84	'85	'86
Taxed profit (Rm)	6,1	7,1	7,4	7,7
Earnings (c)	92	106	110	115
Dividends (c)	31	36	37	38
Net worth (c)	656	812	914	1 149

The attitude of fierce independence seems to have paid off. For at least the tenth consecutive year, Boland Bank increased earnings and dividends last year.

That independence is also fiercely protected. Last year, Boland took Volkskas to court, claiming that Volkskas had effectively increased its stake over the 9,9% limit set in Boland's articles. The case is still under appeal, Boland having lost the first round.

The figures show no need for Boland to find a "Big Daddy" — assets have risen by 350% in 10 years and the bank has moved out from its traditional Cape stronghold. It now has 80 offices in SA and Namibia and, although MD Gert Liebenberg is "slightly hesitant in the present economic climate," wants to open two or three branches a year.

Boland has also been shrewd in determining policies. It has moved away from HP business for the past 14 months, having decided that fierce competition would cut margins. There is also a certain caution. Boland holds a higher proportion of long-term deposits than most of its competitors, although Liebenberg believes interest rates could soften further. Explaining this contradiction, he says Boland has to borrow longer because it is mainly a general bank, and holds a substantial amount of three-year loans and mortgage bonds.

Boland is providing more cheque book

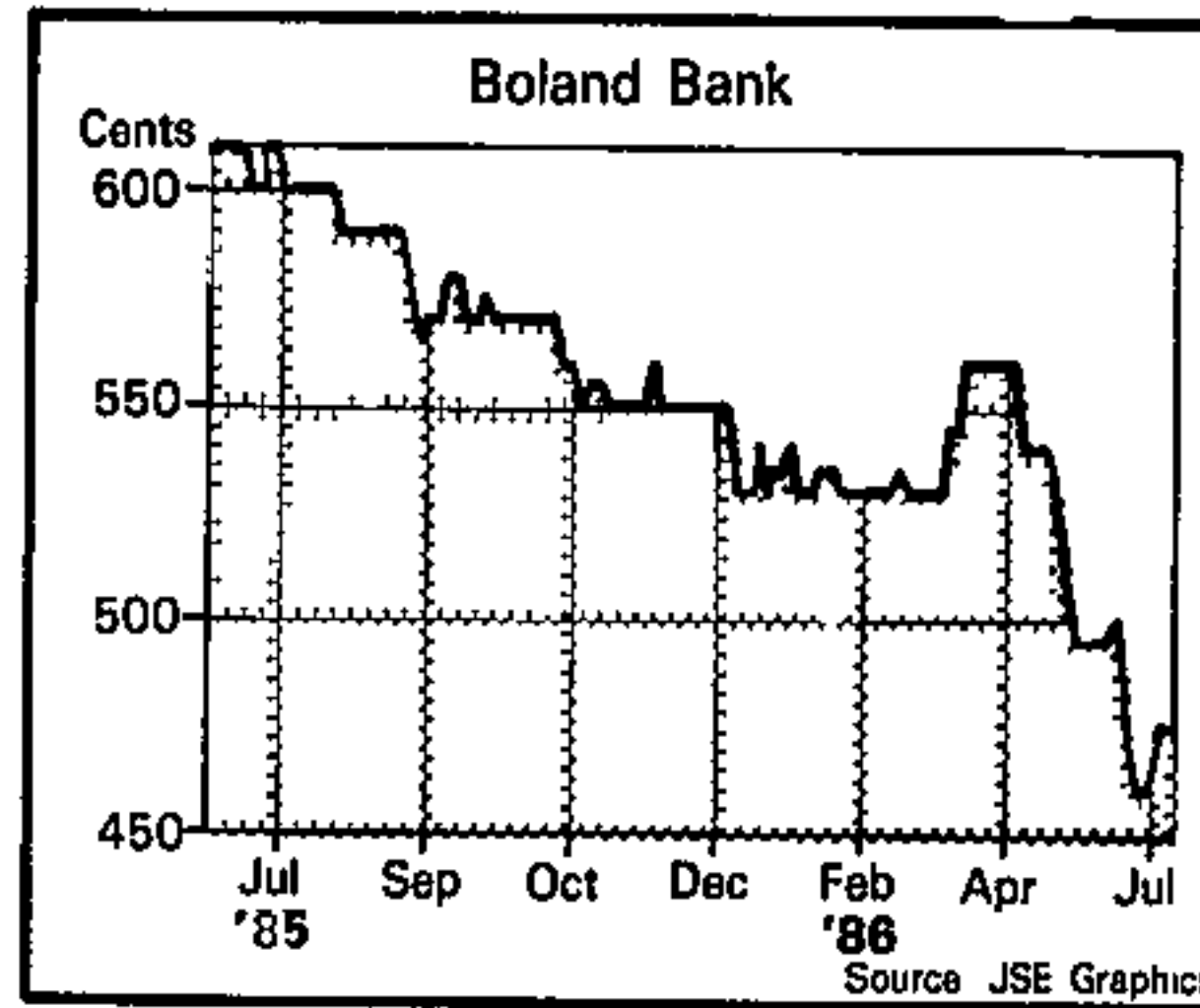

facilities and commercial services are now available at all branches. Like its competitors, it has experienced more bad debts than ever before. Loans are generally well secured, but "no one can guarantee buyers." Boland expects a "substantial drop in demand for credit."

"Now we must continue to expand," he says Saswitch is helpful, providing additional services without development costs, but "this does not increase market share." Credit control is receiving priority and, as Boland expects banking margins to shrink, there is a need to rationalise activities.

When it comes to forecasting, Liebenberg feels there are a lot of uncertainties. "We shall be lucky if we maintain earnings," he says. Nevertheless, the market's rating of Boland on a 7,6% dividend yield — compared with the sector average of 5,4% — seems harsh.

Pat Kenney

## HENDLERS

### Now for prefs

**Activities:** Manufactures and sells metalware and allied products, especially pots and pans

**Control:** Mercabank controls 76,2%

**Chairman:** L B Knoll, managing director S Derman

**Capital structure:** 42m ords of no par value, 2,9m convertible cumulative prefs of 50c, 4,5m cumulative redeemable prefs of 10c

**Market capitalisation:** R7,56m

**Share market:** Price 18c 12-month high, 40c, low, 15c

Trading volume last quarter, 428 000 shares

**Financial.** Year to December 31

	'84	'85
Debt		
Short-term (Rm)	1,7	2,6
Long-term (Rm)	33,6	33,8
Debt equity ratio	3,8	15,2
Shareholders interest	0,19	0,05

#### Performance

	'83	'84
Turnover (Rm)	45,7	40,5
Pre-int loss (Rm)	6,3	4,0
Taxed loss (Rm)	11,7	8,6
Loss per share	77,8	22,3

For two years, chairman Leon Knoll has optimistically predicted that Hendlers would be back in profit by 1986. Mercabank, which has poured millions into the ailing kitchenware company, appears to agree. It became the controlling shareholder after underwrit-

ing a R9m rights issue in 1984, but with losses of R12m that year and R9m in 1985, it has had to subordinate R9m in loans to stave off possible technical insolvency.

Of loans by a banking consortium (excluding Mercabank) of R27m, R15m is to be converted into redeemable preference shares. Knoll refuses, however, to give details. According to the FM's method of calculation, the debt equity ratio, now unacceptably high, will be unchanged.

The terms of the issue are crucial. If preference dividends simply replace interest payments, cash flow could be no better. It needs to be known how the coupon will compare with prevailing interest rates.

Falling interest rates should help reduce finance costs this year. However, even if the interest bill halves, a turnaround of R6,3m on a turnover of R40m (1985 figure) is still needed for a profit. Declining competition from importers, says Knoll, should see domestic sales improve. Local business will be further boosted by a number of new product launches, and last year's price war, which he claims cost "six figures in profit," appears to have abated.

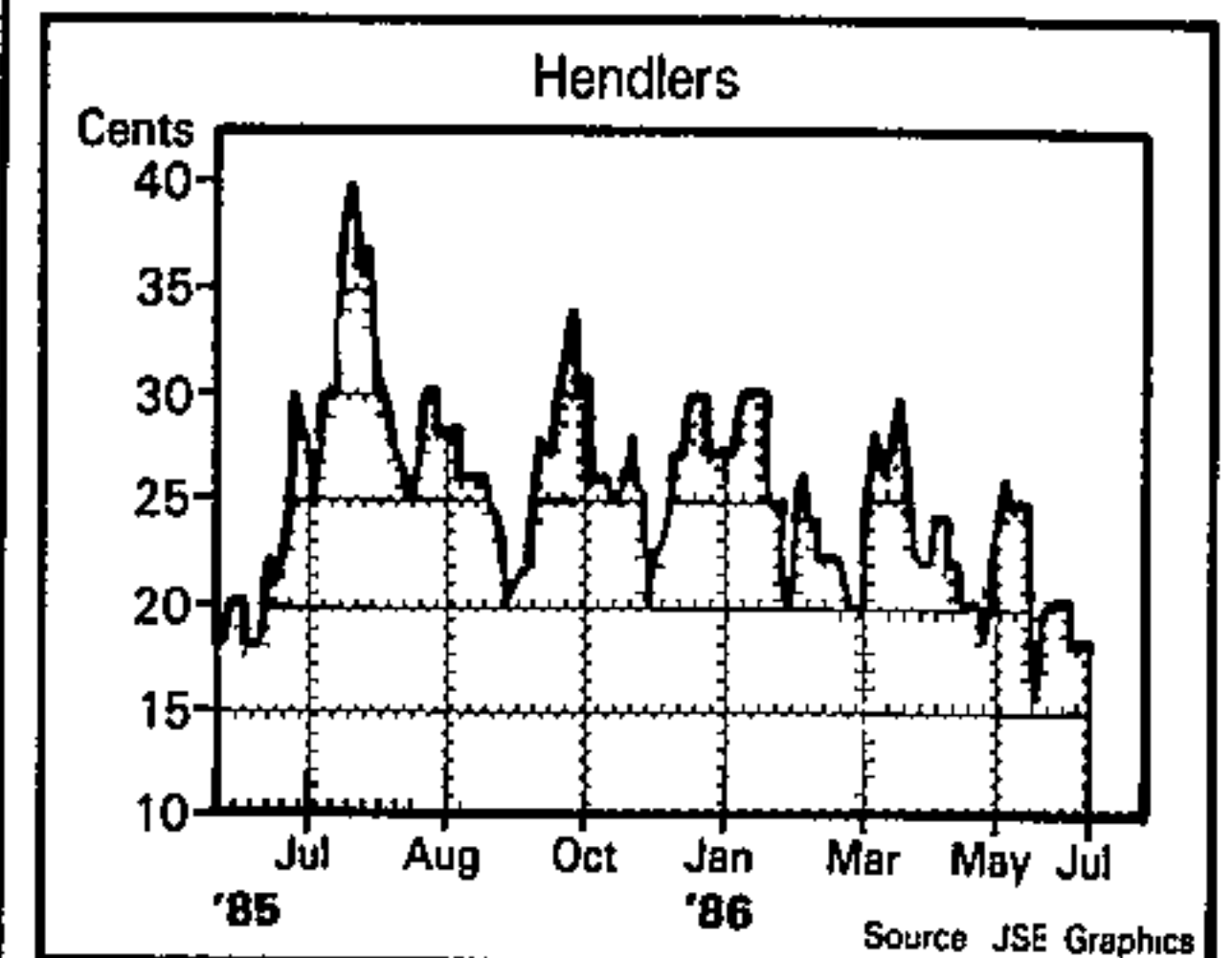

Export sales are, however, expected to fall as anti-South African feeling increases. This should be more than offset by the increase in higher margin local sales.

Rationalisation continues. Under-utilised assets, says Knoll, "must either be better utilised or sold." If all his forecasts are right, Hendlers could achieve a small profit this year. Ordinary shareholders will not benefit for a long time, though, as a large number of preference shares rank before them for dividend. This is still a share to be watched, rather than bought, until the results come through.

Pat Kenney

## FRENCORP

### Under cover

A return to profitability in the year to end-February 1986 is welcome. However, the mistakes made in 1985 were surprisingly repeated. Forex losses of R420 000 bit deeply into profits, following the R1,5m lost on currency dealings the previous year. Group financial director Gilbert da Silva tells me that policy now is to cover forward all offshore liabilities.



GFSa

1/8/86 217

# Botswana platinum find

Gold Fields of South Africa (GFSa) and Southern Prospecting are stepping up work in Botswana on what could be the most important platinum discovery yet outside SA. They are exploring what appears to be a new arm of the Bushveld Igneous Complex (BIC), the platinum and chromite-bearing geological formation mined by SA's three platinum producers around Rustenburg, in the western Transvaal-Bophuthatswana.

The arm lies around a section of the Molopo River, which forms Botswana's southern boundary with SA. The main part is in Botswana, but it stretches into the northern Cape Province. It lies some 140 km southwest of the Botswana capital of Gaborone.

According to information published by the Botswana Geological Survey Department, the area on the Botswana side is tied up by five prospecting licences. These are numbers 1/84, 2/84 and 3/84 held by Gold Fields Botswana — a 100%-owned subsidiary of GFSa — and numbers 13/85 and 14/85 held by Southern Prospecting International (SPIL), part of Southern Prospecting.

The Gold Fields area covers some 300 000 ha and the SPIL area about 190 000 ha. In SA, JCI is estimated to control mineral rights over about 250 000 ha and Southern Prospecting controls another 120 000 ha.

Mining industry sources say GFSa has a number of drill rigs in action in its licence areas, and that SPIL is in the process of listing a company in Australia to raise venture capital to drill its area.

Both Alan Munro, general manager of GFSa's new business division, and Chris von Christierson, MD of Southern Prospecting, refused to comment.

However, a research report put out by analyst Alan Hill, of Max Pollak & Freemantle, claims SPIL intends raising about A\$8m, of which about \$3m will come from London. A new company, Molopo Australia, will be formed. It will also hold a number of gold and platinum prospects in Australia. The issue is expected to be made in October/November. No stock will be offered in SA.

Industry sources say SPIL is listing in Australia because of the popularity there of gold and precious metal venture companies. About A\$200m has been raised on Australian stock exchanges in the past two years for such ventures.

The Botswana area was first drilled in 1983 in a project funded by the UK government. The work revealed that it had similar characteristics to the BIC, with similar rocks of the same age in almost identical geological sequence.

According to Hill's report, grades of platinum and palladium totalling 1 g/t were revealed. Depths are shallow at about 500 m. Grade is low by SA standards, but encouraging enough to warrant further drilling.

One thing is certain. If the deposit proves viable, it is likely to be swiftly exploited for two reasons. The first is the intensive worldwide search for sources of platinum outside SA — the main free world producer.

The second is the Botswana government's approach to mining projects. Mineral rights there belong to the State, which grants pro-

specting licences for limited periods. The GFSa licences expire in 1988. Renewals are only granted for good reasons. If the government believes a company is stalling on a development, it can award the licences to a competitor after they expire. No company can sit on a potential mine for undue lengths of time, as can be done in SA, where mineral rights are largely privately owned.

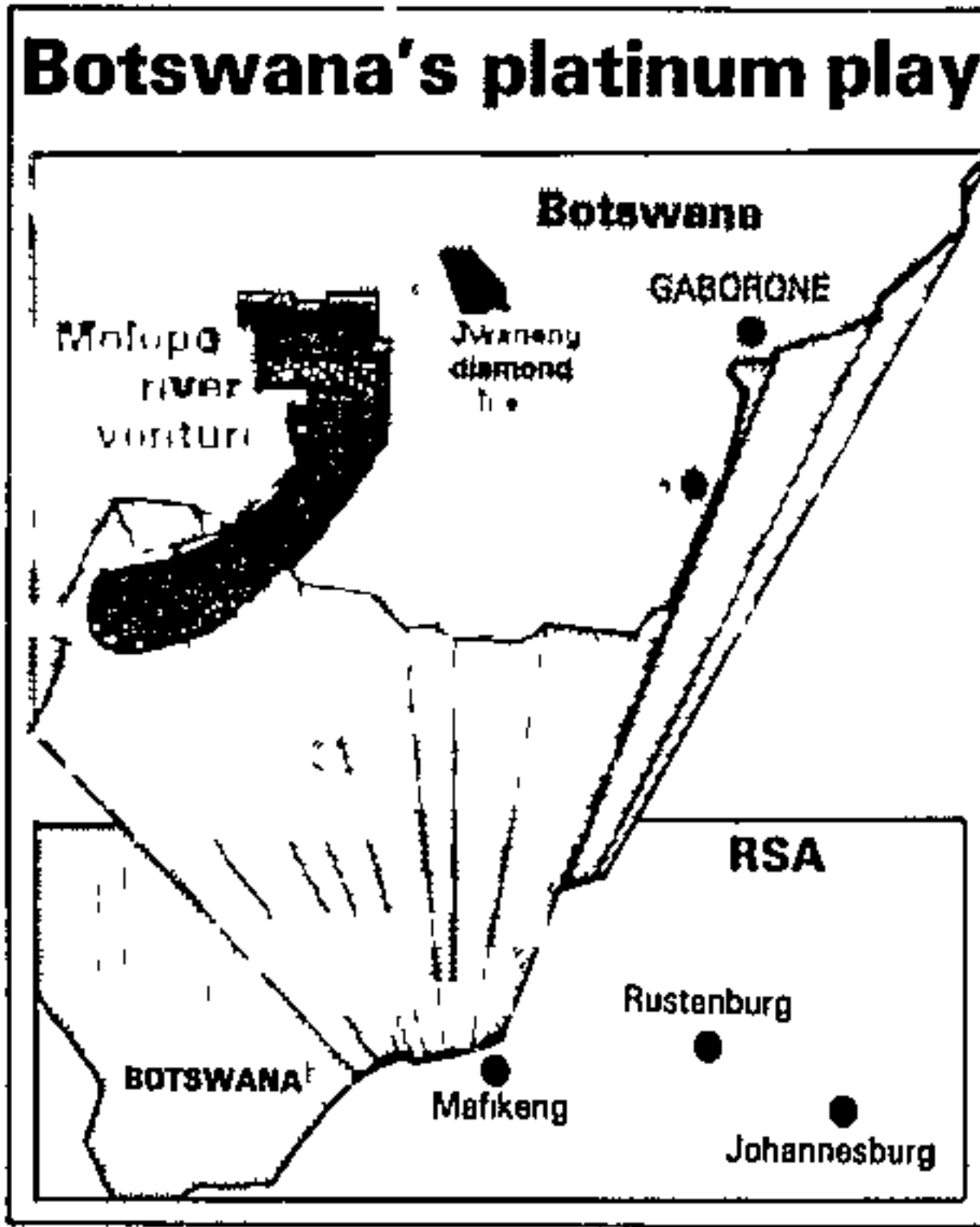

operating licences for limited periods. The GFSa licences expire in 1988. Renewals are only granted for good reasons. If the government believes a company is stalling on a development, it can award the licences to a competitor after they expire. No company can sit on a potential mine for undue lengths of time, as can be done in SA, where mineral rights are largely privately owned.

Brendan Ryan

will translate very soon into action.

There has been much speculation about the prospect, particularly as Pepkor desperately needs final repairs to its forex-damaged balance sheet. Imprudent currency dealings cost R25,9m last year, on top of R20,2m the previous year. Determined moves have already been made to restore the balance sheet, with R54,6m raised in a rights issue last year, and a further R20m from the private placement of red pref shares.

Even as the capital was raised, however, forex losses mounted. At the February year-end the debt/equity ratio remained an unhealthy 110%. Burgeoning debt pushed the interest bill up to R39,8m (R23,1m). The listing of two highly successful divisions should restore the balance sheet to structural health, and eliminate the crippling interest bill.

### Operationally strong

Operationally, Pepkor is exceptionally strong. Where many competitors in the retail clothing market have buckled, its operating profits rose 6% last year, despite a sharp fall in black consumer spending.

The group is benefiting from a strong tendency in the black market to trade downwards in times of recession, directly into Pep Stores' market. The group cannot easily be challenged in this cheapest market sector, although Edgars recently announced it would attempt to do so with a newly formed chain called Express.

The injection of new management, and impending re-organisation, may be exactly what investors — who have strongly supported the share price — have been waiting for.

Neville Glaser

PEPKOR

FIN MAIL 1/6/86

## New listings

In an interview this week (see "People"), Pepkor MD-designate Arnold Louw mapped out his plans. These include reorganising the group in line with new priorities, selling off peripheral operations that do not fit its basic retailing image, and raising funds through listing two key divisions — the Pep Stores/Ackermans chain, including its vertically integrated factories, and the Shoprite supermarket chain.

Although Louw emphasises that no listings application has yet been made, there seems little reason to doubt that the intention



Pepkor's Louw... mapping out plans

AKG 1/8/86

# Gold surge boost for SA business

(217)

By DEREK TOMMEY, Financial Editor

THE prices of gold and platinum, two major South African exports, have surged in overseas markets and look like holding their new levels

If they do it will boost business activity in South Africa

In New York last night gold reached \$363 an ounce, a gain of \$11 since Wednesday, and its highest price since mid-1984. Although gold eased back to \$360,55 in London today although expectations are that the metal will start to recover early next week

The platinum price also rose in New York last night to \$465 an ounce, its highest level since mid-1983 and a gain of \$8 since Wednesday

Analysts said the market was concerned that South Africa might reduce gold and platinum output to retaliate against sanctions. South Africa is the biggest free world producer of both metals.

## DOWNBEAT NEWS

The weak US stock market and the decline in the dollar also helped gold

Mr Dave Nelson, an analyst with the commodities firm Dean Witter Futures in New York, said "Investors were looking for a place to put their money since stock prices were not behaving as well as expected"

Mr George Nickas of the commodities firm Geldermann put gold's strength down to "anticipation that downbeat news from the US leading indicators will increase the flight to hard assets"

From London, Neil Behrmann reports that gold was able to break through a significant resistance barrier of \$355 because investors are beginning to see that it is cheap in European and Japanese currency.

The immediate reason for above-average market activity yesterday was a statement by Mr George Shultz, the American Secretary of State, that the dollar would decline further unless Germany, Japan and others cut interest rates to reflate their economies

## LOW YEN PRICE

But the main impetus to the gold market during the past few months has been persistent buying by Japanese traders and investors. Part of the purchases will be minted into 10-million coins to commemorate the anniversary of the Emperor Hirohito's reign. But the low yen price of gold has generated considerable investment interest too

Japanese gold imports surged to 348 tons in the first six months of this year against 95 tons in the same period the previous year. Bullion dealers estimate that only about 120 tons out of the 348 tons were imported for coin minting. Gold imports for the whole of 1985 were 197 tons

At the current rate of imports Japanese purchases on the international markets will easily exceed previous estimates of 600 tons — about half of Western supplies

● The rand rose to 39,75 US cents today after closing at 19,05 last night



**F N MAIL**  
**RUSTENBURG PLATS** 217  
**Resounding gain**  
After the resounding 64% increase in Rustenburg's earnings to 206,1c a share, and 50% increase in dividend to 135c, the results due soon from Impala could be an anti-climax.  
Most analysts are cautious in their forecasts on Impala, plumping for a maintained final dividend of 100c which, after the unchanged interim, would leave total distribution for the year to June at 135c a share  
Impala might be able to pay more, but the reason for the caution is the loss of production, estimated at between 175 000-200 000 oz of platinum, caused by the strike in January, and the ensuing disruption when 23 000 workers were dismissed.  
FINANCIAL MAIL AUGUST 1 1986

Both Impala and Rustenburg remain in keen demand from investors who remain bullish on the metal, although some analysts feel they are nearly fully priced  
Two points are worth pondering in the Rustenburg results: dividend cover has been raised to 1,5 from 1,4, while stocks rose by R700 000 compared with a decrease of R14,2m the previous year Does that mean Rustenburg is stockpiling platinum group metals again?  
In reply, new MD Brian Gilbertson said the calculation of stocks is a complex issue, and referred me to note 2c in the 1985 financial statements which tells interested shareholders basically that — the calculation of stocks is a complex issue  
The outlook for platinum is still bullish The Johnson Matthey 1986 Platinum report expects a continuation of the slow, but steady, growth of demand seen over the past 18 months.  
Jeffrey Nichols, president of American Precious Metal Advisors, told local investors last week — while on a swing through SA courtesy of JSE stockbroker Jan Silvis — that he forecast world platinum demand to exceed supply by 270 000 oz this year and 245 000 oz in 1987, despite expected increases in mine production  
The only events that would seem capable of upsetting the platinum apple cart are a sudden jump in price, which would encourage industrial users to search for alternative materials, or if the intensive search for new platinum orebodies outside SA bears fruit.  
Brendan Ryan

SUNDAYS (217) 3/8/86

THE market has not seen the last of the strong advance in the platinum sector.

In the past year Rustenburg Platinum has risen by 204% and Impala Platinum by 161% as the rand price of platinum has almost doubled

Both shares could continue running because the dollar price of platinum remains high, the rand is below 40 US cents and demand continues to outstrip supply. South Africa produced almost 85% of the West's platinum in 1985

The average platinum price of \$358 in the year to June 1986 looks certain to be bettered at about \$450 or higher in the year to June 1986. The rand platinum price is about R1 150 compared with R720 in August last year

Bullish sentiment for platinum shares stems from both the upward price trend and the strong investment or hoarding demand for platinum. Hoarded metal includes bars and coins weighing 10oz or less

The 1985 platinum report of British metal refiner and distributor Rustenburg agent Johnson Matthey shows that hoarding demand in the US and Japan rose to 120 000oz. Hoarders' share of total demand rose from 6.5% to more than 9%

The report says purchases of small bars and coins increased last year, particularly in the US, as the weakening dollar, rising industrial demand and continuing fears of disruption of SA supplies conspired to push the dollar price of platinum steadily upwards

The restoration of platinum's premium to gold since October 1985 and consumer wariness of the Krugerrand also induced increased in-

vestment in platinum, and these factors continue to buoy sales

One JSE analyst says the scarcity value of platinum (demand exceeded supply by about 70 000oz in 1985) and marketing campaigns by Johnson Matthey to sell platinum wafers and Impala's promotion of its Noble coins are also contributing to investment demand

He says jewellery demand is still buoyant in spite of the rising dollar price as the yen and Deutsche-mark price of platinum is "ludicrously cheap"

### VULNERABLE

Japan is the largest regional market for platinum, accounting for about 44% of First World demand. More than half the new platinum bought in Japan is used in jewellery

The jewellery market appears to be the most vulnerable to sanctions as it is relatively easy to impose sanctions on what is essentially a luxury item

But it seems doubtful if platinum would be subject to sanctions because it accounts for only 6% of SA's earnings from mineral exports — way behind gold, coal and diamonds

It will certainly not be as easy to apply sanctions in the industrial market as it would be in jewellery

In many cases substitutes would have to be found, and they would need time to develop

One of the major industrial uses of platinum is in autocatalysts — units fitted to exhaust pipes of cars which convert toxic gases so that emissions meet environmental restrictions

The use of platinum-based autocatalysts in automotive emission control grew in 1985. Autocatalyst demand increased by 80 000oz in 1985, 75% of it coming from the US where car-makers made record sales

### TAX BREAKS

The European Economic Community is debating the issue of automotive emission control and trying to decide whether to go the autocatalyst or the "lean-burn engine" route which obviates the need for platinum

However, large cars cannot make use of the lean-burn concept as yet, and companies such as Porsche, BMW and Mercedes are geared to use catalysts. European motor manufacturers also fear a flood of Japanese lean-burn cars if this is the route chosen

In West Germany, tax concessions are offered on cars fitted with catalysts

## DIAGONAL STREET KERRY CLARKE

# Rusplat, Impala still running

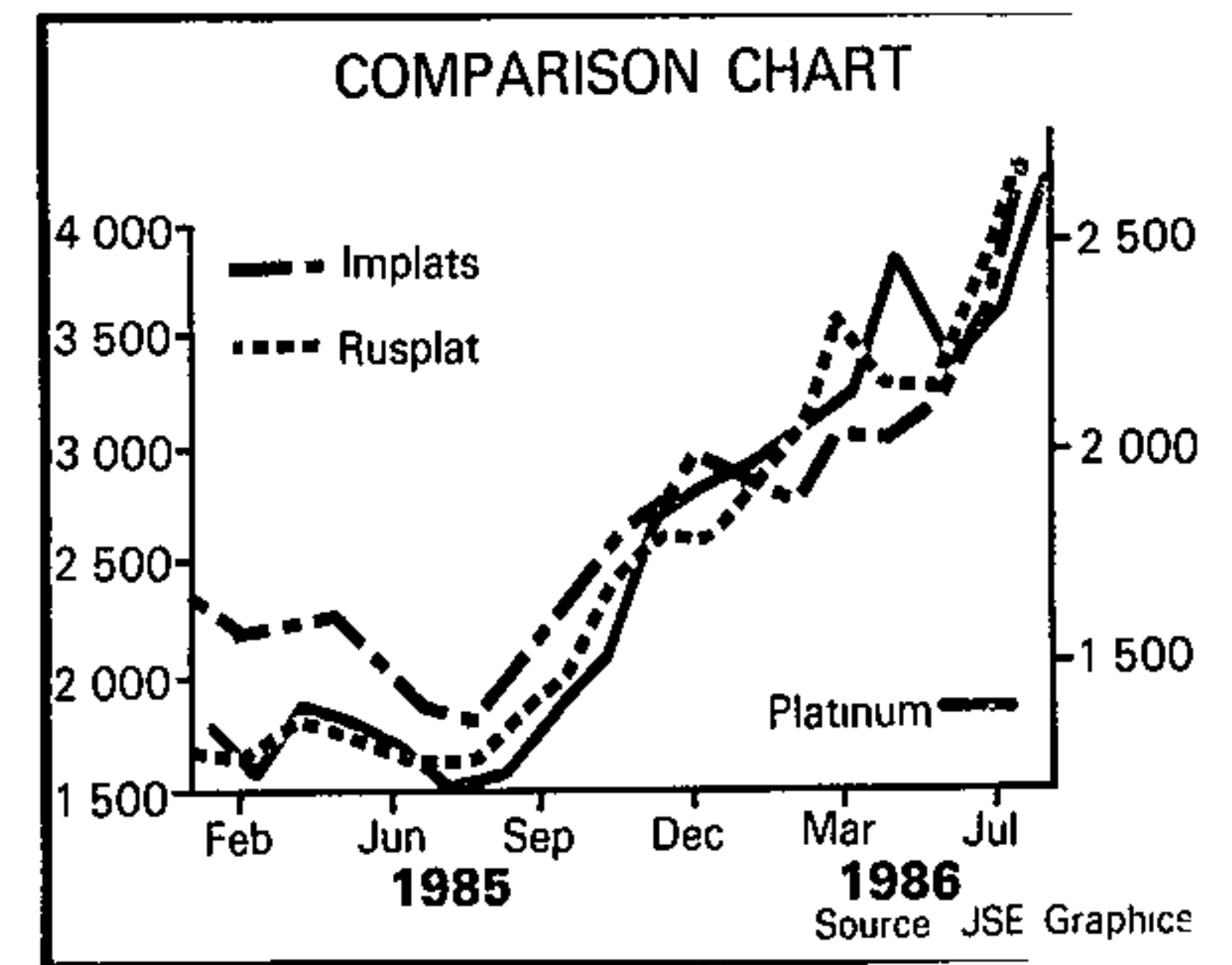
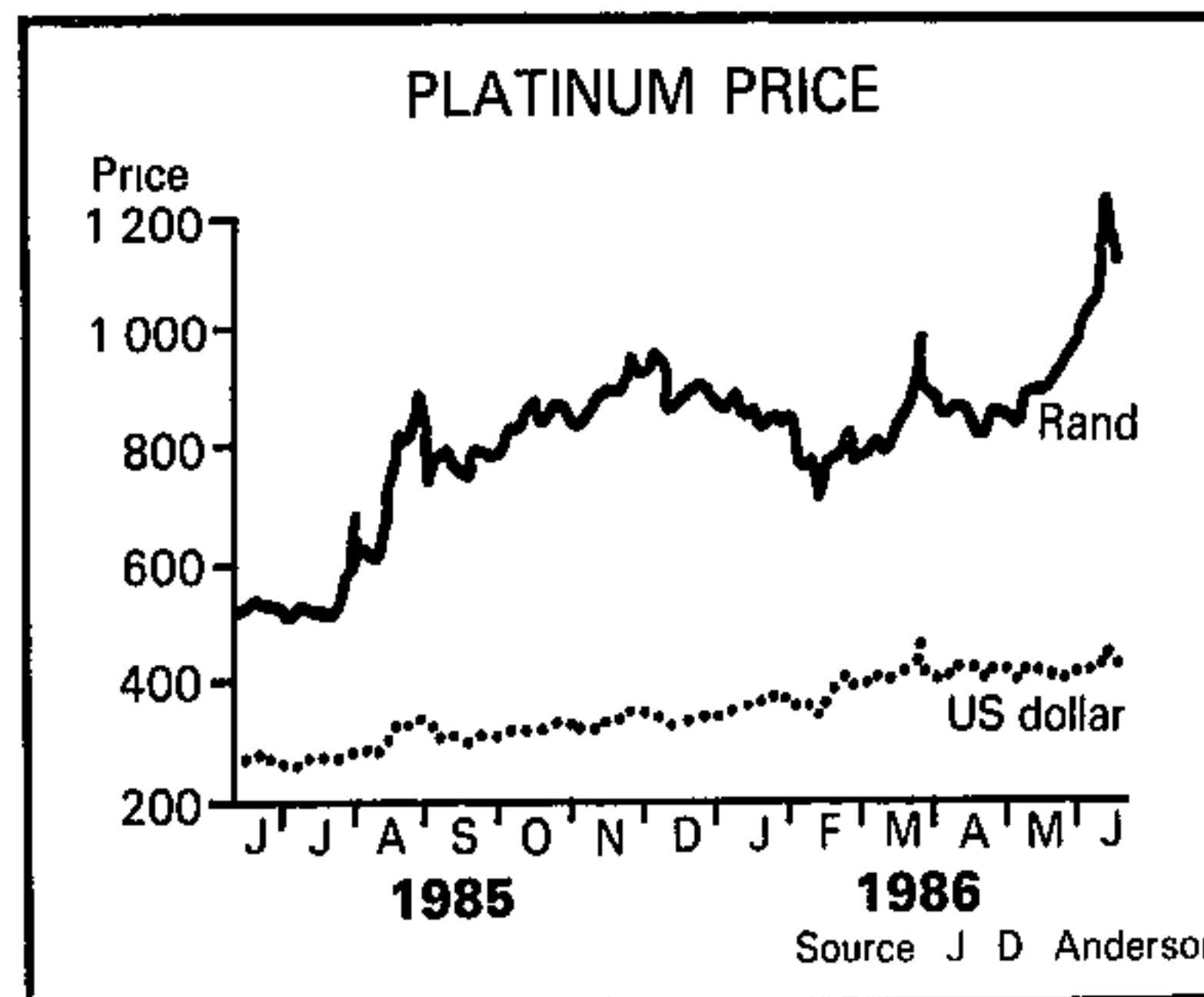

Impala Platinum is believed to have 50% of its production locked into a long-term supply contract with General Motors, negotiated in August 1982 at a platinum price of \$470 when the rand was worth \$1.32

This is one reason Rustenburg has produced better results than Impala in the past few years because its price received from Ford Motors is more closely related to the free-market price

### ON TOP

However, Impala has gained market share with its Noble coin which is marketed by a subsidiary company Ayrton Metals, based on the Isle of Man. There has been huge demand for the coin — Johnson Matthey estimates that out of total hoarding purchases of 260 000oz in 1985, the Noble comprised 40% by weight, small bars and medallions accounting for the rest

Investor sentiment regarding Rustenburg and Impala has varied. Rustenburg is now top of the pile

Although the Rusplat share price was historically about 20% below Implats, the positions have reversed since the beginning of the year as labour problems have dampened enthusiasm for Implats

Estimates are that the mine lost 200 000oz of production during strikes in January. Although earnings rose from 87c in the six months to

December 1984 to 177c in the period to December 1985, Implats paid an unchanged 35c as the mine held back profits to counter the effects of lost production

Analysts expect the final dividend for the year to June 1986 to at least match the 135c paid in the previous year

One analyst believes that although the short-term upside potential for Impala is better, Rustenburg should come out on top in the long term

Implat's three-month strike and a R59-million stock loss in 1985 caused investors to lower its rating. From 1982 to 1985 Impala has not matched Rustenburg's strong earnings and dividend growth

### EXPANSION

Although the market tends to discount results ahead of time, if Impala manages a better performance than expected, its share price could rise strongly in the short term, especially as it is moving from a position of negative sentiment

But one analyst sees the long-term growth potential of Rustenburg as more favourable because it has greater opportunities for expansion than Impala. Rustenburg has the prospect of a new mine at Maandagshoek and it can also expand production at Amandelbult

Impala will probably have to resort to deeper mining to increase production



COMPANIES

COMPANY RESULTS WRAP-UP

	Year end	Turnover (Rm)	Pretax pft (Rm)	Present Eps (c)	Previous Eps (c)	Present Div (c)	Previous Div (c)
<b>Prelims</b>							
Everite	Jun	229,6	12,8	25	91	18	60
Modder B	Jun	—	(1,3)	—	—	—	—
<b>Interims</b>							
Barclays	Dec	—	127,4	108	60	35	35
Capital	Dec	—	\$8,9	12	13	11,92	12,56
CBD	Dec	—	\$7,6	12	12	12,38	11,95
Cenprop	Dec	—	\$7,1	7	8	7,33	7,58
Crulife	Dec	—	0,5	—	—	3,75	—
Fedfund	Dec	—	\$6,9	11	11	10,48	11,39
Metprop	Dec	—	\$2,5	7	—	7	—
Messina	Dec	93,4	(0,9)	5	(45)	—	—
Pioneer	Dec	—	\$11,7	13	12	12,56	11,83
Progress	Dec	14,5	1,0	19	2	7	—
Std Brass	Dec	—	0,4	11	7	—	—

§ = Net after tax

# SA tin faces 3-year fight for survival

SA'S tin mines face a three-year survival struggle if they are to weather the international tin price crisis.

Nine months ago the International Tin Council collapsed, sending tin prices plummeting from levels above £9 000 a ton on the London Metals Exchange (LME) to last week's Rotterdam free market price of £3 640 a ton.

The rub-off from the low prices forced the country's three main tin mines into the red during the June quarter. Not even a weak rand could compensate for the collapse in international prices.

Analysts warn it will take two to three years before the stockpiles are wiped out, thereby enabling prices to return to levels where production costs can be covered.

This would occur if the spot price reaches £6 000 a ton — a level which would cover the production costs of major producer Malaysia.

When the metal was suspended on the LME, 100 000t of tin was held by bankers (44 000t), merchants (36 000t) and producers (20 000t).

At this stage it is not known to what extent, if any, the world stockpile of tin has shrunk. However, the bankers involved in the LME debacle are reported to have reduced their holdings by 10 000t.

Based on forecasts that the tin market will be in equilibrium by 1988 or 1989, the

three main SA tin mines have started rationalising their operations.

Union Tin, a Gold Fields of SA (GFSA) mine, has been placed on a care-and-maintenance basis. The mine was near the end of its life and will only swing back into production if it becomes economically viable.

Zaaiplaats, another minor producer which contributed less than 10% of SA's tin output in 1985, has also trimmed the scale of its operations.

However, GFSA's main producer, Rooiberg Tin, which is the largest tin mine in SA, increased production in the June quarter despite laying off staff.

"Rooiberg is weathering the tin crisis," says Rooiberg chairman Peter Janisch.

Janisch is confident Rooiberg will not close its doors. "The name of our game is to hold out. We must also get to a break-even situation and at this stage we are nearly there," he says.

Rooiberg, which exports half its annual production, would be hurt if fullscale sanctions were imposed.

However, Janisch points out: "Tin is not a glamorous metal and in the overall scheme, SA is a very minor producer."

Indeed, SA sales last year accounted for only 1% of total world production.

THIS WEEK'S AGMs

- Monday Aug 4: Hill-sam.
- Tuesday Aug 5: Charter; Crookes.
- Wednesday Aug 6: Egol; Rand Lon.
- Thursday Aug 7: Alex Lip (S), Boumat; Wes-wits.
- Friday Aug 8: Genrec, HCI; IGI; IGI Life, Pepgro; Pepkor, Volkskas

S = Special Meeting

DIVIDENDS

Last day to register for dividends:

- Bester (F) 8c, CBD (I) 12,38c, Chemsve (I) 25c, Dabi (M) 50c, Elands (I) 55c, Elsburg (F) 15,6c, Everite (F) 11c, Fedfund (I) 10,48c, Ind Sel (F) 25c, Metprop (M) 7c, Nat Sel (F) 29c, Picbel (A) 25c, Picfin (A) 12c, Picfood (A) 90c, Picprop (A) 4c, Pioneer (I) 12,56c, Randfontein (F) 1 000c, Rusplat (F) 82,5c, Sallies (I) 27,5c, Sanland (F) 5,39c, So-vaal (I) 380c, Vaal Reefs (I) 900c, W Areas (F) 24c, Western Deep (I) 255c

A = Annual. I = Interim. F = Final. M = Maiden

217

# Lydplat div up nearly 44%

LYDENBURG Platinum (Lydplat) has raised its final dividend by nearly 44% to 64c (44,5c), lifting total payment to 104c (72c)

The company's excellent year-end results were foreshadowed by Rustenburg Platinum's scintillating results.

Lydplat's dividend income from the platinum producer has increased to R15,2m in the year to October, from 1985's R10,3m. Net taxed profit is estimated at R15,12m (R10,47m).

Lydplat shares closed at R37 on Friday, slightly off their year's high of R37,25. Dividend yield is 2,8%. As yield is usually in line with that of Rusplat (2,3%), the shares should move ahead this week.

The platinum sector once again recorded the best week's gain on the mining board, with the index up 8,2% at 3 340,4.

LIZ ROUSE



BUSINESS

INVESTMENT

ARGUS 5/8/86 217

# Aussies, S Africa in R16 million platinum venture

The Argus Foreign Service

MELBOURNE. — The Australian share market is set to provide the home for a "spectacular" new platinum listing, involving South Africa, that is described as "potentially the best platinum prospect in the world".

Based on large and highly prospective exploration leases on the Botswana side of the South African border, it is expected that the new float will also include attractive Australian precious metals prospects

The identity of the Australian company which will partner the southern

African lease-holder is not known but it is believed to be Kevin Parry's Parry Corporation

Parry has been looking to expand its interests into precious metals for some time

The size of the float is expected to reach R16 million

The area is currently controlled by Southern Prospecting International

Kevin Parry is the sponsor of the Kookaburra Syndicate which is bidding against Alan Bond for the right to defend the America's Cup

ECONOMY

Car. Times 7/1/68  
217

# Rhodium: A powerful SA secret weapon

From SIMON BARBER  
WASHINGTON — By refusing to sell rhodium to Western buyers, the South African Government could severely damage the United States automobile industry, help poison its air, bolster the Soviet economy and reap windfall profits, an unpublished report by the US Commerce Department shows.

The platinum group metal is the key component of catalytic converters used to lower pollutants in US car exhausts. Alternatives for the converters, which are required under the US Clean Air Act, are thus far only at the drawing board stage.

Without South African supplies of rhodium, the report says, the only other significant producer, the Soviet Union, would not be able to meet US, let alone Western demand, with its own resources. There is no domestic US production.

Moscow would therefore be tempted by the prospect of massive hard currency earnings to sell the West its own rhodium at a premium and purchase the South African product at a discount to meet its domestic needs.

The Commerce Department estimates that the market panic triggered by the cutoff of

South African supplies would drive the metal's price to well over \$1 500 an ounce (about R3 750) — an attractive proposition for Pretoria even though it would have to share some of the profit with the Soviets.

"Even at a conservative price of \$1 500 an ounce, US purchasing of rhodium from the Soviet Union would give that country a foreign exchange injection of \$166-million (about R415-million) annually," the study notes.

The chief purpose of the study is to warn of the possible effects of the total trade embargo adopted by the House of Representatives last June, but it makes it clear that South Africa has a powerful weapon at its disposal if it wants to counterattack Western sanctions.

It specifically notes that similar diversions through the Soviet Union and other countries occurred during the Rhodesian embargo, adding 20 percent to the price of Rhodesia's mineral exports.

"Faced with a prohibition on importing South African rhodium and an unwillingness on the part of the Soviet Union to sell to the US more than current levels, the US would be faced with the necessity of suspending the Clean Air Act," the study says.



Rhodium price could skyrocket

# SA and Russia would reap rich boycott reward

BUDOR  
7/17/86  
217

WASHINGTON — Pretoria can damage the US car industry, bolster the Soviet economy and reap windfall profits by refusing to sell rhodium to the West, says an unpublished report by the US Commerce Department.

The platinum-group metal is the key component of catalytic converters used to reduce pollutants in car exhausts.

The only other significant producer, the Soviet Union, would not be able to meet US, let alone Western demand. There is no domestic US production.

Moscow would therefore be tempted by the prospect of massive hard currency earnings to sell the West its own rhodium at a premium and buy the SA product at a discount to meet its domestic needs.

The Commerce Department esti-

SIMON BARBER

mates the market panic triggered by the cut-off of SA supplies would drive the rhodium price to well over \$1 500 an ounce — an attractive proposition for Pretoria, even though it would have to share some of the profits with the Soviets.

The study says "Just the fear, not the reality, of supply disruptions, let alone the question of prohibited access, caused the price of rhodium to rise from \$470 an ounce at the end of 1985 to \$1 150 an ounce at the end of January this year — a period of just three months.

"Even at a conservative price of \$1 500 an ounce, US purchases of rhodium from the Soviet Union would give that country a foreign exchange injection of \$166m annually."

The purpose of the study is to warn of the possible effects of the total trade embargo proposed by the House of Representatives last June, but it makes clear that SA has a powerful weapon at its disposal if it wants to counterattack.

The author of the report, Commerce Department Southern Africa specialist Sally Miller, says. "If the South Africans want to play hardball, there are a lot of devious things they could do."

The Soviets produced 111 000 ounces of rhodium in 1984 and consumed 73 000 ounces, US Bureau of Mines figures show. The same year, the US bought 97 000 ounces directly from SA and a further 35 000 of SA-origin rhodium refined in Norway and the UK.

The manufacture of Hyundai cars in South Korea for export to the US will consume an extra 2 000 ounces a year if the cars are to meet pollution standards. In 1988, European nations will begin enforcing the use of converters, requiring a further 8 000 ounces annually, the Commerce Department estimates.

SUNDAY TIMES, Business Times, August 10, 1986

# US Treasury, IMF pool-pooch gold and platinum embargo

THE forces behind the drive to impose an American economic blockade on South African have run into a frustrating truth — their plan may not work against those two linchpins of SA's economy: gold and platinum group metals.

One of the more popular plans of action against the SA economy — a sell-off of American and International Monetary Fund gold stocks — has been shot down by the US Treasury and IMF economists. They say in a private memorandum to liberal congressional leaders that when the Treasury and the IMF were involved in substantial gold sales 10 years ago the price rocketed to \$830 an ounce — at least in part because of the market stimulation caused by the auctions

## Consequences

The political objective now contemplated is to drive the gold price to virtually nothing and thus beggar SA.

But the joint memorandum argues that it would produce a catch

By Jim Srodes: Washington

## Sanctions drive would turn into dangerous boomerang for West

22 state of affairs which could wreck efforts to solve the Third World debt crisis

The Treasury and the IMF say: "There is a strong case to be made that a massive offloading of bullion on the world market would initially produce a lower price but at the same time produce such a revival of interest in gold that the price would rebound as supplies were quickly bought up."

"Alternatively, if the price of gold on world markets were to remain at perceived 'bargain' levels for very long there is the risk that nations which could ill afford it might divert considerable sums of their current export earnings into gold purchases in an effort to build foreign reserve stocks."

"In either scenario, the unforeseen but broader consequences of a sudden effort to destabilise the gold markets present risks that far outweigh any political objectives

that such a sale might produce."

In fact, the IMF has ruled out any gold sale and this leaves the Reagan Administration in an embarrassing position.

## Trade row

By the kind of coincidence that makes delicious irony, the Japanese Government will mint a gold coin — the Hirohito — in October. It has been stockpiling most of the 6-million ounces of gold (worth about \$2-billion) in the US — more than half of it in the vaults of the New York Federal Reserve Bank of New York.

Nearly all of this gold is from SA and was bought in Europe and shipped to New York where it is officially recorded as a gold import by the US. By arrangement with the State Department, the Japanese intend to ship the gold out as an official export to Japan, so winning a

\$2-billion reduction of the record \$12-billion trade surplus it is running with America and which has aroused violent protectionist pressures in Washington

Platinum group metals provided \$584-million for SA from exports to the US last year. Another US Government report warns that the Soviet Union would be the only beneficiary of a metals embargo on SA

Worse, the report argues that such an embargo could touch off a trade war with Europe over its car exports to America

The Commerce Department has begun to circulate an analysis of strategic minerals trade with SA — a hot debating point. The report says America must get 90% of its platinum and rhodium from SA not only for pollution-control devices that are required on new cars but as an essential part of the petroleum-refining industry.

A total embargo of platinum group metals from SA would result in more than \$475-million in hard-currency purchases being made from the Soviet Union, which in the case of rhodium would probably have to fill its contracts with metal laundered from SA

## Expensive

Equally nasty would be the impact on European car-makers. They would be forced to add hundreds of dollars to the prices of their Mercedes and Jaguars to pay for pollution equipment to meet American standards either by competing for Russian platinum and rhodium or by coming up with more expensive technology

Such a move could be considered a non-tariff barrier under the General Agreement on Tariffs and Trade, says the Commerce Department.



# Gold, platinum boom

GOLD and platinum — South Africa's precious metal money-spinners — rode the crest of a trading boom yesterday

Ironically the crisis in SA contributed to the heavy buying

In New York, platinum led the surge, rising 25 dollars an ounce — the maximum allowed — to its highest level in five years, closing at 514.50 dollars an ounce. The last time it passed the 500-dollar-mark was in 1981

Gold jumped 13 dollars to close at 375.60 dollars — its highest level since June 1984

217  
SUN TIMES  
10/18/80  
SUNDAY TIMES  
FOREIGN DESK

Several factors sparked the rally, New York analysts said

These included fears that South African turmoil would disrupt platinum supplies, and concern about President Reagan's health

It was announced yesterday the President would undergo urological tests today. He has a history of bladder ailments, but it is believed there is nothing seriously wrong

\$26 jump bolsters rand and boosts financial rand

# GOTTA LEARN

AKC 5 11/18/85 217

By TOM HOOD  
Financial Staff

GOLD rocketed to \$394,50 (R998) an ounce at the official fixing in London today, up almost \$26 from Friday's afternoon fixing.

The rise bolstered the rand, which improved to 39,55 US cents from 38,15 cents at the weekend, and boosted the financial rand to 19,50 cents from 18,30

Platinum prices gained \$40 to \$540 in Zurich

Fears of a disruption in gold supplies as a result of sanctions against South Africa also pushed up both gold and platinum prices at the weekend.

In Zurich dealers forecast gold would breach \$400, although temporary adjustments downwards were possible.

## Dollar

Today's gold price rise was fuelled by another drop in the value of the dollar on world foreign exchange markets.

In London the dollar fell to 2,05 Deutchemarks, down a pfennig after slipping to 2,05 marks and 153,85 yen in Tokyo.

Kruggerand prices hit new records today, with dealers quoting a buying price of R1 213 and a selling price of R1 227 in Cape Town.

The combination of high gold prices and the low rand exchange rate could bring an earnings bonanza for the country's gold mines — and the taxman

If present price levels are maintained, the mines could receive as much as R32 110 a kilogram for their gold — a 30 percent increase in gold receipts, which averaged R24 774 a kilogram in the June quarter.

Gold-share prices rose on the Johannesburg Stock Exchange, the giant Vaal Reefs mine gaining R10 at R310.

Rustenburg Platinum gained 150c at R52



AGUS 11/8/88 (217)

COMMODITIES

# Platinum price surge could be flash in the pan, analysts say

From NEIL BEHRMANN

LONDON — Rumours that South Africa will impose curbs on exports of platinum have set off an active buying spree in precious metals markets

But informed precious metals dealers say the surge in platinum and gold prices at the weekend was based on false speculation.

They said gold was inherently strong because the "market was tight" But they were wary of the surge in platinum prices

It was standing at a premium of 34 percent over gold because of unfounded speculation about shrinking South African supplies, they said At their lows in 1985, platinum at \$242 an ounce was at a discount of 14 percent to gold prices of \$281

Platinum was a notoriously volatile metal because world production is only 7 percent of gold supplies

Bullion dealers said, however, that further strength in the gold price would underpin platinum.

London bullion dealers said the South African authorities had never

threatened counter sanctions on platinum and other precious metals because they accounted for a substantial proportion of exports

At current prices, gold exports generated around \$8 billion and platinum \$1.2 billion Coal exports, where international sanctions were in place or under way, generated \$1.4 billion at the end of last year.

South African platinum production accounted for 85 percent of Western supplies

In an interview with the Financial Times in Johannesburg, Mr Gordon Waddell, chairman of Rustenburg Platinum, the biggest platinum mine in the world, said that South African platinum mines were producing at normal output

As so often happened in markets, dealers were trying to find reasons for the sudden surge in gold and platinum, which only had a small impact on languishing silver prices of \$531 an ounce

But the gold market was already building up towards a breakout in July

BUSINESS (217) 11/18/86  
**Platinum soars**

THE price of platinum soared above \$500 on Friday for the first time since 1981 while spot gold shot up \$13 in active New York trading to a middling rate of \$375.50.

The gold price was pushed up by hefty investor demand and technical buying. Heavy buying appeared to have come originally from the Middle East, apparently sparked by concern over the intensification of the Iran-Iraq war.

Strong buying, speculative interest and a dearth of sellers caused gold to break through several resistance points. Other investors then climbed on board.

The run on platinum was caused by fears that S.A., which supplies more than 80% of the West's platinum, could hit back against external pressure.

● See Page 6.



# Platinum well over \$500

*(217) STAL*  
LONDON — Platinum, which a year ago cost \$235 an ounce, was today well above the \$500 mark because of concern over SA supplies, and metal analysts say it is heading even higher. Traders are not ruling out a price rally to \$600 this year if supplies are seriously interfered with," said Mr Martin McNeill of brokers Dominick and Dominick in New York.

The possibility that South Africa, which supplies 80 percent of the West's platinum, could hit back against external pressure by reducing sales to nations that impose economic sanctions was described by one New York trader as "a real threat"

Dealers noted that although platinum was still far off its record level of \$1 050 an ounce touched in early 1980, it had already jumped by nearly \$80 since the beginning of the month.

Traders said platinum's rise was being accelerated by speculation, especially in the US, although there was demand in London from overseas customers, including Swiss and Middle Eastern purchasers. Some analysts said the surge could herald a significant uptrend in gold, and noted that platinum led gold upward during the bull run of 1979-80.

Platinum's sister-metal palladium, of which SA is also the world's largest producer, is attracting the attention of speculators. Credit Suisse forecast last month that world demand for platinum and palladium would exceed supply in 1986 and 1987.— Reuter.

## NEWS FOCUS

NEW YORK — Platinum prices, already at 5½-year highs, will soar even more in the coming weeks, many analysts say.

For many months, platinum has outshone other precious metals, driven by intensifying turmoil in SA, the world's largest producer, and rising industrial and investor demand.

Last week prices crashed through the psychologically important \$500 an ounce level, in large part spurred by speculation that SA would retaliate against possible sanctions.

Many traders expect further price increases. "We're breaking out — there are no ifs, ands or buts about it," says Richard Maseri, senior trader at Private Securities, Miami.

Analysts say the potential for transportation and supply disruptions increases daily as public pressure in the US mounts for sanctions. Market forecasters add that technical factors will trigger additional buying. William O'Neill, research director for Elders Futures, New York, anticipates platinum will soon rise to \$550 an ounce, Maseri expects prices to surge as high as \$675 within a month.

If SA retaliates, adds Frederick Demler, metals economist for Drexel Burnham Lambert, New York, "the sky's the limit".

Platinum contracts for October delivery on the New York Mercantile Exchange soared the daily permissi-

# Platinum set to go higher

ble limit of \$25 last Friday to \$523.10 an ounce. In the past year, platinum prices have soared 86%, far surpassing gold, after lagging that traditional favourite for years. In the past week alone, platinum prices surged 11%.

The SA situation also spurred a 4% price rally in the gold market last week. Analysts noted that while SA produces more than 80% of the Western world's platinum, it also supplies 60% of its gold. On the Commodity Exchange in New York on Friday, gold contracts for October delivery soared \$13.10 an ounce, to \$379, in heavy trading — their highest level since June 1984.

Some analysts caution that the platinum market is overbought and due for heavy profit-taking, however. Sanctions might not lead to supply disruptions, several traders add. "The reality might be less worrisome than

the expectation," says Jeffrey Nichols, president of American Precious Metals Advisors, New York. Indeed, Demler says if supplies aren't disrupted and demand subsides, prices could crash to \$460 and perhaps as low as \$420.

Nevertheless, many analysts say platinum is attractive, fundamentally and technically. Industrial and investment demand continues to outpace new market supplies, according to Shearson Lehman Brothers, which recently predicted the platinum deficit this year could reach 500,000 ounces.

Meanwhile, the recent rally has spurred increased retail buying of the metal, dealers say. Last Thursday and Friday alone, for example, New York-based Deak International's retail sales of platinum reached 60 ounces, or 60% of its total for all of July. — AP-DJ

BW DAY  
12/8/86  
217



# Gold, platinum soar in JSE rush

JOHN BATTERSBY  
and LIZ ROUSE

THE gold price rocketed yesterday on European markets.

It soared to a peak last reached in 1984 and shattered records on the Johannesburg Stock Exchange.

The metal touched \$398/oz in London, easing under profit-taking to an afternoon fix of \$388. JSE turnover reached a new peak of R109m, of which mining shares accounted for R90,5m.

With platinum as the leader, the surging prices of the two noble metals have been sparked off by fears of SA retaliation to sanctions and growing anxiety about deflation in the world economy, London analysts said yesterday.

"Platinum is the leader and gold is following. It seems the US has suddenly woken up to the likelihood of platinum supplies being disrupted by SA counter-

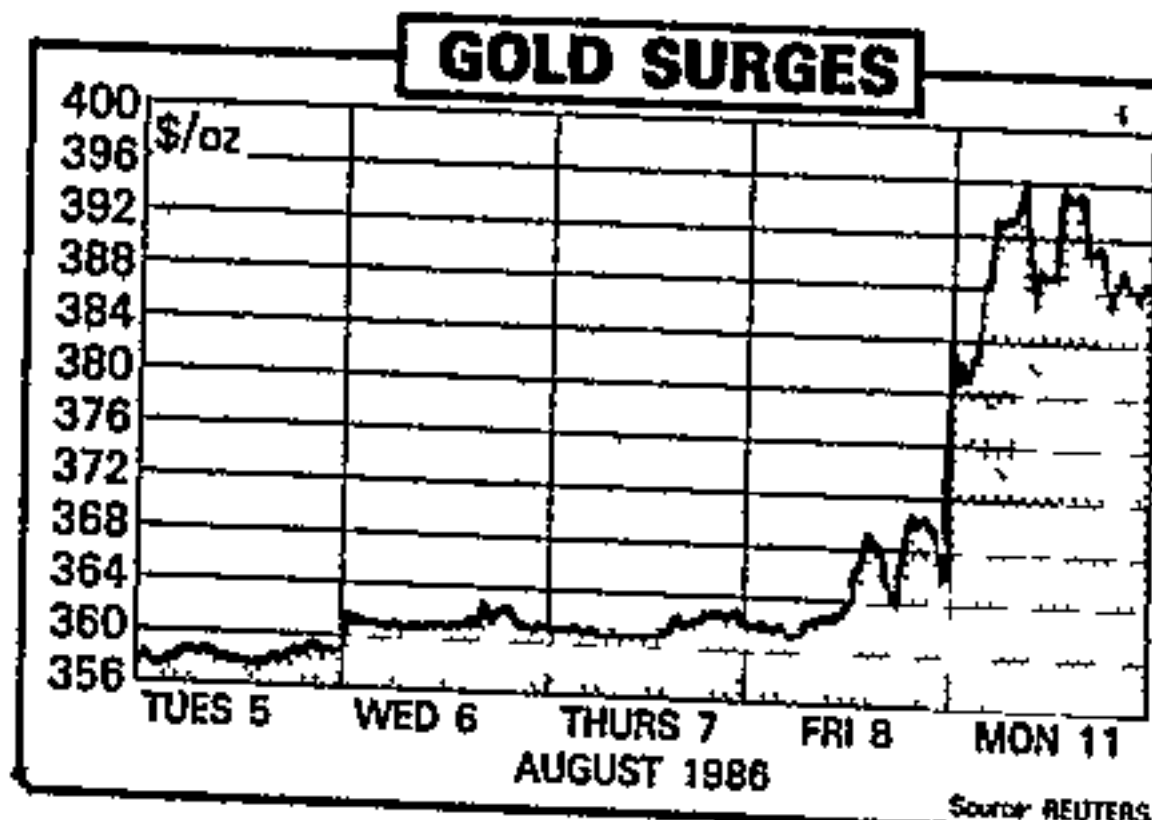

measures and continued troubles in that country," said Stephen Briggs, a researcher from London metals brokers Shearson Lehman Brothers.

He added that there had been hints for several weeks that gold and platinum would take off, "but the US markets had not been taking it seriously until today."

The *Wall Street Journal* published a prominent report yesterday morning linking the platinum price rise to the possibility of SA retaliation. It predicted the price would continue to rise sharply in coming weeks.

The implications for gold yesterday were immediate.

After closing at just below \$370 on Friday, the London gold price soared to \$398 yesterday before being fixed at \$388 yesterday afternoon, 5% up on the day.

"As stock markets are seen to be peaking, people are looking for something else to invest in — and gold is the obvious thing," Briggs said.

Anxiety about the world economy — and particularly fears of a pending recession in the US — could send gold on

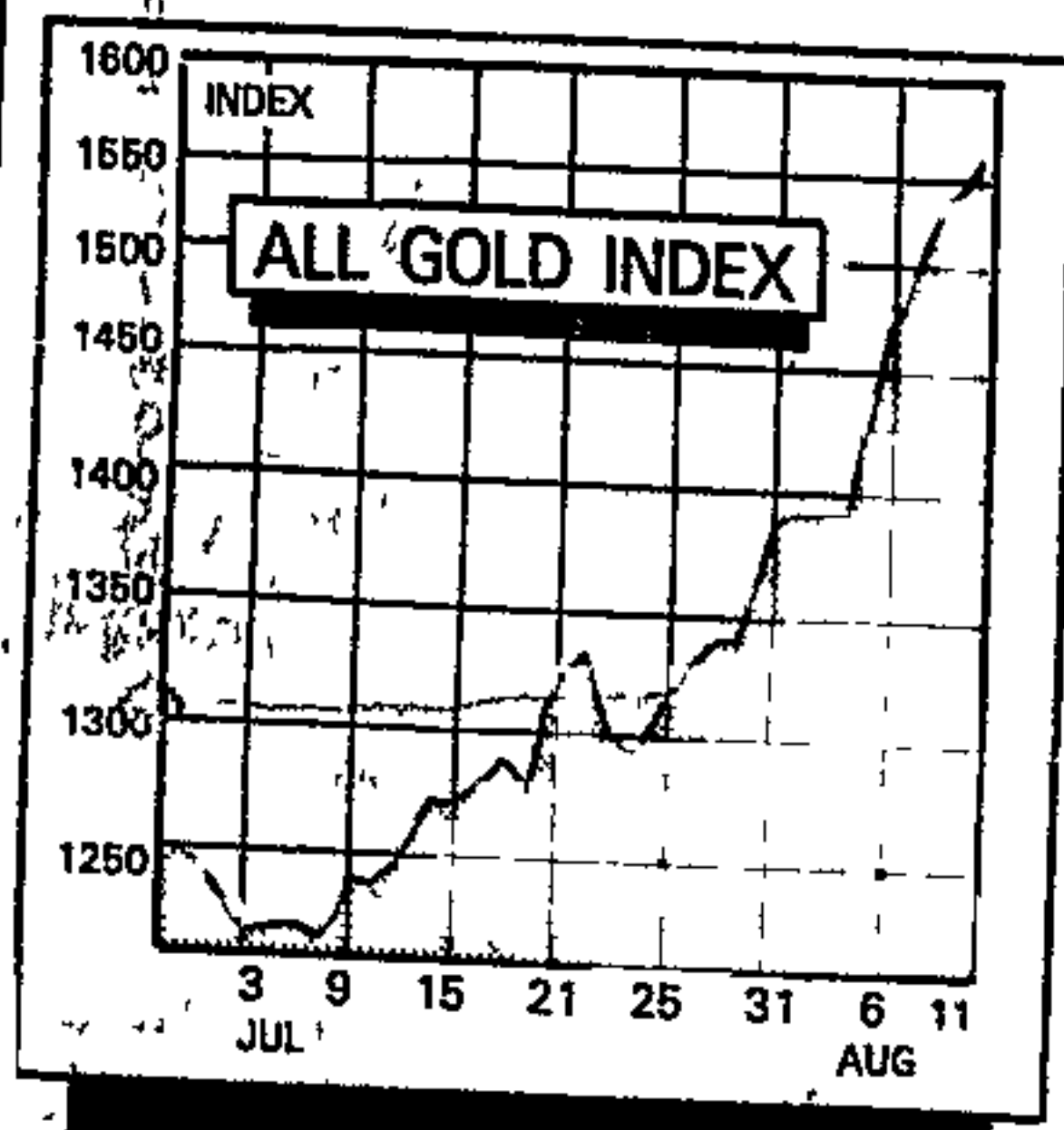

● To Page 2

# JSE turnover at new peak

an upwards spiral

Platinum jumped more than \$50 to \$555 in London yesterday, falling back to \$538,50 in the afternoon, still 7% up on the day.

The metal has been climbing steadily in recent months and is now at a five-and-a-half-year high because of industrial and investment demand outstripping new market supplies.

In the past 12 months platinum has shot up by 86%, and by 11% in the last week alone — well ahead of the gold price after lagging behind for years.

Some analysts warned that the platinum market was heavily overbought and due for profit-taking.

Others were sceptical that sanctions and counter-sanctions would lead to disruptions in supply.

"We don't share the view that platinum supplies will be cut off by unrest in SA," said Ted Arnold, metals specialist of a leading London metals dealer.

"The price already carries a very large SA premium," he said.

But mounting pressure for sanctions

in the US is likely to strengthen the perception that supplies could be disrupted.

Some bullion dealers have played down the likelihood of counter-sanctions, pointing out that SA stands to lose more in export earnings from counter-sanctions than it stands to gain in diplomatic leverage.

There were already indications last week of a major move by investors into platinum, when volumes for the two-day period of Thursday and Friday reached 60% of the volume for the entire month of July.

The JSE opened in high gear yesterday. It was the bull market for which gold and stock market analysts had been waiting.

Johannesburg brokers said the inevitable correction in the gold price to \$387,70 was not expected to stem the bull run on shares, because their books were crammed with unfulfilled orders.

● From Page 1

HAMISH McINDOE

CANADA'S nickel-producing Falconbridge is to put its 25% stake in Western Platinum on the market.

Falconbridge CE and president Bill James said in Toronto yesterday that its stake in Wesplat was definitely for sale.

He said firm negotiations with possible buyers were not underway, although "we have talked to some people".

Sale of Falconbridge's share in Wesplat would mean the loss of one of the last sizeable Canadian investments in SA.

James confirmed that Lonrho — with its 50.44% share in Wesplat — would have first option to buy Falconbridge's stake for a "payable price".

Wesplat joint MD Terence Wilkinson yesterday denied knowledge of Falconbridge's intention to sell its holding in the Transvaal mine.

He said speculation over Falconbridge ditching its SA interests had been widely mooted over the last few months.

"But I'm not aware of any negotiations to sell off Falconbridge's Wesplat

Wesplat  
holding  
for sale

holding," said Wilkinson, who also heads Lonrho (SA)

In London yesterday, Lonrho (UK) director, Paul Spicer, said. "We're not commenting."

James said sales of its Wesplat stake was part of Falconbridge's ongoing programme of debt reduction and asset sales.

Mobil (US) holds the balance of Wesplat's shares through its Superior Oil holding. It too has been subject to speculation over an impending sell-off of its mining and mineral interests

SA Foreign Trade & Investment



PRECIOUS METALS

# Platinum leads bear panic

The platinum-led bear panic in the precious metals markets was simmering down as the *FM* went to press. There was, however, no sign of heavy selling of physical metal — by the Russians or anyone else — which would totally wipe out the “spike” in prices which peaked on Monday.

“We expect a 50% retracement of the rally, but that will still leave gold comfortably in the \$375/oz-\$380/oz range and platinum around \$500/oz and looking extremely strong in chart terms,” says Stephen Briggs of Shearson Lehman Brothers, London.

The lift off in platinum, gold, palladium and silver bore all the hallmarks of a classic panic. Last week's US anxieties that SA retaliation against sanctions would lead to a shortage of the metal were heightened on Monday by rumours that Rustenburg was buying platinum on the New York Metals Exchange (Nymex). This may have been covering in of forward sales positions, but it triggered a stampede in all precious metals.

The volume of platinum trading on Nymex, which had averaged 4 376 lots (50 oz each) during the first three days of the week, rocketed to 8 215, 9 407 and finally 12 644 in Monday's rush to \$560/oz. The pattern was repeated in gold. From a daily average of under 22 000 contracts (100 oz each), the volume on Comex climbed to nearly 48 000 and was estimated at 70 000 on Monday when gold hit \$397-\$398.

A similar trebling of business was seen in palladium and silver.

By Tuesday morning, some calm had returned. Profit-taking left gold trading at \$386,50-\$388, platinum quoted at a wide (and nervous) spread of \$533-\$537 and palladium on \$125-\$128 (from its best of \$135).

“There wasn't much logic behind platinum's surge, but nor was there any real sense in going short of gold because the US Senate was talking of selling bullion out of Fort Knox to depress the price and finish off President Botha's resistance to reform,” said one bullion dealer. “What is surprising is that we haven't seen any heavy offloading of gold into the rising price — which is what the Russians were doing earlier this year.”

“Barring a collapse, gold could generate a momentum of its own. More people are talking of deflation and its impact on overblown equity markets. Any retreat into liquidity will obviously have an impact on sentiment towards gold.”

expected to succumb

Few analysts, however, expect cheaper money all round to prevent the dollar going lower. An average of six forecasts in London puts the year-end value of the dollar at Y135 and DM1,80 — with concomitant movements in other currencies in the European Monetary System. Sterling, shadowed by oil prices, is not expected to rise significantly from its present range of around \$1,50. ■

FOREIGN EXCHANGE

## Lost gold hope

The rand goes on its by now regular merry-go-round. Just as hopes were raised, with eyes switching focus from sanctions to the gold price, the rand came under heavy pressure on Tuesday.

Closing last Friday at US38,15c, the currency opened at US39,5c on Monday on thin volume as a result of the sharp rise in bullion prices. But this soon proved unsustainable, with dollar demand too great. The rand quickly fell under US39c, and by press time Tuesday was under US38c, with the Reserve Bank apparently keeping a low profile. Dealers report a steady shortage of dollars on importer demand.

It is clear, one dealer points out, that the market must first believe that gold will stay at or near these levels. Exporters are also wary of selling dollars forward because of fears that orders may be cancelled.

But the major tragedy is still against third currencies. Last Thursday saw the rand hit new lows of 58,64 Yen and DM78,98. By Tuesday, it was around Y58,87 and DM80,24. Standard Bank's trade weighted index was 40,59 on Thursday. Its all-time low was 38,83 on June 13.

Citibank says the sharp rise in gold price has “thrown new light on the situation.” Like

WORLD INTEREST RATES

## More cuts expected

Three hours of talks between US Federal Reserve chairman, Paul Volcker, and the president of the Bundesbank, Karl Otto Poehl, this week convinced currency markets that another round of coordinated interest rate cuts is on the way. It may not happen this month — Bundesbank officials in Frankfurt were quick to pooh-pooh speculation that German rates would be cut on Thursday. September is strongly tipped for the next move.

Helped by profit-taking in gold, the Volcker-Poehl meeting lifted the dollar off its lows. It had sunk to a record low of Yen 153,55 (24% down this year alone), while at DM2,055 the dollar was at its worst level since early 1981. In a week, the dollar's trade-weighted index suffered a fall of 0,5%. Another half-point reduction in Germany's discount rate (to 3%) would bring it down to the record post-war level.

Germany, along with Japan, remains sceptical, however, that such a cut will be effective in stimulating growth. Both nations ostentatiously declined to follow the last US move to 6% (in early July) on the grounds that their domestic credit growth was already high enough. And the weakness of economic growth was entirely due to falling export volumes.

But the US has continued to apply intense political pressure on Europe (where Germany is the pivot) and Japan. They are now

### RAND'S PRICE

Aug 12 1986	R1 equals	One foreign unit equals (R)
SDR	0,322	3,107
	0 466	2 148
ECU	0,381	2,622
	0 599	1 669
UK £	0,258	3,882
	0 331	3 019
US \$	0,385	2,597
	0 462	2 165
Canada \$	0,534	1,873
	0 626	1 597
Switzerland Fr	0,639	1,565
	1 055	0 948
France Fr	2,578	0,388
	3 915	0 255
Germany DM	0,794	1,259
	1 280	0 781
Japan Yen	59,000	0,017
	109 250	0 009
Italy Lira	545,750	0,002
	860 500	0 001
Zimbabwe \$	0,640	1,563
	0 730	1 370
Austria Schil	5,575	0,179
	9 000	0 111
Holland Guilder	0,895	1,117
	1 449	0 690
US \$ value of SDR	1 032	1,210
US \$ value of ECU	0 780	1,019
Financial Rand		
Cost in US \$	n/a	0,194
Discount (%)	n/a	49,610

Year ago figures in light print  
Average of the Telegraphic Transfer buying and selling rates used by the banking sector for the day for amounts up to R20 000 depending on foreign currency involved  
The above rates are for guidance purposes only

### Forward \$ costs

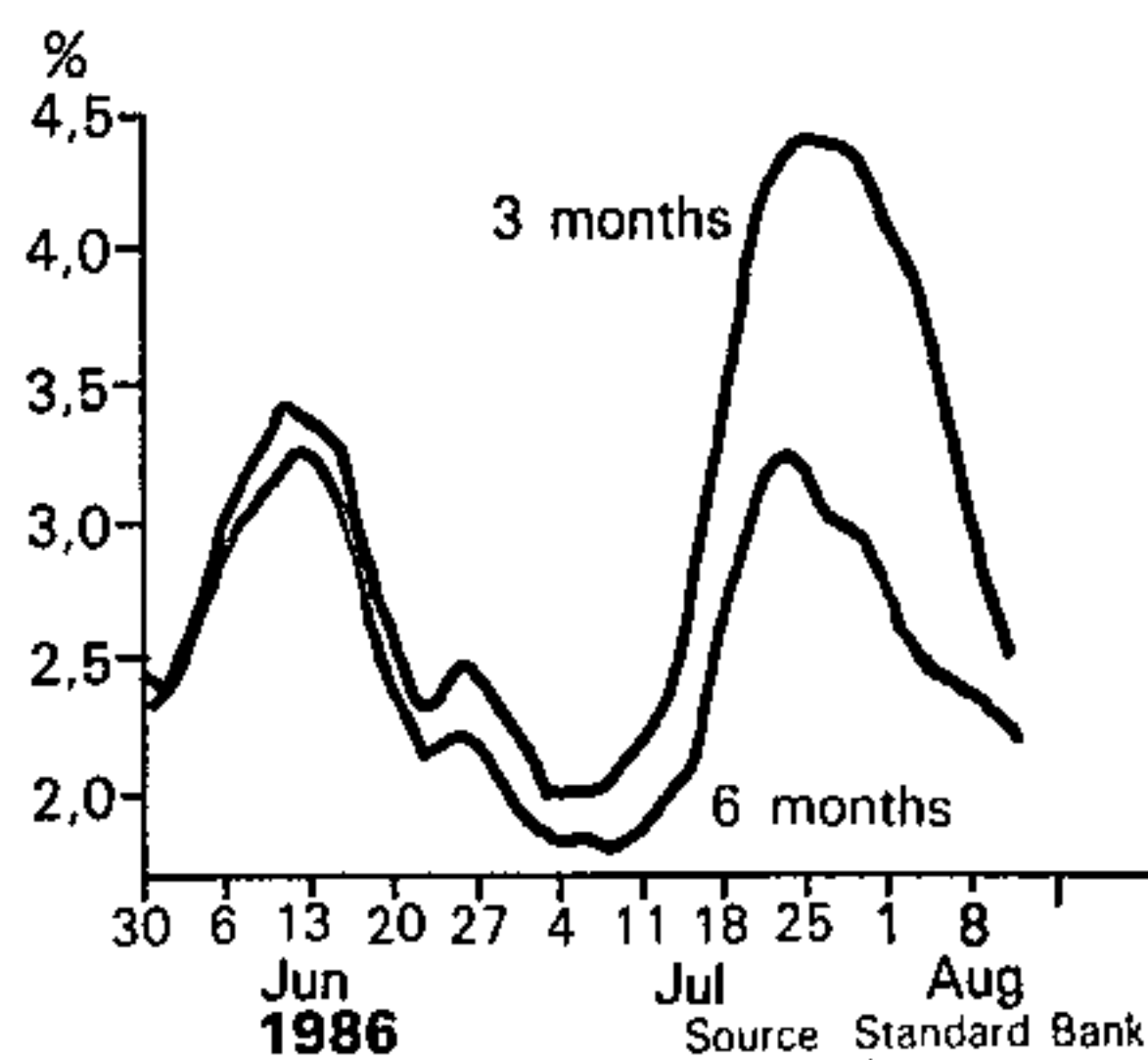



## IMF REPAYMENT

Reserve Bank Governor Gerhard de Kock has confirmed that last week SA made the third of eight scheduled quarterly repayments on its 1982 SDR1 billion loan from the International Monetary Fund. The repayment amounted to R215m, against R192m for the second repayment, three months ago.

other dealers, it doubts whether the rise in the rand has been accompanied by any real improvement in supply "Rather we believe that the rand will be buoyed by the gold price windfall, but unless a real supply of dollars emerges, the rand will struggle to rally above US39,4c. Hopefully, the gold price will continue to improve, which will give the market a psychological boost and any major rise will obviously assist the rand"

Citibank expects that "any rally in the gold price and selling of dollars might be used by the authorities to absorb dollars to replenish foreign currency reserves, keeping a lid on too-rapid appreciation. With the sanctions debate, it might be regarded as prudent to keep exports as competitive as possible"

The gold price rise came just in time to divert attention from sanctions. Barclays says that although the rand began relatively firmly last week, "it has not been able to maintain the gains, giving way to increasingly negative sentiment after the communique released at the close of the Commonwealth mini-summit. Recent events have not been conducive to the unwinding of leads and lags, which remain a negative factor"

Banks are understandably reluctant to commit themselves, although one senses greater confidence.

Barclays adds that "the currency has potential to firm marginally from present levels," with a proviso on political developments and that the dollar continues its downtrend, lending support to the gold price

□ The Reserve Bank has started quoting both spot and forward prices on AP Dow Jones Telerate (page 7953), as well as Reuter screens, as we reported last week ■

## CAPITAL MARKET

### Correction time?

The million-dollar question is, have we witnessed the bottom of the incredible bull run? And incredible it has been — long-term rates have fallen by around three percentage points in as many weeks. Tuesday, however, saw a strong upward correction of around 40 points on long-term rates on profit-taking and institutional selling of portfolio stock. RSA 13%, for example, was 14,98% at press time on Tuesday. It traded at 14,55% on Monday, but is still below last week's levels.

The reaction to the surge in the gold price was barely significant. Some dealers say this reflects the extent of the change in mood. However, to be sure (and sit on the fence), one can still find optimists who enthuse on how the "bottom has not been reached"

To the delight of dealers, volumes are continuing upwards. JSE volume on Thursday exceeded R1 billion for the first time. Weekly turnover was R4,1 billion.

Option prices are also increasing. Three weeks ago, a one-week RSA 13% call at spot and a put four points from spot could be bought for R2 200. They now cost R9 000.

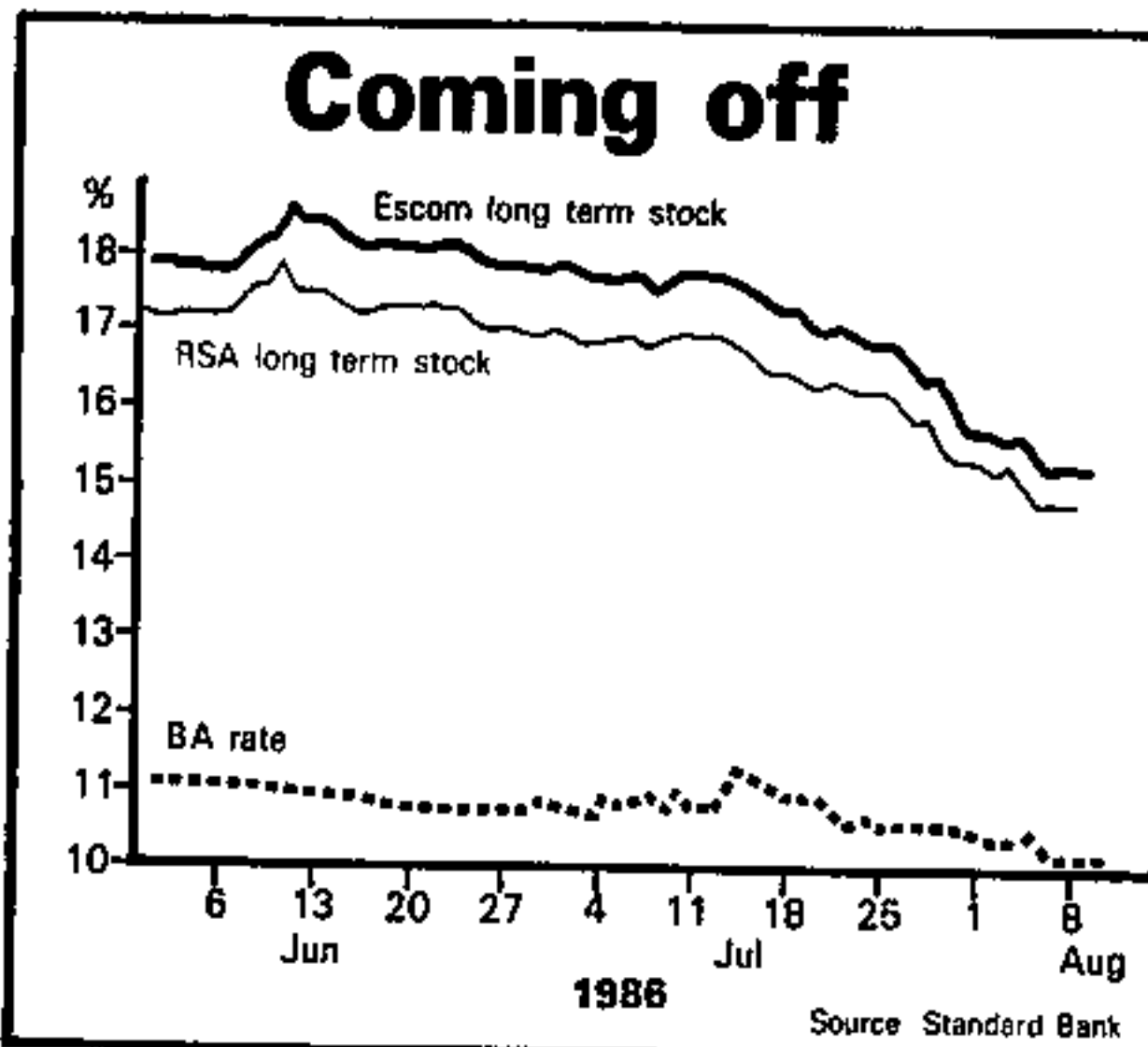

The Reserve Bank has completed tapping the 14,5% 1993, it seems by R700m in total. It tapped R1 billion through the 14% 1989. This completes its taps for the year, but the Bank could start selling for the Public Investment Commissioners.

Also of interest was Monday's two Land Bank debenture issues — 12,75% 1991 and 13% 1992 at yields of 13,25% and 13,65% respectively. The Land Bank hoped for R300m and got R450m — R250m to the 1991 debenture. Dealers say it was all taken up in half an hour, reflecting the popularity of the medium-term area which "is not too risky and provides relatively good yields"

## MONEY MARKET

### Raining money

It has not taken long for the market to recover from its disappointment at the 50-point rediscount rate cuts. Rates have dropped to new three-year lows as liquidity eases to a level where the market is almost out of the Bank. Says one dealer "Institutions are sitting with cash to get rid of". Dealers report no big buying and expect "another period of inertia"

The market shortage narrowed from an already slim R245m last Monday to a mere R42m a week later. Heavy government spending, a foreign loan repayment (see box) and notes in circulation account for this.

The Bank is unlikely to allow the shortage to become negative, as it is a crucial instrument to influence interest rates. A surplus means banks have surplus cash reserves on account with the Reserve Bank. Without such a surplus, the Bank cannot direct rates. The Bank could also withdraw R550m the

Corporation for Public Deposits has on deposit with discount houses.

With such liquidity, Tuesday saw the three-month bankers' acceptance rate trade at 10,10%, slightly up from its opening 10,05%. It closed at 10,4% last Tuesday. Call is around 10%-10,25%.

The weekly tenders were also down. Both the Treasury bill (TB) and Land Bank bills were bid at an average 9,93%, the TB down 12 points and the Land Bank eight points. The TB attracted R113m (R147m) for R100m (R60m) on offer and the Land Bank tender a larger R192m (R273m) for R50m.

Although these rates are a large discount to the rediscount rates, dealers do not expect the Bank to cut rediscount rates again for some time. The August month-end, being a tax paying month, is usually tight — as is September. ■

## SYDNEY

### Still resilient

A classic example of the market's resilience occurred again the other week. The latest ploy by the ubiquitous Robert Holmes à Court in the tussle for control of BHP turned interest back on to Australia's biggest company and helped lift the all-ordinaries index from what had looked to be developing into something of a nosedive.

At Friday's close it was 60 points up over the past fortnight, although at 1153,2 it was still 100 points off this year's high.

Suddenly, however, talk is not so much of the Federal Budget on Tuesday as of who will win control of BHP — which dominates Australian markets — and what profits can come from backing the winner.

If the trend so far is anything to go by, increased interest in BHP leads to renewed buying pressure on other major industrials. The rationale is that resolution of the battle for control of BHP will create some very wealthy winners.

They are expected to turn profits back into the market and create another burst of take-over activity. So the investment community is busy trying to pick, and get set in, stocks likely to be next on the shopping lists.

All this is very well, but some older heads are still concerned about the Budget. It is felt

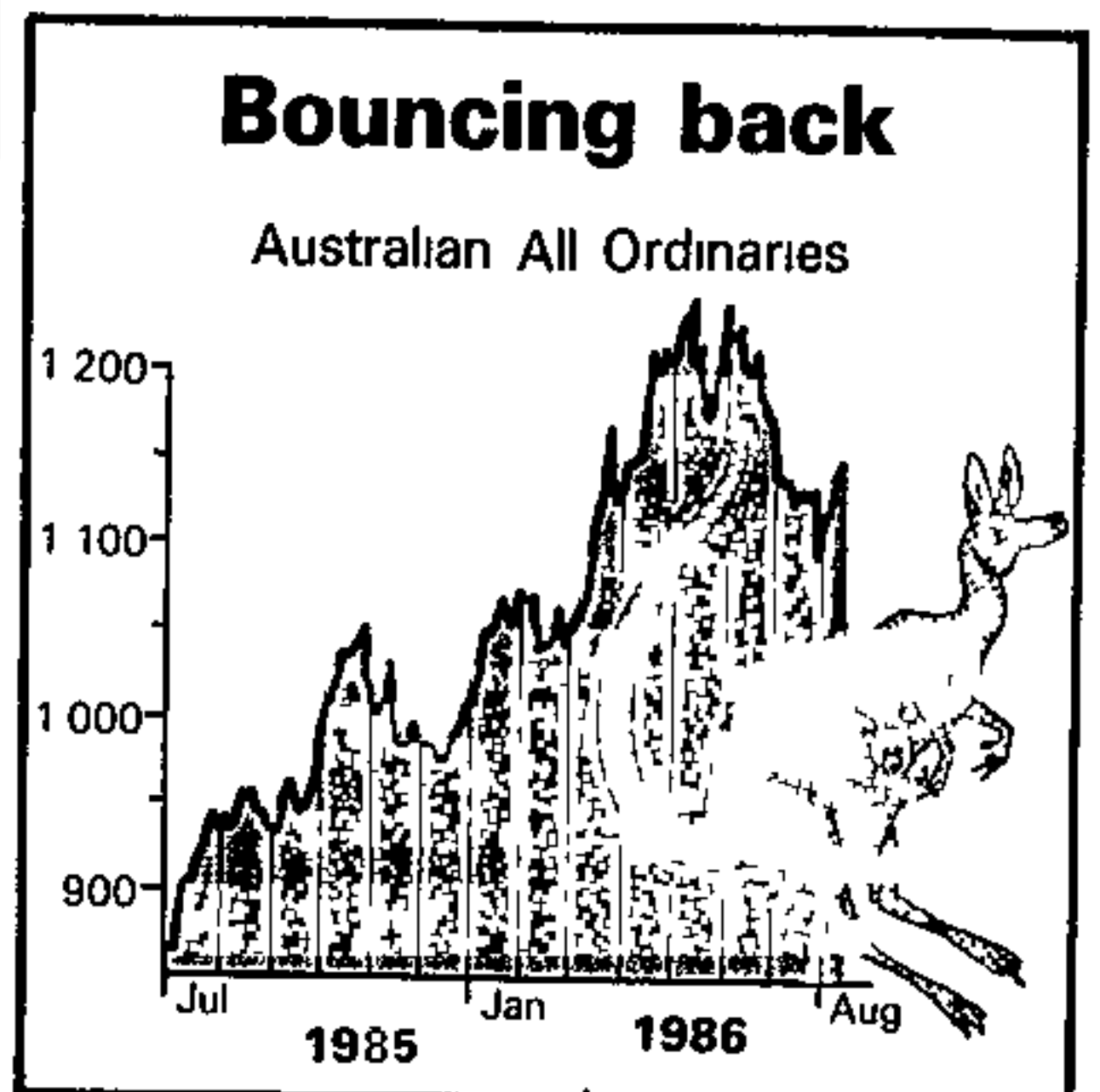



# Falconbridge pulling out of Westplat?

By Gareth Costa

Canadian company Falconbridge is said to be selling its 25 percent stake in Lonrho-controlled platinum producer Western Platinum, which analysts estimate is worth about R200 million.

The mine is tightly held, with Lonrho holding 50 percent, Mobil 24 percent and less than one percent held privately.

Analysts point out that although Falconbridge still does Westplat's marketing it no longer refines its metal, thus reducing its interest in the mine.

Two factors make the decision rather strange. Firstly, the capital would have to be taken out of the country at a substantial discount via the financial rand, whereas dividends are remitted through the much more lucrative commercial rand.

The second point is the timing, which could be construed in two ways, with platinum performing extremely well above \$500 an ounce on world markets with substantial benefits for shareholders through dividends. However, if there was pressure to sell now would be a good time, since the listed platinum producers have surged strongly on the JSE, and a reasonably high price could be demanded.

Analysts suggest that there would be very few interested parties in the country, since R200 million is extremely expensive for a non controlling interest.

However, Lonrho has first option on the Falconbridge stake.

# Rusplat looking to higher profits

BUSINESS DAY (217) 15/8/86

**RUSTENBURG** Platinum will again head for higher profits this year if demand and the rand price of the metal are maintained, says chairman Gordon Waddell in his annual review.

Written before the surge in platinum prices, Waddell's report says the demand for platinum and platinum group metals continues to be satisfactory.

"If both the current level of demand and the rand prices obtained in July continue, then Rustenburg's profits will again increase," he says.

In rand terms, Rustenburg increased its taxed profits by 64,6% to R258,2m in the year to June. However, when measured in dollars they were lower than those earned in 1980 and 1981.

"This is a matter of grave concern both for Rustenburg Plats and the country since it is a striking and brutal reflection of the depreciation of the rand

CHERYLYN IRETON

against the dollar," says Waddell. Another matter important for the future of Rustenburg's mines will be whether experiments with mechanised and trackless mining equipment are successful.

Waddell deplores the high tax levied on Rustenburg, which continues to pay tax and lease at the marginal rate of 66%. He hopes that the Margo Commission will recognise that there is a point of diminishing returns for the country through the imposition of so-called "temporary surcharge" tax.

He made the plea last year that the platinum mining industry should not be placed at a handicap in its efforts to develop new markets and thereby earn additional foreign exchange, as it is clearly in the interests of all South Africans.



BUDDAY 2018/16

AV

(217)

## Implats posts 33% taxed profit rise

CHERYLYN IRETON

IMPALA Platinum (Implats) surprised investors by increasing its taxed profits by 33% to R193m for the year to June — despite a R45m loss arising from labour unrest in January

As predicted, the Gencor mine maintained a final dividend of 100c, giving an unchanged total of 135c for the year

Earnings jumped 33% to 334c a share (251c).

A large portion of the mine's output is sold on long-term contract, which insulates it from the cost and/or benefit of market and exchange rate fluctuations

Capital expenditure increased to R110m (R91m)

Because of the higher capex bill, lease considerations fell to R15,4m (R27m) and local tax provisions dropped to R29m (R32m)

However, tax provisions for both Bophuthatswana and the UK were higher at R46m (R31m) and R8m (R198,000) respectively.

especially since most London analysts  
reduce its debt mountain from the un-  
committed funds, where their details raised

# Impala boosts earnings 33%

By Gareth Costa  
Impala Platinum Holdings has lifted  
its earnings by 33 percent to 334c a  
share for the year to end-June, but has  
kept the dividend for the year un-  
changed at 135c

The company reports that R45 mil-  
lion in after-tax money was lost due to  
the strike in the earlier part of the  
year. This amounts to 78c a share, and  
would have increased earnings to 413c,  
which is the same percentage increase  
as Rustenburg Platinum recorded

Another negative factor is the low-  
priced long-term contracts which Im-  
pala entered into which analysts esti-  
mate amount to about 40 percent of its  
one million ounce production

Pre-tax profit was 23 percent up at  
R290 million, while the tax after capex  
of R110 million was lower at R97 mil-  
lion. After tax profit of R192 million  
was 33 percent up from R144 million.  
Most of the earnings have probably  
gone into reducing the company's debt  
position

20/8/70  
SMA  
217



Mining rights not proclaimed

# Survey shows massive new platinum find

**HUGE** platinum deposits, more than double the size of South Africa's known resources, have been located in the Bushveld Complex by the government's Geological Survey department (GSD).

The deposits have been identified after four years of extensive seismic studies of the igneous rock area containing the Merensky, chromitite and UG2 reefs.

The GSD fieldwork has traced the platinum-bearing Merensky reef to depths shallower than anticipated. In parts it is only 400m below the surface, stretching to depths of up to 3km.

The economic value of these deposits can only be determined once underground samples obtained through boreholes have been assayed and evaluated.

However, new traces of both the reefs and host igneous rock have been found in

## NEW PLATINUM DEPOSITS

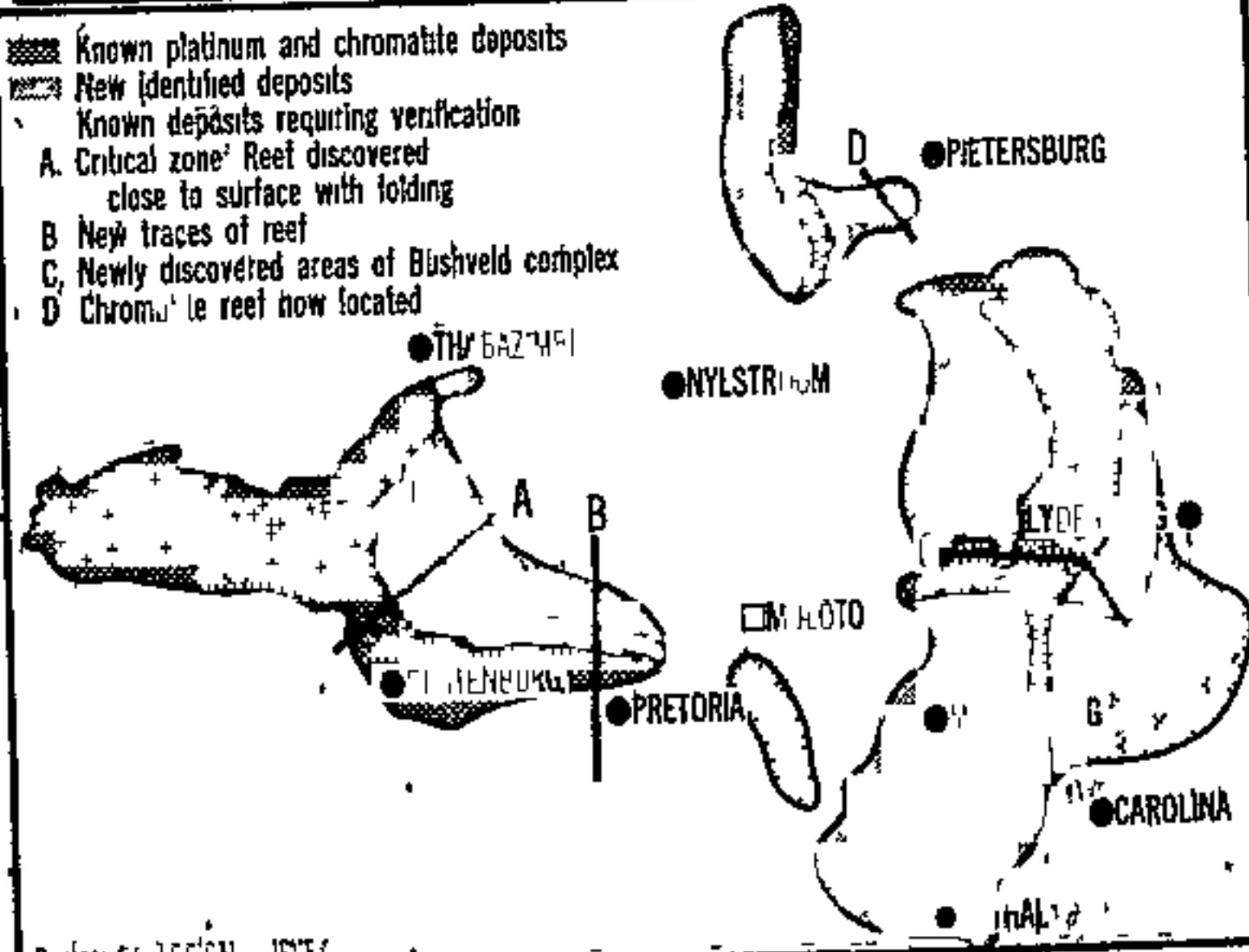

CHERYLYN IRETON

areas reaching from 10km north of Pretoria to Thabazimbi, from Lydenburg to Bethal in the east and in the northern Potgietersrus district.

The western outcrop of this unique

● To Page 2

## Survey reveals massive platinum deposits

geological formation is where the Rustenburg Plats and Impala mines are located. Gold Fields of SA's new Northam platinum project is situated at the northern tip of the proven western area of the Bushveld Complex.

Mining rights to the newly-disclosed platinum areas have not yet been proclaimed. Mintek president Aidan Edwards said yesterday he was "very excited" about the discovery and believed the mining houses would clamour for the right to participate.

But data, which could lead to the establishment of new platinum mines if the deposits are viable, will only be made available on open file next month.

One of the most rewarding aspects of the intensive study had been the tracing of the Merensky and other reefs to areas where they were not previously known to exist, said GSD chief Nok Frick.

"New data on the gradient of the reef has also been collected, showing how the reef dips and is actually folded in places."

Prior to the research the presence of the Bushveld Complex was unknown in the Moloto area, roughly north-east of Pretoria. This could open up other mining possibilities.

217 BUS DAY 21/8/86

217 ← BUS DAY From Page 1 21/8/86

Stock exchange excitement over big platinum discovery and

# SA strikes

record price

# it rich

News 21/8/86 (217)  
newspaper

## and gold sharply higher

By MICHAEL CHESTER  
Argus Correspondent  
JOHANNESBURG. —  
The Johannesburg Stock Exchange bristled with excitement today over the discovery of huge platinum deposits in the Bushveld complex.

With the metal hitting record price levels — it was quoted at \$558 today — the find could add billions of rands to South African earnings.

Boffins at the Geological Survey Office estimated that the new discoveries have doubled the size of the country's known resources of platinum. In the last few months the metal has soared even faster than gold on world markets

### Seismic

They also confirm that new hoards of chrome and vanadium — metals crucial to steel producers — have been found with the platinum.

Seismic studies show the platinum reefs start about 400m underground in sections and run as deep as 3km

Drilling will now unearth samples to help evaluate the new finds

The areas under most intensive study run from the north of Pretoria to Thabazimbi in the west, from Lydenburg to Bethal in the east, and around Potgietersrus

### Big houses

Gold Fields of SA is planning new platinum mines in the western section of the Bushveld Complex. Rustenburg Platinum and JCI are also studying the potential for new mines

It is now likely all the big mining houses will join the platinum hunt

The Chamber of Mines says the surge in exploration promises to lead to at least 15, and perhaps as many as 20, new gold mine operations in the Witwatersrand Basin

Financial Staff  
GOLD spurted six dollars an ounce in early trading today to reach \$383,50 in Hong Kong before falling back at mid-morning to \$380,50 in London.

The sharp rise in the gold price was apparently triggered by a \$25 jump by platinum in New York last night to \$559 an ounce before easing to \$558 at the close.

### NEW PEAK

Gold shares advanced on a broad front on the Johannesburg Stock Exchange today and by mid-morning the JSE's all-gold index had risen 22 points to a new peak of 1 636,9

Dealers blame fears of a platinum shortage for the jump in the platinum price, Reuter reports from New York.

Recent estimates indicate that there could be a possible shortfall between supply and demand of 220 000 ounces in the next 12 months.



# Jobs for thousands

*Copy to be 20/8/80 21 P*  
JOHANNESBURG. SA reserves of platinum, chrome and vanadium are at least twice as large as first estimated, SABC radio news reports.

This was revealed in a geological survey released in Johannesburg which says the mineral deposits in the so-called "bushveld complex" between Pretoria and Brits are at levels which make them economic to mine.

The survey said the deposits were only 400m below the surface in some areas.

The mining is expected to provide jobs for thousands of people.

The extent of the deposits was determined by a method which is used throughout the world in searching for oil, according to the report. — Sapa

217 FIN MAIL 22/8/86

RUSPLATS

# Hot streak

**Activities:** Mining, processing and refining of platinum group metals, and a number of by-products, which include gold, silver, copper and nickel. Cobalt sulphate, sulphuric acid and sodium sulphate are also produced

**Control:** JCI owns 32.62%, Anglo American owns 23.79% and Lydenburg Plats owns 8.25% of the issued share capital

**Chairman:** G H Waddell

**Capital structure:** 125.3m ords of 10c each  
Market capitalisation R6.6 billion

**Share market:** Price 5 225c Yields 2.6% on dividend, 3.9% on earnings, PE ratio, 25.7, cover, 1.5 12-month high, 5 300c, low, 1 540c Trading volume last quarter, 2.1m shares

**Financial:** Year to June 30

**Performance:**

	†'83	'84	'85	'86
Profit on metal sales (Rm)	135.9	210.3	349.9	675.8
Gross sales revenue (Rm)	544	807	1 063	1 600
Taxed profit (Rm)	63.4	100.1	156.9	258.2
Earnings (c)	50.6	79.9	125.2	206.1
Dividends (c)	45.0	60.0	90.0	135.0

\* Lifo † 10 months to end-August

Coming after Rustenburg Platinum's (Rusplats) most successful year, with taxed profit up 530% on the 1982 trough of R41m, the tenor of chairman Gordon Waddell's annual review remains encouraging. Most factors behind the 64% profit jump in the 1986 year should stay in place. These include the weak rand, firm dollar prices of platinum, growth in sales of platinum group metals (PGM) to the motor industry, expanding jewellery consumption and increased investment demand.

Waddell rightly expresses concern that profits in US dollars remain substantially below those of 1980 and 1981. While that is certainly worrying, local shareholders have been comforted by a twenty-fold appreciation of the share from the low of 265c in 1982. This is a greater recovery than that shown so far by De Beers, which climbed from just below R4 in 1982 to around R33. At Rusplats' 1982 nadir the share was depressed by a 66% profit collapse and a theft of platinum from the Wadeville refinery. Since the 1986 year end, the last outstanding insurance claim in respect of this theft was settled, bringing total insurance recovery to R6.4m.

With the share yielding only 2.6% on dividend, can further advances be expected? The omens look good. Platinum shares are among the few counters on the mining board that are not only seen as rand hedges, but have also gained from a sustained firming in product prices, unlike gold, platinum markets are being lifted largely by improved industrial



Rusplats' Waddell ... concerned about the rand's fall

and jewellery demand

When Waddell wrote his review, dated August 1, the free market price of platinum stood at a \$100 premium over gold. "This is no more than is due to platinum, which is much more than a monetary metal in the light of its strategic and other uses in industry where it has a much broader base than gold," he says. "It has, however, to be accepted that the volatility of its price both up and down is likely to remain greater than that of gold."

For some years, considerable stockpiles were said to be overhanging the platinum market but this changed in 1985. Waddell says the improvement in the free market price had its origin in the much better balance that emerged between demand and supply in the last year or two.

The US motor industry remained buoyant, with 1985 sales of automobiles in that country up by nearly 5%, and there is evi-

dence of a trend towards both higher loadings of PGM on each car, and of a greater use of platinum and rhodium combination at the expense of palladium.

In western Europe, manufacturers are beginning to fit catalytic devices and encouraging developments are cited in West Germany, Sweden and others. "It seems, therefore, that requirements for platinum and rhodium are increasing apace and may well be sufficient to offset any decline in demand from their counterparts in America from the (estimated) 1985 level," says Waddell.

Latest US Bureau of Mines figures also depict substantial growth in industrial demand in 1985 from consuming industries in the US, and Waddell is reasonably confident that demand from this sector was maintained throughout the first six months at a similar level to the 1985 period.

Sales of platinum for use in jewellery rose in Japan, the leading market, by 13% in 1985 and indications are that this pace has more or less continued. Sales of kilo bars of platinum to large investors in Japan, the most price elastic of these markets, fell substantially in the first half of 1986, as did sales to industry. However, further growth was seen in the West German jewellery market, where platinum continues to improve its niche relative to the jewellery market as a whole.

Investment in platinum via ingots and small bars has also surged, particularly in the US, and the momentum apparently in-

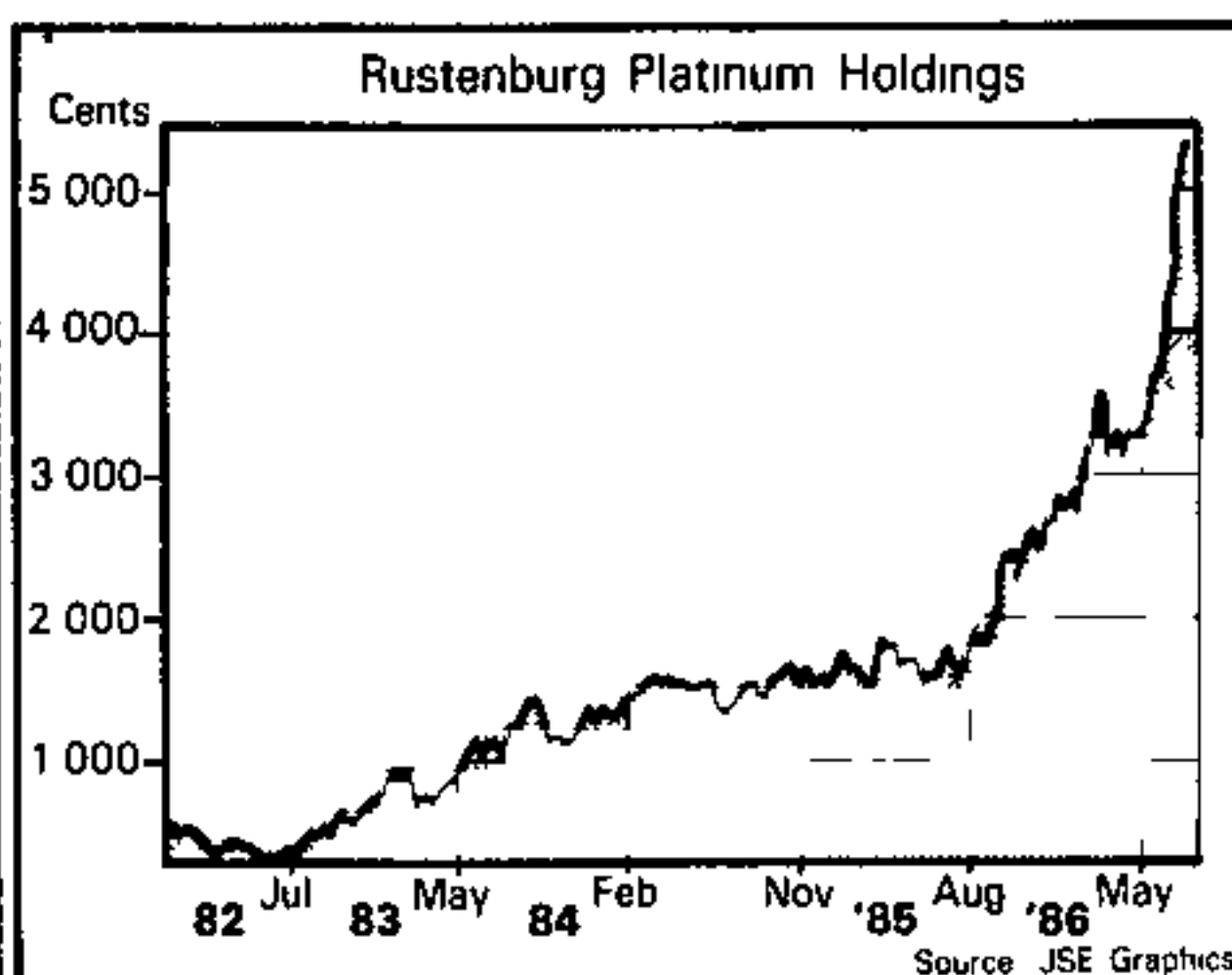



creased in the first half of this year; this increase may well have balanced the decline in other sectors. For the present, then, the overall picture reminds one of Julian Ogilvie Thompson's "slowly rising tide" metaphor, made with reference to the diamond market.

What could upset the platinum appellation? Short-term factors to watch include potential sales by Russia that could depress prices, and any slowdown in the world economy. Longer term, GFSA's Northam mine will be a major new supplier towards the end of this decade.

Meanwhile, Rusplats has been strengthening its financial position. At year end it held cash and liquid investments of R383,2m (R233,9m). While part of this will be used to finance the new R250m metal refinery in Bophuthatswana — the commissioning date is 1989 — cash is being built up with an eye on market volatility and competition. After the steep climb in the past few months, the price could well be due for consolidation, but until the platinum market weakens, the share looks a good investment.

Andrew McNulty

## OCEANA DEVELOPMENT

### Currency hedge

**Activities:** Investment trust incorporated in the UK and holding an internationally spread portfolio

**Control:** Travpart Investments holds 19,7% of equity

**Chairman:** J J L G Sheffield

**Capital structure:** 5,27m ords of 25p Market capitalisation R98,8m

**Share market:** Price 1 650c Yields 0,8% on dividend, 1,5% on earnings, PE ratio, 66, cover, 1,9 12-month high, 2 000c, low, 750c Trading volume last quarter, 354 000 shares

**Financial:** Year to March 31

	'85	'86
Debt		
Short-term (Rm)	—	1,3
Debt equity ratio	—	0,09
	'85	'86
Return on shareholders funds (%)	4,8	8,1
Investment Income (£'000)	58,2	192,0
Other Income (£'000)	3,3	144,7
Taxed profit (£'000)	17,0	116,8
Earnings (p)	3,2	3,3
Dividends (p)	3,9	1,7
Net worth (p)	67,3	272,6

**Oceana must rank among the purest of rand-hedge stocks on the JSE.** The UK-registered investment trust offers a direct investment into international stock exchanges. Small wonder, then, that since Cape-based Board of Executors gained effective control last August and recapitalised the group with a £10,45m rights issue, the share price has spiralled in the wake of the falling rand from 750c to 1 650c.

Currency gains aside, the company performed well in sterling terms. Net worth rose from 204p after the rights issue to 285p by end-June 1986, with the value of Oceana's

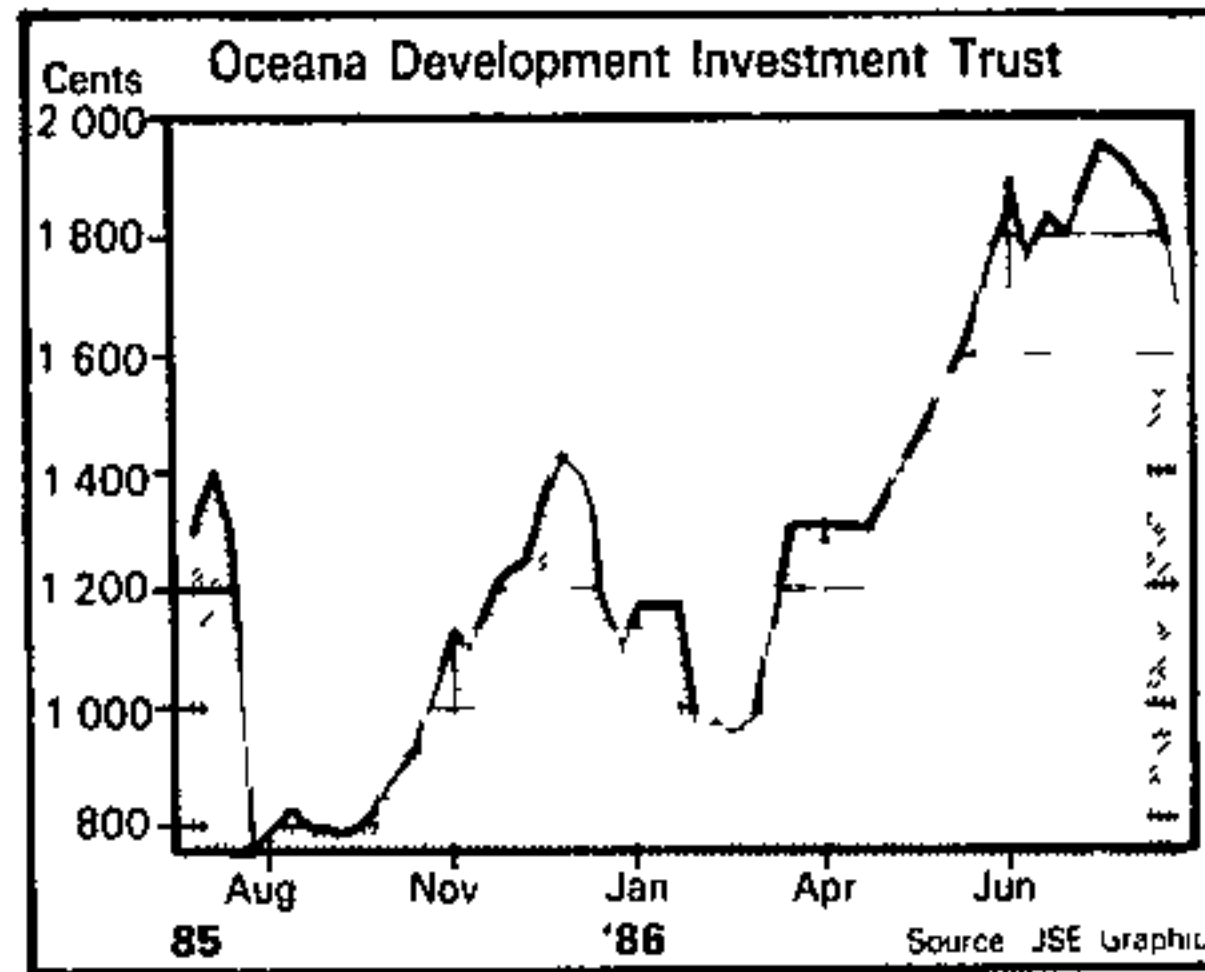

portfolio steaming ahead in the wake of an international equities boom and fuelled by falling inflation and international interest rates.

Oceana aims to achieve "above average total return through capital appreciation and steady dividend growth." Initial investment returns will, however, be relatively low, the directors say. So the counter is likely to be bought for capital gain rather than dividend returns, which last year amounted to only 1,7p, translating in rand terms to a yield of only 0,8%.

However, management says last year's low dividend should not be taken as an indication of future payouts, as the proceeds of rights issue were fully invested for only seven months.

Oceana aims to concentrate its portfolio in "companies with above average growth potential over short to medium-term, and in companies where management is able to enhance profitability through specific action such as reorganisation and rationalisation." It is a strategy suggesting that a high risk-reward profile will be sought. It also implies considerable faith in the investment prowess of joint investment managers Lombard Odier of London and advisers from the Board of Executors, represented by Bill McAdam.

Judging from Oceana's track record in only seven months, the portfolio appears in good hands. The proceeds of last year's rights issue were invested 17,5% in bonds and 82,5% in equities, which was also the portfolio mix at end-March. A sectoral analysis shows 35,8% of equity funds invested in North America, 30,6% in Continental Europe, 8,4% in Japan, and 7,7% in the UK.

Analysed by sectors, the portfolio is most heavily exposed to banking and finance (20,5%), retailing (10,3%), and service and leisure (10,1%). The single largest holding is 1m shares (value at end-March £674 780) in a US-based unlisted financial services company, Wainright Capital Company. Next-largest holding is 7 300 shares (value £635 392) in Cie de Navigation Mixte of France. And the portfolio includes such counters as IBM (£224 904), Merrill Lynch (£281 982), and Salomon SA (£238 414).

Two factors indicate that, at 1 650c, Oceana certainly is not overpriced. Firstly, Oceana's net worth in rand terms, based on the latest figure of 285p, a dollar/sterling conversion of \$1,49, and a financial rand conversion of US0,2015c, amounts to 2 123c, which adequately supports the share

price. Secondly, Oceana trades in London at around 250p, equivalent to 1 862c in SA, which again suggests the share still offers fair value.

Neville Glaser

## BONUSKOR

### No bonanza yet

**Activities:** Investment holding company with interests in timber, forestry, tea, sugar, and energy

**Control:** Rembrandt and Lifegro each own 25% and Volkskas has 26%

**Managing Director:** W J J van Graan

**Capital structure:** 31,3m ords of no par value Market capitalisation R123,6m

**Share market:** Price 395c Yields 1,3% on dividend, 2,7% on earnings, PE ratio, 37,3, cover, 3,96 12-month high, 520c, low, 240c. Trading volume last quarter, 2 501 000 shares

**Financial:** Year to March 31

	'86
Debt	
Short-term (Rm)	2,4
Long-term (Rm)	7,5
Debt equity ratio	0,07
Shareholders interest	0,86
Int & leasing cover	5,80
Debt cover	0,54
<b>Performance</b>	
Return on cap (%)	2,8
Turnover (Rm)	25,4
Pre-int profit (Rm)	4,4
Pre-int margin (%)	6,5
Taxed profit (Rm)	3,8
Earnings (c)	19,8
Dividends (c)	5,0
Net worth (c)	428

\* 6 months

After the major restructuring that has taken place in Bonuskor, the year-end figures are not comparable with previous figures. In addition, the company has changed its year to March, making the reporting period six months.

But there has been very little change since we wrote about Bonuskor in February. When interviewed, MD Wynand van Graan again gave broad indications of the type of company that Bonuskor could find interesting, but no purchases have been made. "We are spending a lot of time on existing investments," he says. "They are not a particular worry to us, we just want to make sure they are settled on a very healthy basis."

The investments must be reasonably

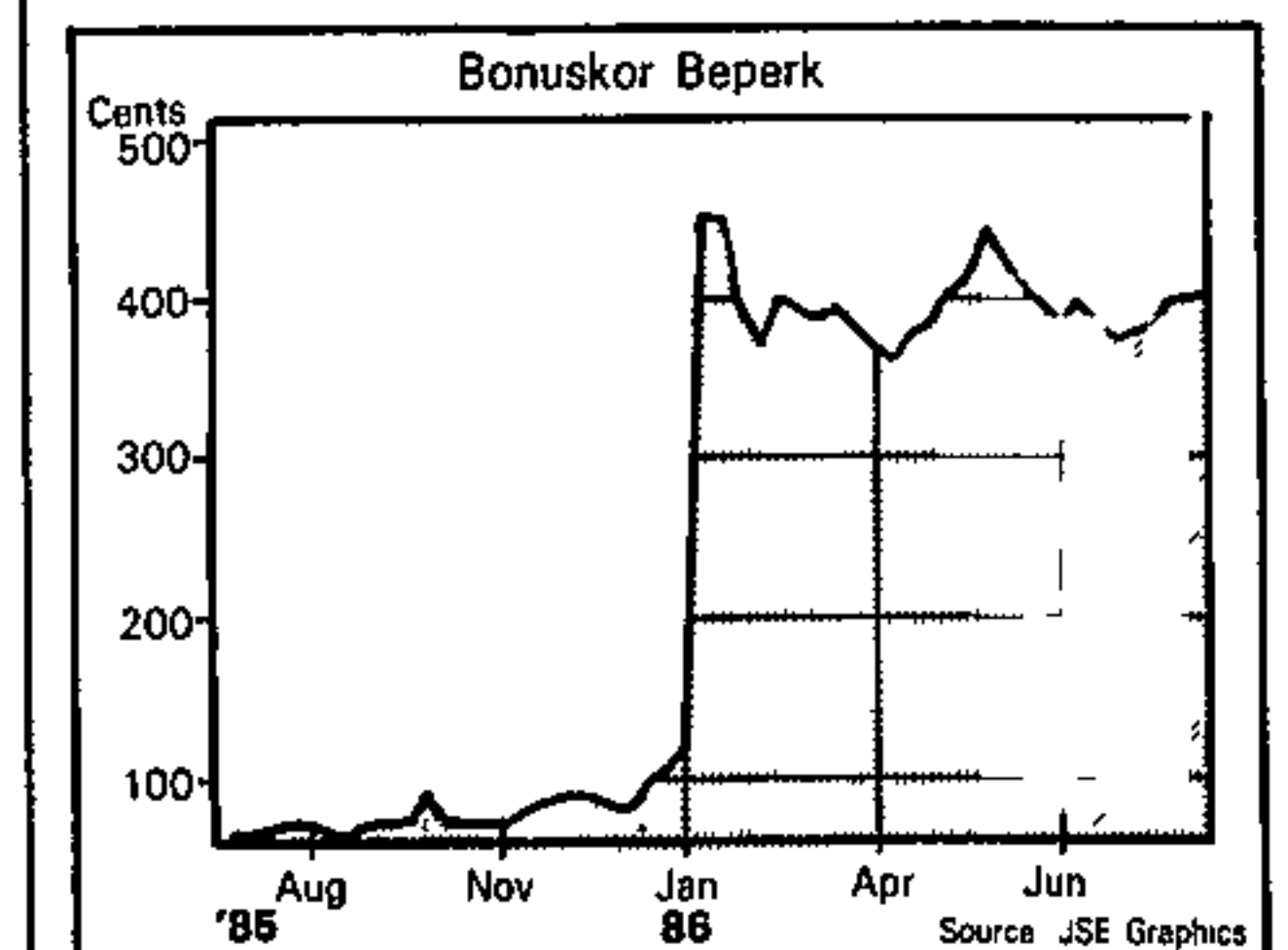



healthy, as they made a profit of 19,8c a share, against the forecast 16,4c. But this still does not give an adequate return on capital. One problem must be the sugar industry.

Bonuskor has a 50% interest in Transvaal Sugar Corporation (most of it acquired from Volkskas, which owns the other 50%) and sugar has not performed well in recent years. The increase in the domestic sugar price, and the expectation that world demand will exceed supply this year, should improve returns in the coming year. Bonuskor has the advantage that its sugar is produced on irrigated farms, which removes dependence upon variable rainfall, and also produces sugar of very high quality.

Bonuskor's other major interests are in timber and tea. There was mention of selling part of this holding, but we understand that Sappi has an option on some of the timber estates. Van Graan says this industry has been hit by recession, but Bonuskor's timber companies are exporting to Europe and an agent has been appointed in the Far East to sell timber products such as flooring. Bonuskor hopes the government's housing programme will lead to increased demand for its products. An interest which Van Graan says is doing well is the wholly owned tea company.

The remaining investment is a 14% stake in Total oil.

Investments at present are valued at R63,7m and interests in subsidiaries at R69m. Van Graan says that Bonuskor can, "without difficulty, lay hands on R20m to R25m on reasonably short notice," but refuses to put limits on the size of investment or to indicate how large the portfolio could be eventually. The very low debt equity ratio certainly allows for higher borrowings and a substantially larger portfolio.

With the share on an annualised dividend yield of 2,6% (1,3% based upon six months' results) against the sector average of 4,2%, a lot of future growth is being discounted. Investors should wait until some of the expected acquisitions have been made before increasing holdings. *Pat Kenney*

## HOSKEN

### Thanks IGI

IGI's turnaround from loss to profit in 1986 could be expected to help the results of holding company Hosken Consolidated (HCI), and HCI duly reported a profit after recording a loss in 1985. At operating level, the improvement appears spectacular. The operating profit last year was R3,7m — a turnaround of R12,2m, which led to an attributable profit of R2,9m after the previous loss of R1,9m.

The improvement was broadly based, but the main reason was the improvement in the negative contribution from IGI. However, after taxation, and when account is taken of the outside shareholders' interest in subsid-

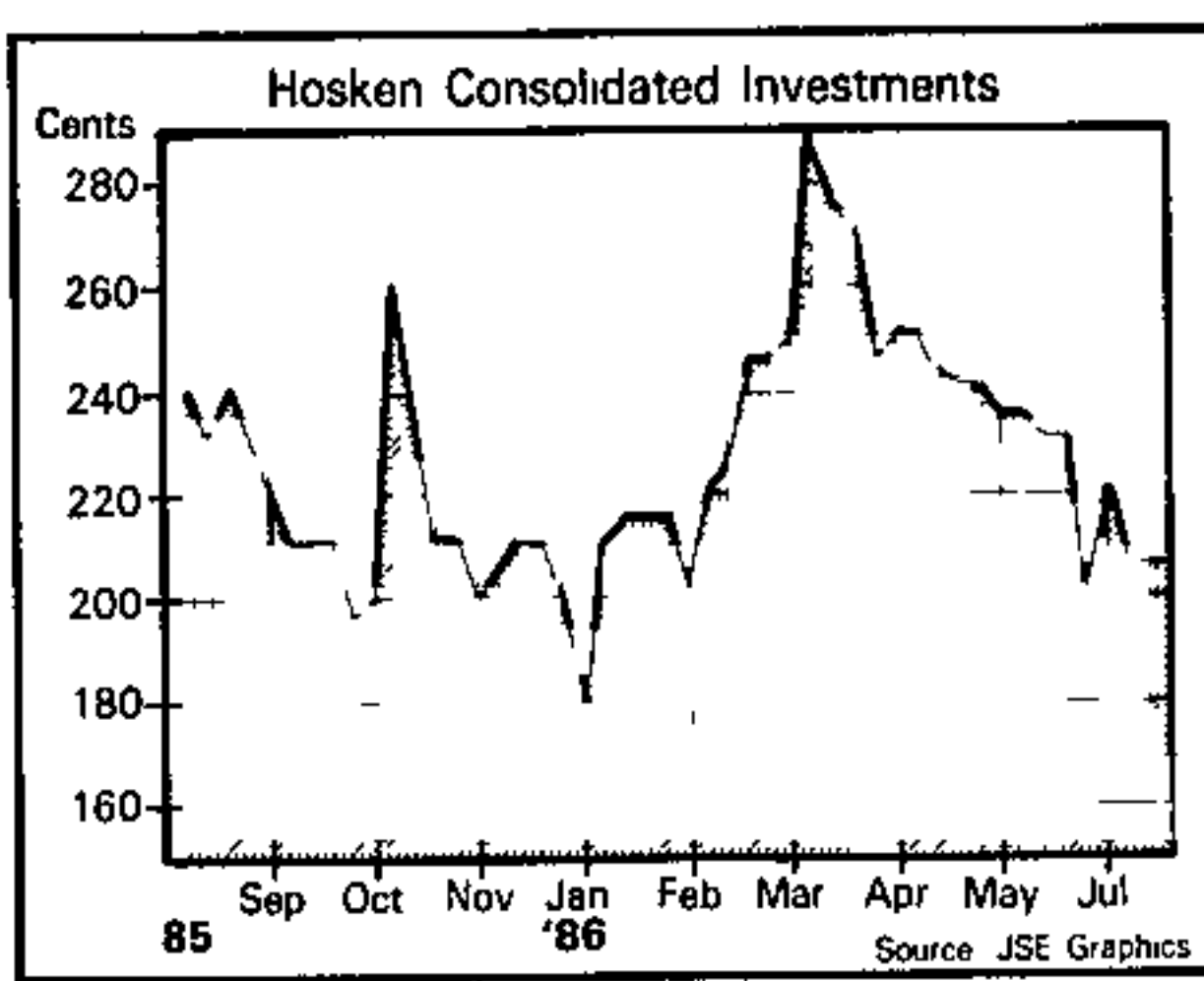

**Activities:** Holding company with interests in insurance, life insurance, underwriting, broking, property administration, and construction.

**Control:** Hosken Family Trusts control 15% and I M A Lewis holds 16%.

**Chairman:** I M A Lewis

**Capital structure:** 9,8m ords of 25c each. Market capitalisation R20,1m.

**Share market:** Price 205c. Yields 6,6% on dividend, 11,0% on earnings, PE ratio, 9,1, cover, 0,6. 12-month high, 290c, low, 180c. Trading volume last quarter, 103 000 shares.

**Financial:** Year to March 31

	'84	'85	'86
Debt			
Short-term (Rm)	8,9	9,4	5,9
Long-term (Rm)	7,9	16,8	16,6
Debt equity ratio	0,42	0,60	0,46
Shareholders' interest	0,39	0,35	0,35
Int & leasing cover	0,49	0,53	1,49
Debt cover	0,60	—	0,15

**Performance**

	'84	'85	'86
Return on cap (%)	9,4	—	5,3
Pre-int profit (loss) (Rm)	9,6	(4,6)	7,3
Taxed profit (loss) (Rm)	5,8	(4,4)	0,8
Earnings (loss) (c)	49,7	(8,0)	22,5
Dividends (c)	11,5	12,0	13,5
Net worth (c)	271	222	249

aries, IGI cost Hosken R334 000, compared with R2,5m in 1985 (FM August 8). Alan Rich & Associates made a positive contribution in 1986 of R45 000 (loss of R450 000) and foreign companies added R1,3m (R1,1m). However, income from foreign holdings rose by only 21% last year, which suggests that much of the improvement was derived from the fall in the rand.

Owing to an issue of shares by Investec in 1986, HCI's holding fell to 14% (it will be reduced further to 10% after the public issue). In 1985, the holding was equity accounted, but in 1986 only dividends (of R446 000) were included.

On the negative side, income from Hosken Brokers was lower at R803 000 (R899 000), expenses were 30% higher and interest paid increased by R2m to R5,6m, despite the fall in debt at the balance sheet date. The effective rate of interest paid, based upon the year-end figure was 25% (13,5%), as borrowings were evidently substantially higher during the year than at year-end.

It is worrying that, although the debt equity ratio is acceptable, debt cover was extremely low. Most of the borrowings are in IGI's property subsidiaries, but HCI also borrowed an additional R3m to put into IGI after the year-end. Obviously, if IGI attains the 20 times increase in earnings forecast by

IGI and HCI chairman Michael Lewis, HCI will benefit enormously. As this is to be achieved by IGI doing its own underwriting there is, however, a risk that any major disaster could eliminate these profits.

As far as Hosken Brokers (which supplied 22% of taxed income) is concerned, Lewis says the present year is "a bit better than last year." New brokers have been acquired and premium increases should also help. The company is budgeting for an increase in earnings of 20%, which would add 6% to HCI's attributable income.

The other big contributors in 1986 were the foreign companies (supplying 45% of taxed profit). Lewis points out that the London-based insurance companies have UK boards and Hosken also has a 49% stake in a Lloyds broker, he forecasts growth in the British profits in the coming year and does not expect adverse effects from sanctions. The Botswana companies should continue to do well and in the local market Investec is forecasting an earnings rise of 20% (FM August 15).

On Lewis's forecasts, Hosken can be expected to show improved profits in the current year, provided that no catastrophes hit short-term insurers. However, a surer and safer way of boosting earnings would be to reduce borrowings. *Pat Kenney*

## FARM-AG

### Into the black

**Activities:** Manufactures, wholesales and exports agricultural chemicals. Distributes agricultural machinery and equipment.

**Control:** Directors own 49,2% of the equity. **Chairman:** R E Sherrell, managing director: L M J R Maingard.

**Capital structure:** 7,84m ords of 50c; 100 000 5,5% cum prefs of R2. Market capitalisation R36m.

**Share market:** Price 460c. Yields 6,9% on dividend, 14,1% on earnings, PE ratio, 7,1, cover, 2,0. 12-month high, 500c, low, 160c. Trading volume last quarter, 860 000 shares.

**Financial:** Year to February 28

	'83	'84	'85	'86
Debt				
Short-term (Rm)	11,3	19,8	16	7,8
Long-term (Rm)	0,4	0,801	0,574	—
Debt equity ratio	1,20	2,10	2,70	0,90
Shareholders' interest	0,28	0,22	0,22	0,25
Int & leasing cover	2,0	0,93	—	2,9
Debt cover	0,18	0	—	0,72

**Performance**

	'83	'84	'85	'86
Return on cap (%)	13,8	5,9	—	22
Turnover (Rm)	59,7	66,5	95,2	58
Pre-int profit (Rm)	4,8	2,6	(5,6)	7,7
Pre-int margin (%)	7,8	3,7	—	13,3
Taxed profit (Rm)	—	(0,19)	(10,9)	5,1
Earnings (c)	31	(3,3)	(66,3)	65
Dividends (c)	20	—	—	32
Net worth (c)	138	134,4	75,2	107,9

Farm-Ag's disposal of its agrochemical retail division in 1985, and the subsequent reorganisation of group activities, has restored health to the balance sheet. An attributable



CWG Trip  
(217)  
26/8/86

# Holding the mineral card

Please don't quote me  
BY WILLEM STEENKAMP

A READER asks: "This business about huge new discoveries of platinum and vanadium — does it mean anything or is it another piece of we're-all-right-Jack hype by the government to prepare us for sanctions?"

The answer is that it is no hype. I know the old saying to the effect that there are statistics, more statistics and damned lies, but there is no doubt that the new discoveries have strengthened the government's hand.

Even before the new discoveries South Africa held the world's greatest reserves of platinum, chrome, vanadium, gold, manganese and fluor spar. For example, 86 percent of the world's entire supply of platinum was found here, 83 percent of the world's chrome ore, 64 percent of the vanadium, 49 percent of the gold, 48 percent of the manganese ore and 46 percent of the fluor spar.

More to the point, the non-communist world was almost totally dependent on South Africa as a primary source of these materials. A staggering 99 percent of the non-communist world's platinum comes from South Africa, 96 percent of the vanadium, 84 percent of the chrome ore, 61 percent of the gold, and 50 percent of the fluor spar; not to mention 92 percent of the diamonds.

In addition, of course, the whole thing is tied into international power politics. Unlike the non-communist countries, Russia is, largely self-sufficient in the essential minerals. If Russia were to suck South Africa into its sphere of influence, or if South Africa were to clamp down on the export of these minerals, the only people to score would be the men in the Kremlin.

One strategic writer says: "Should the USSR ever be in a position to control their cost or to deny their production to the West, they would have succeeded in striking a blow that could well cripple Europe's industrial economy as well as gravely damaging that of the USA."

In the short term such a blow could well prove fatal in undermining Europe's will to resist Soviet domination.

This will be even more the case when the new reserves come on stream. That is why the government's not-so-veiled threats to institute a vital minerals boycott in retaliation for sanctions sent terror rippling up and down a lot of influential overseas spines.

There is the local Gasa branch, which in addition to services such as liaising with Lifeline and counselling on Aids, also runs women-only socials at its premises every second Friday night.

**The answer**  
IT HAS been drawn to my attention that I left a vital bit of information out of my item the other day about the school-age youngsters who tried to panhandle ticket money for the cafe-bio out of the other day when they should have been at school.

**Final word**  
A FINAL word on local organizations catering for gays, homosexuals, lesbians or people of alternative sexual orientations (I am not trying to be funny it is just that a catchall term that satisfies everybody is hard to find).

Conclusion people like these still have an acceptability problem

Heterosexual readers who have been following

# Platinum boosts earnings at JCI

SMK 217  
27/8/86  
By Gareth Costa

Johannesburg Consolidated Investments reflected the good results of its platinum and gold mining companies, but these were tempered by non-mining interests, as earnings increased by 37 percent to 2778c a share for the year to end-June.

The final dividend has been lifted to 875c, equalling the total for last year, and boosting this year's total to R12 a share. JCI director Mr Vaughan Bray says that about a 50 percent of the increase in income from investments was from Rustenburg Platinum, 25 percent from Randfontein and 25 percent from its diamond interests.

He adds that the contribution of non-listed industrial arm Lennings fell, five percent drop, while the Toyota and newspaper investments were too small to reflect either way.

Pre-tax profit was 46 percent higher at R258 million, while after tax profit was only 34 percent up at R209 million following a jump in a tax from

R19 million to R48 million

Mr Bray says that they are looking forward to another good year, as long as the political situation does not deteriorate further. On the expansion side, are the Joel mine and the Doornfontein developments, while there are no non-mining expansions on the cards.

Platinum and gold should again make a healthy contribution at year-end as it has surged strongly on world markets in recent weeks.

The net asset value of the shares has jumped by 68 percent to R484 a share based on market ratings and directors valuations, while the shares are trading at a premium to this at R510.

The shares are yielding 2,3 percent on the dividend of R12, while the PE ratio is 18,4, compared with the historical 23 on past earnings. However, the shares have risen sharply in the past few months, and the share price probably already discounts these results.



# Platinum Nobles shortage

28/11/86  
217  
BUDDA  
STRATEGIC hoarding of platinum by the US, France and Japan has resulted in a shortage of platinum Noble coins.

CHERYLYN IRETON

Demand for the 1oz coin now exceeds supply by about 20%, says Investment Exchange broker Tony Wentzel. The current market shortage is expected to result in delivery delays and price variations for SA buyers because the coin is struck on the Isle of Man.

"The US has a stockpile of platinum-group metals worth about \$340m. This has been regarded as in-

sufficient by the National Security Council. France and Japan have also started strategic stockpiling and the Europeans are buying more metal for catalytic converters," Wentzel says.

These factors, coupled with increased industrial demand, will continue raising the platinum price, he adds. The sanctions threat hanging over SA has aggravated the shortage.

Johnson Matthey platinum product manager John Smith confirms that Nobles have proved popular.

## Platinum price in August

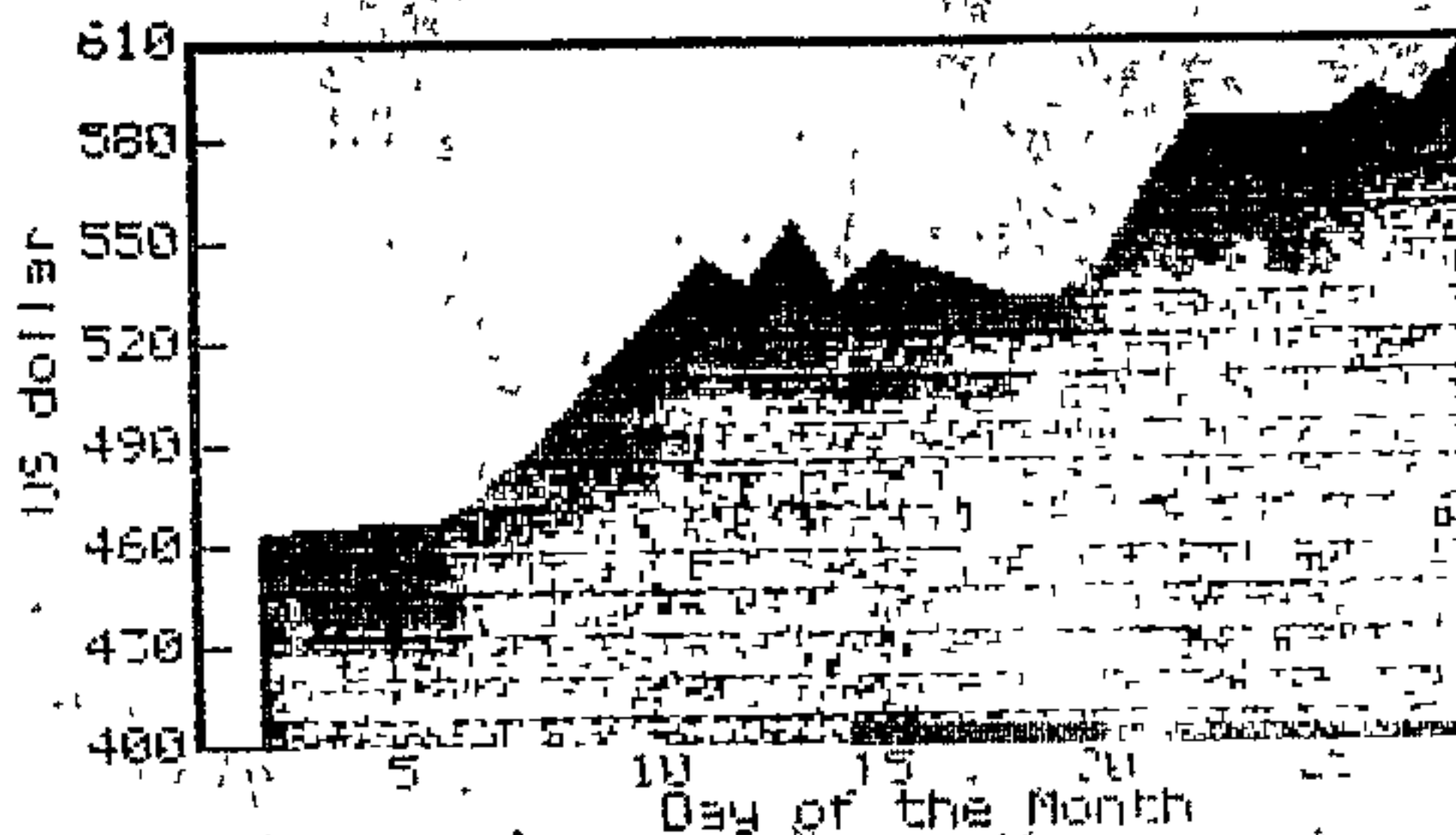

# SPAK Platinum jumps to a (217) 29/8/85 six-year high of \$602

LONDON — The price of platinum jumped above \$600 an ounce yesterday, its highest in six years, as speculators shrugged off warnings that the market might drop.

A year ago platinum cost \$340 an ounce. It hovered around \$599 in London yesterday morning then New York took it to \$602. It has risen \$100 in less than three weeks.

Impala Platinum followed the boom in the price and announced a 26.3 percent increase in its platinum producer price for the first time since August 1980.

The producer price now stands at \$600, compared to the previous \$475.

The platinum price first climbed on fears that South Africa could retaliate against possible sanctions by cutting sales.

But prices now are largely decided by speculators lured by

its volatility and the possibility of huge gains as the price swings.

"South African production risks are really just a psychological factor — an excuse for speculator fever," said Mr. Brian Nathan, managing director of precious metals dealers Ayrton Metals.

Mr. Nathan said he believed the market was due for a price correction now that platinum had breached \$600, seen as a psychological barrier by most dealers.

"Once people see prices moving up so quickly they jump on the bandwagon. Last week we were seeing about a quarter of world annual production passing through speculators' hands."

Earlier this year a report from London bullion dealers Johnson Matthey put South African platinum output in 1985 at 2.32 million ounces. Demand had risen to 2.80 million. — Reuter



bulk of profits in the Christmas-boosted second half

Bearing in mind the group earned 103c in the second half last year, that trading in all main divisions appears to be running ahead of 1985, and that both debt and interest rates are falling, W & A should comfortably earn 200c this year. That puts it on a forward earnings yield of 22%, and assuming three times cover, a dividend yield of 7,2% — a rating that may be far too harsh for a company on a recovery trend whose share price is a 36% discount to asset value.

While operating income remained static at R23,2m (R23,3m), the sharp fall in finance costs to R9,5m (R18,8m) saw pre-tax income spiral to R10,85m (R1,77m). With debt significantly reduced since December, the debt equity ratio has fallen from 78% to 69%, a far cry from the 110% of barely a year ago.

Attributable profit was R4,24m (R1,24m loss), which was boosted by extraordinary profits of R6,22m on the sale of shares in Hallite and Jazz Stores.

The curious fact is that most major subsidiaries had already reported, yet still the market seemed to underestimate performance. One reason could be that while most are listed, some important earners, such as W & A Distributors, lie tucked in unlisted corners, away from analysts' eyes. Another reason could be the group's complex structure, which was recently reorganised.

The newly constituted subsidiary, **Hunts**, produced strong earnings, largely reflecting stable returns from its 60% holding in **General Tyre** and vastly improved returns from its 81% of **E W Tarry**, which now contains the **Williams Hunt** motor division. **Williams Hunt** sells GM cars which, after a lean spell, have been gaining market share.

Higher up the group structure, **World Furnishers** reported a sharp turnaround, based partly on improved trading conditions, and partly on an improved financial structure in the wake of raising some R10m by selling shares in **Jazz**. Interim profits were R1,01m, virtually matching the R1,09m for the whole previous year.

The other furniture subsidiary, **Bradlows**, reduced its interim loss to R213 000 (R897 000), and is expected to return to profit in the second half.

On the strength of the overall performance, W & A could be due for rerating.

Neville Glaser

**GOLD/PLATINUM**

**Shares running**

The JSE All Gold index is pushing towards the 1 700 level, spurred on by foreign buyers encouraged by the improved outlook for gold, and local buyers climbing into what they see as a rand and sanctions-proof investment hedge. A number of JSE analysts feel the gold shares are generally fully valued at present, and further increases in the dollar gold price are needed to justify continued

purchases — but they also expect to get further increases, which means the gold index looks set to climb even higher.

Some analysts caution, however, that there are bound to be corrections along the way, and there are a couple of potentially bearish jokers in the gold share pack. These include the possibility of strike action on the gold mines, and the chances of a recovery in the rand or the US dollar. The improvement in the dollar gold price, which has coincided with drops in the major overseas stock markets and falls in the value of the dollar, has encouraged overseas investors to start looking again at South African gold shares.

"Our shares are cheap viewed in terms of their currencies — in fact, bargains when the yields on offer are compared with those of Canadian and Australian gold producers," comments one analyst with an institutional broking firm. "European and American investors have started buying the shares for the first time in months, which is encouraging given the continuing sanctions debate."

Says another: "The fact that the rand has not recovered along with the gold price proves the policy of a managed rand float is a myth. The currency is being kept right where it is by the Reserve Bank to maximise export revenues and to try to correct some of the problems caused by the mess the economy is in. This is a structural change to the investment situation which is being appreciated by local investors."

Gold at \$380/oz and the rand at US38c works out to R32 151/kg in revenue for the gold mines. This means the current September quarter will again produce some bumper results from the gold mines and, with prospective dividend yields of up to 10% on offer, it's difficult to fault a decision to buy gold shares.

Amid the bullish pronouncements, a note of caution was sounded by a bearish portfolio manager: "I can't argue with the trend in the gold price and I see the gold price moving between about \$370/oz and \$430/oz. However, I cannot accept the overwhelming opinion that the rand will stay at current levels with no chance of a recovery and neither can I accept that the dollar is as bombed-out as everybody says."

Another gold analyst believes that the JSE gold market is currently overheated and there could be a short-term correction.

The platinum market is more complicated, with differing opinions on how long the party can last. "There is a day of reckoning coming for speculators in platinum," prophesies Fergusson Brothers' analyst Derek Ritchie. "The price has been driven up through speculation, verging almost on hysteria, that SA would hold back metal supplies in the event of sanctions. Last week's White Paper on mineral strategy ruled this out and anyway platinum, unlike gold, is marketed by the individual companies and not the Reserve Bank."

"A disruption to supply is just not on. Rustenburg and Impala shares could well go to the R60 level but at that point investors

should take profits," he advises.

Another precious metals analyst agrees with the concern about speculative buying but points out that for foreign investors buying platinum shares the only real options open are Rustenburg and Impala. "If they decide to rate these shares as they rate Australian gold shares and accept those kind of low dividend yields then the prices could stay very firm," he says.

Brendan Ryan

## SPECTRUM INDUSTRIAL

### Joining the DCM

On October 16 Spectrum Industrial, trading under the names General Industrial Supplies (GIS) and Hardware House (HH), plans to join the 13 companies already listed on the development capital market (DCM). Unlike recent DCM listings, a public rather than private offer is being made, giving the public an opportunity to get in at ground floor.

The two divisions, GIS and HH, are situated in Alrode and Isando, and supply parts used in the installation and maintenance of industrial equipment. MD Steven Swersky (32) and financial director Brian Benjamin (31) tell me that the purpose of the listing is to fund growth and expansion in a market niche they believe has good future potential. Given the size of the company, the directors believe the DCM is the ideal vehicle for this.

Spectrum currently has no outside financing apart from director's loans and occasional use of overdraft facilities. This suggests the company is highly liquid. Lead times in which debtors are financed are on average 30 to 60 days, depending on the size of client — an indication of solid cash generation. Over the past five years, turnover has grown by an annual 20%. Turnover to end-December 1985 was R3,4m and an audited R2,1m for the six months to June 1986. Income before tax was R346 000 for the year to end-December, and R289 000 in the six months to June.

Originally founded in 1955 by Swersky's father, Spectrum began trading as GIS in 1973 and merged with HH in 1979. Management says the merged operation enables the company to buy in large quantities without having to approach wholesalers. By doing so, they claim Spectrum has been able to steal a march on competitors. Its wide spread of clients, from multinationals to "one-man-bands," has apparently shielded Spectrum from downturn in the manufacturing industry. Computerised accounts receivables enables tight credit control. And because of the large stock holding of some 10 000 items, the company is said to have gained a reputation for quick and efficient service.

Most of the items such as fasteners, abrasives, piping, valves and hoses, measuring instruments, various tools and hydraulic equipment, don't become dated. Staff complement, including sales reps, is 44, of whom 11 joined in the last six months as Spectrum geared up for an increased volume of busi-



# Platinum outshines gold

30/8/76 STM  
ZURICH — The price of platinum, trading at a six-year peak, was taken yet higher yesterday, chiefly by speculators who seem to prefer it at the moment to their usual precious metals favourite, gold.

A year ago platinum cost \$340 an ounce. It changed hands yesterday at \$636 after breaking through \$600 on Thursday.

Although it slipped later yesterday to around \$620, dealers said the trend stayed firm. But some market analysts predict a reaction sooner or later. They say no fundamental change in the supply/demand outlook underpins the climb.

Fears that South Africa, source of 80 percent of the West's supply, might cut sales in response to any economic sanctions were earlier quoted as the trigger for the rise. But several dealers said it was now being driven more by speculators seeking profit in a rising market.

"It is all just a snowball effect," said one dealer at a major Swiss bank, noting that the price of platinum, which usually moves in concert with gold, had risen faster.

"Sooner or later there is going to be an enormous reaction downward," said another dealer. Gold was dragged up a little by platinum yesterday, then fell back on profit-taking. It was fixed in London at \$386, little changed from Thursday night.

217  
The increases have been amplified by the small size of the platinum market in relation to that for gold.

Dealers put annual output at only around 85 tons, of which some 80 percent is tied into contracts between producers and industrial users. That leaves the free market with a tiny 15 tons or so to trade.

"If one ton of platinum changes hands, it can send the price up as much as \$20," a dealer said. "In gold, the same size sale will produce a rise of just 50 cents."

Analysts are divided on whether the boom will persist. Mr George Nickas of trading company Geldermann in New York said night he "still saw more room on the upside for platinum."

Mr Martin McNeill of Dominick and Dominick said traders "see no reason for platinum to go through a big downside correction as long as the political situation heats up in South Africa".

But others say platinum's present premium over gold, the largest ever in percentage terms, cannot be kept up for long.

"With the price so high, it will be difficult to find buyers if a few substantial holders decide to sell," a dealer said.

Around a third of world supplies of platinum go into the car industry and another third into jewellery. Electronics and chemicals also use it. — Sapa-Reuter

1  
2  
3  
4  
5  
6  
7  
8  
9  
10  
11  
12  
13  
14  
15  
16  
17  
18  
19  
20  
21  
22  
23  
24  
25  
26  
27  
28  
29  
30  
31  
32  
33  
34  
35  
36  
37  
38  
39  
40  
41  
42  
43  
44  
45  
46  
47  
48  
49  
50  
51  
52  
53  
54  
55  
56  
57  
58  
59  
60  
61  
62  
63  
64  
65  
66  
67  
68  
69  
70  
71  
72  
73  
74  
75  
76  
77  
78  
79  
80  
81  
82  
83  
84  
85  
86  
87  
88  
89  
90  
91  
92  
93  
94  
95  
96  
97  
98  
99  
100



By Udo Rypstra

PLATINUM — the trump card in South Africa's precious-metal pack — has caught the imagination of investors and prompted a Johannesburg coin dealer to strike his own medallions.

Heinz Buttkewitz's National Gold Coin Exchange has been minting the Baron (10 ounces), the Portfolio (one ounce) and the Earl (half-ounce) since the middle of June this year. Turnover exceeds R2,5-million.

### Hoarding

By the end of the year, Mr Buttkewitz hopes to have sold 10 000 ounces of platinum for more than R18,5-million.

Although they look like coins and super-size medallions, they are called bullion bars. The current price of the one-ounce bullion bar is R1 850. But Mr

# Over-the-counter platinum booms

sum  
MR BUTKEWITZ - 31/1/86  
217

Buttkewitz forecasts that the price will rise to between R2 000 and R2 500 next year because of hoarding by international investors.

Unlike the Noble, the British one-ounce platinum coin which has to be ordered, Mr Buttkewitz's bars are sold over the counter and cost about R100 an ounce less.

The free-market price of platinum has increased from \$450 to \$594 an ounce this month. Several nations, including the United States and Mexico, are minting Noble-like coins to capitalise on soaring demand for platinum.

Johnson Matthey, the British refiner, says investors hoarded about

260 000 ounces of platinum last year — a 53% increase on 1984. Market analysts see investors' holdings increasing again this year.

Mr Buttkewitz says that propelled by rising industrial demand and unrest in South Africa, platinum's price has surpassed gold's after lagging behind for years.

Futures prices have also increased dramatically, and analysts expect them to pierce \$600. However, some warn that the boom could end soon. They contend that SA output will rise in the next six months and industrial and investor demand may fall.

Mr Buttkewitz rejects that opinion.

He says that vast new platinum reserves evaluated in the Northern Transvaal's Merensky Reef will not add to the supplies until the end of the century. Apart from investor hoarding, he expects increased demand from the American car industry and the Japanese jewellery trade.

He predicts profits of between 60% and 70% for the next year or two on platinum investment and claims some of his clients have made a profit of 20% and more in recent weeks.

He says the 10-ounce bar is the most popular. Mr Buttkewitz has kept a low pro-

file with his new venture. "I like it that way," says the German-speaking businessman, who wears corporate attire complete with con-like epaulettes — "to show that we are not afraid to say who we are." His staff members also wear corporate uniform.

Sales in the last two weeks of June amounted to 73 ounces of platinum, followed by 300 ounces in July. August sales rocketed to more than 1 500 ounces, one client ordering 600 ounces.

### Expansion

Mr Buttkewitz says he is setting up five branches and will have a maximum of seven brokers in a year's time.

He does not believe in buy-back guarantees and certifies of proof to boost sales. He says the platinum content mark "999,5" is on the bullion bars and "is worth more than a piece of paper. We do not pretend there is any collector's value involved — we are merely dealing in an investment commodity."

# Speculators push platinum price to six-year peak

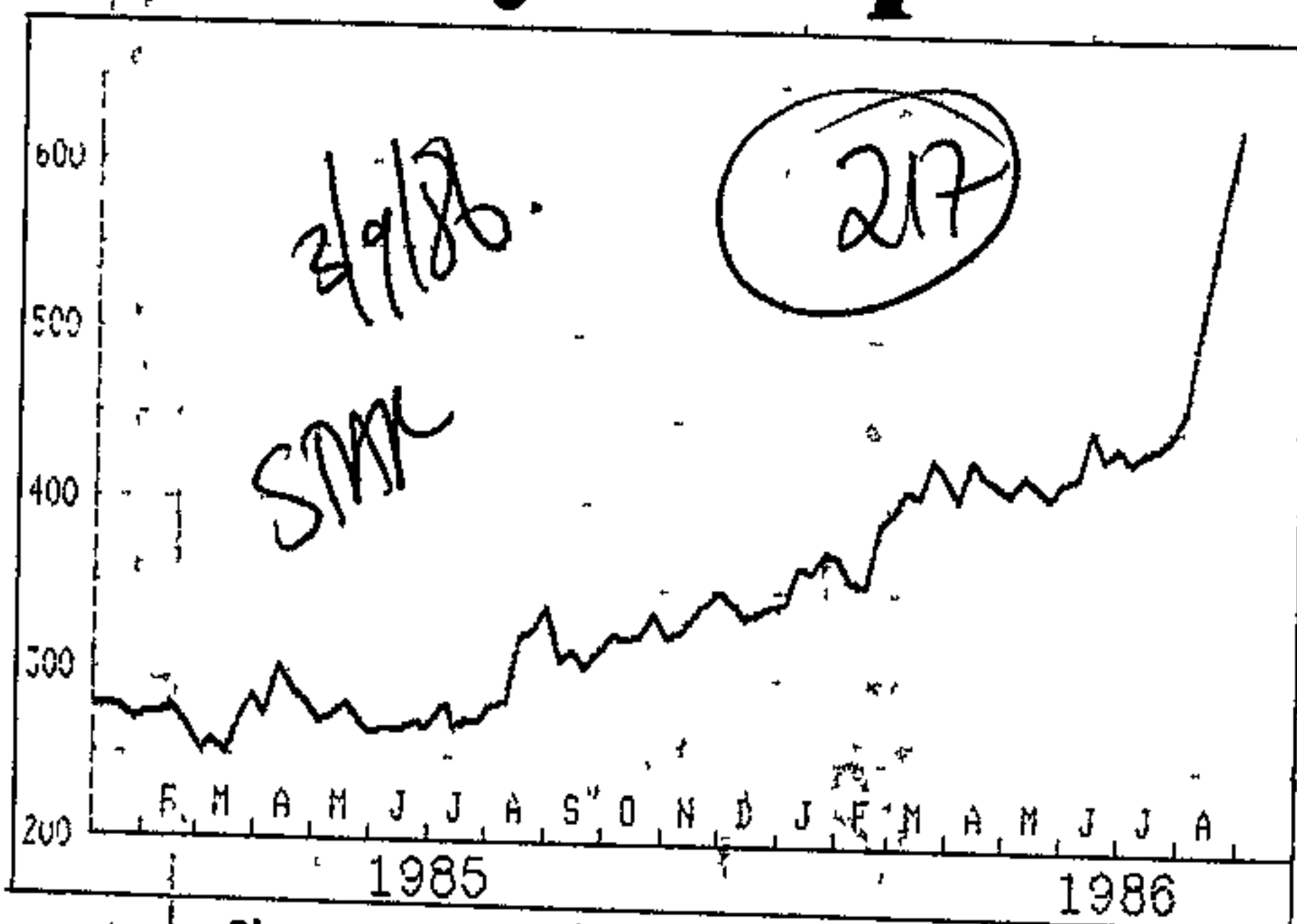

Platinum price in dollars — Graph: Simpson Frater.

By Neil Berhmann

LONDON — Platinum prices surged to a six-year peak of \$658.50 an ounce in London, before easing to \$640 yesterday.

The price was \$480 at the beginning of last month and around \$245 at the beginning of 1985. It briefly hit an all-time peak of \$1,050 an ounce in January 1980.

"The market is in the hands of the speculators — dangerously volatile," says Mr Brian Nathan, managing director of Ayrton Metals, London platinum merchants. He adds that daily platinum futures volume on the New York Mercantile Exchange at 500,000 to 800,000 oz a day is equivalent to about a quarter of annual platinum consumption.

Platinum prices are standing at a premium of 63 percent to the gold price of \$393. When both metals were depressed early last year, platinum was trading at a discount of 14 percent to gold.

Prices surged mainly on fears the Government would slash platinum exports to counter sanctions and violence and strikes on the mines would limit supplies.

The rush into platinum has also pushed up the price of by-products: rhodium and palladium. Rhodium jumped to \$1,300 an ounce from \$600 last year and palladium rose to \$145 from \$112 in July.

Platinum began rising early last year because demand from Japanese jewellers, automobile manufacturers and other industries exceeded supplies, says Mr Alan Austin, manager, platinum marketing division at Johnson

Matthey, precious metals refiners and distributors. European automakers, he says, were following their US counterparts and were beginning to buy platinum catalysts to reduce noxious exhaust fumes.

But investors tipped the balance and when the South African political climate deteriorated prices took off.

Mr Austin estimates investment purchases of coins and bars of platinum are running at an annual rate of 400,000 to 500,000 oz, against 150,000 to 200,000 oz last year.

Few dealers are prepared to forecast a crash.

"Given the deep-seated belief that there will be supply disruptions in South Africa, it is impossible to say how high platinum prices will rise," says Mr Edwin Arnold, metals specialist at Merrill Lynch Pierce Fenner & Smith. The market is volatile, potentially illiquid and dangerous, he says, because annual supplies of around 3 million oz compare with a gold market of around 39 million oz.

"The platinum market was fundamentally sound under \$400, now it is trading in a virtual vacuum," says Mr Tony Harrison, precious metals dealer at Paine, Webber International Futures, in London. He adds that speculators could boost prices to \$700, but if they suddenly decided to take profits, sellers could find few buyers.

"We are not taking any chances and are switching clients from platinum into gold," says Mr Neil Buxton, metals analyst at Shearson Lehman Brothers in London.



10/9/86  
BUDDAY

217

## Waddell hints at Rusplats bonanza

Investment Staff

RUSPLATS (Rustenburg Platinum) chairman, Gordon Waddell has again hinted to shareholders that record profits are on the way.

The higher rand price received for platinum in July and August enabled Rusplats to earn profits substantially higher than those of the same period last year.

At the annual meeting yesterday Waddell said this trend was likely to continue as long as Rusplats received current rand prices and maintained its volume of sales at a level similar to that of last year.

In the year to June, higher platinum prices helped boost Rustenburg's taxed profit by 64% to a record R258,2m.

In his annual review in mid-August, Waddell said that, if levels of demand and the rand prices obtained in July continued, Rusplats' profit would again increase.

scale in 1949

The company's boldness in the face of apparent adversity stems from the fact that its customers retain ownership of the platinum contained in any catalyst "The customer furnishes the platinum," explains the firm's senior vice-president, marketing, Warren Sedlacek "We then charge a price for a catalyst which has the customer's platinum on it" The only platinum which UOP, under normal circumstances, actually owns is a relatively insignificant residual stock to help smooth dislocation in the supply chain

At the end of the catalyst's working life (anything from two to 13 years, depending on application), UOP offers to recycle it, on the customer's behalf, achieving a platinum recovery rate of about 99.5%

The platinum used in the process is like a capital asset for the customer, says Sedlacek "No-one could afford to use a material as valuable as platinum in catalysts if you could not recycle it," he adds

In a typical naphtha reforming catalyst containing 0.3% of platinum, the metal would account for 70-80% of total value at today's price levels, compared with 55-70% a year ago Recycling enables the customer to recover the bulk of this portion of the initial outlay — with the additional possibility of windfall profits (or market-related losses)

The high recovery rate of platinum used in platforming catalysts also goes a long way towards explaining the petro-chemical sector's relatively low proportion of total platinum consumption According to estimates by J Aron & Co, the industry's 1986 take-off of new platinum is expected to reach 234 000 troy oz, compared with 980 000 troy oz in the automotive sector and 714 000 for jewellery

Experts calculate, however, that between 3m and 4m troy ounces of platinum is currently dotted around the Western world, on naphtha reforming catalysts — comfortably more than a year's Western world mine production In addition, industry sources state that approximately 600 000 troy oz are recovered annually from spent catalysts, with the bulk of it duly fed back into the system

The jewellery industry is not unduly concerned by platinum's bull run either

"By the time the price filters through to the customer, the platinum costs tend to be swamped not only by the value of the gemstone, but by the casting as well," says Peter Schneila, a divisional vice-president of Tiffany, the New York-based jewellery com-

pany "At this point we are not passing any extra costs along to the customer, because we don't really need to," he added

The company, it seems, maintains a stockpile sufficient to meet its needs for "a number of months" as a buffer against extreme market fluctuations "If the current trend goes on for some time we may have to re-evaluate our purchasing position," says Schneila

Tiffany maintains that the rocketing price of platinum is not making inroads into sales. However, Japanese trade statistics indicate that this is not universally the case. They show that Japanese imports of the metal were down over 30% from a year earlier during the January to July 1986 period.

Among US car manufacturers, which are being forced to launch a programme of cut-price financing to clear the backlog of unsold vehicles, the rising price of platinum (used in

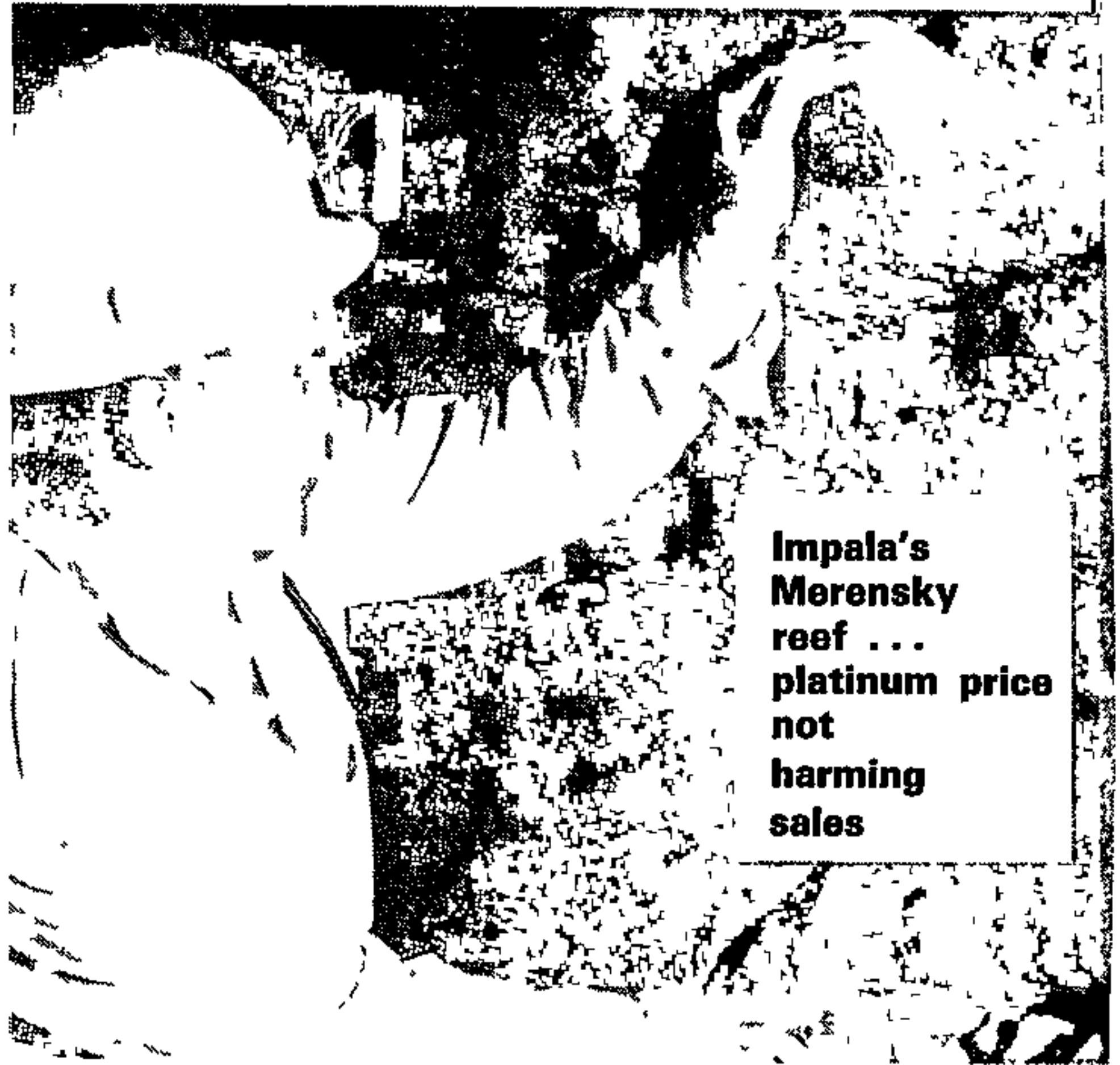

Impala's Merensky reef ... platinum price not harming sales

## PLATINUM

### Buyers unfazed

With platinum prices continuing to scale fresh five-year peaks, one might expect these to be worrying times for consumers of the metal. But platinum users in a range of industry sectors have been contemplating recent market developments in a mood more of resignation than panic

In the jewellery and automotive sectors, this low-key reaction is due principally to the small proportion of overall costs directly attributable to platinum. In the petrochemical industry it is because the near total recoverability of platinum used facilitates the operation of a system whereby the customer effectively bears the market risk

Platinum-bearing catalysts are used to convert low octane naphtha into high octane gasoline, in a process called "platforming". The technique was pioneered by Illinois-based UOP (still one of the major sources in the market) and introduced on a commercial

catalytic converters to clean exhaust emissions) is hardly the most pressing concern.

However, with demand for platinum in the automotive sector set to rise in the short- to medium-term in response to increasingly stringent emission control standards — particularly in the EEC — security of supplies is perhaps more of an issue than in either the jewellery or petro-chemical industry. Certainly the recycling of spent catalytic converters, though on the rise, is not yet as important a factor as is the reprocessing of platforming catalysts in the petro-chemical sector. Both General Motors and Ford obtain platinum for their US operations on long-term contracts

But UOP's Sedlacek implies that the low proportion of platinum irretrievably consumed in any of its major applications renders the threat to security of supply remote "There is a hell of a lot of monetised platinum around, which is always available at a price," he maintains "I don't think we are going to see no platinum for use in catalysts — just high-priced platinum"



# sunrise finance

# Gold and platinum bounce back strongly

13/9/86  
SMK  
217

LONDON — In an abrupt reversal of the trend so far this week, gold and platinum advanced strongly yesterday as investors sought refuge from a tumbling stock and bond market.

Gold was fixed in London at \$418.75 ounce, or \$13 above yesterday's close, and it later traded at \$423 — within sight of the three-year traded high of \$425 reached a week ago.

Platinum rebounded to a London fix of \$600 an ounce, some \$30 above Thursday afternoon's fix, though still well below the six-year fixing high seen last Friday of \$673.75.

Analysts at leading London banks and bullion houses, most of which have expected a broadly upward trend for precious metal prices, saw today's rise as a reaffirmation of their belief after a week in which it has been tested sorely.

"The market has seen a few little upheavals recently ... but we are in a bull phase," said Graham Birch, a bullion analyst with stockbrokers Kleinwort Greaveson and Co.

A wave of profit-taking and speculation, particularly evident on the volatile New York futures market, has taken gold as low as \$400 and platinum down to \$560 an ounce this week.

The catalyst for gold's upturn was a sharp fall in stock and bond prices on New York's Wall Street Thursday night and then a rapid sell-off on the London Stock Exchange.

"A dreadful performance on the stock market normally stimulates stores of value like precious metals," Birch said.

Also boosting gold, and weighing on the bond market, were fears of an upsurge of inflation — although the rise in US producer prices in August, announced early in the European afternoon, were fractionally below expectations at 0.3 per cent.

Analysts were more puzzled by the upturn in platinum, as many had predicted that it would consolidate around the mid-\$500 level.

A senior gold market source said "Platinum fell so heavily in the last few days that some correction was inevitable."

Dealers said platinum was looking for a price level at which to consolidate after its recent violent movements, but it was too early to tell whether this had been found. — Reuter.

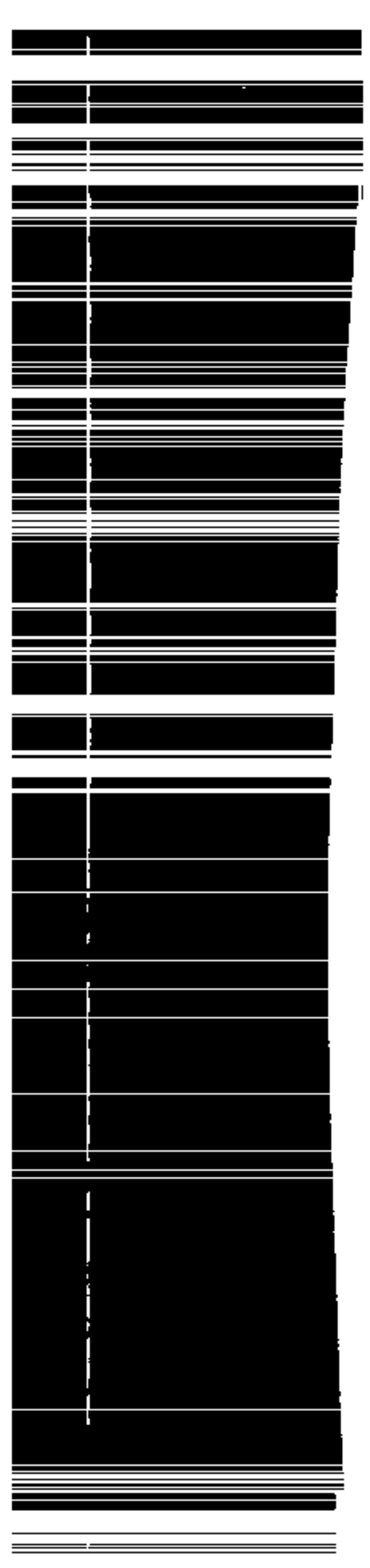

# Aussies hold back on platinum project

By Allan Dunn

MELBOURNE — The chance of gaining a share of the world platinum market dominated by South Africa has precipitated a bitter row within the Australian Government.

Some members of the Government, including Prime Minister Bob Hawke, are keen to allow mining for platinum and gold in the Kakadu national park, a

magnificent but remote wilderness area near Darwin.

It is known that there are some very promising platinum deposits there and Hawke and some of his colleagues see revenue from them as a vital boost to Australia's trading deficit.

Australia has no platinum mines but the Government is well aware that South Africa, which produces 80 percent of

world requirements, may use this near monopoly as a bargaining tool in any sanctions war.

Australia would like to be in a position to supply any needs which might arise if South Africa were to limit platinum supplies.

But the left wing of the governing Labor Party is opposed to any mining in the park, insist-

ing that the area be left undisturbed.

It seems the left has won the day, for the moment anyway, because the Government has decided there will be no mining in most of the park.

But some companies hold leases granted several years ago and if they should decide to exercise them it would cause a split in the government.



R70m deal made for TVL project

# Rand Mines sinks money in platinum

217

25/9/86. BUDDAY

A PLATINUM mine is expected to be established near Steelpoort, Northern Transvaal, after yesterday's R70m deal between Vansa Vanadium and Rand Mines.

The mine could come on stream by 1992 if feasibility studies show the platinum-bearing reefs on the Kennedy Vale farm can be economically mined.

In terms of the deal, Rand Mines acquires 42% of Vansa and becomes the dominant party in the envisaged mine.

Barlow Rand's mining arm has swapped a 99,9% holding in its Winterveld chrome mine, situated 11km from Kennedy Vale, for the stake in Vansa.

The green light to develop the mine will not be given until mid-1987 when results from drilling and feasibility studies will have been examined.

Initial drilling results of the Merensky and UG2 reefs were sufficiently encouraging for Rand Mines to agree to shoulder the costs of the second stage of exploration.

Tony Hall, deputy head of Rand Mines base mineral division, said yesterday his group was one of only two major mining houses without a platinum arm.

Besides providing Rand Mines with the chance to become a platinum producer,

CHERYLYN IRETON

er, it also gives it an interest in a vanadium mine, which Vansa is developing on the Kennedy Vale property.

As the vanadium deposits are on the surface, they will in no way restrict the mining of the underlying platinum-bearing reefs.

Vansa holds the platinum group mineral rights for Kennedy Vale though its subsidiary Rhodium Reefs.

If the mine goes ahead, it will do so under the Rhodium Reefs banner. Rand Mines will provide a further R52,5m to help finance the venture and obtain a 60% stake in Rhodium Reefs.

Vansa will increase its ordinary shares from 20-million to 34,5-million and the options from 5-million to 7-million. The new shares go to Rand Mines.

After taking into account Rand Mines' stake in Vansa and in Rhodium Reefs, it would ultimately have an effective 77% interest in the platinum mine.

Rand Mines chairman Dammy Watt said yesterday "Vansa's new vanadium mining and refining operation, the Winterveld mine and any potential new platinum mining complex can share many facilities."

# Rand Mines backs Vansa in a major new platinum venture in bushveld

25/9/88 STAL

217

## Financial Staff

Rand Mines has stepped in behind Vansa Vanadium SA to forge an association which will bring together some of their interests in the bushveld complex which is likely to lead to a major new platinum producing field in this country

This is just the sort of courageous move that South Africa needs at the moment, and despite the threat of sanctions one of the country's leading mining houses is clearly confident that mining, and in particular platinum, has a solid long-term future

They have reached an agreement in terms of which Rand Mines will acquire 42 percent of Vansa and participate with Vansa in a possible new platinum venture in the vicinity of Steelpoort, Transvaal. Rand Mines thus gets a direct interest in the Vansa Vanadium mine being developed there

On the other side of the coin,

the proposed deal — which is subject to Vansa shareholder approval — gives Vansa a leg into the Rand Mines Winterveld chrome operations only 11km away

The proposed transaction — which has the blessing of Erconovaal which holds just under 50 percent of Vansa — moves the number of ordinary Vansa shares in issue from 20 million to 34,5 million and the options from five million to seven million, while the preference shares in issue remain at five million. Rand Mines thus gets 14,5 million Vansa ordinaries and two million options in exchange for 99,9 percent of its Winterveld Chrome Mine

At current market prices, the Vansa capitalisation will move to over R170 million, R70 million of which will be accounted for by Rand Mines via its 42 percent Vansa holding

The R30 million which Vansa recently raised in a rights issue

is fully committed to its new Vanadium operation

But the major impact is that Vansa secures the full co-operation of Rand Mines — one of the remaining two major mining houses still without a platinum leg — to explore, fund and develop Vansa's envisaged platinum mine on the Kennedys Vale property, on which surface deposits of vanadium are underlain by the platinum-bearing Merensky and UG2 reefs

Vansa needs a well-heeled partner for this venture, which is clearly why the controlling shareholders have decided to go for the agreement

A very important aspect is that Rand Mines will undertake — at no cost to Vansa — a full prospecting programme and investigation to evaluate the feasibility of establishing a platinum mine and refinery to exploit the deposits of platinum group metals which Vansa presently holds in the area through

its subsidiary Rhodium Reefs

If the feasibility study shows an acceptable rate of return, a decision will be taken to establish a major new platinum mining operation under the umbrella of Rhodium Reefs

If the go-ahead is eventually given Rand Mines will initially provide R52,5 million to help finance the new venture and thereby fix its interest in Rhodium Reefs at 60 percent

Vansa will hold the other 40 percent by virtue of the mineral right contribution

Taking its proposed 60 percent share of Rhodium and 42 percent holding in Vansa together, Rand Mines' interest will be 77 percent

For Rand Mines shareholders the deal offers a significant interest in the mining and exploitation (from 1988 onwards) of a strategic material, vanadium, and the distinct possibility of participating a big new platinum venture



25/9/86  
BUDDAY  
217

---

## COMPANIES

---

# Pressure good for platinum

POLITICAL and economic pressures on SA are likely to increase fears about the availability of platinum.

Carl Netscher, chairman of Impala Platinum, expressing this view in his annual review, says these considerations are therefore expected to strengthen the price in the short term and encourage investment in platinum in the first half of the financial year to June 1987.

Netscher adds that the long-term outlook for platinum demand, in spite of current political and economic conditions, remains encouraging for the motor vehicle and jewellery sectors in which Impala has a significant share of the markets.

He says "In the US an economic slow-down appears likely and is expected to reduce consumer spending on durables, which could in turn adversely influence platinum consumption in the automobile and electronics industries.

"The dramatic strengthening of the yen, against the dollar, is likely to inhibit export-led growth in Japan. In addition, the higher platinum price relative to gold will begin to work through to the retail level in the jewellery industry, and the volume of metal consumed is there-

ADAM PAYNE

fore likely to remain fairly constant.

"When considering the probable platinum price trend, conflicting influences are apparent. The oil price appears set to remain low for some months at least and this, together with low inflation levels in the major world economies, could well exert a restraining influence on the price as appears to have been the case with gold in the early months of 1986"

Reviewing the past year to June 30, Netscher says industrial consumption grew in line with the economies of the major markets but this improvement, together with increased demand for bullion coins and mini-ingots, was largely offset by adjustments to dealer and industry inventories

As a result the share of total platinum demand taken by the investment sector reduced, while that accounted for by industrial consumption increased mainly because of growth in the needs of the motor vehicle and jewellery industries.

The London dealer price for platinum improved dramatically over the year, rising from \$269 in July 1985 to \$432 in June of this year

(Impala's present price is \$600/oz).

The upward trend in price was given extra impetus in January when the majority of Impala's miners were dismissed after striking

They were dismissed in January and mine production did not return to pre-strike levels until early May.

The platinum market in the US firmed during the year, due almost entirely to the higher level of purchases by the automobile industry

In Japan after a record 42% growth in the previous year, net imports of platinum fell back by about 25% in the year to June. However, consumption of metal in industry has remained strong and the decline in imports largely reflected de-stocking and liquidation of investment holdings.

In Europe, platinum demand increased significantly due, in part, to greater demands from the motor vehicle industry but, chiefly, to substantial growth in demands for coins and mini-ingots.

World supplies of platinum rose marginally during the year in spite of the negative influence of the Impala strike on its production. There was probably a lower supply of platinum from Canadian and Soviet nickel mines

W/E ARGUS 27/9/86

217

## 'Twsana plant plan angers unionists

Weekend Argus  
Foreign Service

LONDON — British trade unionists are angry that platinum refining plants in Britain and South Africa are to be closed and the work switched to a new plant in Bophuthatswana — where union activities are restricted.

Mr Eddie Marsh, a divisional officer of the Iron and Steel Trades Confederation, said the move was "abhorrent".

Mr Tony Whiteley, a divisional officer for the Association of Scientific Technical and Managerial Staffs (ASTMS), said British unions would be "very sympathetic and supportive" of their colleagues in South African trade unions who were opposing the move.

Both unions have members working at the British plant at Royston, Hertfordshire, run by Johnson Matthey and Rustenburg Platinum.

About 100 British workers have already lost their jobs there — although there were no redundancies.

"Our argument is that in making changes the two companies at Royston should make sure the workers who previously carried out these functions in Britain should also have a continued opportunity of employment."



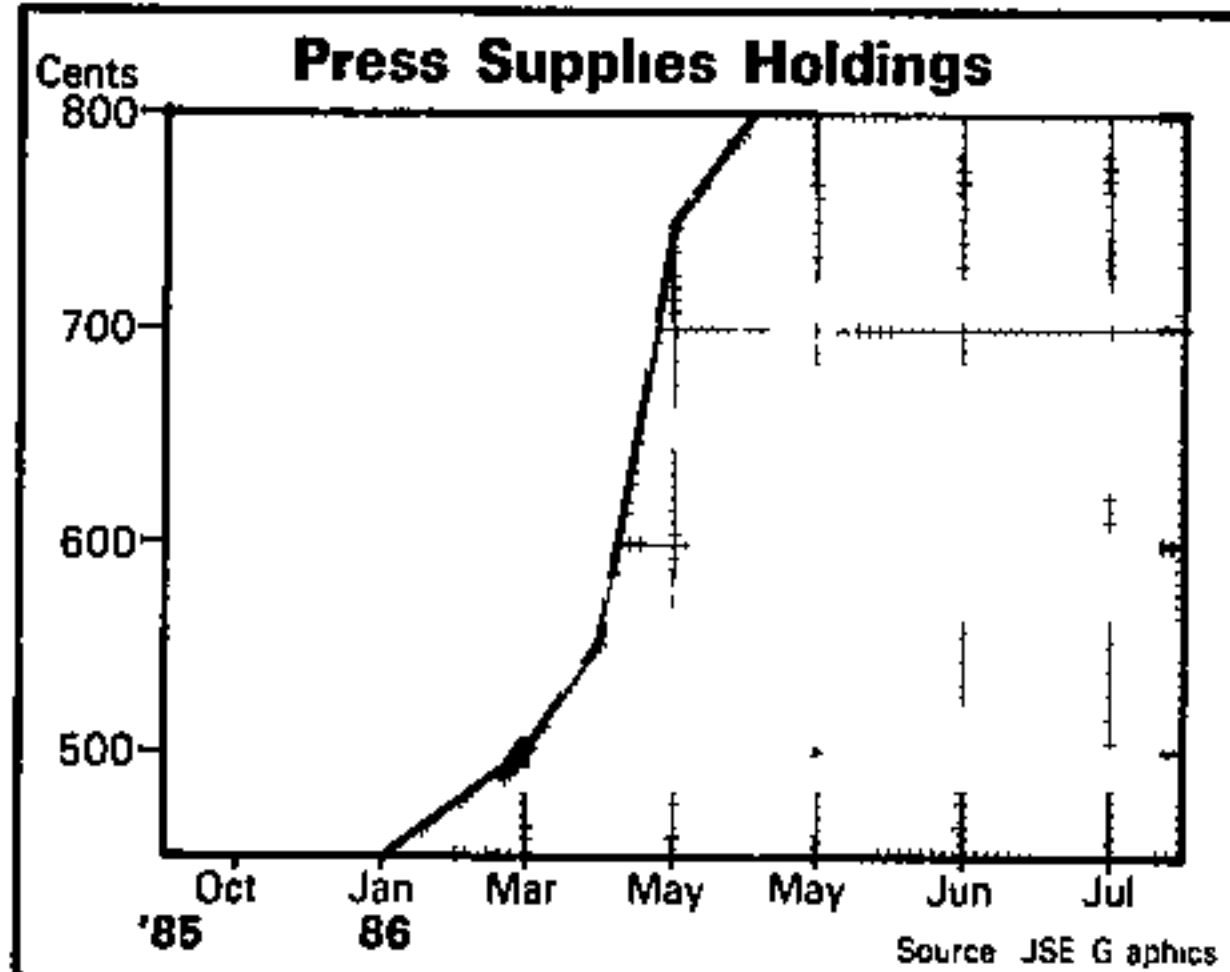

Hohmann now holds a 34% stake, while 51% is held by Zandberg — who earlier this month made an offer to buy from minorities 60% of their holding at R9. The share stands at R8.

At the annual meeting on October 15 the shareholders are to be asked to ratify the proposal to sub-divide the ords of 50c by five into 10c shares. This should improve the marketability of the thinly traded stock.

Undoubtedly, three years of declining performance will necessitate a sea change in strategy. The appointment of Zandberg (previously MD of SA Lighting) may be a step in this direction. But reliance on imports and lack of local alternatives will remain a bugbear.

The share trades at a 60c discount to net worth. Until there is evidence of a turnaround under Zandberg's direction, I think investors would do well to avoid the share.

Mark Ingham

3/10/86  
IMPALA PLUMM 27

## Fumbled profits

The past two years have been a period of exceptional profit potential for platinum producers. Impala, while lifting its earnings by 33% in its 1986 year, has let much of the potential slip through its fingers.

Its 1986 earnings of 334c a share are only 44% up on the 1984 figure, while the dividend has stood unchanged for three years. By contrast, since 1984 Rusplats lifted its earnings by 158% and increased its dividend by 125%. A year ago, Impala's R59m loss on forward contracts were thought to be a once-off event, and its profitability would therefore improve strongly in the 1986 year. Instead, it fell victim to large-scale labour disruption last January, which slashed the year's profits by R45m. The combination of this, and the major capital programme which

**Activities:** Mining and refining of platinum group metals, nickel, copper, and cobalt

**Control:** Gencor has 54% of the equity  
**Chairman:** C A Netscher, managing director D A Ireland

**Capital structure:** 57,7m ords of 20c each  
Market capitalisation R2,7 billion

**Share market:** Price 4 725c Yields 2,9% on dividend, 7,1% on earnings, PE ratio, 14,2, cover, 2,5 12-month high, R58, low, 2 160c  
Trading volume last quarter, 1,3 m shares

**Financial:** Year to June 30

	'83	'84	'85	'86
Debt				
Short-term (Rm)	10,9	30,0	151,3	164,0
Long-term (Rm)	43,8	40,7	35,9	27,4

### Performance

	'83	'84	'85	'86
Return on cap (%)	28,0	30,0	24,9	27,0
Turnover Index*	198	271	320	617
Pre-int profit (Rm)	175	260	253	318
Taxed profit (Rm)	92	133	144	193
Earnings (c)	159	231	251	334
Dividends (c)	85	135	135	135

\* 1979=100



## Impala ... needs to stop profits slipping away

Impala launched into last year, resulted in the dividend again being pegged.

Quite what the capital programme entails is unclear. Impala chairman Carl Netscher

says it involves "shaft sinking and the elimination of process constraints to improve operating efficiencies." Some analysts believe, perhaps unfairly, it includes a significant element of development work that could have been done in earlier years. Be that as it may, the market was certainly peeved at the latest performance, and Impala's share has underperformed Rusplats since late 1984, including the period since Impala's year-end figures were released.

There is a risk now that the share will suffer from the same kind of adverse sentiment that depressed Gencor's share for several years. Gencor chairman Derek Keys said at the Gencor press conference a few weeks ago that he expects to see Impala improve its disclosure in future. That would be one way of improving confidence, Impala's level of disclosure now markedly lags that of Rusplats.

Netscher appears to have reservations about the short-term outlook for the platinum market, at least on fundamental grounds. He says that an economic slowdown appears likely in the US and is expected to reduce consumer spending on durables, which could in turn adversely influence platinum consumption in the automobile and electronics industries.

In Japan, the other major market for platinum, the dramatic strengthening of the yen against the dollar is likely to inhibit export-led growth, he says. "In addition, the higher platinum price relative to gold will begin to work through to the retail level in the jewellery industry, and the volume of metal consumed is therefore likely to remain fairly constant."

### Political pressures

However, Netscher cites conflicting influences likely to affect the platinum price. Restraining influence could well come from the weak oil price and low inflation in major world economies, but in the short-term, economic and political pressures on SA are likely to increase fears regarding the availability of the metal. "These considerations are therefore expected to strengthen the market price and encourage investment in platinum in the first half of the 1986-1987 financial year," he says.

Because it is locked into long-term supply contracts with major customers, Impala is not as sensitive to price fluctuations as Rusplats, but there is some scope for escalations. These, with expected increases in production levels, suggest there is potential for good

## ISSUES

FULLY PAID

NIL PAID LETTERS

LETTERS OF ALLOTMENT

PRICES OF LETTERS

COMPANY AND TERMS	Last day to register	NIL PAID LETTERS			FULLY PAID LETTERS OF ALLOTMENT			PRICES OF LETTERS							
		Listing begins	Issued	Listing closes	Last day for splits	Date offer closes	Listing begins	Issued	Listing closes	Last day for splits	Shares listed	Shares issued	Take up price	Price Sep 22	Price Sep 29
DUNDEE — Rights Issue 10 linked units for every 100 ord shares held and 1 linked unit for every 100 part pref shares held at a price to be announced. Each linked unit will comprise 7 ord shares and 18 Conv Red Pref shares.	24 10 86														

P.T.O.

profit improvement this year.  
Capital spending, forecast at R130m-R140m (R110m) will keep a curb on divi-

dend prospects, but there is certainly potential for a respectable increase in the pay-out this year. Even so, Rusplats is likely to re-

main the more favoured platinum counter until Implats regains confidence among investors  
*Andrew McNulty*

## RESULTS AND DIVIDENDS

		Pre-tax profit Rm		Percentage change	Earned cents per share		Paid		Sector	Dividends		
		1985	1986		1985	1986	1985	1986		Amount cents	Register by	Payable about
Af Cable	P	(1,9)	9,1	—	(5)	20	—	12	Electronics	†9,00	3 10 86	3 11 86
Alexander	P	3,0	3,9	+30	27	38	▲15	18	Engineering	†12,00	17 10 86	3 11 86
Altech	I	42,4	51,7	+22	219	277	—	—	Electronics	—	—	—
Altron	I	60,2	70,1	+17	94	112	—	—	Electronics	—	—	—
Anchusa	P	34,4	6,3	-82	52	7	47	8	Ind Hold	—	—	—
Asea	I	7,3	9,1	+25	20	17	—	—	Electronics	—	—	—
Berzack	P	2,9	7,9	+172	241	340	34	50	Engineering	†43,00	19 12 86	28 1 87
Bivec	P	3,2	8,2	+156	45	62	7	10	Engineering	†8,60	19 12 86	28 1 87
Burling	I	0,2	0,3	+50	—	—	#	#	Clothing	—	—	—
Cons Gold	D	—	—	—	—	—	78,55	77,65	Min Houses	†52,40	17 10 86	2 12 86
D & H	I	1,1	(4,5)	—	6	(46)	#	#	Ind Hold	—	—	—
E Dagga	I	(0,3)	(0,2)	—	—	—	#	#	Rand & Others	—	—	—
Fintech	I	0,5	0,4	-20	11	13	—	—	Cash Assets	—	—	—
Fralex	P	3,1	3,9	+26	15	19	▲8,75	10	Engineering	†6,50	17 10 86	3 11 86
Frencor	I	0,4	1,5	+275	1	47	—	5	Ind Hold	†5,00	9 10 86	24 10 86
Inv Club	P	(0,02)	2,7	—	(33)	38	#	#	Inv Trust	—	—	—
Landlock	I	(0,3)	0,2	—	(3)	1	#	#	Engineering	—	—	—
Math & Ash	P	(0,2)	2,6	—	(35)	34	#	#	Printing	—	—	—
Masonite	I	2,5	3,4	+36	23	37	—	13	Building	*13,00	9 10 86	31 10 86
Powtech	I	15,6	15,9	+2	4	4	—	—	Electronics	—	—	—
Tex Mills	I	20,5	20,9	+80	—	—	#	#	Clothing	—	—	—
Ventron	I	60,3	70,2	+16	35	43	—	—	Electronics	—	—	—
Wankie	I	1,9	8,5	+347	4	19	#	◇2,76	Coal	◇*2,76	17 10 86	6 11 86

▲ = 13 months P = Preliminary † = Final I = Interim \* = Interim dividend # = Dividend passed ◇ = Net after non-resident tax D = Dividend  
Z = Zimbabwean currency

## FOREIGN BOURSES

	Sep 30 1985	Sep 22 1986	Sep 29 1986		Sep 30 1985	Sep 22 1986	Sep 29 1986
Amsterdam Industrial Index	189	283	275	<b>NEW YORK</b>			
CAC Gen Index (Paris)	211	380	384	ASA	38	41	38
Commerzbank (Frankfurt)	1 536	1 980	1 953	Bank of America	13	12	11
Dow Jones Index (New York)	1 327	1 793	1 755	Exxon	50	67	66
New Stock Exchange Index (Tokyo)	1 027	1 458	1 533	General Motors	66	70	68
Swiss Bank Corp Index (Zurich)	467	543	544	Homestake	25	29	28
Sydney & Melbourne Index	987	1 224	1 257	IBM	124	139	134
UK Industrials (FT)	999,4	1 282,8	1 212,6	<b>UK</b>			
UK Government Securities	83,9	84	81,8	British Telecom	198	188	180
UK Actuaries 750 shares	626,2	796,8	762,5	Barclays	365	490	464
US Ind (Std & Poor)	203	260	254	GEC	156	176	160
<b>TOKYO</b>				Marks & Spencer	163	204	187
Toyota	1 050	1 910	2 110	Standard Chartered	423	708	684
<b>ZURICH</b>				Rio Tinto	552	637	632
Credit Suisse	2 800	3 690	3 620				
Swiss Bank	459	535	521				
Union Bank	4 100	5 720	5 625				

# “Hello Mum, how’s London?”

With a TR Services PABX you know exactly how many phone calls your staff have made – from which extension they made them – and precisely where they made them to

Information, that will have a most sobering effect on your telephone bill

AC&R Advertising • Bates Linked – Business Driven 5620

In fact a TR Services PABX will put total control back into your hands. Call us and see for yourself at Jhb (011) 786-2266. CT (021) 51-3322. Dbn (031) 25-9222. PE (041) 54-1291

**Part of the international TR Group**



Making communication effortless



engineering sector p/e of 11,4 and yield of 3,6%. The group has been through a rough period in which confidence was shaken, but a conservative management with the backing of Rembrandt look to have the capability of keeping it on the right track. The share seems to deserve a higher rating in view of its improved prospects.

Kerry Clarke

VANSA FUND

## Strong partner

The link between Rand Mines and Vansa Vanadium will benefit both companies and could lead to a stock market re-rating of the Vansa operation, which many analysts have regarded as speculative until now. While Rand Mines gets back into the platinum business through the deal, Vansa acquires a powerful big brother as well as the Winterveld chrome mine.

Winterveld will kick in cash through its profitable operations, allowing Vansa to declare a dividend in its 1987 financial year. In addition, its existing infrastructure of administration, housing, sales organisation and general amenities will greatly assist towards bringing the vanadium mine into production on target in 1989 and perhaps ahead of schedule.

Despite this, Vansa's share price turned easier on Thursday after the deal was announced, before recovering ground on Friday and early this week. Analysts put the weakness down to stale bulls in the market and to the policy followed by some punters of "buy on rumour, sell on fact," driving up the price unrealistically.

In terms of the deal, Rand Mines acquires 42% of Vansa in return for injecting 99,9% of Winterveld chrome mine into Vansa. Rand Mines has also undertaken to carry out the next stage of exploration on the platinum reefs and the evaluation of a potential platinum mine at no cost to Vansa. The platinum mineral rights are held by Vansa's wholly-owned subsidiary, Rhodium Reefs.

That will probably save Vansa about R2m on the exploration costs and at least R500 000 on the fees that would be incurred in the feasibility study. In the event of a "go" decision on the mine, Rand Mines will contribute R52,5m for shares in Rhodium Reefs, which will give it a 60% stake in the company.

The platinum aspect of the Vansa operation is still speculative, at least until July 31 next year, when Vansa director Cyril Heever says Rand Mines must decide on whether to proceed with a platinum mine. However, a number of analysts feel considerably happier about Vansa's prospects now that it is part of the Rand Mines camp. Vansa had raised some R30m to fund its vanadium mine, but the potential platinum development was too large for the company without a strong partner.

Indications are that any platinum mine set up would mill at least about 100 000 t of ore

## The Vansa prospect

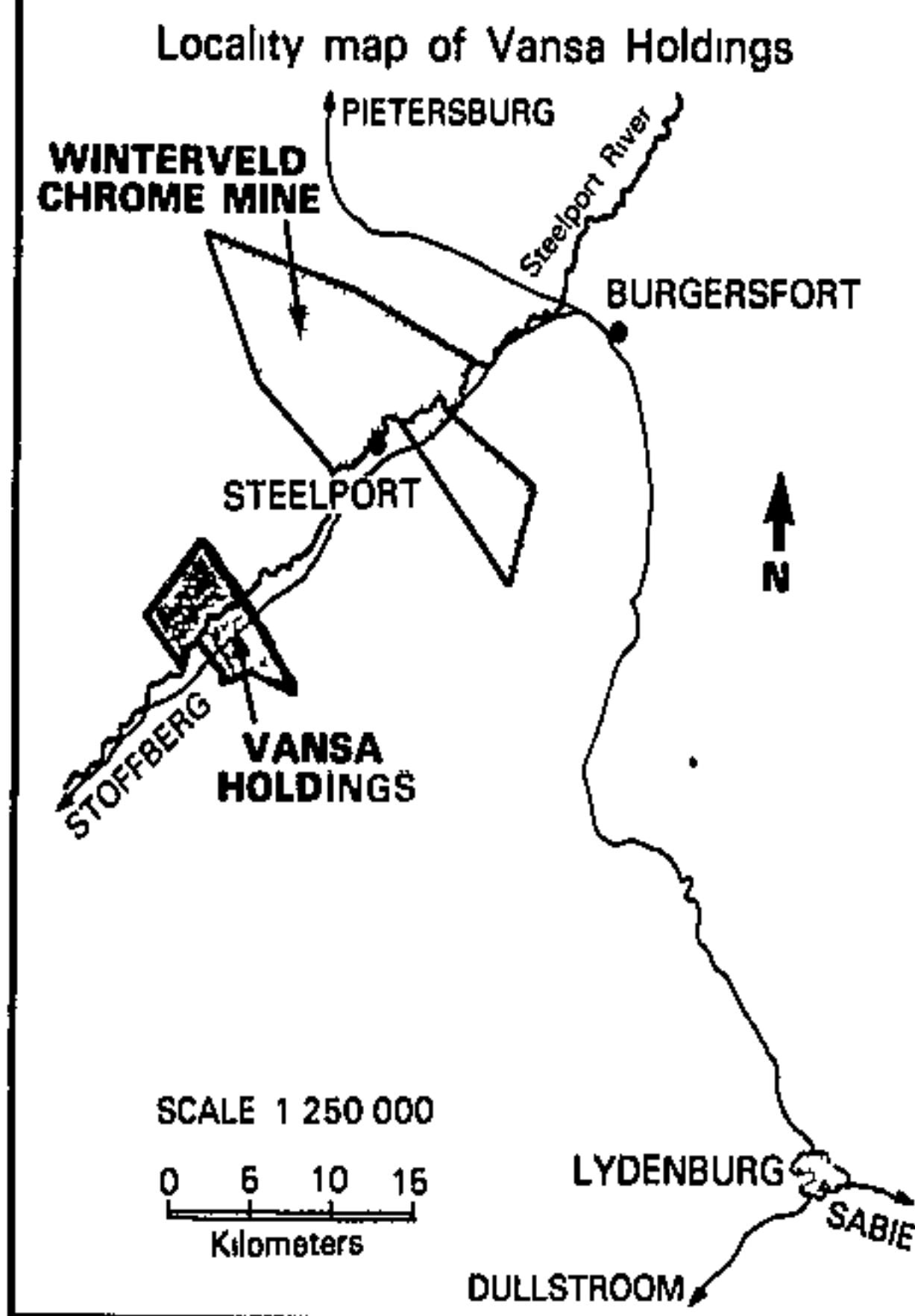

a month, but could be as large as 200 000 t milled a month. Estimated costs would range from about R350-R500m on those two production limits. The development will be cheaper than Gold Fields of South Africa's Northam platinum mine because the Mersensky and UG2 reefs are much shallower at Vansa.

Deputy head of Rand Mines' base metals division, Tony Hall, says it is too early to start talking about the size of any platinum mine development and neither Rand Mines

nor Vansa will reveal results of preliminary drilling already carried out by Vansa.

A decision to develop the platinum mine means heavy capital commitments from both partners. Vansa has retained the right to either follow its rights in Rhodium Reefs, or pass them on to shareholders. That is favourable for Vansa shareholders, as they may be able to decide whether they want to stay in the platinum play or, instead, take profits by selling out through the nil paid letters.

Rand Mines will not reveal the extent of the profits being made by Winterveld, but it is believed current distributable earnings are between R8m-R10m/year. After allowing for retentions by Winterveld, and keeping in mind Vansa's objective, as stated in its prospectus, of paying out 80% of distributable earnings, that means Vansa could pay a dividend of about 10c-15c a share next year on the 34,5m shares that will be in issue after the deal. Vansa expects to start paying dividends from its vanadium operations in the 1989 financial year.

Vansa is being set up to produce vanadium pentoxide, currently selling at some \$2,47/lb. However, it is understood the company has been working closely with the Council for Mineral Technology (Mintek), looking at the production of ferrovandium which sells currently at \$13,4/lb. Mintek wants to see more local beneficiation minerals. Vanadium has been targeted as a key area for this. The capital costs of setting up ferrovandium operations are not excessive — some R6m — and the funds could be forthcoming from Rand Mines if the returns look attractive enough.

Brendan Ryan

## FM INVESTMENT CONFERENCE

Energy is a critical factor in all investment markets, but nowhere more so than in SA. For example, not only does the cost of crude oil affect local economic prospects and the inflation rate, but it also plays a part in establishing the gold price.

Alan Hill is an investment analyst who has spent a large part of his working life studying the international energy markets. His address on world energy developments at this year's *FM Investment in 1987* conference promises to be one of the highlights.

A research partner with Max Pollak & Freemantle, Hill is a civil engineer with an MBA from UCT. He is highly regarded in his field, having been consistently rated among the top investment analysts in fields as diverse as energy, diamonds and

industrials.

In his address, Hill will place recent developments in the oil market in perspective, and discuss their impact on the world economy in general and SA in particular.

Seats at the conference, however, are going rapidly and prospective delegates are advised to book immediately to ensure a place.

The conference will be held at the Carlton Hotel, Johannesburg, on November 13 and 14. The fee is R550 a person, reducing to R500 for subsequent delegates from the same company.

To book, contact Yvonne Courtney, FM

Promotions Department, PO Box 9959, Johannesburg 2000. The telephone number is 710 2480 and the telex number 4-88921.



6/10/80  
WEDNESDAY  
Sanctions could  
close Rossing 217

WINDHOEK — Strict implementation of anti-SA sanctions could close the Rossing uranium mine in Namibia, assistant GM George Deyzel says.

He says: "Applying the uranium sanctions to Namibia could be disastrous. The mine would have to close."

Deyzel says uranium is particularly vulnerable to restrictions as its marketing depends on long-term contracts with a select number of customers.

Mine production is kept secret, but officials say Rossing's output is about 5 000 short tons a year, or around 10% of output in the free world.

The extension of the sanctions (approved on Thursday) — which include import bans on minerals like steel, iron, coal and uranium — to Namibia, is significant as the barren region holds mass natural wealth. — Reuter.



Industrial Staff

SENIOR staff at Namibia's Rossing uranium mine have drawn a veil of secrecy over the possible effect anti-SA sanctions would have on the mine.

Responding to Press statements made by assistant GM George Deysel, a mine spokesman said yesterday: "In the circumstances, we would prefer not to comment on any trade sanctions which have been applied or may be applied against SA and Namibia.

"The situation in the international uranium market is difficult for producers, so the less known by our competitors about Rossing's markets the better."

Earlier reports quoted Deysel as saying implementation of US sanc-

ROSSING keeps  
mum on bans

tions, which include a ban on uranium, could lead to closure of the mine.

The spokesman said possible consequences of effective global sanctions were hypothetical at this stage.

Rio Tinto Zinc has a 46.5% shareholding in Rossing, which has a total annual production capacity of 5 000 tons. The mine, regarded as the world's largest open-cast uranium mine, employs 2 500 people.

From 1981 to 1985, Rossing contributed 35%, by value, of all exports from the territory and 18% to Namibia's gross domestic product.

# Platinum futures lead precious metals higher

CHICAGO — Platinum futures led a strong advance in precious metals prices yesterday as demand from speculators continued to bolster prices in response to political tension between South Africa and the United States.

Concern that South Africa might retaliate against US sanctions by withholding supplies of platinum, which has industrial applications, fuelled the speculative surge, analysts said.

The platinum January contract closed up \$19.90 at \$615.30 an ounce. The advance helped take gold and silver prices higher.

However, after the close of trading, the Finance Minister, Mr Barend du Plessis, said retaliation against sanctions would be contrary to Government policy.

The December gold contract rose \$5.30 at \$442.80 an ounce.

Silver prices were also boosted by a de-

7/10/86 SPAK (217)  
cline of about 5.7 million ounces of silver from stocks deliverable against futures contracts, analysts said.

Petroleum futures prices drifted aimlessly as the Organisation of Petroleum Exporting Countries began a new meeting to discuss policies and production quotas.

The first day of the session of 13 OPEC ministers shed little light on the future of the cartel or its ability to hold the line on production and support prices, analysts said.

Most expect OPEC to continue the existing quotas until the end of the year.

"OPEC is caught in the classic Catch-22," said Mr Michael McDermott, of Drexel Burnham Lambert.

"They all want to sell more at higher prices, but you can't have both at once. I still expect them to continue the present agreement." — Reuter.



# The vital MCV Factor

By Jaap Boekkooi,  
Science Writer

Most industrialised countries are hesitant to follow the American sanctions initiative against South Africa because of the little known MCV Factor which is seldom discussed outside boardrooms

The MCV Factor stands for manganese-chromium-vanadium, a powerful combination of minerals without which steel manufacturing throughout the modern world would revert to the technological Middle Ages. And without which there would be no railway lines, cars, jet aircraft, locomotives

As it is South Africa holds a virtual world monopoly on these minerals. As the newspaper *General-Anzeiger* in the West German capital Bonn mentioned the other day: "The West German steel industry is completely dependent on South Africa for certain alloy raw materials. The production of high-grade steel in Germany could be speedily paralysed by counter-boycott measures since, unlike

the US, it has no strategic reserves."

For Germany, one can also read France, Sweden, Japan, Korea and the entire industrial world which runs and moves on modern steels. The exception is the United States which has stockpiled strategic minerals, manganese even, for the past 40 years

The MCV Factor could be South Africa's "bomb in the basement" as an unparalleled bargaining power ploy

For as the Bonn paper points out, the amount of strategic minerals South Africa supplies to the West "is not that significant for its own balance of trade"

The unsaid implication is that South Africa could use the strength of its rare minerals in sanctions-spawned barter agreements much in the way Russia used to do

This country is in no obvious bargaining position for its coal and iron ore exports, for instance, where too many suppliers are ready to step into the sanctions breach. But if ores and coal were offered in package deals with more vital minerals, they would consti-

tute an offer increasingly hard to refuse

Even if South Africa were to hold up exports of the MCV Factor minerals it would only affect a small fraction of its total mineral exports

The 22 000 tons of vanadium exported from South Africa annually, six times that of its nearest rival Finland, earns the country a mere R122 million, about 0.5 percent of total mineral exports of R23 000 million. Manganese exports are twice this, just over one percent of mineral exports, and chrome ore exports stand at R147 million a year

Yet together, at below 2.5 percent of mineral exports, they constitute a mighty mineral mouse that roars. And one that, when tweaked, will again send up the gold price

Manganese production, most of it from the great Kalahari storehouse whose reserves are almost 80 percent of the world's, has tripled since 1960. If supplies were interrupted the United States, for instance, would be forced to use up its reserves and resort to expensive seabed mining of manganese nod-

ules

In chromium, the heart of many alloys and all stainless steels, South Africa and Bophuthatswana hold 77 percent of Western reserves and just on 56 percent of present world production

Although South Africa and Bophuthatswana have 93.7 percent of the world's reserves of platinum metals and these minerals are often classified as highly strategic, the world is not as dependent on South African platinum mining as is often thought.

There are large-scale strategic global platinum reserves in the form of bars and jewellery which could be turned into platinum for industrial uses. Car emission catalyst programmes, the main outlets for the metals, could simply be suspended world-wide until Southern African supplies are restored.

Once other countries start looking at the critical implications of the MCV Factor, then the German newspaper's *cri de coeur* "Bonn is faced by a difficult decision", will soon be echoed in other world capitals.

10/10/217  
SMAR

## NEWS FOCUS

NEW YORK — This week's decline in the price of platinum has pared its substantial premium over the price of gold, and analysts are predicting further price drops as some investors sell platinum and buy lower-priced gold and silver.

While analysts recommend staying away from platinum for the time being, less volatile gold and silver are still on some buy lists.

Underpinning these metals are good, solid investment interest, aided by weak performances in the US stock and bond markets, which is bringing fresh money into the precious metals sector.

Concerns of a resurgence in inflation are also bolstering the metals, a traditional haven in inflationary times. In addition, traders are seen to be holding an abundance of long positions in platinum. An unwinding of these positions is expected to continue in coming days, with funds moving instead into the gold and silver markets.

The price differential between platinum and gold lately has widened as the price of platinum soared, selling late last week at a premium to gold of as much as \$250.

Following this week's corrective action in the precious metals, however, the spread between bellwether contracts in platinum on the New York Mercantile Exchange and gold on the New York Commodities Exchange narrowed on Wednesday to

# Platinum takes on a tarnished image

*2/9/80*  
*BUSDPA*  
*217*

LARRY M GREENBERG

\$180.40

Most of this differential between October platinum and December gold emerged in the last few weeks. In July, for instance, the average premium of platinum over gold was \$91. This increased markedly to an average \$165 in August. But just over a year ago, tables were turned and platinum was selling at a discount to gold of about \$22.

This week's narrowing of the premium represents the rapid sell-off platinum has undergone, even as gold also has fallen, but at a slower pace. Since last Friday, platinum has fallen 13%, compared with gold's 4.3% decline.

Bernard Savaiko, senior precious metals analyst at Painewebber in New York, said that some holders of long platinum positions are unwinding platinum-gold ratios to take profits in platinum and buy gold. These

profits are also making their way into the silver market, he said.

The platinum market has been widely viewed as being over-bought. According to this view, the rally in the metal, fuelled by concerns about unrest in SA, the non-communist world's major source of platinum, was joined by speculators who drove up the price of the metal to levels that were difficult to sustain, at least in the short-term.

Now, the large price differential is "psychologically making platinum bulls nervous," Savaiko said. The market could either respond by taking platinum lower or gold higher, he said. In the current case, the premium "is enticing a lot of platinum longs to switch positions to gold" as well as to silver.

Savaiko noted, however, that it's difficult to determine which has created more nervousness in the platinum market — the metal's wide premium over gold or simply its high

price.

With gold selling at just over \$400, and silver under \$6 an ounce, these metals are seen as a less expensive way of participating in the precious metals rally than by purchasing platinum at prices near \$600.

In addition, said George Anagnos, a market analyst at the Comex, since as much as 40% of the world's demand for platinum goes for the manufacture of jewellery in Japan, consumers might easily turn away from these items at current high prices, thus exerting pressure on the platinum market.

According to Anagnos, platinum's current premium over gold shouldn't be particularly vexing to the market. Today's metals' prices "indicate that the premium is very wide, but by historical standards it is not unique," Anagnos said.

Platinum's record premium over gold was \$397, set in early March 1980, when platinum was selling for more than \$1 000 an ounce — AP-DJ



COMPANIES

RUSOFF 14/10/89  
217

# Black Mountain pays off loans

**BLACK MOUNTAIN Mineral Development** — the rising star in GFSA's base metals portfolio — has paid off its R222m loans by means of an equity issue and cash payments.

The north-west Cape mine produces lead, copper, zinc and silver.

Big loans caused a heavy interest burden, and the payment of the loans will improve bottom-line performance.

The authorised capital has been increased from R30 000 (divided into 60 000 shares) to R20m (40-million shares).

Of this, 35 843 666 shares were issued to existing shareholders, principally GFSA and Phelps Dodge Corporation. This was in repayment of R17,9m

ADAM PAYNE

of shareholders' loans. The balance of the loans was repaid in cash.

The effective percentage holdings of the various shareholders remains unchanged, with GFSA holding over more than 50%.

Black Mountain's profit rose 51% to R17,7m (R11,7m) in the September quarter.

Higher production of lead was achieved in spite of lower tonnage milled, because of improved grade.

The grade is unlikely to be held at the higher level. The mine has been working a richer area and grade is expected to return to previous levels.

Lead sales were up at R36,6m (R32,2m) and the cost of sales was virtually unchanged.

Prices of lead, zinc and copper were up in the quarter. However, since then they have been overtaken by the effects of the stronger rand.

**ROOIBERG TIN:** Results were better than in June, with loss reduced from R663 000 to R166 000.

Grade was better at 0,48% (0,41%). Sales revenue a ton rose marginally to R14 246 (R14 124). Loss before tax was reduced and a tax credit of R182 000 helped the final result.

Chairman Peter Janisch comments that GFSA will keep Rooiberg going until the international tin price recovers, hopefully by 1989.

"At present the low price is critical because of the stronger rand, which affects export receipts.

"On the local market Rooiberg is also hit by the stronger rand, since the domestic price is set according to

the price of imported tin, which is lowered through a stronger rand. A substantial part of sales are local."

**O'OKIEP COPPER:** The mine raised its net profit 37% to R4,8m (R3,5m) in the quarter, with a higher tonnage milled, improved grade and a bigger recovery of copper in concentrates.

Sales of blister copper were up, as were costs of sales, leaving a working profit of R5,4m (R4,8m).

Production figures were good. The company will be affected in its exports in the current quarter by the strength of the rand.

**ZINC CORPORATION:** Net profit was raised to R6,8m (R260,000).

A sum of R1m included in the profit was received as part payment of an insurance claim for losses through fire.

# One dead, 25 hurt in accidents at refineries

By Mike Siluma

A worker died and more than 25 had medical attention after accidents at two East Rand platinum refineries yesterday.

Gencor confirmed that Mr G C Fourie (49), a process operator, died — apparently from a heart attack — after the accident at the Impala plant and 25 other workers were kept under observation for a few hours.

Two other employees involved in the accident were still in hospital today.

A Gencor spokesman said a spill of processing liquid was involved but the accident had minimal effect on production.

At Matthey Rustenburg Refineries, Wadeville, eight workers were affected by chlorine fumes from a burst pipe, the Chemical Workers' Industrial Union (CWIU) reported.

CWIU spokesman Miss Chris Bonner said eight workers were

affected and three of them were sent to hospital.

Miss Bonner said evacuation procedures at the plant were inadequate and had been raised with management about a month ago. Nothing had been done to correct the situation.

She said tight security at the plant allowed only security personnel to open exits. Workers wanting to escape would not be able to do so because they had to wait for security men to open the doors.

A company spokesman confirmed the accident but declined to comment on the allegations about evacuation procedures.

The spokesman said three workers were affected.

●Late editions of *The Star* yesterday wrongly reported Miss Bonner's comments about safety as concerning the Impala refinery. In fact she was referring to the situation at Matthey Rustenburg.



(217) STAR 22/10/86.

By Neil Behrmann

# West's tin output 'will tumble by 20 percent'

LONDON — Nearly a year since a tin crisis rocked world metals markets, production has crumbled, trade has shrunk and brokers and bankers are preparing for acrimonious legal battles

The International Tin Council, the international organisation that defaulted, estimates that Western world tin output will tumble by 20 percent to 127 000 tons this year

For the first time in years production is well below consumption of 160 000 tons. But tin prices remain depressed because huge stocks estimated at 100 000 tons are overhanging the market.

Production of Malaysia, the world's biggest producer will slump by 25 percent to 27 820 tons, Bolivia by 32 percent to around 11 000 tons, Thailand by 9 percent to 15 000 tons while South Africa's production will fall marginally from last year's 2 000 tons, estimates the council

Brazil, expected to produce nearly 27 000 tonnes this year, is set to become the world's biggest producer because analysts expect that Malaysia's production will fall even further.

Some analysts say that the council's estimates are optimistic and that world production declines will be even greater. They believe, for example, that Bolivia's tin production is down

to around 7 000 tonnes

Eldred Halton, a former tin miner and analyst at stockbrokers Kleinwort Greaveson says that the market has become a struggle for all. He estimates that under-capitalised mines and metals firms will be forced to liquidate tin stocks. Up to 30 percent of the world's tin mining capacity will close permanently, he predicts.

The seeds of last year's tin crisis were sown in 1981, when Malaysia's attempt to manipulate the tin market and boost prices, failed.

The International Tin Council, a price stabilisation organisation controlled by 22 tin producing and consuming nations including Malaysia, was instructed in terms of an international agreement to bolster prices. But the support price was unrealistically high.

Support operations were a success for several years. But on October 24 last year — following appeals for help — the council ran out of money.

It failed to meet payments on tin purchases and left in its

wake an indefinite suspension of tin trading on the London Metal Exchange. Several firms and banks incurred massive losses and there were doubts about the future of a once powerful and wealthy metals market.

In trading outside the exchange tin prices slumped from £8 900 in October 1985 to a low of £3 400 before recovering to £3 800 a metric ton. Seven firms out of 28 floor members of the London Metal Exchange stopped trading and output of tin producers slumped.

## OPTIMISM

With supply and demand coming into balance, tin traders are more optimistic. Without a large overhang of stocks, says a trader, tin prices would have risen even further.

Tin trade is much healthier now that the market is no longer controlled, say traders.

But metals firms remain worried because they are uncertain about the outcome of law suits involving hundreds of millions of pounds.

In a significant case due to be

heard early June next year, Shearson Lehman Brothers Inc and its subsidiary Shearson Lehman Metals Ltd are suing two metals traders Maclaine, Watson company and JH Rayner (Mincing Lane) for £94 million.

The action concerns tin sales contracts worth £74.5 million through Maclaine and £19.5 million via Rayner.

Shearson's writ also claims unquantified damages against the London Metal Exchange and its committee members.

That case is crucial because it will determine the extent of litigation against the 22 member governments of the International Tin Council, says Andrew Green, legal director of Amalgamated Metal Corporation, one of the metals firms that will be involved in litigation.

He estimates that eleven brokers hurt by the tin collapse could claim between £165 million and £400 million from government members of the council.

As a tactic, the eleven brokers have formed Tinco Realisations, an action group to pressure governments into paying.

Michael Arnold, a senior partner of Arthur Young, accountants and co-ordinator of Tinco Realisations, intends petitioning the High Court in London to wind up the International Tin Council.

If the council is liquidated, member governments including EEC states, Canada and Australia will be "jointly and severally liable" for the Tin Council's debts.

Bank creditors owed around £200 million also intend becoming involved in lawsuits.

● Following the collapse of the ITC last October, Rooiberg Tin, a subsidiary of Gold Fields of SA (GFSA), has gone into a loss situation aggravated by the recent improvement in the rand value against sterling.

Rooiberg has therefore decided to suspend production from those mines which are the major contributors to the losses. A and B mines and Vellefontein are to be placed on a care and maintenance basis immediately but the smelter will con-

...trates from 'C' mine, where operations will continue for the present. The reduced amount of tin produced will be more than sufficient to meet local needs, with the surplus continuing to be exported. About 1 000 workers will be affected by the trimming down of operations but many of them will be absorbed into GFSA group.

FUNNAL 3/10/86 (2/17) Pat Agency

### Westplats reduces disclosure

Lonrho-controlled platinum producer Western Platinum has cut back on the amount of information it reveals on its operations because of the increasing number of potential newcomers to the platinum game. Until now, Westplat has been the only South African platinum producer to provide ore grades and detailed statistics on production and working costs. These statistics are not published by Rustenburg Platinum or Impala Platinum and it appears they will not be published by GFSA's new Northam Platinum mine.

The latest Westplat results omit a grade figure and give only a combined figure for the quantity of noble metals contained in matte produced. Previously, this figure was split into component amounts of platinum, palladium and the other minor platinum group metals, as well as amounts of base metals produced as by-products. Westplat still publishes milled ore production as well as working costs per ton milled.

Lonrho SA commercial director Kevin Wilkinson tells me the changes have been made because of anticipated market competition. "We don't want to make it any easier for others to get into the platinum business," he says.

It is still fairly simple to work out the missing figures with reasonable accuracy. But if Westplat maintains the new policy, the calculation will become increasingly difficult in future, depending on expansions and the mix between UG2 and Merensky Reefs.

*Brendan Ryan*



S

217  
28  
3/10/86  
PUS DAY

# Gold could replace uranium

ADAM PAYNE

IF US sanctions on uranium — possibly followed by other countries — result in reduced sales of uranium oxide, some mines could be tempted to convert their uranium plants to gold plants.

Western Deep Levels had already done this before sanctions were imposed, with the uranium plant being converted to a plant milling 120 000 t per month to produce gold from dump waste rock.

The view that plants might be converted to gold production, far more profitable than uranium production, is expressed by London brokers James Capel, one of whose directors, Julian Baring, is considered London's leading gold "guru" in investment advising.

He believes the next upswing in gold could make the last one look like a minor event.

Uranium sanctions by the US

could be more severe than sanctions on steel and coal, particularly if other countries follow the American lead

The table shows percentages of pre-tax profits attributable to uranium in 1985 of SA gold mines and the profits in the year to June 1986.

In some cases, there are consumer loans which, presumably, will not be repaid if deliveries are reneged upon. In addition, not all uranium sales are export-orientated.

The US sanctions, if effective, may represent an opportunity for the mines affected to convert plant to gold recovery so as to enhance gold production

Harmony has considered this step, which would seem ideal for surface material gold recovery plants.

A company not listed in the table

is Rossing Uranium Production is not known but is thought to be in the ball park of 4 300 t to 5 000 t a year, according to Capel

A Rossing spokesman is on record as saying that the US sanctions, if effective against Namibia, could result in closure of the mine.

RTZ derived 9,7% of profits last year from that source. Capel's estimate for this year is 6,2%

Julian Baring, in his optimistic gold market projections, has worked out the paper profits that the huge rise in world stock markets generated. He concluded that they added up to \$100bn in the UK, \$460bn in the US and \$550bn in Japan.

With markets struggling in most countries, there is an uneasy feeling that capital gains will be harder to make in future. The one remedy for all this nervousness, Baring considers, is an investment in gold.

I  
F  
S  
V  
V  
\*  
T  
S  
C  
C

AKG 5/11/80

# Tin miners go back after two-day stoppage

JOHANNESBURG. — Workers at the Roonberg tin mine were back at work today after a stoppage which started on Sunday night, Gold Fields said in a statement today.

By yesterday afternoon about 60 percent of the work force at the C mine had reported for work, the statement said.

Workers at Zincor are still on a strike which started on Sunday night following a deadlock in wage negotiations. The plant is operating at slightly reduced capacity, Gold Fields said

The company says in its statement it would welcome talks with the National Union of Mineworkers — Sapa.

YAP

RECEIVED

APR 28 1980

Rate express

Vertical text on the right edge of the page, possibly a list or index.



9/11/86 30. N TIMES

# Rustenburg to use new refining technology

217

By Dave Edwards

**RUSTENBURG** Platinum's proposed refinery will use a new refining process based on solvent extraction technology.

The technology has been tested and proved and promises substantial advantages over the two conventional refineries operated at Royston and Wadeville.

The advantages are:-

- A healthier working environment.
- Lower operating costs.
- Lower precious-metal working stocks.
- Greater security.

The precious-metals refinery will be built at the Rustenburg mining complex in Bophuthatswana. The Rustenburg Platinum mining leases requires that the platinum group metals be refined in South Africa. The provision has had to be extended to include Bophuthatswana.

It is also clear that the Minister of Mineral

and Energy Affairs has granted a temporary exemption from those provisions to permit the use of the Royston facilities in England. However, the exemption will not be extended indefinitely — and a suitable long-term decision had to be made.

The other factors influencing the decision to set up the refinery were the decline in the rand against other currencies, particularly against sterling which increased the costs of refining at Royston, and the availability of the new solvent extraction technology.

The refinery is planned to start operations late in 1988 and will require a larger number of people than employed at Wadeville. Most of the employees at the Wadeville will be offered work at the new refinery.

Extension delayed 'indefinitely'

# Europe holds out against coal sanctions

LONDON — West Germany and Portugal held the line against a possible European ban on SA coal imports yesterday. And after a meeting of Foreign Ministers from the 12 EC countries it seems an extension of sanctions has been delayed indefinitely.

British Foreign Secretary Geoffrey Howe, current president of the European Council of Ministers, said "No conclusion was reached. It remains part of the measures on which there is no consensus."

Howe refused to detail the discussions, but officials said there had been no change in positions taken by European governments in Brussels in September, when limited sanctions were approved but coal — one of SA's major export earners — was dropped from the package.

Sources confirmed that West Germany

and Portugal had maintained their opposition, while the Dutch and Scandinavian governments pressed for the inclusion of coal, which last year realised R2,3bn in European sales.

After the Brussels meeting, the British government was given a mandate to continue to seek consensus on coal. But yesterday that was clearly impossible and officials were reluctant to predict when the deadlocked situation might change.

SA was not a major issue at the London meeting and was well down on the agenda as Foreign Ministers struggled with the problems of East-West relations, Latin American policy and Syrian-backed terrorism.

The decision taken in Brussels banned European imports of SA iron, steel and gold coins, as well as blocking new investment

Iron and steel exports to Europe last

● To Page 2

## No EC consensus on SA coal ban

year were worth R777m, but a series of complex definitions about which products could not be purchased has brought the impact down to a lot less than that.

The ban on new investment has proved even more difficult to implement, and European government officials are still working out the details.

The only formal statement on SA after

yesterday's meeting was the familiar joint declaration that everything should be done to promote dialogue between black leaders and the SA government, and that in Southern Africa as a whole it was necessary for "restraint to be exercised on all sides". — Sapa.

← ● From Page 1

BWD/AM

11/11/86

217

11/11/86 BWD/AM

217

387



# EEC split on SA coal ban

By Michael Morris  
The Star Bureau

Europe has failed for a third time in just more than a month to reach agreement on banning South African coal.

West German opposition blocked consensus among the EEC's 12 foreign ministers.

Any further EEC-wide action against SA — like adding a coal ban to existing measures — must have the unanimous backing of all member states.

The EEC has, however, affirmed its backing for financial and other aid to South African blacks and the Front Line states.

The South African issue was eclipsed yesterday by the debate on Syria's links with terrorism and European measures against Damascus. And when the 12 ministers finally turned to Southern Africa it was merely, according to British foreign secretary Sir Geoffrey Howe, a "brief review".

Holland — backed by Denmark and Ireland (which both have own coal bans) — restated its plea for the ban to be included in the truncated package agreed in Brussels in September.

Holland argues that without a coal ban the measures are too weak and are neither meaningful nor effective.

West Germany says a ban on coal will cause further unemployment in South Africa and increase racial friction. And West German foreign minister Mr Hans Dietrich-Genscher refused to budge.

In his statement afterwards, Sir Geoffrey said there had been no agreement on a coal ban, but the foreign ministers had emphasised the importance of continuing to seek progress through dialogue. He welcomed steps to improve the co-ordination of positive measures.

# Private investors in platinum rush

12/11/86  
27  
By Stan Kennedy  
SMK

Private investors are once again big buyers of platinum bars and coins, with current demand indicating that more than 400,000 ounces, or the combined total for the past two years, will be absorbed by this sector in 1986 as a whole.

In its interim review for 1986, Johnson Matthey estimates total Western demand for platinum this year will be 2,82 million ounces — 10,000 ounces more than last year.

It expects supply to fall short of demand for the second successive year but the gap may be narrower at 2,81 million ounces compared to 2,74 million ounces.

What could be quite sharp falls in jewellery sector consumption and demand for larger investment pieces in Japan are likely to be balanced by substantial increases in sales of small bars and coins to investors in the US.

The review also sees a rapid rise in the use of platinum as an motor catalyst in Europe, where it projects a take-off of 120,000 ounces, a fourfold increase over the total for the previous two years.

Preliminary estimates indicate platinum demand in the US will fall slightly but this will be compensated by a sharp increase in Western European demand and some growth in Japan.

The overall picture is of an increase in Western world demand for use in autocatalysts to about 60,000 ounces more than the 1985 total of 935,000 ounces.

The review says that supplies from South Africa will be slightly higher than last year because of the rising market price having encouraged the two major producers, Rustenburg and Impala, to maximise output from existing capacity.

“Demand has gained powerful added stimulus in the past year from the situation in South Africa.

“New investment has generally exceeded disposals and no significant quantities of small bars or coins have been returned to fabricators or refiners.”

The second highest outlet for platinum is jewellery, with 80 percent of industrialised nations' demand in this sector coming from Japan.

Higher yen prices for platinum are expected to bring reduced demand for jewellery and a provisional estimate is of an eight percent drop in sales of new metal to Japanese industry.

## SPECULATIVE

“Against a background of overall increased demand and the speculative pressures stemming from South Africa's political situation, which have pushed up the price, market conditions remain unsettled and prediction of its future price trend is not easy.”



Special was 1000

CNY 7000

14/11/86

period last year

217

# Platinum drops \$40 in 10 days

Own Correspondent

LONDON — The price of platinum is toppling as speculators unload the rare metal they snapped up earlier this year on a hunch that SA might restrict supplies

In London yesterday platinum was quoted around \$533 an ounce, down nearly \$40 in 10 days

It dipped as low as \$520 on Wednesday before bargain-hunters did some buying

Geoffrey Robson, with London metals dealers Johnson Matthey, said the market faced "many weeks of short-term ups and downs"

Prices peaked at their highest in six years on September 5, up at \$673.75

from \$460 at the beginning of August, after speculators took an interest

They thought SA might retaliate against economic sanctions by curbing the supply of platinum SA supplies more than 80% of the West's platinum requirements

The metal has become increasingly important in the car industry, where about a third of the world's supply is used in catalytic converters for converting poisonous exhaust fumes into non-toxic gases

Another third of the world's platinum is used in jewellery

The metal closed in London yesterday at \$529 an ounce

# Gold, platinum prices plummet

12/11/86 BUS DAY 217

GOLD has slipped below the \$400 mark as precious metals slump on world markets.

The New York gold price fell to \$396,75/\$397,75, finishing at about \$398,80, down from the London Friday afternoon fix of \$408,25. The metal closed in Hong Kong on Saturday around \$398.

And platinum futures plunged the daily limit of \$25 on Friday as speculators continued to sell contracts in a fast-moving market at the New York Mercantile Exchange.

The New York platinum price plummeted to \$502,30, down \$30,70 on the London Friday afternoon fix. Platinum for delivery in January ended at \$509,90, falling \$53 in the week to three-month lows. The decline has been attributed to speculators unloading stocks on rumours of SA restricting supplies.

As far as gold is concerned, a fall

LIZ ROUSE and REUTER.

through the resistance point of \$403 is considered by some analysts to be the crucial mark for a potential decline to \$385.

The metals' decline mean that Diagonal Street — which coped in a professional manner last week with a huge US sell-off of gold and other mining shares to transmit funds ahead of the US Congress deadline for new investment — faces another uncertain week.

Good local absorption of non-residents' stocks and a decline on the financial rand to about \$22,50, which dried up foreign selling, stabilised the JSE all-gold index at 1 898 on Friday after last week's low of 1 831.

However, a lower firrand (which

● To Page 2



## Gold plunges below \$400 mark

12/11/86 BUS DAY

cushions declines in mining shares) and short-covering by precious metals operators might brighten the picture today. New York traders said weakness in the gold market spilled into platinum

amid an absence of the type of supportive news concerning SA that fuelled a speculative buying binge last summer

● From Page 1



# Cosatu slams platinum plant move

18/11/86  
ALAN FINE  
A MEETING of the Congress of SA Trade Unions (Cosatu) central executive committee this weekend condemned the decision of Mathey Rustenburg Refiners to relocate its Wadeville platinum refinery in Bophuthatswana

Cosatu described the move which, it said, was taken without consulting the Chemical Workers' Industrial Union, as reflecting support for "apartheid's bantustan policy".

The meeting also demanded that General Motors reinstate all workers dismissed during the present strike and "accede to all demands of workers" It listed a number of conditions to which companies planning to disinvest should adhere

Cosatu further condemned the "vio-

lent attack on unarmed and defenceless workers" at the Metal and Allied Workers' Union annual general meeting at Curries Fountain, Durban, on Sunday.

Meanwhile a delegation from the Chamber of Mines met officials of the Department of Manpower yesterday for talks over the ban on Mozambican migrant labour, which was imposed after a landmine explosion in Natal several weeks ago.

After the meeting, the chamber would only confirm that it had taken place and that talks would continue. However, the mining industry is concerned about the ban, which effectively prevents the recruitment of Mozambicans and the renewal of contracts of those already working in SA

COMPANIES

217  
412/86  
PAU-DAM  
New ventures  
to boost Vansa

CHERILYN IRETON

VANSA VANADIUM'S earnings should improve by about 10c a share in the current year as a result of the acquisition of the Winterveld Chrome mines and participation by Rand Mines in the platinum venture on Kennedy's Vale, near Lydenburg.

Vansa has just reported earnings of 3c a share for the nine months to September. The financial year-end was changed to accommodate the deal with Rand Mines

A circular to Vansa shareholders explaining the deal says other financial benefits may emerge from the rationalisation of resources between Kennedy's Vale and the chrome mines, which are 11km apart

Meanwhile development of Vansa's vanadium mine is under way. Chairman David Marshall says in his annual report that work on the layout, design and establishment of the mine and recovery works has proceeded swiftly

The plant, on which construction was to have begun in mid-November, is expected to be commissioned by June 1988.

However, Vansa has been plagued by the scarcity of suitable second-hand equipment and the drop in the value of the rand against other currencies.

Marshall says these factors have been partially offset by limiting the foreign content of plant units and amending design to trim initial budgets.



Rustenburg  
miners to get  
wage increases

Workers at the Rustenburg Platinum Mines are to get wage increases of between 3,8 and 5,6 percent and a number of leave benefits, the Federated Mining Union said.

The increases, negotiated in July, will be back-dated to October.

Maternity leave will be for 26 weeks and 56 days a year, accumulated to a maximum of 112 days, with leave for injuries sustained in mine accidents, the union said.

The union said that both staff members and non-members would benefit from the wage and leave packages

84.80	882.03	1165	0.4476	0.2288	2.0105	0.3124	8.65	1837.9	1500.1	1945.0
-------	--------	------	--------	--------	--------	--------	------	--------	--------	--------

22/12/86  
RUSDA-1

(217) ~~250~~ ~~280~~

**SIMON BARBER**

WASHINGTON — Congress's ban on SA uranium imports, due to go into effect at the end of the month, is threatening thousands of US jobs and US security

So say two senators who voted for the sanctions Bill and now wish they had not.

Mitch McConnell and Wendell Ford, both of Kentucky, fear the ban will force a major enrichment plant in their state to lay off workers or even close down.

The Paducah gaseous diffusion plant, operated by the Department of Energy, is contracted to enrich SA

## Senators slate embargo of SA uranium

uranium for various overseas customers, chiefly Japan and Taiwan.

As written, the ban appears to prohibit all SA uranium, even if re-exported after processing, and would thus automatically nullify Paducah's contracts with any customer using SA material.

The Reagan administration has looked in vain for an alternative in-

terpretation since the Bill was passed on October 2.

Ford, a Democrat, and McConnell, a Republican, are pleading with the administration to grant an exemption for trans-shipped uranium when they publish the final regulations implementing the ban

The fear is that although only 10% of uranium enriched for export at Paducah, and a similar facility at Portsmouth, Ohio, is of SA origin, clients who buy their uranium from various sources would consider the discrimination against SA material a breach of contract and take their business elsewhere, including to the Soviet Union.

Disarmament in



Reagan risks wrath of Democrats

# Sanctions loophole for SA uranium

24/12/86

BUS DAY

217

WASHINGTON — Risking the wrath of pro-sanctions Democrats, the Reagan administration has decided to allow certain SA uranium oxide imports to continue for six months despite a Congressional ban due to go into effect on December 31.

The delay, which covers SA uranium purchased by third countries and sent to the US for processing, is in response to urgent warnings by six senators, four Republicans and two Democrats, all of whom voted for sanctions, that the ban could cost "thousands of jobs" in their states.

The move is expected to trigger howls of protest from other members of Congress who are already complaining that the Administration is dragging its feet on implementing the comprehensive Anti-Apartheid Act passed on October 2.

The six concerned legislators, led by Kentucky senators Mitch McConnell, a Republican, and Wendell Ford, a Democrat, and joined by Senate foreign relations committee chairman Richard Lugar, wrote to President Reagan last

SIMON BARBER

week pleading to have non-US-owned SA uranium exempted when the regulations putting the bill into effect were issued.

A number of foreign customers buy SA uranium oxide and send it to be processed in the US

The oxide is converted into uranium hexafluoride by two US firms in Illinois and Oklahoma, and then enriched at government facilities in Kentucky and Ohio. The enriched material is fabricated into fuel rods by a third set of entities and finally delivered to the overseas customer.

The senators, who also included Oklahoma Democrat David Boren, told the President they believed they had reached a legally-binding agreement during the sanctions debate last August that would have permitted this cycle to continue.

They fear that even though only between 10% and 13% of the uranium enriched for foreign clients is of SA origin,

● To Page 2

## Loophole for SA uranium

customers would be entitled to consider the ban on material they had already agreed to buy from SA a breach of contract and thus take all their business elsewhere

This could mean heavy layoffs at the two plants, which employ more than 3 200 people, as well at the conversion and fabrication companies.

McConnell yesterday informed voters in Kentucky that the Administration had agreed to withhold a final decision for six months in order to give Congress time to clarify its "intent" on the issue.

"Foreign uranium bought from SA and sent for enrichment and then immediately sent out of the country was not meant to be covered by the bill," he said.

Senator Edward Kennedy, one of the driving forces behind the sanctions, has strenuously objected to this "loophole", arguing that Senate specifically rejected the exemption by a 56 to 40 margin when it was offered by Ford and McConnell as an amendment

● From Page 1

24/12/86

BUS DAY

# Platinum output poised

## to surge

W/St Argus 27/12/86 217

### From NEIL BEHRMANN

LONDON — South Africa's platinum output is expected to surge next year.

In a report, Shearson Lehman Brothers estimates that South African platinum production will surge from 2.3-million ounces in 1986 (1985 production was 2.39-million) to nearly 2.6-million ounces in 1988.

Soviet exports will remain around 300 000 ounces a year. So total world platinum supplies will increase in spite of sporadic strikes and mine violence in South Africa, Shearson believes.

### NEW MINE

Northam, a new platinum mine owned by Gold Fields of South Africa, will produce 220 000 ounces a year from 1990, Shearson predicts. Rustenburg and Impala platinum mines are by far the world's largest.

The firm reckons that supplies of platinum will exceed industrial demand by a small margin, but the market is so small that any investment and speculative purchases will continue to create wide price swings.

Shearson doubts that platinum's premium over gold can stay above \$100 for any length of time. The proviso is a sharp curtailment of supplies which the firm believes unlikely.

Platinum, priced at \$485 an ounce, is currently at a premium of \$90 or 23 percent over gold. If the premium remains high, more money will shift from platinum into gold and silver because jewellery fabri-

caters and investors are price sensitive, says Shearson.

Meanwhile, gold mining development in Zimbabwe is increasing at a rapid pace, says London broker Williams de Broe.

Mining output in Zimbabwe surged from 11.4 tons in 1980 to around 15 tons this year, in spite of Zimbabwe's internal economic difficulties and border problems with South Africa.

Huw Williams, mining analyst at Williams de Broe, estimates that from 1988 onwards, production will be at least 17 tons a year.

Breaking its links with South Africa, Zimbabwe has begun refining its gold in Western Australia. But with the help of Western Australia it will establish a gold refinery in Harare.

Groups actively mining gold in Zimbabwe are Rio Tinto Zinc, Lonrho and Anglo American Corporation.

Falcon Mines and Cluff Oil Holdings are also producing, and Cluff in particular will be producing about one ton a year from 1988 via the Bindura deposit in Northern Zimbabwe.

Williams de Broe estimates that Western gold production will have surged by 17 percent to 1 339 tons between 1984 and the end of 1987. This demand will be matched by orders for coins and investment, especially by the Japanese, the report says.

The firm predicts that gold prices will rise next year, and of the South African shares it favours Driefontein, Freegold, Hartbeestfontein, Randfontein and Vaal Reefs.



## New US anti-apartheid regulations remain a mystery

# Departing firms in dark

US COMPANIES quitting SA are still in the dark about the implementation of stringent US anti-apartheid regulations.

The regulations are intended to enforce the US congressional ban on investment in SA

Copies of the regulations are not yet available and affected companies say they are not conversant with them

"Until we see the regulations, it is very difficult to know what is and what is not illegal," says Leo Cecchum, the US consul for economic affairs

"The law is designed to prevent expansion and new investment and not to stop payment of debts. The intention of the regulations is not for companies to go bankrupt

"What will probably change is the buy-back option and the concept of

RICHARD BARTLETT

share-selling to retain control of SA subsidiaries. This is at present a cloudy area," he says

Outgoing MD of General Motors Bob White says that although he has not had an opportunity to see the regulations, he does not foresee any change in GM's plans to disinvest

"The rulings have been in effect since the Senate veto and GM people in the US have worked with the Treasury concerning these regulations."

White does not believe GM would have gone thus far if its actions were found to be illegal in US law

"No funds will be transferred from the US to complete the change of ownership," he says

A spokesman for Honeywell says the main transfer will be in technology and so no immediate impact is expected. "There will be no import of funds and growth of the company is financed locally," says Honeywell's market development manager Duncan Todd

Coca-Cola is not aware of the implications of the regulations, but a spokesman says he does not see any difficulties. Other US multi-nationals, not dependent on US funds, do not expect repercussions. Many companies are waiting to see how stringent the regulations are and what they mean before reacting to them.

A spokesman for IBM had no comment to make.

But market sources say the company, despite a recent announcement of a buy-out by local employees, will not be affected.

19 December 1986

## NATIONAL PROPERTIES LIMITED

("NATPROP")

Reg No 68/04109/06

### ANNOUNCEMENT TO SHAREHOLDERS

Shareholders are advised, that in compliance with an extension of time granted by the Registrar of Companies, they were mailed Natprop Provisional Unaudited Financial Statements at 30 June 1986 on 30 November 1986. The audited financial statements for the year are still in the course of preparation. Recently settlement has been reached, in respect of disputed claims, with B&D Inry Teaters and Metropolitan Life Limited and

## Tax gaps for mining

THE mining industry can save money by interpreting exemptions to the General Sales Tax act liberally.

So says Ernst & Whinney tax consultant Ken Walton in the latest tax bulletin of the Transvaal Chamber of Industries.

"Many mines are dealing with the tax question of GST on an ad-hoc basis. In consequence there is not the uniformity which one would wish. Some mines are unquestionably paying too much GST while others may not be pay-

CHEMILYN IRETON

ing enough," says Walton. An example is the exemption for parts and materials used to repair and maintain certain plant. Walton says the tax authorities have agreed that the plant specified in the act can be interpreted more widely than the list suggests.

He says companies supplying plant to the mines should examine the laws and then review what items have been taxed in the past.

**Lyd Plat**  
pushes  
earnings  
up 44%

CHRIS CAIRNCROSS

LYDENBURG PLATINUM (Lyd Plat), whose main income comes from dividends received from platinum producer Rustenburg Platinum, has benefited greatly from this investment in the year to October.

In its annual statement this investment company, in which SA Mutual has a 56% controlling interest, reports an earnings improvement of 44%, from 72.7c to 104.7c a share

Pretax income amounted to R15,08m (R10,69m), reflecting growth of 42% as a result of the sustained strength of the platinum price/market over much of the year.

These results have enabled Lyd Plat to boost the total dividend pay-out to 104c (72c), the final dividend being lifted to 64c (44.5c).

Apart from its primary holding in Rustplat, Lyd Plat's other investments are in Genbel, Free State Consolidated Gold Mines, and Orange Free State Investments

Market capitalisation of these investments at Lyd Plat's year-end amounted to R523.2m (R270.4m).

BUS DAY 31/12/86

217

MINING — OTHER

1987

JANUARY — DECEMBER.



# SA uranium is pouring into US despite sanctions

SMK 4/18/87  
The Star Bureau

217

WASHINGTON — Millions of tons of uranium ore from South Africa are being shipped to the United States in spite of stringent American sanctions laws that went into effect on January 1.

But the uranium is not intended for American industry. It is being re-exported to other countries after enrichment in US conversion plants.

A decision by the Reagan Administration to permit the importation of foreign-owned uranium oxide from South Africa follows pressure by United States Senators to allow this loophole in the sanctions laws which ban South African uranium.

The Senators — including Mr Richard Lugar, former Foreign Relations Committee chairman, who led the sanctions drive last year — warned President Reagan that banning all uranium, including stocks bought from South Africa by third countries, would cost the US thousands of jobs.

It would also injure the US conversion industry, lose business opportunities to foreign competitors including the Soviet Union and release millions of tons of uranium into the world market without US control, they warned.

## KEEPS TRACK

In terms of the Nuclear Non-Proliferation Act, the US tracks all uranium processed in America for the rest of its life in the hopes of keeping it out of the hands of countries, such as Libya.

The uranium oxide from South Africa goes to plants in Kentucky, North and South Carolina, Virginia, Oklahoma, Ohio and Missouri where it is converted into uranium hexafluoride.

The United States dominates the uranium conversion industry with only France, Canada, Britain and the Soviet Union providing competition.

The Senators, all from areas where jobs were threatened, feared that an over-zealous interpretation of last year's sanctions laws would have had severe economic repercussions in their states.

However, in a telegram signed by Mr Gerald McManus, Assistant Commissioner of the US Customs Service, customs officers have been ordered to allow South African uranium to enter the US — as long as it is held in bond during enrichment and sent on afterwards to its original buyers.

The customs officers were told, however, that no South African uranium should be admitted in any circumstances without a specific licence issued by the US Nuclear Regulatory Commission.

Fears of job losses in ailing nuclear industry

# Loop-hole lets

# SA uranium

8/1/87

# into the US

WASHINGTON — Fearing that the congressional ban on SA uranium imports will prove highly damaging to the already ailing US nuclear industry and increase risks of nuclear proliferation, President Ronald Reagan's administration has punched a giant loophole through the law.



Regulations implementing the ban, due to be published towards the end of the month, will permit US companies and the Department of Energy to continue processing SA-origin uranium for non-US customers, a Treasury Department spokesman confirmed yesterday.

● REAGAN

The only change will be that the customers will have to obtain special licences for every shipment of SA nuclear material from the Nuclear Regulatory Commission (NRC), the independent agency that oversees all US nuclear commerce, rather than operating under blanket licences, as has previously been the case.

SIMON BARBER

The decision is expected to trigger a storm of protest from Senator Edward Kennedy and other Democrats who insist that the intent of the comprehensive anti-apartheid Act was to block all SA uranium and derivatives from reaching American shores.

Treasury spokesman Sam Richardson said the department's Assistant Secretary for Enforcement Francis Keating — who has the chief responsibility for approving the regulations — had decided that processing SA uranium for third parties "does not directly benefit SA and will therefore be permitted".

The administration had earlier sought to delay implementation of the ban for six months pending what the NRC called "final clarification of the scope of the Act" in hopes of persuading the legislators to enact the loophole of their own accord.

The chances of this happening were apparently so slim — and the stakes so high — that the Treasury decided to take

● To Page 2

Police's deaths

LONDON — Britain is stepping up its efforts to help wean the Frontline states away from economic dependence on SA. This has emerged

UK  
Fro

217

# US will still process SA uranium

matters into its own hands and face the outcry.

And the stakes are high

According to an analysis prepared by the NRC, the ban as interpreted by Kennedy and his allies would have "a substantial economic impact on those private US industries that convert SA-origin uranium oxide to uranium hexafluoride for enrichment purposes for use by both domestic and foreign utilities"

The conversion companies — Allied Chemical and Kerr McGee — "represent a \$100m industry employing over 1 000 persons, and, with respect to just their foreign customers, over 20% of the industry's throughput of uranium hexafluoride is SA-origin material", the NRC maintained

"There also could be a substantial impact on Department of Energy enrichment services performed for foreign customers should the foreign users divert their conversion and enrichment contracts to other suppliers"

"In the past year, the Department of Energy's enrichment contracts involving SA uranium were valued at approximately \$200m. The foreign users most likely to divert their services to other

suppliers would be in Japan, Taiwan and Spain"

Emphasising the importance of foreign-owned SA uranium to US processors, the NRC added that the ban would have "minimal impact on the domestic power industry which imports almost no SA uranium for domestic use"

As the law is written, uranium hexafluoride produced from SA material is not banned, so foreign customers could theoretically have their SA uranium converted elsewhere before sending it on to the Department of Energy's Paducah, Kentucky, and Portsmouth, Ohio, enrichment facilities

While this would only hurt the conversion firms, the expectation has been that the foreign customers would use it as a justification to break their enrichment contracts and seek cheaper services in Europe or the Soviet Union

The prospect so alarmed two Senators from Kentucky, Republican Mitch McConnell and Democrat Wendell Ford, that they wrote to Reagan warning that unless foreign-owned SA uranium was exempted "thousands of American jobs would be lost"

8/1/87

BUD

From Page 1

217



12/11/87  
Gold, platinum  
soar  
Dispatch

JOHANNESBURG

Gold and platinum broke through current barriers at the weekend against a background of turmoil in European currencies and bearish sentiment on the dollar

Precious metals prices soared as European Community finance ministers scurried to set up a meeting to realign currencies within the European Monetary System (EMS), in disarray as the West German mark climbed and the French franc sank last week.

The gold price went through the \$405 mark in New York on Friday and in Hong Kong on Saturday

On the Commodity Exchange in New York, gold closed at \$406, up from \$402,30 late Thursday. It opened at \$405,79 in Hong Kong

Platinum futures surged on the New York Mercantile Exchange on Friday as speculators interpreted the metal's ability to breach the \$500 level as a buy signal

Platinum began its assault on \$500 an ounce on Thursday when the January contract closed at \$494,90, up \$12,50 — DDC

## Turmoil in European currencies

# Gold, platinum break barriers

CAT 712B 12/1/87 (217)

Own Correspondent

JOHANNESBURG — Gold and platinum broke through current barriers over the weekend against a background of turmoil in European currencies and bearish sentiment on the dollar.

Precious metals prices soared as European Community finance ministers scurried to set up a meeting to realign currencies within the European Monetary System (EMS), in disarray as the West German mark climbed and the French franc sank last week. The gold price went through the \$405 mark, the resistance point on charts, in New York on Friday and in Hong Kong on Saturday.

On the Commodity Exchange in New York, gold closed at \$406, up from \$402.30 late Thursday. It opened at \$405.79 in Hong Kong.

### Signal to buy

Platinum futures surged on the New York Mercantile Exchange on Friday as speculators interpreted the metal's ability to breach the \$500 level as a buy signal.

Platinum began its assault on \$500 an ounce on Thursday when the January contract closed at \$494.90, up \$12.50.

Steve Chornowitz, director of commodity research in New York at Smith Barney, Harris Upham & Co, said the \$500 level was considered significant because it represented the highest price of the past eight weeks.

The January contract closed at \$520.90 on Friday, a gain of \$26.

Chornowitz said that although political instability provided underlying support, the rally was triggered mainly by speculators who follow technical trading factors. Gold was also boosted by technical factors as buying emerged when the price showed strength at \$400, he said.

The surge in the gold price justified the JSE's gold fever, which pushed the All Gold Index to a near record level of 2 073 on Thursday in hectic dealing. The index closed at 2 068 on Friday, having jumped 8.4% on the week.

However, a successful realignment of European currencies and Japanese determination to lower the yen could affect the strong precious metals' up-trend.

The EMS, a mechanism for stabilizing European exchange rates, has been forcing Bonn to intervene heavily to narrow the gap between the rising West German mark and the falling French franc.

Dealers said West Germany's Bundesbank bought more than one billion French francs on Friday to keep the currency from falling through the floor within the EMS.

The central bank also bought an estimated \$40m to \$50m in an unsuccessful attempt to prevent the US currency from falling in Europe.

### Devaluation of franc

The turmoil in European currency markets fuelled speculation that France may be forced to accept devaluation of the franc, the Danish central bank said.

The European situation had little bearing on the dollar (which was slightly higher against key currencies on Friday), except when it also became the subject of intervention by overseas banks to dampen the West German mark.

In Tokyo, where trading ends before Europe's business day begins, the Japanese central bank spent more than \$2 billion to push the dollar up against the Japanese yen. A strong yen makes Japan's exports more expensive.

In New York, the dollar closed at 158.33 yen, up from 157.54 on Thursday.



# Palamin copper production down

14/1/87 BUDDY

217

COPPER production by Palabora Mining (Palamin) dropped 4% in the December quarter to 30 954 tons, compared with the September quarter, but was still above the two-year quarterly average for the Rio Tinto Zinc base-metal producer.

Total copper production for the year at the Northern Transvaal opencast mine, South Africa's largest producer, was 117 411 tons, down 1,4% from 1985's 119 119 tons.

Mill throughput in the December quarter was 7,42-million tons, bringing the year's total to 29,4-million tons (27,1-million tons) Increased tonnage milled (at lower grades) over the year is attributed to 90 days of mill downtime in 1985. Grade during the year was

PETER STACEY  
Mining Editor

down about 5% on 1985 results at 0,48% (0,51%).

Increased demand for vermiculite and magnetite boosted sales of these minerals by 6% and 4% respectively during the year Vermiculite sales for the year were 187 129 tons (175 275 tons). Magnetite sales improved to 110 726 tons (106 432 tons). Together with zirconia and other products, these minerals as a rule contribute about 13% to overall revenue

Precious-metal content of anode slimes production in the fourth quarter improved to 2 442kg, compared with the previous quarter, but overall production was down 5,6% to 15 137kg

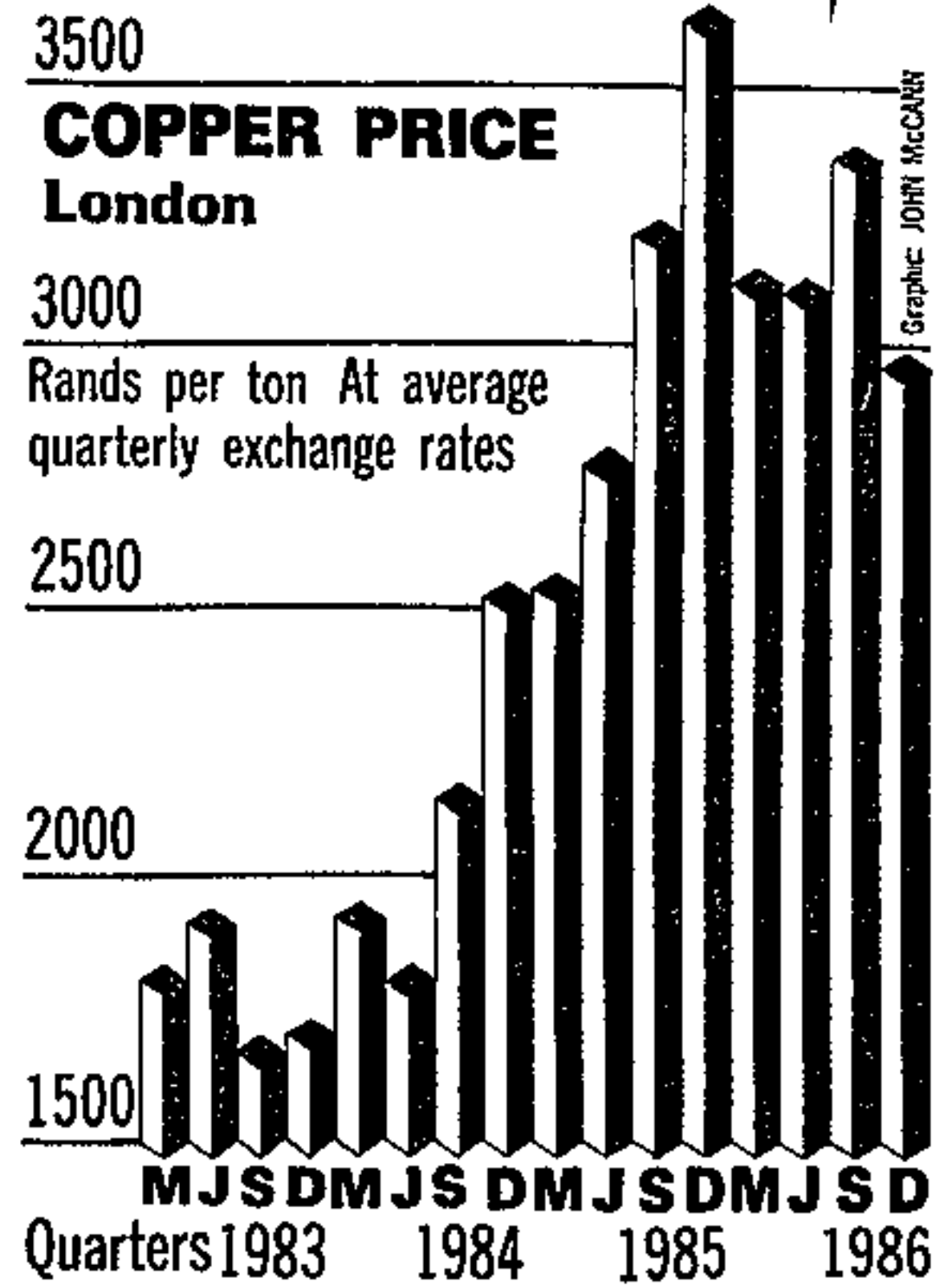

(16 045kg) in the year. This accounted for R22,3m, or 5%, of total revenue of R450m for Palabora in 1985

No uranium concentrates were sold in the quarter, but total sales for 1986 were 325 651kg, against no sales for the previous year

✓

16/11/87 FCN/MHL

217

# Polishing up on profits

As the sanctions campaign against SA forces a closer look at the beneficiation of the country's mineral wealth, attention is turning increasingly to chrome

Government is now being urged to take the initiative in developing a viable, export-based stainless steel industry. Experts say this has the potential to increase current earnings from chrome ore exports seventy-fold

In the face of strong demand for so many of its primary products, SA has lagged behind the rest of the world in the drive to add value to exportable raw materials.

For instance, while SA has almost 70% of the world's known chromium reserves, it currently provides less than 1% of international stainless steel production

Raw chrome ore earns some R100/t on world markets while ferro-chrome sells for about R1 000/t. But it is during the third and fourth stages of beneficiation that earnings really rocket

Stainless steel plate currently sells for R3 000-R3 500/t while finished products can earn R6 000-R7 000/t — or about 70 times more than raw ore

"Government should support or subsidise a major stainless steel manufacturing plant along the lines of Iscor or Sasol," says Mintek president Aiden Edwards. "While this could involve an investment of R1 billion to R2 billion it would set off major growth in the stainless steel industry"

With investment of that order, and considering the current economic climate, State aid is seen as the only possible stimulant for the industry. Support would also be needed while the industry finds its feet in the early, high-risk stage while fighting its way into international markets. Edwards says the private sector could go into partnership with government, or the industry could be privatised at a later stage

While there's much to be said against the State adding to the list of protected industries, mineral experts argue that the benefits in export earnings and job creation, particu-

larly in the special case of chrome, outweigh the dangers

South African chrome exports last year topped R1 billion for the first time, with ferro-chrome sales accounting for some R750m. But with the West virtually dependent on SA and Zimbabwe for its strategic chrome supplies — the only other major source is Russia — clearly SA has not yet played its chrome card

"Chrome — like manganese and vanadium — is a strategic mineral for Western armaments industries," notes George Malan, executive director of the Stainless Steel Development Association. "But, whereas other State-supported projects like ADE, Sasol and Afprene were started for strategic reasons, an indigenous stainless steel indus-

plant could earn R300m-R350m a year while providing about 2 500 jobs. But if the investment led to more downstream production, earnings would rocket and many more jobs could be created. The major problems at this stage, Millar adds, are sanctions threats, the confidence required for such an investment, finance and lack of skills

Joint ventures with Eastern countries such as Taiwan or Korea could be part of the solution. But Millar cautions against this, pointing out that the partner could pull out at a critical stage if the climate changes. The major benefit of a joint venture would be the skills rub-off and marketing connections

Edwards is adamant that an investment in a stainless steel plant should be seen as a long-term commitment, while he sees sanc-

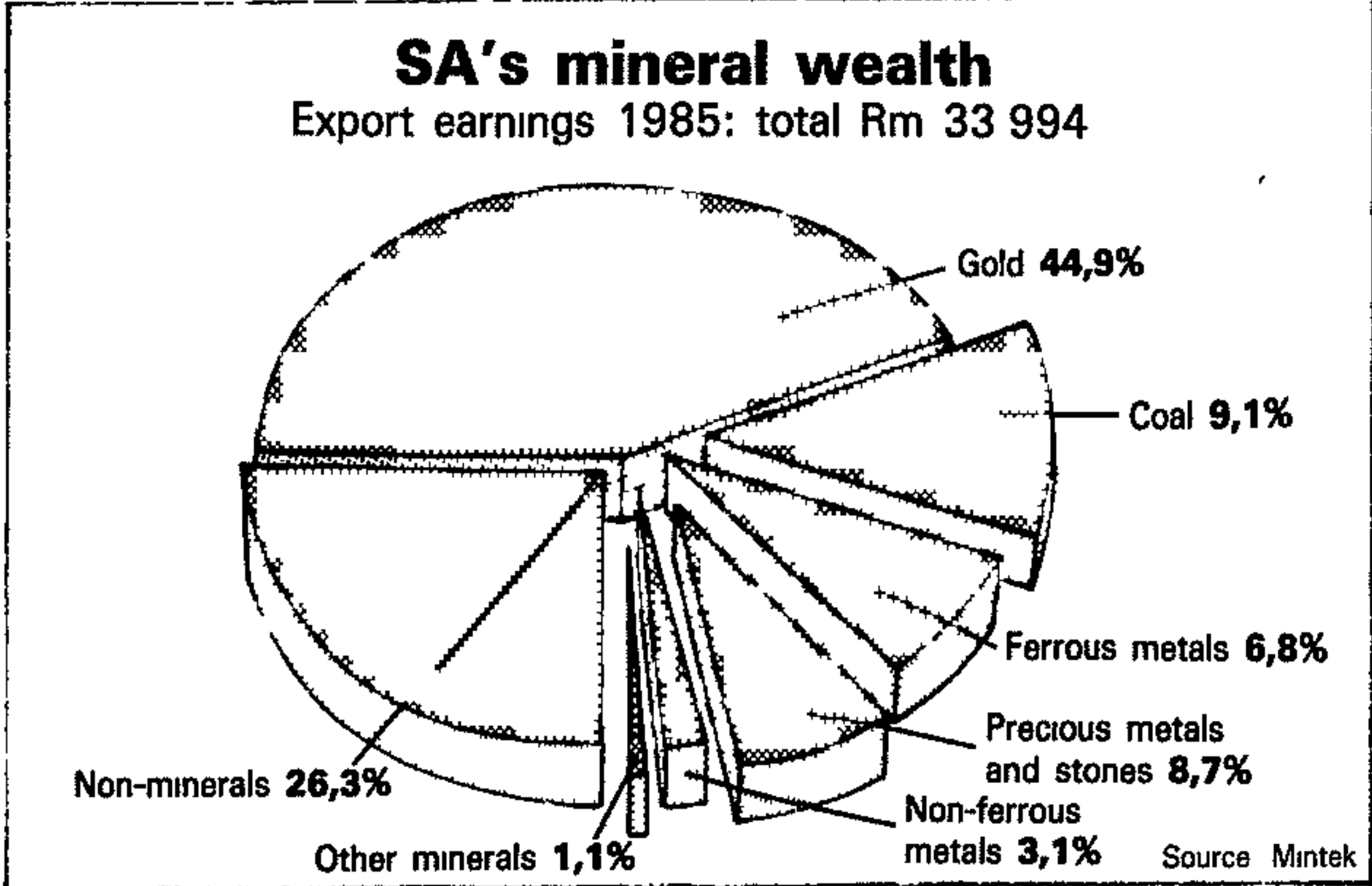

try makes straight economic sense"

Gavin Millar, Middelburg Steel and Alloys marketing strategy manager, says a stainless steel plant with a capacity of 100 000 t a year, similar to his group's plant at Middelburg, would now cost R800m-R900m and would take two to three years to reach breakeven point

"Flat stainless steel exports from such a

tions and other political problems in SA as essentially short- to medium-term problems

"We have to look beyond our immediate constraints," he says. "By investing in the future of our minerals industry we will ensure future growth, job creation and a thriving local manufacturing industry. Adding value to our mineral riches is the precondition for future economic growth"



US cannot do without us

# Exempted minerals earn SA billions

BUSDAY  
280  
217  
19/1/87

THREE of the strategic minerals exempted at the weekend from US sanctions provide SA with an estimated annual revenue of more than R4bn from all sources.

And Mineral and Energy Affairs director general Louw Alberts says by exempting 10 strategic minerals from sanctions the US has tacitly acknowledged it cannot do without SA.

"The Americans seem to be waking up to the realities of sanctions and the position of SA in the Western world's mineral supply," Alberts said yesterday.

The 10 minerals that have been exempted are andalusite, antimony, chrysotile asbestos, chromium and ferromanganese, cobalt, natural industrial diamonds, manganese, ferromanganese and ferrosilicomanganese, platinum-group metals, rutile and titanium-bearing slag and vanadium.

Of the minerals exempted, chrome, platinum and manganese are the most important to the SA economy, with estimated annual revenue totalling more than R4bn.

Alberts said the minerals in question were of vital strategic importance to the US.

"As for the hypocrisy of turning sanc-



ALBERTS

PETER STACEY and SUSAN RUSSELL

tions only in one direction to suit themselves, I leave that to their leadership and their conscience."

He did not have figures available on what percentage of these minerals SA exported to the US or how much money was involved.

"But seeing as platinum is one of them we are talking in billions."

Minister of Economic Affairs and Technology Danie Steyn described the US decision as "very selfish", but added that government did not intend to withhold these minerals.

"We are not sanctions supporters, therefore any decision that is anti-sanctions is welcomed," said Steyn.

"They are protecting their own interests. So while we are pleased about it, especially for the producer's sake, it is of course very selfish."

"It indicates that the whole sanctions thing has two legs. Firstly they want to get at SA, but they also want to ensure their survival in specific fields."

Steyn added that while he was pleased with the decision, he hoped the exemption would be extended to other minerals.

He said the exemption could have a flow-over effect on American companies under pressure to disinvest in SA.

"I intend to study the whole report

To Page 2



## SA's exemption bonanza

BUSDAY  
217 280 337  
From Page 1  
19/1/87

tomorrow. It is difficult to make a comprehensive comment at this stage because I do not really know what is behind the decision."

SA produces 82% of the world's platinum group metals (PGMs) — platinum, palladium, rhodium, osmium and iridium.

Apart from its use in the manufacture of jewellery, one of platinum's most important uses is as a catalyst to cut down on harmful exhaust gas emissions from internal combustion engines. Other important applications for PGMs are as catalysts in the chemical industry and in electronics.

The platinum reserves of the Bushveld Igneous Complex are the largest proven reserves of the metals. Apart from a low grade deposit, rumoured to be large, but as yet unproven, in Montana in the US, the only other PGM resources of any significance are in communist bloc countries.

Chromium metal is a vital component in the production of high quality steels and alloys. Chromium chemical compounds

are particularly its oxides, and the chromates of sodium, potassium and calcium, have important applications as process catalysts, oxidants and pigments, and in photography.

At present SA is the world's number one producer of chrome, accounting for 33% of world chrome ore and concentrates and 30% of ferrochrome. SA also has the world's largest known reserves of chrome. Other major sources are Zimbabwe and the Soviet Union.

In production of manganese and ferromanganese, SA rates fifth in the world, behind the Soviet Union, China, Japan and Norway.

Manganese is an important alloy, particularly in the production of abrasion resistant steels. Rutile is a source mineral for titanium, but also has importance as a refractory material.

Titanium, because of its lightness, high strength and resistance to corrosion is the ultimate space age metal.

SUN TIMES  
18/11/87  
217

# U.S. drops strategic minerals from its trade ban

Sunday Times Reporter

THE US Government has dropped 10 South African-produced strategic minerals from its sanctions package — because they are essential to US defence.

The remarkable turnabout has revealed again the difficulty American officials are having in implementing the extensive bans imposed by US legislators.

The decision comes a week after the State Department punched another hole into the Bill by allowing US companies to work South African-originated uranium — a bid aimed at saving thousands of American jobs.

Another official said five companies have been removed from a list of 144 South African companies boycotted by the United States.

The other 139 companies are unable to export to the United States under the law because they are "parastatals" — owned, operated or subsidised by the South African Government.

The law bans the import of South African gold coins and the export to South Africa of computers and other high technology products.

## Removed

Mr John C Whitehead, Deputy Secretary of State, determined that the minerals were "essential for the economy or defence of the United States" and were unavailable from reliable or secure suppliers.

The five companies were the first to be removed from a list of 144 at first believed by the State Department to be "parastatals".

"Although they are removed from the 'parastatal' list, other aspects of the sanctions law may apply to them," one official said.



By Gareth Costa

217

# Rusplat earnings are up by 110%

Earnings at Rustenburg Platinum Holdings shot up 110 per cent to 156c a share for the six months to end-December, following the dramatic rise in the platinum price to around \$600 an ounce during the period.

The interim dividend has been increased by more than 70 per cent to 90c, and analysts now expect the total payment for the year to be in excess of 200c.

Gross sales revenue for the mine's estimated 1,2 million ounce production of platinum and other platinum group metals (PGM) was up from R720 million to R1,13 billion. Profit on sales was more than

double at R563 million

Pre-tax profit was R522 million, while the tax bill increased by a massive R176 million to R316 million, leaving after-tax profit of R195 million from the previous R92 million

In the interim statement MD Mr Brian Gilbertson says current rand prices for the PGMs are below average prices in the six months to end-December.

"If they remain as is, then the profits in the second six months of Rustenburg's financial year are likely to be significantly lower than those declared dur-

ing the period under review."

After a set-back in the price of platinum to below \$500, the metal resumed an upward trend going through the \$500 mark earlier this month, reaching \$549 yesterday after a \$17 rise

But in rand terms the rise is less spectacular, and analysts say that current prices of palladium, rhodium and ruthenium have not moved in dollar terms, and so the rand price is lower.

Original estimates of the full year earnings were 310c, but costs are expected to rise in the current period while sales reve-

nues may well drop, and earnings could be below 300c.

Sales volumes of all metals, other than nickel, iridium and ruthenium, were higher than in the comparable period in 1985. "Both higher dollar and rand prices were received for platinum, palladium, rhodium, ruthenium and gold, and the reverse for base metals"

An accounting change for the basis in which renewals and replacements provisions was done, saw earnings revised downwards from 167c on the original basis to the declared 156c.

SMPK 20/1/87

Taxed profits soar 110,8%

# Platinum price boon for Rusplats

217  
BUS DAY  
20/1/87

RUSTENBURG Platinum Holdings's (Rusplats) interim taxed profits in the six months to December have soared 110,8% to R195,8m, compared with the same period in 1985.

A buoyant platinum price, in dollar as well as rand terms, pushed sales revenue for SA's major producer to R1 133m in the half year, 29% better than in the first six months of 1986, and 57% up on results for the comparative period a year ago.

On record earnings for the first half of the financial year, Rusplats has declared a 90c interim dividend — 71,4% higher than last year's 52,5c interim (year's total 135c) — and equal to the total dividends paid for the year to June 1985.

The Johannesburg Consolidated Investments' (JCI) precious metals producer does not quantify output, but the interim report says sales volumes of all metals — with the exception of nickel and two of the platinum group metals, iridium and ruthenium — were up, and higher prices, in rand as well as dollar terms, were received for platinum, palladium, rhodium and gold. Base metal by-products, copper and nickel, were down in price.

The directors, however, caution

PETER STACEY  
Mining Editor

against over-optimism in the remainder of the year as "current rand prices for those metals from which Rustenburg obtains the majority of its revenues are below the average prices received in these six months."

"If prices remain as is," they say, "then profits in the second six months of Rustenburg's financial year are likely to be significantly lower than those in the period under review."

Platinum, the mine's prime product, kicked off the current financial year at \$430/oz, after a steady climb from \$252/oz a year earlier. A rapid advance by the metal brought a peak price of \$673 in early September, before stabilising in the \$540-\$600 range. In (some would say irrational) sympathy with gold's fall below \$400 in mid-November, the metal's price shed \$70 to trade as low as \$470, and stayed in the \$475-\$495 range to the year end.

In the first week of January, however, platinum climbed above \$500 and then

● To Page 2 →

20/1/87

## Rusplats' earnings boosted

217 BUS DAY

move rapidly to above \$530 Today the metal registered another sharp gain, closing in London at \$549 — \$17 ahead on the day

While shareholders have good reason to be pleased with a big boost to earnings, the Receiver of Revenue should be equally elated with a R316,8m bonanza in the six months reported — only R37,8m short of the entire previous year's R354,6 tax bill, and 126% up on the comparable half year.

Capital expenditure in the period totalled R78,6m (R53,2m) Construction on the new precious metals refinery at Rustenburg has commenced, the report said. Some revisions have been made to

← ● From Page 1

Rusplats' accounting approach in the current year. JCI's director for platinum, Brian Gilbertson, says the practice of estimating current and future levels of capital required for renewal and replacement of production capacity, and making provision accordingly, has been discontinued

Gilbertson said this smoothing device had been unsuccessful in the past, largely due to under-estimates of capital expenditure because of inflation. Replacement charges will now be based on actual expenditure in the period



Can Times 20/1/87

# Rusplats profits up by 110,8%

Own Correspondent

JOHANNESBURG. — Rustenburg Platinum Holdings's (Rusplats) interim taxed profits in the six months to December have soared 110,8% to R195,8m, compared with the same period in 1985

A buoyant platinum price, in dollar as well as rand terms, pushed sales revenue for SA's major producer to R1 133m in the half year, 29% better than in the first six months of 1986, and 57% up on results for the comparative period a year ago

On record earnings for the first half of the financial year, Rusplats has declared a 90c interim dividend — 71,4% higher than last year's 52,5c interim (year's total 135c) — and equal to the total dividends paid for the year to June 1985

The Johannesburg Consolidated Investments' (JCI) precious metals producer does not quantify output, but the interim report says sales volumes of all metals, — with the exception of nickel and two of the platinum group metals, iridium and ruthenium — were up, and higher prices, in rand as well as dollar terms, were received for platinum, palladium, rhodium and gold. Base metal by-products, copper and nickel, were down in price.

While shareholders have good reason to be pleased with a big boost to earnings, the Receiver of Revenue should be equally elated with a R316,8m bonanza in the six months reported — only R37,8m short of the entire previous year's R354,6 tax bill, and 126% up on the comparable half year

Capital expenditure in the period totalled R78,6m (R53,2m).

## Your guide to gilts

Name	Yield	Clean price	Cum price
RSA 12,5% 1 09 2003	15,40 (15,45)	82,77 (82,51)	87,56 (87,20)
RSA 13% 15 07.2005	15,08 (15,05)	87,14 (87,31)	87,28 (87,34)
RSA 14% 15 05 1993	14,15 (13,95)	99,35 (100,17)	101,85 (102,55)
RSA 14,5% 1 06 1987	9,10 (9,10)	101,86 (101,91)	103,81 (103,73)
Escom 10% (154) 1 11 2007	15,78 (15,70)	64,90 (65,23)	67,07 (67,32)
Escom 9 1/4% (158) 1.09 1994	14,25 (14,49)	76,19 (76,29)	79,74 (79,76)

Previous figures in brackets

**'Anti-terrorist'  
insurance**

arer  
ide  
the  
an-  
ice  
up  
las  
e,"  
s-

1-  
a  
o  
1-  
e  
d

m  
d,  
ie  
to  
ie  
ie

1-  
o  
y  
n  
d

construction his government would invest about R50 million

Vaalharts scheme have had their quota increased from 40 percent last year to 50 percent this year

other partners and that is basically why other race groups were not permitted

ASSOCIATION, the attorney said "The irony is that black swimmers can participate in the Tasa finals taking place this week"

## SA glee at minerals ruling baffles US

The Star Bureau

WASHINGTON — Reports of South African glee at the exemption of several strategic minerals from United States sanctions have nonplussed officials and analysts in Washington

The minerals were not banned anyway by the sanctions law — the Comprehensive Anti-Apartheid Act of 1986 — they said yesterday

They were reacting to a report in *The*

*Washington Times* quoting jubilant South African officials as saying the move rendered American sanctions harmless

The US State Department said the sanctions had generally not prohibited America from importing strategic minerals

"To the best of our knowledge, few if any strategic minerals were produced by parastatal organisations, so the exemption does not alter the status quo," the depart-

ment said

The sanctions ban products from South Africa's parastatals. It is understood that only a small percentage of chromium, mined in Lebowa, would be hit by this clause

The importance of South Africa's strategic minerals to America has repeatedly been raised in Washington. It was mentioned widely in the congressional debates last August which led to the sanctions

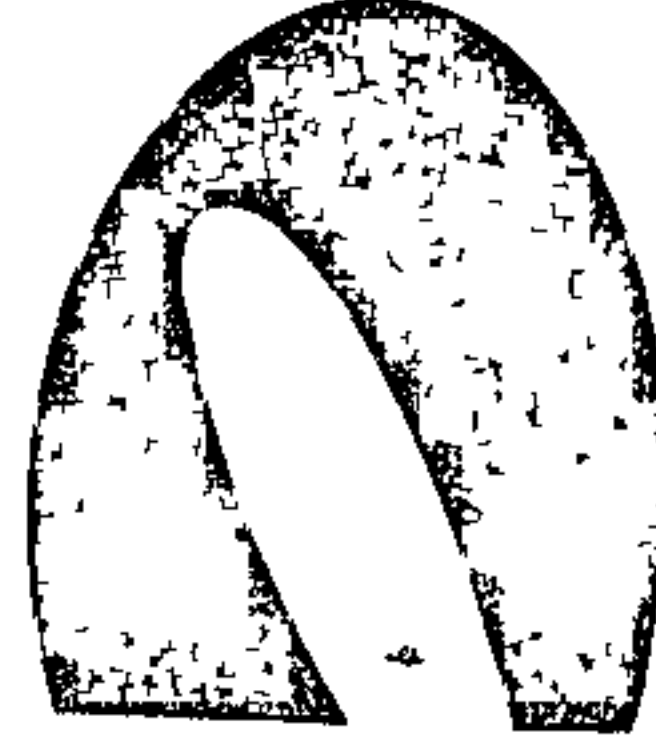
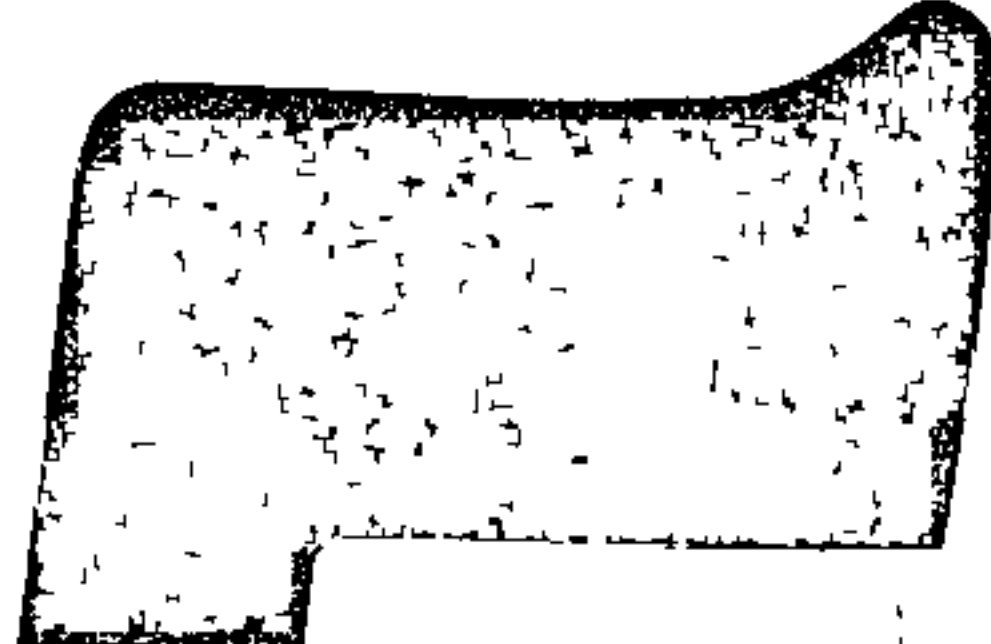
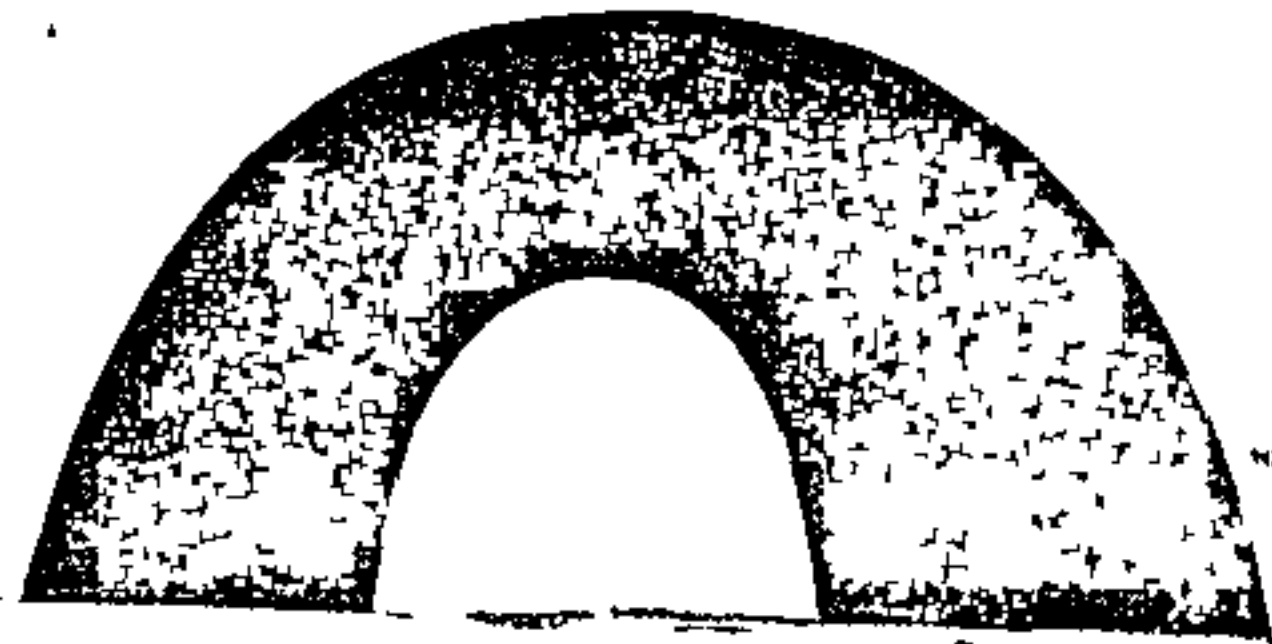



BAD DATA (287) (217)  
23/1/87  
VIRTUALLY no local mineral producer has been materially affected by the US Congress's exemption of SA's 10 most strategic mineral exports.

# Minerals ban wouldn't have hit producers

Reduced production or lost markets before the sanctions reversal were distant considerations

for major mineral exporters because platinum group metals, chrome, asbestos and manganese were not included on the original sanctions list.

Consolidated Metallurgical Industries MD Brian Davidson said: "We felt it unlikely that ferrochrome would be included in a boycott. It is comforting to see that US dependence on SA's ferrochrome has at last been acknowledged."

Rustenberg Platinum MD Brian Gilbertson took a more cautious line. He said one could not be certain where sanctions would lead once they got under way.

A Griqualand Finance and Ex-

ALAN SENDZUL

ploration Co spokesman said as far as asbestos was concerned the trade exemption had referred to chrysotile asbestos, even though SA exports have only been of crysido-lite or "blue" asbestos.

Manganese producers say that because there are virtually no operative facilities for ferro-manganese or ferro-silico-manganese in the US, SA exports are not jeopardised.

Even while the ban on ferro-alloys was in place, producers continued to ship to the US.

MINERAL EXPORTS

# Action at last

The specific exclusion of 10 vital strategic minerals from the US boycott list, contained in a special directive sent to Congress last week, underwrites South African exports worth some R4 billion a year.

But, even more important in the eyes of the local mining industry, it confirms the US's reliance on supplies from SA and its commitment to continued purchases

In a bid to sweeten the pill for Congress, the administration commits itself to developing a programme to reduce dependence on SA. But the chances of this happening in the short term are negligible

"If an important new discovery was made today it would probably take 10 years to set up refining facilities," says Aiden Edwards, president of SA's Mintek. "In many cases, exploitation and refining would be uneconomic and in some cases there are no known substitutes."

He believes the time SA has won, and the considerable cost advantages enjoyed by many local minerals, must now be used to increase the appeal of South African commodities

The US moves lend added urgency to the old call for greater beneficiation of raw materials, with the added benefits of increased export value and greater local employment (*Business* January 16) And, believe it or not, something is being done

A top-level government committee is about to review State assistance for mineral beneficiation, with the aim of spurring the private sector into action

Current State assistance includes a 25% electricity rebate, but a 25% rebate on transport costs was abolished in April 1982

Edwards was appointed chairman of the inter-departmental committee, which holds its first meeting in mid-February. Committee members will be drawn from the Department of Mineral and Energy Affairs, the Department of Trade and Industry (DTI), Danie Steyn's new Department of Economics and Technology and Mintek.

It has long been Edwards' view that greater beneficiation of SA's chrome, vanadium, titanium, manganese, gold, platinum and other minerals could double current export earnings to R60 billion a year (at 1985 prices) over the next decade.

"At last we're starting to move," Edwards tells the *FM* "All the signs are very positive and we have every intention of moving quickly"

Transport savings on the export of more refined products alone could provide a powerful stimulus, says DTI deputy director-general Frans Scheepers. An *ad valorem* levy on the export of raw minerals would be

another spur to beneficiation

Says Scheepers: "We will have to look into these matters. While government has helped promote beneficiation since the Reynders Commission's report in 1972, an examination of further co-ordination in this field is now indicated."

But while it is essential to create more opportunities, he doubts whether government can do better than make beneficiation a more attractive proposition for industrialists.

Government also has to evaluate the viability of specific projects, industries and sectors before granting concessions, he adds. Basie Kleu, chairman of the committee investigating export incentives, tells the *FM* beneficiation also forms part of his brief

Mintek is now undertaking major research



Mintek's Edwards ... new drive to add value

and development into increased platinum beneficiation. It is also examining the jewellery industry for which SA has a virtual monopoly on diamond, platinum and gold production, but produces less than 0,1% of the world's jewellery

"We have the technological leadership to find new uses for our mineral riches," says Edwards.

"But the State must play a major role in R & D developments. Once this is done, the private sector will invest. And unless we wake up, cheaper substitutes for some of our minerals could be developed"

23/1/87  
STEEL SALES FINMAIL

## Going domestic

Faced with hostile export markets, SA steel manufacturers are looking increasingly to domestic sales. But even at home possibilities

are limited

Highveld MD John Hall says it's too early to forecast 1987 performance but confidence has not yet reached a level to attract capital development of any note

"Consumer booms have little impact on our sales," he tells the *FM*, "and capital expenditure cuts by government aren't helping us either."

But, as stocks aren't high, Hall expects any real increase in market activity to be reflected in sales, and steel companies are doing their best to hold prices

Econometrix chief economist Azar Jammine says demand for steel correlates more closely with the demand for investment goods than for consumer goods and he expects gross domestic fixed investment to grow no more than 0,8%

However, Econometrix has revised its forecast for the increase in iron and steel industry production. In the last quarter last year the prediction for 1987 was 2,5% but the latest growth forecast is 2,74% — assuming exports remain constant

This could mean a growth in local sales for Iscor after two years of decline — local sales fell 3% last year and 13% in 1985

But Robin Bosomworth, MD of steel exporter-importer Robco, says there's no future for the secondary industry. There has been a 50% increase in the cost of rolled steel since price control was abolished and primary producers have a destructive two-tier pricing policy, he claims

Complains Bosomworth "It would make sense for us to move from Cape Town to Taiwan. A ton of South African wire rod and reinforcing bar steel costs the Taiwanese \$210 (R440) but the local man pays R730. Even if steel is beneficiated for export we're still charged the higher rate. This has enabled Iscor to maintain a positive cashflow of R600m — about R100 per ton"

However, UME joint MD Peter Smaller is much more bullish. "There's bound to be some stimulation of the economy in the election run up and the private sector is taking advantage of the low interest rates to restock steel products. I can also see more import replacement"

With projects like Mossel Bay on the cards Smaller expects a 5% growth in steel demand.

Steel and Engineering Industry Federation of SA director Sam van Coller is reluctant to estimate production increases. He says some large steel consumers like gold mines are doing very well, but any real turnaround would have to come from a recovery of the vehicle industry and a general revival in infrastructural activity



# Zaaiplaats slips back into the red

27/1/87 BUDDAY 217

ZAAIPLAATS Tin continued its see-saw performance in the December quarter, slipping back into the red with a loss of R37 000, or 3c a share

The tin producer reported a distributable loss of R3 000 in the June quarter but bounced back in September to lift earnings to R7 000 for the first half of its financial year

The December quarter loss was despite a drastic cut in capital expenditure to R22 000 and a sustained effort to reduce costs to the bare minimum.

Having been warned to expect lower tonnages, higher grades, losses and no dividend payments until the

CHERYLYN IRETON

tin price recovers, the market did not react to the dismal results. The share price closed unchanged at 100c a share

Zaaiplaats is not expected to lift production or earnings until the world oversupply is reduced and the tin price recovers to around £8 000 a ton

Latest estimate put the stockpile at 70 000 tons and based on this analysts say it will be around two years before Zaaiplaats' can consider lifting its production.

During the quarter, production

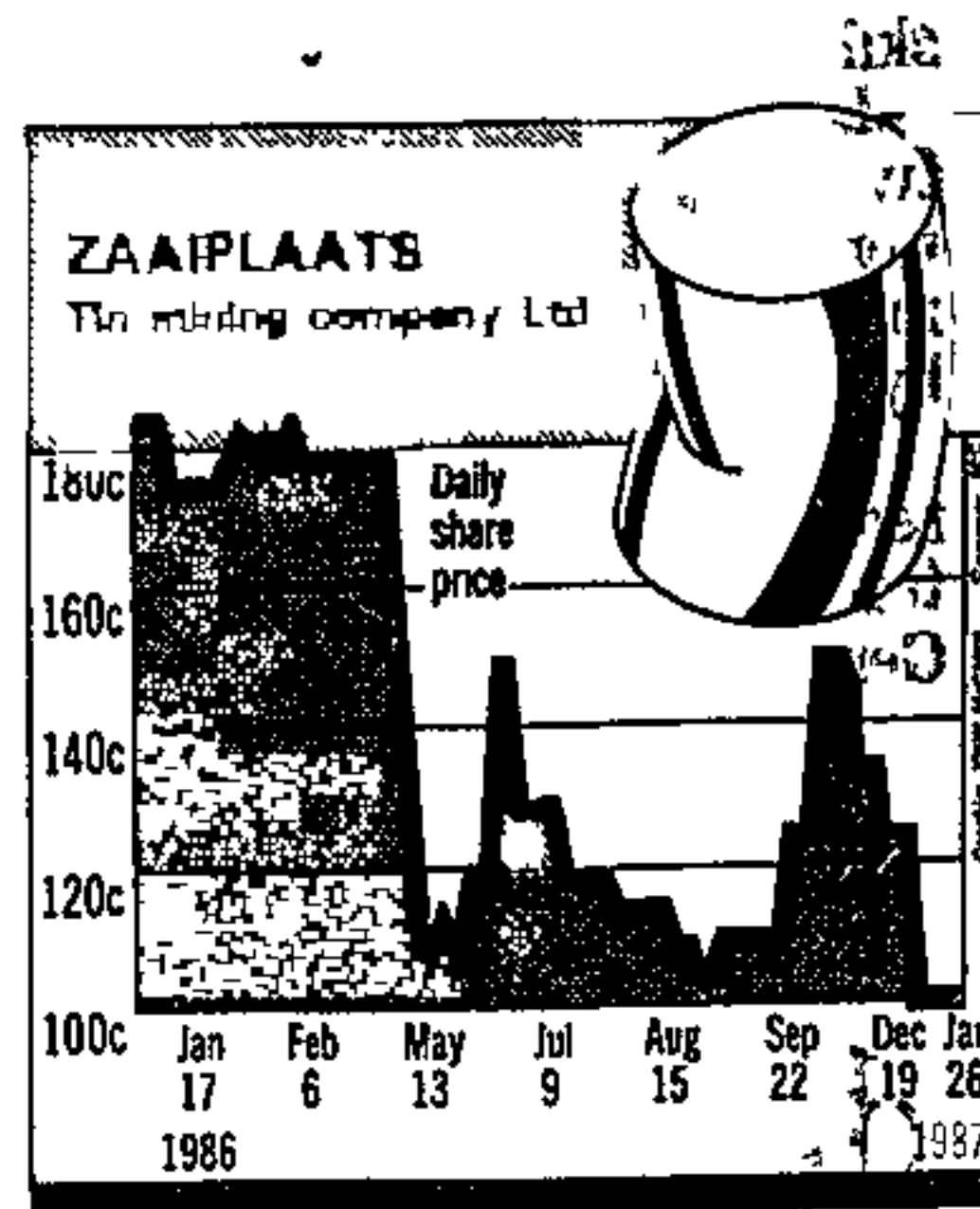

was maintained at a low level of 43,9 tons — which included 3,39 tons of tin-in-concentrate purchased from outside sources.

As expected recovered grade was higher at 0,228%, probably due to a concentration of activity in the higher-grade Western Area of the mine.

DIP

— Reuter

APOL Times 12/2/87 (217)

# Lonrho raises stake in Wesplat

**LONDON.** — British holding company Lonrho said yesterday it had increased to 99,4% its stake in the SA mining company Western Platinum at a cost of \$75m.

Lonrho, which already had 50,4% of the firm's shares, said in a statement it was able to buy a further 49% holding from the Canadian mining firm Falconbridge under an agreement signed 17 years ago.

Lonrho said it was not prepared to allow the 49% to be sold to what it

called an unsatisfactory partner in SA, and had decided to consolidate its ownership by acquiring the shares.

It added that Western Platinum would become a better managed company as a result of the consolidation and would potentially become an easier company to sell in the future.

A Lonrho spokesman said a small stake in the firm was owned by non-Lonrho interests, but he did not identify the holder. — Sapa-Reuter

(61)



# Mineral wealth 'no reason for optimism'

13/2/87  
Stam  
217

Finance Staff

Being the world's major supplier of chromium, manganese, vanadium, platinum and gold may not be as wonderful to the long-term future of South Africa as some people think, Minister of Economic Affairs and Technology Mr Danie Steyn said yesterday at Halfway House, Midrand.

Speaking at a technology investment seminar organised by the Engineering Association of South Africa, he said: "It may well be argued that South Africa's mineral wealth is no longer the powerful asset it used to be, and that the country will continue to drift further away from the developed world.

"As the world moves rapidly into an age of high technology, we are passing through a phase in which growth in demand for raw materials is low"

The problem, he said, lay with researchers, who had not paid enough attention to the development of the country's heritage and had not revealed the great rewards that could be won in the field of added value.

The fact that mineral-related products generated R25 000 million in 1985 and R29 000 million in 1986 should not make people complacent

As high technology begins to replace the country's material requirements, it could not afford to let the opportunities for optimising the exploitation of its mineral resources to gradually slip away.

"We should, for instance, ask why we produce only 0,1 percent of the world's jewellery and hardly any of the gold items used in the electronics industry

"Why do we supply 92 percent of the world's platinum, and yet no industry has been developed here to supply the world with catalysts, jewellery and sophisticated alloys?"

He said there had to be an intimate collaboration between the statutory research bodies and industry, and to this end he had appointed a technological planner

# Platinum mine plan takes shape

PETER STACEY  
Mining Editor

PLANS for the establishment of a platinum mine — at a cost of at least R200m — in the Brits area are sufficiently advanced for Golden Dumps chairman Lucas Pouroulis to say construction could start in six months, with platinum being marketed 18 months later.

Detailed feasibility studies are now in hand in an area of more than 7 000ha underlain by the two platinum-bearing reefs of the Bushveld Igneous Complex.

Cash for the venture, if it gets the green light, will be raised by an issue of shares on the Johannesburg Stock Exchange.

Mining engineers and geologists who know the area warn, however, that producing platinum will not be plain sailing. Initial mining is planned to start on the UG2 Reef, but the key is extraction of platinum-group metals from this ore, which contains a high percentage of

## Lefkochrysoos Platinum Project

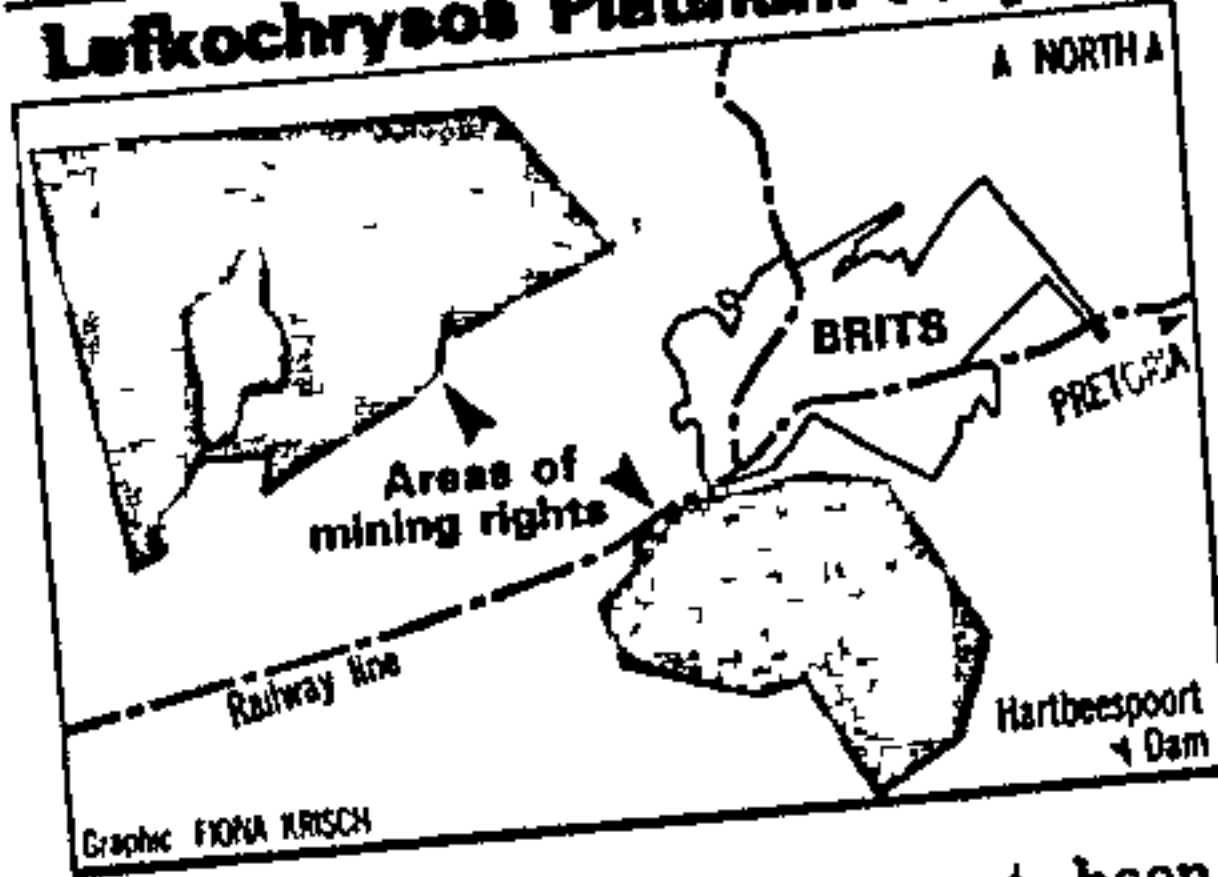

chromite. This has, in the past, been a serious headache for metallurgists.

However, Pouroulis is known to have employed some of the most experienced and highly qualified specialists in the field and is confident the problems can be overcome.

An extensive drilling programme has revealed payable grades in the shallow

● To Page 2

## Impetus for platinum mine

area of the proposed mine, between Brits and Hartebeespoort Dam.

Known faulting in the area is another of the difficulties to be overcome.

Pouroulis says, on the basis of the drilling results and preliminary feasibility studies, he is confident that it is all systems go for a new medium-size precious-metals producer. He expects first production in two years. The first stage's full output of 80 000 tons is scheduled a further six months on. In the long term this level of output could be trebled.

The mining entrepreneur, whose group lists among its operations South Roodepoort, Springs Daggafontein and Cons Modder gold mines, as well as diamond and other mineral interests, is cagey on exactly what grades have been found, but says they are comparable to those at nearby Western Platinum Mines.

The group says it has consolidated mining rights — in two blocks — on more than 7 000ha and that it is still engaged in tying up more rights.

Payable grades, according to a statement, have been found in the southern,

shallow area, at all depths, from outcrop down, in the UG2 reef, and below 400m on the Merensky Reef.

The reefs dip at about 12° from outcrops at the Hartebeespoort Dam end of the southernmost of the two areas.

No drilling results are yet available from the second, and larger area, north-west of Brits. Six drilling rigs are in operation. The first intersections are expected within three weeks. Depths range from 1 000m to 2 700m for the Merensky Reef (which is about 200m shallower than the UG2 Reef).

Initial mining is planned to start at 20m depth in the southern block, via shallow gradient roads direct to the mining faces on the UG2 reef horizon. This means access can be almost immediate, without the need for shafts and hoisting facilities in the early stages of the mine's life.

Pouroulis envisages a highly mechanised, trackless mining operation and drive-in/drive-out ore haulage to the surface.



PLATINUM MINING

# Thorny path to profits

217 9/11/27/87

After nearly two decades of domination by three producers, SA's platinum industry is being restructured. New producers are entering the market, enticed by the booming platinum price and generally favourable outlook for the metal over the next decade.

Investors will have the opportunity to buy into two new producers — Gold Fields of SA's Northam Platinum, which will be listed on March 5, and Loucas Pouroulis's Lefkochrysos Platinum, which could be listed towards the end of 1978. There is also the choice of speculating in Messina and Vansa Vanadium, both involved in drilling programmes evaluating potential platinum-bearing ground they control.

Despite the widely held bullish views on the platinum market, the best course of action for the investor is not straightforward. There are potential risks attached to developments in this market as well.

Brian Gilbertson, MD of industry leader Rustenburg Platinum, says: "At current rand prices you can make very good money from platinum mining. Profit margins are such that you can exploit deposits geologically difficult to mine and go after deposits which do not have very attractive grades. However, the industry's fortunes go up and down. We have had some very bad times in the past and it is unrealistic to believe conditions will remain good forever."

While many analysts believe world demand for platinum will grow sufficiently over the next 8 years to allow the market to absorb supplies from the two new producers, there is plenty of scope for volatility. Determining factors include the reactions of other producers, and whether any more new mines are announced. Rand Mines, for example, appears hopeful that in Vansa Vanadium it has another Northam-sized mine.

Western Platinum MD Terence Wilkinson is concerned about new production coming on stream because of the depressing effect it could have on prices. Like many commodities, platinum prices are set at the margin. The price at which the last 50 000 oz is sold is crucial.

"I also think far too much is being read into forecasts of increases in demand from European automobile manufacturers," says Wilkinson. "Our golden rule to cope with changing market conditions is to maintain Western Platinum's position as lowest-cost producer. From that everything else goes without saying."

What steps will be taken by established producers like Rustenburg in response to increasing production from newcomers in

**Booming prices and forecasts of rising demand have enticed new producers into the platinum mining industry. But there are risks for investors.**

world new supply Northam is expected to add about 250 000 oz and Lefkochrysos about 80 000 oz. Both GfSA and Pouroulis indicate production could be expanded swiftly from those initial levels depending on market conditions.

Those statistics underline SA's dominant role in world supply, which is not expected to change for at least the next 10 years, despite the intensive search in Canada and Australia for alternative deposits. These efforts have been spurred by Western fears of possible disruption of supplies from SA.

Platinum prospecting by companies such as Hunter Resources, Noranda Pacific and Pancontinental Mining in Australia as well as Madeleine Mines and Fleck Resources in Canada have attracted considerable investor attention. But the only mine outside SA likely to come into production within five years will be Stillwater in the US. This has some 35 Mt ore reserves and will start production next year at about

26 000 oz a year and reach about 52 000 oz a year in 1991-1992.

Gilbertson dismisses all the non-SA projects as "peanut" deposits. "For the foreseeable future there is no replacement for SA production. Maybe in two or three decades' time the situation might change. But even if they find another Merensky reef outside SA it will take time to develop. Meanwhile the natural advantages SA producers possess, combined with a weak rand, would make for exciting times in platinum markets."

## Driving ahead

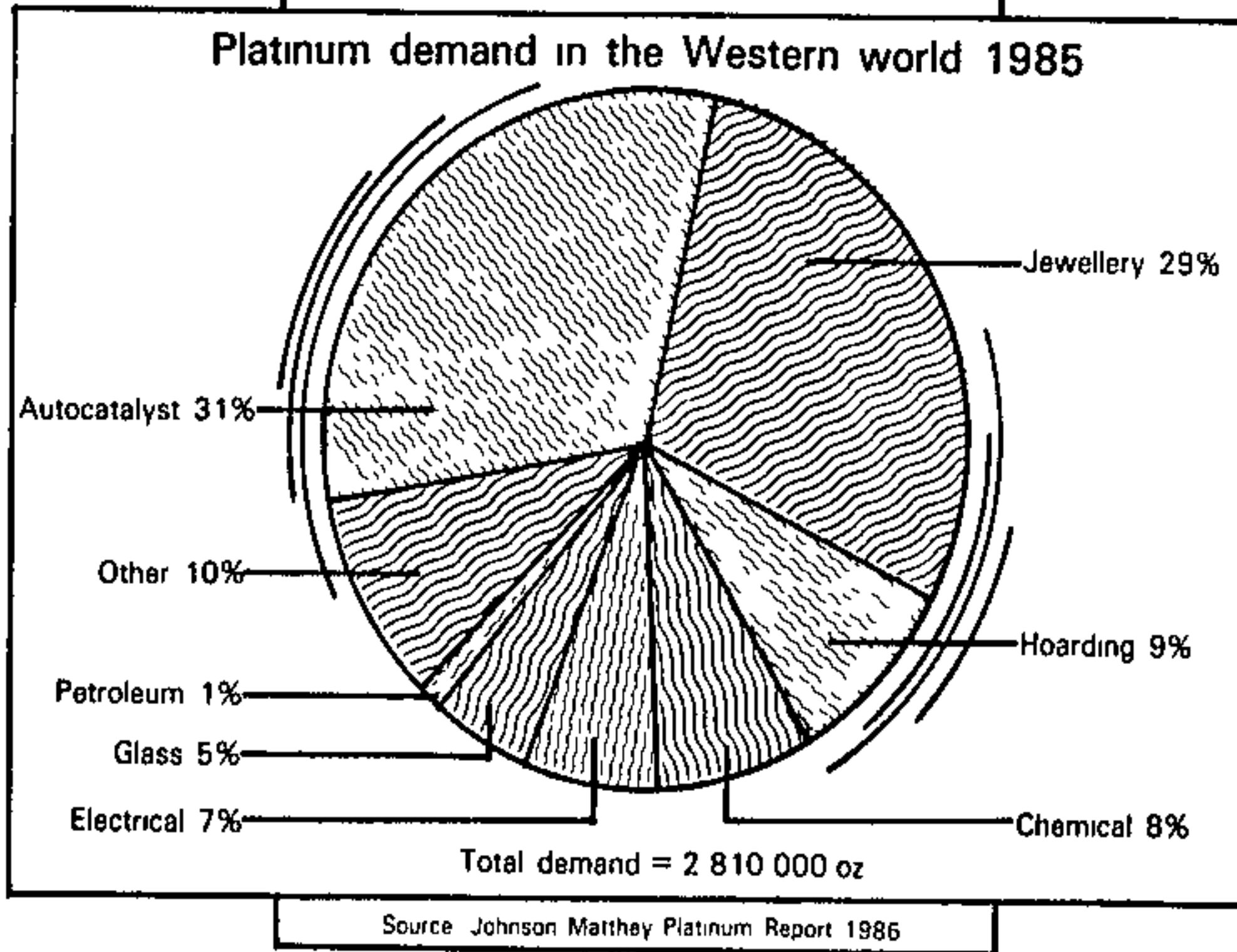

SA and other projects such as Stillwater in the US is unclear. Comments Gilbertson: "In the past we tended to rush out and expand when the platinum market went up. That turned out to be bad news when the market subsequently collapsed. This time we have been more careful."

"However, we are unlikely to sit back passively losing market share to the newcomers. Rustenburg has efficient, established mines which are financially very sound. We also have immediate access to relatively rich surface outcrops of Merensky ore that can be extracted at a cost much lower than from a deep deposit."

"If the market declines Rustenburg will fight other producers all the way for the business. In the past we did not do this. We stuck instead to the producer price system. That no longer applies," he says firmly.

During 1985 SA's three existing mines produced 2,32 Moz of platinum, 84,6% of the Western world's new supply of 2,74 Moz, for the past five years SA's mines have contributed an average 84,3% of Western

## SA Producers dominate

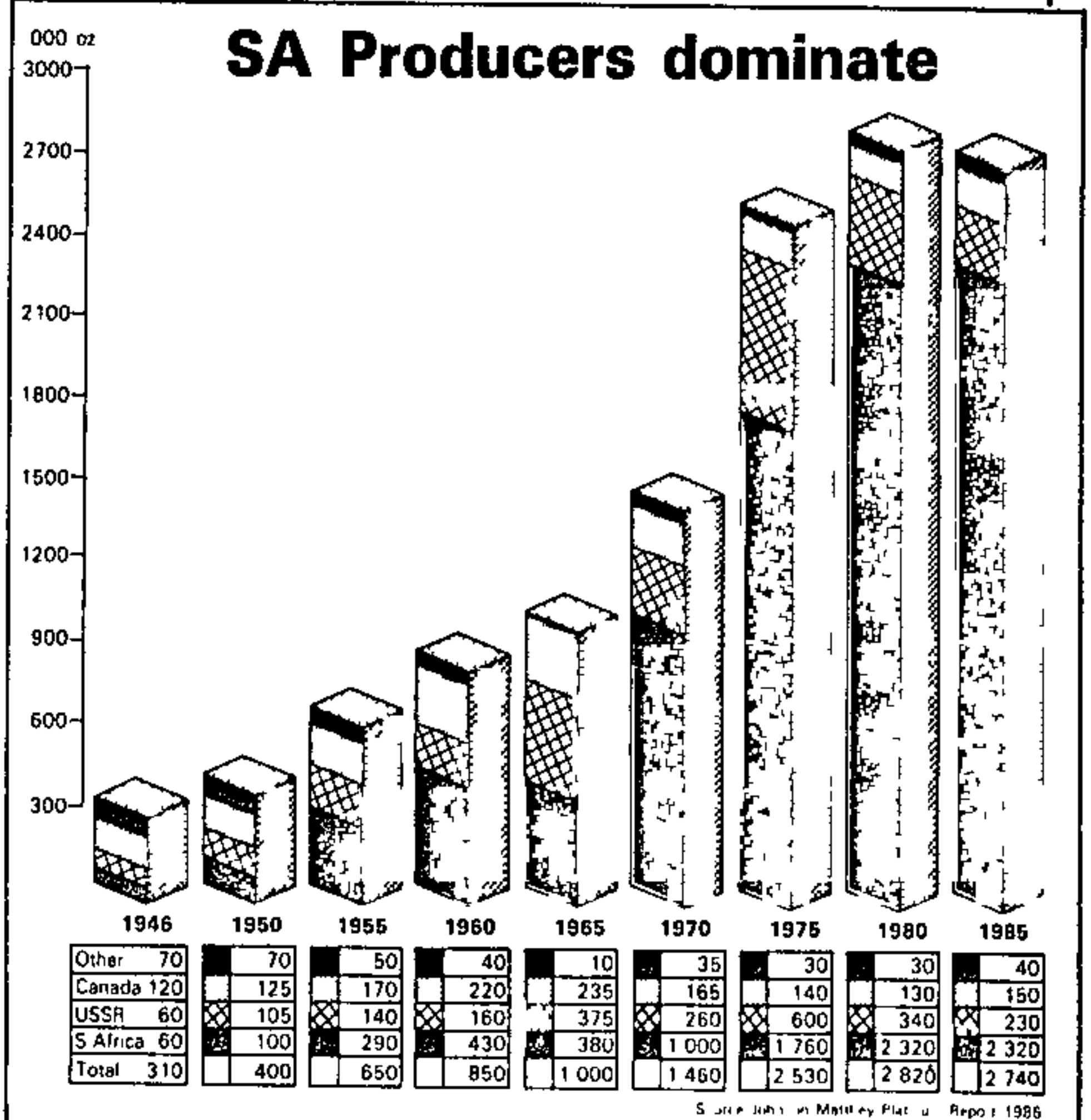



27/2/87 F/M 27/2/87

## Striking the BIC

SA's platinum deposit box — The Bushveld Igneous Complex (BIC)

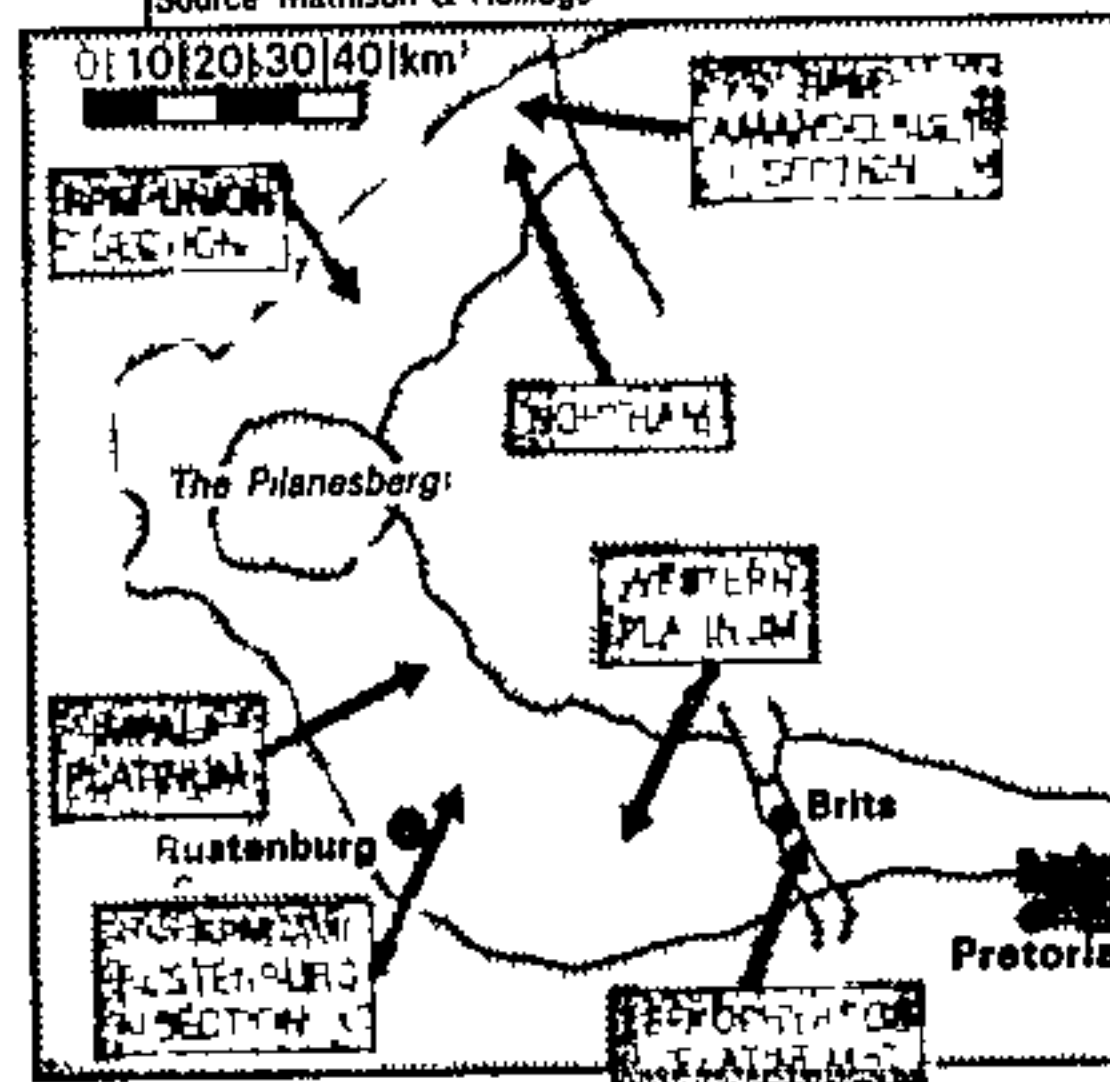
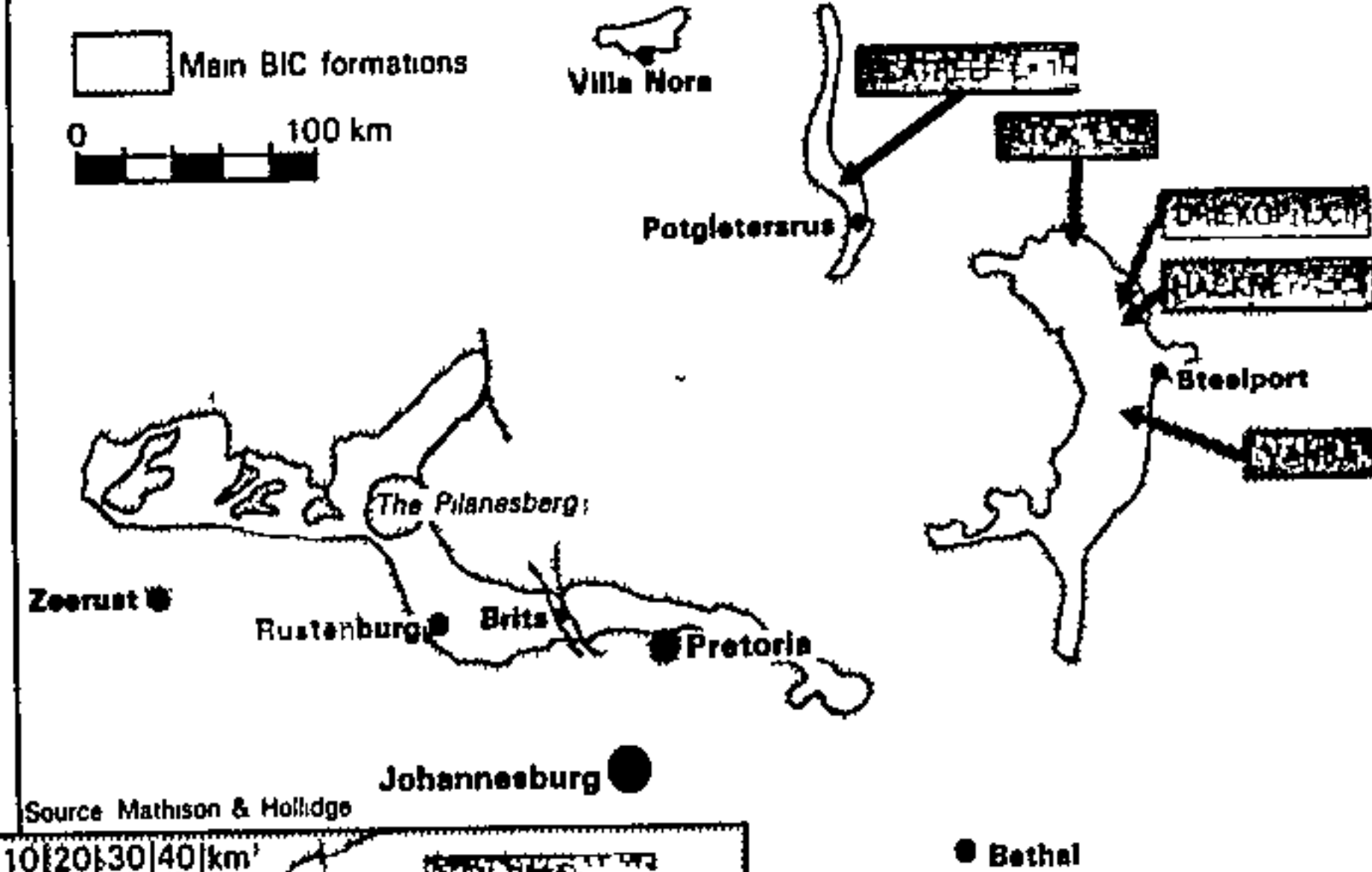

Demand for platinum comes from four main sources — the motor industry, jewellery, industrial uses, and investment.

Total demand exceeded supply in 1985 and again last year, though final figures for 1986 are not available. World platinum demand hit 2,81 Moz in 1985; Nic Dinham, analyst at stock broker Mathison & Hollidge, estimates that 1986 demand will be about 3 Moz.

He believes SA mine production fell slightly last year from 1985's 2,32 Moz because of production losses at Impala, which were offset by increases from Rustenburg and Westplat.

However, he feels the tight supply situation is over. Excess demand is being met by increased supplies from existing mines and new mine production about to come on stream, in addition, growing quantities are recovered from industrial scrap and autocatalysts from scrapped cars.

Dinham says production of 200 000 oz of platinum in 1990 and 550 000 oz in 1995 from non-JCI and Gencor mines seems assured. Platinum recovered from scrapped cars with autocatalyst exhaust systems could grow from 65 000 oz in 1985 to 230 000 oz in 1990. Even so, he sees demand and supply staying more or less in balance until about 1995, after which there will be oversupply from new mines and scrap recovery.

Growth in demand over the next decade will have to come from the present major markets. Gilbertson is optimistic about demand from European car makers, which has so far exceeded expectations despite pressure to establish the alternative lean-burn engine technology.

"I like to see the European car industry as a growth area, increasing from 50 000 oz in

1985 to reach perhaps 200 000 oz-250 000 oz by 1990 or earlier, and 300 000 oz-350 000 oz in 1995," he says.

Jewellery is another key area, particularly in Japan, where it peaked at an annual 840 000 oz in the late Seventies and then fell to a low of 560 000 oz in 1983.

Gilbertson estimates 1986 Japanese jewellery demand at 750 000 oz, and hopes growth will continue despite higher dollar platinum prices; the yen's strength meant the average yen price of platinum in 1986 was, apart from 1985, the lowest for the past eight years.

Outside Japan the German market for platinum jewellery has reached 70 000 oz a year. Gilbertson is optimistic about recent interest by Italian manufacturers. Italy, the world's largest producer of jewellery, has substantial exports to the US, the world's largest consumer jewellery market. "It would be nice to sell about 100 000 oz of platinum annually to Italy within about two years," he says.

Investment demand has grown from 45 000 oz in 1982 to 260 000 oz in 1985 and 1986 sales should be well up again, says Gilbertson. He says investment demand is too volatile to forecast but a sales base of about 250 000 oz a

year could be hoped for.

So which platinum shares do you buy? A number of analysts feel Northam is worth going for but the share looks like being extremely difficult to acquire, at least initially. Not only is it tightly held — GFSA and Consolidated Gold Fields hold 85,36% — but few holders can be expected to sell ahead of the R200m rights issue in April, because of the money they could make from selling the rights. Predictions on what price the shares will initially trade at range from R35 to more than R100. One analyst says the shares could be worth acquiring up to a price of about R50.

Vansa and Messina are cheap but speculative at this stage, because there is insufficient information on what they may have. Analysts in favour of Vansa point to the Rand Mines' link with Cyril Heever and David Marshall and emphasise its desire to get back into the platinum game. Sceptics say there is insufficient geological information about the Steelpoort fault and the vanadium-bearing plug on the platinum-bearing reefs. Rand Mines is drilling and has until July 31 to complete a feasibility study.

Last week's interim results for the six months to December from Impala Platinum swung analyst opinion almost completely in favour of Rustenburg, which is increasingly seen as the better investment. "Impala is a dog, its performance was appalling," is one analyst's opinion. It appears to have been hit by its producer-price-related sales on contract to General Motors.

Western Platinum is not quoted. According to Wilkinson, it is unlikely to be listed despite Lonrho's recent acquisition of Falconbridge's stake. Wilkinson declines to comment on statements by Lonrho's group PR manager in Zimbabwe that Lonrho bought out Falconbridge's stake to speed up its decision to disinvest from SA. Rumours and PR comments notwithstanding, Lonrho's recent actions, such as restructuring its holdings in Zimbabwe mining company Corsyn, do not appear to be those of a group intent on disinvesting.

Brendan Ryan

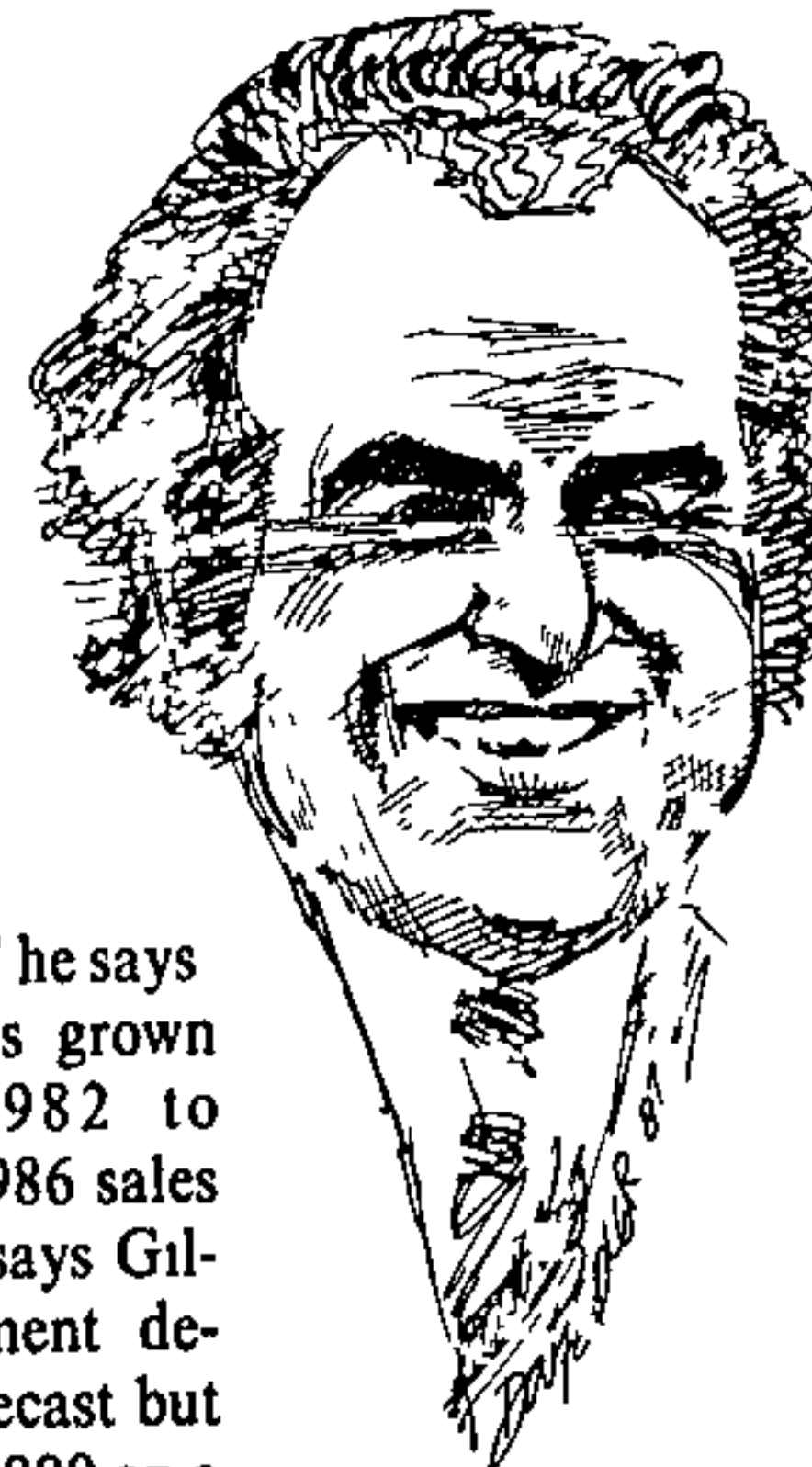



screaming about trying to compete in the EEC, but there is no stopping the stock market. Madrid's performance has kept at or near the top of the world league. The market peaked early this month at 251.4 — about 20% higher than on January 1.

All records were broken last year: total trading volume grew by 180% and equity dealings alone by 250%. Equity capitalisation rose to P6.5 trillion (\$51 billion) from P3 trillion. And the net inflow of foreign investment — dominated by the British — of P125 billion (\$98m) was more than double 1985's, which in turn was treble 1984's.

Spaniards can no longer be oblivious to what is happening in Plaza de la Lealtad, but still tend to regard the market as a hermetic institution, where a few make fortunes dealing in a small group of companies. This is not such an inaccurate picture.

Since the late Seventies, the number of

listed companies has shrunk from 500 to barely 300. This year the trend may be reversed. The record P43.7 billion (\$34.4m) flotation of the Catalan motorway operator, Acesa, was the first in a queue of new companies coming to the market.

So far the market remains narrow — with the constant threat of an Italian-style stall and collapse. In the last boom, before the 1973 oil crisis, 14 stocks made up more than half the market. In 1986 those 14 still held the same position.

Though investors have been more selective, almost all sectors were pulled along in the recent rise. Contributing factors include improving profits, relatively low interest rates, an income tax change removing relief on bond purchases but keeping it for equities, and the closing of outlets for "black money."

It was thought that recent easing of restrictions on purchases of foreign securities

by Spaniards would take pressure off the market. But with a stable peseta, there has been no rush to get money abroad.

Meanwhile some old habits which hindered understanding are disappearing. Madrid now has a permanent index, instead of going back to 100 at the beginning of each year — quite a psychological bump. And from April shares will be traded in pesetas instead of percentages of nominal value.

Of course, all bull markets run into trouble now and again. Speculation over financial difficulties at Fecsa, an electrical utility, was followed by falls of the maximum allowed 5% of nominal value by a number of utility shares — after which trading in them had to be temporarily suspended.

This triggered a broader correction. The index dipped as low as 226.9, but is now back close to the high again. It doesn't look as if the party's over just yet. ■

## ALUMINIUM

# Is there a silver lining?

Though prices have been strong recently, analysts cannot agree on the outlook for aluminium this year. "Bleak, to say the least," and for next year "poorer still" are the main conclusions of a comprehensive report by London broker Shearson Lehman Brothers, but others are more optimistic.

On reports of shortages in stockholders' hands, prices have soared to a near two-year high in sterling and a near three-year high in US\$ since late last month. The end of last week saw a correction of just over £20/t, but by Monday this was all regained.

The International Primary Aluminium Institute has reported falls in primary stocks for five months in a row (to December), and London Metal Exchange (LME) warehouse stocks of about 110 000 t are less than half the January 1986 level.

The supply shortage is partly due to technical factors. Artificial shortages can arise because the market deals in 99.5% pure metal, whereas the most common grade in physical trade is 99.7%. The LME plans to put this right by introducing a 99.7% contract in May.

Dealers say short-term difficulties are exacerbated by the growth of the options market, as options are open for only five days. This too will change in May, when the LME will introduce a 14-day option period.

Some analysts believe prices could fall sharply when the technical reasons for shortages are removed. But others say the supply/demand balance is now close enough to hold prices at present levels.

Shearson's "best estimate" puts the 1987 price average at US52c/lb, down from 52.2c in 1986. Its "high" and "low" estimates range between 56c-49c/lb. For 1988 it projects a sharper decline ranging between 54c-44c/lb with the "best estimate" at 46c.

"In the absence of further substantial

smelter cutbacks the market seems destined to remain in oversupply for the foreseeable future," the report says. Non-Socialist production is forecast to rise by 600 000 t this year and a further 100 000 t in 1988. With consumption continuing downward Shearson predicts surpluses of 450 000 t this year and 800 000 t next.

Last year lower production in North America and Asia more than outweighed higher output in every other region, and the non-Socialist world total fell by about 60 000 t to an estimated 12.2 Mt. But the North American decline was entirely due to

smelter cutbacks and strike actions in the US, Shearson points out. Canadian output continued to climb steadily.

In Asia the decline in Japanese primary output continued apace, to less than 21% of the 1981 level, when it was the third largest producer in the non-Socialist world.

On the consumption side increased usage in most areas was more than offset by cuts in the US and Japan, the report says. These two account for between 45%-50% of total primary consumption in the non-Socialist world, "so relatively minor changes in their demand have a marked impact on the total."

US and Japanese demand is expected to fall further in the coming two years, a trend Shearson expects to be aggravated by increasing substitution of primary metal with recycled supplies.

Aluminium prices outside the US could come under extra pressure if, as Shearson expects, the dollar weakens further. However, it accepts that short-term supply tightness caused by increased activity in the options market could result in "several squeezes" during the first half of the present year. But "no sustained increase is in prospect."

Conversely, metal trader Rudolf Wolff believes supply and demand will virtually balance this year, near 12.9 Mt, and forecasts rising prices.

And last week David Morton, president and CEO of the West's largest producer, Alcan, told a London conference that continued economic growth should at least sustain recent price increases.

He says smelting capacity of 1.5 Mt — more than 10% of Western capacity — has been closed in the past two years in the US and Japan. Up to 250 000 t more could be closed this year. Offsetting this, new capacity has been only 700 000 t. ■

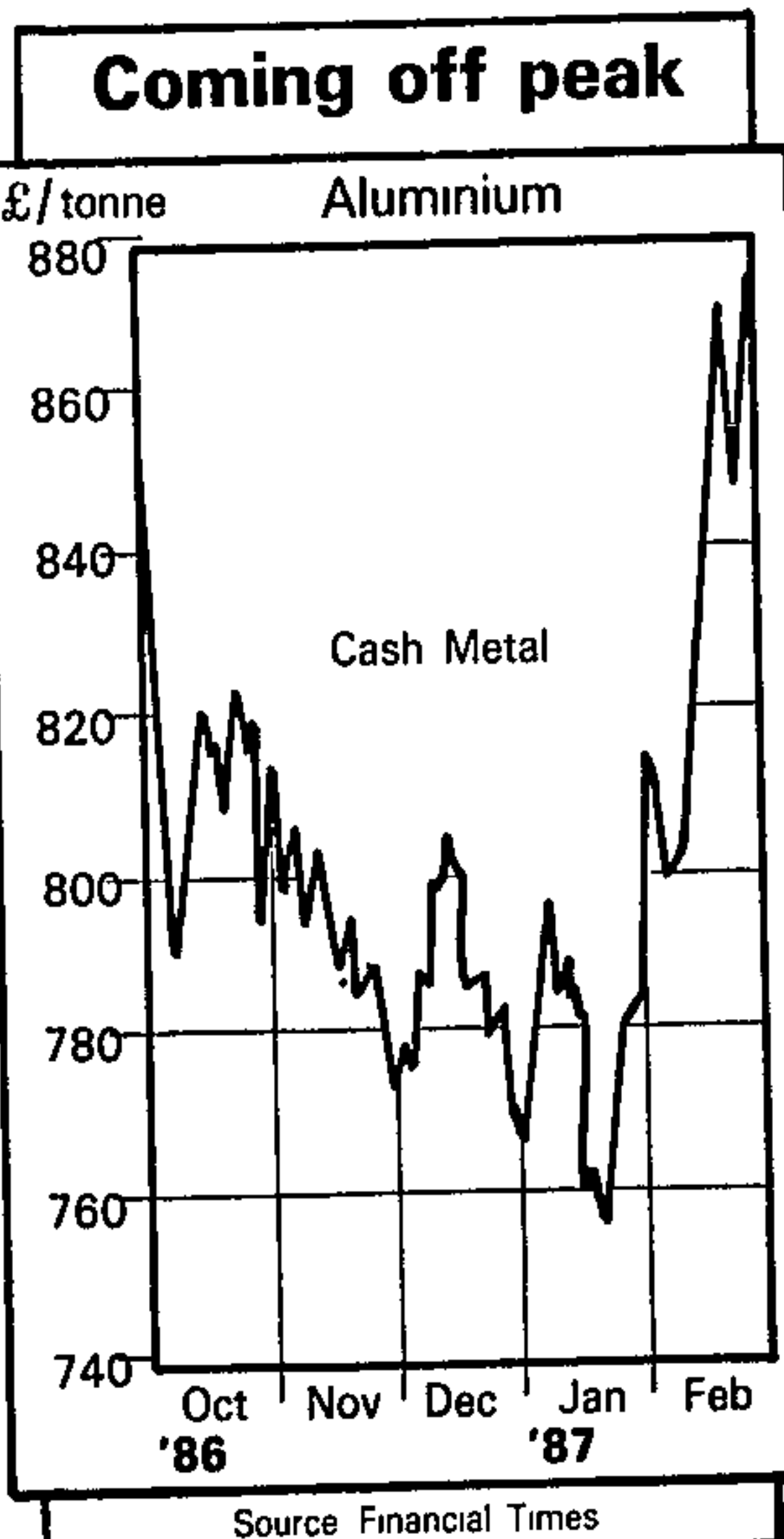

## R5,4m profit for Messina

JOHANNESBURG — Messina has produced a dramatic turnaround in the year to December, with taxed profits of R5,4m compared with a loss of R43,96m in the previous year

In so doing, the mining/industrial group has surpassed the year's tough target of breaking even, set by managing director Terry Buchans, it is reported

Preliminary results show turnover for the year of R218,8m — 3,4% higher than in 1985.

Rationalization, which began in 1985, saw major shareholder Sanlam take over the Magnis and Nissan motor operations.

### Rescue operation

The rescue operation mounted by Buchans, who took the reins in mid-1985, included sales of unprofitable assets and streamlining of operations

Another feature of restructuring was a deal with the bankers to convert about 40% of short-term borrowing into redeemable preference shares and long-term loans. The group agreed not to pay dividends in 1986 and requires the bankers' permission for payments in the next three years.

The major activities for the trimmed operation are the Messina Copper Mine (which after more than 80 years of production is still profitable) diamond and anthracite interests, and Premier Metal, which produces and markets heavy earth-moving machinery and materials-handling equipment — Sapa



# R320m bonanza on Northam shares

CALL 11115  
10/3/87  
217

Own Correspondent

**JOHANNESBURG** — The massive premium on shares of the newly listed Gold Fields of South Africa (GFSA) platinum venture, Northam, has produced a potential R320m bonanza for the holders of 8m shares

The lucky shareholders, who include some top names in stockbroking and business, were offered shares in the mine through a private placing at R10 a share and have made paper profits of about 400% in less than a week. The share closed yesterday at R50.

## Affiliated companies

Although individuals hold only 14,6% of Northam's shares, which is small compared with GFSA's 72,6%, and Con Gold's 12,7%, some prominent individuals could make instant profits in excess of R100 000 if they sell

GFSA placed 887 593 shares with affiliated companies, its pension and provident fund and business associates. This figure includes the more-than-500 GFSA staff members and directors allocated 170 700 shares

The potential profits are proving to be a bit of an embarrassment to some who refuse to comment on their allocated shareholding in a public company. GFSA itself has come under criticism for misjudging the issue price

## 'Long-term investment'

According to the share register, GFSA and Northam chairman Robin Plumbridge, who holds 4 000 shares, could realise a R160 000 profit. GFSA director Andrew Gnodde, whose family trust — the AMDG Trust — holds 3 000 shares, stands to make a staggering profit of R120 000

"This is a nice long-term investment," he says

Gnodde's daughter, Gillian, who works for stockbroking firm Ferguson Bros in Cape Town, was allocated 200 shares

Peter Campouroglou and Harry Mulholland, both directors of stockbrokers Mathison & Hollidge, were allotted 500 each

Henri de Villiers, a Gold Fields director and chairman of Stanbic, received 1 000 shares

procedure  
their own  
flow of it  
body is p  
□ Dead  
scrapping  
includin

Heunis,  
Stoffel  
"At  
gression  
tion of  
rall and  
such ex-

mix of  
and the  
r with a  
ations of  
state of  
olicy and

□ A B  
ual libe  
and group  
guage and culture must  
□ Regional initiatives aimed at local co-operation such as the Natal Indaba should be encouraged  
"We are not a political party. It would be presumptuous now to confine or inhibit this new, dynamic spirit. However, we do accept that this spirit is directed at the general election which constitutionally must be held at the end of 1989"

(Report by Max du Preez, 11 Diagonal Street, Johannesburg)

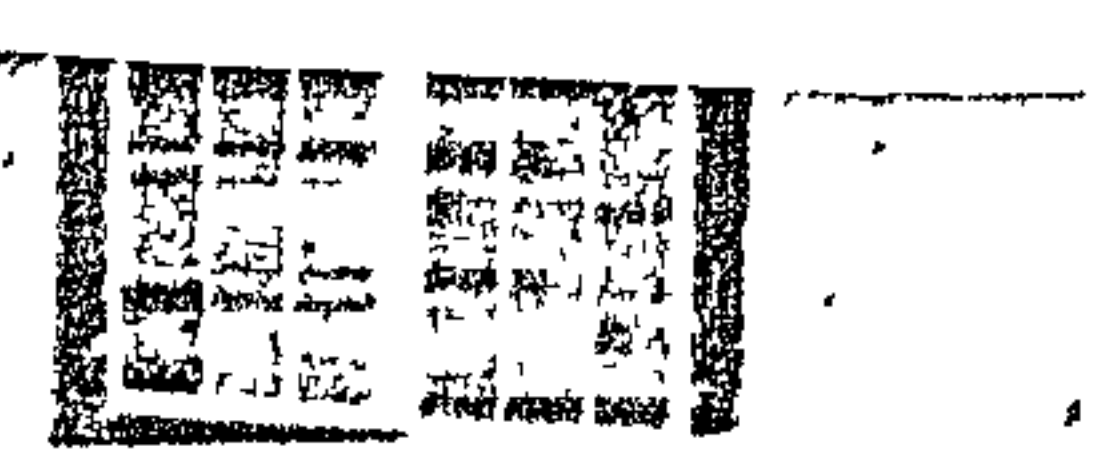

'Born',  
'gain'

still existed... who had resigned from... candidates in the forthcoming election

He said the party's left wing was made up of many layers of Nationalists — ranging from ministers and MPs to rank and file blue-card holders

These people, he said, believed the NP was too closed and rigid in regard to cardinal policy issues.

□ □ □ □

THE independent candidate in Port Elizabeth Central, Mr Johan Stander, who was to have stood against the sitting PFP MP, Mr John Malcomess, has withdrawn from the election

Mr Stander said yesterday he would now support an NP candidate, if one was nominated in Port Elizabeth Central. He also pledged to work for unity in NP ranks

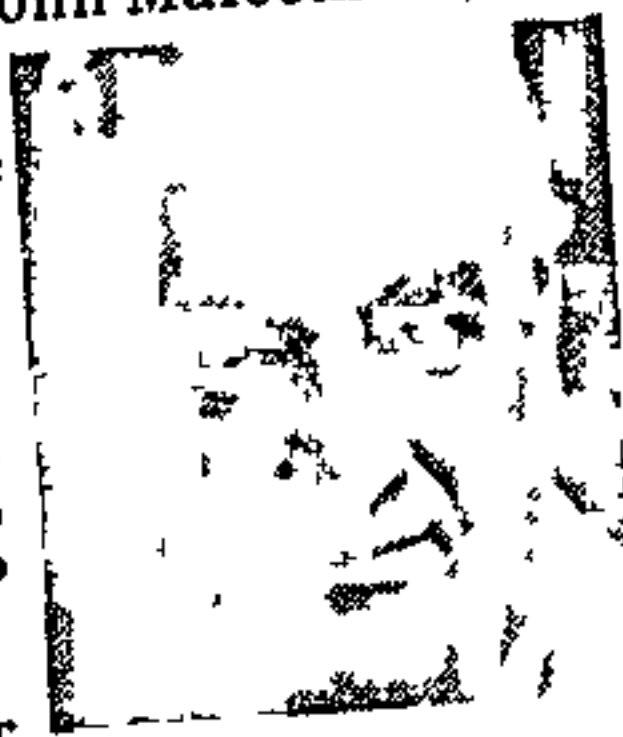

Mr John Malcomess now unopposed

His decision means that four PFP MPs are, at present, unopposed. Apart from Mr Malcomess, they are Dr Marius Barnard (Parktown), Mr Ray Swart (Berea) and Mr Jan van Gend (Groote Schuur)

□ □ □ □

TWO more MPs have quit parliamentary politics, bringing the total number of MPs who have retired voluntarily before the outcome of the May 6 election to 38

They are Dr Rina Venter, one of three women in the House of Assembly, and Dr Louis van der Watt, the NP MP for Bloemfontein East. They are both to become full-time ministerial representatives or "assistant ministers" in the House of Assembly Minister's Council

Net asset value per share (cents)  
\*\* Weighted on the basis that the shares of the acquisition of the food companies the respective effective dates of acquis

**GENERAL**  
The results for the year were dramatically the food processing and agricultural machinery (proprietary) Limited. These interests contribute attributable income

**DIVISIONAL REVIEW**  
All operations, including the bearing division year with the weak rand benefitting food export the export sector would have been considerable reduction of export packs due to drought Sales of canned and bottled products on the growth despite slack consumer demand during The bearing division improved market share within the industry, net operating income previous year Sound management and an embroiled parts helped

NOTE  
1  
2  
3  
4  
5  
6

# Record results for De Beers

*CAPL Trans 11/3/87 217*

JOHANNESBURG — De Beers Consolidated Mines Ltd yesterday announced record results for the year ended December 31, 1986

Group profits attributable to deferred shareholders before extraordinary items improved by R113m or 17% from R649m (180c a share) to R762m (212c) before taking into account De Beers' share of retained earnings of associated companies, and by R116m from R1 035m (288c) to R1 151m (320c) after taking into account the group's share of retained earnings of associates

## '50% higher'

Converted at the year-end rate of \$0,4576 attributable earnings excluding the share of retained profits of associates amounted to \$349m and improved by 38% on \$252m in 1985 at \$0,3883, and to \$527m (\$402m) including the share of retained profits of associates

The final dividend was 50% higher at 60c a share (40c) making the total for the year 80c a share (55c) absorbing R288m, and exceeding by 5c the highest level of total dividends previously paid in 1980.

The diamond account which increased by R211m or 19% to R1 361m (R1 140m) following much improved sales as well as price increases of 7,5% in May and 7% in November, was adversely affected by the recovery on the rand against the dollar at the year-end

Investment income rose from R215m to R274m and interest received was R76m (R82m) reflecting lower rates of interest and the improvement in the rand/dollar exchange rate at the year-

end Net surplus on realization of fixed assets and on investments was R2m in 1986 (R35m)

Group profits before tax amounted to R1 514m (R1 190m) Higher diamond earnings and the utilization in 1985 of assessed losses brought forward and unredeemed capital expenditure caused taxation and mining lease consideration to rise by 55% from R411m to R635m

The share of group profit attributable to outside shareholders in subsidiaries was R12m lower at R116m mainly because of the reduction in dividends paid in respect of preference shares redeemed during the year

## Stocks lower

The group's share of extraordinary losses of associated companies amounted to R51m (R63m)

Diamond stocks at R4 036m were lower by R850m of which R721m was attributable to the higher rand/dollar exchange rate as applied to opening stocks, and R129m to a real reduction in stocks Converted at the rates of exchange at the end of each year stocks were \$1 898m in 1985, and \$1 847m dollars in 1986, a reduction of \$51m.

Preference shares of R89m outstanding at 31 December 1985 were redeemed during the year Long- and medium-term liabilities reduced by R453m to R527m and net current assets increased by R160m to R646m so that the apparent overall improvement in funding amounted to R702m Had the conversion rate used in 1986 applied to both years such improvement would have amounted to R530m — Sapa *hbs*



# Zincor rejects NUM's proposal

ALAN FINE

217  
THE management of the Gold Fields-owned Zincor zinc refinery near Springs has turned down a proposal by the National Union of Mineworkers (NUM) for an independent commission of inquiry into violence at the plant.

217  
Three employees have died and five have been injured in unexplained attacks by unidentified gunmen since March. The shootings precipitated a strike last week by 600 workers. The NUM alleges supporters of the United Workers' Union of SA were responsible.

217  
NUM general secretary Cyril Ramaphosa said the union received a telex from the company yesterday saying it would not participate in an independent inquiry because it was already addressing the underlying problems. The telex said the company would inform the union of developments.

Commenting on NUM allegations that the company would not permit union meetings unless they were recorded and the tapes made available to management, a Gold Fields spokesman said this arose after a memorial meeting in March when the union failed to adhere to certain written undertakings. These were that were that it would be a memorial service only, and that allegations of responsibility for the deaths would not be made.

"Zincor is concerned that mass meetings held at a time when emotions are running high, as during last week's stayaway, could lead to exacerbation of the situation.

However, since the workforce returned to work last Wednesday tensions have cooled and management has agreed to allow a meeting to take place this afternoon (yesterday) without stipulating that it be recorded," he said.

industry

This industry was earmarked as a growth point when Spectrum went to the DCM in October. However, initial progress was slower than anticipated. "We have made a few contacts and have a few orders," says Swersky, "but this is a long-term project. Sales are slow because of the nature of the mines' tender system, and it will be at least another six months before we will be able to consider our efforts successful."

Since its listing, Spectrum's share price has risen and fallen in tandem with the engineering sector index. At its current 125c, the share yields 6% on earnings, lower than the sector average of 8,8%, but certainly not unusually thin for a DCM listing.

With the help of funds raised in its listing last October, Spectrum's balance sheet seems healthy enough. There is no long-term debt and even with the short-term borrowings of R352 000, the debt equity ratio remains respectable at 22%.

It's an interesting company, but in terms of track record, perhaps not among the most impressive to reach the DCM. *Cherilyn Ireton*

MESSINA 24/48 (217)

## Debt laden

**Activities:** The company operates in mining, automotive components, materials handling and construction equipment, retail truck and commercial vehicle distribution and shipping industries. Group mines produce copper, gem diamonds and anthracite.

**Control:** Sanlam has ultimate control

**Chairman:** I Mackenzie, managing director A D S Buchan

**Capital structure:** 11,8m ords of 50c. Market capitalisation R50,1m.

**Share market:** Price 425c. Yields 6,7% on earnings; PE ratio, 14,9. 12-month high, 525c, low, 140c. Trading volume last quarter, 1,07m shares

**Financial:** Year to December 31

	'83	'84	'85	'86
Debt				
Short-term (Rm)	70,8	92,9	15,2	10,8
Long-term (Rm)	21,2	51,2	65,4	61,4
Debt equity ratio	0,54	2,1	2,72	1,41
Shareholders' interest	0,35	0,14	0,23	0,33
Int & leasing cover	10,2	—	—	1,14
Debt cover	0,1*	—	0,08	0,47

**Performance:**

	'83	'84	'85	'86
Return on cap (%)	4,2*	—	—	7,9
Turnover (Rm)	948	858	212	219
Pre-int profit (Rm)	25,7	—	(33)	12,2
Pre-int margin (%)	2,6	—	—	5,6
Taxed profit (Rm)	5,4	—	(23,6)	0,2
Earnings (c)	30	—	(206)	29
Dividends (c)	10	—	—	—
Net worth (c)	1 372	558	186	369

\* Annualised

**Tony Buchan**, appointed MD in mid-1985, achieved his aim last year of getting trimmed-down Messina into a break-even position. But although some R10m was shaved off debt, the mini-conglomerate can't afford to be complacent while its gearing

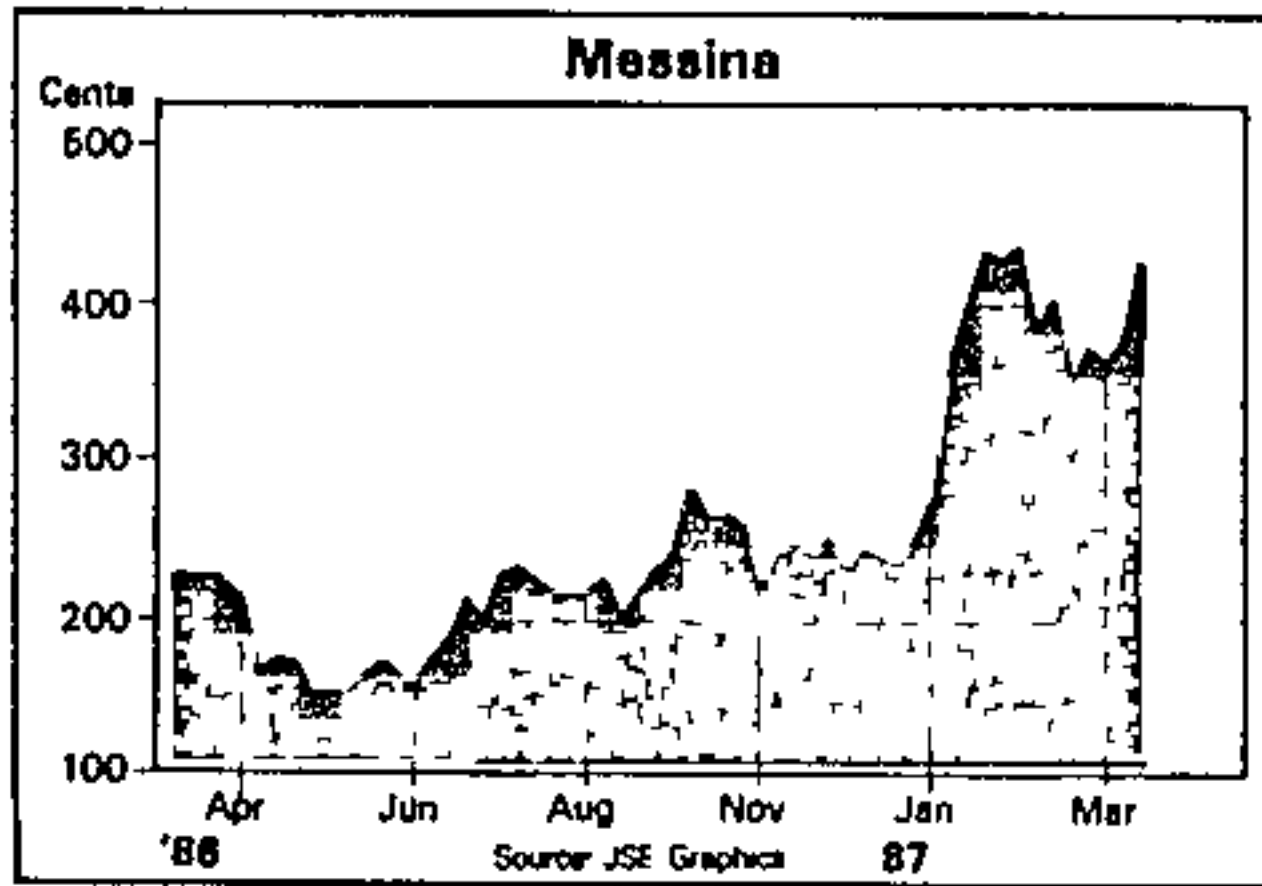

remains at the present unhealthy level of 141%

Management is obviously conscious of this. Says chairman Ian Mackenzie "The level of borrowings remains unacceptably high and we have placed a high priority on debt reduction in 1987." Quite how this may be done is unclear — unless a rights issue is on the cards.

Operating divisions all showed significant improvements, although automotive components contributed a R4m loss. Nevertheless, attributable income turned sharply around from the previous year's R22m losses to R3,6m profits.

Automotive components are expected to benefit from the rising trend in new car sales, and profits are expected to improve at Autocast, whose efficiency has improved following rationalisation. Management expects to regain market share in the materials handling and construction equipment division following the merger with Gradtek.

After its purchase of a 51% interest in Nissan Truck Rental, the retail truck and commercial vehicles division could show improved profits. And, after reporting a 64% increase in profits last year, Messina's 50% shipping interest in Ahrenkiel Liner Service should sustain creditable growth.

But the mining division remains an unknown factor, with cost inflation and a stronger rand affecting Messina copper and diamond operations. Messina copper mine had a good year in 1986, when sales of recoverable copper concentrates rose to 6 912 t (6 499 t). A change in the method of bringing sales to account, which ensured that revenue and expenditure are more closely matched, benefited profits, but this will not recur in 1987.

An increase in the rand price of diamonds saw diamond profits soar by 97%, but this upward trend is unlikely to continue at this rate if the rand continues to appreciate. With Anthra anthracite opencast mine now closed, the group's coal exposure is limited to its 60% holding in Nkomati Anthracite, where future mining will depend on the availability of suitable export contracts.

The share's strong appreciation in February was based on speculation that Messina would sell its platinum rights in Lebowa, where a drilling programme to investigate the Merensky and UG2 reefs is under way. Preliminary drilling is expected to be completed in mid-1987; the group will then consider a trial mining project.

Referring to the dispute between Messina

and RUC/Fury over rights west of the present exploration, Buchan says "The company already has prospecting permission over 16 km of strike. The dispute will not have any material effect on our decision to either develop a mine or sell (the rights)." Still, given the present strains on the balance sheet, it is difficult to see how the group could plan to fund a mining project of its own.

After touching a speculative high of 525c in February, the share has retreated to a more reasonable 425c, where the historical earnings yield is 6,7%. As the group has given an undertaking to its bankers not to pay dividends until 1988, the share might be considered fully priced for now.

*Dave Edwards*

## would be minimal.

The Financial Director's company would be covered for approximately 80% of the contract value. This amount would be paid immediately on the buyer's liquidation or six months after the original due date. In addition, his company could receive a further 20% of any recoveries.

With this income guaranteed, he would then be in a position to arrange finances in order to continue trading.

This type of situation is not unusual in South Africa today and it illustrates just how Credit Guarantee insures companies against bad debt in both the domestic and export markets.

With that in mind, you owe it to yourself to find out how we can help you.

So call Credit Guarantee now:  
Johannesburg (011) 886 3010  
Durban (031) 31 6142,  
Cape Town (021) 21 7830  
Port Elizabeth (041) 26 795

Or if you prefer, fill in the coupon below and send it to us. We'll be more than happy to contact you to arrange an appointment or to send you further information.



## CREDIT GUARANTEE

We are the people who turn bad debts into good money.

Please tick applicable and print all details neatly.

If you reply right now, we'll send you the first two volumes of the Credit Guarantee Economic News Bulletin and we'll put you on our mailing list to receive future issues absolutely free.

**YES.** I would like to know how Credit Guarantee can help insure me against bad debt.

Please send me further information  Please contact me to arrange an appointment.

Name

Designation

Company

Type of business Domestic  Export

Address

Code  Telephone

Language preference English  Afrikaans

Send to: Credit Guarantee, PO Box 9241, Johannesburg 2000, F.M.

WUNDERMAN INTERNATIONAL DIRECT 300047/D/R2



ed for around 35% of annual production, were placed on care and maintenance last October in a bid to keep the bushveld operation viable

In the first quarter of 1987, with only the C mine operating, overhanging costs caused Rooiberg to lose R46 000. Chairman Peter Janisch says that if these costs can be brought under control, and international tin prices remain stable, Rooiberg should return to profitability in the current year

Meanwhile, mine management is concentrating production efforts on the higher grade C mine from which a larger amount of concentrates will be produced for the smelter. Exploration activities are continuing, with the opening up of the promising NAD area at the A mine. Work will continue this year and the area should be ready for development when the A mine is reopened. Work

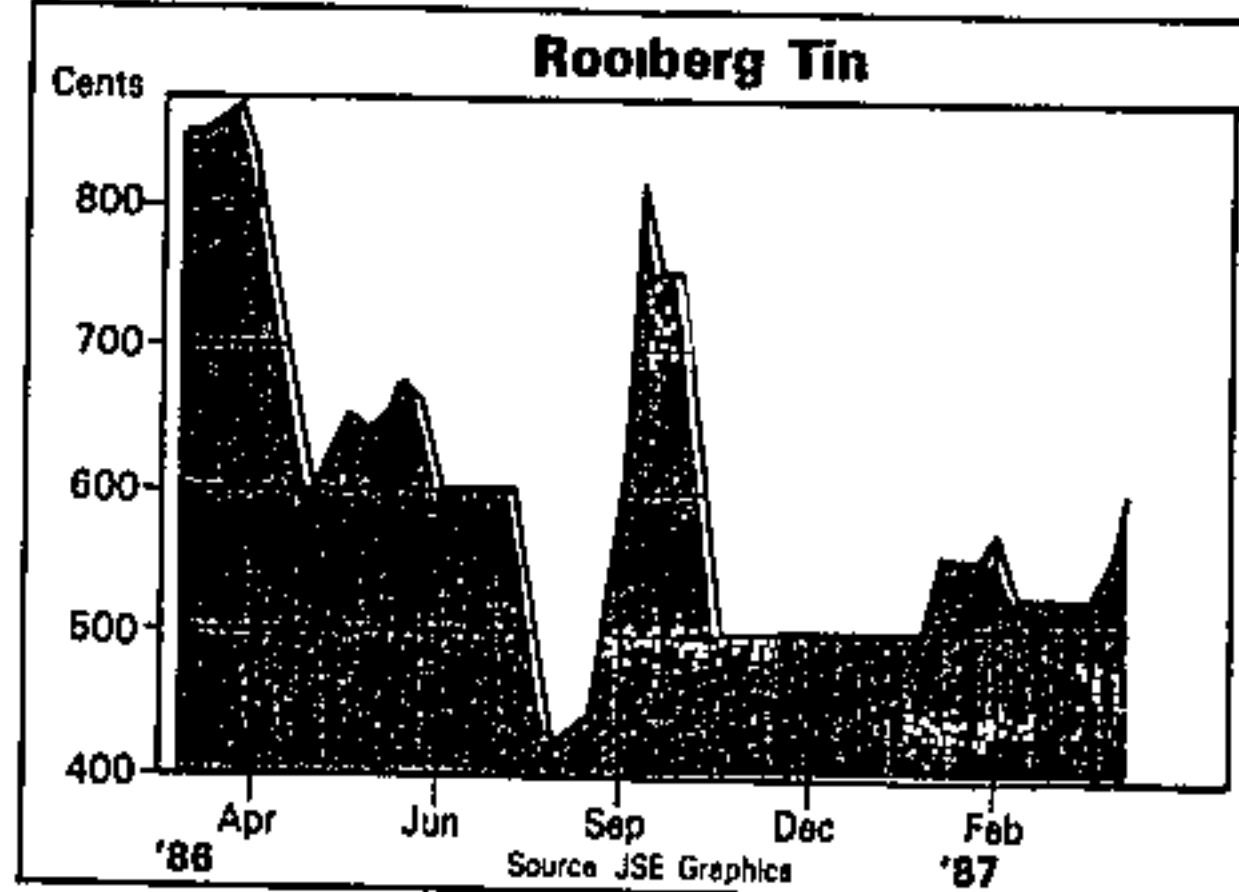

in the NAD zone consumed much of the R3,1m allocated for capital projects in 1986.

Although Rooiberg's first priority is to supply local demand — with about 720 t of tin — almost two thirds of its production has, in the past, been exported. In 1986, income from exports plunged by 37% to R16m, thanks to the collapse in prices and despite a 5% increase in export tonnage to 1 210 t.

According to the Rotterdam Free Market price, tin is currently selling for around £4 220/t — or R13 672/t — well up on last year's levels of around £3 600/t. However producers are looking for above £6 000/t before they will consider the market to be back in equilibrium.

Although Janisch envisages a recovery in 18 months, some analysts take a more conservative view and estimate that it will take 2½ years before the entire stockholding of merchants and bankers — which totalled 60 000 t in mid-March — is wiped out.

Nevertheless, Janisch's optimism seems to be reflected in the share price which in recent weeks has climbed to 700c from the year's low of 425c. If management succeeds in cutting costs to the desired minimum, Rooiberg could well break even in the current quarter. A return to payment of dividends will take longer.

Cherilyn Ireton

24/4/87  
**ROOIBERG TIN** (217) 2020

### Market overhang

**Activities:** Tin mining in the Warmbaths district of the Transvaal

**Control:** GFSa has 45% of the issued share capital

**Chairman:** P Janisch

**Capital structure:** 2,08m ords of 25c each  
 Market capitalisation R14,6m

**Share market:** Price 700c 12-month high, 875c, low, 425c Trading volume last quarter, 92 000 shares

**Financial.** Year to December 31

	'83	'84	'85	'86
Tin Production (t)*	2 133	1 787	1 707	1 837
Tin Sales (t)	2 079	1 738	1 612	1 871
Turnover (Rm)	28,1	28,6	39,7	27,3
Pre-tax Profit (Rm)	8,1	6,8	11,6	(0,4)
Earnings before capex (c)				
Before capex	301	250	334	(17)
Dividends (c)	120	40	100	—

\* Includes tons recovered from retreated smelter slag

**Rationalisation came too late for Rooiberg,** which slumped to a taxed loss of R353 000, in the wake of the international tin crisis and oversupply. Parent Gold Fields of SA (GFSa) remains confident that much of the world oversupply of tin will be absorbed in the next 18 months, and is hoping to reopen Rooiberg's A mine towards end-1988. The A, B and Vellefontein mines, which account-

MINING

AA648 1/6/87 217

# O'Okiep profits mount to R11,7-m

By TOM HOOD, Business Editor

AFTER facing disaster, the O'Okiep Copper Company swung into a net profit of R11,7-million last year

The 50-year-old Northern Cape mine plunged to a net loss of R18,4-million in 1984 but recovered to an R8,5-million net profit for 1985

This is reported by Gold Fields of South Africa, which took over the running of the mine in October 1984 and now has a 41 percent stake in the company

For most of its life, the mine struggled to keep afloat and needed finance from several quarters to avoid closure, which would have been a calamity for the economy of the region

The copper price plunged in the early 1980s

and Government backing helped the mine survive

GFSA bought shares in the company and made rights issues in 1982 and 1984 to inject millions of rands into the business. Since its affiliation to Gold Fields, annual production of ore has been successfully increased, says GFSA

To mark the company's 50th anniversary, about 380 hectares of land have been given to the local coloured community for a housing development project. But it took the company four years to get its decision to donate the land ratified

The original company inherited the rights to a vast area of arid, semi-desert land and newcomers to the area could only set up squatters' camps as all the land was privately owned



**Black spots**

99 Mr P G SOAL asked the Minister of Education and Development Aid  
(a) How many Blacks were moved from Black spots to Black states in 1986 and (b) (i) from which Black spots, (ii) to which Black states and (iii) why were they moved in each case?

**The MINISTER OF EDUCATION AND DEVELOPMENT AID**

(a) and (b) No Blacks were moved from Black spots  
The Seakamela Squatter Community comprising 839 families was, after negotiations, moved from the farms Dalmeney and Preston and settled on the farms Avon and Innes which later are to be incorporated with Lebowa

358 families from the community of Lmgwali fled from the area and sought assistance from the Department of Development Aid which settled them at Frankfort in collaboration with the Ciskei Government  
119 families from the communities of Mooiplaas and Kwelera fled from those areas and were assisted by the Department of Development Aid to settle on the farm Good Hope

**Teachers detained**

104 Mr S S VAN DER MERWE asked the Minister of Education and Development Aid  
Whether, during the latest specified 12-month period for which figures are available, any teachers in the employ of his Department were unable to perform their teaching duties because of their being detained by the South African Police, if so, (a) how many and (b) in what departmental areas were these teachers employed at the time of their detention?

**The MINISTER OF EDUCATION AND DEVELOPMENT AID**

(a) Yes, 147 according to figures available

(b) Highveld Region	15
Cape Region	79
Natal Region	3
Northern Transvaal Region	14
Orange Vaal Region	5
Orange Free State Region	31
Johannesburg Region	0

**Unemployment Insurance Fund**

112 Mr P H P GASTROW asked the Minister of Manpower

- (1) What was the balance of the Unemployment Insurance Fund at the end of 1986.
- (2) (a) what was the total amount (i) paid into the Fund by State employers and employees and (ii) paid out in benefits in that year and (b) to how many applicants were benefits paid.
- (3) (a) what is the present average rate of interest received by the Fund and (b) what amount was paid from the Fund in 1986 in respect of administration costs.
- (4) (a) what total amount in unclaimed money is held in the Fund and (b) how many persons are involved in this amount,
- (5) how many employers were registered with the Unemployment Insurance Fund as at 31 December 1986?

**The MINISTER OF MANPOWER**

- (1) R171 352 894
- (2) (a) (i) R5 729 690  
(ii) R386 467 103
- (b) 424 461 applicants
- (3) (a) 9,32 per cent in respect of 1986
- (b) R20 248 651
- (4) (a) This figure is not readily available
- (b) The total number of persons involved is not readily available
- (5) 130 036

**GST**

114 Mr C J DERBY-LEWIS asked the Minister of Finance

(a) What amounts were budgeted in respect of general sales tax revenue from (i) Whites, (ii) Coloureds, (iii) Indians and (iv) Blacks for the 1984-85, 1985-86 and 1986-87 financial years, respectively, and (b) what were the actual amounts collected in respect of each of the above categories?

**The MINISTER OF FINANCE**

(a) It is impossible to apportion sales tax collections on a race basis with the result that no separate estimate for each race group is prepared for the Budget  
(b) Fall away

**Gold/silver/platinum**

115 Mr C J DERBY-LEWIS asked the Minister of Economic Affairs and Technology

What were the average prices realised in rands for (a) gold, (b) silver and (c)

Whites to Cape Coloureds	214
Whites to Chinese	30
Whites to Malays	9
Whites to Indians	51
Whites to Blacks	5

**National states: officials seconded**

119 Mr P G SOAL asked the Minister of Education and Development Aid

- (1) (a) How many officials in the Public Service had been seconded to each specified national state, (b) what post was held by each such official, and (c) what was the cost of the secondment of such officials, as at the latest specified date for which figures are available,
- (2) whether all posts in the national states in respect of which secondment is

platinum in 1980, 1982, 1984 and 1986, respectively?

**The MINISTER OF ECONOMIC AFFAIRS AND TECHNOLOGY**

Rand/troy ounce	1980	1982	1984	1986
(a)*	480	412	528	837
(b)	13	7	9	10
(c)†	531	355	521	1 065

Prices quoted by Chamber of Mines

**World prices**

**Prohibition of Mixed Marriages Act**

118 Mr M J MENTZ asked the Minister of Home Affairs †

How many marriages between Whites and members of other specified race groups were solemnized since the repeal of the Prohibition of Mixed Marriages Act No 55 of 1949 (a) up to 31 December 1985, (b) in 1986 and (c) from 1 January to 6 May 1987?

**The MINISTER OF HOME AFFAIRS**

**Marriages Solemnized**

(a)	(b)	(c)
1985-06-19	1986-01-01	1987-01-01
1985-12-31	1986-12-31	1987-05-06
214	266	80
30	28	7
9	19	6
51	77	23
5	13	6

required are filled at present, if not, how many remained vacant as at the latest specified date for which figures are available,

- (3) whether any further secondments are envisaged, if so, how many?

**The MINISTER OF EDUCATION AND DEVELOPMENT AID**

- (1) (a) and (b) The information as requested is contained in the attached schedule

16/6/87 Handwritten notes and signatures



(ii) failed their examinations in all subjects at the end of the year? The MINISTER OF EDUCATION AND DEVELOPMENT AID

(a)	University of Zululand	(i)	244	(ii)	78
	University of the North		40		321
	Medical University of Southern Africa		12		25
	Vista University		830		925
(b)	University of Zululand		19 8		6.3
	University of the North		2 75		22.14
	Medical University of Southern Africa		2 85		11.16
	Vista University		12 5		13.9

Per capita expenditure

40 Mr R M BURROWS asked the Minister of Education and Development Aid

What was the per capita expenditure, (a) including and (b) excluding expenditure of a capital nature, on Black school pupils in the 1985-86 financial year?

The MINISTER OF EDUCATION AND DEVELOPMENT AID

- (a) R387.02
- (b) R303.23

Own Affairs

State housing sale

16 Mr P C CRONJÉ asked the Minister of Local Government, Housing and Works.

(a) How many houses had been sold by his Department in each province under the State housing sale announced by the then Minister of Community Development on 3 March 1983, as at the latest specified date for which figures are available and (b) how many houses remained to be sold in each province as at that date?

The MINISTER OF LOCAL GOVERNMENT, HOUSING AND WORKS

HOA

18/6/87

As at 31 May 1987 in respect of dwellings erected for Whites from the National Housing Fund

(a)	Transvaal	843
	Orange Free State	175
	Cape	2 113
	Natal	479
(b)	Transvaal	1 186
	Orange Free State	119
	Cape	5 677
	Natal	234

Houses without electricity

30 Mr P G SOAL asked the Minister of Local Government, Housing and Works.

Whether any houses in White group areas are not being supplied with electricity at present, if so, what (a) total number and (b) percentage of houses situated in White group areas in each province was not being supplied with electricity as at the latest specified date for which information is available?

The MINISTER OF LOCAL GOVERNMENT, HOUSING AND WORKS

No, not insofar as housing supplied by the Department is concerned

18/6/87

FRIDAY, 19 JUNE 1987

of the emergency regulations in 1986, if so, (a) when, (b) where and (c) what is the name of this person.

- (2) whether he received a request from or on behalf of this person to furnish reasons for her detention, if so, when,
- (3) whether he has furnished this person with such reasons, if not, why not, if so, on what date?

5 Mr S S VAN DER MERWE asked the Minister of Law and Order

How many investigations had been held by the South African Police into alleged contraventions of the Group Areas Act, No 36 of 1966, since 1 January 1987 as at the latest specified date for which information is available?

The MINISTER OF LAW AND ORDER

394 cases until 30 April 1987

Joint management centres

9 Mr P G SOAL asked the Minister of Law and Order

With reference to his reply to Question No 114 on 20 February 1987, (a) what are the names of the members of each of the eleven joint management centres, (b) on what basis were they appointed and (c) what tasks do these members perform on these joint management centres?

The MINISTER OF LAW AND ORDER

(a) and (b) I refer the honourable member to my reply to written questions numbers 114 and 565 which I regard as sufficient

Sandra Steward

10 Mr S S VAN DER MERWE asked the Minister of Law and Order:

(1) Whether a certain person, whose name has been furnished to the South African Police for the purpose of the Minister's reply, was detained in terms

19/6/87

The MINISTER OF LAW AND ORDER

(a) 14 June 1986

(b) The Female Prison, North End, Port Elizabeth

(c) Sandra Steward

(3) Falls away

Note This person was already released from detention on 5 September 1986

Gold/silver/platinum

107 Mr C J DERBY-LEWIS asked the Minister of Economic Affairs and Technology

How many fine ounces of (a) gold, (b) silver and (c) platinum were (i) mined and (ii) marketed in 1984, 1985 and 1986, respectively?

The MINISTER OF ECONOMIC AFFAIRS AND TECHNOLOGY

	1984	1985	1986
(a) (i)	21 861 000	21 524 000	20 514 000
(ii)	Classified information		
(b) (i)	6 978 907	6 699 708	7 172 113
(ii)	7 625 159	7 077 593	7 629 781
(c) (i)	Classified information		
(ii)	Classified information		

Uitenhage: crime

123 Mr D J N MALCOMESS asked the Minister of Law and Order

19/6/87



# US will decide on uranium imports

217  
SMB  
18/6/87

By Neil Lurssen, The Star Bureau

WASHINGTON — The United States Treasury is to decide soon whether sanctions laws will forbid the import of uranium ore and uranium oxide from South Africa valued at millions of rand

Mr R Richard Newcomb, Director of the Office of Foreign Assets Control in the Treasury, told a congressional committee here that a decision was expected before July 1

The possibility of a ban has alarmed American companies which process uranium ore and uranium oxide for foreign buyers and re-export to the foreign buyers

If the ban is confirmed, thousands of American jobs could be lost in seven states. The companies have enlisted the aid of their Senators, who have asked the Treasury not to include uranium in the list of banned imports contained in the sanctions imposed last year

## NO AMERICAN CONTROL

Senators have argued that an end to American involvement in the processing of the South African uranium — enriching it for use as nuclear fuel — would end American control over the future use of the fuel by potentially hostile nations like Libya

Mr Newcomb said that because of uncertainty over the intent of the Congress regarding the uranium, the Treasury had called for public comment

During the period of comment and analysis, uranium ore and oxide were being imported from South Africa in the usual way.

"The Treasury took this action because the domestic uranium conversion industry and the federal government's enrichment industry could be seriously injured in a manner unintended by the Congress if imports for processing and re-export were barred through a mistaken interpretation of the Act," he said

Mr Newcomb said there were cases involving false country of origin declarations for textiles and false declarations for semi-concentrates and sports equipment

SISHEN MINE

**Still near capacity**

The Sishen-Saldanha scheme, commissioned by government a decade ago at a then cost of R700m, may never have fulfilled the great expectations set for it. But, after recent rationalisations, it is still far from being a white elephant.

Originally Iscor hoped to export up to 18 Mt of iron ore a year through Saldanha. But even in the early halcyon days no more



than around 15 Mt a year passed through the port. Today that figure has fallen right back to 8,88 Mt a year.

However, the mine is still producing over 16 Mt of ore a year with 7,2 Mt now being either processed by Iscor's own mills at Vanderbijlpark and Newcastle, or sold on the local market.

The old south beneficiation plant has been closed down and all production is now centred on the much more modern north plant that was the basis of the original export scheme. This plant has the capacity to treat up to 18 Mt a year and is consequently currently running at close to full capacity.

Iscor tells the *FM* that, in view of the decline in steel production in the Western world, it can be expected that the existing iron ore surplus will continue until at least 1995. "This situation creates little hope for higher sales volumes from Sishen. In fact, there is no likelihood that the original export target of 18 Mt a year will ever be met," says Iscor.

Nonetheless, trains are still leaving Sishen at a rate of three a day, though the length of the trains is regulated in accordance with demand and optimum electricity consumption.

Meanwhile, Iscor's seemingly evergreen Thabazimbi iron ore mine is still producing 2,3 Mt a year, virtually all of it going to the old Pretoria works. ■

FM  
19/6/87 217



AK645 3/787

317 280

# Americans facing big uranium ban backlash

From NEIL LURSEN  
The Argus Foreign Service

WASHINGTON. — Thousands of American jobs are in jeopardy and foreign earnings may be cut by hundreds of millions of dollars after the US Treasury ruling that uranium ore and uranium oxide may no longer be imported from South Africa

The Treasury said it recognised the impact the decision could have on the American uranium-processing industry, but that was an important concern that had to be addressed by the US Congress

It is the first known instance where the 1986 US sanctions measures against South Africa have the potential for a serious backlash effect on American industry

Yesterday's decision ends a long dispute over whether section 309 of the Sanctions Bill included a ban on uranium ore and oxide bought from South Africa and shipped to the US for enrichment into nuclear fuel before being re-exported to the owner countries.

## Pleas to Reagan

Supporters of the sanctions insisted the raw uranium was covered by the Bill while senators from states that faced job losses, including some who had voted in favour of the sanctions, pleaded with President Reagan to allow the uranium to be imported

The US Treasury called for public representations on the dispute and issued a temporary permit for the uranium to be allowed in until the matter was resolved

That permit was allowed to lapse yesterday when the Treasury announced it had concluded that the Congress had intended that South African uranium ore must be banned

Neither the Sanctions Bill nor the Treasury decision makes reference to uranium hexafluoride, an intermediate stage in the complex conversion process

This means that, theoretically, the South African ore can still be converted to hexafluoride abroad before being sent to the US for the final enrichment process

However, the US industry fears that foreign clients, uncertain about what the US Con-

gress will ban next, will send their uranium elsewhere rather than get caught up in the American fight over South Africa

In addition, the US Nuclear Regulatory Commission must issue permits for the importation of the hexafluoride, another uncertainty for the foreign businesses

The word in Washington is that the fight over South African uranium is not over and that some senators will introduce a measure to lift the ban

The decision by the United States to finally ban the import of uranium and uranium oxide from South Africa was not "disastrous", said a spokesman for the South African industry today

"Although it is not a positive step, anticipatory moves to counter the ban have been taken since last year when the Anti-Apartheid Act was passed in the US"

The Nuclear Fuel Corporation spokesman added that some European clients, who had used the United States to convert and enrich the South African uranium and uranium oxide, would welcome this step to withdraw from contracts held with United States agencies

## Other options

The ban would be detrimental to the United States, as business done through that country could now go to other countries which had such facilities

Among them are France, Britain and Russia

The value of contracts affected by this move are not known as uranium export figures are classified

# Don't fence them in

Is it a good thing or not? From any number of quarters, the virtues of beneficiation have been extolled and debated. If we are to lead the way out of recession with exports, SA's storebox of metals, minerals — even, lately, chemicals — would seem to be superbly qualified for processing before export. That's one way to get add-on value in foreign exchange. But there certainly isn't consensus as to how — or even if — it should be tackled.

Perhaps the most ardent proponent of beneficiation is Council for Mineral Technology (Mintek) president Dr Aidan Edwards. He maintains that SA can never aspire to First World status until it makes some headway in beneficiation. As he put it to the *FM* this week: "It is absurd that we have some 80% of the Western world's chrome reserves,

---

Proponents of beneficiation have long argued the case for adding to the value of SA's exports. It isn't a simple process — but in the jewellery sector the time is definitely ripe for cutting out the red tape and getting on with it.

---

yet produce only 1% of the world's stainless steel. In fact, annual earnings of the aluminium industry in SA, at R1,5 billion, are more than the annual earnings of the chrome industry at R1,3 billion — and we don't even have any reserves of bauxite.

"If we produced just 10% of the world's stainless steel, it would earn the country roughly half the current earnings of gold —

and gold is a diminishing resource."

Edwards adds that with 92% of the West's platinum reserves, 49% of the gold, and 30% of the entire world's gem diamonds, SA should be supporting a thriving jewellery industry. But a combination of strict controls offers little incentive to the local jewellery industry. A jeweller must pay up-front for unwrought gold and uncut diamonds — and there's still the ad valorem tax on finished articles. Compare that with Italy, which absorbs around 250 t of gold a year, much of it from SA, and re-exports at least some of it back in the form of jewellery to SA and many other markets. By the same token, Israel, which has no diamonds of its own, is now a major diamond cutting country.

Edwards tells the *FM* that steps are being taken to examine the constraints on the jew-





## SA's minerals: where we stand in the world

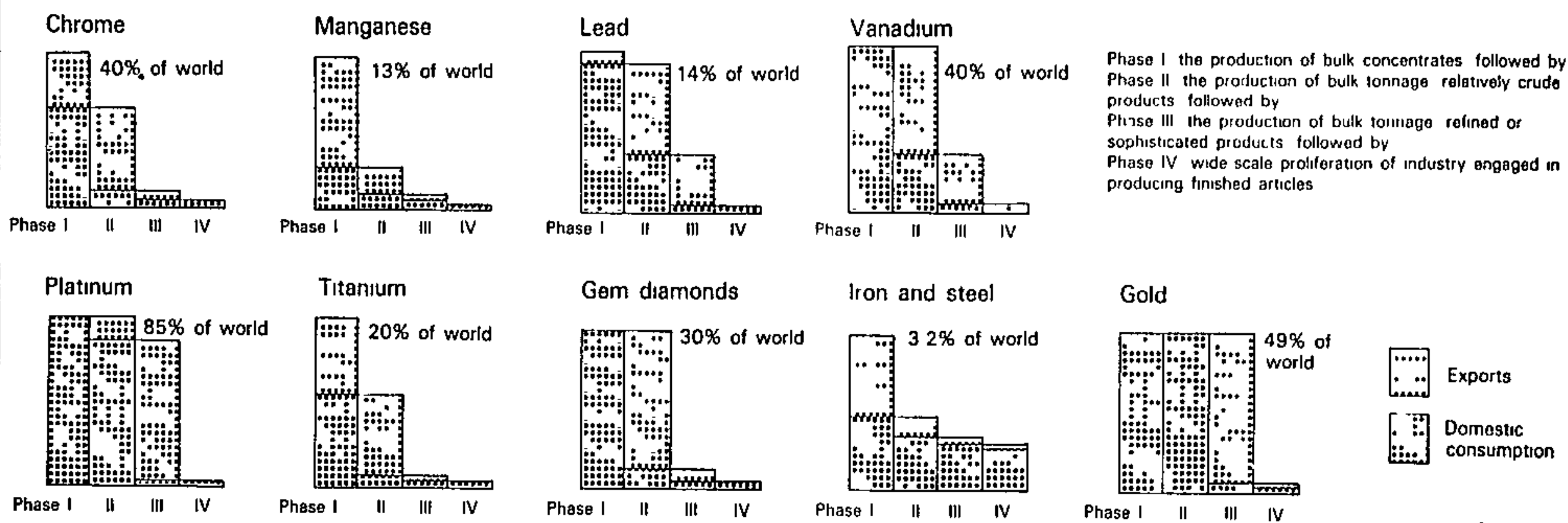

ellery industry, and that this could constitute a first move towards local beneficiation of gold, which has huge added value as jewellery

He says "It is an anachronism that State constraints through the imposition of heavy duties and complex requirements for certification and registration, have been the most inhibiting factor in the development of a large South African jewellery industry"

Tim Davidson, executive director of the SA Jewellery Council, says that for years government has been pressed to drop the ad valorem tax on jewellery. However, except at the Department of Mineral and Energy Affairs, where the idea received a positive hearing, other government departments seem to be more interested in collecting the tax than seeing the establishment of a viable jewellery industry

SA also has 20% of the world's titanium and 40% of its vanadium, both of which are exported in slag form. Both could be beneficiated to make industrial products — titanium, for example, is used in the manufacture of white goods

Edwards points to Taiwan as an example of a developed country that has pulled itself up by its bootstraps. Taiwan's foreign exchange earnings rose from US\$1,3 billion in 1969 to \$35,4 billion in 1985 — an increase of 27 times. During the same period SA showed an increase of only five times and today earns only 45% as much as Taiwan. Edwards notes "All this has occurred despite the fact that Taiwan has hardly any raw materials to speak of, and has had to find its own feet in the harsh international field of trade." In fact, Edwards goes so far as to say that SA should adopt the slogan "Beneficiate or bust"

Edwards says he sees four phases in any country's development (see graph). The first involves the production of bulk concentrates, Phase 2 is the production of bulk-tonnage, relatively crude products, Phase 3, the production of bulk-tonnage, refined or sophisticated products, and Phase 4, wide-scale proliferation of industry engaged in producing finished articles. He says SA is currently in Phase 2

However, he also maintains that the lack of skilled manpower in the country could

prove to be the biggest single stumbling block in the path of metal and mineral beneficiation

But if Edwards is the arch-proponent of beneficiation of metals and minerals, not everybody agrees with him. In his closing address as president of the Chamber of Mines last week, Peter Gush, head of Anglo American's gold and uranium division, said the normal operation of free markets would ensure that beneficiation of minerals would be undertaken, provided the rewards were in proper relationship to the risks involved

Says Gush "While SA may have a significant share of the raw product, an equitable share of the international market for the processed product is not automatically assured. The industry has to weigh up potential profitability against the vertical integration of operations that are traditionally the preserve of the very customers who have enabled our industry to achieve its success so far

"While the possibility of competition with customers does not necessarily forbid entry into a business, such a venture must be carefully weighed, particularly where there are alternative sources of supply of raw materials and where such customers form the backbone of the markets to be served by the beneficiated products," Gush says

He adds "The benefit from expanding the beneficiation of South African minerals will, to a large extent, be determined by the competitiveness of local producers compared with foreign producers who have access to similar minerals and processing facilities"

The current president of the Chamber of Mines, Gencor's Naas Steenkamp, also has his reservations. He maintains that if there was a profit to be made in further beneficiation — as has already happened in the case of ferrochrome and ferromanganese — then people would already have beneficiated

Like Gush, Steenkamp is not at all sure that competing with one's customers is a good idea

But Edwards sees it differently "I'm not talking about competing with customers. I would like to see our customers going into partnership with South African companies to produce beneficiated products here. It would in many cases be cheaper to do it here close to source than overseas"

But whether overseas companies would invest here, particularly in the current inhospitable political climate, is moot. Edwards believes that when economics do the talking politics come second

In his pro-beneficiation stance he appears to have the support of the Minister of Mineral and Energy Affairs, Danie Steyn, who earlier this year said "The fact that SA is the number one supplier of chromium, manganese, vanadium, platinum and gold may not be as wonderful to the long-term future of this country as we think SA's drawback has been its failure to generate or export high-technology products. As the world moves rapidly into an age of high-technology, we are passing through a phase in which growth in the demand for raw materials is low. And what hurts SA is downturn in demand for many of our basic commodities"

But it's not only in the fields of metals and minerals that beneficiation could be of advantage to SA. Mike Sander, managing director of AECI, is on record as saying that, if SA ever hopes to become a successful exporter of chemicals, it had better move towards beneficiation now

There is a glut of so-called raw or commodity chemicals on world markets — basic acids, ammonia, chlorine and even some types of plastic. This means that SA, essentially a producer of commodity chemicals, would do well to broaden its chemical base, according to Sander. Production of speciality chemicals is a move in this direction — something already being pursued by companies like Chemical Services, in which AECI has a controlling interest. Johan van der Walt, a director of Sentrachem, endorses Sander's views

To sum up it would certainly seem that the proponents of the unshackling of the jewellery industry really do have a point. The creation of a viable jewellery industry would in turn lead to SA beneficiating its own gold and making use of some of its diamonds at home, rather than exporting the great bulk of them. And why tax exports of this nature — unless out of some form of anti-rich political pique? As for other basic commodities — well, Gush and Sander both seem to have a point. Perhaps in the end the bottom line will tell who was right

# US govt to ban SA <sup>CAP TIPS</sup> uranium <sup>3/7/87</sup> <sup>280</sup> <sup>317</sup>

WASHINGTON. — The government announced yesterday that it was banning imports of uranium and uranium oxide from SA despite objections from congressmen trying to protect jobs at a US uranium-reprocessing plant.

The Treasury Department in March had allowed the imports to continue till July 1 while it sought clarification of Congress's intent regarding sanctions imposed against South Africa.

The department said the section of the anti-apartheid sanctions that were passed last year needed clarification concerning imports of South African uranium shipped to the US for processing before being shipped to other countries for final use.

In a discussion during debate on the bill, Senator Mitch McConnell of Kentucky had sought to restrict the ban on South African products so that it would not cover uranium meant for re-export to other countries. — Sapa-AP



# Uranium ban may affect US

Political Staff

IT APPEARS that the US ban on South African uranium could rebound on America and affect her more than South Africa

Reports from the US indicate that hundreds of nuclear workers could lose their jobs through the ban. It would appear Congress and Treasury did not have the proper experts to consider the consequences before going ahead with the total ban

Mr David Sinclair-Smith, general manager of the Nuclear Fuel Corporation (Nufcor), said steps had already been taken to minimize the effect of the ban on SA and its customers

"It is not as though the move has taken us by surprise and we have had a long time to prepare for it. However, it will make business a lot more inconvenient, but not a total loss," he said

## 'Enrichment done elsewhere'

Mr Sinclair-Smith explained that SA sold uranium to its customers and then delivered it to the enrichment facility of their choice

Up to now America had allowed this uranium in, but had now clamped down on any uranium coming from SA irrespective of who the owner was.

There were two important stages in the enrichment process which many customers had done in America, but could now have them done elsewhere.

The uranium first had to be converted into uranium oxide and then into an intermediary stage, uranium hexafluoride, known as UF<sub>6</sub>. There was no ban on UF<sub>6</sub> entering America, so customers could have the initial stages done in Europe.

"Where America will lose out is on the first stage of conversion, but it could also lose out on the second stage, as this can also be done in Europe," Mr Sinclair-Smith said

U  
S  
S

UN  
U S  
SUB

U J  
S 'S

# Golden Dumps pulls off several coups for its platinum mining project

W/C Areas  
4/7/87  
217

From DAVID CUMMING

JOHANNESBURG — Golden Dumps' soon-to-be-listed Lefkochrysos platinum mining project is set to become far larger than analysts originally believed.

In setting up the project Loucas Pouroulis' company has pulled off several coups, under the noses of some of the major mining houses.

As more details of the operation in the Brits area become known in the highly secretive platinum mining world it emerges that:

- A second, much larger section of the mine is planned. It will exploit the orebody at below 1 000m and raise overall production to 640 000 ounces of platinum group metals (325 000 ounces of platinum) by 1994.

- It has negotiated about 450 separate mineral rights contracts in the mining area without competitors getting wind of its plans.

- It will be producing a projected 160 000 ounces of platinum a year before GFSA's Northam mine is in production

- What were previously thought to have been "geological problems" with the orebody — the result of sketchy drilling in the 1960s — have been shown from infill drilling to have been the result of incomplete interpretation.

- In spite of the notorious difficulty from a metallurgical point of view of handling platinum group metals, it is intended the mine will produce high quality metal for sale on both London and Zurich spot markets to facilitate sales.

- The mine will be highly mechanised. Staff will consist exclusively of skilled technicians, virtually eliminating the possibility of production

disruption by strikes

All of which is good news for potential holders of the 60 million shares of R11. These will be made up of 40 million in the hands of Golden Dumps' Salene and Dallad, six million for a private placing, three million of which have gone to institutions on condition they take up a further three shares at R13 for each share taken.

Staff and business associates have taken up a further three million R5 shares without the obligation of taking up further shares. A further three million shares will be made available to staff and associates at R13 and the public will get two million at R13.

In the first section the UG2 reef will be mined from the surface using advanced trackless mining methods. In the second, the reef will be mined at the deeper levels. This section will have its own plant.

## MINOR FAULTS

Both reefs in the area were earlier thought to have been displaced by many minor faults between the major faults. Detailed drilling, trenching and geophysical investigations have now shown this is not the case.

A report by sponsoring broker JD Anderson says production costs a ton are expected to be extremely low, enabling the mine to be highly competitive with existing operations and enabling it to withstand any downward movement in platinum group metal prices should demand and supply move out of balance.

Ore will be processed on site to produce a smelter matte which will be transported to base and precious metal refineries on the East Rand



ort

Global stock levels high 217

# Samancor hit by drop in demand

*Case Times 14/7/87*

By AUDREY D'ANGELO  
Financial Editor

SAMANCOR, which supplies chrome and alloys to industries all over the world and employs more than 9 000 people in SA, has been hit by falling industrial demand overseas

Chairman S P Ellis explains in the annual report that the weak rand helped to make up for falling export sales in the year to March.

But, he warns, "Should the recent strengthening of the rand, combined with a continuing high rate of inflation and pressure on export sales volumes persist, a reduction in profits from the exceptionally high levels experienced during the past two years will be unavoidable"

However, Ellis says that "recent signs of an upward trend in the selling prices of certain of the group's products may provide some counter to these negative effects"

And, he says, Samancor "will continue with research into alternative technologies for the production of benefited products to ensure the group's continued competitiveness".

Ellis explains the reason for falling demand last year was lower industrial production overseas combined with high stock levels and more competition from overseas producers

"A further reduction in foreign ferrochrome production is expected in the current year and this, together with the high levels of stocks held by consumers, may have a further negative impact on export sales of chrome ore

"The world's supply of silicon metal steadily increased during 1986/87 and an excess of supply over demand was evident. Consequently, gradually declining price levels were experienced in most markets during the year"

Ellis says the stronger rand and inflationary pressures on production costs, together with higher tax, reduced the profit contribution from chrome alloys in the past year

He added "New production facilities coming on stream in certain foreign countries could reduce the group's market share"

Samancor lifted turnover in the year to March to R832m (R803m) But earnings fell to 117,40c (152,12c) a share

# Record Rusplat dividend after R555-m tax bill

By TOM HOOD, Business Editor

A R555-million tax bill would be enough to clobber almost any company, but Rustenburg Platinum, the world's largest platinum mine, coughed up and still paid shareholders record dividends of 200c for the year to June

The 110c final is up by a third and total dividends are 48 percent more than last year's 135 total

Sales volumes of platinum increased and higher dollar and rand prices were recorded, says the new chairman, Mr Pat Retief, in his preliminary report

Operating profit surged by R381-million (53 percent) to R1 098-million. The tax man's haul jumped even higher — by 57 percent or R201-million to R555-million

Earnings a share rose to 293,8c from 185,2c on an unchanged share capital

Improved salaries, benefits and employment conditions were extended to all employees, says Mr Retief.

If current rand prices persist, Rustenberg's profit in the 1988 year should be similar, he forecasts



# Aiming for a platinum coup



Since Loucas Christos Pouroulis (48) left Anglo American in 1971, he has established himself as SA's most successful independent mining entrepreneur. If his Lefkochrysos Platinum

mine (Lefko) near Brits turns out to be all he claims, then his Golden Dumps group will become a mining house to be reckoned with.

But the R253m platinum venture is a far larger and more complex project than anything Pouroulis has yet tackled — quite different from running a small gold mine. More complete details should be available when the prospectus is issued next week. But it is obvious that Lefko will require hefty financial, technical and managerial resources — and needs to be carefully considered by potential investors.

Pouroulis has overcome formidable obstacles in the past. As a pioneering independent in a gold mining industry dominated for more than 50 years by major mining houses, he had a rough ride setting up his first gold mines, Consolidated Modderfontein and South Roodepoort, both of which had been closed previously by major mining houses.

Without an established track record, Pouroulis was unable to raise locally the R20m he needed to finance Cons Modder. He eventually found the money in London through stockbroking firm Laing & Cruickshank. Seven years later, with these two mines making healthy profits, Pouroulis has had no problem finding finance for Lefkochrysos (an ancient Greek word meaning white gold).

Even so, some observers are sceptical that he can actually bring the mine to profitable production. Although they make no official comment, the established platinum producers appear to be among the sceptics. These groups have accumulated immense platinum marketing and technical expertise, and, of course, the three present South African producers — Rustenburg, Impala and Western — are accustomed to dominating supplies of platinum group metals to Western markets.

Platinum is a tougher nut to crack than gold, from both metallurgical and marketing viewpoints. In contrast to the gold producers, which sell their gold to the Reserve Bank, competition between the platinum producers is cut-throat. They market independently and have kept their activities highly secretive, refusing to publish such basic information as recovery grades, working costs, and production levels. There is no technical co-operation between the platinum groups.

Pouroulis's reaction to being viewed as

**If mining entrepreneur Loucas Pouroulis brings his Lefkochrysos platinum mine to profitable production according to his own ambitious schedule, it will be the biggest coup in decades by an independent mining group. But investors should realise the risks involved.**

a gatecrasher at the platinum party has been to establish at the outset that he, too, is tough. So far, he has poached for Lefko the manager of Western Platinum's complex precious metal refinery, won control of mineral rights which previously formed part of Rustenburg's Pandora prospect, and, by planning to get into production some two years ahead of Gold Fields of SA's (GfSA) new Northam Platinum, must be pitching for customers GfSA would have liked to tie up.

Lefko controls the mineral rights to more than 11 000 ha of ground around Brits (see map). The platinum-bearing Merensky and UG2 reefs outcrop on surface in the south of the area and dip to the north. JCI continues to hold some of the mineral rights within the project area, including a large chunk in the centre, and certain boundary areas. Pouroulis acknowledges this, but says it does not present a problem, as Lefko can simply mine around the JCI-held areas.

Plans are to start mining the UG2 reef in the shallow area, using rubber-tyred load haul dumpers (LHDs) and jumbo drill rigs

in a highly mechanised operation. Production is scheduled to start in 1989, hitting first-phase full output of 160 000 t a month within a year. A report by one of Lefko's sponsoring stockbrokers, J D Anderson, estimates that at that milled production level, Lefko should produce some 280 000 oz of platinum group metals (PGM) annually, of which some 144 000 oz will be platinum.

The plan is to set up a treatment plant at the mine, comprising a conventional milling section, flotation circuit and smelter, to produce a UG2 convertor matte. The matte will be sent to Lefko's own base metal and precious metal refineries on the East Rand. Pouroulis says a base metals refinery is necessary because the UG2 reef — like the Merensky Reef — contains quantities of base metals, which need to be removed before the PGM can be recovered.

Total cost of the first phase is estimated at R253m, of which some R101m is for the refineries and treatment plant. Longer-term planning is to sink vertical shafts in the deeper, northern sections of Lefko's ground. This would cost another R350m, to be financed from retained earnings. J D Anderson estimates this would push Lefko's annual production to some 640 000 oz of PGM, containing 326 000 oz of platinum by 1994.

Because the mine is to be highly mechanised, Pouroulis says, less than 1 000 workers will be needed for the Lefko operation. Sinking of the first three decline shafts has started and work will soon start on a fourth. Contractors are doing the surface excavations down to about 15 m, after which Lefko's staff take over the sinking. Stockpiling of ore on surface is due to start in about two weeks.

Edward L Bateman is carrying out the design and project management work on Lefko's concentrator. The smelter will be built by a Bateman/Lurgi syndicate, while Lefko is also using Bateman for back-up on much of the general technical work involved. The base metal refinery will use Sherritt Gordon technology, with Sherritt Gordon doing the detailed engineering. Construction contracts for this and the precious metals refinery have not yet been awarded.

Arrangements have been made to obtain water for the mine from the nearby Crocodile River. Lefko MD Richard Johnson adds that an agreement has been reached with the Department of Water Affairs to release enough water from the Hartbeespoort Dam to meet the mine's requirements.

Derek Ritchie, mining analyst at stockbroking firm Fergusson Brothers Hall Stewart, says "I believe Pouroulis can make Lefko work and that it is a worthwhile project. However, I think he is being too optimistic in planning to hit full



**Lefko's Pouroulis ... fighter in a competitive sector**



production within a year of start-up That could take between two and three years to reach, depending on teething problems encountered "

Certainly, Pouroulis's determined — some may say headstrong — approach has given rise to misgivings Lefko's critics say he is rushing into a project that calls for a more cautious approach

Messina, for example, another prospective new platinum producer, is setting up a R10m pilot mining and treatment operation before committing itself fully to its proposed platinum mine to exploit Merensky reef — far easier to treat than UG2

The critics claim that problems associated with mining the UG2 reef, as well as the faulted nature of the ground, could slow Lefko's production build-up, and that there could be severe metallurgical problems smelting the UG2 concentrates into a matte, because the technology for this is far from proven For his part, Pouroulis rejects these criticisms He contends that four years of planning have gone into Lefko and all these problems have been foreseen and planned for

A number of independent geologists and mining engineers tell me they support him, although they continue to hold reservations on the UG2 smelting technology issue The UG2 reef contains chrome in quantities that make smelting very difficult when com-

pared with Merensky reef Pouroulis counters by saying the Council for Mineral Technology (Mintek) has developed the technology to successfully smelt UG2 concentrates Pouroulis is mining UG2 because the Merensky reef at Lefko is of too low a grade to mine down to a vertical depth of 400 m

Since 1983, Wesplat has been running a UG2 smelter established with Mintek's help Wesplat could not get it to work on pure UG2 concentrates Merensky ore concentrates containing higher levels of copper and nickel sulphides, which proved crucial in attracting the PGM in the smelting process, had to be mixed with the UG2 concentrates before the system gave acceptable recoveries

Lefko will not have Merensky concentrates to blend in — at least not in the beginning

However, Mintek Report 1-87 on PGM from the UG2, released early this year, describes a number of modifications to smelting technology undertaken since then It provides the basis for Pouroulis's confidence that the UG2 concentrates can be successfully smelted

Lefko is taking out a licence to use Mintek's patented UG2 recovery and smelting system and Mintek is acting as metallurgical consultant to the mine

For the present, though, there are no guar-

antees on the process A Mintek spokesman with pyrometallurgical experience tells me. "Our work on various UG2 ores has shown that, in principle, it is technically feasible to smelt pure UG2 ore concentrates However, until we have carried out and evaluated pilot plant testwork on Lefko's specific UG2 ore, it is impossible to be completely sure it can be done "

Bulk ore samples from Lefko have still to be delivered to Mintek for this pilot plant work to be carried out The prospectus apparently includes a statement from Mintek.

Faulting in the shallow Lefko areas has broken up the orebody into large blocks which will be mined separately A geologist with experience of platinum deposits in the region tells me "By Bushveld Igneous Complex standards the Lefko ground is heavily faulted, but by gold mining standards it is not Any miner from Buffelsfontein (a Gencon mine experiencing severe faulting problems) would think Lefko a piece of cake "

If all goes according to schedule, Lefko will be on stream well ahead of GFSA's Northam, despite the far larger resources of GFSA

The explanation for this, apart from Pouroulis's own breathless style, is that the two projects are radically different

Before mining can start, Northam needs to sink shafts to depths of 2 000 m This will take some three years Because of the

## LOUCAS IS A LEAN AND HUNGRY MINING MAN

Pouroulis is a Greek Cypriot who came to SA in 1964 at the age of 25 with degrees in mining engineering and metallurgy. He joined Anglo American as a learner graduate and worked on the East Daggafontein and Western Deep Levels (WDL) gold mines, eventually becoming a section manager at WDL before he left in 1971 to go into business for himself.

Pouroulis headed back to the East Rand, where his experience at East Dagg had revealed the potential of this, and other, East Rand mines then on the point of closure

In 1974 he acquired claims over the New Modderfontein and Modder Deep mines. His major break came in 1977 when he negotiated a contract with Anglo American for a gold clean-up at the East Dagg and Daggafontein mines which had been closed. Pouroulis pulled 700 kg of gold out of the mines, way in excess of what Anglo thought he could recover, and the proceeds went into setting up the Modderfontein 74 treatment plant.

In 1978 Pouroulis took management control of the South Roodepoort mine on the West Rand and, in 1979, he acquired Government Gold Mining Areas, which he merged with his other East Rand claims into Consolidated Modderfontein Cons Modder coped with the post-1981

gold price crash by becoming a small, high-grade operation instead of the large, low-grade mine described in the prospectus This quarter the mine should for the first time hit its 70 000 t/month milling capacity available since 1982

In the year to end-June, Cons Modder made net profits after tax of R34m, while in the same period South Roodepoort made net profits of R8m

With his gold mines launched, Pouroulis began to diversify He moved into offshore diamond mining in 1983 through Dawn Diamonds, so getting involved in what some see as one of his few failures — although he rejects this view

While Pouroulis's mansion in Bryanston, Sandton, reflects the wealth of its owner, his head office is an austere and cramped house in Randburg which has been extended by addition of prefabricated office space The management policy is to get the staff out working on the mines and keep the head office operation to a bare minimum

Described by his staff as a "human dynamo," and by outsiders as an extremely proud man who will not admit failure, Pouroulis runs his business using a strict hands-on approach He delegates authority but managers who do not produce the goods get personally "revved" in

language which leaves no room for misunderstanding

At head office, Pouroulis has six key executives reporting to him, but there appears to be no obvious second-in-command at Golden Dumps All his top staff have come from a number of the major mining houses — including two former JCI consulting engineers, Hag Slater and Tony Painting Geologist Roger Daniel was acquired from GFSA

Lefko MD Richard Johnson (36), a mining engineer who joined Pouroulis in 1980 from JCI, asks "How many executives my age would have had the chance to get involved in the exploration work, acquisition of mineral rights and feasibility studies for a major platinum mine — and then be sent out to find investors for the project and customers for the metals?"

Pouroulis says he believes in paying his staff well and ensuring they are considerably better off than they would be in comparable positions in a major mining house His mines are not members of the Chamber of Mines and he pays his mineworkers well above chamber rates In return, he makes sure he gets his money's worth It is quite common for a meeting to be called suddenly on a Sunday afternoon



different thermal gradients, temperatures at that depth in platinum mines equate to those found only at 4 000 m on gold mines Northam, therefore, has to instal refrigeration equipment to cool the mine workings. Thanks to its shallower operations, Lefko will not need such complex and costly cooling equipment.

Initially, Northam will mine Merensky ore. According to Mintek, the PGM grades of concentrates produced from UG2 reef are three to five times higher than those obtained from the Merensky reef, resulting in

significant advantages in the downstream process. Lefko will be able to instal smaller furnaces and convertors, allowing for lower operating and capital costs for the plant.

These factors account for the differences in capital cost. Northam is estimated to cost R559m until it reaches financial self-sufficiency in 1993.

Louw Alberts, former president of Mintek and Director General of Mineral and Energy Affairs until his retirement on June 30, has been appointed a director of Lefko with effect from August 1.

## Lefkochrysos starts up

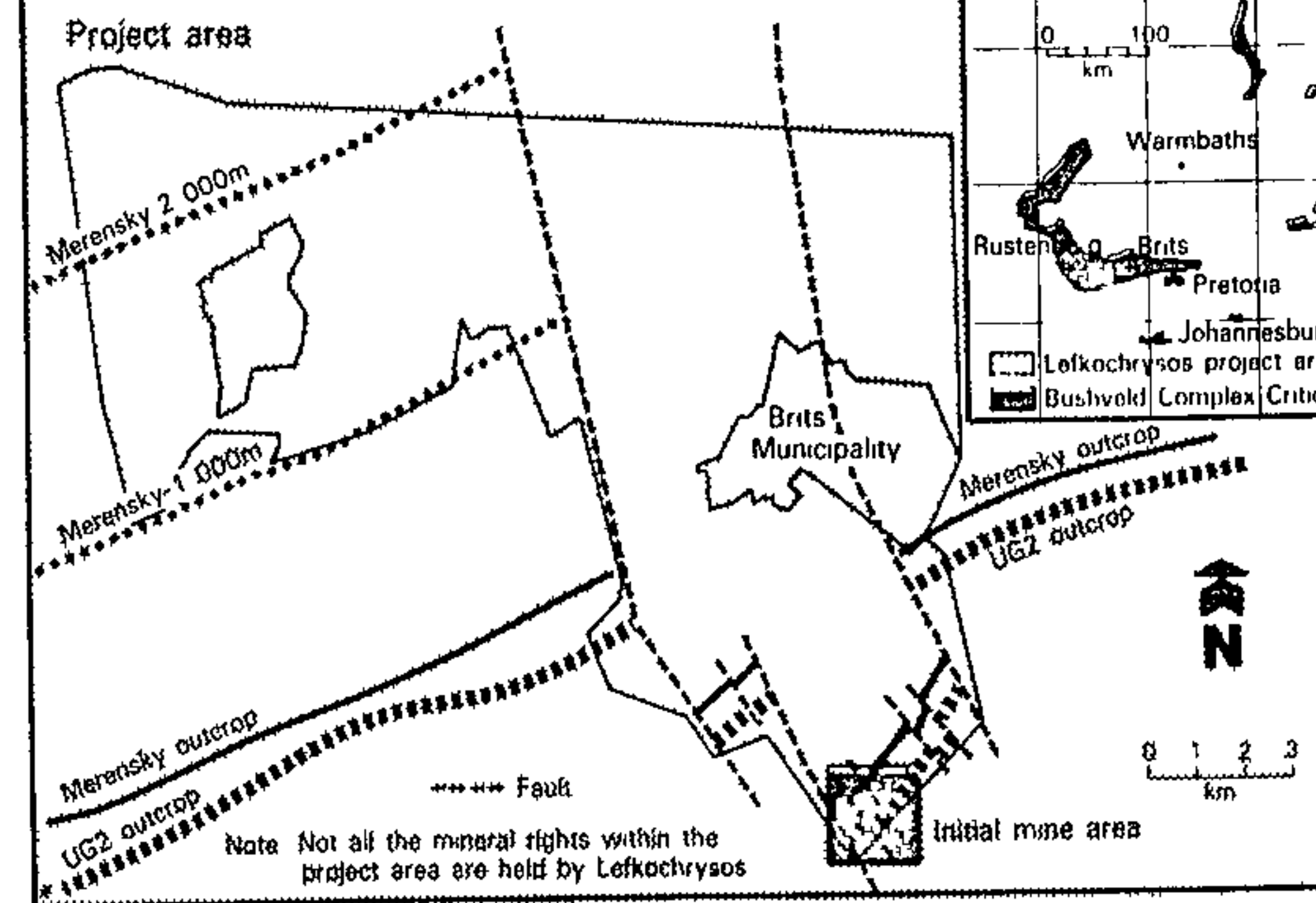

Pouroulis says he approached Alberts after his retirement from Mineral and Energy Affairs to offer him a board appointment. When Alberts accepted the position, he was given the right to subscribe for, and pay for, the same number of shares in the Lefko private placing as the company's other directors.

Pouroulis declines to specify how many shares each director has the right to buy.

On current indications, Lefko shares seem set for a welcome reception from investors when they are listed on the JSE. But poten-

tial investors should remember there is a risk factor involved in Lefko's development and should watch the rating accorded the shares compared with the established producers. The prospectus should be assessed and Mintek's conclusions on the metallurgical process should be watched particularly carefully, especially once results of pilot tests become available.

The other aspect to watch is the world platinum supply-demand equation. All going well, Northam and Lefko will add some 400 000 oz of platinum to world supply by the early Nineties.

Messina's proposed mine will add to that. A number of analysts believe platinum demand can cope with the higher production up to the mid-Nineties. After that the picture gets uncertain — and the platinum industry has had some very lean years in the past. If conditions turn tough, each producer's financial and marketing muscle — and cost structure — could be crucial.

Brendan Ryan

CME Times 27/7/87

217

# Rush into platinum raises spectre of glut

Own Correspondent

JOHANNESBURG — The rush of companies to announce new platinum mines and projects has raised the prospect of a platinum glut, with a fall in price, from the early 1990s

Apart from the new South African production, there will be increased output from mines outside SA and growing supplies of platinum from scrap recycling operations

Gordon Waddell, former chairman of Rustenburg Plats, warned in the past that the platinum industry is extremely cyclical and its history has shown that it moves from boom to bust — with great energy applied to increasing production in boom times and thousands of workers laid off in bad times.

Rusplats' announcement of a 59% growth in attributable earnings in the year to June came on the same day that Loucas Pouroulis gave details of his new Lefko (Lefkochrysos) platinum mine

Brian Gilbertson, MD of Rusplats, was asked whether there was likely to be over-production from the early 1990's

He replied "I hope that the word 'likely' will not turn out to be reality. If you take note of all the planned increased production from newcomers you look at only one side of the equation — the supply side

"There will, of course, be increased supply by the mid-nineties, but the tricky question is what the demand will be

"We see an increase in demand but the question is whether it will be substantial enough to absorb the increased supply

"Platinum is a small market and supply-demand imbalances can throw the price one way or another

"The fact that production is being increased without guaranteed additional demand must give rise to a risk that the market will be severely disturbed"

Gilbertson explained Rustenburg's position in the platinum market recently "We are unlikely to sit back passively losing market share to the newcomers

"Rustenburg has efficient, established mines, which are financially sound. We also have immediate access to relatively rich surface outcrops of Merensky ore

that can be extracted at a cost much lower than from a deep deposit"

GFSA's new Northam platinum producer will be a deep mine. With Lefko it will be the principal new producer in the next few years

Other new producers are possible

Northam will start production in 1992 and build up to an estimated output of 250 000 oz of platinum a year

Lefko in its first phase plans to mill 160 000 tpm which could produce about 160 000 oz of platinum a year. It will increase to mill about 360 000 tpm by 1994, producing about 360 000 oz a year

This production must be added to Rustenburg's estimated 1 350 000 oz of platinum this calendar year, Impala's probable 950 000 oz this year and Lonrho's Western Platinum's 165 000 oz a year now and planned 270 000 oz by 1992

If all goes according to plans so far announced, an additional 785 000 oz could be produced in SA between now and 1995 — a large quantity for the market to absorb.





Call tips 29/1/77 217  
12/18/72

# Platinum dominates markets, news

Finance Staff

JOHANNESBURG — Platinum came to the boil yesterday with a surge in JSE platinum-prospect shares, the announcement of a new platinum mine by Rusplats and Lebowa Development Corporation (LDC), and a \$24 rise in the London platinum price to \$598,50 an oz

Platinum-prospect shares rose up to nearly 20% with Vansa up 75c (17%) to 515c and Messina jumping 15,3% or 225c to a new high of R17

The price of platinum futures on the New York Metal Exchange jumped to a two months high with October delivery up \$8,10 to \$604,50 an oz

Rusplats yesterday signed an agreement with the LDC for the opening of a mine producing about 50 000oz of platinum a year where the small Atok mine is now operating

The mine will be established by a newly-formed company,

Lebowa Platinum Mines (LPM), in which citizens of Lebowa will be offered shares

The agreement gives LPM the right to develop a 100 000oz a year platinum producer at Maandagshoek, south of Atok. Brian Gilbertson, MD of Rusplats, speaking at the signing, said "This new company (LPM) has the potential to become for the Eastern Bushveld what Rusplats mines are to Rustenburg and the Western Bushveld"

Provided Maandagshoek is developed into a large mine, the two properties will within the foreseeable future be producing 150 000 oz of platinum a year and employing 4 000 men, following the investment of many millions of rands

For the first time a "homeland" will have a financial stake in a company operating platinum mines in its territory

Members of the Lebowa Cabinet, headed by the Minister of Economic Affairs, Nel-

son Ramodike, attended the signing

During the expansion at Atok, Rusplats will finalize its technical investigation of the PGM (platinum group metals) deposits at Maandagshoek

LPM has the option for three months from completion of the investigation to decide whether to establish a mining operation on Maandagshoek of not less than 50 000 tons of Merensky and UG2 ore a month

Provided the mining operation on Maandagshoek is expanded within a period of five years after its establishment to a throughput of not less than 100 000tpm, LPM will acquire the sole right to mine additional reserves of PGM on the farms Nooitverwacht and Hoepakraans in Lebowa

These farms cover an extensive area with large reserves of Merensky and UG2 reefs and could support a big platinum mine

The grades at LPM's Atok deposit and Maandagshoek are not disclosed but they are said to be higher than the average grade of 5,9 g/t to be mined by Loucas Pouroulis' Lefko mine, due to produce in 1990

The agreement between the LDC and Rusplats provides that 7,5% of the eventual issued share capital of LPM will be issued to LDC as consideration for its contribution to the joint venture

The LDC has a further right to buy 5% of the eventual issued share capital of LPM

LDC and Rusplats have undertaken to offer 15% of the eventual issued share capital to the citizens of Lebowa, each party providing 50% of the shares to be offered

□ These arrangements offer LDC and the Lebowa citizens the opportunity of acquiring 20% of the equity of LPM.



RUSPLATS/LEBOWA PLATINUM

# Expanding eastwards



MM 3/17/87  
217

The agreement signed this week between Lebowa Development Corporation (LDC) and Rustenburg Platinum (Rusplats) to jointly exploit reserves at Atok and Maandagshoek mines of platinum group metals

Indications are that Rusplats will lose no time in raising production in Lebowa. Certainly, with Loucas Pouroulis's Lefkochrysos scheduled to produce 160 000 oz of platinum annually by late 1990, and Western Plati-

num also planning a 105 000 oz expansion during 1991, Rusplats' timing of its Lebowan developments is significant

With a listing scheduled, the announcement has been accompanied by a degree of disclosure of key information which is unusual for Rusplats. If Lebowa Plats eventually produces 150 000 oz, its effect on total industry production of platinum will be relatively small. Excluding potential producers such as Messina and Vansa, total production in 1990 is estimated at about 2,7M oz, which perhaps adds some perspective to the announcement. But the timing indicates that Rusplats is not willing to sit idly by and let outsiders capture its market share. The move is perhaps ominous for them, as Lebowa Plats will not only have established connections but a significant cash pile to fund its growth. Moreover, Gilbertson says reserves are huge. "You don't have to worry about them," he states.

What remains to be established are the terms of the listing, which should make interesting reading when more details are released in about a month.

Dave Edwards

## JCI's new platinum projects

Locality of Atok and Maandagshoek

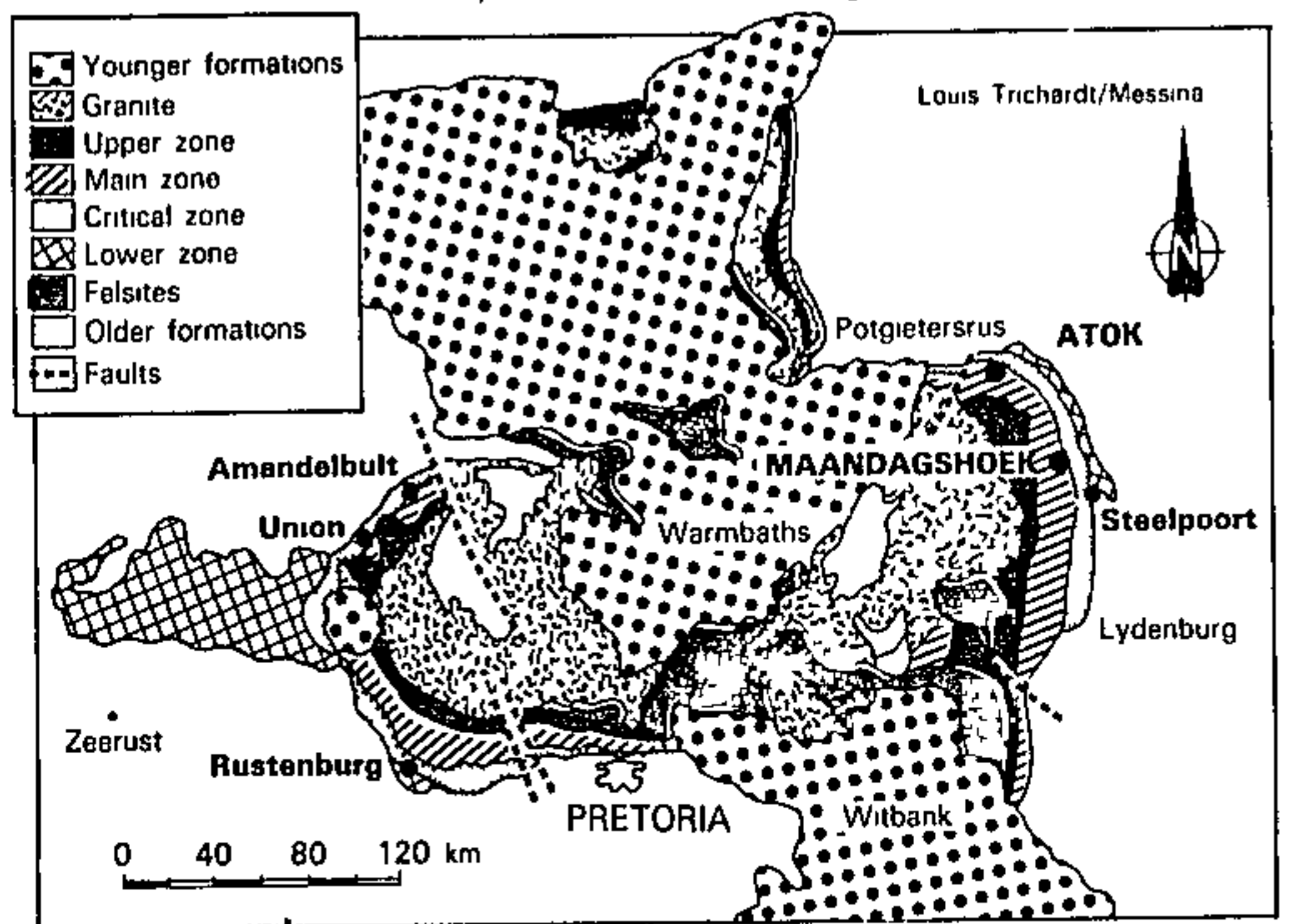

(PGMs) represents a change from past royalty-linked agreements. It also indicates a determination to benefit from an expected increase in demand in the Nineties.

The announcement of an expansion for Rusplats came in the same week that Rusplats published record results. In the year to end-June — the fourth year of dramatic profit growth since profits crashed in 1982 — Rusplats' EPS jumped by 58,6%, from 185,2c to 293,8c. The dividend was lifted by 48% to 200c.

In terms of the agreement, the LDC will get 7,5% of the issued share capital of Atok mine as recognition of its past contribution. Atok will be listed later this year under the new name of Lebowa Platinum Mines (Lebowa Plats). LDC will also have the right to purchase 5% of the eventual issued share capital. LDC and Rusplats have undertaken to offer 15% of the eventual issued share capital to the citizens of Lebowa, each party contributing 50% of the shares to be offered.

These arrangements offer the LDC and Lebowa citizens the opportunity to acquire 20% of the equity of Lebowa Plats. Rustenburg MD Brian Gilbertson denies that pressure from the Lebowan government precipitated the agreement. "We have an existing agreement with the LDC in respect of Maandagshoek," he says. "This agreement means we have an even better deal."

double to 50 000 t/month within two years. Gilbertson says funding will come partly from cash flow and expects the target production to be reached before the specified period. During this phase Rusplats will finalise technical evaluation at Maandagshoek, some 50 km to the south, where mining has started on a small scale.

Rusplats has a three month option from completion of investigation to establish a mining operation of not less than 50 000 t/month. Funding will again come partly from Atok cash flow. Provided this operation is expanded to throughput of at least 100 000 t/month, Lebowa Plats will acquire sole right to mine additional reserves of PGM at Nooitverwacht and Hoepakrantz, adjoining Maandagshoek. The combined operations could, therefore, be producing some 150 000 t/month of ore before Lefkochrysos reaches full production.

As both Atok, which mines Merensky, and Maandagshoek, which mines UG2, are surface operations, costs can be expected to be low. This should enable reasonable profits at a lowish grade. Gilbertson expects platinum production to eventually reach some 150 000 oz/year — which could be construed to represent a platinum grade of about 2,5 g/t extracted. After processing, the combined production will be treated at Rustenburg's new Lebowa refinery which has al-

## VENTURES

217 mgw 6/8/87

# Lefko platinum mine likely to tickle investors' fancy

From TEIGUE PAYNE

JOHANNESBURG — The Lefkochrysos platinum mine near Brits is likely to become an investor's favourite as soon as doubts about its ability to process its UG2 ore, one of a number of unique features of the mine, are cleared up

Any platinum mine is complex for ordinary investors to understand, but in Lefko's case, the difficulty is exacerbated because of its unique features

The first major innovation is the method of mining the southern arm of the lease area using addits and trackless, mechanised mining methods. But this is a relatively simple innovation which apparently has low and high advantage

The biggest innovation, holding the greatest potential risk for investors, relates to the fact that Lefko is the first South African platinum mine which envisages production of platinum group metals exclusively from UG2 reef

Throughout Lefko's lease

area, drilling has shown that values on the UG2 reef are more consistent and reliable than Merensky reef, which overlies it and is not as well developed here as in other areas. Lefko's plans and prospectus promises are thus based exclusively on UG2 reef.

UG2 has never been exclusively used before because of metallurgical problems in its extraction

There are two main aspects to the metallurgical problems Lefko, which has recruited some of the technical leaders in the industry, and is using top consultants, believes that these problems have been overblown and that extraction will take place without major problems

Ore from the mine will be subjected to primary crushing, then to a heavy media separation plant. It will then be crushed finer before being fed into the flotation plant

The first aspect of the metallurgical problems is that chrome iron oxide in the con-

centrate, which is the product of the flotation plant, has to have a content of 2,8 percent or less to be acceptable to the smelter. If the content is higher, smelter temperatures must be much higher

The concentrate will be continually sampled. If it rises above 2,8 percent, it will be returned to the flotation plant to bring the chrome content down

Lefko officials say neighbouring Western Platinum Mines, in its process, reduces its chrome content from UG2 to 2,8 percent or below in its concentrator — showing that it can be done.

Lefko is currently mining another 500 tons of UG2 ore for testing by Mintek on pilot plant scale in batches of 50 tons, and Lefko officials are very confident of the result

Of course, commercial production can throw up problems not indicated in a pilot plant. Opinions differ, but most analysts believe Mr Loucas Pour-

oulis, chairman of Lefko, is the best man for the job and they seem confident that Lefko will solve any metallurgical problems which do arise

For investors, Lefko is an attractive prospect provided metallurgical problems do not occur. If they do, the effect on cash flow could be very damaging

For this reason, it seems likely that after the listing on September 1 the share price will trade above the issue price of R13, but below its potential based on net present values (NPVs) at the low-risk discount rate which would otherwise be suitable

According to analyst Kevin Kartun of brokers Simpson McKie, on a low-risk discount rate of 3 percent, Lefko's NPV should be R29,24. On a moderate-risk rate of 5 percent, it should be R20,89, and on a higher rate of 7 percent, it should be R15,06



The mining industry is astir with rumour and controversy following a shift in government policy on mining rights. The major effect so far has been to strip JCI's Rustenburg Platinum Mines (Rusplats) of major prospecting leases in the Brits area, and the transfer of these rights to Loucas Pouroulis's new Lefkochrysos mine

**Finance Editor GERALD PROSALENDIS reports**

# How Pouroulis took valuable mining rights away from JCI

*B/Day 7/8/87 217*

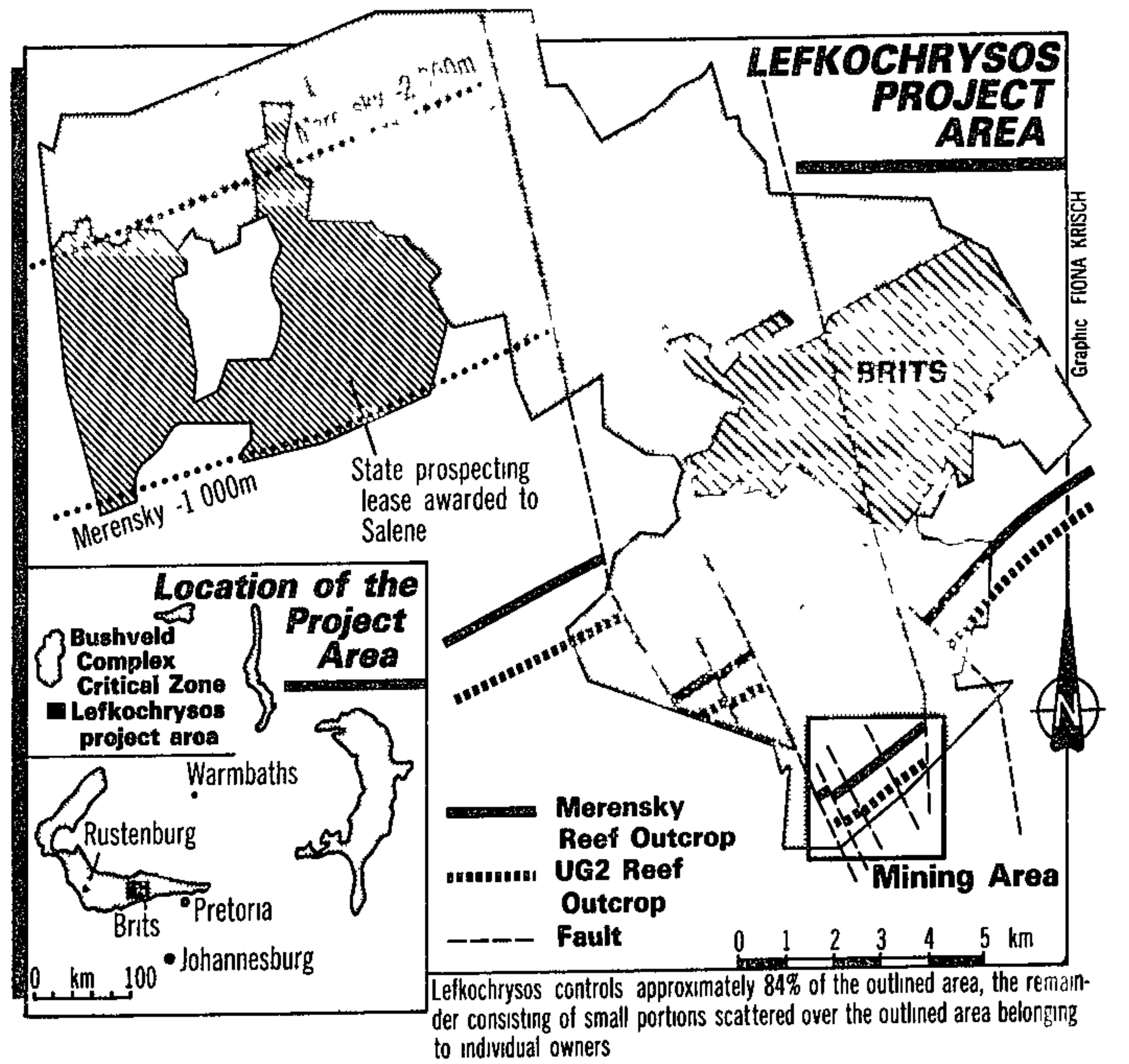

**T**HE OPENING of the Lefko platinum mine earlier this month marks a new direction in South African mining development. It is the culmination of a four-year effort to acquire mineral rights from nearly 500 owners and to wrest a portion of the prospecting lease from the hands of JCI's Rustenburg Platinum Mines.

In 1984, JCI bought from Texas Gulf the prospecting leases for what was known as the Pandora platinum project, near the Transvaal town of Brits, together with other assets. The price for the lot was R6.8m.

Lawrence Blomkamp, director of Dallad Mining Company, put together the package of more than 500 individual contracts involving more than 1 000 plots of land.

"One of our companies, Ypsilon Mining, did the mineral rights for Texas Gulf," he said last week. "The intention was that they would be mining by 1981. They decided after 1983 they would leave the country. While we worked with them, we acquired the rights on certain State ground, prospecting contracts on ordinary private land and the prospecting leases that are the subject of debate.

"In terms of Ypsilon's agreement with Pandora, Texas Gulf had to have our consent to cede their rights to a third party, which was JCI. I objected, because I believed JCI were in the business of acquiring rights to keep for their own purposes. I also believed they would not exploit this mine.

"Eventually, Texas Gulf ceded all its mineral rights out of Pandora to JCI. I knew this lease was renewable every two years. Pandora had apparently done enough

work on the land to justify to the Minister of Mineral and Energy Affairs that they did not have to do any more work.

"It would have been hard to take that lease away from them because they owned only this project. Consequently the lease was renewed upon application.

"In 1984, JCI got the Minister's consent to cede the lease to themselves. The lease expired yet again at the end of April last year, and JCI tendered its application for renewal of the lease, fully expecting it to be granted automatically. SA is one of the few countries in the world where you can obtain prospecting rights and then sit on them indefinitely," says Blomkamp.

**H**owever, applications for the prospecting lease were received from two further mining companies, Salene and Gencor.

Says Blomkamp: "There was no one who knew about this lease besides Pandora and JCI. We saw the potential there.

"I approached our attorneys and asked what chance I would have if I contested the automatic renewal of the lease. They told me it had never been done before. I then approached Pouroulis and decided it was worth putting in an application for that ground. We had enough information, we thought, to convince the Minister that JCI were not going to use the ground.

"We approached senior counsel and asked his opinion on matters relating to the lease."

In an opinion prepared for Salene Mining Company, Ezra L Goldstein SC, now Mr Justice Goldstein, put forward the view

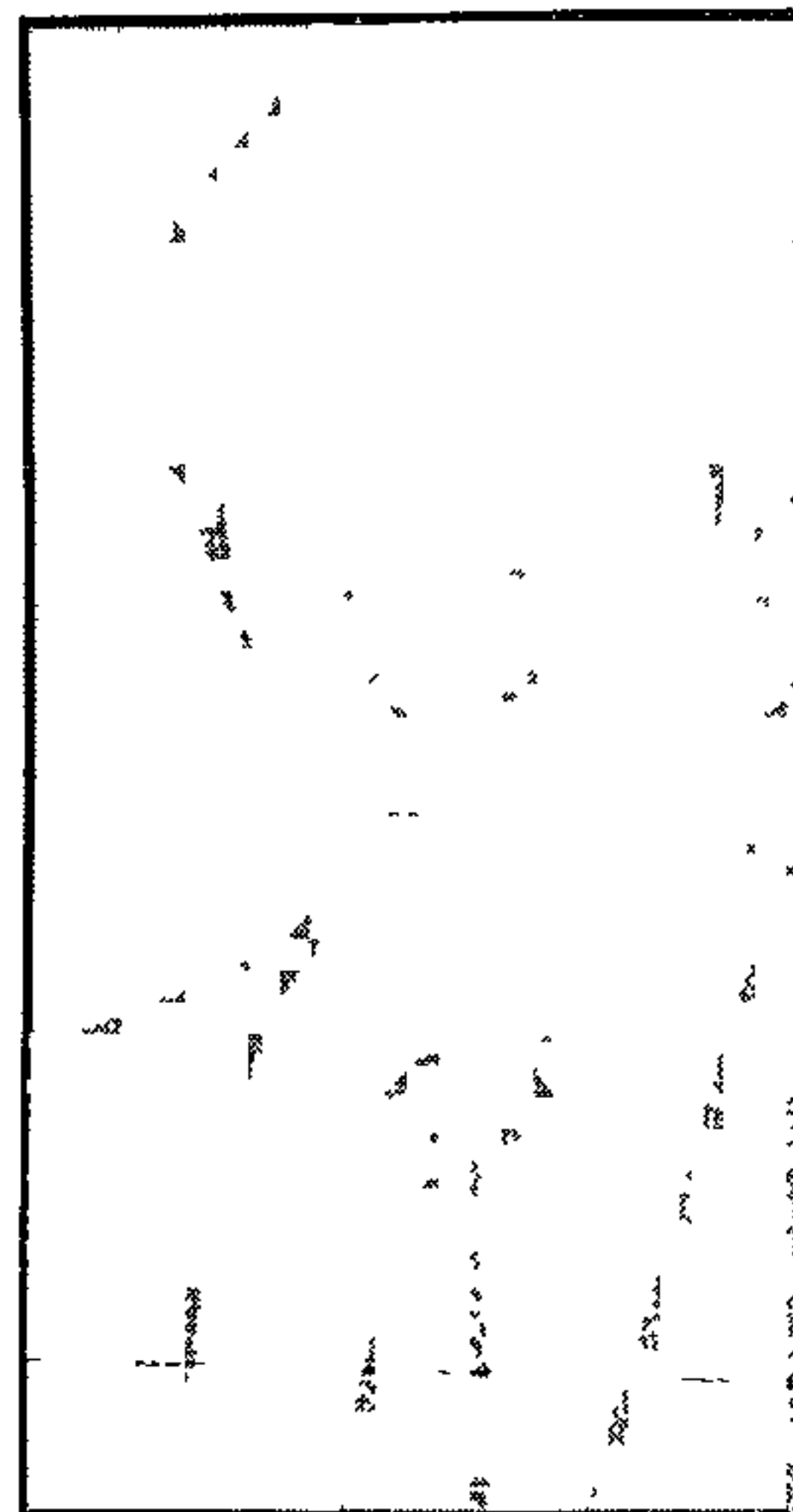

□ LOUCAS POUROULIS

that "if the Minister should decide to grant RPM (Rusplats) a prospecting lease over the whole area of land and if in fact he proceeds to grant them such lease he will be acting unlawfully, since he will be exceeding the powers granted to him ..."

"If this occurs, Consultant (Salene) will have the right to apply to court to set aside the Minister's decision and will also be entitled to apply to set aside the lease granted to RPM."

Goldstein's opinion focused on Section 13(1) of the Mining Rights Act No 20 of 1967, which directs the Minister to satisfy himself that a prospective lessee has "financial resources ... adequate for proper prospecting under such a

lease or that the arrangements by which he proposes to obtain capital for the purpose are satisfactory ..."

"Obviously, the purpose of the direction is to ensure that the prospective prospector can prospect and thus that he may be expected to do so," said Goldstein.

"It follows that it is an implicit requirement of the section that the prospector intends prospecting and that the Minister must be satisfied that he will use his resources or capital for such purpose.

"Section 25(3) forbids the grant of a mining lease unless the Minister is satisfied that there are reasonable grounds for believing that there are workable quantities of metals or minerals in question; that the scheme according to which the prospective lessee proposes to carry on the mining is satisfactory, that the prospective lessee's financial resources are adequate for proper mining.

**I**n my view, it would be senseless to lay down these requirements in respect of a prospective lessee who had no intention of mining within the foreseeable future. Thus the section clearly implies that the Minister must be satisfied that mining will in fact start within a reasonable time after commencement of the mining lease and will endure for the duration thereof," said Goldstein.

Blomkamp added "We had gone to see the Competition Board prior to last year's April 16 meeting about what we were trying to achieve, and they felt fairly strongly that in terms of the Act we had a case.

"By April '86 we had submitted our application," he said. "The lease came up for renewal at the end of April. JCI and Gencor had also applied for the lease.

"We motivated why JCI should not be granted the lease. Gencor, meanwhile, had submitted a standard short application.

"After consultation with the Mining Commissioner we decided it would be hard for the Minister to deprive JCI of the shallow area. We felt our chances would have been jeopardised by including this in our lease application. We resubmitted our application on April 16 just applying for the deeper ground to make life easier for the Minister.

"The eventual outcome was that we would get everything from minus 1 000m Merensky contour line and north. We did not mess up JCI's possible mining operations south of the line.

"I went to see the Minister in Cape Town in April last year, with our attorney, to explain why we were doing what we were. After not hearing from the Minister we took senior counsel's opinion to show that he could in fact do what we were proposing, and that if he did not we felt we would have a strong case if the matter landed up in court.

"We wanted to show government that we felt strongly that he was obliged to promote mining and not to renew leases knowing there would be no development of the ground. We then had another meeting with the Minister, when we presented him with Goldstein's opinion in October." Soon afterwards, the decision was made — in favour of Pouroulis, and against Rusplats and Gencor.



# JCI, RPM and a fait accompli

**G**OVERNMENT'S refusal last year to renew Rustenburg Platinum Mines' prospecting rights on State-owned land near Brits took the company's executives — and the executives of parent company JCI — by surprise.

A reconstruction of events surrounding the decision suggests that the surprise was perhaps intentional — that the controversial decision was intended as a warning to the major mining houses to stop "sterilising" valuable mining rights and to speed up the development of known ore reserves.

Says an Mineral and Energy Affairs official "There has been a rethink on the granting of prospecting leases over the last five years. It was something that developed over time and as certain minerals have grown in importance. The imposition of sanctions also made it important to reevaluate our policy.

"Over the years mining houses have taken options on large tracts of land for which they had to pay. But in this particular case we were dealing with a prospecting lease on State land which carried a low rental

**Q**ue of the arguments advanced against renewing the lease was that it was not fair or reasonable to sterilise mining rights on State land."

According to the same official, government thinks it may be even more important to prevent "sterilisation" of privately-owned land, but he adds, "In this regard, the Lefko decision is not entirely applicable."

That may be true. The precedent established with the transfer of prospecting rights to Lefko has no direct legal application to privately-owned land or land over which mining houses hold options. However, some do believe the move was intended as a warning to mining houses to exploit potential mineral deposits held by themselves.

It was at a crucial meeting in Pretoria on October 28 that Louw Alberts, then Director General of

Mineral and Energy Affairs, together with the Government Mining Engineer G P Badenhorst and legal administrator Willem Voigt, informed Rusplats of government's decision not to renew the prospecting lease for certain of the platinum deposits near Brits.

Says an official: "Alberts indicated he was not happy about the renewal of the lease over the entire area in favour of JCI. He argued against the sterilisation of platinum deposits, which would be to the detriment of the country. The decision was taken with the knowledge that JCI had not conducted much prospecting while it held the lease."

**LOUW ALBERTS**, former Director-General of Mineral and Energy Affairs, has now retired and become a director of Lefkoehyos, the company which won the battle against Rusplats and Gencor for the prospecting lease near Brits.

Alberts was offered a directorship in the mine late in April this year, at least eight months after the decision to switch the prospecting lease to Lefko was made. He signalled his intention to accept the offer in June, and joined the board from August 1. He retired at the end of June.

Says Lefko's chairman Loucas Pouroulis: "I heard in April that Alberts was retiring. Because of his background as a former President of the Council for Mineral Technology (Mintek), where a lot of research in the extraction of platinum has been done, I thought of approaching him after his retirement to join the board of Lefko.

"The first discussion was at the end of April, when he came to visit the mine. After asking him he said he would have to think about it. He later said he would join the board at the beginning of July, when he retired. I said to him that was too close to his retirement and he should join on August 1. He agreed.

"I then asked him if he was aware that each director was entitled to participate in the private

Says Rustplats's Brian Gilbertson: "We knew there was a problem developing with these rights. A proposal had been put to our consulting engineer and mineral rights department that there would be a split of the area at the 1 000m contour line."

Says JCI's legal adviser Jock Lessing "We heard government were going to take half of the area away from us. Gordon Waddell, then chairman of JCI, got off his chair and went to Pretoria, together with Gilbertson and consulting engineer Bruce Sutherland, to object vehemently.

Says Gilbertson: "At the meeting, which took place at our re-

quest and was chaired by Alberts, Badenhorst spoke to correct a previous statement by his department which had implied that RPM would have no problem conceding the prospecting leases of the deeper ground.

"We wanted the GME to acknowledge at this meeting that JCI was not happy with these prospecting rights being taken away from us."

Government officials give a different version. Says a Mineral and Energy Affairs official "Alberts was closely involved with the application for renewal by JCI. As a result of a meeting, at which Waddell was present, it was decided that the prospecting lease for only

rector of the mine. A share certificate was made out in his name. The particular share certificate was not sent to Alberts, but to these offices.

"Towards the end of the financial year the auditors wished to sort out any outstanding amounts for shares. We instructed the transfer secretary to take Alberts's name off the register and the shares were taken up and paid for by someone else. This was because Alberts had not paid for them, nor had he taken possession of them. However, his offer to avail himself of shares is still valid."

Alberts said last week: "I did not know the number of shares I had been allocated until two nights ago (Monday, July 27). I merely knew that shares were being allocated to the board. I have not yet taken delivery of the shares."

Alberts said he had decided at the time of the announcement of his retirement to accept positions on two or three boards.

"I have also joined the board of a construction company. I accepted Pouroulis's invitation because it was an attractive project technologically. When I was at Mintek, we broke the back of the UG2 platinum seam, and here was a mine that would operate on that process."

a portion of RPM's land would be renewed Waddell agreed to the division of the land into two. We have had nothing subsequent to these meetings to indicate JCI were not happy with the division."

However, says Lessing "We objected vigorously to Alberts's statement that government were entitled to do what they intended. We had lost half our prospecting area."

Says Alberts. "I certainly chaired the meeting at which Waddell and his team came to see me. By that time the decision had been made. The Minister of Mineral and Energy Affairs and myself had sat down and rethought the effective sterilisation of land. The issue is still under review.

"But this will have to be done in great depth because the mining industry is powerful and inextricably woven into this economy."

**W**e were aware the decision was a controversial one and it was carefully examined by a group from the GME's office and experts from the legal division in the department. We came to the conclusion there was no way you could refuse Pouroulis's application. He was within the constraints of what the law entitled him.

"A few weeks later a group from JCI, including Waddell, came to see me privately to see if the decision could be reversed. I said there was no way it could be done morally or legally. I suspect that if we had refused Pouroulis's application he could have taken us to court."

Says an official: "JCI said at the meeting they were unhappy, but said if division was insisted upon they would accept division at the 1 000m contour line. The document was signed believing that, although JCI were not happy, they were not unduly unhappy about the decision."

But, says Waddell: "When faced with a fait accompli — Alberts said he had already made his decision — we opted for the more shallow land rather than deeper mines."

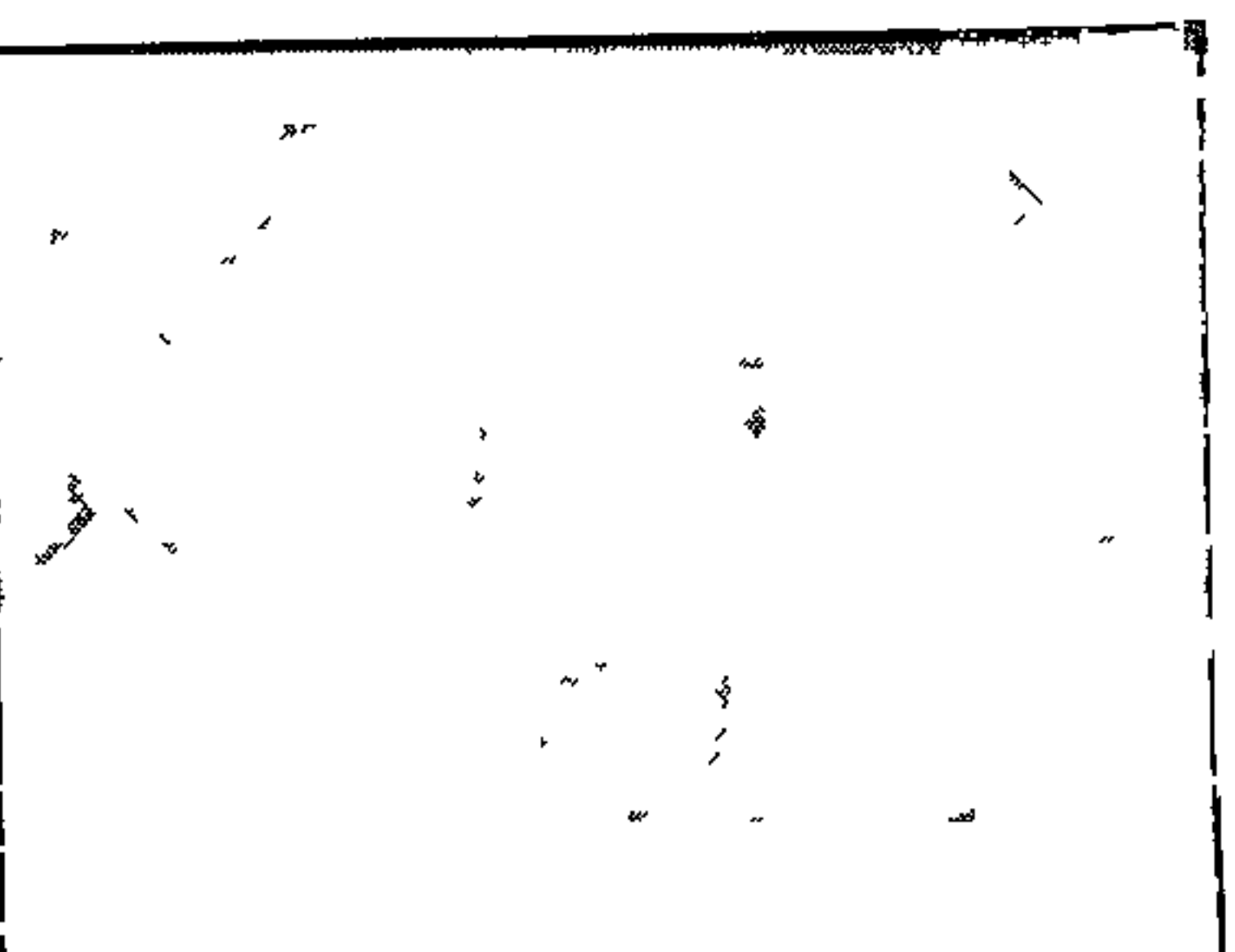

□ ALBERTS . . . "attractive project"

placing of shares. We allocated some shares, for which he has as not yet paid or taken possession of."

On June 5, 10 000 shares were, according to the share certificate listing for Lefko dated June 8, allocated to Alberts. However, a subsequent list of Lefko share accounts, dated July 30, does not include his name.

Says Lefko MD Richard Johnson: "Alberts was aware that he would be allocated shares as a di-



Platinum rights go to Lefko

# Controversy as govt strips JCI of leases

1/18/87  
B. Lefko  
217

A SHIFT in government policy on mining rights, which stripped JCI's Rustenburg Platinum Mines (Rusplats) of valuable prospecting leases near Brits, has caused controversy in mining circles.

The policy shift is apparently aimed at speeding up mining development and the transfer of Rusplat's rights to Lefko. Lefkos opened the way for the expansion of Loucas Pouroulis's new platinum mine. However, the decision to strip Rusplats of leases which had previously been renewed more or less routinely every

● How the leases changed hands: the full background story: See Page 8.

two years was described by former JCI chairman Gordon Waddell as "neither fair nor equitable".

Rusplats MD Brian Gilbertson said the policy shift was "appalling". In a meeting of prospecting rights, granted to Rusplats in terms of Section 13 of the Mining Rights Act, is seen as a strong signal to mining houses not to hoard mineral rights or attempt to "sterilise" large areas of mineral deposits.

A lease was awarded to Loucas Pouroulis's Salene Mining, Lefko's holding company, opening the way for the future

GERALD PROSALENDIS  
Financial Editor

expansion of his new Lefko-chrysos platinum mine

The controversial decision to award a portion of the lease to Salene Mining, taken in October last year, was the first time in SA mining history that a major mining house had been stripped of its rights in this fashion.

With this decision, one of the basic principles of SA thinking on mineral rights has been overturned, said an academic.

The Lefko decision, coming after government's earlier refusals to automatically renew coal prospecting leases in the Waterberg area and oil prospecting leases in favour of Soekor, represents the culmination of a new government policy which has been developed over five years.

Says former Mineral and Energy Affairs director-general Louw Alberts, the man who chaired the meeting at which JCI was informed of government's decision: "The Lefko decision created a precedent and was done within the framework of existing laws and regulations. It could also trigger future actions. Pouroulis made a breach in the practice of

● To Page 2



# Govt strips JCI of leases

government automatically renewing prospecting leases

"The thought had occurred to government that people could sterilise large tracts of land

"SA holds the platinum market in its hands. There are two issues involved here, however. While government is sensitive to the fact that there should not be overproduction of platinum, it is equally sensitive that as the market and demand grow there must be room for newcomers to take up the growth.

"There is a concern that entrepreneurs could be locked out and land sterilised permanently."

But Waddell said in an interview this week "We paid Texas Gulf for their mineral rights on the assumption that the lease would be renewed. There had been no government objection to Texas Gulf holding the land for a number of years. When we were told that some parts would be taken away, we did not think this fair or equitable.

"We were given no satisfactory explanation for a departure from the practice that had been followed in the past with regard to Texas Gulf.

"In fact, an inference was made that JPM owned too many mineral rights for

From Page 1

platinum". JCI's concern is that the platinum market is delicately balanced and sensitive to volatile supply and demand. Also, said Gilbertson "There are many areas underlain by platinum ore that are held under Section 13."

It was in 1984 that Rusplats concluded a R6,8m package deal with US-based Texas Gulf to purchase the Pandora platinum project, which included the Section 13 leases, some 99-year leases and outright ownership of tracts of land, plant and equipment, borehole cores and exploration results.

Gilbertson said "We made it clear to government we did not want to lose what we had paid for from Pandora. We knew there was an expiry date and reasonably expected that the entire prospecting lease would be renewed in our favour. We were confident that this lease could not be taken away from us."

Alberts has been appointed a director of Lefko from August 1 and, as such, is entitled to 10 000 shares at a price of R5. The shares are currently being offered at R13.

217



# Vansa, Rand Mines join forces in R527m platinum mine

217 B Day 11/8/87

**RHODIUM Reefs, the Vansa/Rand Mines platinum joint venture has been given the green light and a first-phase R527m mine and metallurgical plant has been planned.**

A JSE listing for the new platinum producer is planned "towards the end of the year", according to Rand Mines gold division chairman Clive Knobbs. The platinum group metals (PGM) deposit underlies Vansa's Kennedy's Vale and adjacent properties on the eastern lobe of the Bushveld Igneous Complex (BIC), in the Steelport valley, north of Lydenburg. The UG2 seam extends from 700m to

**PETER STACEY**  
Mining Editor

1 400m below surface and reserves total 84-million tons at an average in situ grade of 5.3g/t. Grades for the Merensky Reef average about 3g/t and are not at present an attractive mining proposition. Rhodium Reefs will have a phase-one labour force of 5 000 and a 35-year life. Development is to begin almost immediately.

Contrary to the pessimistic prophecies of a future platinum glut recently made by major producer JCI (who shortly thereafter announced an increase in

their own output), Rand Mines predicts a strong market, and indeed a greater market shortfall in 1992, when the new mine is on stream.

As with Loucas Pourouli's Lefkoehrysos mine, the target is the UG2 Reef, the deeper of the two platinum-bearing horizons of the BIC. In the past, with the exception of Lonhro's Western Platinum Mines, which blends Merensky Reef and UG2, the more metallurgically complex UG2 ore has been largely neglected.

Rand Mines is confident of successfully treating the UG2 Reef and rates the metallurgical process as "low risk" and the projected 82.5% plant extraction effi-

ciency is considered conservative.

Full production of the first phase is 150 000oz of PGM's, scheduled for 1992. According to Rand Mines project leader, Gerry Emere, this is a modest 5% of SA's market. "We don't want to tackle JCI head-on," he said.

A second phase, planned for the year 2001, will boost output by 50% and lift capital expenditure — in current money terms — to R838m.

The joint project, was initiated in September last year, after Vansa had drilled

● To Page 2 ➔

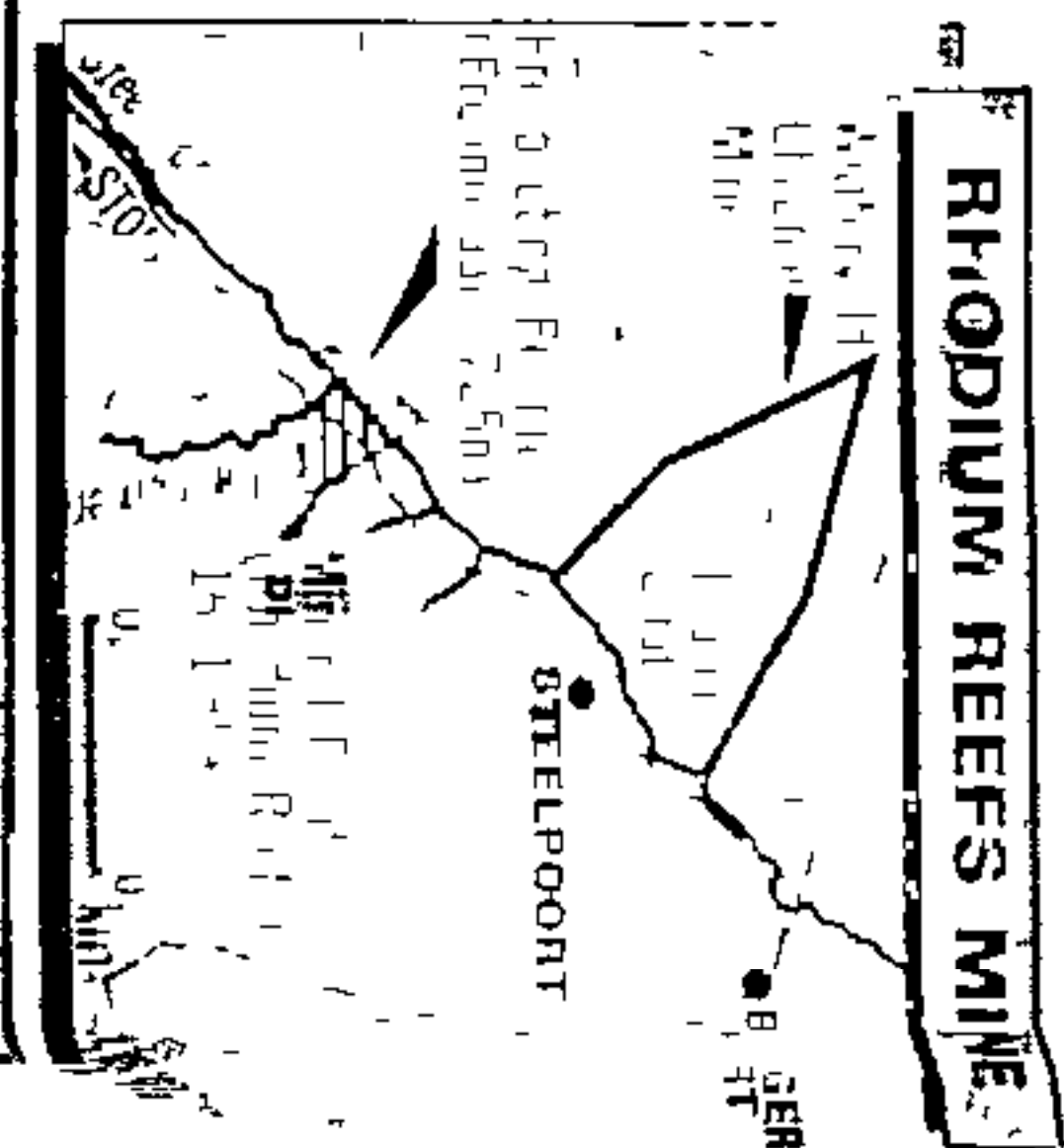

## Vansa-Rand Mines joint platinum venture

six exploration boreholes on the property. Rand Mines has drilled a further six holes and carried out an exhaustive metallurgical testing programme and feasibility study.

Rand Mines will fund an additional R52m of development and in terms of their agreement with Vansa, increase their stake in Rhodium Reefs to 60%. This, coupled with their Vansa holding, gives the group a 77% effective holding in the mine.

In situ grade, for the three major PGMs (platinum, palladium and rhodi-

um) as well as gold, averages 5.3g/t. The total area, straddling the Steelport valley, over which mining rights or options are held, is 2 400ha, and includes the vanadium-bearing magnetite deposit already being developed by Vansa.

A recovery rate of 69.5%, including waste dilution and other underground losses, as well as extraction plant efficiency, gives an overall recovery grade of 3.68g/t for the main PGMs and gold. Addition of the balance of the PGMs enhances this figure by about 15%.

217 B Day 11/8/87



STANBIC

## Sell out terms

Standard and Chartered's (Stancha) sale of its Standard Bank Investment Corporation (Stanbic) shares has been completed, in a complicated deal, which must leave minority shareholders wondering how to react. Individuals should take the shares, not the cash offer

After completion of the deal, the new major shareholdings will consist of Liberty (30%); Old Mutual (20%); Gold Fields

109

217

1400-514

(10%), Rembrandt (10%), and Standard Bank Pension Fund (5%) The remaining 25% will be held by the general public and executives Apart from the Standard Pension Fund, all of these already hold significant stakes, so are simply receiving additional shares

According to the announcement, Stancha is forfeiting 22% of its shareholding and selling the balance for R18,75 a share Included in the price is a special dividend of R4,125 a share It thus receives a total of R715,9m in two forms R558,4m in finrands, being payment for the sale of the shares, and R157,5m in commercial rands, which is the special dividend As Stancha is a company, this dividend is not taxable in its hands

The shares Stancha forfeits are being placed in a rights offer, firstly with the new major shareholders, up to their final shareholding, with the remaining shares offered to other shareholders in a ratio of 15 for 100 at R18,75 a share All ordinary and preferred ordinary shareholders may either accept the offer of these shares, or they may elect to take the special dividend If they take the dividend, they also have to forfeit 22% of their shareholding in favour of the institutions holding the major stakes.

At the current price of R21,50, if a shareholder owns 100 shares, these are worth R2 150 if he keeps the shares. If he takes the dividend, he would end up with R413 cash (less tax for individuals) and shares worth R1 677, a total of R2 090 Standard Merchant Bank's Mark Barnes says that, based on the transaction price of R18,75, there is no difference between the two options, ignoring the tax effect However, it is clear from the figures that, when the market price stands above R18,75, the best option is to take the shares And the individual cannot ignore the tax effect

If Stancha is the only shareholder to take the special dividend, it will still cost Stanbic R157m However, Stanbic will recoup this amount by selling to the institutions the shares forfeited by Stancha. Stanbic MD Conrad Strauss says there will be no change in shareholders' funds.

Reserves will be reduced by payment of the dividend. Sale of the forfeited shares, which should total exactly the same amount as the dividend, will in turn increase the share premium. However, reserves are a bank's buffer, built up (in Stanbic's case) by a high dividend cover over a number of years, which the share premium is not. Barnes points out that total shareholders' funds and the number of shares on issue do not change

The real price Stancha is receiving for its shares is R21,34 If all the funds had been sent through the finrand market and there had been no special dividend, Stancha would have had to receive this price for its shareholding to buy the same amount of pounds sterling

No special dispensations were needed for the deal. Legally and in terms of exchange control, a company can declare as a dividend and remit out of the country, earnings re-

tained since January 1 1984 Many other disinvesting companies have taken this route in the past and others must be planning to do so. Disinvesting companies are not just pulling out — they are taking their earnings of the past two and a half years with them

Pat Kenney



RAND MINES/VANSA/RHODIUM

# Major breakthrough

New precious metal mining ventures announced this month by Rand Mines (Randmin) offer grounds for the stock market to take a more favourable view of the share. Unlike recent expansions to the gold operations, this week's announcement of a go-ahead for Rhodium Reefs platinum mine represents a major — and badly needed — breakthrough in efforts to diversify in precious metals. But more breakthroughs are needed before the share will catch up with other mining houses. Randmin's share rose to R106,50 ahead of Monday's Rhodium announcement and gained 350c on Tuesday, to yield about 4% on dividend against the sector's 2,1%.

News of the R530m Rhodium mine comes only a week after the house said it is to develop the R94m Barbrook gold mine in the eastern Transvaal in a joint venture with Anglo American. But, with 50% of 1986 group earnings derived from coal, the house cannot afford to ease back on new developments — nor is it likely to. Management is working on plans for what looks almost certain to be a large expansion at the old Durban Deep gold mine, held 20% by Randmin.

A feasibility study on the exploitation of Kimberley reef in the south west of Durban Deep's lease area was completed months ago, but the financing package will be critical. In the area concerned, the Kimberley reef goes to considerable depth, well below 1 000 m. There is potential for a large capital programme, and some analysts' cost estimates have run as high as R500m. However, with the mine making losses after capex, the investment will probably be smaller, perhaps around R250m, with operations focused on shallower areas.

Still, provided that funding can be arranged (presumably involving a rights issue), and that expected recovery grades justify the investment, the expansion could substantially lift production and lengthen the life of the mine. Indications are that an announcement on Durban Deep could come within weeks. Currently at R52, the share has been another weak performer this year. It should benefit from a positive decision, although much would depend on details of the funding.

Rhodium, a Randmin/Vansa joint venture at Kennedy's Vale near Steelpoort in the eastern Transvaal, was announced with a considerable show of confidence and an impressive degree of disclosure. One worry is that it is the fifth new platinum venture or expansion announced recently. Others are: GFSA's Northam, with pre-production capex of R559m and start-up in 1991; Loucas Pouroulis's R253m Lefkochrysos, with start-up in 1989; Lonrho's Wesplats is doubling

production; and a fortnight ago Rusplats announced expansion at Atok and Maandagshoek mines in Lebowa.

Northam (according to a Johnson-Matthey estimate) could produce an annual 350 000 oz of platinum group metals (PGM) by 1994 including up to 200 000 oz of platinum, Wesplats is adding about 250 000 oz of PGM. Lefko could produce about 160 000 oz of platinum by late 1990, and Lebowa Platinum Mines could reach 150 000 oz a year of

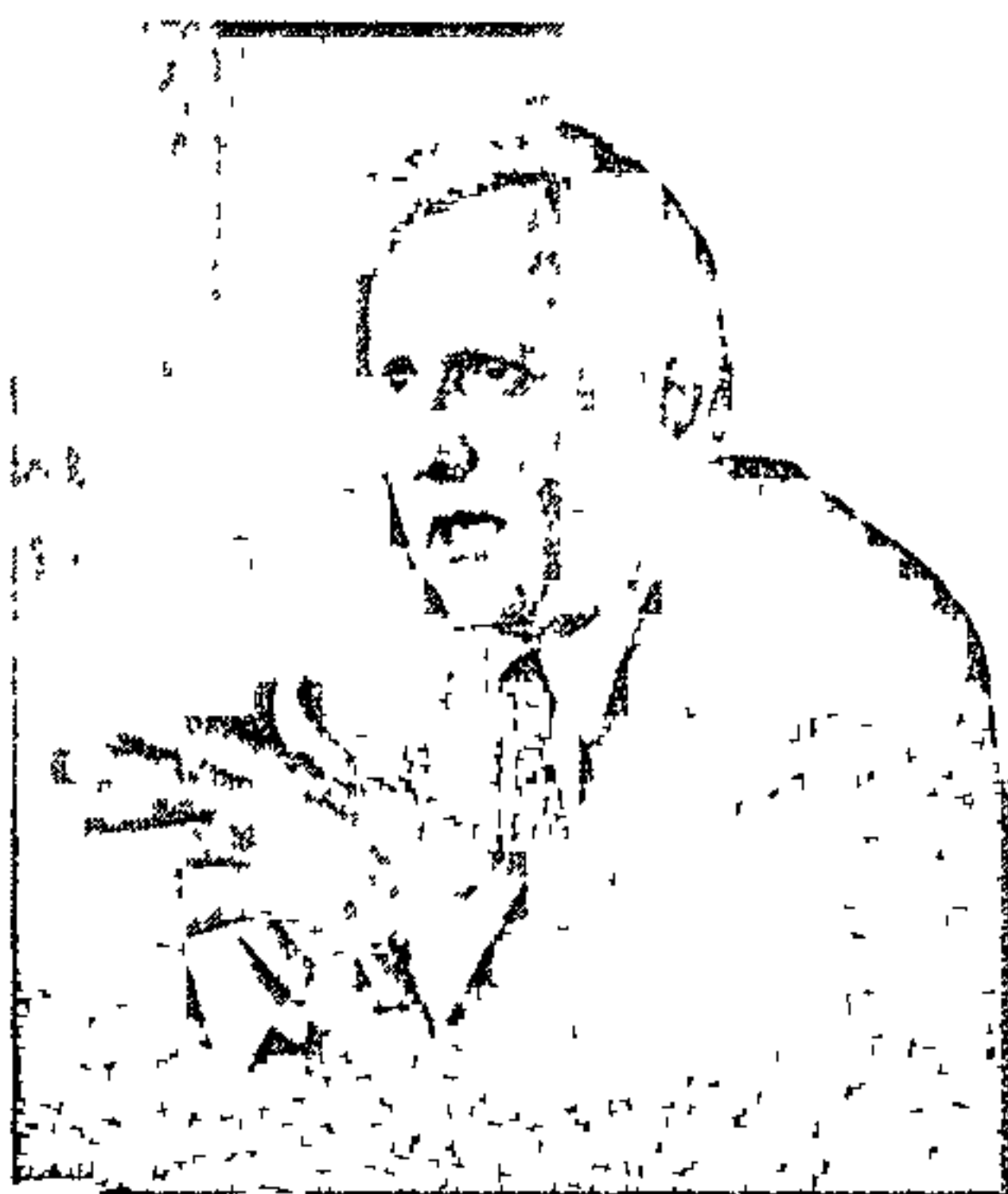

Randmin's Knobbs ... preparing the next project

platinum

As one mining analyst points out, it is extremely difficult to predict market conditions when these come on stream. But it can be assumed that, as with Barbrook, Randmin has been extremely thorough in its evaluations and conservative with its budgets and forecasts. On the metallurgical side, for example, during exploratory drilling 42 deflections were taken on the UG2 reef for metallurgical testwork.

Management does not intend to confront market leader JCI head-on. Randmin gold division chairman Clive Knobbs says that the planned production of about 140 000 oz of platinum by 1992 will represent only 5% of demand for South African platinum and about 3,5% of the Western world's requirements. The plan is to expand to meet customers' needs. Despite expansions, Randmin's platinum market projections show a 1985 supply deficit of 70 000 oz rising to 170 000 oz in 1992.

Financial forecasts show the mine would make healthy profits with PGM prices 30% lower than at present. For 1992 the forecast is pre-tax profit of R21m with capex of R80m, and the 1998 pre-tax profit projection is R114m with capex of R28m.

Although low-grade Merensky reef is present, Rhodium plans to mine only UG2 reef, whose reserves total 83,6 Mt at an in situ grade of 6,3 g/t. The recovery rate is estimated at 69,5%, tonnage milled should be 2,16 Mt in 1993, rising to 5,24 Mt in 2002. Unit operating costs are projected at R59,16/t in 1993 and R54,09/t in 2002 (in 1987 money).

Recovery grades would be higher than at other new or expanding producers except Northam, but Northam will start mining at twice the depth of Rhodium, where the UG2 seam extends from about 700 m to about 1 400 m below surface. Lefko's initial operations will be very shallow, but by the Nineties both Lefko and Wesplats will be using shafts systems, with consequent higher costs. Longer term, Randmin believes there is large potential for improvements in metallurgical extraction from the UG2.

Meanwhile, it is possible that the project could be further expanded, or its life extended, if a deal can be made with JCI — or, perhaps, with government. JCI apparently owns minerals on ground contiguous to Rhodium's lease area, and JCI seems unlikely to exploit these itself. A logical move on Randmin's part would be to try and negotiate with JCI, failing that, to approach government with the same argument that Pouroulis used when he put together Lefko's mineral rights.

In terms of the agreement earlier this year when Randmin acquired 42% of Vansa, the house will inject R52,5m of the initial funding of the platinum mine, by subscribing for additional shares in Rhodium. This will fix its direct equity stake in Rhodium at 60%, with Vansa holding the rest, with Randmin's 42% holding in Vansa, its total interest in the Rhodium rises to 77%. Part of the remaining funds will be raised by way of a rights offer later this year, when the company will be listed. Judging by initial reactions to the announcement, the listing should be well received.

Andrew McNulty

STANBIC

## Sell out terms

Standard and Chartered's (Stancha) sale of its Standard Bank Investment Corporation (Stanbic) shares has been completed, in a complicated deal, which must leave minority shareholders wondering how to react. Individuals should take the shares, not the cash offer.

After completion of the deal, the new major shareholdings will consist of Liberty (30%), Old Mutual (20%), Gold Fields



# Asbestos mines in battle to break even

ADAM PAYNE

THE asbestos twins, Msauli Asbes and Griqualand Exploration and Finance (Gefco), are struggling to break even and Gefco reports a loss of R512 000 in the six months to June.

This compares with a profit of R6,4m at the same time last year and a profit of R9,4m for the year to last December.

Operating income in the six months totalled R768 000 but financial costs were R1,3m.

Pat Hart, chairman and MD of the two mines, says they are struggling but the first half of the year is always worse than the second when customers stock up before year-end.

The directors report production has been cut at Gefco's Kuruman and Penge mines. Because of the cutback, unit operating costs have risen.

The combined effects of low US dollar prices, a stronger rand and higher unit costs substantially reduced working profit margins.

Sales volumes for the year are expected to be slightly lower than last year. No significant improvement in performance is foreseen in the remainder of the year.

Financing costs should, however, be reduced in line with expected reductions in fibre stock levels.

The company had foreign loans totalling \$1,7m at June 30.

Msauli's after-tax income in the half year was down to R50 000 compared

with R1,7m a year ago.

Turnover was higher at R18,6m (R16,8m) but operating income plunged to R232 000 (R2,2m).

US dollar prices for asbestos appeared to stabilise. Although moderate price increases for some grades were obtained for the first time in five years these were inadequate to offset the negative effects of the stronger rand and the high internal inflation rate.

Msauli managed to operate at about break-even in the six months. The capital programme went according to plan. Financing is becoming increasingly problematic because of the near exhaustion of internal resources.

"At this stage every effort is being directed at maintaining at least a break-even situation," say the directors.

"However, inflationary pressures will continue to hamper any improvement in profit performance, despite significant improvements achieved in productivity."

"The investigation into the longer-term viability of the mine is progressing according to plan. The results are expected to be before the board during the latter half of the year."

Both Msauli and Gefco each have a 25% interest in the Von Brandis gold prospect, 2km from Msauli.

After meeting their share of prospecting costs they will be partners with Phelps Dodge Corporation.

(217) 6/20/87 4/9/87

# Retief warns on platinum supply

**RUSTENBURG** Platinum Holdings chairman Pat Retief warns unless platinum demand increases sufficiently to absorb increases in supplies there is a material risk that major market and price setbacks will occur.

In his annual review to shareholders, Retief says the platinum market is sensitive to oversupply situations and the emergence of three new producers, coupled with the likelihood of increased production from existing platinum mines, "adds up to a considerable increase in total world supplies over the next few years.

"Happily, the Rustenburg group is in sound financial and technical condition to take up these challenges of the medium- and long-term future."

Retief says the higher rand price for platinum has led to an "unprecedented effort on the part of our competitors to locate and develop new platinum deposits, even ones which in our judgment might prove to be of marginal long-term viability and which are certainly less attractive than reserves available to Rustenburg."

These efforts have, of course, been intensified by the knowledge that a booming JSE will facilitate the raising

## Business Day Reporter

of capital funds required to start mining activities, he adds.

In the six months to June, sales of investor products in the form of bars and coins appears to have slumped worldwide to below 70% of the level achieved in the corresponding period of 1986 and to less than half of that achieved in the second half of 1986.

"Of course, these adverse developments do not necessarily portend an imminent collapse in the market. To a large extent, they will be off-set by the very significant increase in autocatalyst demand that is occurring in Germany and also in Korea, and by the continuing strong demand for platinum jewellery and indeed for platinum in industrial applications, in Japan."

"However it seems a substantial portion of the boom of the past year or two has been due to the increase in areas of speculative demand rather than in the more reliable industrial end usage. The traditional volatility of the platinum market is more likely to be increased than decreased by this development and Rustenburg's affairs have been planned accordingly."



217

RUSTENBURG PLATINUM

# Market uncertainties

**Activities:** Mining, processing and refining of platinum group metals and by-product gold, copper and nickel

**Control:** JCI holds 32,62%, Anglo American holds 23,79% and Lydenburg Platinum holds 8,25%

**Chairman:** P F Retief, managing director B P Gilbertson

**Capital structure:** 125,3m ords of 10c each  
Market capitalisation R7,3 billion

**Share market** Price 5 800c Yields 3,4% on dividend, 5,1% on earnings, PE ratio, 19,7, cover, 1,46 12-month high, 6 350c, low, 4 100c Trading volume last quarter, 1,5m shares

**Financial:** Year to June 30

	'84	'85	'86	'87
Profit on metal sales (Rm)	210,3	349,9	675,8	1 047
Gross sales revenue (Rm)	807	1 063	1 600	2 216
Taxed profit (Rm)	100,1	156,9	258,2	368,9
Earnings (c)	79,9	125,2	206,1	293,8
Dividends (c)	60,0	90,0	135,0	200,0

After the spate of new producers that entered the picture recently, key variables for the fortunes of platinum companies are the future demand for, and supply of, platinum group metals (PGM). Rustenburg Platinum (Rusplat) chairman Pat Retief comments in detail on the matter in his 1987 review.

Retief shows concern that additional supplies from all the new producers coming on stream could weaken the market. However, contrasting with that standpoint are Rusplat's own actions in increasing its output through the formation of Lebowa Platinum to expand production from the Atok mine

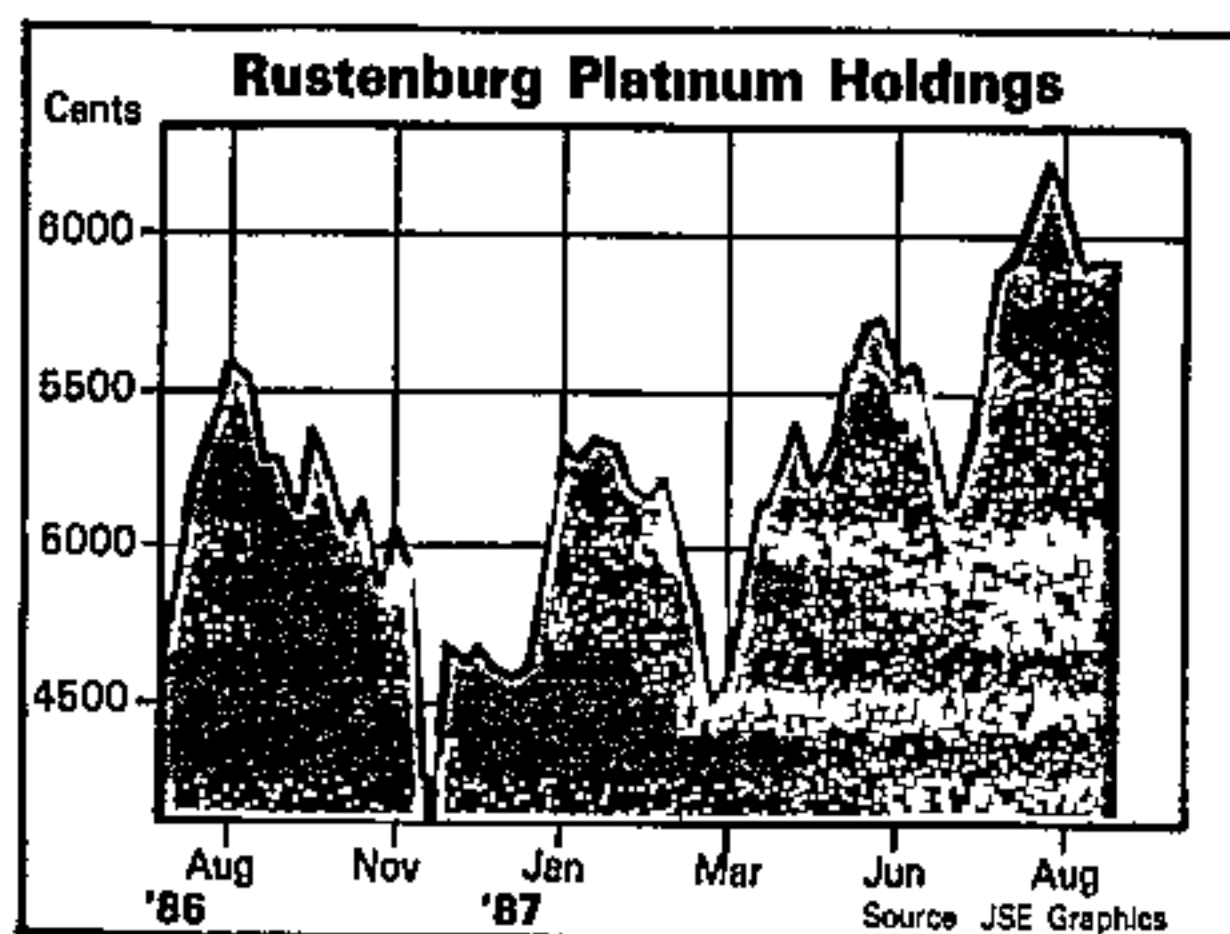

and develop the Maandagshoek deposit

Referring to new mines coming on stream in SA, and lesser amounts of new production building up elsewhere, Retief says "Unless demand increases sufficiently in the coming years to absorb these increased supplies, there is a material risk that major market and price setbacks will occur. Happily, the Rustenburg group is in sound financial and technical condition to take up these challenges of the medium to long-term future."

Some analysts feel that Rusplat, having



Rusplat's Retief ... risk of market setbacks

dragged its heels as long as it could on development of the Maandagshoek project, is being forced by the Lebowa government to do something about it or risk losing the mineral rights. Potentially at risk on that scenario is more than just Maandagshoek mineral rights which Rusplat holds over the important Platreef deposits are also in Lebowa. For Rusplat, then, developing a mine it may not really want could be the best of an uncomfortable situation, given the group's concerns about oversupply.

A Rusplat spokesman says only that "In terms of the joint venture agreement entered into with the Lebowa Development Corporation on behalf of the Lebowa government, the company is required to expand its production in Lebowa."

According to Johnson Matthey, which markets Rusplat's production, platinum demand in 1986 was 2,85 m oz while supply was 2,79m oz. Indications are that GFSA's Northam, Loucas Pouroulis's Lefko and Rand Mines' Rhodium Reefs could add another 540 000 oz annually by the mid-Nineties, Lebowa will add a further 150 000 oz a year and Western Platinum about another 135 000 oz. That would push total platinum supply to about 3,6m oz annually by 1996, without taking into account anything additional that Rusplat or Impala may do with their own outputs over this period.

Not everyone accepts the demand crunch scenario. Johnson Matthey GM platinum marketing, Alan Austin, suggested to the Platinum '87 conference in Canada earlier this year that platinum consumption could possibly reach 3,77m oz a year in 1996,

fuelled principally by growth in the jewellery and autocatalyst markets. By contrast, a straightline projection based on historical growth over the past 12 years indicates consumption of only about 3,2m oz by 1996.

A recent report from JSE stockbroking firm J D Anderson notes that historic average growth rate in platinum demand over the past 12 years is 1,38% a year and, if that continued, an oversupplied situation could arise from about 1990 because of the new mines starting up.

However, the report points out that over the past two years demand growth has risen at 2% a year, while the growth in platinum demand in 1986 compared with 1985 was 2,53%. The report says an annual growth rate of 2,82% is required to prevent an oversupplied situation occurring.

While all the platinum market newcomers believe their output will be absorbed by the market, much will depend on expansion of the uses of platinum. The European car industry is seen as a crucial area.

Referring to the way in which State-owned mineral rights were taken from Rusplat and allocated to Lefko, Retief warns that, if this indicates a State policy calculated to promote increased platinum production, it involves very material risks because small oversupplies can cause major price drops.

Retief says that much of the platinum demand boom of the past two years has been in areas of speculative demand rather than industrial end-usage, which he feels is likely to increase the traditional volatility of the platinum market. "Rustenburg's affairs have been planned accordingly," he says.

Some analysts feel that Rusplat has for several years been adopting conservative financial policies and storing funds away ahead of a downturn. If so, that would be a major point in favour of the group when ranked against major competitor Impala. Overall, Rusplat has a number of strengths that should help defend its dominant position in the long term. These include large financial muscle, proven, aggressive marketing capability, and ample scope to expand at relatively low cost.

Brendan Ryan

M & S SPITZ

HM 18/9/87

## Stronger step

The recent sale of the manufacturing operations leaves the up-market shoe retailer well heeled to pursue its core business, while also strengthening the balance sheet. This comfortable situation follows a turnaround last

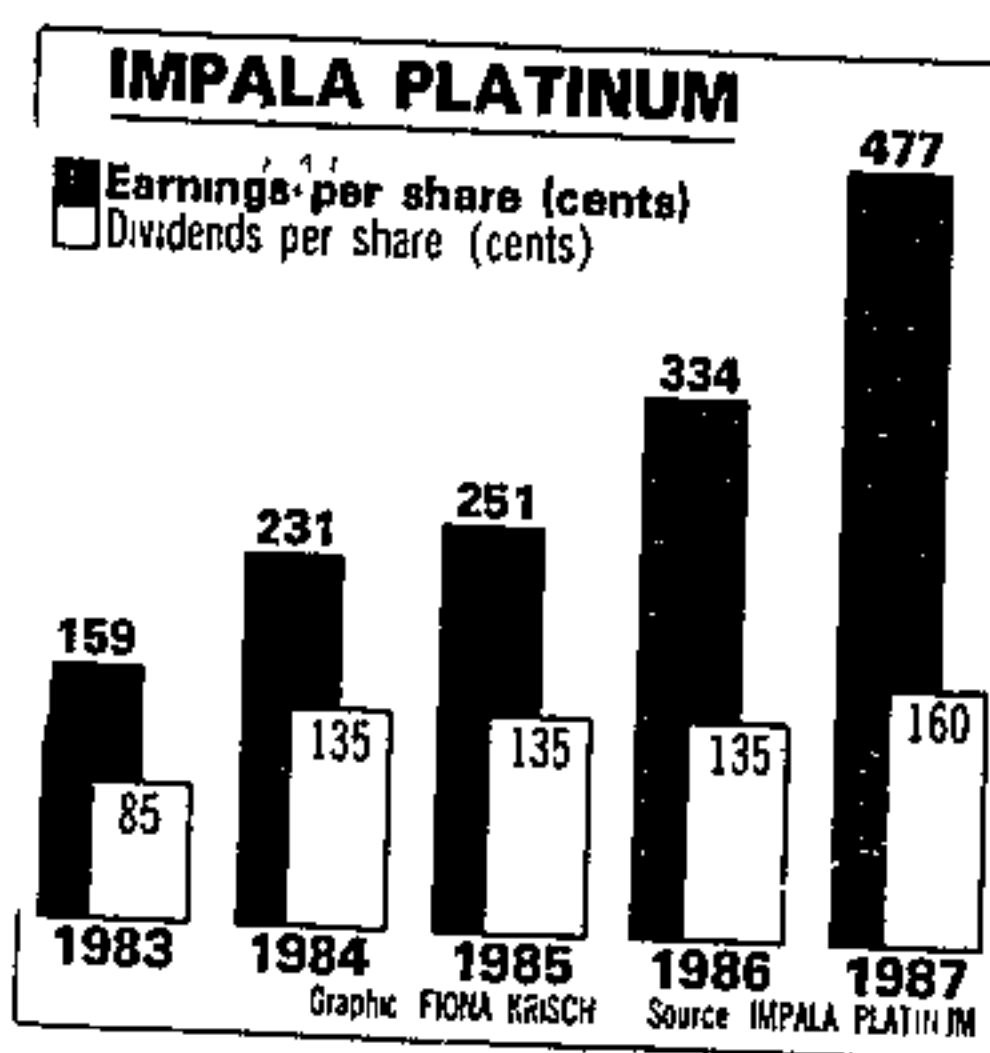

**PETER STACEY**  
Mining Editor

IT may not be all plain sailing for new entrants to the platinum market, Impala Platinum's Carl Netscher warns.

The Impala chairman says in his annual review that a volatile market for platinum group metals between now and the coming on stream of new projects could mean re-appraisal and a downward revision of their prospects.

On the positive side he sees the market as having sound fundamentals "The platinum price in dollar terms is likely to remain strong for the foreseeable future," he says.

Looking at the 1987/8 financial year, he says that while growth in world economies may slow, a growing investment market should result in total demand maintaining a degree of pressure on supply.

"The progress made in the fuel cell programme indicates that commercialisation of fuel cells in the early 1990's is now a real possibility," he adds.

Netscher said the upward progress of the platinum price in rand terms over the past 24 months had been particularly strong, and had encouraged existing and potential producers to announce new production projects.

"However, little change in metal

# Prospects for plats seen as volatile

supply to the market is likely in the near term because of the long lead times required for the creation of new mining production facilities.

"In the intervening period changing market conditions could alter the supply/demand situation, which is not unusual in the volatile platinum market.

"Consequently, there is a likelihood of reappraisal and downward revision of some of the prospects currently planned."

Impala as an established producer, and one which sells a substantial part of its output on a contract basis was well placed, both in the medium and long term to "ensure that its market is adequately catered for".

Netscher said demand for the other platinum group metals had been characterised by steady consumer interest in palladium and a growing consumption of rhodium, particularly from the motor industry, which had been mirrored in the strong price performance of these metals.

The nickel market had shown a welcome return to strength as the year progressed. A good balance between demand and supply appeared to have been achieved, and the metal's price had begun to recover to "more normal levels" in recent months.

217  
2/29/87



## Severin group must raise R530m

# New platinum mine in Lebowa

217  
CAPE TOWN 8/10/87

JOHANNESBURG — A major new platinum mine and refinery, costing R530m, are to be opened by the Severin mining group in Lebowa

Steen Severin, the Danish chief of the Severin group, said an initial tranche of R70m would be raised in December through a private placing with institutions, and the balance of R460m in a listing targeted for May 1988

### Lease

Details had not been finalized, he said, but it would be a medium-to-big mine

The prospecting lease is held by Southern Sphere, formerly Utah International's subsidiary in SA, which is now wholly owned by Severin

Severin said that because no drilling had been done, no value had been placed on the platinum prospect in Utah's sale of a package of prospecting permission to the Severin group late last year — reportedly for R5m. Eersteling gold mine is being opened on one of the other prospects in the package

"You could call it a bargain," said Severin, referring to the platinum prospect. In January this year, shortly after the sale of the package, sinking of six boreholes was begun on the property.

Not all of these holes were complete, but results had been encouraging on both the UG2 and the Merensky reefs

Severin said a reserve of 80m tons of mineable UC2 was indicated, and about the same amount for Merensky

A major disadvantage was that it would be a relatively deep and hot mine. Severin said the ore was at an average of 1800 m

He said application was being made to the Lebowa government for a mining lease and preparations for shaft-sinking would begin next January.

### Target

It was intended the mine would begin production by the end of 1990

The current target was that full production would be 150 000 tons milled a month, which the mine would build up to as quickly as possible — Sapa

# Reds rake in cash for SA<sup>(217)</sup> uranium

15/10/87 SIMON BARBER

WASHINGTON — The Soviet Union, which appears to have no intention of copying the US Comprehensive Anti-Apartheid Act (CAAA), is raking in hard currency by enriching SA uranium for Western customers.

The CAAA bans imports of SA uranium, but not, as interpreted by the US Department of Treasury and Nuclear Regulatory Commission, of SA-origin material which has been enriched elsewhere.

About 20 tons of Soviet-enriched uranium originally bought from SA Nuclear Fuels (Nufcor) are due to arrive in the US today for fabrication into fuel pellets by Advanced Nuclear Fuels (ANF) at its plant in Richland, Washington.

Details of the paradoxical arrangement are contained in an affidavit filed with the US Court of Appeals by ANF on October 2 after anti-apartheid groups sued to block the shipment.

The case is especially ironic because the ailing US enrichment industry is seeking a \$8bn bailout from the federal government and could use the business that is going to the USSR.

The affidavit says the uranium is owned by Rheinisch-Westfaelisches Elektrizitaetswerk (RWE), a West German utility, and was acquired from Nufcor between 1976 and 1979.

Late last year, the material, then in concentrate form, was converted to uranium hexafluoride for RWE by British Nuclear Fuels and sent on to the Soviet Union for enrichment.

ANF is to fabricate the enriched uranium under a January 1, 1984, contract with RWE and must deliver the final product by next May.

Members of the congressional black

● To Page 2 →

## Reds rake in cash for enriching SA uranium

caucus and the Nuclear Control Institute, an anti-nuclear group, asked the commission to revoke ANF's licence to import the material because of its (by now, somewhat distant) SA origins

After a considerable delay, the NRC rejected the petition and the protesters applied to the court for an urgent injunction, arguing that ANF should find another source of enriched uranium. The injunction was denied on Friday.

In its affidavit, the company said it was "idle to suggest that ANF should attempt to replace 20 tons of enriched uranium hexafluoride to substitute for the planned shipment

"First, the (material) does not belong

← ● From Page 1 (217)  
to ANF, it would have to be replaced by RWE. It is estimated the replacement value would exceed \$11m

"Second, enriched UF<sub>6</sub> of a specific enrichment, unlike uranium ore or uranium oxide, is not a product readily available on the international market."

DOMINIQUE GILBERT reports that Atomic Energy executive chairman Wynand de Villiers last night referred to the reports as "very old news"

However, De Villiers declined to confirm or deny their content saying that even if they were valid he would not confirm the sale of any SA uranium

Blair  
15/10/87



# Rustenburg strikes back

217

Platinum market leader Rustenburg Platinum (Rustplat) this week took the wraps off Lebowa Platinum, its response to the newcomers intent on carving their way into the platinum market over the next five years.

Publication of the Lebowa prospectus, followed by a presentation to analysts, provided an unprecedented degree of disclosure of information by Rustplat. The unaccustomed openness was evidently intended to underline the group's intention not only to remain at the top of the platinum heap but, if anything, to increase its market share.

In the same week came the release of further details concerning the developments at Rhodium Reefs and Messina's platinum project, as well as the announcement of yet another new platinum mine, this time by the

**As more prospective platinum producers appear on the scene, industry leader Rustenburg Platinum has unveiled an aggressive response.**

#### Severin group

Rustplat's aggressive stance also focuses attention on forecasts of a platinum oversupply crunch from about 1991-1992 onwards, and the question of which of the newcomers will survive if the worst happens.

The platinum market is expected to grow at a rate of some 3.5% annually over the next five years (see table), considerably better than the average rate of 1.38% over the past

12 years. This means the platinum price will remain firm for the next three years, when there is likely to be a shortfall in the supply of new platinum. Rustplat MD Brian Gilbertson estimates the shortage this year at 60 000 oz and for 1988 at 100 000 oz.

The situation starts to change from about 1990. Lefkochrysos Platinum plans to start producing in late 1989, reaching 1.92 Mt milled during 1991. If all goes according to plan, Lefko should produce about 150 000 oz of platinum in 1991, while Western Platinum's current expansion programme should have lifted production to the forecast rate of an additional 135 000 oz/year by then.

Platinum supply from existing sources totalled 2,83m oz in 1986. Assuming this builds to about 3,1m oz by 1991, that gives a

total supply of about 3,385m oz against the Johnson Matthey (JM) consumption forecast of 3,4m oz.

From 1992, GFSA's Northam kicks in, followed by the other newcomers. By 1996, if all goes according to plan, Northam (about 250 000 oz), Rhodium Reefs (about 150 000 oz), Lefko (planned further expansion to 320 000 oz), Lebowa Plats (about 150 000 oz), Messina (about 100 000 oz), and Severin Mining (about 150 000 oz) will add a further 970 000 oz to annual platinum supply. Assuming the existing producers hold their output at 3,1m oz — unlikely because there is already speculation about an expansion by Impala on new ground — that gives a total platinum supply figure for 1996 of 4,35m oz against a forecast consumption figure of 3,77m oz made by JM marketing executive Alan Austin at the Platinum '87 conference in Canada.

This is a worst-case scenario. Rustplat executives believe that, despite the various optimistic claims, the newcomers are going to run into mining and metallurgical problems and production will be held below forecasts.

Against this background, Lebowa Plats emerges as one of the top contenders. The prospectus reveals that Maandagshoek has estimated reserves on the UG2 Reef of 67 Mt at an in situ grade of 7,5 g/t of platinum group metals (PGM) over a stoping width of 92 cm, as well as 26,5 Mt of Merensky Reef at 6,77 g/t in situ. All this ore is located at a depth of only 300 m.

By comparison Lefko, also a shallow mine starting from surface, has an in situ grade of 5,9 g/t on the UG2 Reef over an average reef width of 140 cm. No figures for Merensky Reef were given in the Lefko prospectus.

Both operations will be low-cost producers, but Lebowa has the added advantages of being an existing producer, through the present operations of the Atok section which are being expanded. Its UG2 and Merensky concentrates will be toll-treated by Rustenburg's existing metallurgical plants. The metallurgical processes for treating the Maandagshoek ores have already been proven by Rustplat, and Lebowa's output will be marketed through Rustplat's existing and long-established system.

## Expansion eastwards

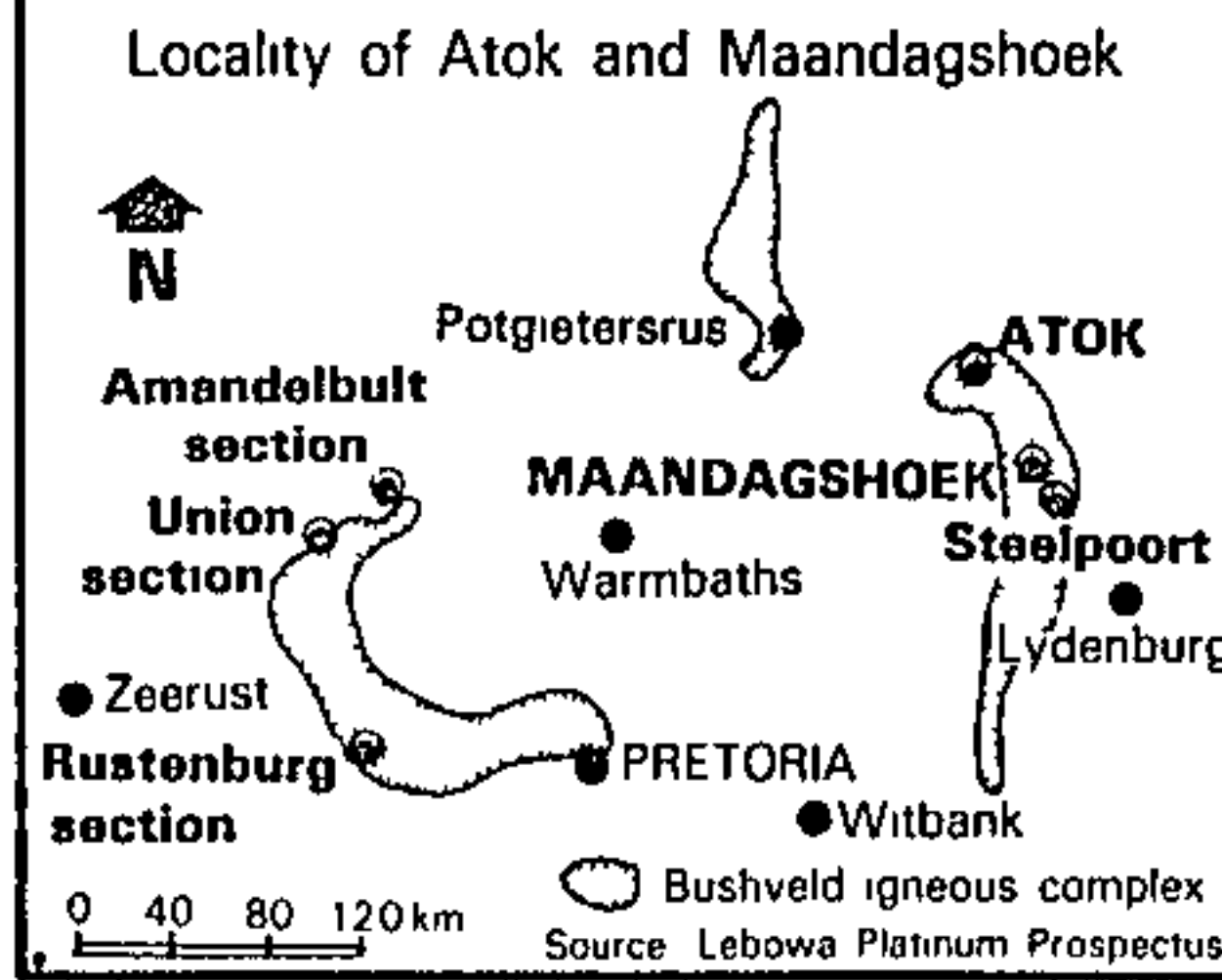

Rustplat will follow the proven Westplat route of mixing UG2 and Merensky concentrates during smelting. This overcomes recovery difficulties which can be experienced in smelting pure UG2 ore. While Lefko management received a grilling over its plans to smelt pure UG2 concentrates using new Mintek technology, investor confidence has been boosted by the news that Rand Mines intends using the same procedure to smelt pure UG2 concentrates at Rhodium Reefs.

Gilbertson also said at the presentation that Lebowa Plats is being set up as the vehicle to exploit Rustplat's huge ore reserves on the eastern Bushveld Igneous Complex. Rustplat owns outright the mineral rights to 120 km<sup>2</sup> of ground contiguous to, and running south from, Maandagshoek, where the UG2 and Merensky reefs outcrop. Down dip of this area and contiguous with it, are the farms Hoepakrantz and Nooitverwacht, to which Lebowa will gain sole mining rights when the Maandagshoek operation reaches 100 000 t/month milled within five years.

What of the other projects? One industry source — a highly experienced mining executive — has ranked the current expansion programmes in their descending order of attraction as follows: Lebowa Plats, Impala's expansion, Westplat's expansion, Northam, Rhodium Reefs, Messina, Lefko and the Severin project. A key factor in that ranking is the risk reduction provided by the technical backup that would be available if required, in view of the complexities involved in platinum smelting and refining. There is also the question of financial support: should there be a depression in the platinum market it was for these reasons that Vansa got into bed with Rand Mines — which is to

manage the mine — instead of going it alone on Rhodium Reefs.

Messina announced this week that it is to hold a R62m rights issue to repay its debts and fund its 5 000 t/month pilot mining operations. Finance director David Dry confirms the mine will be developed and managed by Messina and not sold to Impala as has been speculated. He tells me that Messina intends building up production from the Merensky Reef slowly. The policy is not to try to come in immediately with an operation producing 150 000 oz of platinum a year owing to the risk of such an approach. He says Messina's plans are to produce a smelter matte and then have this toll-refined either locally or overseas, and so initially avoid building and running base and precious metal refineries. He expects the mine to be in production in 12-18 months.

Some analysts believe the cautious approach that Messina is taking is the correct one. Big Daddy in this case is controlling shareholder Sanlam. Sanlam, through Gencon, also controls Impala and that link could be used for technical help if needed.

Messina may not be alone in its decision to go for toll-refining. GFSA's Northam Mine is due to make a decision within months on its refining plans and indications are that it, too, could initially go the toll-refining route.

It's early days yet on the Severin platinum project located in the Steelpoort Valley near Rhodium Reefs. But indications are the forecast capital expenditure of some R530m, virtually the same as Rhodium Reefs, could be optimistic, as could the proposed timing of the development. This is because much of the infrastructure needed for Rhodium Reefs, such as housing, hostels, power, and workshops, was already available through a combination of the Vansa Vanadium development and the inclusion of the nearby Winterveld Chrome Mine into the group.

Vansa shareholders, who were last week offered rights into Rhodium Reefs' holding company Barplats Investment, of one linked unit — consisting of 10 ordinary Barplats shares at R15 each and eight compulsory convertible debentures at R20 each — per 100 Vansa shares held, were this week offered a second way in through the listing of Marshall Metallic Corporation (Metallic).

Metallic will be formed by the listing of Lonfin's South African subsidiary Erconovaal, which holds 28% of Vansa. Vansa shareholders are being offered Metallic shares on a one-for-two basis, with 40 ordinaries and 10 options offered at 450c each for every 100 Vansa shares held. This, plus a public issue and private placing, will raise R90m of which R37m will be used to fund Metallic's contribution to Barplats. The rest will be used to build a portfolio of high-quality gold and other mining shares.

The attraction of Metallic is that shareholders will have exposure to the platinum market through Barplats, but will also be investing in vanadium through Vansa's operations and in gold through the investment portfolio.

Brendan Ryan

## MOVING UP

### Consumption of Platinum in '000 oz for 1946-1986 and the predicted Consumption for 1991

	1946	1956	1966	1976	1986	1991
Autocatalyst	—	—	—	490	1 015	1 150
Jewellery	180	60	150	950	880	1 050
Investment	—	—	—	—	450	400
Chemical	40	200	300	280	195	200
Electrical	50	80	200	240	180	220
Glass	—	80	180	95	90	140
Petroleum	—	220	370	90	25	40
Fuel Cells	—	—	—	—	—	10
Other	30	40	100	285	45	190
<b>Total</b> . . . . .	<b>300</b>	<b>680</b>	<b>1 300</b>	<b>2 430</b>	<b>2 880</b>	<b>3 400</b>

Notes: Net Consumption  
'Other' includes sales to Comecon/China

Source: Johnson Matthey



AC 645 19/10/87 (217)

# 'Platinum market will be underpinned soon'

From NEIL BEHRMANN

LONDON — Chairman of Rustenburg Platinum Pat Retief believes that the platinum market will be underpinned in the next year.

Platinum priced around \$583 has under performed gold recently.

In a presentation of Lebowa Platinum he was more cheerful about the metal's prospects than his recent statement in the company's report where he warned that the market could be "oversupplied" by a production surge in Southern Africa and to a lesser extent North America and elsewhere

"Unless demand increases sufficiently in coming years, there is a material risk that major market and price setbacks will occur," he said.

Mr Retief continues to be cautious about platinum's prospects in the early 1990s when competing mines come on stream. But the fundamentals of the metal are still good for this year and next.

During a recent trip to Japan he noticed a marked turnaround in jewellery demand for platinum

So much so that Japanese jewellery consumption is estimated to be 900 000 ounces, the highest level since 1979 Japanese orders for large investment bars also totalled 161 000 ounces this year, he said

The US automobile industry, however is buying less platinum and worldwide investor purchases of bars and coins is down 50 percent from last year's 450 000 ounces

But the Japanese penchant for platinum jewellery and orders from European automobile makers needing platinum to meet more stringent anti-pollution legislation indicated that demand would exceed supply

Mr Retief is proud that Rustenburg Platinum Holdings, the largest platinum miner in the world, is following some other South African companies and is offering shares to blacks

A team from Rustenburg presented Lebowa Platinum Mines to London emphasising that besides the issue of stock to shareholders in Rustenburg, blacks identified with Lebowa will get a stake

"We are the first South African mining company to issue shares to blacks," said Mr Retief

Some 2,5 million black nationals associated with Lebowa can apply for 7,5 percent of the 86 million shares issued by the mine, he said.

Another 12,5 percent of the shares will be owned by Lebowa Development Corporation which is controlled by blacks and promotes industry and education in the region.

Lebowa Platinum a mine in which Anglo American and its sister company Johannesburg Consolidated Investment will hold 45 percent of the shares is presently producing 30 000 ounces of platinum a year, Mr Retief said Expansion of the mine would raise platinum output to around 50 000 ounces by 1989 and to about 100 000 ounces by the early 1990s, he said.

Rustenburg is producing around 1,4 million ounces a year, he said This is half annual world platinum production of 2,8 million ounces a year.

Professor PC Mohgokong of the Lebowa Development Corporation said it had created employment for 14 000 people following the establishment of mining and agricultural projects

# Implats to start new platinum mine

Implats Platinum Holdings is to establish a new platinum mine at Marikana, 30 km east of Rustenburg. Implats is to raise R300-million towards financing the project by a rights issue to ordinary shareholders.

The new mine, developed partly to maintain Implats's output as production at the present mine starts to decline in the next few years, will be known as the Karee Mine.

It will also provide a base from which to increase sales, Implats managing director Mr Don Ireland told a Press conference today.

Construction will begin early next year, with the first metal being produced early in 1990.

Capital expenditure to bring the mine into initial production is estimated at R406-million in July 1987 terms.

Mr Ireland said the platinum market was forecast to continue growing over the medium to long term, and Implats was well placed to participate in the growth.

Application would be made by Gazelle Platinum, a newly registered wholly-owned subsidiary of Implats, to mine precious metals over the proposed lease area between Western Platinum and the Rustenburg section of Rustenburg Platinum Mines.

He said Karee had extensive mineable reserves on both the Merensky Reef (around 130-million tons) and the UG 2 Reef (some 180-million tons).



# Impala Platinum <sup>(217)</sup> to set up new mine <sup>SMA</sup> at cost of R300-m <sup>23/10/87</sup>

By Teigue Payne  
Impala Platinum Holdings is to establish a new mine at Marikana, 30km east of Rustenburg, at a cost of R300 million financed by a rights issue

The Karee mine will be wedged between the Rustenburg section of Rustenburg Platinum Mines and Western Platinum's lease area. It will mine both Merensky and UG2 reefs. Reserves so far have been calculated at 130 million tons, with an in situ grade of 5,5g/t of combined platinum group metals on Merensky and 180 million tons at an average 5,3g/t on the UG2.

The grades are uncorrected, however, and the reality could be 10 percent higher, according to Mr Don Ireland, managing director of Impala. Recovery grades in prospect are, says Mr Ireland, slightly higher than Impala's existing grades.

The UG2 reef outcrops on the 4 600ha property's southern boundary, and the Merensky outcrops slightly north of it. Both reefs dip northwards and reach 1 450 metres (Merensky) and 1 600 metres (UG2) at their deepest.

Since Merensky grades are highest in the central area, the first shaft will be sunk there, but four shallow winzes will be sunk on the UG2 outcrop to bring the mine on stream as soon as possible. Later, an incline shaft will be sunk in the central area to mine UG2 reef.

Construction will begin in early 1988. The first metal will be produced early in 1990, building up to an initial planned level of 100 000 ounces of platinum a year by 1991. Smelting will be at Impala's smelter in Bophuthatswana and refining at its refinery in Springs.

Total output is planned to increase to 300 000 ounces a year by the year 2000, although it could be speeded up, depending on the market. The initial goal is to make up for a decline in production from Impala's operation in Bophuthatswana and increase Impala's production marginally.

Impala is opening the mine after the recent announcements of seven other new platinum projects, creating fear of oversupply in the market in the medium term.

Mr Ireland says if all projects

announced (except the Severin Steelpoort project, which was announced too recently for inclusion) produce as planned, production of platinum in Southern Africa will rise from 2,2 million a year currently to 3,2 million in 1994.

Impala is being cautious about its expansion because of the oversupply possibility. However, Mr Ireland says that with its established position, Impala is confident of being competitive. Working costs, which Impala will not reveal, will be slightly lower at Karee than at its existing Bophuthatswana operation.

Mr Ireland says Impala is banking on an eight percent real rate of return on the project. The project will not benefit from Impala's tax shelter as the existing Impala operation is in Bophuthatswana and the Karee mine is wholly within South Africa.

Mr Ireland says the rights offer will not materially affect Impala's dividends for the current financial year — although this will entail some reduction of cover — and Impala's 1987 dividend of 160c should be maintained.

# Wraps off new Karee project

217  
5/20/87  
23/10/87

**PETER STACEY**  
Mining Editor

IMPALA PLATINUM yesterday unveiled the R406m Karee platinum project, its contender on the growing list of new platinum mines.

The mine, near Marikana, is planned to reach a first stage full output of 100 000 ounces of platinum early in 1991. From this base, there will follow a modular build up to 300 000oz a year of platinum — at a cost in current terms of R320m.

Construction will commence early next year and the first metal production

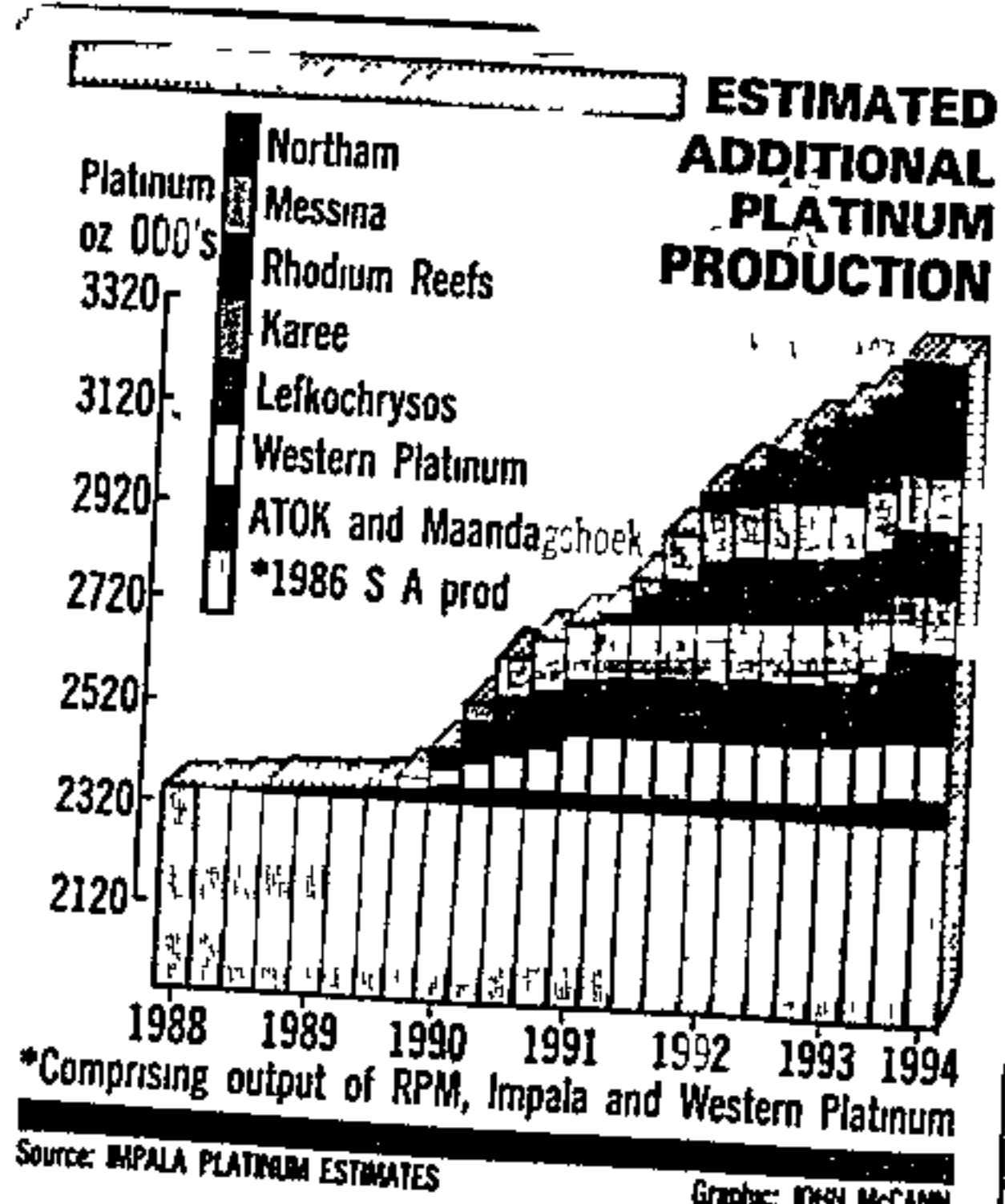

is scheduled for two years later. The mine will be a wholly owned subsidiary of Impala Platinum Holdings and finance will be raised by way of a R300m rights offer to shareholders.

● To Page 2 ➔

# Impala unveils R406m Karee

◀ ● From Page 1

The new operation, sandwiched between Rustenburg Platinum Mines and Lonrho's Western Platinum, 30km east of Rustenburg, will initially concentrate on the UG2 Reef, mined from the outcrop at the southern boundary of the 4 600ha property.

In addition, a 775m vertical shaft near the centre of the property will provide access to a high grade area of Merensky Reef.

Total reserves of 310-million tons, at average *in situ* grades above 5g/t for both Merensky and UG2 Reefs, indicate a life of mine of about 100 years. Merensky Reef grades range from 4,4g/t to 6,5g/t, while those for the 180m deeper UG2 Reef average about 5,4g/t.





# Impala sets a cat among the pigeons

IMPALA has fired the latest salvo in the great platinum struggle.

The Impala board announced on Thursday this week that it was to open a platinum mine to be called Karee

Located at Marikana, Karee is sandwiched between Western Platinum on the east and the Rustenburg section of Rusplats on the west. The proposed lease area will be a stand-alone operation and Impala will not have the benefit of launching the mine under a tax shield.

A rights issue to members of Impala will raise R300-million to finance the project, for which the total capital expenditure forecast is R406-million in July 1987 money. This will translate to R570-million in the money of the day, says Impala managing director Don Ireland.

## BOREHOLES

Mr Ireland says that the platinum market is forecast to continue to grow over the medium to long term and the mine will provide cost-effective replacement capacity to maintain metal output.

A total of 55 boreholes was drilled along the 6,6-kilometre outcrop and little faulting was encountered. The mineable reserves comprise 130-million tons of Merensky Reef and 180-million tons of UG2 Reef.

Mr Ireland went so far as to disclose the grades. He said that three ore types had been identified in the Merensky Reef. These were 42-million tons of type 1 at 4,4g/t platinum group metal, 36-million tons of type 2 at 6,5 g/t and 52-million tons of type 3 at 5,8-million tons.

In addition, the grade on the UG2 was 5,3g/t, giving a total of 310-million tons at an average grade of 5,4g/t.

## INITIAL

These figures are uncorrected fire assay values and could be 10% higher following correction. Mr Ireland declined to furnish details of the reef widths, other than that they varied.

The two reefs outcrop on the southern edge of the property and dip northwards at 10 to 12 degrees. Merensky overlies UG2 and will be accessed by a vertical shaft at a depth of 775 metres. This will take 18 months. Four shallow winzes will access the UG2.

Karee's initial output has been set at 100 000 ounces of

platinum a year, which will "marginally increase sales", says Mr Ireland. Thereafter, production will be increased on a modular basis to offset the expected gradual decline in metal output from Impala's operations in Bophuthatswana.

## OPTION

The target is 300 000oz, for which R320-million in July 1987 terms will be required. This will probably not be before 1994.

Planning has been for conventional mining with the option to switch to mechanised methods should the opportunity arise.

Smelting will take place initially under a toll agreement with Impala's current facility in Bophuthatswana, and the refining at Springs.

No details of the rights offer have been disclosed other than the amount to be raised and the comment that the dilution in the number of shares will not have a material effect on the dividend. "... the 1987 dividend of 160c per share should be maintained".

An "S" class ordinary share will be issued to overcome problems associated with the investment ban imposed by the United States.

Many analysts have expressed surprise that Impala is not considering expanding into an area contiguous with its current operations. This would have enabled the effective use of Impala's tax umbrella.

From the evasive way in which questions on this subject were replied to, it appears that either the reef is not suitable, the depth is too great or indeed that Impala does not own more mineral rights.

Mr Ireland says that extraction of PGM from UG2 is not as cost effective as from Merensky, and that it gives rise to reduced metal output.

A real return on investment of at least 8% is possible, using a platinum price of \$460 an ounce and a reducing exchange rate.

217  
30/10/87 FM

production will be initially smelted on a toll basis at Impala's existing smelter in Bophuthatswana, while refining will be done at Impala's refineries in Springs which have adequate capacity.

That minimises the technical risks involved in the expansion. As previously reported (FM October 16), it justifies a ranking of Karee as the most attractive of the new platinum ventures after Rustenburg Platinum's expansion through Lebowa Platinum.

Impala MD Don Ireland says customers have asked Impala to increase its platinum output. This means the market for the metal is virtually guaranteed and the only effect of an oversupply situation would be on the price. Ireland is confident the Karee project will be able to cope profitably with lower prices if necessary. He says the real internal rate of return on the project is 8%, assuming a platinum price of \$460/oz is maintained in real terms.

Karee will be a combined expansion/re-

added to them to get an accurate comparison with the grade figures given for Lebowa, which were corrected. After the correction Lebowa is still a higher-grade proposition.

Cost of the new mine is R406m of which R300m is to be raised through a rights issue. Karee is completely separate from the existing Impala mine which means Impala cannot offset capital expenditure on the new mine against current revenues for tax purposes. Impala will hold Karee through a wholly-owned subsidiary called Gazelle. This structure is to provide flexibility to list Karee separately in future if Impala so decides, but Ireland indicates there are no immediate plans for this.

Because of the rights issues Impala's earnings in the current year will be diluted by the extra capital. Ireland says this effect will not be "material" and the 1987 dividend of 160c a share should be maintained.

Analysts are split in their opinions over the choice of investment in Impala against Rustenburg but a number,

including London broking firm Kitcat & Aitken, are recommending investors keep Rustenburg to get the Lebowa Plats entitlement and then switch to Impala. Feeling is that Impala looks cheap at present in relation to the increased revenue which the greater production and the change in the General Motors contract should bring.

Attraction of Rustenburg is that the

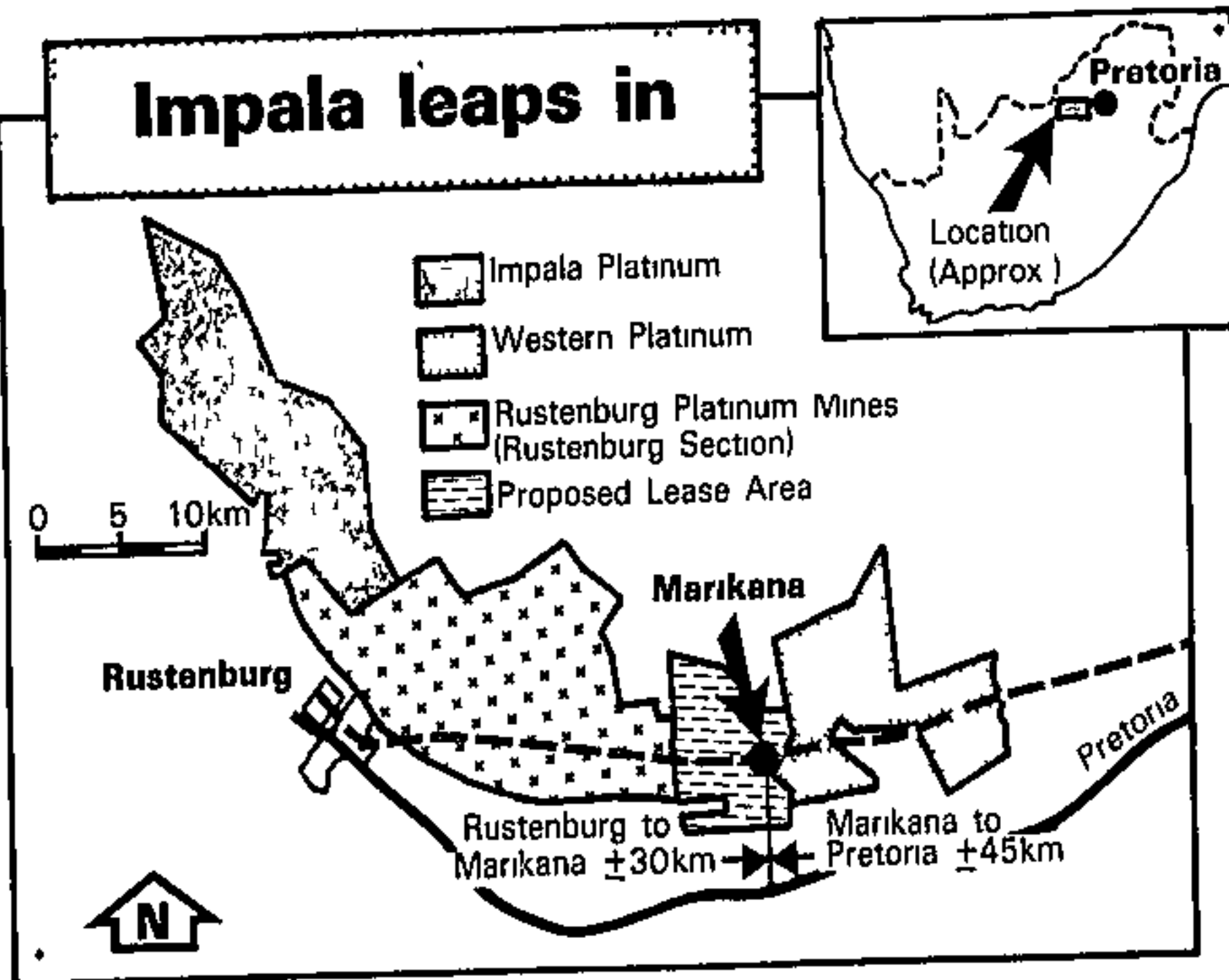

placement project for Impala, with construction starting early next year and the first metal due to be produced early in 1990, building up to the initial planned level of 100 000 oz of platinum annually by early 1991. The UG2 and Merensky Reefs outcrop on surface in the south of the Karee area, and the plan is to start production immediately from the UG2 through a number of shallow incline shafts. Simultaneously a vertical shaft will be sunk to a depth of 775m in the middle of Karee lease to get at higher-grade Merensky ore located at depths between 300m and 600m.

The initial output of 100 000 oz will be an expansion on Impala's current production which is estimated at about 1m oz — Impala refuses to disclose the exact figure. Ireland says that from the mid-Nineties, output from Impala's existing lease will start to drop as the percentage of low-grade ore treated rises. Karee will be expanded to produce about 300 000 oz of platinum annually to compensate for this expected drop.

Karee's ore reserves are estimated at 130 Mt on the Merensky Reef at an average in situ grade of 5,5 g/t pgm, and 180 Mt at an average grade of 5,3 g/t. These grade figures are uncorrected, about 10% should be

group has been salting away funds for years against a platinum market depression and is in a very strong financial position. The annual report revealed R665m in cash and short-term deposits and no debt. Also, when it comes to future expansions at low cost, Rustenburg is in a better position than Impala which is limited by lack of ground.

Impala is going ahead with Karee because it does not own the mineral rights to the down-dip extensions of its current lease area. If Rustenburg wants to expand production, it can do so from its existing mines on the western limb of the Bushveld Igneous Complex (BIC), and on the eastern limb through Lebowa Plats. The extensive Platreef deposits which Rustenburg controls will also be mined by Lebowa Plats.

Brendan Ryan

## IMPALA PLATINUM

### Opening Karee

Impala Platinum's expansion through the new Karee mine at Marikana adds further weight to worries about future platinum oversupply. This project looks one of the more successful of the rush of new platinum ventures.

Karee's main advantage is that it is a marginal expansion of output by a major existing producer, so the market for the metal to be produced is virtually guaranteed. Its

FINANCIAL MAIL OCTOBER 30 1987

217



## Messina postpones rights issue

# Platinum shares slump to lows

CML-Trans 2/11/85

217

Own Correspondent

JOHANNESBURG. — The platinum bubble has burst. Tumbling platinum share prices, have caused Messina to postpone its rights issue.

Messina shares slid 350c to R14 in the past week, down 51,7% from the pre-crash high of R29.

### Funds

With other platinum producer shares slumping to new lows last week and Messina previously only rated highly on its platinum prospects, a rights offer at this stage was deemed imprudent.

Messina intended to raise R62m for its pilot plant project in Lebowa. The group has now made arrangements for the provision of the necessary funds to enable it to complete the evaluation of the platinum project by proceeding with limited mining operations and the establishment of a pilot plant, according to a Senbank announcement.

But alternative arrangements spell a larger debt burden for strapped Messina. Although the group turned in a taxed profit of R2,3m in the six months to June, interest-bearing debt remained high at R67,4m. Shareholders have had to forego divi-

dends since 1984.

The rights issue would have reduced borrowings and strengthened the balance sheet, releasing the group from certain restrictive agreements with its bankers concerning the acquisition and disposal of assets and the payment of ordinary dividends, according to the original announcement on October 12 of the intended rights issue.

Messina will have to wait for a market recovery and in particular an upturn in currently free-falling platinum stocks.

The JSE platinum index plummeted 19,4% to a year's low of 2 432 on Friday, 45,6% off its high of 4 470 on August 6.

Week's losses were substantial on the platinum board. Year's highs are shown in brackets.

### Year's lows

Impala Platinum lost 850c to a year's low of R33 (R60), Rustenburg Platinum fell 800c to a low of R34 (R63), Lydenburg declined 925c to a low of R32,25 (R59), Lefkochrysos shed 325c to R11 (R24,23) and Leplat nil paid letters came off 115c to 135c (800c)

Only Northam, down 200c at R36 was a fraction above its low of R35,50.

V  
n  
S  
S  
N  
St  
cr  
is  
fo  
to  
al  
la

su  
ti  
a  
L  
n  
1  
d  
i  
s  
l  
l

CME Times 6/11/87 (217)

# Platinum plunges as gold moves off lows

LONDON — Gold made a limited recovery to close at \$460/\$461, off morning lows of \$454/\$456 but still down from Wednesday's \$466,50/\$467

Platinum closed at \$460/\$465, down from Wednesday's \$499/\$501 and just above the lows set after large scale morning liquidation. The afternoon platinum fix of \$464,50 was the lowest since August 1, 1986

Dealers said platinum started the early fall, sliding to a low of \$451/\$456 as sell stops were triggered below \$500

After going down the \$25 limit in New York on Wednesday night, platinum "dropped like a stone" in London yesterday morning from a high of \$481/\$486, one dealer said. It was fixed in the morning at \$472.

The metal traded for much of the day at near parity with gold, after showing a premium of \$33 on Wednesday and \$34 at the start of last week.

Platinum again fell the \$25 limit in early Nymex trading

Active selling of gold at the morning fix also played a part in pushing the markets lower. Gold slid to a low of \$454/\$456 shortly after the fix of \$459,70

Bearish sentiment was seen as the most powerful factor driving bullion lower, with the market ignoring normally positive influences such as the continuing slide of the dollar.

● In Zurich, gold end-

ed sharply lower after sentiment was hit by continuing falls on stock markets, dealers said

The weaker dollar hindered rather than helped the dollar as the old inverse relationship between gold and foreign exchange simply ceased to apply, they said.

Gold ended here at \$456,50/\$457,50, just above the day's lows, and \$9 below the opening and the previous close

Dealers said gold had been dragged down by platinum, which had plummeted to \$461/\$468 an ounce, \$21 below the

opening and \$39 below the previous close.

Platinum has, anyway, always been a more speculative metal than gold and was being pressured by fears of recession which would hit demand for cars, particularly in the US, and with it demand for their pollution-cutting catalytic convertors which use platinum

Silver was also sharply lower, ending at \$6,30/\$6,40 an ounce, \$0,38 below the previous close

● In New York, gold closed at \$458,50, down from its previous close of \$466,35 — Reuter

## ATTENTION!!!

### CALLING ALL INVESTORS WHO HAVE LOST MONEY ON THE STOCK MARKETS

A seminar will be held today  
Friday November 6 1987  
on Venture Capital Investment Opportunities  
"One of the hottest ways to make big money  
and multiply your wealth"

— New York Daily News

All are welcome

PLACE: CAPGOLD SECURITIES (PTY) LTD  
Regd share dealer of the  
Unlisted Securities & Private  
Placings Market (US + PPM)  
201 Cartwrights Corner  
(2nd Floor), Adderley Street

The seminar is free but to reserve a place  
it is essential that you telephone 45 6434  
as accommodation is limited

(CAA38207)

# stay open



# Platinum price soars above \$500

18/11/87  
Bl & Day  
217

d  
h-  
e-  
it  
in  
t.  
e  
l

THE platinum price rose strongly yesterday and on fundamentals should remain above \$500 an oz.

The London morning fix was \$503 and the afternoon fix \$506.25, compared with \$488 the previous afternoon — a rise of \$18.25.

January futures rose in New York yesterday morning to \$515/oz, and then fell back to \$509, unchanged from Monday.

The Johnson Matthey report released on Monday saying the demand for platinum is set to exceed the supply of newly-mined metal could have been a factor in the price rise.

ADAM PAYNE

A platinum mining executive expressed the view yesterday that the price should remain firm with fundamentals as they are.

However, since the surge in price in 1980, fundamentals have not ruled the platinum market. Speculators influenced the market and prices have moved regardless of fundamentals and have been based on sentiment.

"Markets are uncertain and nobody knows what direction the price will take," said a platinum analyst.

"When speculators said the demand for autocatalysts would slacken, the price fell. Others then said the auto demand would remain strong, and the price rose.

"With the threat of inflation in the US there is also the possibility that people will move out of currencies into precious metals."

Meanwhile, Rustenburg and Impala share prices have plummeted since October 19, although nothing has changed in their business and profits should be strong with the price maintained in the \$500/oz area.

# Vansa paints rosy platinum picture

Monday 24/11/87  
ADAM PAYNE 217  
VANSA Vanadium chairman David Marshall is confident about future platinum prices, in spite of doubts expressed about overproduction.

In his annual review for Vansa, which has platinum, vanadium and chrome interests, Marshall says "Much has been said about an over-supply of platinum group metals and weak prices in the future.

"I do not share that view. Metal demand for the group's products will be highly competitive but our sales agent Rand Mines (Mining & Services) is well placed in the market to maximise our planned share."

He says Rand Mines undertook the feasibility study of the Rhodium Reefs platinum mine at a platinum price substantially below current market levels



**MANGANESE**, chrome giant Samancor turned in a strong interim performance on the ferrochrome-chrome ore side, while manganese alloy sales and prices turned out to be better than expected.

But, as anticipated, the strengthening rand, rising costs and a weak manganese ore market combined to force earnings down again from the high levels of 1985/1986.

Nevertheless, Samancor's performance is regarded as satisfactory in the circumstances by CE John Jacobs, who expects similar earnings in the second half of the year.

Attributable taxed profit for the six months to September declined 21% to R74,9m, from R94,8m in the first half of 1986, equal to earnings of 50,03c a share (63,34c a share). The interim dividend has been cut slightly to 27c from 30c.

## Samancor profit takes a knock

LIZ ROUSE

Turnover was up at R427,7m (R400,9m), reflecting an improvement in sales volumes and prices of several major products, in particular ferrochrome. But the effects of higher costs on increased sales is clearly reflected in a narrowing operating profit margins.

With pre-tax profit down 39,8% at R99,6m, from R165,4m, the percentage operating profit to turnover was down at 23,3% from 41,2% in the 1986 half-year, and 32% in the previous full year to March 1987.

Samancor remains impressively liquid

● To Page 2

## Samancor's earnings take a dip

with long-term loans at R36,4m and expected to decline further in the second half of the year. Maximum permissible borrowings are R505,9m, while actual borrowings amounted to R50,5m.

Interest charges were only R1,6m (R3,5m in the 1986 half-year), while interest received amounted to R5,2m (R13,2m). Samancor's strength is further mirrored in retained income of R407,4m and R83,6m in the deferred tax benefits reserve, all factors which justify the

share's rating as a hedge stock

Planned capital expenditure is R100m, of which R60m is being spent on a sinter plant, R14,5m on pollution control facilities at Meyerton and the balance on replacement of equipment.

Jacobs says the cash-rich giant is looking at production of stainless steel in the longer term.

● From Page 1

STI TOP 100 COMPANY

(2/19) 6/12/87

# Rusplats: favourite of the institutions

NUMBER four performer over the past five years has been Rustenburg Platinum Holdings (Rusplats)

During 1982 the shares traded between 265c and 695c and in August of this year the price had reached an astonishing 6 350c. Compounded annual growth over the period has therefore been 70,2%.

There are 125,3-million shares in issue and the earnings a share in 1982, at 32,7 cents, put the company at that time on an average price-earnings ratio of 14,6 times. By 1987 the mean price at 4750c and earnings of 293,8 cents rated the share on a PE of 16,2

## Outpaced inflation

The share's performance outpaced inflation and gave investors their just rewards

Trade in the shares also rose over the period. In 1982 only 1,4-million shares changed hands, but this peaked during the financial year ending June 1986 when almost 8-million shares traded on the JSE. This eased to 6,9-million in the year to June 1987.

Principal corporate shareholders are Anglo American with 23,8%, Johannesburg Consolidated Investments with 32,6% and the listed holding company, Lydenburg Platinum, which owns 8,3%.

Rusplats has obviously been a favourite among institutions and features among most mutual and pension fund portfolios.

Rusplats is the holding company for the Rustenburg group of platinum producing mines. It operates three major mines which exploit the platinum-bearing reefs in the western part of the Bushveld complex.

The three sections are Rustenburg itself, Amandelbult to the north and Union section further west.

## New base

While the primary product is platinum itself, the platinum group metals — palladium, rhodium, iridium, ruthenium and osmium — are also produced, as well as gold and silver. The important by-products, copper and nickel, sulphuric acid, cobalt sulphate and sodium sulphate, are also produced.

The mines' production is currently treated at several locations within South Africa and the United Kingdom, but rationalisation steps are under way in the form of a new precious metals refinery.

This has been designed to replace the ageing refineries at Wadeville near Ger-

miston in South Africa and at Royston in the south of England. In 1981 a new base metal refinery was also completed at Rustenburg to replace the old one.

These steps will shorten the platinum pipeline from the mining of the ore to the selling of the products. The marketing is handled by Johnson Matthey plc, which jointly owns the refineries with Rusplats. Part of the group's product is purchased direct by customers under long-term sales agreements.

To put some perspective on Rusplats' performance the financial year ended June 1987 saw its profit amount to more than R1-million each day, and the amount paid on tax and lease exceeded R1,5-million a day.

Rusplats is the largest producer of platinum in the world and, though production figures and recovery grades are kept under wraps, it is generally assumed that its mines produce more than 1-million ounces of platinum a year.

The advent of several new proposed producers of platinum has been noted

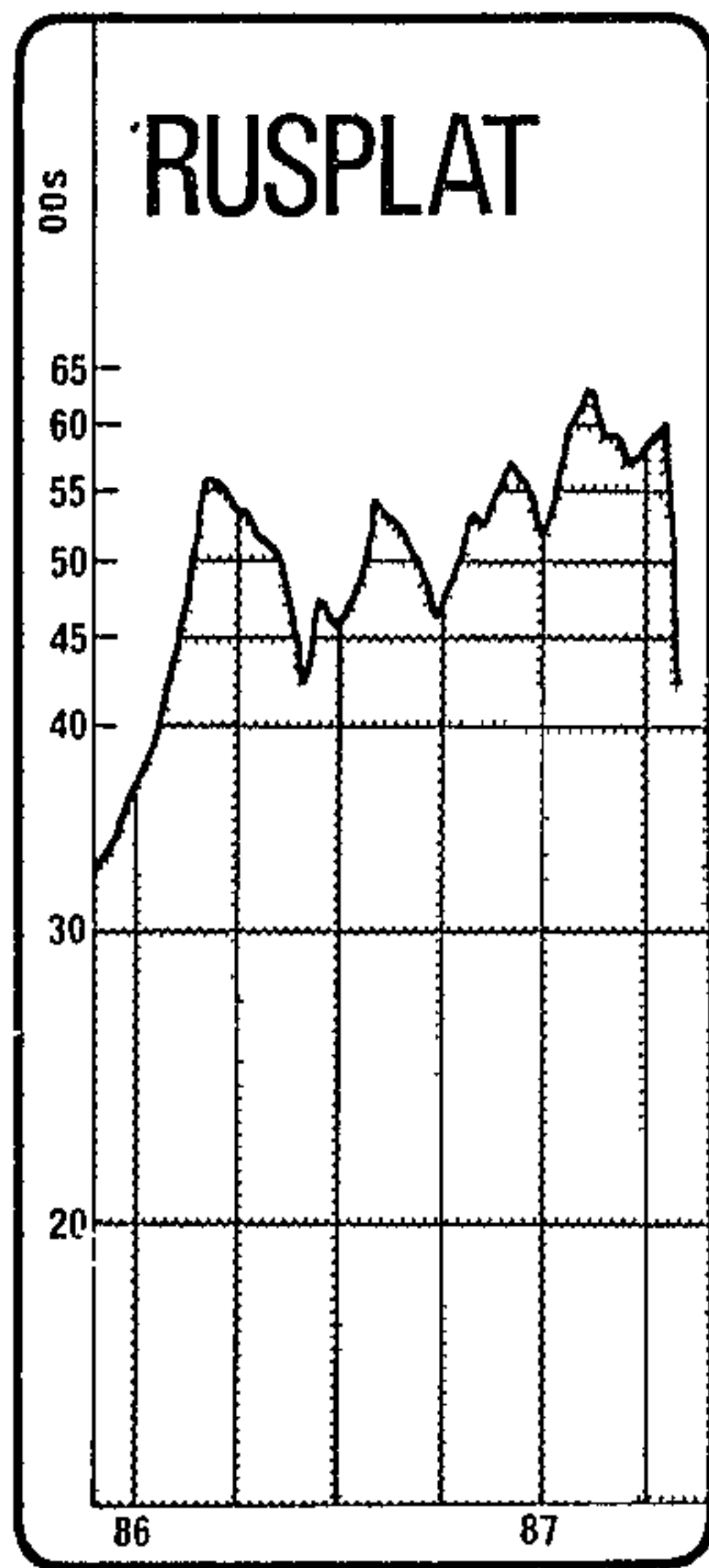

By Julie Walker

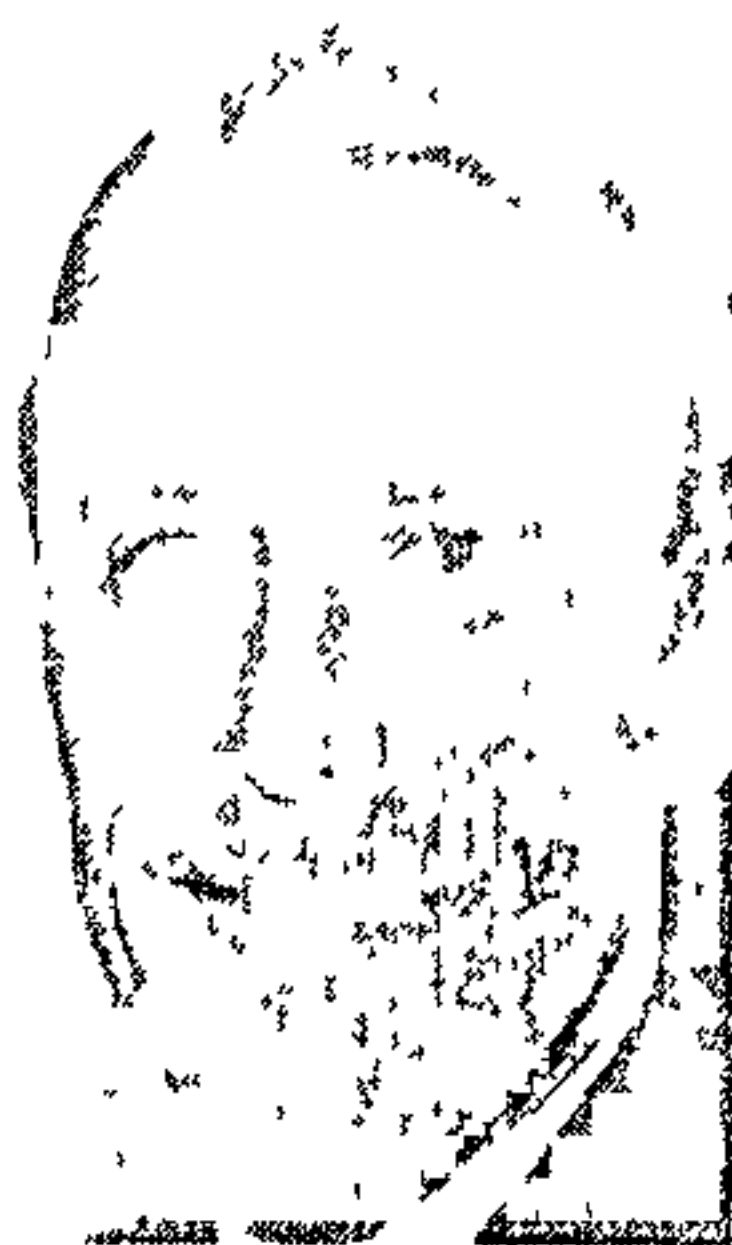

PAT RETIEF  
Rand performer

with some concern by the company. The chairman's statement lays out the effects an oversupply of the metal may have.

Chairman Pat Retief points out that, as recently as 1985, the average price of platinum was at a seven-year low in dollar terms, but in the local currency it has risen consistently.

In 1982 the price per ounce averaged R352, but by 1986 this had reached over R1000. The first nine months of 1987 has seen the rand price even firmer.

In retrospect, the chairman's comments have

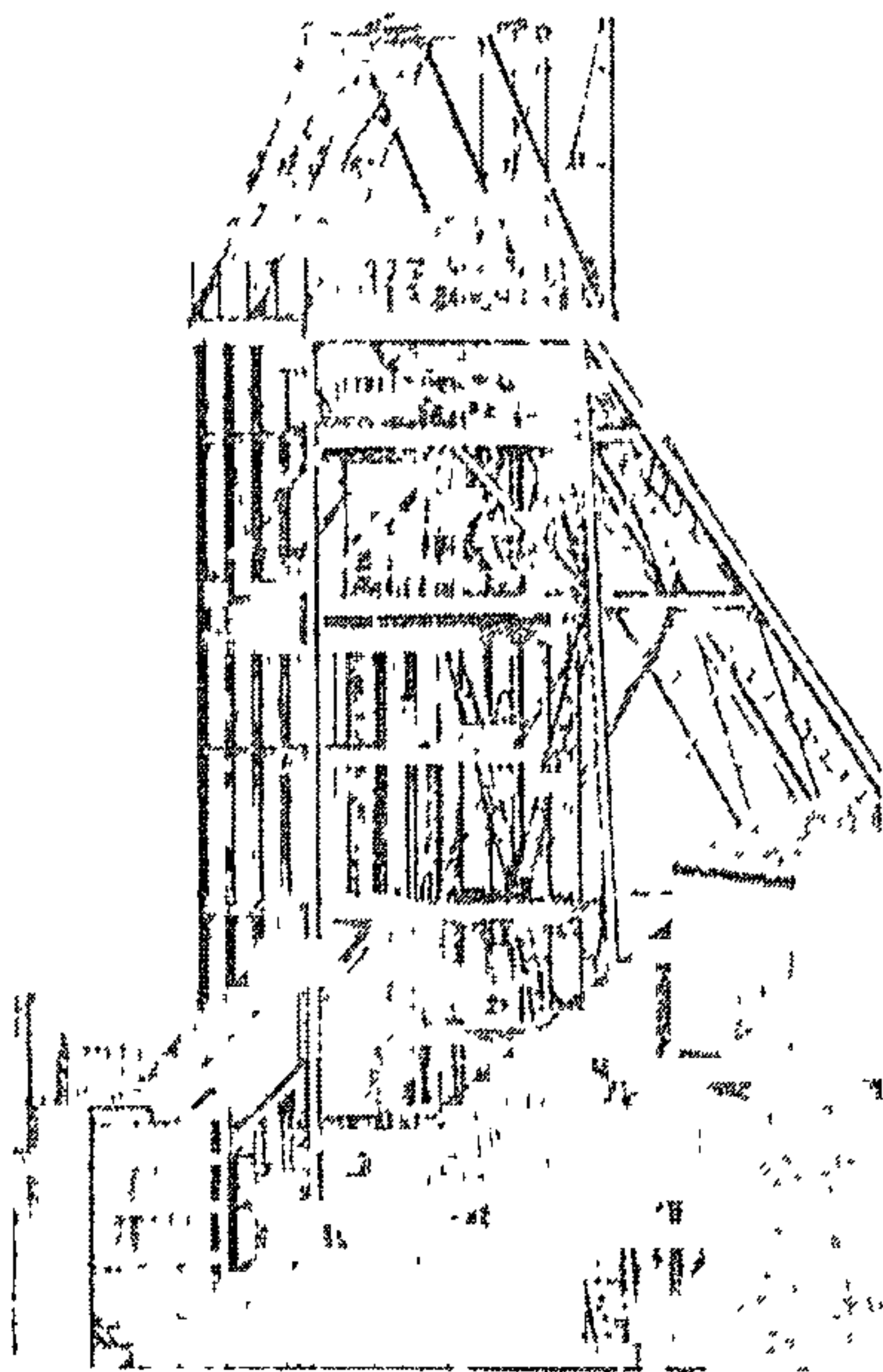

RUSTENBURG MINE Giving investors just rewards

proved to be shrewd. During October 1987 the bottom fell out of all stock exchanges around the world, and platinum shares in particular were badly affected.

For the first time in two years the price of platinum fell to trade below that of gold, but soon made up the ground to top \$500 an ounce.

The major difference between the precious metals is that the demand for platinum depends on industrial consumption and has only recently been subject to demand by investors, whereas gold has always been regarded as an investment.

The crash on the markets has led to fears of recession in the United States, which would be accompanied by a decrease in demand for cars. One of the major uses of platinum is in autocatalysts.

The world also seems to be concerned that an oversupply may be possible and this serves to depress the price further.

One spokesman for Rusplats stated publicly as recently as October that, if

such a position were to develop, some of the new proposed producers may not be around ten years from now.

Critics have responded by suggesting that Rusplats itself need not sit on its laurels. But to imply that Rusplats itself may go out of business is akin to saying that De Beers may fold if the diamond market weakens.

The chairman's statement also points out that a booming JSE has made it much easier for new mines to raise the necessary finance. The boom is now over and there have been two casualties already. Impala Platinum has postponed its proposed rights offer to fund a new mine and Messina has done likewise, although it still intends to develop its mineral rights.

To quote Mr Retief on the subject: "Happily, the Rustenburg group is in sound financial and technical condition to take up these challenges of the medium to long term future."



## FOCUS ON THE MINING SECTOR

# The year of the platinum <sup>217</sup> see-saw

1987 WAS the year of the platinum venture. Following Northam's announcement in June 1986 and its public listing in March 1987, the ball was set rolling for others to follow suit.

Northam's preferential offer of shares at R10 was followed by a public offer at R40. The shares traded at R59 on the opening day of trading, but declined steadily to trade at around R45. The crash saw them down to below R25.

Lefkochryos made public its intentions at the end of last year and attracted over R1-billion in its public offer of shares at R13 each in August. The privileged paid R5 for shares and the average price paid by institutional backers was R11.

Lefko shares traded as high as R24.50 before collapsing to R7.50 in the wake of fears about world over-supply of platinum and recession, among other factors.

Lefko made history by declaring its intention to mine and treat only the UG2 reef, to be mined near Brits on the western part of the bushveld complex. UG2 presents certain technical difficulties during the smelting stage. Lefko is confident that a process developed at Mintek will prove successful on its particular ore.

Weight was added to the credibility of Lefko's decision when Rand Mines announced that it was to establish a platinum mine, again on UG2, at Kennedy's Vale on the eastern side of the bushveld complex.

Kennedy's Vale is the site currently being exploited for its vanadium deposit by Vansa. Vansa and Rand Mines became partners in the investigation of the platinum potential and the resulting company, Barplats, has been floated on the JSE.

Both companies have absolute confidence that Mintek will solve the production difficulties, but, to quote Rand Mines' Clive Knobbs

and a chance for independents to bring small new gold mines to the boards

By JULIE WALKER

on the subject "It's also important to remember that we have plenty of Merensky Reef to fall back on."

The market had been speculating on the platinum prospects at Messina for several months before the company made an announcement that it was to undertake pilot mining of its platinum deposit at Zebedelia.

Alas poor Messina, which has sat on the mineral rights for over ten years, that the moment it chose to announce a rights offer was followed by a collapse of both the platinum price and the share market in general.

Messina shares rose from around 300c in October 1986 to 2900c by September 1987 but, upon the announcement that the rights offer was to be postponed, the price of the shares fell to a mere 575c.

Messina has reserves of both Merensky and UG2 reefs. It will nonetheless continue with its platinum venture — the share price

recovered to top R10 on this information.

Then came JCI to add to the already growing concern about the amount of platinum world demand could possibly absorb. JCI announced the expansion of operations at Atok, also toward the east of the bushveld complex in Lebowa.

The new company, to be known as Lebowa Plats, will mine both UG2 and Merensky reef, citing the mixing of the two reefs to be the only commercially proven way to treat UG2 successfully.

The UG2-only mines did not like this insinuation, especially in view of the fact that JCI has extensive reserves of its own UG2, which it could have considered treating.

Maybe the special technology which seems to have escaped the research team at JCI has been discovered by the government body of Mintek. Careful following of the conditions in Mintek's patented process should ensure success for those who try.

However, Mintek itself in

its reports on the UG2 says that ore from different parts of the bushveld complex responded to treatment with varying degrees of success. JCI must just be unlucky to have unresponsive ore.

Impala was the latest platinum company to announce plans for a new mine, Karee, although in this case it is partly for the replacement of material which is currently mined at Impala's Bophuthatswana operations. Karee is not planned to be floated separately, but a R300-million rights offer by Impala has been announced to fund the new venture.

The Severin group is also reported to be going ahead with a platinum mine close to Kennedy's Vale.

This year also saw the flotation of several small independently owned gold mines.

Rogold was the first, being floated at 100c in May. The share has been something of an underperformer when compared to the two other mines to list this year, Eersteling and Osprey.

At its 225c peak Rogold has managed only a 125% premium over the issue price, whereas Eersteling, which was also pitched at 100c, reached 410c, and Osprey, also 100c, soared to as high as 510c before the rot set in on the stock exchange.

On the other hand, it could be contended that Rogold was a more successful listing from the point of view of raising capital for the company itself. A share which commands a 20% premium over its issue price was certainly not wasteful during the primary issue.

Those which were poorly pitched and traded at huge premiums to the issue price virtually gave away the equity of the company for a song.

Rand Mines announced the launch of Barbrook, which met with analysts' approval, as was shown in the share price. The nil paid letters traded between 10c and 70c, the takeover price being 100c. Even in this nervous climate the market has faith in Barbrook.

## Value puzzle

**Activities:** Owns 99,9% of Winterveld Chrome is establishing a vanadium mine at Kennedy's Vale and has a 24% interest in Barplats

**Control:** Rand Mines owns 42% and Erconovaal (a 100% owned subsidiary of Lonfin) owns 28%

**Chairman:** D C Marshall, managing director C Heever

**Capital structure:** 34,5m ords of no par value 5m convertible preference shares of no par value Market capitalisation R117m

**Share market:** Price 340c 5 2% on earnings, PE ratio, 19,2 12-month high, R12, low, R3 Trading volume last quarter, 5,2m shares

**Financial:** Year to September 30

Debt		
Short-term (Rm)	—	0 2
<b>Performance</b>		
Pre-Int Margin (%)	'86	'87
Taxed profit (Rm)	—	5 5
Net worth (c)	0,8	6 8
	154	214

Vansa's interests cover three strategic minerals vanadium, chrome, and platinum. Income is derived from chrome mining at Winterveld and vanadium mining will start at Kennedy's Vale next year. Vansa also holds platinum rights at Kennedy's Vale through its 24% shareholding in Barplats, which holds the entire issued share capital of Rhodium Reef. Rhodium Reef is expected to produce platinum on Kennedy's Vale and an adjoining farm in 1992.

At September 30, R19m had been spent on developing the group's vanadium mine, with a further R12,7m committed. The bal-

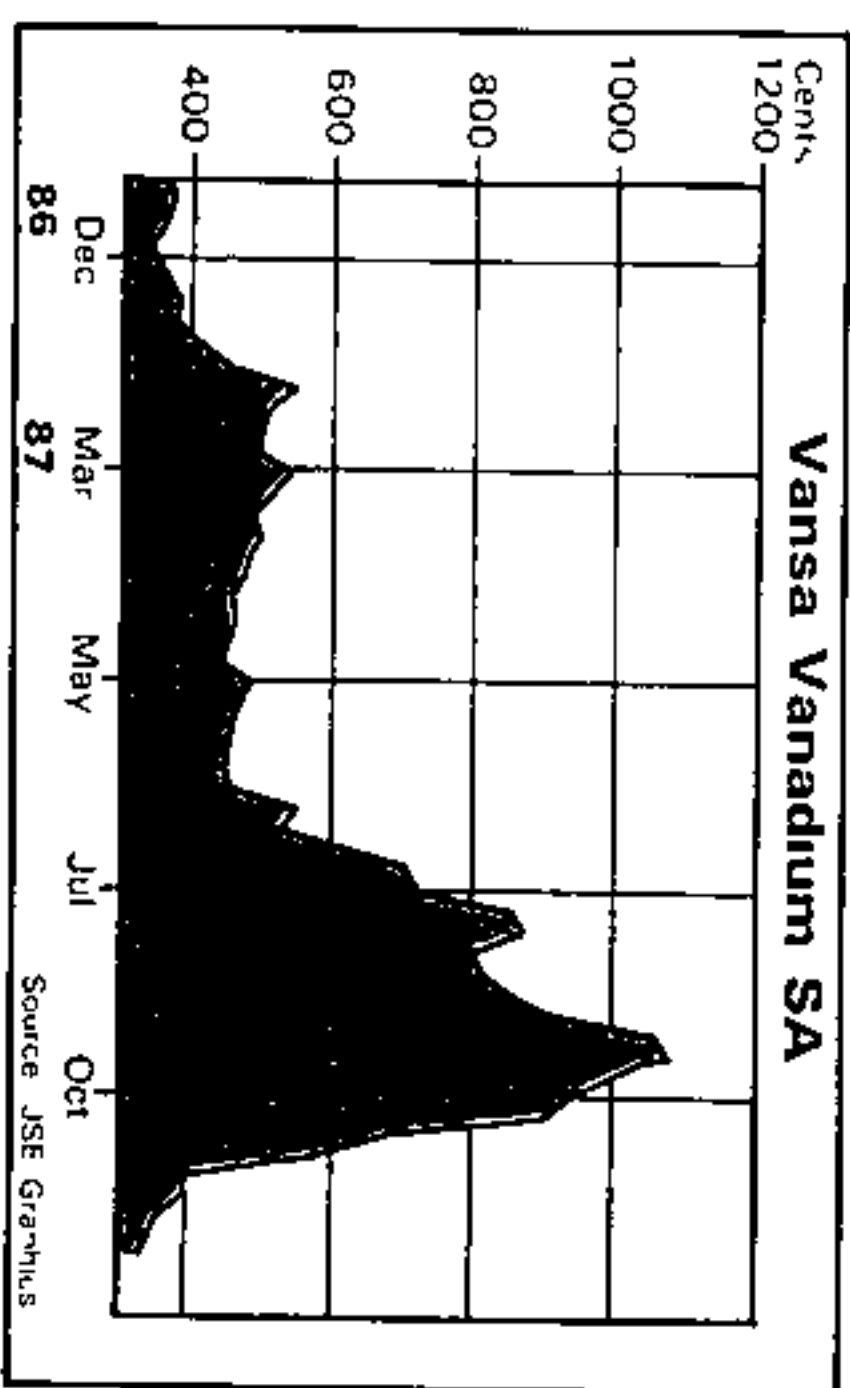

FINANCIAL MAIL DECEMBER 18 1987

ance sheet showed R19m held in cash against further capital commitments of R32m — to be financed from existing resources and available loan facilities.

Chairman David Marshall reports that the vanadium mine is proceeding ahead of schedule, but at a higher capital cost than originally estimated. He says in his review that the cost will now be about R52,5m, the Vansa prospectus gave an estimate of R30m in 1985 money and MD Cyril Heever says that, still in 1985 money, this has been revised to R41m.

"The capex increase is to cater for inflation and for sound technical changes to improve the efficiency and effectiveness of the operation," Marshall explains.

Commissioning of the Kennedy's Vale vanadium plant has been advanced to June 1988. Though first sales of ore are expected to take place in the last few months of the 1988 year, revenue from vanadium pentoxide sales will come too late to affect Vansa's

1988 cash flow materially. However, Marshall expects Vansa to pay its first dividend in 1989.

Dividends from the Winterveld Chrome operation, which is now a 99,9%-owned sub-

### DATES TO REMEMBER

**Last day to register for dividends:**

**Thursday Dec 24:** Blyvoors 75c; Boumat 14,5c, Cemenco 14c, Deelkraal 25c, Doorns 20c; Dries 80c; Fugit 16c, GF Coal 50c; Kloof 60c, Libanon 35c, Venters 30c; Vlaks 15c.

**Meetings:**

**Wednesday Dec 23:** Anjet (S) (Germiston)

All meetings are in Johannesburg unless otherwise stated.

S = Special meeting.

sidary of Vansa, amounted to R3m last year, though the value of chrome sales fell by 13% on a 15% drop in volume caused by destocking by local and export customers. About 40 production days were lost through strikes and other industrial action. Marshall, though, expects Vansa to continue to earn a "sound" profit from Winterveld.

Barplats is trading at R13,50, so the market values Vansa's 24% shareholding at R94m, or 270c a share — though Vansa's holding will decrease to 18,2% when the Barplats debentures are converted to ordinary capital on December 31 1992. Vansa's 340c share price therefore includes its vanadium and chrome interests at 70c — which seems low, alternatively, Barplats could be overvalued.

Several analysts still value Vansa's vanadium interest at R4 a share. Suggests Hever: "The market doesn't yet understand the nature of the Vansa deal."

Dave Edwards



217 Bldg 29/12/87

# A boom year for platinum mining

**PETER STACEY**  
Mining Editor

THE Platinum industry has seen a year of unparalleled activity, with the appearance on the horizon of half a dozen potential new mines, and a cosy market, dominated mainly through JCI's control of mineral sources, threatened.

Platinum and the other platinum group metals have a major industrial usage component and, as a result, prices might be expected to follow the cyclical variations in the world economies. While this tends to hold for Palladium and Rhodium for example, platinum shows a tendency (some analysts say irrationally) to follow the often volatile gold price.

The three existing producers, JCI's Rustenburg Platinum Holdings, Gencoir's Impala and Lonhro's Western Platinum Mines, all have expansion projects in the pipeline, and this, coupled with new entrants to the industry has sparked serious concerns on oversupply in the market.

Much of the platinum market's past volatility has hinged on a delicate balance between supply and demand. Early in the year JCI's Gordon Waddell, prior to his departure as the group's chairman, sounded a stern warning on the "boom or bust" nature of the industry and this was echoed by his successor Pat Retief.

Market worries notwithstanding, the JCI hierarchy was clearly chagrined that platinum newcomer Loucas Pourouls's Golden Dumps group

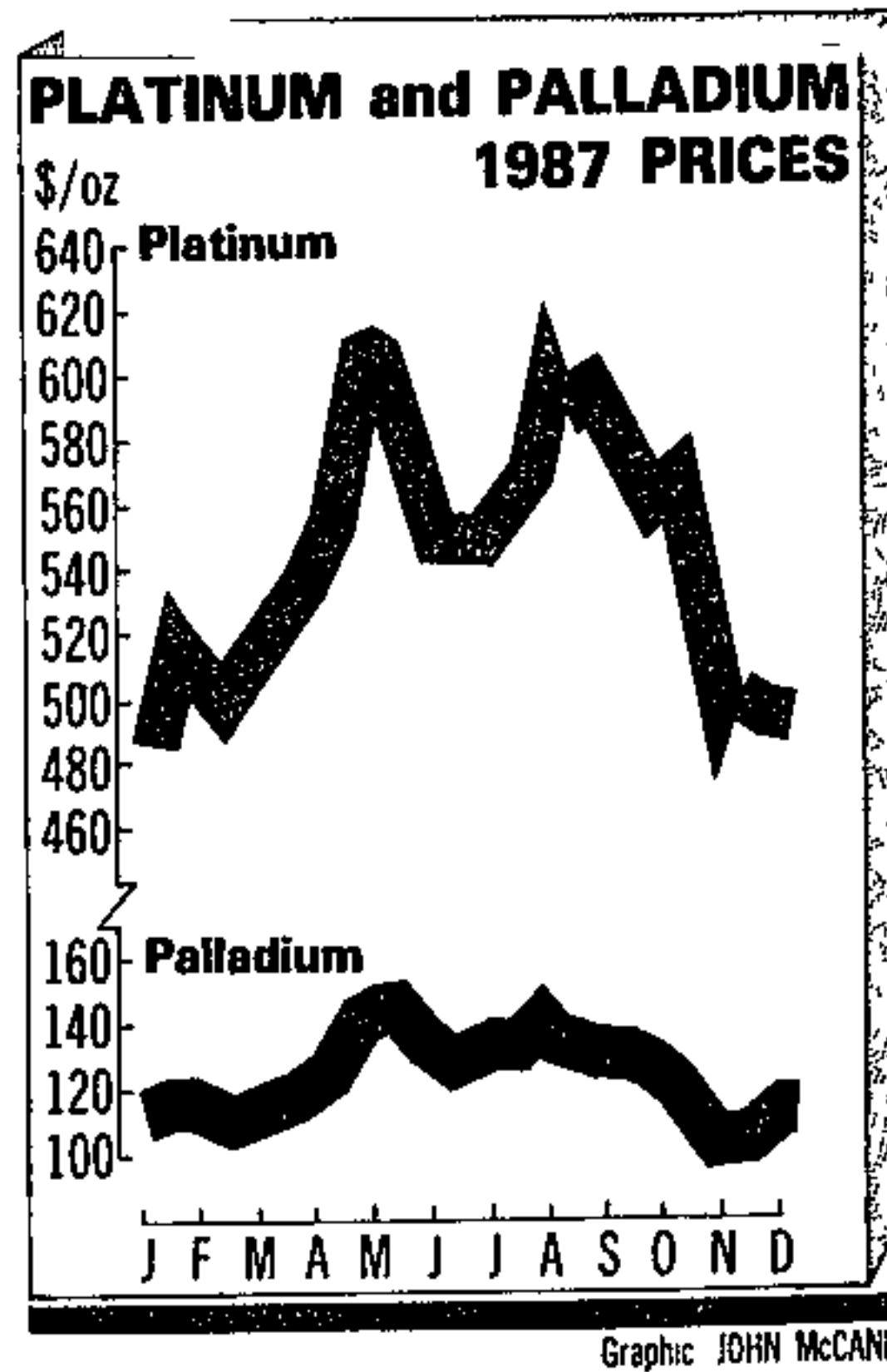

Graphic JOHN McCANN

not only planned to bring new metal to the market, but would mine some of it from ground RPM previously held under prospecting claims, and which the government had passed on to Pourouls.

Pourouls's Lefkochrysos, which is expected to cost about R253m, is well advanced in mining development, with access to the orebody by way of incline shafts from surface.

The decision to target the hitherto largely ignored UG2 platinum horizon came in for a high degree of criticism, mainly on the score of perceived metallurgical difficulties. Fears that the material could not be successfully treated have been discounted by the Council for Mineral

Technology (Mintek), which is a consultant for this and a number of other new platinum ventures.

Rand Mines and Vansa's Rhodium Reefs (now Barplats) project was given the go-ahead some months after Lefko, and with UG2 again the prime target, it reinforced the view that a major source of the metal had become available for exploitation.

While Lefko has the benefit of out-crop access to ore reserves, and hence a relatively short start-up time and low costs, mining at depth and the need to sink shafts has not discouraged Rand Mines from going ahead with Rhodium Reefs. In fact Gold and Platinum division chairman Clive Knobbs terms the venture technically sound and financially robust.

Messina, which has rights to a large, fairly high grade deposit near Zebediele, has begun "limited mining operations" and will build a pilot metallurgical plant. Some analysts however feel the Messina management are particularly cagey on their plans, and believe the deposit is not only of high grade, but also that Messina could be one of the first of the newcomers into production.

Other developments include Gold Fields' Northam Platinum mine, which was the first of the new crop of platinum producers to get under way, and the richest. Conversely, it is also the deepest and can expect to see other producers come to the market well ahead of it.

JCI's contribution to the growing JSE tally of platinum listings was its hiving off of Lebowa Plats, previously the Atok section of Rustenburg, where production is being increased. Lebowa and its nationals received a significant stake in the operation, which could be further expanded with the addition of the Maandagshoek deposit.

All round, the share market crash placed an end of year dampener on new developments. No new details have been published on Severin Mining's potential operation adjacent to Rhodium Reefs and Impala Platinum's R400m new Karree mine, which was announced in the wake of the crash, will await the new year, and hopefully a less disturbed market, for the evaluation of financing options.

The Rhombus/RUC possible platinum venture is currently on hold, awaiting the outcome of litigation on a mining lease application contested by Messina. Proceedings have been deferred to next year.



217 Bldg 29/12/87

# A boom year for platinum mining

**PETER STACEY**  
Mining Editor

THE Platinum industry has seen a year of unparalleled activity, with the appearance on the horizon of half a dozen potential new mines, and a cosy market, dominated mainly through JCI's control of mineral sources, threatened.

Platinum and the other platinum group metals have a major industrial usage component and, as a result, prices might be expected to follow the cyclical variations in the world economies. While this tends to hold for Palladium and Rhodium for example, platinum shows a tendency (some analysts say irrationally) to follow the often volatile gold price.

The three existing producers, JCI's Rustenburg Platinum Holdings, Gencor's Impala and Lonhro's Western Platinum Mines, all have expansion projects in the pipeline, and this, coupled with new entrants to the industry has sparked serious concerns on oversupply in the market.

Much of the platinum market's past volatility has hinged on a delicate balance between supply and demand. Early in the year JCI's Gordon Waddell, prior to his departure as the group's chairman, sounded a stern warning on the "boom or bust" nature of the industry and this was echoed by his successor Pat Retief.

Market worries notwithstanding, the JCI hierarchy was clearly chagrined that platinum newcomer Loucas Pouroulis's Golden Dumps group

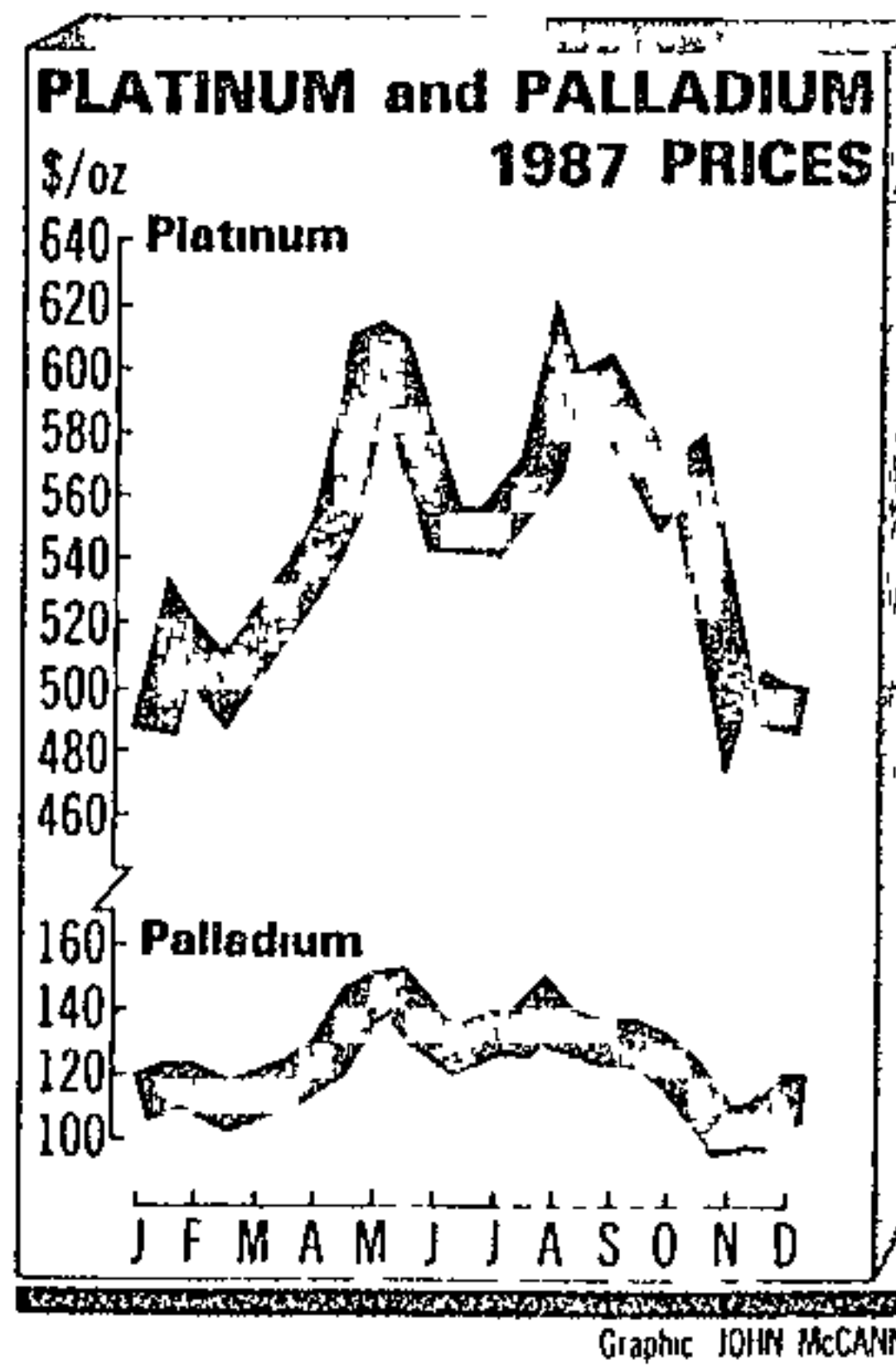

Graphic JOHN McCANN

not only planned to bring new metal to the market, but would mine some of it from ground RPM previously held under prospecting claims, and which the government had passed on to Pouroulis.

Pouroulis's Lefkochrysos, which is expected to cost about R253m, is well advanced in mining development, with access to the orebody by way of incline shafts from surface.

The decision to target the hitherto largely ignored UG2 platinum horizon came in for a high degree of criticism, mainly on the score of perceived metallurgical difficulties. Fears that the material could not be successfully treated have been discounted by the Council for Mineral

Technology (Mintek), which is a consultant for this and a number of other new platinum ventures.

Rand Mines and Vansa's Rhodium Reefs (now Barplats) project was given the go-ahead some months after Lefko, and with UG2 again the prime target, it reinforced the view that a major source of the metal had become available for exploitation.

While Lefko has the benefit of outcrop access to ore reserves, and hence a relatively short start-up time and low costs, mining at depth and the need to sink shafts has not discouraged Rand Mines from going ahead with Rhodium Reefs. In fact Gold and Platinum division chairman Clive Knobbs terms the venture technically sound and financially robust.

Messina, which has rights to a large, fairly high grade deposit near Zebediele, has begun "limited mining operations" and will build a pilot metallurgical plant. Some analysts however feel the Messina management are particularly cagey on their plans, and believe the deposit is not only of high grade, but also that Messina could be one of the first of the newcomers into production.

Other developments include Gold Fields' Northam Platinum mine, which was the first of the new crop of platinum producers to get under way, and the richest. Conversely, it is also the deepest and can expect to see other producers come to the market well ahead of it.

JCI's contribution to the growing JSE tally of platinum listings was its hiving off of Lebowa Plats, previously the Atok section of Rustenburg, where production is being increased. Lebowa and its nationals received a significant stake in the operation, which could be further expanded with the addition of the Maandagshoek deposit.

All round, the share market crash placed an end of year dampener on new developments. No new details have been published on Severin Mining's potential operation adjacent to Rhodium Reefs and Impala Platinum's R400m new Karree mine, which was announced in the wake of the crash, will await the new year, and hopefully a less disturbed market, for the evaluation of financing options.

The Rhombus/RUC possible platinum venture is currently on hold, awaiting the outcome of litigation on a mining lease application contested by Messina. Proceedings have been deferred to next year.

## Columbia link 'major move'

**LIZ ROUSE**

and growth potential will eventuate in a possible DCM listing under the group's guidance.

This will have a major impact on future earnings.

The main benefit of Techire's association with Columbia will be the extension of Columbia's investment banking activities through Techfin, a newly-formed division of Techire.

The Techfin division was launched with the acquisition of Columbia's wholly-owned subsidiary, Ethical Medical Industries, which markets pharmaceutical products, traditional medicines and allied products to black traders in rural areas, the

homelands and neighbouring states. The company is earmarked for a DCM listing.

Techire made strategic acquisitions in the past year — Draftcraft, Stanley Westerman Associates, Accounting Assignments, and the consumer collection bureau division of Information Trust Corporation (formerly Dun & Bradstreet) to form a new company, Advanced Credit Bureau.

Techire achieved a turnover of R2,2m and earnings of 5,93c a share in the year to September 1987, and paid a maiden dividend of 3c.

The shares are trading at a low of 45c, having shown no signs of recovery after the market crash. The stock peaked at 280c early in 1987.

th  
a  
re  
is  
ss  
or  
lt-  
co  
la  
1-  
p  
in  
1-  
in  
to  
og  
d