

MINING - GENERAL

1989

~~Wash~~

~~Wash~~

R2bn for listed JSE companies

S/Times 11/189

MORE than R2-billion was raised on the JSE in the first 11 months of 1988 — by existing listed companies.

Cynics had challenged the ability of companies to seek equity capital, but new listings remained abundant.

The largest amount ever raised in a single deal was by Fugit — now First International Trust (FIT) — which was the vehicle used to house the foreign interests of Donny Gordon's Liberty Life. Fugit issued 59,4-million shares at 815c each to raise R485-million.

Members of Liberty Life and Liberty Holdings also qualified for rights to FIT shares. FIT shares traded as low as 975c in November but are 1 160c now.

Platinum

Northam — Gold Fields of SA's developing platinum mine — offered shares on a one-for-one basis at R19 to raise R273-million. The share price has hovered close to R19 for much of the year. But nearly 90% of Northam is retained by GFS and Cons Gold Fields, so management was hardly concerned that the offer would not be well subscribed.

East Rand Proprietary Mines (ERPM) made a one-for-two issue at 1 650c a share, raising R91-million to finance expansion. The price dropped as low as 1 325c in February. When the pitch price was pinpointed by management, the shares were more than R29. The price is now 1 625c.

Defunct

Randfontein members were given rights to subscribe for shares in Barnato Exploration and in Lindum Reefs.

Barnex contains impressive mineral rights and R75-million was raised for their investigation. Lindum is the name given to the parts of the old Randfontein Estates mining area which are being reopened with the R30-million proceeds of the offer.

Gencor's Oryx gold mine — being developed at the site of the defunct Beisa uranium venture — raised more than R60-million at 800c a share though rights offers to Gen-

By Julie Walker

cor and Fedmyn members. Oryx shares dipped to 720c in June, but have rallied to 825c. They reached 975c early in December.

Nedbank financed its purchase of the SA Perm with a rights offer of 18 for 100 at R6 a share. A total of R168-million was raised, and Nedbank shares have since strengthened to R7.

Federale Volksbeleggings rights offer of one-for-four at 300c raised nearly R100-million for debt reduction and growth. Fedvolks is now 365c.

FSI Corporation members followed their rights in a sequence of offers. Top of the pile was FS-Group, which raised R26-million through preferred ordinaries at R3.

FS-Industries — now FSI Corporation — raised R40-million at 600c a share. Wacor raised R36-million at R14 a share, W&A R75-million at R35 and Hunts R113-million at R7.

Property

TSI (Technology Systems International) was listed through a rights offer to members of Reunert at 400c in which R187-million was raised. TSI is now 610c.

Property trust companies Capital Property Fund, CentreCity and Vetrust collectively raised R110-million.

In addition to the rights offers by these companies more than 40 new listings took place in the year, some of which raised capital and others merely applied to list. The spread was broad — from thoroughbred studs to rugby stadiums to independent homeland investments.

Agreement reached on mining package ⁽²¹¹⁾

AGREEMENT had been reached on a productivity package which would have far-reaching beneficial effects throughout the mining industry, the Chamber of Mines said yesterday

A spokesman said the agreement, signed with the Federation of Mining Unions — an umbrella body representing six artisan unions with almost 14 000 members — would create opportunities for artisans to earn more money

At the same time, by providing for

Business Day Reporter

the appointment of operatives and underground section electricians — new categories of employees on the mines — it would open the way for the industry to develop and make use of the skills of employees of all races who did not have the qualifications to become artisans

Operatives would assume responsibility for a broad range of routine tasks now performed by artisans

19/10/2011 15:17:57

Offshore market-maker numbers drop

THE number of offshore market-makers in SA mining stocks dropped dramatically in the second half of last year. *3/Day 5/1/89*

This has caused extreme concern to stockbrokers on the JSE.

The trend of offshore market-makers closing their SA desks was evident before but has gathered momentum in the past six months.

Activity in SA stocks dried up because of anti-SA sentiment.

Among offshore market-makers who have recently pulled out of dealing in SA stocks are James Capel, Ackroyd Warburg, Shepherd & Chase, Scrimgeour Vickers and T C Coombs.

The UK market used to be divided into jobbers and brokers until the Big Bang. At that time there were only two jobbers

MERVYN HARRIS

dealing in SA stocks, Ackroyd Warburg and Smith Brothers

Smith Brothers (now Smith New Court) are continuing to make markets in SA stocks.

Worrying *(210)*

Overseas fund managers, who want to invest in SA gold mining shares, no longer want political hassles so activity in these equities has fallen to a low level.

"The implications of the pullout for our market are worrying," said Peter Allen, senior partner of JSE stockbrokers Max Pollak & Freemantle.

"A bigger and more active market with many players makes it easier to trade in the shares and there is less

chance of market-makers getting their fingers burned

"As more market-makers pullout, the few left have difficulty in balancing their books."

With market-makers in SA stocks down to a few players the market is getting dangerously thin

Compounding the problem for market-makers with books in SA stocks is the fact they have to take a position on the financial rand — one of the most volatile currencies — and this makes it even harder to make a profit

Indicative of these problems is the wider spread of prices quoted by fewer market-makers in SA stocks.

The wider spread makes it easier for offshore market-makers to avoid getting hurt but it hits trading on the JSE.

210
6/1/89
Fm ML

RAND MINES

Ambivalent outlook

Activities: Mining group with major interests in gold, coal, base minerals, property and platinum

Control Barlow Rand owns 74% of the equity
Chairman and managing director. D T Watt

Capital structure. 11,21m ords of R1 each
Market capitalisation R919m

Share market: Price 8 200c Yields 5,5% on dividend, 17,9% on earnings, PE ratio, 5,6, cover, 3,3 12-month high, 9 000c, low, 4 500c Trading volume last quarter, 180 000 shares

Financial Year to September 30

	'85	'86	'87	'88
Investments				
Book value (Rm)	162	171	204	371
Market value (Rm)	318	425	671	611
Performance				
Attributable profit (Rm)	111	134	154	165
Earnings (c)	989	1 197	1 369	1 467
Dividends (c)	350	425	435	450
Net worth (c)	56,4	87,3	112,7	88,1



Rand Mines's Watt ... expects earnings to rise

Chairman Dammy Watt seems to be in danger of falling into a state of perpetual gloom and uncertainty. This is the second year he has reported difficult trading conditions for Rand Mines, and though he hopes the present year's earnings will be better than 1988's, his forecast is ringed with caveats.

Curiously Watt's ambivalent outlook is best illustrated by his comments on SA's political situation. In one breath he blames what he calls "misguided self-centred interference from abroad" for halting the government's reform process. In the next he warns fellow businessmen against ascribing all of the country's problems to outside political interference. It's symptomatic of the uncertainty faced by mining firms this year.

The main imponderable is coal, which continues to provide more than half of Rand Mines' attributable profit. Last year SA's exporters sold more than expected abroad as

other exporting nations failed to make contractual deliveries and buyers turned back to reliable SA. The swing back came too late to help the group's collieries — their exports slipped to 4,4 Mt in fiscal 1988 from 4,7 Mt a year earlier, and a larger drop was recorded in the non-Eskom inland market.

Sales to Eskom are cause for concern and optimism. The Khutala colliery made initial deliveries to Eskom's Kendal colliery last year and will lift sales to an annual 12,2 Mt by 1999. In contrast, Majuba colliery has been put on the back burner as Eskom has delayed commissioning of the power station's first generator by five years. Rand Mines wants some form of compensation as it has already spent R186m developing the colliery. While Majuba is on ice, there's precious little chance of other Eskom contracts being awarded.

As for coal exports, SA's exporters are reportedly demanding higher prices for 1989 delivery, but they are faced with deepening sanctions. Rand Mines' gold mines are an uninspiring bunch. Blyvoor is managing to mine some low-grade main reef to supplement the fast disappearing Carbon Leader, Durban Deep has slithered into losses and been forced to cut production, ERPM is nearing completion of its expansion project but is now faced with repaying a mountain of debt, and Harmony is suffering from progressively lower uranium sales.

The smaller gold operations are a different matter. Barbrook is on schedule, while the Central Rand and eastern Transvaal developments managed in conjunction with Rand

Mine Pröps are weighing in with gold production. At the same time there is little sign of an early start to developing new mines. Deep exploratory drilling to the south of Johannesburg continues slowly, while additional work is needed before any decisions can be taken on new mines in the eastern Transvaal.

The group got lucky, unlucky and lucky again with its platinum ventures last year. First it found reserves on the De Goedeverwaching farm, planned as an extension to Barplats' Kennedy's Vale mine, were more extensive than originally expected. Delight was quickly tempered when it transpired the reserves were deeper, and therefore far more costly to mine, than first believed.

The dilemma was solved when the mismanaged Lefkochrysos platinum development was acquired from Golden Dumps. At present Barplats is withholding final payments to Loucas Pouroulis's company, but the acquisition has allowed the group to defer expenditure on expanding the Barplats mine and should allow it into the platinum market this year. Still, there will be no income from platinum this year, and it is likely to be slow to build up in fiscal 1990.

It's a different story at the group's two chrome mines and Vansa, the 42%-owned vanadium producer. The chrome mines are selling all they can pull out of the ground with strong demand from local ferro-chrome producers. And Vansa starts producing vanadium pentoxide early this year and could pay a dividend of as much as 40c at year's end. Rand Mines, then, might count on dividend income in the region of R5m from Vansa this year.

The platinum and vanadium interests remain comparatively insignificant and investors continue to believe their contributions are outweighed by the less attractive coal and gold outlooks. Watt expects earnings to rise this year, though understandably he does not quantify the expected increase. At best this year's dividend could rise to 475c, putting the share on a forward yield of 5,7%. The share is rated more cautiously than those of the other houses and there is little reason to expect an early rerating.

Jim Jones

COAL'S STILL KING

	Rm	%	Rm	%
Gold, uranium, platinum	25,8	16,8	31,9	19,4
Gold from residues	12,6	8,2	17,7	10,8
Coal	79,9	52,1	89,0	54,1
Base minerals	3,3	2,1	3,3	2,0
Forestry and timber	2,1	1,4	2,6	1,6
Property	3,4	2,2	3,6	2,2
Management, financial services, exploration investment realisation and sundry	26,4	17,2	16,4	9,9
Attributable profit	153,5	100	164,5	100

R M PROPS

Rising capex

Ironically, RMP's first year listed in the mining finance sector has seen the best profits from property since the boom years of the early Eighties. Still, that's no reason to criticise the listing move. Chairman Dammy

Van Rensburg says a feasibility study is under way on the future of the mine and, until it is completed, he cannot be specific on the total workers to be retrenched or what plan the mine will adopt. Underground mining at W R Cons is largely based on reclaiming pillars from previous operations while the mine is already taking some 144 000 t/month off surface sand dumps amounting to 32% of its total monthly throughput.

Van Rensburg describes W R Cons' situation as "serious" while he says the other Gencor marginal mines which he runs — Marievale and Grootvlei — "are walking a tightrope."

Bracken and Leshe, two other Gencor marginals, are in the same boat. Leslie chairman Gary Maude says in the annual report the mine will cut throughput in the 1989 year to match production levels to dropping ore reserves. "The ore reserves and development figures indicate that, at the current cost to gold price ratio, net reserves are declining. If this continues, profitable operations will not extend beyond a few years," he says.

On Bracken's prospects Maude says: "At best the mine is expected to continue for the next few years at a reduced milling rate while maintaining recovery grade"

Brendan Ryan



Mervest's Walsh . . . long-term improvement

months Mervest has deployed half its fleet — five shallow-water boats and one deeper-water boat — to the area. Expenses and profits will be shared equally by the two parties.

It is understood that since October, when the agreement became effective, 8 000-9 000 carats have been extracted from the area, more than Trans-Hex extracted from it in the previous few years. This compares with Mervest's total production of 17 327 carats last year. It is understood that despite better weather this year Mervest fared rather poorly in its other operations in its year ending December. But the 5(a) pickings should mean it will report fair results.

The stones being extracted from 5(a) probably account for the recent rise in Mervest's share price from around 15c in October-November to about 24c. After numerous disappointments in the past, Mervest chair-

man Jack Walsh is cautious. He believes after its "lucky beginning," the area will provide good "bread and butter" income in future. Nevertheless, as 5(a) is opposite De Beers's rich Kleinzee (onshore) diamond mine it has always been regarded as rich.

Trans-Hex has been unsuccessful in its offshore operations. All its concessions are in the shallow "a" zone, more easily exploited than those in deeper water. Trans-Hex chairman Francois Hoffman said in his review for the year ending March that the group's policy regarding marine operations was under review "because of cost considerations."

The agreement with Mervest is in line with this, as is Trans-Hex's agreement with listed Broadacres, announced in November. Broadacres has concessions further south near Doringbaai. Its agreement allows it to extract diamonds from Trans-Hex areas contiguous to its own areas on a royalty basis.

The agreements should boost the operations of both Mervest and Broadacres long-term. Both have been picking the eyes from their existing areas, and the reserves in shallower areas must be somewhat depleted. Mervest, the most successful offshore operator so far (although even its profits have been modest), has pioneered extraction in the deeper "b" zone. Mervest initially lost heavily on its high-cost deeper-water operations, but Walsh says they are now approaching break-even. He expects a long-term improvement in the practicality of offshore diamond recovery rather than a sudden breakthrough.

Meanwhile, the boats of troubled Loucas Pouroulis's Dawn Diamonds have reportedly been withdrawn from the company's 5(b) concession area. Latest events on the west coast emphasise again the difficulties of offshore diamond mining.

Teigue Payne

MERVEST

Good beginning

The agreement by which Mervest is conducting offshore diamond recovery in Trans-Hex's 5(a) concession area has apparently resulted in high recoveries in its first three

UNIT TRUSTS

High/low since 1 1 88	Annual dividend cents		Price Dec 23	Price Dec 30	Yield on repurchase price %	High/low since 1 1 88	Annual dividend cents		Price Dec 23	Price Dec 30	Yield on repurchase price %				
General equity funds															
1282,21	906,22	53,28	Guardbank	Selling price	1261,84	1282,21	4,45	274,36	230,24	17,50	Sanlam	Selling price	255,11	257,53	7,27
1195,77	844,31		Repurchase price	1176,82	1195,77		255,82	215,57			Dividend	Repurchase price	238,60	240,86	
127,39	102,26	5,26	Lifegro	Selling price	125,34	127,39	4,43	695,06	490,27	21,20	Sanlam	Selling price	683,33	687,38	3,31
118,70	97,79		Repurchase price	116,78	118,70		646,97	455,72			Index	Repurchase price	636,12	639,88	
109,43	92,35	*7,50	Metfund	Selling price	108,64	109,43	7,32	490,97	378,61	17,30	Sanlam	Selling price	481,75	490,97	3,78
102,41	86,90		Repurchase price	101,67	102,41		458,11	353,03			Industrial	Repurchase price	449,54	458,11	
549,75	498,45	9,28	NBS Hallmark	Selling price	547,28	549,75	—	227,89	180,64	10,30	Sanlam	Selling price	223,95	224,87	4,90
511,06	463,11		Repurchase price	508,76	511,06		212,97	168,33			Mining	Repurchase price	209,34	210,21	
228,32	199,87	3,42	Norwich NBS	Selling price	225,06	228,32	—	111,06	99,89	—	Southern	Selling price	108,39	109,89	—
212,21	185,70		Repurchase price	209,19	212,21		102,92	92,54			Mining	Repurchase price	100,46	101,85	
1501,58	1118,16	61,98	Old Mutual	Selling price	1488,58	1495,31	4,46	227,05	171,45	11,62	Standard	Selling price	189,65	190,24	6,54
1395,05	1044,81		Invest	Repurchase price	1383,08	1389,36		212,11	160,05		Gold	Repurchase price	177,01	177,55	
1301,63	959,72	54,20	Sage	Selling price	1286,91	1277,42	3,95	268,32	207,64	13,09	UAL Mining & Resources	Selling price	262,91	266,23	5,27
1211,59	895,46		Repurchase price	1201,04	1191,68		250,25	188,47			UAL Select	Repurchase price	245,24	248,36	
895,96	731,24	42,20	Sanlam	Selling price	882,91	895,96	5,04	993,09	847,85	53,24	UAL Select	Selling price	949,10	993,09	5,77
837,70	681,77		Repurchase price	825,55	837,70		922,64	812,41				Repurchase price	881,78	922,64	
108,85	100,00	—	Southern	Selling price	106,70	108,85	—				Income/gilt funds				
100,89	92,75		Repurchase price	98,89	100,89		107,41	101,82	13,93	Corbank	Selling price	105,46	101,82	13,82	
664,97	515,61	31,28	Standard	Selling price	660,52	663,93	5,03	107,13	100,74		Gilt	Repurchase price	104,34	100,74	
622,51	483,54		Repurchase price	618,43	621,61		113,23	103,14	13,67	Guardbank	Selling price	111,59	111,89	12,37	
123,84	93,31	5,29	Syfrets Growth	Selling price	121,14	123,84	4,59	110,47	102,05	12,60	Sanbank	Selling price	95,63	95,81	13,29
115,34	87,20		Fund	Repurchase price	112,90	115,34		98,55	86,14		Repurchase price	94,62	94,80		
1094,19	787,27	46,12	UAL	Selling price	1078,91	1089,66	4,54	97,51	85,24	12,59	Sanbank	Selling price	95,29	95,46	13,33
1019,09	733,74		Repurchase price	1004,92	1015,07		98,16	85,46		Gilt	Repurchase price	94,29	94,46		
Specialist equity funds															
110,29	76,29	5,53	Guardbank	Selling price	107,61	108,28	5,47	90,61	85,20	10,03	Standard	Selling price	89,11	89,36	11,36
102,92	71,31		Resources	Repurchase price	100,40	101,02		89,53	84,16		Income	Repurchase price	88,07	88,32	
228,50	181,85	10,53	Old Mutual	Selling price	221,59	222,40	5,10	105,89	102,05	—	Syfrets	Selling price	105,57	105,89	—
213,32	169,78		Mining	Repurchase price	205,92	206,67		103,74	100,01		Income	Repurchase price	103,43	103,74	
94,14	71,16	4,70	Sage	Selling price	92,05	91,06	5,54	1100,17	1017,97	124,38	UAL Gilt	Selling price	1060,22	1062,22	11,83
87,79	67,71		Resources	Repurchase price	85,86	84,91		1089,18	1007,65		Repurchase price	1049,62	1051,60		

* Annualised

510 20 FmML
6/1/87

tle up Governor Gerhard de Kock as a witness or perhaps members of the London and Zurich bullion market to explain the facts of life to the MMC. But Minorco is not being put off. It is fully sympathetic to the reality that given the politically-charged nature of the inquiry the MMC had no alternative but to cover every angle.

In any case, it seems, Minorco was not caught off guard by the widening of the MMC's deliberations. The "letter" was in fact a formal agenda sent to all parties concerned several weeks ago. Minorco went into this week's hearings well prepared. As director Roger Phillimore said, the questions did not imply a judgment. And though CGF's share price dipped 37p to £12.52, on the press-fed speculation it was comfortably within reach of the value of Minorco's equity-cash package worth £12.63 — in spite of a lacklustre gold price and generally weaker equity market.

John Cavill

6/1/87

MINORCO/CONS GOLD

Wide brief

Minorco has quickly put paid to any notions that the breadth of the Monopolies and Mergers Commission (MMC) inquiry into its bid for Consolidated Gold Fields (CGF) might force it to retire from the battlefield. Ahead of this week's hearings of evidence by the commission in London, the British financial press published leaks of a letter to both Minorco and CGF outlining 29 points which the MMC was looking at.

This went far beyond the original general remit by Trade and Industry Secretary Lord Young, which had specified only the possibility of a monopoly situation arising in the rare earths, zircon and titanium. The suggestion in the London papers was that the MMC letter amounted to a sudden shifting of the goalposts aimed at finally deterring Minorco from going ahead.

Interestingly the leak came after a massive advertising campaign by CGF, extolling the virtues of its operations and its future promise, which suggested that chairman Rudolph Agnew was taking nothing for granted while waiting for the MMC's report later this month.

The scope of the "letter" was formidable: the hoary notion that somehow a merged Minorco-CGF would enable Anglo/De Beers to exercise power over the world gold markets, the diamond cartel, the degree of Minorco's independence from 44 Main Street now and after the takeover, even the question of "the previous limited success of SA enterprises abroad."

And in a purely political context it raised the issues of what might happen to CGF interests in the US, UK and Australia if Minorco's SA connections made them the target of intensive anti-apartheid campaigns. Would it, for example, reduce the business of ARC (Amey Roadstone), the crushed stone and aggregates operation, to the extent that its rival in the UK, Tarmac, would willy-nilly be put in a dominant market position?

Given that the Reserve Bank sells all SA gold, it might have been appropriate to whis-

Anglo refers to code of conduct

210
11/1/87
Sowetan

ANGLO American yesterday responded to National Union of Mineworkers' allegations of "repression" by AAC by referring to a code of conduct which had been proposed to NUM.

Anglo's response follows a 178-page "research report" conducted by NUM which reveals alleged reports of "intensified repression" on the company mines.

The report is based on a survey at Anglo mines and the findings include allegations that "Anglo has embarked on a systematic campaign of retarding the union and intimidating union members"

It also argues racism and job reservation "remain a central experience of the corporation's employees"

An Anglo Press statement — issued ahead of a Press briefing to be held the corporation yesterday — refers to a set of rules proposed by the company during the 1987 miners' strike which would "both protect union and worker rights and prevent violence"

• In the post-strike agreement signed in March 1988, both AAC and NUM, undertook to negotiate a code of conduct to achieve this purpose

UAL reduces liquidity in trusts

8 Jan 11/1/89
Finance Staff

UAL has announced that its Unit Trust's distribution for 1988 was 10 percent up on the previous year at 49,36 cents a unit. The distribution for the last quarter was 10,73 cents

It said liquidity was reduced in the last quarter as holdings in Nedbank

and Barlows were increased

During the quarter UAL Mining and Resources trust, which focuses on rand-hedge investments, added to its holdings of Palaborwa, Lebowa Plats, Consolidated Metallurgical Industries and Sasol in order to place more focus

on underlying commodities

For the quarter, the fund is distributing 3,07c a unit. This brings the total for the year to 13,65c

UAL Selected Opportunities, reduced liquidity by 11 percent as a result of rationalisation

● Norwich NBS unit

trust increased its equity content from 31,7 percent to 64 percent over the past quarter

The fund's unit price rose 12,1 percent, largely due to a focused performance orientated investment portfolio, enhanced by the addition of certain high growth smaller companies

LIZ ROUSE

UAI trusts increase holdings in key stocks

UAI Management Company consolidated its holdings in key stocks in the December quarter and increased total equities and assets in its four funds.

Total assets of the largest of the four funds, UAI Unit Trust, increased to R240m from R218,6m at the end of the September quarter.

The liquidity percentage was reduced to 12,81% from 13,3%, but the amount increased to R30,75m from R29,1m at the end of the September quarter.

Holdings in Nedbank and Barlows were increased.

Barprop loan stock was sold and the stake in Plate Glass was reduced.

UAI Unit Trust's top holdings are An-

amount, JCI, Pick 'n Pay, Anglo, Rusplat, De Beers, Nedbank, Sasol, Vaal Reef, with Liberty, NEI and Sunbop tying in tenth place.

With the latest quarterly distribution of 10,73c a unit, the Unit Trust's distribution for the 12 months of 49,36c a unit is 10% higher than the previous year's distribution.

UAI Mining and Resources reduced its liquidity to 17,98% (R36,27m) from 22,13% (R39,7m) at the end of September and total assets rose to R201,8m from R179,4m.

The trust, which has its focus on random hedge investments, added to its hold-

ings of Palamin, Lepiat, CMI and Sasol to place more focus on the underlying commodities.

The holdings in Lefko and Randex were reduced.

The top ten investments at the end of the December quarter were Anglovaal loan stock, JCI, De Beers, Anamnt, Rusplat, Anglo, Anglovaal A, Palamin, Gencor and CMI.

The fund is distributing 3,07c a unit for the quarter, which makes its total distribution for the year 13,65c a unit.

UAI Selected Opportunities Unit Trust reduced liquidity to 11% (R5,4m) from 15,48% (R7,15m) at the end of September.

Considerable rationalisation took place during the December quarter.

New holdings in Siltek and Walhold were introduced, while stakes were increased in GDM Finance, Time Holdings, FS Group, SA Bias, Solid Doors, Strebel, Control Instruments, FS Team, Clyde, Toyota, Gresham, Tongaat and Lion Match. Anglo, Wit Deep, Placor and Joshua Doore were sold.

The fund's managers believe that in 1989 many of the smaller companies represented in the portfolio will begin to follow the price recovery of the larger listed companies, which started in 1988.

UAI Selected Opportunities' portfolio

assets increased to R54,7m from R46,2m.

Top ten holdings were JCI, I & J, Rusplat, CNA Gallo, FirstBank, Toyota, ICS, Laser Transport, Siltek and SA Bias.

While UAI Gilt Unit Trust reduced liquidity during the quarter, cash holdings remain high — 50,86%, or R32,26m, of its total assets of R63,44m.

The reason for the high liquidity is that the opportunity cost of not being invested in the long end of the market is reduced substantially as the yield curve flattens.

The fund's strategy has been to move to longer-dated investments.

1210

~~210~~

~~1210~~

Star 11/1/89

Code of conduct the hub of Anglo, NUM dispute

A code of conduct proposed by the Anglo American Corporation (AAC) is threatening relations between the giant mining house and the National Union of Mineworkers (NUM).

Anglo says the code would provide the most constructive mechanism by which investigations could be carried out by joint AAC/NUM committees, while the NUM accuses management of attempting to roll back gains made by the union.

Anglo says:

In its statement, Anglo says it has proposed a code of conduct which will regulate the behaviour of management, the National Union of Mine Workers (NUM) and employees, to eliminate violence.

The statement says despite the existence of channels and procedures to resolve differences, violence and conflict have occurred in certain instances.

The principles of the code, it says, are to hold parties to the agreement accountable and responsible for the actions of their officials, representatives and members.

It will also ensure all steps available, individually and collectively, will be taken to ensure that all persons acted at all times in the interests of industrial peace.

Other principles of the code are:

- Parties will at all times seek to uphold and protect the individual rights of workers, including freedom of association and the individual's freedom to work either when a strike may have been called, or to take part peacefully in a lawful strike.

- Parties will not promote or support the use of unlawful actions including threats or any form of violence, coercion or intimidation. Both parties will work constantly to prevent the occurrence of any such act.

- The parties acknowledge that in the event of a lawful strike, lock-out or any other form of industrial action, management,

employees and union representatives should ensure certain facilities, such as hostels and canteens, are maintained.

NUM says:

The National Union of Mineworkers (NUM) has released the results of a survey carried out on 13 gold and nine coal mines administered by Anglo American, which, the union says "unmasks Anglo's claims to be a model of civilised labour practices".

The union said the report showed that despite the continued existence of "limited collective bargaining processes, workers were experiencing a climate of repression and control so severe that, in many respects, conditions are as bad, or even worse than in the period prior to unionisation".

"Workers question Anglo American's projected image of itself as a model for future negotiated reform in South Africa. While Anglo at both local and national level will deny its in-

attention is to destroy the NUM; it is clear the union is being restricted and repressed," the NUM said in a statement yesterday.

In the latest issue of *NUM News*, the NUM says the survey revealed "widespread complaints by black mineworkers" at Anglo mines. The feeling of workers, says the NUM, was that "good industrial relations ended with the 1987 strike". The union adds that at Anglo mines "the very survival of the NUM is threatened".

In an article headlined "How Anglo Rules The Mines", the NUM accuses the mining giant of practices including mass retrenchments, assaults of workers by mine security, the banning of union meetings, forcing workers to work in unsafe places, the derecognition of the NUM, barring union officials from mine premises, the proscription of "workers' songs" and housing workers in overcrowded compounds.

Tighter restrictions had allegedly also been placed on workers' movements in and out of hostels.

Star 11/11/89



210



'Whites only' war rages between Anglo and CP

By Esmaré van der Merwe, Political Reporter

The reintroduction of "whites only" signs in three municipal parks in Carletonville has led to a war of words between Anglo American Corporation, a major employer in the area, and the chairman of the town's Conservative Party-controlled management committee, Mr Koos Nel

The National Union of Mineworkers (NUM) has also entered the row, challenging Anglo to cut ties with Mr Nel who has a large business contract with an Anglo mine in the area

A spokesman for Anglo yesterday said it was considering having talks with the town council

CHALLENGED

He could not say whether the contract with Mr Nel would be reconsidered in the light of the town's return to petty apartheid. He said the Corporation would rather take up the issue with a town council than with individuals

Mr Nel lashed back and chal-

lenged Anglo to put a stop to discriminatory practices at its two mines in the area, Western Deep Levels and Elandsrand

NUM general-secretary Mr Cyril Ramaphosa said the union would approach Anglo shortly to discuss the corporation's links with Mr Nel

Anglo says:

Anglo American Corporation and its associates are committed to equal opportunity in the workplace. For this to be meaningful, it must be accompanied by a move away from racial discrimination in the communities in which employees live

The Corporation will continue to use all avenues of constructive influence to assist local authorities, irrespective of their political persuasions, to continue to move in this direction

Where local authorities appeal to the Corporation for assistance and support, the Corporation requires that such assistance and support be applied in a non-discriminatory way

Non-racialism can only be partly effective if it is practised in a community free of racial

discrimination

The Corporation will sit down and talk with local authorities with which it has a problem. Discussions concerning Carletonville's town council's retrogressive move are about to be considered

As far as the NUM is concerned, we are more than prepared to hold discussions with the union regarding the interests of our employees

Mr Nel says:

Anglo should practise what it preaches. Discrimination is rife at the Corporation's two mines in the area, Western Deep Levels and Elandsrand

It has built a wall around the white residential area on Western Deep Levels Mine to keep the black mineworkers out

At Elandsrand, security gates have been installed for the same purpose — to prevent blacks living in the hostels from entering white residential areas

And why does Anglo not act against the Government whose policies differ enormously from its own?

The white residents of Carletonville are happy about the

measures the council has taken at three municipal parks where littering and vagrancy have been reported before. That situation has been rectified, much to the satisfaction of the residents

Carletonville's residents voted in the present council by a two-thirds majority. All the candidates stood under the official CP banner, and we have to fulfil our promises to the electorate

Anglo does not govern Carletonville, but the council is prepared to discuss the issues with Anglo

NUM says:

It is surprising that Anglo appears to be retaining its contract with Mr Koos Nel

Anglo must merge words with deeds if it is to be believed to be the liberal organisation as is publicly projected

The NUM views the measures taken by Carletonville's council in a serious light as it has a large membership in the area

The municipal facilities must be made available to all communities without discrimination

Carletonville will cease to exist without the labour of black mineworkers

Deaths

Deaths

Funeral Notices

and the executive must

Star 11/1/89 (210)

By Mike Siluma, Labour Reporter

The National Union of Mineworkers (NUM) yesterday accused Anglo American Corporation of "sidelining" the issue of worker repression by blaming workers for mine violence.

The union was reacting to a statement by Anglo, detailing incidents of violence on group mines over a 30-month period from April 1985, which claimed 80 lives.

Anglo said the step was taken after the union made allegations that management was placing unreasonable restrictions on activities.

The corporation called on the NUM to accept a proposed code of conduct

Anglo is 'sidelining' issue of worker repression — NUM

drawn up by it after the 1987 strike. The code of conduct provided "the most constructive mechanism by which (the union's) unsubstantiated allegations can be investigated", said Anglo.

Rejecting Anglo's stance, the NUM said Anglo was negotiating "through the press by releasing the contents of the code before a meeting planned for February".

"The issue of violence has to be seen against the larger context of apartheid. Migrant labour is a form of institutionalised violence," said the NUM.

Simultaneously, the NUM released to the media the findings of a survey it carried out at 13 gold and nine coal mines administered by Anglo, titled "Collective Bargaining at Anglo American Mines — A Model for Reform or Repression?"

The survey, the NUM said, found that control on Anglo mines had been intensified since the 1987 wage strike. "The rights to representation won by the union prior to the strike have been systematically reduced."

Anglo's industrial relations and public affairs consultant, Mr Bobby Godsell, said. "The allegations are based on statements by workers which have not been substantiated. It will be a problem to respond to some of the allegations when no time or place is given."

Mr Godsell said a full response would be given to the NUM at the meeting on January 19.

● See Page 5.

ANGLO American, acknowledged, yesterday its mines had

Anglo admits meetings banned

B/Day 12/1/89 (210)

BRONWYN ADAMS

banned some union meetings and videotaped or recorded others, restricted union facilities and searched hostels for illegal firearms.

The company was reacting to the National Union of Mineworkers' (NUM) challenge to Anglo to respond to this week's NUM report on conditions on Anglo mines.

NUM spokesman Marcel Golding accused Anglo of trying to cast a smokescreen over the "real" issues of its "repressive" labour relations practises by holding a Press conference two days ago on the joint code of

conduct for Anglo mines — a matter that was not in contention.

An Anglo spokesman said some union meetings were banned or taped as management had reason to believe emotive language would be used and issues raised leading to possible violence.

He said union facilities had been reduced as Anglo's laissez-faire approach had been abused.

Golding challenged Anglo to respond to the report's allegation of

assaults on workers by management, together with widespread restrictions on union activities, which had resulted in the de-recognition of the NUM on at least five Anglo mines.

The Anglo spokesman denied the NUM had been de-recognised.

He responded to the allegations of assaults by challenging the union to provide details.

Golding said the code of conduct was not in contention as the union had agreed after the 1987 strike to negotiate a code.

fronten business-
solino. — Sapa.

... was "a bit down".

"I'm taking about R4 000 a day

CP councillors have mine links

B/day 12/11/81
EDYTH BULBRING

HALF of the councillors in the Carletonville CP town council, which has introduced "whites only" signs in its park, have strong employment ties with mining companies in the area, management committee chairman Koos Nel said yesterday.

Nel also said a partner in his business, which has a contract with Anglo American, was Carletonville mayor Gert Jacobs. The two own Mooituin Garden Enterprises which has a large contract to tend gardens at Anglo's Western Deep Levels mine.

And Councillor Frank Swanepoel said he worked as a stoper for Goldfields' West Driefontein Mine and was a shaft steward for the Mineworkers Union. Councillor Henry Dednam was a night shift cleaner for Anglo's Elandsrand mine, he said.

Local authorities

Councillor Erik Meyburgh, a dentist, is employed by the Mines Benefit Society (MBS), a medical aid scheme for white miners. The Chamber of Mines subsidises the MBS by 50%.

An Anglo spokesman reiterated the corporation's position regarding its connections with the CP councillors. He said the corporation was concerned with the practices of local authorities and not with specific individuals serving on those local authorities.

He could not say what action, if any, would be taken against those CP councillors in business or employment relationships with Anglo.

Why the AAC restricted meetings

Anglo American Corporation outlines its reasons for imposing conditions on the holding of National Union of Mineworkers meetings on Anglo premises

Reacting to the NUM report, an Anglo American Corporation spokesman confirmed that there had been a "general tightening up on conditions governing the holding of meetings by the union on AAC premises"

He said this had been because at a number of meetings things had been discussed in "provocative language" that had served to divide employees, sometimes violently

This was also why union meetings were video recorded and photographed

AAC felt it had the responsibility to protect all employees living and working on its premises. If the union had problems with specific actions taken it should document these in some detail, where they took place when and by whom, etc. These could be discussed jointly in terms of an agreed code of conduct

He said the NUM had only been de-recognised at the President Brand mine, after the whole branch committee was found guilty of culpable homicide and imprisoned for the killing of a team leader, following the 1987 strike. Even then, he said, the de-recognition of the committee "was not tantamount to the de-recognition of the union". The union had subsequently been re-recognised again at the mine

Shaft stewards had also only been de-recognised at President Brand

Allegations of victimisation of former shaft-stewards and union members, including assaults

Star 13/1/89
by superiors, were unsubstantiated and unattributed, said the spokesman. The same applied to claims that workers had been threatened with physical violence and dismissal

AAC was willing to investigate and discuss specific incidents with the NUM in accordance with an agreed code of conduct, if the union could provide details

While it was not common practice to ban meetings, this would have been done where "management had good reason to believe that matters for discussion, and the terms in which they were to be discussed, could divide employees, possibly violently"

Denying that union office facilities were removed, the spokesman said these had, in some cases, been re-located outside hostels because there had been cases "where office facilities inside the hostels had compromised order and the safety of residents"

Kangaroo court

For example, at Vaal Reefs No 8 during the strike, the union office was used for kangaroo court action against employees

On allegations that workers were discouraged from NUM membership, the spokesman called on the NUM to provide details of specific instances, which would be investigated

General security had been tightened up "to ensure the safety of all employees in the face of a pattern of violence prevailing between 1985 and 1987," said the spokesman

He referred to a statement released by the corporation earlier this week, in which AAC stated its belief "that all workers have the right to join or form unions of their choice, to bargain collectively and to strike peacefully"

Dismal portrait of relations at post-strike Anglo

Star 13/11/89

A new research report released by the National Union of Mineworkers (NUM) paints a gloomy industrial relations atmosphere on Anglo American mines in the post-1987 strike period. The report blames this on "management's desire to repress and restrict the union".

The report, titled "Collective Bargaining at Anglo American Mines - A Model for Reform or Repression?" and released this week, accuses Anglo mine management of a series of steps taken against the union since the strike, which violate industrial relations guidelines laid down by the International Labour Organisation (ILO).

The investigation was carried out by the union's research department and the academic research group, the Community Resource and Information Centre, at nine coal and 13 gold mines owned by Anglo. All the gold mines had taken part in the strike, while collieries had participated to varying degrees. The union was recognised at all the mines.

Shopfloor relations 'worse'

The results of the survey suggest a dramatic deterioration of shopfloor relations between the union and management in the aftermath of the strike.

According to the report, Anglo mine management has, since the strike, withdrawn recognition at five of the gold mines concerned. This had led to:

- Prevention of shaft stewards representing workers in dismissal and grievance cases
- Intense levels of victimisation of union members and former shaft stewards
- The intimidation of members through threats of physical violence and dismissal
- A refusal to allow union branches to hold membership meetings
- The prevention of shop stewards from visiting living quarters to recruit members.

A report released by the National Union of Mineworkers (NUM) this week points to a marked deterioration in relations between the union and Anglo American management in the wake of the 1987 wage strike. Labour Reporter MIKE SILUMA reports

- The tightening of security measures and controls on workers' movements in living quarters
- The withdrawal of union office facilities (in violation of ILO Convention 135, which requires that such facilities be made available to worker representatives). On the collieries, only one colliery was found to have withdrawn such facilities. At another six mines, telephones had been removed from offices.

In addition, researchers found that shaft stewards had been de-recognised at five gold mines, with stewards being given only "observer status" at another two.

The recognition of shaft stewards had also been withdrawn at three collieries, while restrictions were placed on stewards at four coal mines.

According to the report, gold mine managements were now actively involved in discouraging workers from joining the NUM by intimidating them with mine security forces, distributing anti-union pamphlets and urging workers to resign from the NUM. (This violated ILO Convention 87, providing for freedom of association.)

Even where the union had not been de-recognised, workers' meetings were closely monitored.

The report concludes that "while Anglo management would deny that their intention is to destroy the NUM, it is clear that the union is being restricted and repressed to regain the uncontested control over the mines which (managements) enjoyed before the union emerged".

Imbalance in mines' profit sharing claimed

A claim that an imbalance existed in the sharing of South African mine profits was made yesterday by the chairman of the Transkei Military Council, Major-General H B Holomisa

He said black homelands were supplying most of the labour, but benefits were going to only a few

General Holomisa and senior Transkei government representatives yesterday completed a fact-finding tour of

the South African mining industry. They had been invited by the Chamber of Mines *Star 18/1/84*

The party met representatives of the chamber, the Employment Bureau of Africa and of the black mining labour force

General Holomisa said his government and the chamber would hold talks aimed at stemming faction fighting in the mining industry — Sapa

210

Crucial congress for MWU

ALAN FINE

212
14
127
210
8/Day 19/1/89

THE whites-only Mineworkers Union (MWU) is to stage its most crucial annual conference in recent years next week, with strategies for countering the employment of qualified black miners topping the agenda.

The first black miners acquired blasting certificates late last year after amendments to the Mines and Works Act, and at least 17 have since been deployed underground.

Negotiations between the MWU and the Chamber of Mines on the issue — with the MWU seeking extensive safeguards for members' job security — have not been concluded.

MWU general secretary Peet

Ungerer declined to detail the options to be considered. However, sources believe the union is likely to bring one or more court actions, alleging that mining companies acted unfairly and/or contravened agreements between the MWU and the industry.

These agreements, negotiated when job reservation was in force, do not address the new circumstances. The closed shop agreement requires that blasting certificate holders employed on chamber mines be MWU members. At issue would be whether this applies to whites only.

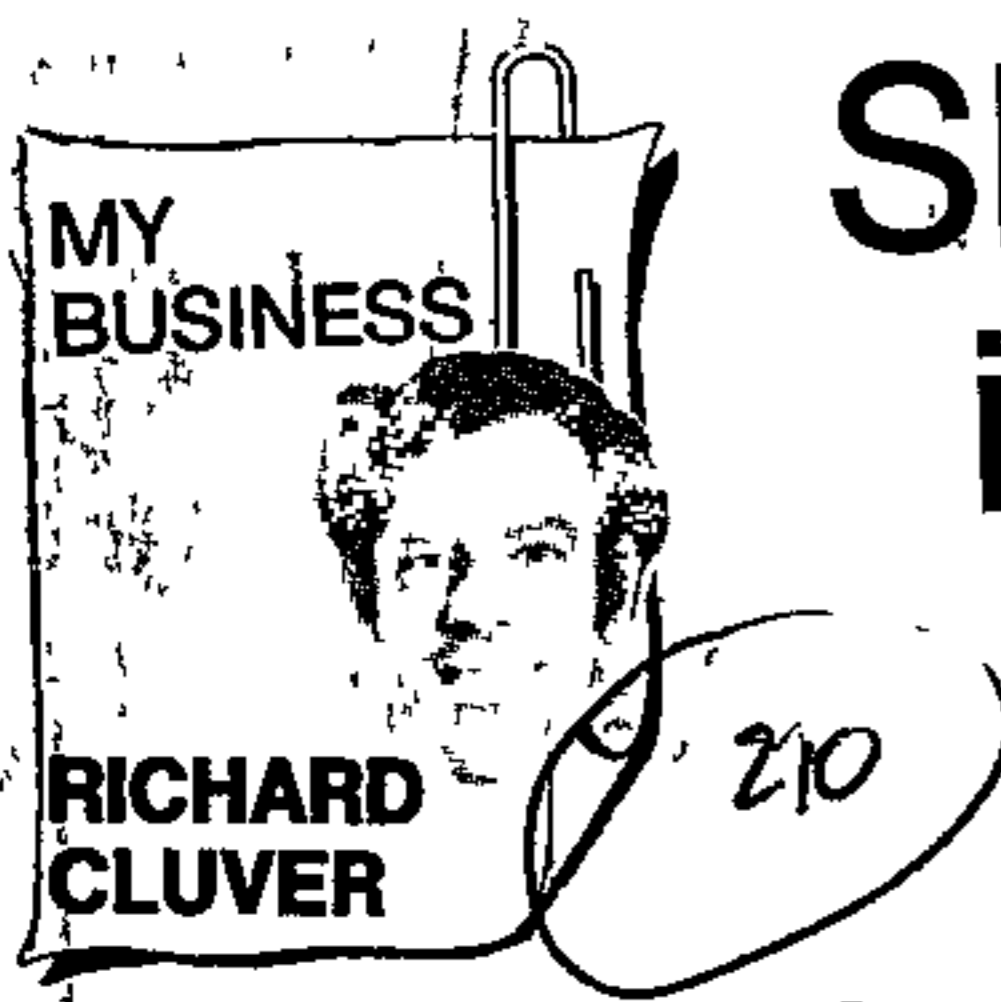

Shares: Understanding the important mining sector

V/C ARGUS 21/1/89

as people spend more or less upon the good things that they enjoy, but in the main both these types of companies can rely upon pretty constant business

in the award of supply contracts

The situation can become nightmarish if a mineral consumer wants a long-term supply contract and the competing suppliers operate in countries which have far lower inflation rates than South Africa has

per suppliers. In addition to a reduced requirement for copper wire for new phone lines, massive quantities of the metal have been recycled as scrap as old phone lines were torn down

Clearly then it is a risky business to go in for mining. However, the world has a voracious need for minerals and so it is not really all that surprising that well-managed mining companies are huge profit-makers when things go well for them

Leaving out gold mines for now because they have their own special peculiarities, if one analyses the long term dividend, earnings and return-on-capital histories of the all JSE companies according to the principles I have laid down in this column, it is mining shares that consistently come to the top

Next week I will explain now the investor can analyse a mining share

● Richard Cluver's My Business columns are a serialisation of his best-selling book *Investment Without Tears* which is available post free from The Promotions Department, The Daily News, PO Box 1491, Durban at a price of R25 plus R3 GST

THE mining sector of the Johannesburg Stock Exchange is both the most important and the most volatile area

Fortunes have been made and lost more quickly in this sector than in any other. That is why the investor who opts to buy mining shares should understand the fundamental differences between them and the ordinary shares of other sectors of the stock exchange

The greatest single distinction is, of course, the volatility of the mineral markets and hence the fluctuating fortunes of such companies

To understand why mines experience this volatility it is necessary to briefly compare the markets within which a mineral-producing mine operates in comparison with, for argument's sake, a brewer or a grocery chain

Companies operating in both of these latter spheres can generally rely upon a constant supply of customers.

Boom and bust cycles of the economy might have a peripheral effect upon their fortunes

The investor who buys their shares is thus assured, presuming that the companies are well managed, of constant dividends and so the shares remain fairly constantly priced within the marketplace

Their only real fluctuations have to do with measurable things like long-term profit trends which are quite easy to predict if one applies the tests I have earlier described in this column, and with the economic cycle of the share market itself as it moves from bear through to bull and on again to another bear cycle.

Mineral producers, on the other hand, have to contend with frequent changes in the exchange rate of the rand and the currencies of the markets they supply.

In recent years they have also had to cope with a huge disparity between this country's inflation rate and that of most of their trading partners. Competing in the open world market is tough with a few cents a ton often being critical

A mine which enters into such a contract and gets its long-term estimates of inflation wrong can quickly find itself in a loss-making situation as its rising internal costs soar above the break even level

Then again, other countries have their own boom and bust cycles which can dramatically affect their needs for some of the basic minerals

When a vast economy like that of the United States goes into recession, for example, there can be a truly horrendous contraction in the markets for many of the key minerals that South Africa produces and international prices thus fluctuate enormously

New technology also has its effect. For example the development and growing application of optical fibre for telephone communication has had an obvious impact upon cop-

Anglovaal buys stake in NSG

B/Day 11/2/89

210

ROBERT GENTLE and
REINIE BOOYSEN

LONDON — Mining house Anglovaal has concluded a conditional £16.5m agreement which will give it a 29.9% stake in British natural resources company North Sea & General (NSG)

NSG, formed in 1980, was a North Sea exploration company until 1987, when it switched to minerals

Most of its income — about £2m before tax last year — now derives from gold operations in Australia, with a small portion coming from industrial minerals in Scotland.

Under the terms of the agreement, announced shortly before midday on the London Stock Exchange, Anglovaal will purchase 23.2-million NSG ordinary shares at 56p a share from the Australian investment holding company Apex Securities

This reduces Apex's holding in NSG to about 5.5% while Anglovaal's immediately rises to the psychological maximum normally associated with takeover bids

According to stock exchange regulations, Anglovaal cannot increase its stake any further without making a formal bid for the rest of the company

However, Anglovaal said it regarded its shareholding in NSG as a long-term

investment and had no intention of mounting an all-out bid

The agreement also sees Anglovaal buy £2.5m of convertible unsecured 1992 NSG loan stock. A conditional agreement to purchase a further £1m of the same loan stock has been reached with an as yet unidentified third party.

An NSG spokesman said that besides gaining access to Anglovaal's expertise in mineral exploration and extraction, NSG will also get first option on any new mineral investment propositions outside southern Africa.

Anglovaal director David Crowe has already been appointed to the NSG board. On completion of the agreement, which is subject to approval from the exchange control department of the Reserve Bank, he will be joined by Rob Wilson and Derek Kyle, who are also Anglovaal officials

To further consolidate its move into natural resources, NSG will dispose of its Merlin Fund Management business.

● To Page 2

Anglovaal buys into UK resources firm

This will be acquired by Apex, which has undertaken to limit its shareholding in NSG, whether direct or indirect, to 17.5%

NSG directors have welcomed the multi-million pound cross-over deal as being in the long-term interests of the company. Apex could not be reached for comment, but an NSG spokesman said

they would be "more than happy"

He was referring to the fact that while NSG shares yesterday traded at about 46p, Anglovaal had to buy them at 56p — a 22% premium

Anglovaal said a formal announcement would be made in the Press tomorrow

● From Page 1

Was it a good buy for Anglo Vaal?

Star 2/2/89
210

Anglo Vaal's R170 million shopping spree will considerably enhance its rand hedge attraction. But given that very little information has been provided in the group's official statement, it is difficult to determine whether or not AV has paid over the odds.

It has made two acquisitions: North Sea and General for around R89 million and Lavino for R77,6 million.

Certainly, from the information so far available it seems a hefty price was paid for NSG. The most recent accounts, which relate to the six months to June 1988, show taxed profits (no tax was paid) of £780 000. In the accompanying directors' report it is stated that "a number of actions have already been taken which are expected to contribute to improved financial performance in the second half".

This suggests that full year earnings could be in the region of £1,7 million. AV has paid £16,5 million to get 29,9 percent of this action which indicates that AV bought it on a price/earnings rating of around 29 times. Even Minorco, Charter, Congold and Richemont do not enjoy these sort of ratings. So either AV know a lot more about NSG's prospects than they are willing to reveal at present, or the English saw the South Africans coming.

The price per share that AV paid is equivalent to 56p and compares with the current market price of 46p.

AV will not comment on the price that it paid or how it will fund the acquisitions. It seems that NSG placed the South Africans in an uncomfortable situation by announcing details of the deal in London on Tuesday be-

Diagonal
Street

ANN CROTTY



fore the final details were sorted out. In response AV released a statement yesterday referring to a "conditional agreement to purchase" 23,2 million shares from Australian group, Apex Securities.

But it is unlikely that AV was so keen to get a foreign currency earner that it would have paid such an apparently heavy premium. Rather, it is likely that the AV team are very optimistic about the growth prospects of NSG and have built this into the price.

NSG group, which is listed on both the London and Australian markets, underwent a major transformation during financial 1987 from a North Sea oil exploration and production company into a diversified natural resources group with worldwide interests in gold, hydrocarbons and industrial minerals. There was also a change of management during that year.

The group's assets are spread across Europe, US and Australia.

AV has made no statement on how it intends to fund the acquisitions but it is likely to involve an element of overseas borrowings with the dividend income from the operations being used to pay the interest bill.

Even if all the funding were to be carried up-front by AV, it would not put any pressure on the group's balance sheet. The 1988 annual report showed that the group had cash of R1 billion

R77,6 million

ANGLOVAAL 210

Plunging in ^{AM/ML} 3/2/89.

Latest SA company to plunge into international waters is Anglovaal. Though it already had some small stakes overseas, its first big step came this week, announced by the British company apparently before Anglovaal was ready to give details here.

Anglovaal has made a conditional contract with Apex Securities to purchase 23,2m shares (29,9%) of North Sea and General Holdings (NSG). The price is 56p per share, putting a value on the deal of £13m, but Anglovaal is also buying £2,5m 10% convertible unsecured 1992 loan stock from Apex and another £1m of the same stock from an unnamed third party. We understand this is the entire amount of loan stock on issue.



Anglovaal's Hersov ... building foreign assets

Apex is to remain a long-term investor and still has 4,27m shares (5,5%) and an option on another 5m shares. If the sale is declared unconditional, Apex intends to raise its stake to 14,9%, but will limit its shareholding to 17,5% of the ordinary share capital.

Anglovaal chairman Basil Hersov says the group has intended for some time to invest in overseas mineral operations and the invest-

ment is part of an ongoing programme. Hersov says that payment will be made in financial rands, which at today's rates suggests a local cost of around R89m for the ordinary shares alone.

The group will hold 29,9%. As this is under 30%, no offer will have to be made to other shareholders. But that could change when the loan stock is converted in 1992, as the conversion rate is two shares for every £1 of loan stock, giving Anglovaal another 7m shares.

Quoted on the unlisted securities market, NSG's price hit a low of 29p last year and was 48c on the day of the announcement, well below the 56p Anglovaal is paying. At the current market price the price is a high 21 on historic earnings.

NSG is capitalised at £43,5m, half of which is net cash. Some came from the sale of interests in oil and gas in the North Sea and on the Australian shelf, which it sold about two years ago for £17m. Other assets consist of 33% of an unlisted British company, Anglo European Minerals, which quarries marble and supplies silicon for glass. NSG also has an interest in Indian Ocean Resources and Kurara gold mine in Australia, which produces 50 000 oz/year of gold.

NSG's interest is to obtain access to Anglovaal's expertise and possibly to be a part of future projects. It is proposed that Anglovaal financial director David Crowe, who has been responsible for the negotiations, will join the NSG board. More details will be available on Thursday, when Anglovaal makes its official announcement. *Pat Kenney*

Minorco's bid gets the go-ahead

210

THE British government yesterday gave the South African-controlled Minerals and Resources Corporation the go-ahead to pursue its £2-billion bid for British mining giant Consolidated Gold Fields.

The Monopolies and Mergers Commission said Minorco, controlled by Anglo American and De Beers, could pursue the bid despite attempts by Cons Gold to block it on the grounds that South Africa would gain dominance of the world gold and platinum markets.

The commission said it concluded unanimously that Minorco's proposed acquisition may be expected not to operate against the public inter-

est Minorco welcomed the announcement. "Given the facts as we have always known them to be, we expected total clearance. We are delighted that the MMC, following its exhaustive and dispassionate investigation, has seen it that way," chief executive Sir Michael Edwardes said yesterday.

Stock market analysts had said a decision by the commission to block the bid could only have been based on political rather than business factors.

Cons Gold chairman Rudolf Agnew had said a takeover by Minorco would damage the British company's interests. He argued Cons Gold's

quarrying subsidiary ARC could lose contracts in Britain and its US unit Newmont Mining Corporation, which Minorco has said it intends to sell if its bid succeeds, would face similar problems.

In its battle to block the offer, Cons Gold has also complained to the British government's Office of Fair Trading that De Beers, which controls over 80 percent of world diamond trading and owns 21 percent of Minorco, was involved in unfair diamond trading in London.

If the Office of Fair Trading finds there is a case, it could refer De Beers' operations to the Monopolies Commission.

WMAAC 3/2/89 - 9/2/89.

Miners reject Anglo's proposed code

^{6/2/59}
THE NUM anti-repression rally at Wits University, attended by more than 5 000 miners, yesterday rejected Anglo-American's proposed code of conduct. National treasurer Paul Nkuna said Anglo's code was aimed at maintaining exploitation and repression on mines. "If repression does not end we will consider going on strike. For the next six months from today we will be watching what they (Anglo and the Chamber of Mines) are doing," he said.

SIPHO NGCOBO

210

Mkuna said the code was aimed at taking away workers' meeting rights and would enable mine security personnel to enter hostel rooms whenever they wished and do whatever they liked. He said NUM members demanded to have the right to meet union officials to discuss problems whenever the need arose. "We want our union officials to have free access to the mines," he said.

AAM pledges to make life tough for Anglo

LONDON — The Anti-Apartheid Movement (AAM) has pledged to put an end to "the sinister operations" of Anglo American and cause the group to regret ever launching a bid for ConsGold

Attacking the UK government's "hands-off" approach towards Minorco's £2.9bn bid for ConsGold, AAM chairman Bob Hughes accused Prime Minister Margaret Thatcher of "totally irresponsible behaviour"

Hughes said if current efforts to stop the bid failed, the AAM would convene a meeting in London of government and anti-apartheid representatives in all the

210
Own Correspondent

countries where Anglo American operated

He said "It is high time we put an end to the sinister operations of this group across the world. We will make it regret it ever started this takeover attempt"

'Indefensible'

Hughes said he had written to Thatcher stating it was "indefensible" her government did not warn the Monopolies and Mergers Commission of the "potential damage to Britain's foreign policy interests" posed by the bid

"Likewise, it is inexcusable the Trade

BIDder 6/2/89
Secretary should have abrogated all ministerial responsibility by refusing to use the powers available to block the bid"

Government's refusal to present such evidence to the commission of inquiry into the bid was a clear dereliction of its duties "since it cannot be seriously argued that the takeover of such a major British company by SA interests can do anything but damage Britain's standing in the international community, given the extent of international opposition to apartheid"

Hughes had also sought an assurance from Thatcher that the Conservative Party would stop accepting funds from SA business interests

Anglo and NUM see old mine Act being put to new test

210 (circled) 2/10/87 8/2/87

ALAN FINE

AN APPLICATION by two NUM members, under a little-known section of the Mining Rights Act but with potentially far-reaching implications, will be heard in the Rand Supreme Court today

If it is successful it could mean a payout of at least R5m to 10 000 NUM members dismissed during the August 1987 strike

An NUM legal adviser and an Anglo American gold division industrial relations

consultant, Nigel Unwin, confirmed the application by the two Vaal Reefs men was seen as a test case

They also confirmed the potential payout figures were reliable estimates

Section 164 of the Act provides that no mine may discharge more than 20% of its workforce in any month without giving writ-

ten notice of the dismissals to the Mineral and Energy Affairs Minister

It also stipulates a mine contravening this provision will be liable to pay each man a month's wages

The original intention of Section 164, promulgated in 1919, is believed to have been to protect state earnings from sudden changes in the operating practices of low-grade mines

There are two sets of clauses but the answers are the same

Mines to fight Bill that scraps Kruger's laws

210

St Times 12/2/89

By Ian Smith

THE mines will contest sweeping legislation which could affect every sector of the industry which laid SA's economic foundation

The Chamber of Mines has completed a 200-page document outlining objections to the Minerals Bill, due to come before the current session of Parliament

The Bill repeals 32 Acts and replaces sections of another four

"Mining law which has been around since the days of Paul Kruger will be scrapped," says a mining house official

The chamber has asked for talks with the four-man task force from the Department of Mineral and Energy Affairs which drew up the draft Bill

Objections have to be lodged by February 17.

Objectives

The chamber's detailed paper was delivered to the Director-General of Mineral and Energy Affairs late this week and a summary has gone to Economic Affairs and Technology Minister Dame Steyn

"We support the aims of the Bill as outlined by Government, but we do not believe it will achieve the objectives," says Chamber of Mines legal adviser Barry

Shipman

"The Bill should be revised — from beginning to end"

The major objections stem from the belief that surface rights holders, or landowners, are gaining more protection at the expense of mineral rights holders

One of the Bill's main provisions would make prospecting and mining rights currently registered by the Government subject to individual personal agreements with landowners.

Guaranteed

Mr Shipman says: "This could cause a great deal of uncertainty. We see that a host of problems could arise"

A 1986 White Paper said the security of mining rights would be guaranteed. "This Bill appears to conflict with that undertaking in some respects," says Mr Shipman.

Deputy Minister of Economic Affairs and Technology George Bartlett said in December that the consolidated Act was being prepared to simplify legislation covering mining and to avoid overlapping laws

But, according to Mr Shipman, an explanatory memorandum says the Bill serves only as a framework and that provision must be made for regulations by the Minister

"This seems to open the door to more regulation"

The Bill also provides for prospecting permits to apply to base minerals

Mr Bartlett says that the traditional separation of mineral rights and surface rights has often led to conflict between the interests of the holders

"In its quest for the establishment of a well-ordered society, the Government must ensure the protection of not only the interests of the holders of surface rights and mineral rights, but also the interests of the community as a whole."

Under the present system rights which are normally regulated by common law are statutorily affected by rights and permissions granted by the State. They include surface rights on private land and mining leases for certain privately owned minerals.

The memorandum on the Bill says: "Although such an arrangement apparently suits the mining industry, it undoubtedly creates tremendous unhappiness among other holders of rights"

Under the present system there are nine levels of authority in the administration of mining legislation and regulation.

The proposed legislation provides for the formation of a minerals advisory council and the appointment of regional directors to administer the Act

Stock exchange gains

R16-bn in one week

210 Ste 13/2/89

By Derek Tommey

The JSE is booming Share prices surged last week after heavy institutional buying and rose overall by 4,8 percent to boost the market value of listed shares by R16 billion to R346 billion

This is a continuation of the steady rise which has added R43 billion to share prices since December

Only investors in Hong Kong and Britain so far this year have fared better, as the accompanying graph shows.

Last week's frantic buying boosted turnover to R475 million, giving brokers their most active week since the October 1987 crash.

Brokers attribute the buoyant market conditions to the better-than-expected performance of the economy and to companies reporting unexpectedly high profit increases

Some of the percentage increases in earnings a share reported in the past week are (annuals) SA Eagle 83, Afex 55, Conafex 44, Metalco 34, Chemserv 31, Didata 28 and Stanbic 20; (interims) Kudu 269, MS Spitz 89, Wooltru 42, Impala 32, Micor 23 and Klipton 20

A feature of the results is that virtually all sectors of the economy appear to be doing well

This, was reflected in share movements last week when coal, diamond, metal and mineral, manganese, platinum, financial and industrial shares all gained

- Hong Kong
- United Kingdom
- SOUTH AFRICA
- France
- Singapore
- Canada
- United States
- Holland
- Japan
- Switzerland
- Belgium
- West Germany
- Australia

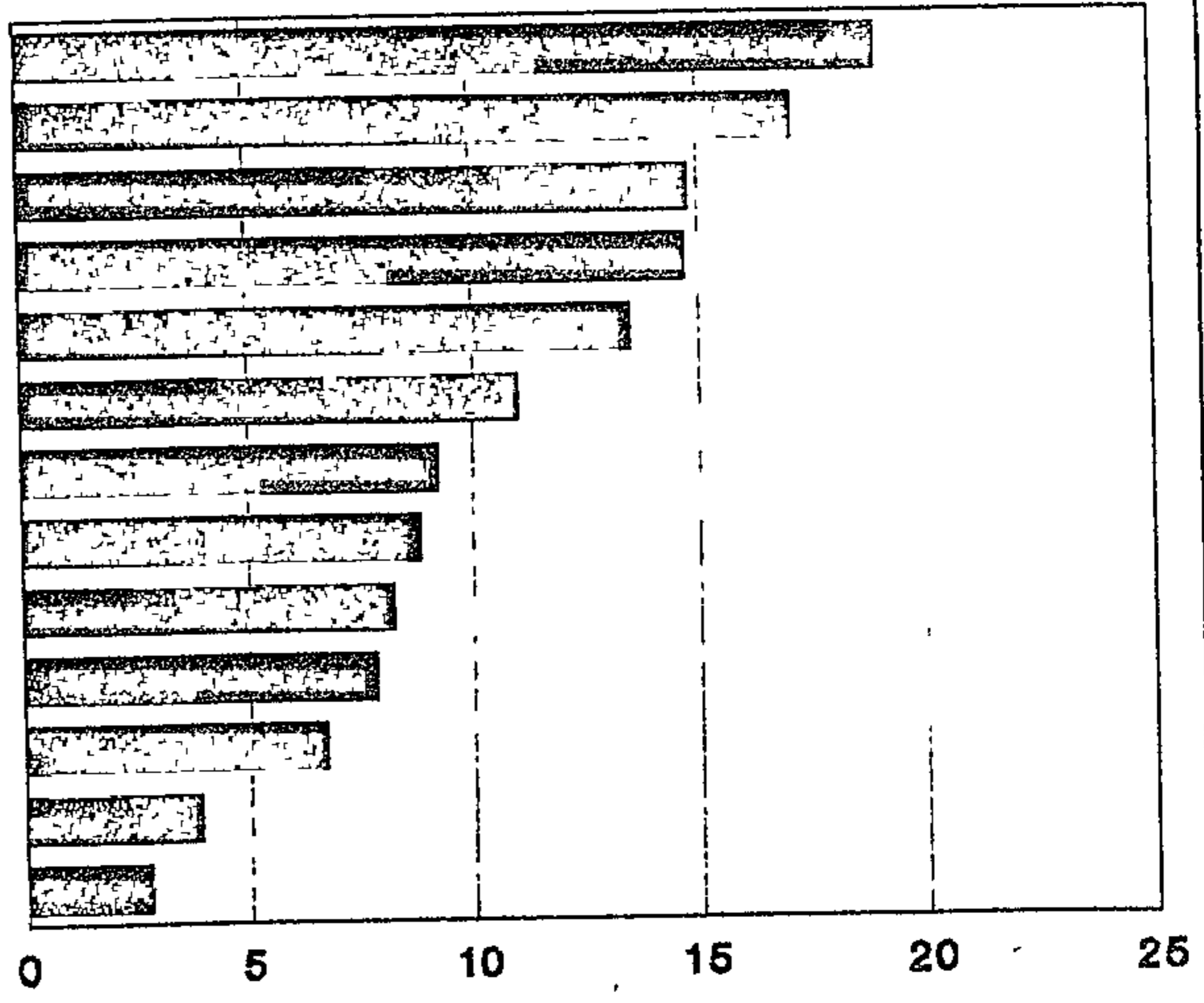

Share gains since December (percent)

more than four percent.

With the gold price sinking below \$390 at the weekend, gold mining is not doing as well.

Nonetheless gold shares managed to rise 5,5 percent, indicating that even under current conditions, investors believe these shares are offering value

After last week's gains many investors will obviously be wondering whether to take profits

Most economists expect a growth rate this year of two percent — which means that profits will continue growing, but perhaps not at the current rate.

This suggests there is no reason for profit-taking at this stage.

An analysis by Mike Brown, of Davis Brokum and Hare, shows that dividend yields offered by the leading sectors are still some way above their 1987 October peak and

November slumps, which shows that earnings have kept pace with share price growth

Percentage dividend yields offered by the major sectors last Friday and, in brackets, those at the end of August, 1987 were: Tobacco and match 1,9 (0,9), platinum 4,5 (3,3), diamonds 2,5 (1,7), insurance 3,6 (3,0), food 2,8 (2,2), mining houses 3,2 (2,5), motors 4,6 (2,6), all gold 5,5 (2,3) and banks 5,6 (3,9)

No poverty plea, union tells mines

ALAN FINE

THE Chamber of Mines will find itself hoist with its own petard if it enters the 1989 wage negotiations pleading poverty, Council of Mining Unions (CMU) chairman Ben Nicholson said yesterday

The CMU, representing artisans and white qualified miners, has submitted proposals for 20% increases. Talks are expected to begin by next week, and new rates are scheduled to be implemented from May

Nicholson said the chamber had always insisted that during good years the gold price and affordability were not legitimate criteria for determining the level of wages and increases

He predicted the chamber would attempt to change this approach in 1989, using the industry's unfavourable economic conditions to resist union demands

Chamber senior GM, external affairs, Johann Liebenberg responded that Nicholson appeared to have "a very short memory"

The chamber had for years drawn attention to employers' need to account for rapidly rising working costs when determining increase levels to be granted, he said.

According to Nicholson, other CMU proposals include a five-day week, improved bonus, annual leave and accident leave conditions

January 17 to February 23 1989

(210) W. WILLIAMS
17-23/2/89
7

A forgotten old law could cost Anglo millions

By DREW FORREST

THE Anglo American Corporation's mass dismissal of strikers at its Vaal Reefs mine during the 1987 mine-workers' strike could prove a costly step

Last week, two of the fired workers asked the Rand Supreme Court to rule that their dismissal was unlawful. If the court finds in their favour, it could cost Anglo a cool R10-million — and open the door to court action on other mines where strikers were fired *en masse*.

The application, brought by National Union of Mineworkers members Samuel Kula and Job Sekoane, is in terms of a little-known section of the Mining Rights Act which requires employers to inform the Minister of Energy and Mineral Affairs if they intend sacking more than 20 percent of the workforce on a single mine.

The provision dates back to 1926, and was apparently intended to help stabilise the country's most important industry.

A total of 17 000 workers were fired during the strike at Vaal Reefs. Some were later rehired but lawyers say they will all qualify for compensation if Kula and Sekoane win their case.

The Act provides for the payment of one month's wages to workers who are unlawfully dismissed. Sources estimate that if all the Vaal Reefs strikers are paid out, it will cost Anglo about R10-million.

In addition, other Anglo mines where mass dismissals took place during the 1987 strike — including Western Deep Levels and Free State Consolidated Gold Mines — might become vulnerable to court action. The corporation fired a total of 40 000 workers during the strike.

In an affidavit placed before the court, the regional manager of Vaal Reefs, Robert Williams, says the employers knew nothing of the relevant clause in the Mining Rights Act at the time of the dismissals. They only became aware of it when they received a letter of demand from lawyers representing Sekoane and Kula.

Anglo concedes that it fired 10 000 workers on the mine but argues that the law was not intended to apply to the dismissal of strikers.

The case also turns critically on the exact proportion of Vaal Reefs' 57 000-strong workforce dismissed after striking. Anglo argues that 19,8 percent of the workers, not the 20 percent required by the Act, were dismissed in the strict sense, and that the remainder either resigned, deserted or were dismissed after a lockout.

Minerals feature as exports surge

(210) WMAPC
17-23/7/89

FIRMER international markets for metals and minerals contributed to a surge in South Africa's non-gold exports in the final quarter of last year.

The value of South Africa's non-gold exports in the last quarter was up 40 percent on the quarterly average for 1987, Finance Minister Barend du Plessis said this week. As a result, the surplus on the current account of the balance of payments was running at a seasonally adjusted annual rate of R5-billion. This was in sharp contrast to the first quarter of last year, when the current account was in deficit.

Detailed trade figures are not available, but firm international markets and rising prices for metals and minerals were probably the biggest factors in the "dramatic" rise in South Africa's export earnings late last year, according to South African Foreign Trade Organisation general manager Ann Moore.

Metals and minerals make up about half of non-gold exports, she says. The category includes raw minerals such as coal, and iron, chrome and manganese ore, as well as processed materials such as iron and steel and ferro-alloys.

Other exports which were probably significant last year were diamonds and platinum, for which international markets were good.

South Africa continues to rely for its export earnings mainly on primary commodities such as minerals — manufactured goods account for between 22 and 25 percent of South Africa's exports.

The outlook for metal and mineral exports for this year is still quite good, Moore says, but the outlook for manufactured goods depends on the local economy. When the domestic market is buoyant, many manufacturers sell here — it's only when things are bad that they tend to start looking for export markets.

Europe is still South Africa's major export market, probably accounting for about 50 percent of the value of non-gold export sales. The next most important markets are in the Far East.

Moore says that while Africa is a relatively small export market, it is an important one in that it takes a higher proportion of manufactured goods than do other markets. Machinery and equipment manufactured in South Africa are, for example, well suited to the needs of neighbouring countries

nd to
of
y
ve

BUSINESS

Big business meets Swapo: Better the devil you know

THE last time executives from the Anglo American/De Beers group met publicly with members of an African liberation movement it was in a game park in the bush. This time, last week, it was in London's Ritz Hotel.

The matter in hand for the businessmen was the same on both occasions what accommodations can be expected when the biggest and richest mining empire in the world is not protected by a white minority government?

For the leaders of South Africa's African National Congress and Namibia's South West African People's Organisation the question was the economic, and indirectly, the political survival of their countries after independence.

Anglo American chairman Gavin Rely came away from the meeting with the ANC in Zambia in 1985 comforted by the view that the ANC leadership "would be more interested in a viable and vibrant South African economy that they would be in the Marxian form of economy."

After the meeting at the Ritz between senior Swapo officials, including its president Sam Nujoma, and De Beers executives, both sides maintained a tight-lipped silence, embarrassed that news of the encounter had leaked out.

But in fact these discussions between the liberation movements and the principal mining conglomerates — the main foreign exchange earners of both countries — have been continuing in private for some time, according to sources close to the exile leaderships in London.

— Namibia's owners met the would-be new rulers when De Beers talked with Swapo in London last week. Times are changing indeed, and De Beers is taking no chances.

By DAVID PALLISTER in London

the United Nations Institute for Namibia has put it. "There is no doubt that the government of an independent Namibia will adopt a more rational approach towards this sector."

With the need for technical expertise and huge investment, the mining companies can expect at the very least management contracts and even some compensation in return for continuing capital programmes. But their losses will still be enormous. Any independent government in Namibia would want to reverse the present position where most surplus is remitted to South African private interests rather than invested in national development.

It is this prospect which many analysts believe has prompted Anglo's recent attempts to take over Consolidated Gold Fields, part of a long term strategy to shift the group's resources and centre of gravity away from southern Africa.

Anglo's bid for ConsGold, through its international investment arm, Minoro, has been rich in ironies and unusual alliances. Both sides have indulged in public fantasies, with the anti-apartheid movements in Britain uncertain about how to respond.

Luxembourg-based Minoro,



Anglo's Rely



Swapo's Nujoma

through its new chairman, Sir Michael Edwards, has tried to maintain the fiction that it will not in future be controlled by Anglo and the Oppenheimer family, even though the group is a past master at engineering control through minority interests.

ConsGold, the company after all of Cecil Rhodes, has hilariously insisted that Minoro — that is, South African control — would damage its interests abroad when its associate in South Africa, Gold Fields, has one of the worst labour relations reputations in the Chamber of Mines ConsGold, moreover, has deliberately flouted the Commonwealth and EEC voluntary ban on new investment by two rights issues for Northern Platinium in 1986 and 1987.

For Western banks, supposedly cheer-leaders of disinvestment, the £2.9-billion Minoro bid was too much of an attractive business to ignore.

Chemical Bank in New York, one of Minoro's financiers, shrugged off anti-apartheid protests and the Bank

of Nova Scotia joined the consortium while Canada, through its chair of the Commonwealth foreign ministers' committee on sanctions, was proposing tougher financial measures against South Africa.

In this fog of hypocrisy, British anti-apartheid groups wobbled in their search for a political advantage. End Loans to Southern Africa came out with a straight condemnation of both the Minoro bid and ConsGold's record on its gold mines. The Anti-Apartheid Movement belatedly endorsed this approach. But initially it protested only about Minoro's South African roots, while deliberating ways of putting private pressure on ConsGold's management to disinvest.

Rudolph Agnew, ConsGold's chairman, realising that he needed all the friends he could get, tentatively opened up a private dialogue with AAM and hinted that the GfSA connection would in the long term be run down.

Now that the Monopolies Commission has given Minoro the go-ahead to reactivate the bid, a curious calm has descended on the battlefield. It is suggested that Minoro is waiting for ConsGold's buoyant share price to level out before it comes back with an offer.

In the meantime, the affair has turned the spotlight on Anglo's undisputed monopoly in diamonds, with the Office of Fair Trading examining a ConsGold spoiling complaint that the De Beers business is a restraint of trade.

But De Beers has seen it all before and survived. The company has avoided similar scrutiny in the United States from the Justice Department for nearly fifty years yet the US remains the biggest market for the London-based Central Selling Organisation marketing arm.

When Sam Nujoma met with De Beers last week he knew he was dealing with the men who have been accused by the Thurton Commission of raping Namibia of its mineral resources. But in the art of politics, as in business, it may be better to deal with the devil you know.

MAKHOSEKAZI
FEDERATION

Minerals feature as exports surge (210) WMAPC, 17-23/89

FIRMER international markets for metals and minerals contributed to a surge in South Africa's non-gold exports in the final quarter of last year.

The value of South Africa's non-gold exports in the last quarter was up 40 percent on the quarterly average for 1987, Finance Minister Barend du Plessis said this week. As a result, the surplus on the current account of the balance of payments was running at a seasonally adjusted annual rate of R5-billion. This was in sharp contrast to the first quarter of last year, when the current account was in deficit.

Detailed trade figures are not available, but firm international markets and rising prices for metals and minerals were probably the biggest factors in the "dramatic" rise in South Africa's export earnings late last year, according to South African Foreign Trade Organisation general manager Ann Moore.

Metals and minerals make up about half of non-gold exports, she says. The category includes raw minerals such as coal, and iron, chrome and manganese ore, as well as processed materials such as iron and steel and ferro-alloys.

Other exports which were probably significant last year were diamonds and platinum, for which international markets were good.

South Africa continues to rely for its export earnings mainly on primary commodities such as minerals — manufactured goods account for between 22 and 25 percent of South Africa's exports.

The outlook for metal and mineral exports for this year is still quite good, Moore says, but the outlook for manufactured goods depends on the local economy. When the domestic market is buoyant, many manufacturers sell here — it's only when things are bad that they tend to start looking for export markets.

Europe is still South Africa's major export market, probably accounting for about 50 percent of the value of non-gold export sales. The next most important markets are in the Far East.

Moore says that while Africa is a relatively small export market, it is an important one in that it takes a higher proportion of manufactured goods than do other markets. Machinery and equipment manufactured in South Africa are, for example, well suited to the needs of neighbouring countries.

nd to
of
y
ve

210

WMMU 17-23/2/89

BUSINESS

A MULTI-MILLION rand project to develop natural gas fields off the shores of Mozambique has caught the eye of the Anglo American Corporation.

Anglo representative Michael Spicer this week confirmed reports that the corporation was considering investing millions of rand in the Pande gas fields, which lie off the Mozambique coast halfway between Maputo and Beira.

A number of other investment opportunities in Mozambique have been also been investigated by the company since Anglo chairman Gavin Relly visited the country early last year, he said.

If the gas deal comes off — and Spicer stressed that no definite decisions have yet been made — Anglo will become the biggest single investor in the war-torn country.

Responding to reports at a confer-

Anglo looks east to Maputo gas

business

"We are now looking at a range of projects," said Spicer. "These are reaching a fairly final form in some areas and in others, given the security situation, they are of a long term nature." He declined to provide further details.

Last month Sergio Veira, member of Frelimo's central committee, told a media conference in Harare that powerful business interests in South Africa were clearly in favour of seeing an end to the war and that his government believed this would constrain more aggressive elements in South Africa.

In recent months Mozambican officials have claimed South Africa continues to arm and support the rebels despite the revival of the Nkomati

non-aggression pact in September last year. This has been denied by SA Defence Force headquarters.

Spicer said Anglo was "interested in a stable Mozambique and a stable region".

Although there are strong political and social motives behind Anglo's interest in its eastern neighbour, Spicer stressed all the projects were being checked for their commercial viability.

A number of other South African corporations — including Sappi, Premier International and SA Airways — have plans to step up their involvement in Mozambique.

Such investment is being encouraged by the Mozambican government which this year made sweeping tax concessions, including exemption from tax for a period of between two and ten years and exemption from customs duty of imported materials

Billions in mine capex 210

1/2 Day 2112/89

GERALD REILLY

PRETORIA — Capital investment by the mining industry would amount to tens of billions of rands over the next five years, a project management conference at the CSIR heard yesterday.

LTA's process engineering MD D A Edge said the scope and complexity of individual projects was growing as pre-grades diminished and the trend towards more refined products increased.

He said the financing of such projects — which would total tens of billions of rands over the next five years — had to rely on local capital which had become an ever more precious resource because of the withdrawal of foreign financial support.

Eskom project manager J A de Beer said the value of Eskom projects under construction by the end of last year totalled R30bn.

The capex budget for this year was R2,6bn spread over 3 000 contracts and orders. De Beer said to control that, about 1 200 Eskom employees were in-

involved in project management.

Economic Affairs and Technology Deputy Minister George Bartlett said it was regrettable that the productivity of construction workers in SA averaged less than half that in the US, Japan and Western Europe.

This meant not only spending hundreds of millions of additional rands on direct field costs on a major project, but also additional management and supervision problems.

Probably the biggest challenge in southern Africa was to ensure enough companies with the resources of skilled workers backed by efficient control measures.

Bartlett said several of the large-international engineering and project management companies no longer did business with SA and this highlighted the need for training of South Africans to required skills levels.

NUM accuses mine management of not co-operating

BIDEN 2/12/87

210

ALAN FINE

THE National Union of Mineworkers (NUM) yesterday accused Western Deep Levels (WDL) management and the Chamber of Mines from withholding from NUM documentation related to the use of polyurethane underground NUM health and safety officer Mavis Hermanus said the union was collating information on the subject in preparation for an inquiry next week into the October 13 WDL accident Seven miners died in a fire during which the substance ignited.

Both Anglo and the chamber denied unfairly holding back information

Hermanus said the union had requested from both the mine and the chamber a copy of recommendations circulated by the chamber to its affiliates after the Kinross disaster on "the safe application and usage of polyurethane"

"The secrecy surrounding the documentation is not in the interests of mine safety The fact that the industry is not prepared to tolerate public scrutiny is an indication of the sorry state of health and safety on the mines"

She added arrangements for NUM

participation in a test in the chamber's fire tunnel facility had fallen through

She also criticised the office of the Government Mining Engineer for not intervening

The GME could not be reached for comment

An Anglo spokesman said certain documentation "had been withheld from wider distribution as is normal in sub justice cases"

Chamber senior GM, external relations, Johann Liebenberg dismissed NUM allegations that the chamber had

failed to co-operate as "untrue"

He had told the NUM research into polyurethane was "multi-faceted and on-going and there was still a great deal of work to be done before any conclusive results could be published"

He quoted from a letter written to the NUM in November to show certain documents on fire hazards had been supplied to the union.

Union officials had been invited to visit the fire tunnel to see first-hand the work being done to test materials for potential hazards

Num, Anglo to meet

2/1/89
Somerset

By LEN MASEKO (210)

A MEETING between the Anglo American Corporation and the National Union of Mineworkers — called to draw up a code of conduct for Anglo mines — was on the cards, the two parties said yesterday.

Num official Mr Marcel Golding said they were geared to meet Anglo management soon, though the date for the meeting had not yet been set.

An Anglo spokesman said certain issues were still being cleared before the date for the meeting — kept a secret for a while — was announced.

Sowetan 22/2/89

Chamber denies Num claims

THE Chamber of Mines has dismissed as untrue claims by the National Union of Mineworkers that it had refused to cooperate with the union on the use of the controversial polyurethane substance.

A chamber spokesman, Mr Johann Liebenberg, said reports had been sent to the Num and union officials invited to visit the employer body's "fire tunnel" so they could see first hand the work being done to test materials for potential hazards.

He said, "Additional Num allegations regarding a polyurethane fire at Western Deep Levels would be dealt with separately by the Anglo American Corporation (owners of the mine)."

papers on the respondent (the minis-

release of trial. He said he would continue his fast for 24 hours.

Clem Sunter gains fans behind the Iron Curtain

by Day 23/2/87

ANGLO American's Clem Sunter, whose "high road, low road" theorem is familiar to thousands of South Africans, has won himself a new audience from behind the Iron Curtain.

During a visit to Harare two weeks ago, Sunter delivered his presentation to more than 30 advisers from Eastern European countries and the USSR.

He said the presentation was "well-received" — so much so that Sunter is expecting invitations to address other communist interest groups in Eastern Europe.



● SUNTER

Sunter, Anglo's director of strategic planning, developed his overview of SA and the world out of the work done by the Anglo forecasting team during the

BRENT MELVILLE

past few years (210)

He has presented it to more than 30 000 people and 250 companies, and has produced a bestseller *The World and SA* in the 1990s, which has sold more than 55 000 copies in SA alone

In addition, he has made a video which has sold more than 43 000 copies.

The demand for Sunter's views has spread well beyond SA's borders, being enthusiastically received by proponents of President Mikhail Gorbachev's perestroika to supporters of capitalism

Apart from the Eastern Europeans, he has been invited to speak in the US, Europe and Japan but has declined

Asked why, he said he was committed to the idea of SA becoming a winning nation, and he could best serve that dream from inside the country.

Iran
Belg
"an
fired
die f
ing

Genbel maintains interim dividend at 110c

GENBEL maintained its interim dividend at 110c for the six months ended December 31, 1988.

This reflects the confidence in the underlying portfolio which, in the period under review, produced income before taxation and surplus on investment transactions of 5% less than recorded in the corresponding period last year.

The income has been affected by significant changes in the portfolio and the year-ends of certain investments.

A statement from Gencor says the attributable net asset value a share, based on market prices at 22 February 1989, increased by 14.9% to R52,67.

This increase is due to a general improve-

Included in these changes were the acquisition of an interest of 5% in Sappi in exchange for gold shares, the acquisition of an interest of 14.4% of Barnato Exploration and the purchase of 840 000 shares in De Beers — Sappi's 24/21 5% 10/24 24/21 5%

FINANCIAL MAIL 27/1/89
MINORCO/CONSOLIDATED GOLD FIELDS

Waiting for Lord Young

With the Monopolies and Mergers Commission (MMC) report completed this week, Minorco still gives no indication that it has cooled in its enthusiasm to acquire Consolidated Gold Fields (CGF)

At a briefing at 44 Main Street, Johannesburg this week, Hank Slack, director of Minorco's North American operations said that the group was optimistic about a clearance, but he cautioned that a public pronouncement is not expected for several weeks. Interestingly, Minorco financial director Tony Lea says that UK Trade and Industry Secretary Lord Young has the prerogative of overruling the MMC should the report be negative, but if the MMC clears the bid then he has no flexibility.

However, the Minorco camp contends that any idea of deferring a decision on the bid until an investigation into alleged insider trading has been completed — as CGF has suggested — would be unrealistic. Such investigations normally take many months, a similar report relating to deals in 1986, for example, is still awaited.

Lea and Slack were in Johannesburg for two days, during which they held discussions about CGF's local interests, as well as talked to Minorco's two largest shareholders, Anglo American Corp and De Beers.

They gave no indication of how Minorco would react to a conditional acceptance by the MMC, a situation which Lea describes as "hypothetical," though an acceptance with a long list of conditions may be seen as a polite form of refusal. The Minorco executives reiterated that if the bid is rekindled the group would maintain its stance on disposing of a number of CGF's assets, including the SA interests and Newmont Mining.

Meanwhile, John Cavill reports from London that if price behaviour is an indicator, the bid will be nodded through by Lord Young. The main outstanding doubt is whether, possibly via court action, CGF will successfully obtain a further delay by arguing that all the facts were not available to the MMC because the separate Department of Trade inquiry into allegations of pre-bid insider dealing is incomplete.

A Conservative peer, Lord Morris, has tabled an amendment to the Companies Act which would automatically suspend any takeover while the outcome of such an investigation was pending.

But as regards the MMC, market sentiment and action seems to have come off the fence without waiting for Young to pronounce. In the first two weeks of January, turnover in CGF shares limped along at an average of 129 000 a day. A surge in activity starting on January 18 boosted business to

1,5m last Friday and the average for the four days before the *FM's* press day was 953 000. The action has come from buyers — rather than a sell-off — which has kept CGF's price within 2% or so of Minorco's first offer.

The MMC has so far proved leakproof though a report in *The Guardian* said it "understood" it will give conditional approval to Minorco's hostile offer by stipulating



Minorco's Slack ... a very risky defence

strict conditions for the disposal of CGF assets if it wins ownership.

These would relate chiefly to the 38% Gold Fields of SA (GFSA) stake, probably with the requirement that this is not sold to Anglo American interests, though the MMC's power to enforce its conditions is in doubt, given that Minorco is not a UK-registered company. However, in Johannesburg Lea said that Anglo would not be interested in buying the stake.

And if the Minorco bid does go ahead, Slack says that the terms would have to be reassessed against recent developments. These include any conditions which may be attached to its approval, as well as the amounts which CGF has spent on its defence and the damage that may have been done to the group's interests and financial relationships in the US through the highlighting of the SA links. "This defence has been very risky," says Slack. "We will have to assess the damage." *Andrew McNulty and John Cavill*

JCI

Dividend growth

Shareholders assessing JCI's performance in the six months to end-December should go by the 17% hike in the interim dividend

rather than the earnings comparison which is complicated by the non-recurring special dividend of R36,8m from Rustenburg Platinum (Rustplat) received in the six months to end-December 1987.

Exclusion of that item shows the group increased attributable earnings by 21% in the six months. The major improvements came from the final dividends declared by Rustplat and ferrochrome producer Consolidated Metallurgical Industries for their financial years to June.

JCI's income from investments rose by R12,2m to R93,4m while the attributable earnings of operating subsidiaries improved to R13,5m (six months to December 1987 — R10m) because of better coal earnings.

Taking the non-recurring dividend into account, results in the house showed a 12% drop in attributable earnings to R121m (R137,3m).

However, the bulk of the house's income

STILL GROWING

Six months to	Dec '87	Jun '88	Dec '88
* Pre-tax profit (Rm)	124.0	198.7	135.4
* Attributable (Rm)	100.5	186.5	121.0
* Earnings (c)	1 363	2 529	1 641
Dividends (c)	600	1 150	700
Net Asset Value per share (R)	608	616	712
* Before non-recurring item			

has still to come in the last six months of its financial year. Included in this period is the major portion of JCI's income from its diamond trading investments and, judging by the 1988 sales performance of the De Beers' Central Selling Organisation, this should be well up. Rustplat has already raised its interim payout by 15% which will accrue in this half-year.

The balance sheet remains strong with much of the rise in investments, loans, marketable properties and mining prospects to R966,6m (R839,6m) being accounted for by the R45m spent by the house on taking up Joel B options and a further R50m going into Barnato Exploration and Lindum.

JCI's share price moved strongly from the R460 level at which it stood last August to a high of R630 in mid-December before it was hit by the shock-waves from the Ford announcement on a new autocatalyst. That thumped the platinum market and the JCI share price came off the present levels around R578 as a result. On current prices the higher interim puts the share on a yield of 3,2% and some growth in the price can be expected as sentiment on the platinum market improves.

Brendan Ryan

RUSTPLAT/LEBOWA PLAT

Dividend surprises

Interim results from Rustenburg Platinum (Rusplat) have matched market expectations with the exception of the dividend, where most analysts were looking for a payout of between 120c and 125c a share instead of the 115c declared

By contrast, Lebowa Platinum (Lebowa Plat) declared yet another unexpected dividend, this time an interim of 2,5c a share. That makes the third consecutive payout since the company was listed after releasing a prospectus that stated shareholders could expect no dividends until completion of the expansion at Atok by 1990

Reason for the lower Rustplat dividend is that the cover was raised marginally and the tax rate rose slightly while Lebowa Plat seems to be continuing its policy of keeping its numerous Lebowa shareholders happy. Whether it should be paying this money out when there is still no decision on the financing of the Maandagshoek mine is debatable.

Uncertainty over how Maandagshoek will be paid for is the greatest influence at present on the Lebowa Plat share price, which currently stands at around 720c. Rustplat and Lebowa Plat MD Barry Davison says all avenues are being considered and a decision can be expected "in due course"

There appear to be three options, of which

PLATINUM-LINED

Six months to	Dec '87	Jun '88	Dec '88
Turnover (Rm)	1 129,6	1 237,3	1 414,2
Pre-tax profit (Rm)	494,9	484,7	633,0
Attributable (Rm)	198,0	186,5	239,0
Earnings (c)	158,0	148,9	190,7
Dividends (c)	100,0	120,0	115,0

the most attractive would be if Rustplat succeeded in persuading the Receiver of Revenue to allow the group to spend the capital needed to develop the mine and offset this against its own revenues for tax purposes. Lebowa Plat would be paid a royalty from the mining operations at Maandagshoek.

Failing this, Lebowa Plat will have to pay for the development itself, either through loans or a rights issue or a combination of the two. Whatever route is taken will have a big impact on the share price. Analysts' valuations range from between 400c to 500c if funding is completely through a rights issue, to around 1 100c if Rustplat gets the tax break it wants to develop the mine from its own earnings.

The 25% rise in Rustplat's turnover and 21% increase in distributable profits reflect the improved platinum prices which ruled during the comparable accounting periods with exception of the sharp plunge from about US\$600/oz to about \$500/oz caused in late December by the Ford catalyst an-

nouncement. The price has recovered to around \$550/oz.

Davison remains confident on the future of the platinum market. "Demand remains firm and the price has recovered quite well from the slump caused by the Ford announcement," he says. "Demand and supply fundamentals remain sound and I believe this situation has begun to re-assert itself in the platinum price."

Brendan Ryan

BIDCORP

Worth trying

Investors who bid up the Iclaf share price from R3 to R7 after the announcement that Brian Joffe had bought it obviously knew what they were doing. Joffe bought Iclaf in October, at the same time announcing the acquisition of Walter A Chipkin (WAC) and in November Chipkin bought Sea World. Now there is more.

The circular to shareholders on the first deals had hardly been issued when a cautionary announcement was made this week. Market sources suggest this involves purchase of a cash shell, providing Iclaf, or Bid Corporation (Bidcorp) as it is now to be called, with finance for further acquisitions.

The transmuted listing statement states the intention of the company is to become an industrial holding company focused mainly on distribution business with the objective of listing each operating area. So there should be opportunities for shareholders to participate in rights issues of shares in Bidcorp subsidiaries. The first listing is planned for WAC.

Bidcorp intends a rights issue of 4m special class convertible debentures (SCRDs). These, which will raise R6m net, will not be convertible into shares of issuing company Bidcorp, but into shares in WAC in 1991, provided the latter company is granted a listing. WAC cannot be listed immediately, as JSE regulations preclude the listing of a pyramid within two years of listing.

Issued at par (475c), the interest rate on the SCRDS is 13% per year. If a listing is not granted, they will be redeemed at 550c, equal to a yield to maturity of 17,7%.

For the individual investor, the use of debentures rather than preference shares has tax disadvantages, but prefs would probably have carried a lower return and for institutions not paying tax, high-rate debentures are attractive.

As the SCRDS will be listed, Joffe sees them as an effective listing of the WAC interests and says they could be used for acquisitions. However, if Bidcorp buys another investment then it will no longer be a pyramid but a true investment holding company, and will be able to list its other interests immediately.

The SCRDS are not the only unusual part of this deal. Controlling shareholders are renouncing their rights to the SCRDS in favour of a specially created company, Sky-

top, which will take up and own 2,7m SCRDS. Joffe and associates will thus have control through Bidcorp and have no direct stake in WAC. Skytop will then be the company to buy any new acquisitions for Chipkin, using the SCRDS as payment, and it seems likely that Skytop will be the start of another division.

But what are Bidcorp and WAC worth? For Bidcorp, earnings calculations based on forecast earnings for Chipkin and Seaworld amount to R5,6m or 70c per Bidcorp share. The share price was R7 at time of writing, but analysts are still evaluating the document and this price is cum SCRDS rights (to be issued on the basis of 50 for 100 ordinary shares). Compared with the average price for the retail sector of 12,9, the price seems cheap.

The SCRDS are on what amounts to an effective dividend yield for institutions of 13%, but less for individuals, against the sector average of 4,8%, though this yield will only be for two years. Rights should be taken up and there is substantial leeway for buying rights on the market.

It will be interesting to see what value the market places upon this instrument, taking into account the convertibility of SCRDS, the fact that they are convertible into shares which are not yet listed, and Joffe's plans for the company. Discounting future earnings, analysts suggest that initial calculations put the right price for the SCRDS at a substantial premium to issue price.

Pat Kenney

MARIEVALE/RANDEX

Diversifying

Analysts differ in their opinions on the relative merits of the various mineral rights held by Marievale and Rand Extensions & Exploration (Randex). But they are unanimous that a deal combining them, referred to in a cautionary announcement on Tuesday, would be mutually beneficial.

Peter Bahnmann of Simpson McKie believes that Randex's prospects are, overall, of better quality than Marievale's. He was relatively unimpressed with the mineral rights injected into Marievale on its transformation into an exploration company on January 1 last year. He then valued these rights at 280c per share (compared with Marievale's price of 590c then and 330c now). Bahnmann valued Randex's mineral rights in March last year at 213c (its price was 255c then and is now 205c).

But he said Marievale's main business would be to trade in mineral rights, acquiring and exchanging them to best advantage.

And indeed, Marievale has been active. The most important, post-transmutation interest it acquired was a 25% participation right in 36 000 ha in the South Rand Basin, east of Heidelberg, and a 51% participation in three areas totalling 14 000 ha in the Free State from Southern Witwatersrand Exploration Company (SouthWits).

Marievale, Randex merge mineral rights

210

REINIE BOOYSEN

GENBEL'S Marievale and Rand Extensions and Exploration (Randex) have confirmed the conclusion of negotiations to merge their mineral rights and other interests, by Marievale acquiring the issued share capital of Randex.

Directors have agreed to the following terms: Marievale will issue 60 new Marievale shares in exchange for every 100 Randex shares. This means Marievale will issue a total of 22 600 814 new shares to existing Randex shareholders. At yesterday's share prices 60 Marie-

vale shares were worth R210, while 100 Randex shares were worth R205. Both share prices were fairly steady on the JSE. Randex eased 5c to 205c, and Marievale was unchanged at 350c, 110c higher than the 12-month low of 240c on February 21, and 25c below the 12-month high of 375c in November last year.

Randex chairman Ken Whyte said yesterday the deal would reduce Ran-

dex shareholders' risk profile, with a more diversified portfolio of mineral rights and interests.

It would also increase the size of its resources and business operations, and give Randex shareholders the opportunity to participate in the exploitation of some of Marievale's nearer-term ventures.

Genbel Investment's stake in the enlarged company will be diluted from 93% to about 67%, said Genbel MD Anton Botha.

B/Dan 1/3/87

Anglovaal close to decision on new mine

Star 3/3/89
210

By Derek Tommey

Mining house Anglovaal, which has increased its interim dividend by 13,6 percent from 220c to 250c, is spending tens of millions of rands on its Oribi and Sun gold prospects in the Free State. This suggests that it must be coming close to taking a decision on whether to establish its proposed new mine north of Loraine.

It reports today that it spent R20,6 million on these two prospects in the six months ended December and is planning to spend a further R20,7 million in the six months ended June. Most of this money is believed to have been spent on the Sun prospect.

Mr Basil Hersov, Anglovaal's chairman, reported in September that the company had completed a preliminary feasibility study covering 12 300 hectares in the Sun prospecting area.

The results had been sufficiently encouraging to justify a further

more detailed study to see whether a mine having an eventual milling rate of 5 million tons a year would be viable.

Because the mine would be relatively deep with workings ranging from 2 700 metres to 4 400 metres below surface, and therefore a high cost one, a fairly high grade gold deposit would be needed to make the mine payable.

Viability

He said that the overall gold recovery grade required for viability would have to be above the industry average of 5,3 grams a ton.

Mr Hersov said that the study would be completed in the second quarter of this year and he repeats in today's interim statement that shareholders would be informed of the results and any decisions arising from them as soon as possible.

Mr Hersov's comment should

help still market talk that Anglovaal has put the new gold mine on ice following its purchase of chrome ore producer Lavino and the acquisition of a 29,9 percent stake in an overseas gold mining company.

Meanwhile, Anglovaal's interim report suggests that the group would welcome a new mine to help boost its earnings from gold.

An analysis of its interim profit figures indicates that it was only a sharp increase in manganese earnings and the continued strength in Anglovaal Industries' profits that enabled it to report reasonable earnings growth.

Although operating profit rose 23 percent in the six months ended December to R228,9 million (R186,7 million), income from investments dropped 8 percent to R26,6 million (R29,0 million), and tax payments leapt 36 percent to R113,2 million (R85,6 million).

The result was a 9 percent rise

in taxed earnings to R142,3 million.

But a doubling in equity accounted earnings, mainly as a result of the improved profitability of the manganese investment, boosted net profits to R159,0 million — a 15 percent or R20,8 million increase on the R138,2 million earned a year ago.

Subsidiary

However, with 66 percent-owned subsidiary Anglovaal Industries increasing its earnings by 25 percent or R24,5 million to R123,6 million, it would seem that Anglovaal's non-industrial earnings overall showed no growth in the six months ended December.

Anglovaal's net profit after provision for minority interests and preference dividends was R78,6 million, up 12 percent on the R70,2 million earned a year ago.

Manganese interests aid earnings

Improved profits from Anglovaal

Cap. Trusts 3/3/89 210

By REINIE BOOYSEN

JOHANNESBURG. — Anglovaal's industrial and manganese interests countered the dull performance from the group's gold mine investments in the six months to December 1988 — resulting in a 12% rise in earnings attributable to shareholders, to R78,6m (R70,2m)

Subsidiary Anglovaal Industries yesterday declared interim earnings of R79,9m — 22% higher than the previous year's R65,7m. This largely explains the parent's 23% rise in operating profit, to R229m (187m).

The parent's earnings a share (ordinary and "A") are 1 836c (1 641c), and an interim dividend of 250c/share has been declared (14% above last year's 220c)

Income from investments — largely in gold mines — declined 8% to R26,6m (R29m)

The 106% rise in equity accounted earnings, to R16,7m (R8,1m) derives mainly from Associated Manganese Mines. The directors pointed out in August that "increased sales volumes

and higher US dollar prices for manganese and iron ores and for ferro-manganese and ferro-chrome, together with the lower average value of the rand against the dollar" were positive factors affecting the company's performance

Another interest which should have performed well was Prieska Copper Mines, also as a result of good metal prices. But because it only declared a dividend on February 14 — 20c/Prieska share, equivalent to 100c/Anglovaal share — this will only be accounted in the current half-year.

The consolidated costs of the group's exploration programmes in the northern Orange Free State, a feasibility study on the southern portion of the Sun prospect area, and certain mineral rights purchases amounted to R23,3m (R28,7m) — of which R20,6m was for the Sun and Oribi programmes

The market value of listed investments, mining subsidiary and associated companies on December 31 was R1 181,6m (R1 250,2m) as against book and carrying value of R257,4m (R242,8m). Anglovaal's net asset value had risen to R340/share (R322/share)

Blue chips pile on the points.

Industrials surge to a record high

~~210~~
210
B/Dam 8/3/87

BLUE chip shares surged on Diagonal Street yesterday to sweep the JSE industrial index up 1,7% to a record high of 2 303 points.

This easily surpassed its previous peak of 2 265 points set just before the collapse of share prices in October 1987 and represented a gain of 59,7% since the index bottomed at 1 442 points exactly a year ago.

In another buoyant trading session fuelled by another sharp decline in the value of the rand, the JSE overall index rose 1,3% to a new post-crash peak of 2 359 points.

The rise lifted the gains in the overall index to 50,8% from its low of 1 564 points exactly a year ago but the index is still well below its peak of 2 804 points reached on the day before the crash.

Helped by a huge demand for De Beers shares on its excellent results, the volume of shares traded doubled from 7,5-million on Monday to 15,15-million yesterday while the value of shares jumped from R65m to almost R100m.

MERVYN HARRIS

Dealers said the uptrend seemed more controlled than during the height of the boom. The market was soundly based on the back of large institutional cash flows with smaller investors still mainly on the sidelines.

Analysts believed the market could be set to move to higher ground as the gold price rebounded from early lows of \$385 in Europe to a high of \$392 in New York last night.

The rise came in the wake of buying by a managed fund account and local traders amid speculation that crude oil prices could jump to new contract highs.

Dealers said once crude oil made a convincing penetration of the contract high of \$18,88 a barrel it could go beyond \$19 a barrel.

Reuters reported that precious metals were also boosted by a rise in platinum prices which touched \$558 in New York.

● To Page 2 →

Industrial blue chips surge to record high

The metal closed in London at \$551,75

The gold price rise came too late to affect trading on the JSE but gold shares held up well, aided by a weakening in the commercial and financial rands.

Erosion of the value of the rand from just below R2,5100 to the dollar to R2,5260 lifted the rand price of gold R15 to R986,91. This is its highest level so far this year after falling to below R940 in February.

B/Dam 8/3/87
← ● From Page 1
210

The lower rand gave a fillip to rand hedge stocks on the JSE with most of the 28 shares reaching new highs yesterday and likely to benefit from increased earnings flowing through from overseas interests.

● See Page 12

Southern Unit Trusts make their maiden distribution

SOUTHERN Unit Trusts have declared a maiden income distribution of 2,7c a unit for the Southern Equity Fund and 2,79c on Southern Mining Fund for the period ended January 31. The trusts were launched in October.

"This distribution is one of the highest initial dividends to be declared by a unit trust fund and was paid to unitholders on March 1," Southern says.

Portfolio manager and head of Southern Unit Trusts, Carel de Ridder, says the income will automatically be reinvested on behalf of monthly investors while lump-sum investors may request cash.

"We advise that it be reinvested to maximise capital growth and most investors have opted for this route. Our objective is to provide long-term capital appreciation and a steadily increasing income year after year."

Ridder adds "We have assembled two portfolios of good quality shares to achieve this."

The combined value of the funds is R25m with more than 4 800 individual investors — Sapa

SA's mineral sales 16% up

CAPC - TRANS 10/3/89 210

JOHANNESBURG. — SA's total mineral sales in 1988 were 16% higher than in the previous year at R33,41bn, the SABC reports.

Provisional figures released yesterday by the Minerals Bureau show that export sales increased by 13,1% to just over R27bn. Local sales were 32% higher at R6,3bn.

Gold production climbed from 601 tons to 617 tons, resulting in sales of R19,6bn.

There were also significant increases in production of manganese ore, iron ore and chromite ore, although diamond production dropped by 7,3% to 8,3 million carats.

Meanwhile, Natal's nine anthracite mines are experiencing a boom period as a result of a sharp increase in the overseas demand for SA anthracite since October last year.

In addition, profits have been boosted by a rise in the export price from about R14 A ton in 1987 to R70 a ton last year.

As a result, exports last year totalled R234m, 27% more than in 1987 — in spite of the fact that 3% less anthracite was exported.

All anthracite mines in Natal are in full production because of the upsurge and a new mine has come into operation near Vryheid in the past 18 months. — Sapa

Mining (210) fund pays out R4m

CAPE TOWN — Old Mutual Mining Fund this week paid out more than R4,2m to about 27 000 investors in its latest distribution of 7c a unit, a 35,6% increase on the distribution of 5,20c paid six months earlier.

The latest distribution brings the total value of dividends paid to unitholders during the year to date to R7,1m.

About 80% of the total was re-invested, with the majority of investors opting to maximise capital growth.

"Bearish sentiments in the mining sector notwithstanding, investors in Old Mutual Mining Fund have earned handsome returns," said the marketing division's Stuart Fish.

Although essentially a long-term investment, a R10 000 lump sum invested on March 1, 1988, was worth R12 917 on February 28, 1989 — a return of 29,2%. In this case distributions were re-invested.

Portfolio manager Marco Celotti stressed that the mining fund offered long-term value mainly for two reasons.

Although current sentiment towards gold is bearish, there are still serious risks within the world economic structure, such as the US twin deficits, which have not been resolved and would lend support to the dollar price of gold.

Secondly, the mining sector is on the whole a beneficiary of a weak rand. This implies that the price of gold in rands will improve, which will benefit the profitability of gold mines. This trend is likely to prevail for the foreseeable future. — Sapa

SA's mineral sales 16% up

CAPC TRANS 10/3/88 210

JOHANNESBURG — SA's total mineral sales in 1988 were 16% higher than in the previous year at R33,41bn, the SABC reports

Provisional figures released yesterday by the Minerals Bureau show that export sales increased by 13,1% to just over R27bn. Local sales were 32% higher at R6,3bn.

Gold production climbed from 601 tons to 617 tons, resulting in sales of R19,6bn.

There were also significant increases in production of manganese ore, iron ore and chromite ore, although diamond production dropped by 7,3% to 8,3 million carats.

Meanwhile, Natal's nine anthracite mines are experiencing a boom period as a result of a sharp increase in the overseas demand for SA anthracite since October last year.

In addition, profits have been boosted by a rise in the export price from about R14 a ton in 1987 to R70 a ton last year.

As a result, exports last year totalled R234m, 27% more than in 1987 — in spite of the fact that 3% less anthracite was exported.

All anthracite mines in Natal are in full production because of the upsurge and a new mine has come into operation near Vryheid in the past 18 months — Sapa.

Record earnings rise for Amic

ANGLO American Industrial Corporation (Amic) has achieved a record 47% increase in attributable earnings to

LESLEY LAMBERT

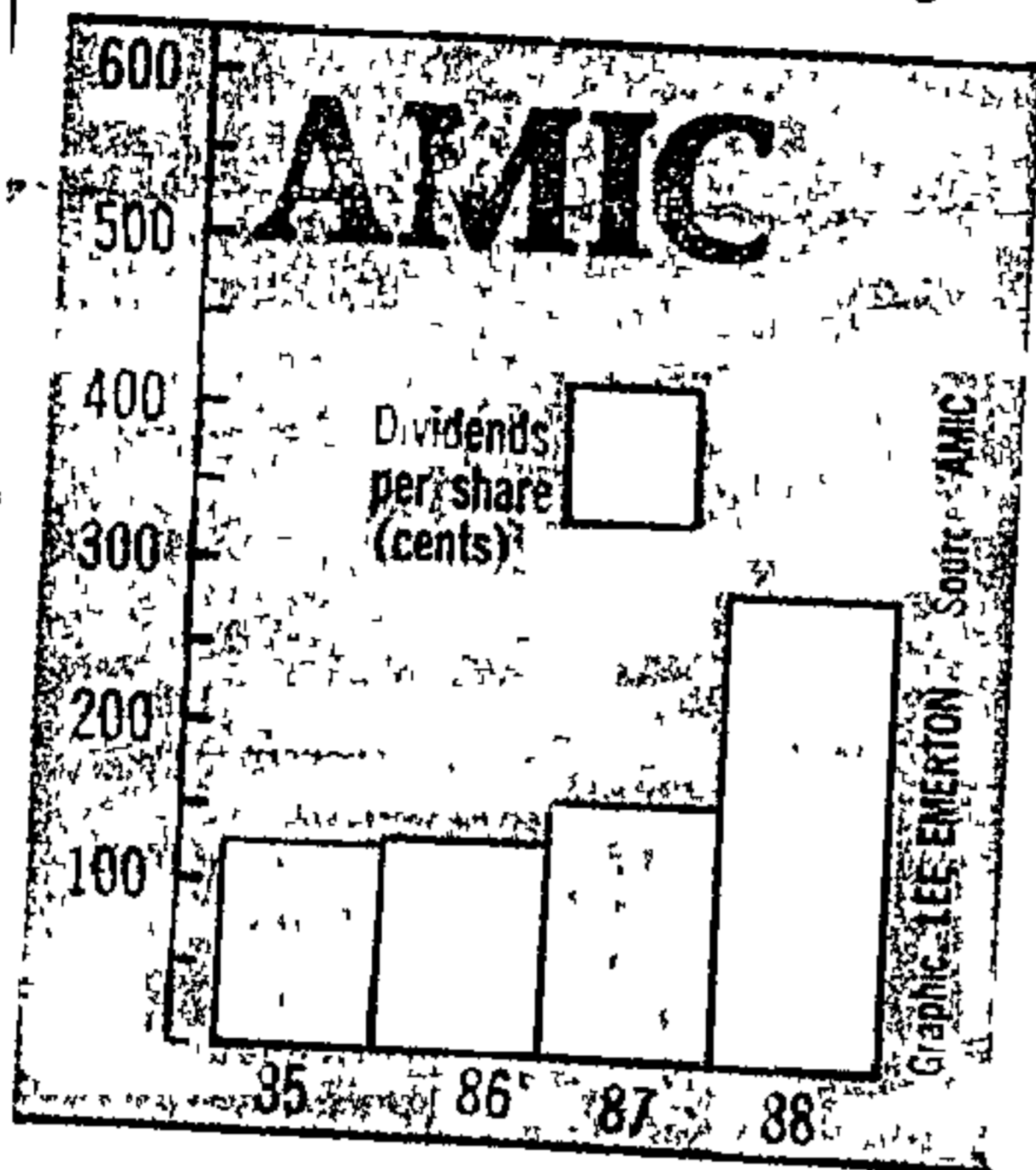

R517m for the year to December. Earnings a share exceeded analysts' expectations, advancing 43% to 963c. The increase in EPS was reduced by a larger share base.

A final dividend of 205c has been declared, bringing the total to 290c, a 29% increase. Dividend cover increased from 2,9 to 3,3 times.

Chairman Graham Boustred said the results were largely a reflection of a strengthening SA economy and the continuing resilience of world economies which stimulated strong export growth.

While 85% of earnings were contributed by AECL, Boart, Mondi, Scaw Metals and Highveld Steel, Boustred said every company in the widely-diversified group recorded growth in operating profits.

● To Page 2

Record 47% earnings jump for Amic

Highveld Steel achieved record production of more than one-million tons and turnover exceeded R1bn for the first time. Attributable earnings increased by 114% to R121m, or 171c (80c) a share.

Higher pulp and paper production and higher export prices enabled Mondi Paper to increase attributable profit by 56% to R162m, while Boart International achieved 54% growth in attributable earnings to R97m.

The group's major associate, AECL, boosted earnings by 20% to R255m, reflecting firm demand in the plastics, speciality chemicals, fibres, explosives

and paints divisions. The Tongaat group continued to build on its strong recovery and in the year to March increased earnings by 90% to R119m.

During the year Amic significantly reduced net borrowings from R976m to R720m. At year end debt equity had fallen to 25% compared with 47% last year and 71% in 1986.

The share gained R3 ahead of the results to close at a new peak of R80. It has doubled in value over the past year.

● From Page 1

Excellent year for base metals

B/Daw 10/3/89 210

Minerals sales show big leap in rand figures

REINIE BOOYSEN

THE SA minerals industry's total sales in 1988, locally and abroad, were slightly higher in terms of US dollars at \$14,7bn (compared with 1987's figure of \$14,1bn, according to provisional figures released yesterday by the Minerals Bureau.

In rands the improvement was much greater, rising by 16% from R28,7bn in 1987 to R33,4bn in 1988. By far the largest proportion of the SA minerals industry's sales are exports — 81% in 1988 — which are mostly denominated in dollars.

Therefore the rand export figure must be adjusted in accordance with the decline of the rand to provide a clearer picture of the industry's performance.

The rand declined from an average exchange rate of R2,037/\$1 in 1987 to R2,273 in 1988.

In dollars there was a slight improvement in SA export sales, from \$11,7bn to \$11,9bn. In rands the improvement was greater, from R23,9bn to R27,1bn.

Total sales of gold — which represented the largest chunk of SA's minerals exports, at 73% — were 12,5% higher in rands, at R19,7bn (R17,5bn), and only a fraction higher in dollars, at R8,66bn (R8,59bn).

The base metal industry did extremely well, in rands. Chrome exports rose 28% to R312m (R242m), copper rose 53% to R947m (R619m) and manganese

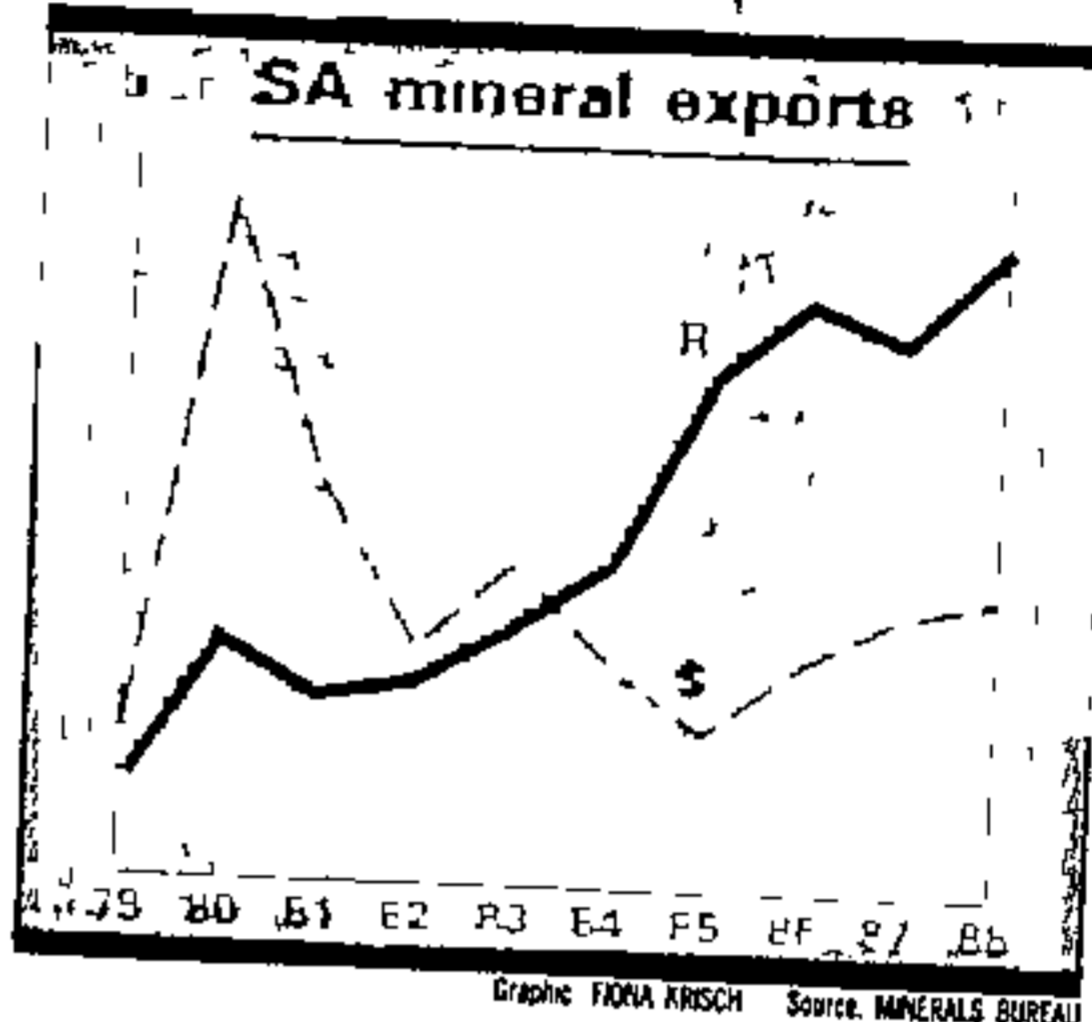

rose 91% to R337m (R179m).

The second largest contributor to export revenue was coal, at 10%. The better fortunes affecting the coal industry were evident in the rise in the unit price for coal exports, which rose 19% from R54/ton in 1987 to R64/ton in 1988.

Total sales (local and abroad) revenue for coal rose 20%, from R4,8bn to R5,7bn. The unit price of anthracite, a better quality coal, rose 32% from R57/ton to R75/ton.

Although figures are not disclosed for platinum group metal sales, there are figures for an important by-product of platinum production, nickel.

The surge in the nickel price on the London Metal Exchange during 1988 resulted in a near-tripling of total SA nickel sales (overseas and abroad), from R106m to R305m. In dollars the increase was 158%, from \$52m to \$134m.

Cash-strapped Joe Berardo is doing a deal

Business Times Reporter

JOE Berardo's Johannesburg Mining & Finance and subsidiary Egoli will be on a sound footing if a deal comes off

Financial director Don Grant-Hodge — in the absence on holiday of Mr Berardo — says that although JMF and Egoli have liquidity problems, there is no need for a rescue

"The companies continue to operate, though we shall probably have to raise money one way or another"

Mr Grant-Hodge says the pending deal will strengthen the group. He will not comment on whether the transaction involves a takeover or whether a foreign investor is involved

Mr Grant-Hodge would not disclose the whereabouts of JMF and Egoli founder and chairman Berardo

At the end of September 1988, the top company had total debt of R62-million against shareholders' funds of R253-million. Debt rose from R8,2-million in December 1987

Attributable profit in the six months to September was R2,8-million compared with R14-million in the nine months to March 1988. There was only R4,3-million of debt in Egoli, holding company for the mining operations

Mr Grant-Hodge says there are problems at Wit Nigel, but otherwise the gold mining and dump treatment operations are fine

The company's major mistakes were in the industrial area

"We acquired a large plywood factory, Ply Products, Natal. We had to sink a lot of capital into it. We had a similar problem at Tempo Engineering, which does specialised work. We are virtually out of both now"

"There will be capital losses, but at least we won't have to continue absorbing losses. The problem was that we never had a managing director for our industrial operations"

Mr Grant-Hodge says Wit Nigel's problems do not affect the rest of the group.

"It is an investment in Egoli and Waverley Negotiations are under way. This week we reduced staff numbers"

"When we took over, we found a lot of arrear debts that had to be paid. There was debt for the company's pension fund contributions and amounts were owing for PAYE"

Mr Grant-Hodge says JMF is not trying to sell its splendid new head office on the corners of Fox, Simmonds and Commissioner streets, Johannesburg

Mr Grant-Hodge hopes JMF and Egoli will be able to make further announcements soon, "but documentation and technical formalities have a habit of delaying things, so I cannot be sure"

Focus goes shopping

INNOVATIVE retailer Focus Holdings is off again on the acquisition trail. Its latest deal could boost earnings in the current year by 35%.

It has taken over the retail operations of listed Cashworths Fashion Holdings for R4-million. Cashworths manufacturing operations are not included in the deal

Details will be announced tomorrow, but the addition of Cashworths' 28 speciality women's clothing stores to the Focus chain of men's clothing and bedding stores will strengthen the group.

There will be 76 stores in the retail division, with forecast sales of R60-million in the year which began on March 1

If the deal had been in the place for the last financial year earnings would have increased from 8c to 10,5c a share. Now it looks as if Focus will earn 13c in the current year fully diluted and assuming a full tax rate.

v
a
i
A
d
p
t
r
e
at
fit
55
wi
F.
re
an
£2
cr

5/11/87

210



1
E
N
G
L
I
S
H
P
R
O
B
L
E
M
S
C
O
L
L
E
C
T
I
O
N
S
A
N
D
O
T
H
E
R
I
S
S
U
E
S

Gencor spins off mining divisions

210
Stew
15/3/89



Steve Ellis



Colin Officer



Brian Gilbertson

By Derek Tommey

General Mining Union Corporation (Gencor) has streamlined the management of its mining division by forming a new corporation, General Mining Metals and Minerals Limited, which will take control of all its mining operations.

These include 12 gold mines, its Impala Platinum Mine, its Samancor mine and Trans-Natal Coal Corporation.

The new arrangement is intended to generate increased growth in the group's mining interests by setting "challenging targets" for the men running it who will control an autonomous management company within the Gencor group.

The three men heading the mining division will become the top executives at Genmin. They are Mr Steve Ellis (55), who will be chairman, and Mr Brian Gilbertson (45) and Mr Colin Officer (53) who will be deputy chairmen. Other directors will be Mr Derek Keys, chairman of Gencor and Mr Naas

Steenkamp, head of corporate affairs.

Mr Ellis said the decision to establish Genmin was in accordance with Gencor philosophy that with the exception of some limited services of general interest, Gencor does not run anything at the centre.

The group's mining and related activities were previously spread over various divisions under different executive directors.

Unlike other major components of the Gencor group, no separate management group existed for mining to which the obligation to grow could be delegated.

Genmin will carry out its obligations to its parent in terms of an agency agreement of undecided duration at this stage.

It will promote and maintain its own corporate identity.

However, no assets will be transferred to Genmin, at least at this stage, and Genmin does not contemplate a listing on the stock exchange.

Gencor unwraps new company

B/Dair 15/3 189 .

210

GENCOR yesterday finally unwrapped its plan to delegate the management of all the group's mining-related interests to an autonomous company called General Mining, Metals and Minerals (Genmin).

This is another step in executive chairman Derek Keys's restructuring of the mining house, initiated when he took charge two years ago. His tenure has been marked by a drive to decentralise and rationalise Gencor's operations.

The investment holdings of Gencor in subsidiary mining interests will not be transferred to Genmin. Genmin chairman (and Gencor executive director) Steve Ellis said there was also no plan to list the company, "although this may be considered at some future time".

Ellis said Genmin would function as a separate management company within the Gencor group, under its own board of directors. It would guide and monitor the strategic direction of Gencor's mining interests. The listed companies are 12 gold mines, Impala Platinum, Samancor (base minerals) and Trans-Natal Coal.

Gencor's platinum interests will fall under Ellis, and he will be supported by two deputy chairmen, Brian Gilbertson (to head gold and coal) and Colin Officer (to head Samancor). At this stage, the only other directors are Derek Keys and

REINIE BOOYSEN

Naas Steenkamp, but "more appointments will be made as and when necessary".

Ellis said: "The establishment of Genmin provides Gencor with a separate management group to be entrusted with the obligation of achieving long-term real growth and a leading position in the mining, metals and minerals industry."

This objective would be achieved through exploration, development and acquisition, and promoting the momentum of existing enterprises for which Genmin was accountable to the holding company.

Ellis said the move would place Gencor's mining people in a single unit with which they could identify.

Genmin would ensure that all obligations imposed on it by Gencor in terms of the various agreements with mining and mining holding companies relating to the provision of technical and other services would be properly fulfilled.

These included consulting engineering services, purchasing, geology and exploration and specialised services, including safety and health control, human resources and communication, law, accounting and finance.

Mining taxation cuts welcomed, but there's also disappointment

Star 16/3/89

210

Finance Staff
Anglo American's tax consultant, Mr Marius van Blerck, said he was extremely disappointed at the Government's failure to lay down a timetable for the implementation of the Marais Commission's recommendations on mining taxation.

The Minister of Finance, Mr Barend du Plessis, announced in his Budget yesterday a small change in mining taxation, which would cost the State about R31 million in lost revenue from gold mines and R22 million from other mines. But he said that no timetable for the other recommendations could be specified.

The new comprehensive tax formula for mines will consolidate the existing formula tax and the surcharge of 25 percent, and will slightly reduce them.

The maximum theoret-

ical marginal rate will fall from 70,5 percent to 68,72 percent, while for non-gold mines the surcharge of 15 percent above and beyond the normal tax will be reduced to 12 percent.

Mr van Blerck said he welcomed the reduced tax rate as a first step in implementing the Marais Commission's recommendations, although the reduction itself was not really significant.

However, failure to specify a time table would create considerable uncertainty in the mining industry, delay decisions and affect its long-term planning.

The Chamber of Mines yesterday welcomed the commitment to the future of the mining industry reflected in the Budget. The chief executive of the Chamber, Mr Tom Main, said "The tax concessions announced by

the Minister of Finance are an important first step towards implementation of the recommendations of the Marais Technical Committee on Mining Taxation.

"The new formula tax for gold mines and the reduction of the surcharge on non-gold mines from 15 percent to 12 percent are precisely in line with the first year phase-in recommended by the Marais Committee.

"They are a move towards a reduction in the overall rate of mining taxation and thus represent a very welcome reversal of the trend in recent years. While the Minister has indicated that he will consider further reductions on a year by year basis, the Chamber hopes that he will find it possible to adhere to the timetable proposed by the Marais Committee," Mr Main said.

By Dan Side

In response to the reimposition of petty apartheid by certain Conservative Party-controlled town councils, the giant Anglo American Corporation will not provide support to councils which racially restricted facilities or activities.

In a communique to group employees, Anglo chairman Mr Gavin Relly said the corporation could only achieve its aim in a society freed from racial barriers

The corporation's aim, he said, was to create wealth in ways that were beneficial not only to shareholders, but to all employees and the South African community as a whole

Anglo refuses support for 'apartheid' councils

He felt there was little good in Anglo doing everything it could to employ, train, promote and reward its employees irrespective of race, when those employees had to contend with racial discrimination in the communities in which they lived

"Anglo's relationship with all levels of government, especially town councils, is governed by the corporation's desire to encourage in a constructive way the end of racial discrimination," said Mr Relly

"The corporation will accordingly not provide any support to town councils for racially restricted facilities or activities"

However, Anglo would not take action against individuals with whom it conducted business, simply because they served on town councils promoting the reintroduction of petty apartheid

"We believe individuals are entitled to their own political beliefs and our main concern is that they conduct them-

selves in a businesslike, ethical way," he said

"Naturally we reserve the right to act if they fail to meet these standards, or undermine the progress we have made"

Under the same philosophy, Anglo felt it was up to the individual to decide whether or not he wanted to join a trade union — and to have the right to have that decision respected by both trade union and employer

A society free of racial barriers would not be advanced by punishing individuals who did not share the view that prosperity for all depended on an end to such discrimination, he said

was anticipated at the beginning of the year," Mr du Plessis said

a rate of only about 1 percent, Mr du Plessis concluded

"Mining taxation cuts welcomed, but there's also disappointment"

Star. 16/3/89

210

Finance Staff

Anglo American's tax consultant, Mr Marius van Blerck, said he was extremely disappointed at the Government's failure to lay down a timetable for the implementation of the Marais Commission's recommendations on mining taxation

The Minister of Finance, Mr Barend du Plessis, announced in his Budget yesterday a small change in mining taxation, which would cost the State about R31 million in lost revenue from gold mines and R22 million from other mines. But he said that no timetable for the other recommendations could be specified.

The new comprehensive tax formula for mines will consolidate the existing formula tax and the surcharge of 25 percent, and will slightly reduce them

The maximum theoret-

ical marginal rate will fall from 70,5 percent to 68,72 percent, while for non-gold mines the surcharge of 15 percent above and beyond the normal tax will be reduced to 12 percent.

Mr van Blerck said he welcomed the reduced tax rate as a first step in implementing the Marais Commission's recommendations, although the reduction itself was not really significant.

However, failure to specify a time table would create considerable uncertainty in the mining industry, delay decisions and affect its long-term planning

The Chamber of Mines yesterday welcomed the commitment to the future of the mining industry reflected in the Budget. The chief executive of the Chamber, Mr Tom Main, said "The tax concessions announced by

the Minister of Finance are an important first step towards implementation of the recommendations of the Marais Technical Committee on Mining Taxation

"The new formula tax for gold mines and the reduction of the surcharge on non-gold mines from 15 percent to 12 percent are precisely in line with the first year phase-in recommended by the Marais Committee

"They are a move towards a reduction in the overall rate of mining taxation and thus represent a very welcome reversal of the trend in recent years. While the Minister has indicated that he will consider further reductions on a year by year basis, the Chamber hopes that he will find it possible to adhere to the timetable proposed by the Marais Committee," Mr Main said

Changing face of industrial relations

THE years 1979 to 1989 yielded more fundamental change in industrial relations than any other time in the history of IR

Chamber of Mines senior general manager of external relations, Johan Liebenberg, told the second post-Wiehahn decade conference in Pretoria that the commission's proposals had changed the law and climate of labour relations. But it was up to employers to bring about change.

Mr Liebenberg said the Wiehahn report had resulted in

- The unionisation of unskilled and semi-skilled workers. It had led to the rapid growth of the National Union of Mineworkers (NUM), culminating in 1987 when the union had 184 000 paid-up members. It became the largest trade union in South

Africa, if not in Africa

- The advancement of blacks into white positions. At the beginning of March this year, about 5 000 of the 50 000 skilled positions in mining were held by blacks, coloured and Asians

- The legal profession had been the winner. Mr Liebenberg said one of his criticisms of the industry was that it had become too legalistic. But old-fashioned, emotional collective-bargaining was being phased out.

- The growing insecurity of white employees which was not necessary as they would continue to be important in mining.

- Increased violence on the mines. Blackie Swart, head of the industrial relations research unit at the University of Stellenbosch Business

School, talked on trends in labour relations. He said the removal of legislative discrimination was not enough, but must go hand-in-hand with a non-discriminatory labour market

"This has happened to a certain extent with the abolition of influx control and the opening of certain business districts. However, it has been said that the only difference between the Government's ideology and that of its opposition is that the Government has been prepared to do away with petty apartheid

"Industrial relations has become an island of equal opportunity in a sea of discrimination. Unions have been forced by the Government to become open avenues for the social, political and economic grievances

of the people

"Apartheid cannot be reformed, it must be abolished. Employers will have to take a stand on this, as well as national and international issues"

Looking at demographic trends, Professor Swart said that in 1951, blacks accounted for 67% of SA's population, by 1985 for 73% and by 2010 they were expected to make up 80% of the people

5/1/89
26/3/89
12

Modder options doubt

By Julie Walker

THE price of Modder B options jumped from 1c to 5c since the end of February, but I expect the price to return to a cent soon

The options must be exercised by April 23, 1989, at a price of 200c. This makes a total of 206c for a new Modder B share. The catch is that Modder B shares are trading at only 32c.

Its notice to option holders contains an interesting paragraph "The company will issue share certificates for the shares allotted as a result of the exercise of the options within 21 days after the rela-

tive exercise of the options, and will at its expense apply for and use its best endeavours to obtain a listing of the shares to be allotted pursuant to the options on the JSE."

It implies that there is a chance that the new ordinary shares will not be tradeable on the JSE.

Surely nobody will exercise the options when it means effectively paying six times as much for the same share. If the options are not exercised, they will lapse,

and today's buyer at 5c will have lost his investment unless he can sell them to the naive.

Modder B management has already deferred the exercise date of the options from last July when Modder B shares were about 50c on the grounds that the money was no longer needed at that time following a deal with neighbouring Cons Modder.

Loucas Pouroulis is now the managing director of Modder B and Cyril Heever the chairman. Listed in 1985, Modder B has yet to acquit itself in the manner forecast in the prospectus.

Getting more ^{AKUS} from ^{78/3/89} gold ore

The Argus ²¹⁰
Foreign Service

LONDON. — A process being investigated now by De Beers involving the use of microbes to release residual gold from low-grade ores, could transform South Africa's economy, some mining experts believe.

Old mines could be revitalised and new profits could be extracted from the dozens of dumps which dot the gold-mining world.

De Beers is "very interested" in the process — called bacterial leeching — and is currently co-funding a study with Mintec at Vaal Reefs.

Much of the research into microbes such as T-ferro-oxidans which eat their way through spoil-heaps and release soluble compounds of valuable metal, has been conducted at King's College in London.

So far researchers have found bacterial leeching is best suited to low-grade copper and iron ores. De Beers and companies in Australia and Canada are hoping to be able to adapt the process to recover gold which would otherwise be too expensive to extract.

ALTERNATIVE

Scientists, including inorganic chemist Dr Jack Barrett, believe the microbes will eventually dramatically reduce capital outlay, as well as running costs, and could perhaps even replace the alternative processes of roasting and pressure-leeching.

So far, however, there is no indication of when — or if — the process will become commonplace. But a De Beers spokesman in London said "We are very interested in the process, and are at the moment involved in an extensive study in South Africa." ●



COLIN FENTON

Inflation is mining's most pernicious enemy

THE South African mining industry was being subjected to "unprecedented pressure," Mr Colin Fenton, President of the Chamber of Mines, said yesterday.

He told the annual meeting of the Association of Mine managers that the fact that the gold price had been below \$400 an ounce for some time, combined with rising costs, was having a negative impact on economic viability.

"Nowhere is this more starkly

illustrated than in the fact that almost 8 000 employees on five gold mines have been retrenched in recent months."

He said milling costs had risen by 13 percent to R107 a ton during the past year "a substantial and crippling hike by anybody's standards."

Mr Fenton pointed out that while gold output rose from 604 tons in 1987 to 619 tons in 1988, profits decreased by 1,6 percent.

The rise in costs could be laid at the door of the high rate of inflation, which was squeezing the marginal mines and undercutting their ability to develop.

"It is clear to me that inflation is our most pernicious enemy. It is eroding profits and threatening livelihoods," he stated.

The industry would back any measures necessary to reverse the upward trend of inflation, but

there was little cause for optimism in the recent Budget, with the Government seemingly prepared to accept an inflation rate of 15 percent, Mr Fenton said.

"This approach is contradictory to both the long and short term interests of the industry. Helping to devise the means to curtail ongoing double-digit inflation will become one of the major challenges we will need to confront in the immediate future."—Sapa.

Generous offer for Mooi River

Nov 4/84

210

By Ann Crotty

Just a week after its generous offer to buy out minority shareholders in four of its subsidiaries, Anglo Vaal Industries (AVI) has astounded the market with its R11,50 a share purchase of Mooi River Textiles

This puts it on a P/E rating of 15,4 times

Major justification for the apparently high price includes the favourable outlook for the textile market and the replacement cost of the assets being acquired

The deal seems to indicate that AVI does not hold out too much hope for the rand over the next few years

A weak rand should enhance the earnings performance of the textile industry because it significantly reduces the degree of import competition. In addition, a weak rand makes the cost of replacing assets extremely expensive

The purchase prices of last week's offer to buy out various minority shareholders were all pitched above book net asset value and indicated an awareness by AVI of the cost of replacing them

Underlying the pricing strategy on both of these deals is a grim outlook for the rand

If the outlook and pricing strategy take hold in the market, share prices could rocket to unreasonable levels in terms of historic earnings performances and dividend yields

Details of the latest deal, which prices Mooi River at R78,2 million, took most analysts by surprise, not

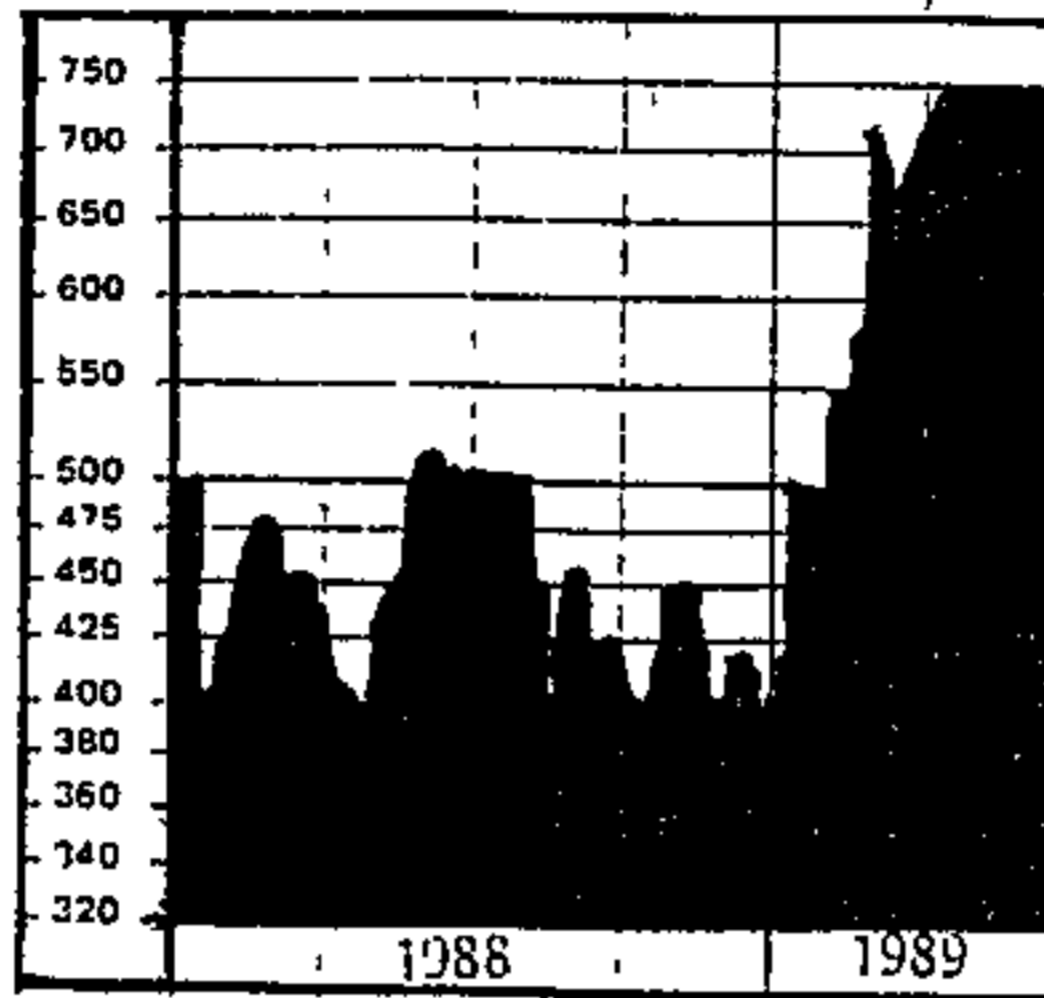

Mooi River share price

only because Romatex had been heavily tipped as the buyer, but more so because of the unexpectedly high price at which it has been pitched

The Mooi River share was suspended on Friday at 750c after weeks of speculation about change of control.

Speculation put an upper limit of 900c on the deal and this was considered expensive on the basis of its historic earnings performance

In the 12 months to December 1988, Mooi River reported earnings of 74,4c a share and declared a dividend of 40c, putting the deal on a P/E of 15,4 times and a dividend yield of 3,4 percent

The average P/E rating for the sector is 5,1 times and the average dividend yield is 5,8 percent.

At the beginning of the year SAB bought textile group Da Gama on a P/E rating of seven times. The market considered this to be on the

generous side

Mooi River's operating performance in recent years has been far from impressive

Net asset value at the end of financial 1987 was around 280c a share. But ahead of today's announcement, a number of analysts believed this could be as high as 700c if the group's property assets were valued at current prices

AVI holds a very different view. Executive director Dave Royston says that at the end of December 1988 the replacement value of Mooi River's plant and equipment was R125 million

Add to this an independent valuation of Mooi River's land and buildings of R24 million and it looks as though AVI has got a bargain. But analysts disagree on the extent to which it is appropriate to price equities on the basis of the replacement cost of the underlying assets

On the operation front there is little doubt that, freed of its Dutch parent (which has been keen seller since 1981), local management should produce an improved performance

Moreover, Mooi River fits in well with AVI's existing textile interests and prospects for the textile industry look good

But in terms of earnings performance it is difficult to see Mooi River justifying the price for a few years down the track. Mr Royston says "We've got to take a strategic view"

Inside
Out
Ann
Crotty



The outer limits

WELL... Myles didn't get it exactly right. The Mooi River deal wasn't with Romatex and the R11,50 was significantly above the 900c that he stressed (emphatically) was the upper limit. "Wouldn't pay more than 700c myself" was Myles' comment earlier this year.

I let him know that this sort of thing did severe damage to his street cred. He whinged a bit and pointed out that even the guys down at Mooi River hadn't known what was going on. I pointed out that at least they hadn't gone around letting on to everyone that they did know.

Myles then said that as far as he was concerned the AVI/Mooi River deal so stretched the bounds of credibility that he could not be held responsible for being "a little off the mark".

The speculative investors who had moved into Mooi River ahead of the deal seemed to be pouring out of it after the announcement Myles said that it was almost as if they couldn't believe their luck and wanted to get the money in case AVI changed its mind. Yesterday the share was trading at R11.

According to Myles, the big game in the market for most of the week was trying to identify the next possible AVI acquisition. As Myles saw it: "At this stage AVI is beginning to make FSI look steady and boring — imagine FSI only paying market price for W&A back in October 1987."

Talking about FSI, it seems that the FS-Team deal should be announced week after next or thereabouts.

The pharmaceutical sector appears to be attracting some positive attention, with all sorts of talk about deals being done, particularly about Noristan. It's probably inevitable that FSI got a mention in the list of possibles involved.

Punchline came in for a bit of a battering during the week. The share closed at around 130c, down from 200c last week. It seems that the market is expecting disappointing figures from this company, reflecting the difficult trading conditions in Punchline's market.

Trintex, which supplies the clothing industry, had a good week with some institutions involved in a large book over on Wednesday. On Friday the share had reached a high of 160c.

On the mining front, Myles couldn't give me any good reason (not even a good guess) as to why the Sankorp/Impala/Messina deal was taking so long. "They probably don't like to rush into things".

On Thursday I got the impression that Myles was going through another one of his identity crises (Public holidays have that sort of effect on some people) Initially he seemed reluctant to talk but eventually he opened up. Said he was sick-to-death at what he feels is becoming Johannesburg's favourite sport — "broker-bashing".

Seems he read on the KNOW Reuters screen that scientists in Sydney (Australia) are using stock-brokers instead of rats in their experiments.

"Why?"

"Three reasons: there are more stockbrokers than rats; the experimenters don't get emotionally attached to the stock-brokers and; there are some things that even a rat won't do."

I told him that sort of talk was scandalous and promised not to repeat it.

But it seems his Mum thought it was quite funny. He told her the story, expecting considerably amounts of sympathy, forgetting that at the best of times she's fairly insensitive. She only stopped laughing when he threatened to make her watch reruns of Diagonal St.

More news on the mining front - there was a lot of attention around Knights which is expected to declare reasonably good dividends in the current financial year. And it seems that Southwits is about to make an announcement about a successful prospect. Myles was a bit vague about what exactly had been discovered — gold, coal, platinum, chrome...

On Friday evening his Mum was expecting to hear about her £16 full cash offer from Minorco for her Consgold shares.

UAL's trusts perform well in March quarter

B/Day 10/4/87

210

UAL Unit Trust, the general equity trust in the UAL stable, achieved a 52,5% return for the 12 months to March 1989 and a 36,5% increase over the first quarter of 1988

The fund increased its income distribution by 25,6% with a distribution of 17,15c a unit (10,73c)

UAL Unit Trust Management Company MD Clive Turner says the UAL Unit Trust was a major beneficiary of the improved market circumstances in the past six months.

However, the March quarter

portfolio was largely unchanged from that at the end of 1988. Liquid assets increased to R39,6m (13,5% of total assets) from R30,7m (12,8%), while the value of the fund's shareholdings rose to R251m (85,7%) from R206,1m (85,9%)

The exposure to the gold sector was reduced through the disposal of Western Deep shares. A new holding was Riche-mont (300 000 shares) and the existing holding in Barlows was increased

The total portfolio reflects a concentrated and focused profile incorporating the major high-quality stock on the JSE, says Turner

• TURNER

LIZ ROUSE

UAL Mining and Resources Unit Trust also showed an improvement in income distribution of 15,06c, a 19,5% year-on-year increase and a 42,7% increase on the first 1988 quarter

The overall return of 41,8% is an excellent return for a specialist equity trust in the mining sector, comments Turner

UAL Mining participated in the recent improvement in mining share prices. Activity was concentrated in maintaining a realistic balance in the portfolio across the various sub-sectors of the mining board

Outlook

The fund's size at the end of March was R227,6m with liquid assets totalling R40,2m (17,7% of total assets)

Randfontein, Western Deep, Randex and Lefkochrysos were sold while the fund's existing positions on ET Cons, Lebowa and Midwits were consolidated

UAL fund managers say the outlook for the remainder of the year will depend largely on the inter-relationship between the gold price, the rand exchange rate and the direction of interest rates. They foresee a modest improvement in the gold price in the remainder of the year but do not expect a major movement from current levels in the

short term

UAL Selected Opportunities Trust was only launched in July 1987 and therefore does not have a comparative annual track record

It was the most active of UAL's four trusts during the quarter and further consolidation of the portfolio took place. The fund's total assets increased to R59,4m from R49,4m with liquid assets standing at R6,1m (10,2% of total assets)

Additions were made to the number of holdings and new additions were Hunts convertible debentures, African & Overseas and Delta Electrical

The holdings in Springtex, Western Areas, Amshoe and NEI Holdings were sold

The half-yearly distribution in March 1989 increased to 24,31c a unit from 23,73c distributed in the previous comparable half-year

UAL Gilt Trust, which was also launched in July 1987, increased its income distribution for the half year to 79,47c a unit from 56,93c from the equivalent period in 1988

Because of adverse conditions in the arena in which it invests, total assets declined slightly to R61,8m (R63,4m). While liquid assets rose to R46,9m (R32,3m) approved assets declined sharply to R14,9m (R31,1m)

Sage trusts' results mirror market recovery

(210)
SYLVIA DU PLESSIS

SAGE Fund Unit Trusts' investment strategy during the past quarter reflected increases in a number of holdings, including De Beers, Allied Group, Barlows, Remgro, Sasol and Sappi prefs.

However, the holding in Randfontein was reduced, while Cons Gold, Doornfontein, Libanon, Ofsil, Amgold and Minorco were disposed of. A new holding was established in Walhold.

The Fund's performance for the year to end-March mirrored the recovery in equity markets, and the overall return to unitholders for the period — capital plus income — was 46,4%.

Investment activity in Sage Resources Fund was reflected in additions to the holdings in De Beers, Lydenburg Platinum, Fedfood, New Wits, Sentrachim and Vogels.

New holdings were established in Messina, Highveld and Union Steel.

The total holdings in Southgo and Western Deep were disposed of, while the exposure to Lebowa was reduced.

The total return to Resources Fund unitholders for the year under review was 41,6%, with the top 10 holdings including Sappi prefs, De Beers, Gencor, Samanco, Genbel and JCI.

What price assets? 210

Recent deals struck by Anglo Vaal Industries (AVI) have drawn attention to the notion of valuing equities according to the cost of replacing underlying assets

The R78,2 million paid for Mooi River was stated to be reasonable in view of replacement costs estimated at R149 million (including R24 million for land and buildings) By contrast, on the basis of historic earnings performance, the price of R11,50 a share put the deal on a P/E rating of a 15,4 times

If the notion of replacement valuation gained general acceptance, share prices would soar to dizzy heights, in most cases leaving behind any reasonableness in terms of earnings and dividend yields

Although there may be grudging acceptance of the wisdom of the AVI/Mooi River deal, there is great reluctance to accept "replacement valuation" of equities A leading institutional player says: "Ultimately assets are only as good as the earnings they can produce"

A move to revalue assets at replacement cost would make the current earnings performances look quite paltry in terms of return on assets.

Cash investment

In the year to December 1988, Mooi River earned R5 million, representing a 3,3 percent return on the replacement valuation of assets. If the R78,2 million price is used, the R5 million reflects a more respectable 6,4 percent return If the approximate R500 000 (after tax) management fee is added to earnings, the R5,5 million reflects a 7 percent return on AVI's cash investment.

Assuming the deal can be made tax efficient, the return to AVI begins to look almost reasonably attractive, and this is before any allowances are made for a pick-up in earnings that could result from an improved performance under local ownership and/or an improvement in trading conditions.

If shares had been used to fund the deal, the picture would look quite different

Diagonal Street

ANN CROTTY

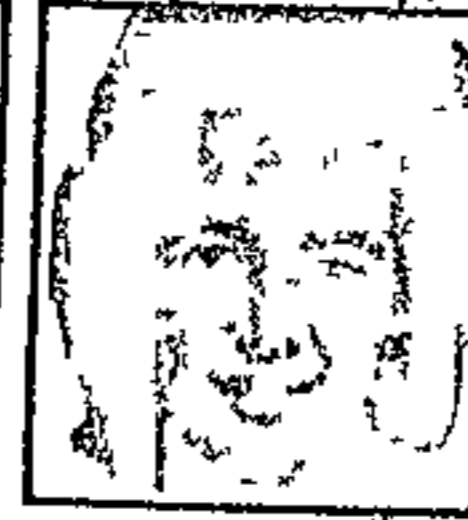

Institutional investors say the use of replacement valuation can only be used in exceptional circumstances These include a change of control and the prospect of a considerable enhancement of earnings

Another institutional player says: "Our investment strategy is based on forecasts for the earnings that can be sweated from assets and not so much on the value of the underlying assets. If the assets cannot be worked, they are not attractive at any price."

The notion of replacement value is not entirely bullish for share prices as it draws attention to the prospect facing every company of having to make sufficient investment to ensure that plant and equipment are kept up-to-date

Because of the depreciation of the rand, existing assets will have to be replaced at higher cost. With many companies close to full capacity, this investment will have to be undertaken in the not-to-distant future and is likely to coincide with a time when growth in earnings may not be as strong as it is currently

It is significant a leading analyst's view that as a result of low capital expenditure over the past several years, Gentyre needs spend at least R100 million over the next three years "to restore it to a solid capacity and technology footing"

Gentyre chairman Terry Rolfe believes if the necessary assets are to be bought on the open market, the bill could top R100 million. But he says that because of a situation of "reverse engineering" in the local tyre industry and because of Gentyre's ability to adapt technology and assets that are more cheaply available to it, the same effect can be achieved for R50 million

It is difficult to estimate to what extent this strategy is available to other industries, but the depreciating rand does make replacement costs look daunting.

LIZ ROUSE

COMPANIES

Old Mutual fund achieves record distribution

LD Mutual Investors' Fund has declared a record distribution of 42,46c for the six months ended March 1989, an increase of more than 60% over the previous distribution and bringing the total for the year to 78,41c.

During the past quarter substantial inflows from investors and the strength in the equity market resulted in a R274m increase in the market value of the fund, now totalling R1,5bn. This fund is by far the largest in the SA unit trust industry.

During the quarter the repurchase price of units in the Investors' Fund rose

by 20% and by 16,8% in the Mining Fund.

"The Investors' Fund has yielded excellent returns for investors," said Stuart Fish, AGM marketing. "On March 31 a R100 a month investment yielded 47,9% after one year, 22,8% a year after three years, and 29,3% a year after five years. In all cases dividends were reinvested."

Old Mutual Mining Fund benefited from the strength in the gold and mining counters, with the market value of

the fund increasing by almost R30m to R156m.

Commenting on market trends, Investors' Fund portfolio manager Rowland Chute said the March quarter saw the JSE industrial and all gold indices appreciate substantially by 25,5% and 22,7% respectively.

"The industrial index was supported by very good dividend and earnings growth and the all gold index moved strongly in spite of a decline in the dollar gold price and a flat rand gold price

"The recent strong gains in both the industrial and gold markets seem to indicate that unless the fundamentals improve, the recent period of strength could suffer a setback."

The Investors' Fund experienced a quiet trading quarter, the only acquisition being an initial purchase of Barprop. The 10 largest holdings in the fund are Anamint/De Beers, Richemont, Rembrandt Group, Safren, Anglos, Sasol, Gencor, JCI, Anglovaal Industries and Driefontein.

The Mining Fund was a net buyer with the action centred mainly on good-quality gold shares such as ET Cons, Elandsrand and Unisel. The fund also added to its Anamint, De Beers and PGA holdings.

As a result of the buying activity and better share prices, liquidity was reduced to 16,1%. The 10 largest holdings in the fund are Anamint/De Beers, Gencor, Anglos, Sasol, Driefontein, Amcoal, Samancor, GFSA, Witbank and Western Deep.

Anamint's
total dividend ²¹⁰
has risen 81% ⁰⁷

MERVYN HARRIS

ANGLO American Investment Trust (Anamint) has declared a final dividend of 2 370c a share for the year to March

This, with the interim dividend of 530c a share, boosts total distribution to 2 900c (1 600c), up 81%

Anamint derives most of its income from its 25,8% shareholding in associate company De Beers. During the year under review, its dividend income from this investment increased by 82% to R196,4m (R108m), while income from unlisted investments rose R44,1m to R98m

After allowing for interests earned, administration expenses, taxation and preference dividends, Anamint's earnings attributable to ordinary shareholders, excluding its share of retained earnings of its associate, amounted to R292,4m (R160m), or 2 924c a share

Earnings, including its share of its associate's retained earnings, rose to R861,4m (R440,1m)

Anamint's share of its associate's retained earnings is transferred to a non-distributable reserve

New Cent Wits' earnings rise slightly

Bldg 12/4/87

210

ANDREW BUDDEN

NEW Central Witwatersrand, an investment holding and mineral rights prospecting operation, has announced slightly higher earnings in the six months to March 31

The Anglo company yesterday announced its intention to proceed with Phase II of the prospecting programme on its Gerhardminnebron farm north of Potchefstroom. This will aim to prove

ore reserves indicated by Phase I

Taxed earnings rose marginally to R1,12m for the six months to March, from R1,11m in the corresponding period during 1986, and earnings a share rose comparably from 62,7c to 63,6c

As forecast in its 1986 annual report, the company maintained its interim

dividend at 47c a share

Income from investments was R1,2m (R1,3m) and net income before tax increased to R1,15m from R1,13m

The market value of listed investments was R64,1m (R43,2m). Its net asset value, after providing for the dividend, and based on the market value of listed investments, was 3 651c a share versus 2 468c a share a year ago

Union queries sincerity of drive for peace

Star
14/4/89

By Adele Baleta

Differences between South Africa's largest trade union, the National Union of Mineworkers (NUM), and the Chamber of Mines over the elimination of violence in the mining industry have resurfaced.

In the union's annual report, presented this week at its sixth national congress, NUM secretary general Mr Cyril Ramaphosa questioned the sincerity of the Chamber's desire to eradicate violence on the mines.

The Chamber has dismissed "this allegation with contempt".

The NUM says:

If employers were serious about mine violence then a commitment had to be given and a programme adopted to deal with the migrant labour, hostel and induna systems which were the causes of violence on the mines.

While the union had repeatedly called for the abolition of these antiquated structures and systems, employers had paid only lip-service to removing them.

When the NUM decided to begin negotiations with the Chamber on violence after the 1987 miners' strike, the Chamber retreated from the negotiating table.

The Chamber's refusal to continue negotiations was clear evidence that it was bent on keeping the mine compounds as places where they could maintain their authoritarian control.

Chamber of Mines

Chamber of Mines says:

spokesman Mr Johann Liebenberg claimed the NUM allegations questioning the Chamber's desire to eradicate violence were arrant nonsense.

Much of this violence appeared to be by NUM members against others.

It was only after repeated calls by the Chamber on the union to join it in discussions that the NUM responded and then, instead of lending its support to playing a meaningful role in devising a programme to reduce the violence, the union introduced the issue of migrant labour.

The Chamber said it was fully prepared to look at how its member mines might reduce their dependence on migrant labour, but pointed out that this was a separate, long term project.

PLATINUM shares grabbed the limelight on Diagonal Street last week as golds battled to hold their ground under pressure from a stronger financial rand, which offset the moderate rise in the price of the metal.

Gold rose to above \$390 on the back of soaring platinum group metal prices but was unable to hold on to all its gains. The metal got little help from the latest batch of key economic data released on Friday.

The US February trade gap of \$10,5bn matched market forecasts, while the 0,4% rise in the March Producer Price Index (PPI) was also seen as positive. Analysts were braced for a 0,6% to 0,7% increase after the PPI rose 1% in the two previous months.

Gold has risen from lows of \$381 but needs to establish a platform above \$390 to breathe fresh life into the gold-board. Gold shares had been held back earlier by the 4,5% strengthening in the finrand on overseas buying of SA gilts.

However, some analysts believe that once foreign interest in gilts is out of the way, the currency will resume its weaker trend.

The sharp rise in the free market price of platinum to a four-week high of around \$550 has caught many traders by surprise, as the market has recently been following a sideways pattern.

Fundamentals for the metal have been bolstered by the European Parliament's approval of tough new anti-pollution curbs on small cars.

But the price advances generally reflect the strength of palladium and renewed speculative interest

DIAGONAL STREET

Platinums grab limelight while golds face pressure

210 (10)
Biday 1714 87:

LEFKO, helped by news that smelting of platinum-rich ore had been successfully tested, was in the forefront of the surge in platinum shares. The price rose 23% to 675c, while Barplat was hot on its heels with a gain of 22% to R16,25.

Nearly all platinum-related stocks

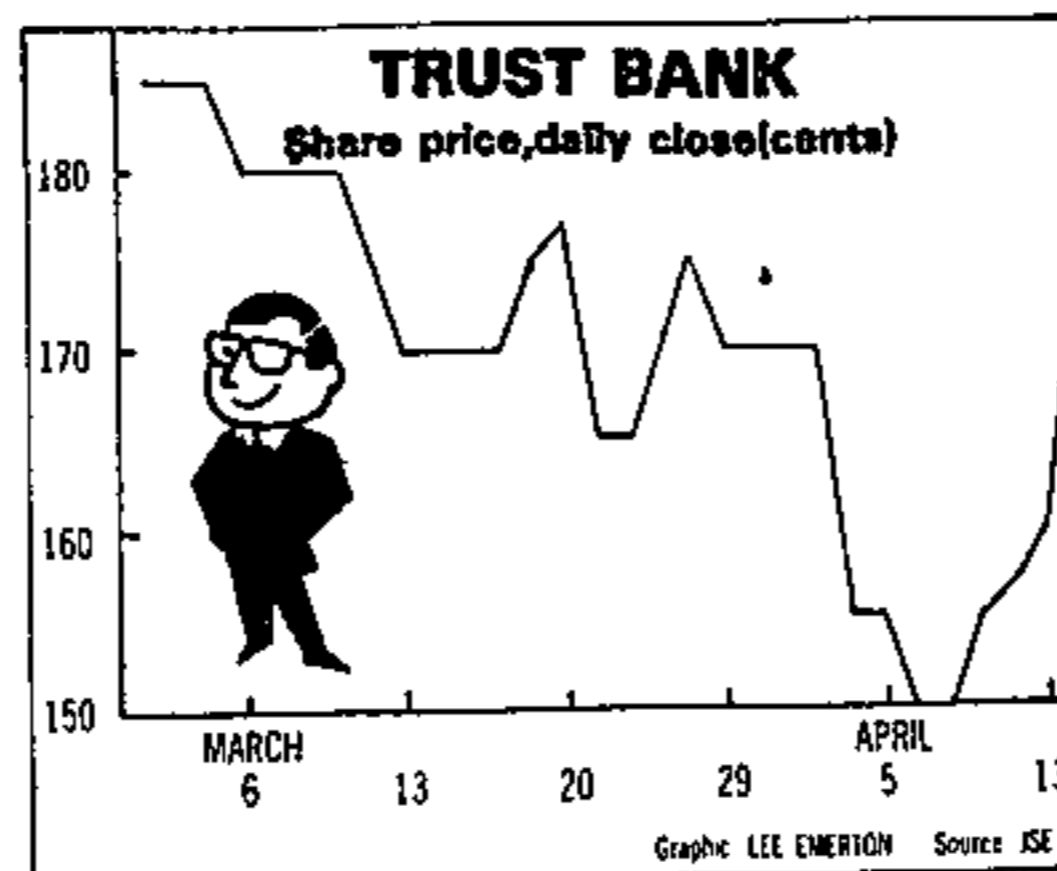

moved to higher ground, while on the mining exploration board SOWITS attracted good demand on speculation of an impending announcement on its mine interests.

Sowits recently announced plans to exploit its chrome deposit near Brits before the end of the year.

It also has platinum interests.

The shares rose almost 25% to 116c after falling to a low of 55c.

Leading industrials tended to move

sideways. After its 25% surge to a peak of R13,50 the previous week, SASOL gave up ground but was firming again on confirmation of a petrol price increase. The shares, which backtracked to R12,40, were testing the R13 level.

Shares of furniture company GOMMA, which sank to a low of 20c in mid-February after poor results, rose sharply to 45c on news that it was involved in negotiations.

JAZZ shot up 47% to 103c before it was suspended on Friday. The company issued a joint cautionary statement earlier with sister company Metro which was expected to take out the troubled group.

Textile group CONFRAME rose 10c to 66c on Friday on volume of 65 000 shares which represented more than half of its average monthly turnover during the past 12 months of 120 000 shares. Some analysts considered the share cheap as it was trading at a big discount to net asset value.

Among financial shares, Trust Bank steadily regained its losses on news that it should recover most of the money involved in a R47m fraud at the bank.

The shares, which had fallen from 170c to 150c, were back at 170c.

MERVYN HARRIS

LIZ ROUSE

THE decision to follow an investment strategy of low liquidity has paid off for Southern Unit Trusts after strong equity performance in the March quarter.

The Southern Equity Fund showed a return of 19,86% for the three months while the Mining Fund returned a healthy 21,84% to become the second-ranked specialist equity.

Short-term performances should not be seen in isolation but it is encouraging for investors that both relatively young funds in the Southern stable are among top performers, according to a survey by Pretoria University's Graduate School of Business.

Southern Unit Trusts full of early promise

COMPANIES

The combined value of assets is more than R27m with the Equity Fund holding liquid assets of R2,84m and the Mining Fund R1,5m.

Portfolio manager and head of Southern Unit Trusts Carel de Ridder believes some share prices might drop.

He said "The recent substantial rise in share prices has placed the market on a more expensive footing."

"The mining sector is expected to perform well but the gold price remains an area of concern. Although gold fell to

\$382 an ounce at the end of March, it recovered to more than R1 000 as our currency weakened against the dollar. Sentiment on the gold board of the JSE underwent a marked improvement which was not dented in spite of gold falling to R977 at the quarter's end.

"There is also growth potential in minerals and good results can be expected from companies in this sector. With high interest rates, company balance sheets should be watched carefully and I still favour rand-hedge companies

with little loan capital," said De Ridder. He added that, while interest rates might be attractive, after-tax returns were still low and investors are strongly advised to channel funds into unit trusts or the share market.

During the quarter Southern Unit Trusts declared a maiden dividend distribution of 2,7c a unit for the Southern Equity Fund and 2,79c for the Southern Mining Fund.

Major purchases in the Equity Fund were Anamint, AVI, De Beers, Elands-

rand, Indsel, Malbak, Rlichemont and CMH Holdings in Tollgate, Toyota and Yabeng were sold. The Mining Fund sold its holdings in Barplat, Marlin, Rooiberg and Vansa options.

The 10 largest holdings in the Equity Fund are De Beers, Anamint, Rlichemont, PP Cement, Anglos, Gencor, Genbel, Rusplat, Johnnies and East Dagga.

The Mining Fund's 10 largest holdings are Gencor, De Beers, Genbel, Anglos, Anamint, Rusplat, Anglovaal loan stock, Johnnies, GFSA and East Dagga.

day, April 19 1989

COMPANIES

Market value of unit trusts up 51% over year

THE total market value of SA's 30 unit trusts rose by 20% over the March quarter to R5 268,6m, reflecting a 51% increase on the total market value a year ago

Association of Unit Trusts chairman, Roy McAlpine, comments in his quarterly report that investors have appreciated the excellent performance by the unit trust industry as a result of which a

further net R146,2m flowed into the industry in the March quarter

This means the industry has attracted a net inflow of more than R440m in the past year. In addition, during the past six months more than 35 000 new investors have been attracted to unit trusts, says McAlpine

The funds sold a total of R323,8m new units in the quarter while repurchases amounted to R177,6m

The association's figures showed that the twelve general funds, which constituted the bulk of the industry, held assets with a value of R3 672,2m at the end of March. This value compared favourably with the R3 021,6m market value at the end of 1988

The general equity funds held 6% of their assets in gold, 16% in mining finance and 12% in other mining. Industrials comprised 47% or R1 738,9m of the portfolio and the proportion held in liquid assets, at 17% or R615,2m, was little changed from the December quarter's 18%

The seven high income funds held assets of R223,2m with the bulk of the portfolios held on the short end

LIZ ROUSE

210

by Peter Walker

RAISING THE MINIMUM

Chamber of Mines and other monthly wage rates compared (Gold Mines)

1989 NUM demands	Official Chamber minimum 1988	Anglo 1988	JCI 1988	Gencor 1988	Gold Fields 1988	Rand Mines 1988	Gencor marginal 1988	Maximum 1988 % Deviation from Chamber	Maximum 1988 % Deviation between Mines
SURFACE									
543	278	337	337	294	280	323	291	21%	20%
605	319	382	384	337	354	364	335	20%	15%
675	374	443	441	402	438	410	400	18%	10%
753	432	517	519	474	538	480	471	25%	14%
840	496	597	599	365	653	544	561	32%	20%
937	578	704	698	670	—*	646	665	22%	—
1 044	670	823	809	812	775	768	806	23%	7%
1 165	838	956	941	1 008	928	971	1 000	20%	9%
UNDER-GROUND									
600	306	385	384	350	329	372	347	25%	17%
669	379	443	440	398	393	422	394	18%	13%
746	439	512	537	475	480	474	472	22%	14%
832	505	599	590	548	591	547	544	16%	10%
928	576	694	686	661	718	619	656	25%	16%
1 035	667	799	768	780	—	734	774	20%	—
1 154	765	924	924	929	869	841	922	21%	10%
1 287	939	1 067	1 072	1 119	1 074	1 055	1 110	19%	6%

Source NUM

*n a

MINE WAGES

At the margins

Pay talks this year between the Chamber of Mines and the National Union of Mineworkers (NUM) look set to take up the issue that emerged so strongly at last year's negotiations — the health of the mining industry and whether it can afford to pay the kind of increases tabled by the union.

On Monday, NUM general secretary Cyril Ramaphosa announced opening demands for a national minimum cash wage of R543 for grade 1 surface workers, and R600 for the lowest scale underground workers. This would nearly double their current cash earnings based on chamber rates (see table). At the top end, the minimum demanded for grade 8 surface workers is R1 165 (a 39% increase) and R1 287 (37%) for their underground counterparts.

In terms of the wage policy adopted at the NUM's sixth biennial congress last week, the union aims to negotiate national minimum rates in an endeavour to counter the different levels paid by different companies and to reduce "drastically" the gaps between wage categories. It was also decided that

minimum wages will henceforth be negotiated "in money terms" since it is difficult for workers to understand percentage increases. Those earning above the minimum "must get a guaranteed rand increase (of) at least the difference between the new minimum and the present minimum for their grade."

Ramaphosa added "We want a commitment from the chamber to pay a living wage by 1991." A "living wage" was not defined but this year's demands, if met, "came close," he said.

NUM's drive for a national minimum comes at a time when industry sources are predicting separate negotiations in future for richer and poorer or marginal mines. They say it was pointed out to the union last year that a number of mines were in dire straits and would have to close but for State assistance to keep them going. Wage demands of the current order might just be the death knell to the marginals and lead to massive retrenchments. The chamber's 14 marginal mines, furthermore, account for only 13% of production but employ about 20% of the total workforce. This has serious implications for NUM membership, which the union hopes to build to 400 000 by 1991, from its current 240 000 paid-up level.

According to one mining source "At the current gold price and rand/dollar exchange rate, it appears as though at least 12 of the 33 operating gold mines are producing gold at working costs in excess of their revenue. If this trend continues for the rest of the year, then quite obviously these mines will have to consider drastic steps to reduce working costs."

"The NUM's very substantial demands must be seen against this light." Already this year there have been 10 000 retrenchments, mainly in the Gencor group, and, it is pointed out, many companies have been "downsizing" through natural attrition.

According to Chamber of Mines figures, 1988 showed a record working revenue of

R18,8bn. However, total profits before tax (R6,98bn) were down 1,6% on 1987, which in turn was 14,6% lower than in 1986. Wages and salaries (R5,7bn) last year accounted for 31% of working costs of R11,8bn.

Whereas revenue in 1988 was up 9,7% (1,9% in 1987), costs went up by 17,7% (18,1%). Dividend payments at R2,2bn were down by 3,6% in 1988, having fallen 9,4% in 1987. All this occurred when the gold price was on average higher than it's been so far this year. Realistically, therefore, the chamber will be hard pressed to grant wage rises of more than a few points higher than the official inflation rate.

Ramaphosa, of course, opposes the arguments for closing marginal mines and maintains that "the marginal mines should be boosted up by the super-performers." For example, he claimed, in the same way that the mines purchase machinery "from a single pool, there is no reason why wage costs cannot be dealt with in a similar manner." Shareholders will, of course, think differently.

The union proposes various other ways of dealing with the problem of marginal mines and retrenchments. For instance, negotiating a scheme whereby the union could take over those mines and run them on a co-operative basis, and shorter working periods where a longer period of "home time" between contracts is negotiated, as has been done in one case.

Boost for Old Mutual-managed funds

8/Day 2-11/489 (210) ~~210~~
PENSION and provident fund investments managed by the Old Mutual have received a major boost from the strong performance of a range of mining and industrial shares.

The Mutual's Multifund yielded returns of between 28% and 44% for participating pension and provident funds, says the Mutual Employee Benefits GM Gerhard van Niekerk

Multifund is a market-related investment system which offers trustees the opportunity to select a range of investment channels to build the ideal portfolio which best serves their needs. The investment profiles of funds participating in Multifund, and consequent returns, can differ significantly

LIZ ROUSE

Funds participating in the Omnifund portfolio during the year from April 1 1988, to March 31 1989, reaped returns of 28,3% — more than double the 13,8% inflation rate. This reflects a real increase in the wealth of the funds investing in this portfolio of 14,5%

The portfolio grew by 63,6% to R427,8m. Main contributors to Omnifund and Multifund's strong showing were the Mutual's selection of industrial and mining shares. Returns of 72,4% were shown by the industrial channel and 66,5% by the mining channel

The leading performers were Rusplat, Anamint/De Beers, Anglo and Gencor

Gencor earnings surge 55%

STRONG performances by Gencor subsidiaries Samancor and Sappi countered poor results from the house's gold investments and boosted its earnings for the six months to February by 55% to R456m (R294m).

Earnings per capital unit were also 55% higher at 465c (300c). The board declared an interim dividend of 120c — 20% higher than last year's 100c. Dividend cover was more conservative, at 3.8 times (3.0 times). The improvement was largely attributable to a surge in profit from Gencor's two happiest divisions.

Metals and minerals — including ferro-metals producer Samancor and heavy sands processor Richards Bay Minerals — which lifted attributable earnings by 195% to R186m (R63m), and Paper/pulp producer Sappi, which lifted its contribution by 64% to R128m (R78m). Executive chairman Derek Keys said Sappi moved quickly to bring its greatly

REINIE BOOYSEN

enlarged responsibilities under control. "Export price movements are no longer only upward but are nevertheless firm enough to be attractive in prospect."

Less impressive, but nonetheless good improvements were recorded by Malbak and associates, which lifted earnings by 39% to R64m (R46m), Gencor's platinum producer Impala which lifted its contribution by 24% to R31m (R25m), and coal producer Trans-Natal, to R16m (R3m).

These performances overshadowed the cost of investing in mining exploration (R52m as opposed to R42m last year) and in Gencor's energy programme, which includes Mossgas, the Torbante project and oil and gas exploration (R22m as opposed to R7m). They also countered the following burdens a 14% decline in gold's contribution,

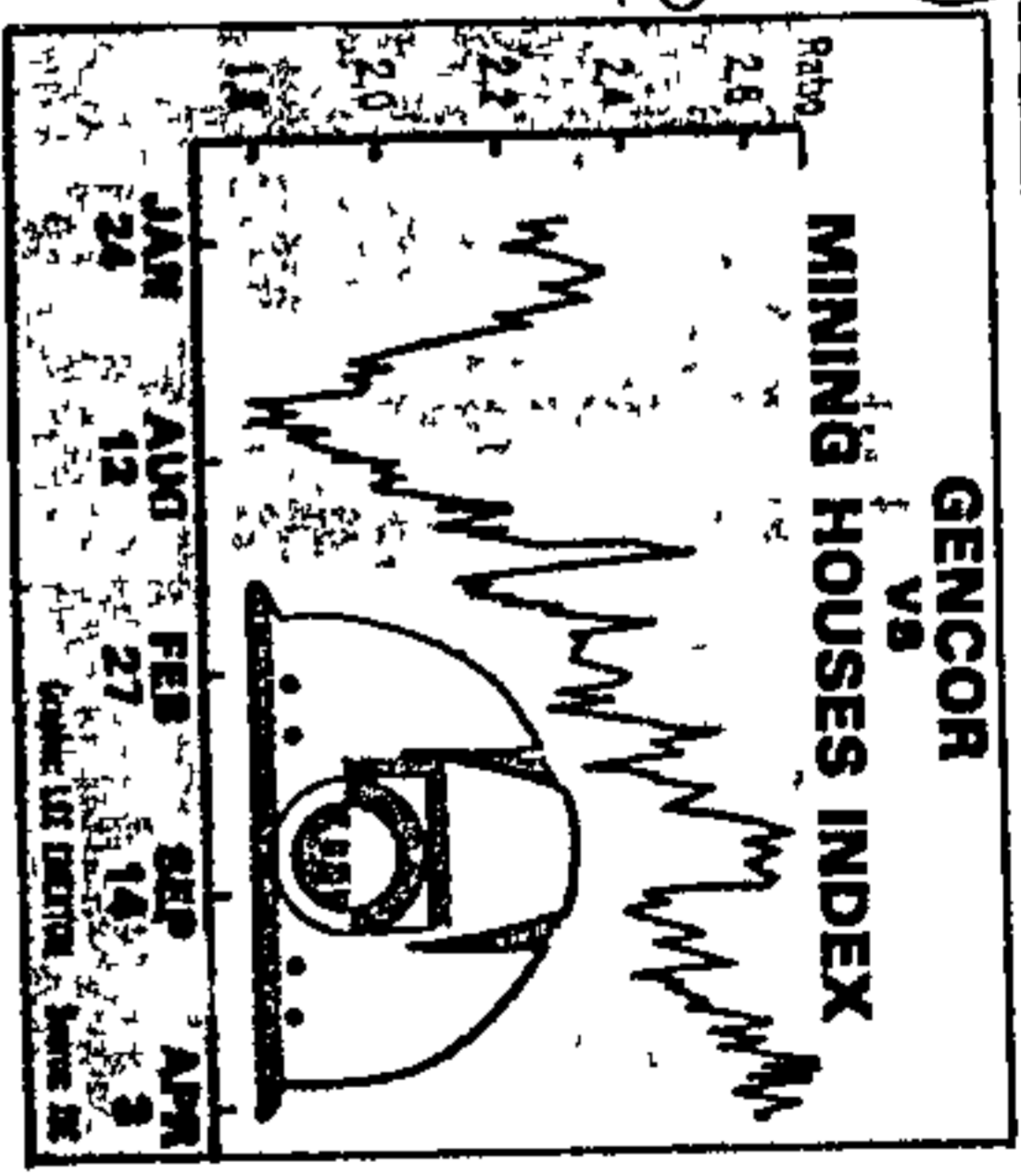

to R78m (R91m) and a 7.5% decline in earnings from Genbel and Investments to R74m (R80m). Gencor's 55% rise in earnings outstrips that of all three mining houses reporting

● To Page 2

Sappi, Samancor boost Gencor earnings

interim results to December Johannesburg Consolidated Investments lifted attributable profit, before non-recurring item, by 20% to R121m (R100.5m). Gold Fields of SA lifted attributable profit by 14% to R150.8m (R131.9m). Anglovaal lifted attributable earnings by 12% to

R78.6m (R70.2m). Keys said "The group is enjoying its best year yet and in consequence all past benchmarks of financial excellence are in the process of being surpassed."

● From Page 2

210

the in 15

2 Page of

To Page 2

Mining puts sparkle in Gencor

By Ann Crotty

210

A massive hike in contribution from its metals and minerals division helped Gencor to a sparkling performance for the six months to February

The figures are sure to enhance chairman Derek Keys' reputation as a dynamic business leader

The performance reflects the situation vis-a-vis the world prices of its major commodities, but there is little doubt among analysts that the quality of Mr Keys' management team ensured that shareholders would benefit from developments in world commodity prices.

Attributable income was R456 million — 55 percent ahead of the pro forma figure for February 1988 (Last year Gencor changed its year-end from December to August)

Earnings per share were 465c (300c), from which a dividend of 120c (100c) has been declared

A divisional break-down shows the group's mining interests, now housed in Genmin, provided the lar-

gest chunk of earnings

Its R259 million was 85 percent ahead of the previous year's pro forma figure of R140 million and represented 51,4 percent of Gencor's R503 million attributable income before head-office charges and financing costs

By contrast, in financial 1988, mining interests accounted for 41,5 percent of the total

The major factor behind the increased contribution from mining was the surge in attributable income from metals and minerals to R186 million from R63 million

This meant that metals and minerals accounted for 37 (18,7) percent of attributable income

Samancor, which benefited from the strong world demand for steel, dominated the performance. Richard's Bay Minerals also helped

Contribution from gold was down in both absolute and relative terms to R78 million (R91 million), representing 15,5 (27) percent.

Platinum was up in absolute

Star 21/4/89.
terms to R31 million (R25 million), but down in relative terms to 6,2 percent from 7,4 percent

Also reflecting trends in world commodity prices, coal's contribution surged to R16 million (R3 million). Exploration costs took R52 million (R42 million)

Sappi's contribution of R128 million (R78 million) was equivalent to 25,4 percent of the total — up from the previous year's 23 percent

The overall performance may persuade the market to tighten the gap between its rating of Anglo and Gencor

Currently, Anglo is on a P/E rating of 9 times and a dividend yield of 2,7 percent, compared with Gencor's 12,2 times and 3,1 percent respectively

But although Gencor's management is highly regarded, the quality of its assets (compared to Anglo's) is likely to see the gap being maintained in the medium-term

Anglovaal buys

Star 21/4/57
42% of AA Life

Finance Staff
Anglovaal has acquired a 41,6 percent stake in AA Life Assurance Association in a surprise move announced yesterday

This makes Anglovaal the largest single shareholder in AA Life, the other shareholders being the consortium which, a year ago, bought out Kirsh Industries' interest in the company. They are Volkskas Merchant Bank, the management of AA Life and the Automobile Association.

The purchase will set Anglovaal back by about R30 million which will be financed by means of a rights issue, of which Anglovaal will take 95 percent.

This is the first time that Anglovaal has invested directly in the South African financial services sector and means that within the last 12 months AA life has received capital injections totalling over R50 million — the first R20 million came from a rights issue shortly after the consortium took over the Kirsh interests earlier last year.

Commenting on the deal AA Life managing director, Dr Brian Benfield said "The challenging new circumstances in which we find ourselves will most certainly lead to exponential growth enhanced by the Anglovaal association."

DIGOCO Mining Company has applied for a JSE listing in the mining exploration sector, but some shareholders have expressed concern over the delay in applying

Concern over delays in Digoco application

ZILLA EFRAT

A shareholder says the company stated it would list around the middle of last year, but flotation date was regularly advanced by a month. The last official date given for listing was December, after which he received no communication from the company.

JSE GM Doug Gair says the JSE received a formal listing application very recently, which were to be put to the listing committee yesterday and the general committee today.

Digoco financial director Morrison Smit says listing was a new experience for the company's management which expected the listing to take far less time. Delays included the obtaining of geological and technical advisers' reports.

The company was then asked not to communicate with shareholders until the deal was finalised and shareholders quite rightly got uptight, says Smit. The Pretoria-based mining com-

pany's wholly owned subsidiary mines diamonds in the north-western Cape and holds some mining exploration rights in the north-eastern Transvaal. Its associated company intends to develop an open cast manganese mine.

Smit says the company is seeking a listing to put it in a position to raise capital for future capital projects, expansion programmes and the acquisition of further mining rights.

Digoco already has the necessary spread of shareholders for the listing.

Previously called the Supernational Corporation, the company changed its name in March last year when it began its mining operations.

In response to reports that the company is related to the liquidated Turf Holdings, Smit says there are no connections at all.

Jannie Nel is to be chairman of the company and Johann de Witt MD.

Mobil to sell SA interests to Gencor

By Sven Lunsche

Industry sources confirmed this morning that Mobil Oil was selling its South African interests to mining group Gencor for an estimated R500 million.

Mobil is the largest US company remaining in South Africa and has assets in the Republic valued at around R1 billion.

Mobil executives in Cape Town and New York could not be reached for comment but financial analysts said a number of developments indicated that its withdrawal was imminent.

● The financial rand has weakened over the last 10 trading days on a large selling order, which financial dealers suspect is Mobil.

● The share price of Gencor's oil subsidiary Trek, which is likely to take control of Mobil's oil interests, rose by 225c or 17 percent to R17 on the JSE yesterday after a 25c increase on Monday.

● An article in the London *Observer* at the weekend suggesting that Mobil was planning to transfer ownership of its South African interests to a tax haven in the Channel Islands.

The move was precipitated by fears of the effects of the Rangel Amendment, passed by the US Congress in December 1987, which obliged Mobil to pay taxes in the US on its South Africa profits.

Turnaround in property sector boosts RMP profits

M/Dan 26/4/89

A TURNAROUND of almost R7m in Rand Mines Properties' (RMP) property division and a steady contribution from gold recovery operations boosted the company's bottom-line profits by 42% — from R8,7m to R12,4m — in the six months to March

Earnings a share were 100c, against 70c in the first half last year, and the interim dividend was raised by 10c to 30c

Record

However, directors warn that second-half results will be significantly lower than the first half, taking into account current gold price trends and the outlook for property sales in the light of higher interest rates

They forecast after-tax profits for the full 1989 year at about R21m, compared

Business Day reporter

with the record R27,8m earned in 1988

Directors say dividend cover can be reduced in view of the good liquidity position and low capital expenditure requirements. The total dividend for 1989 is, therefore, not expected to be less than the 120c paid in 1988

Chairman Dammy Watt says the company is well placed to take advantage of investment opportunities

RMP's turnover for the half-year to March rose by 37%, from just under R60m to R82,2m

The property division turned in an operating profit of R4,9m, compared with a loss of just under R2m in the first half last year, while the operating profit from gold recovery was more or less unchanged at R13,2m

Total operating profit was, therefore, 61% up, at R18,1m. Net interest totalled R1,1m (R191 000), which took pre-tax

profit to R19,2m, against R11,4m — an increase of 68%

Tax took R6,6m (R2,7m), while minority interests accounted for R108 000

RMP's sand treatment operations held more or less steady for the half year, with operating profit from the Crown Mines and City Deep plants R1,2m lower at R12m. However, a R1,2m contribution from the new Pilgrim's Rest plant — which is half-owned by RMP — compensated for this

Achieved

On the property side, RMP showed gross revenue from township land sales of R14,7m for the six months, against R1,5m in the first half last year

The contribution from this division during the second half of the current year is expected to be less than that achieved during the comparable period of 1988

HOME IMPROVEMENTS

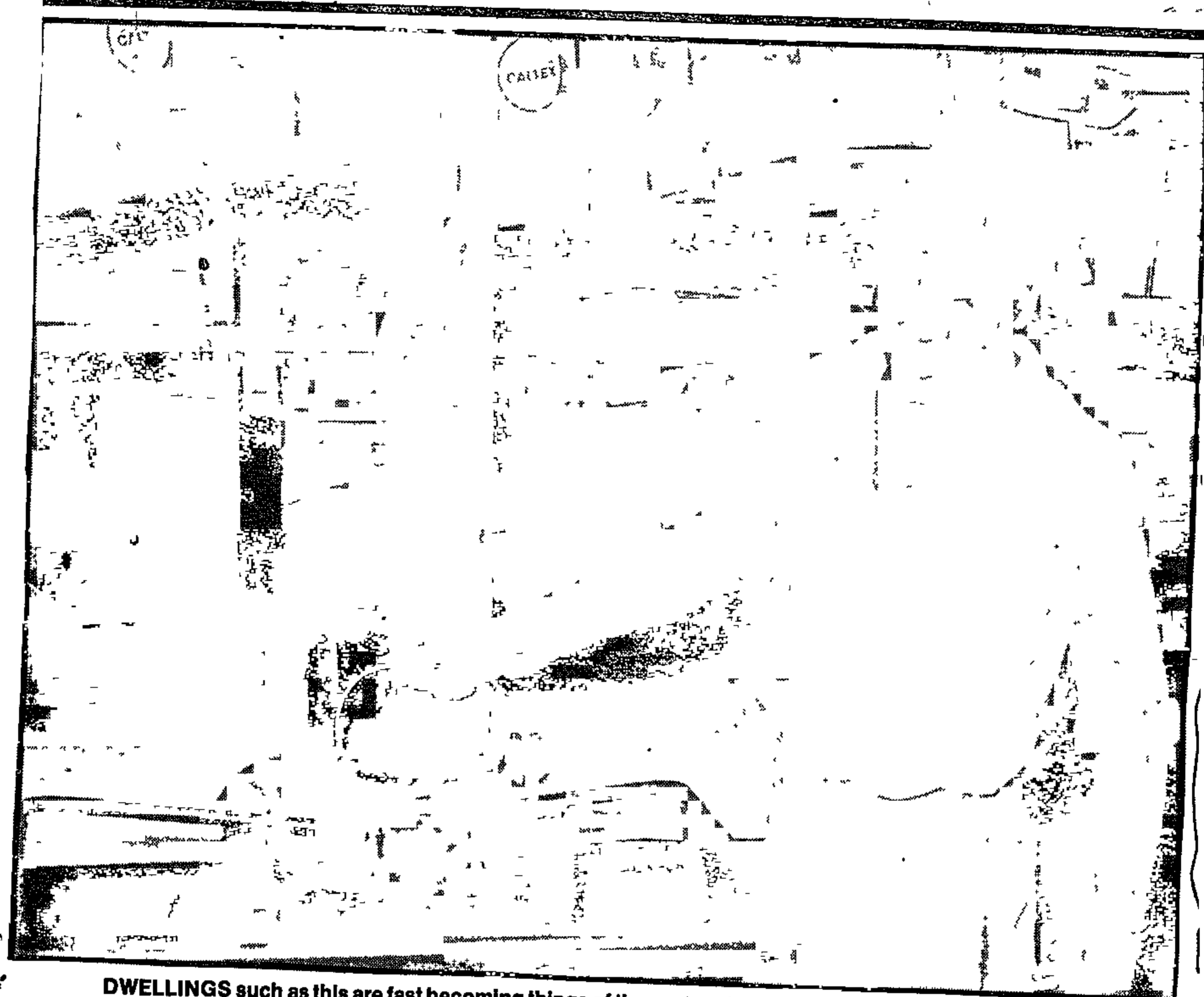

DWELLINGS such as this are fast becoming things of the past as the Gold and Uranium Division of the Anglo American Corporation commits itself to the total urbanisation of its workers on the mines.

HOUSING HOPES FOR MINERS . . .

Sowetan
27/4/89
211
~~2~~

THE Gold and Uranium Division of the Anglo American Corporation has set aside more than R82 million for the development of housing projects to accommodate thousands of its employees working on the mines.

The division says it has always been its commitment to move away from the migratory labour system and to employ people on a permanent basis so that they could settle themselves with their families near their workplaces

It says it could not achieve this objective until in 1986 when the influx control regulations were abolished and freehold rights were extended to blacks

After the abolition of the Act, the division acted quickly and a home ownership scheme was launched the same year.

A market survey, conducted in 1986, revealed that more than 24 000 people employed on the mines were likely to be urbanised within three years.

"To make home ownership a viable option for our married employees, we developed a financial scheme which subsidises bond repayments down to five percent interest. The

scheme requires only two-and-half percent deposit and also provides for collateral to building societies in order that employees may have access to such financial institutions," the division said

The subsidy provided by the division ensures that all employees who are married and those at the lowest levels of the wage structure are eligible for home ownership

The division has since embarked on four major housing developments in

Wedela, near Carletonville, Klerksdorp, Welkom and Odendaalsrus, the biggest of which is in Wedela where more than 7 000 stands have been serviced

Owning

According to Mr Willem van der Post, manpower consultant of the division, about 700 employees were owning their homes by November 15 last year

According to Mr Van der Post, the biggest problem facing the

division is infrastructure. He said the anticipated urbanisation of mine workers over a short period of time in townships which were already overcrowded and suffered from inadequate infrastructure raised severe problems

"Land for development, bulk services and storm water drainage are the most pressing needs. Public transport services, recreational facilities, educational facilities and health services also have to be provided, he said. He said he believed

that these services should be provided by the Government

"So far very little has been done. Without adequate infrastructure, the progress of the home ownership scheme will be seriously impeded," he said

He said during the next decade alone, 134 schools would have to be built in the four regions to meet the educational needs of the inhabitants

FAROO

Mobil board 'set to clinch sale to Gencor'

210 By Sven Lunsche
The board of Mobil Oil is reported to be meeting in the United States tomorrow to ratify the sale of its South African interests to the local mining giant, Gencor.

Mobil (SA) and Gencor yesterday again refused to confirm the transaction, but this only strengthened market talk that Mobil was selling its local stake for an estimated \$200 million (about R500 million).

Analysts have described this as a give-away, as the sum would drop to \$125 million (R313 million) if payment is made in financial rands

Mobil is the largest US company remaining in South Africa, and has

assets in the Republic worth about \$400 million (R1 000 million) and employs a staff of about 2 800.

The reports have strengthened the share price of Gencor's oil subsidiary Trek, which is likely to take control of Mobil's oil interests. Since Monday, Trek's shares have soared by 25 percent.

The disinvestment was precipitated by fears of the effects of the Rangel Amendment, passed by Congress in December 1987, which obliged Mobil to pay taxes in the US on its South African profits, costing Mobil about \$5 million (R12,5 million) in lost profits last year.

the C
myo
sids
Ordin
ble
ma
Sev
supp
night
the pi
terrur
and s
fore
Claas
tonvil
told T
Ap
night
ment
Koo
want
we a
mone
win t

It's all a lie, says Femme editor Jordan

By Paula Fray

The up-market glossy magazine, *Femme*, is not being wound up or facing provisional liquidation, the editor, Susie Jordan, said yesterday.

Mrs Jordan was commenting on a court order for the provisional winding up of Fashion Publishers (Pty) Ltd, trading as *Femme*, which was granted in the Rand Supreme Court on Tuesday.

The application was by Citylab (Pty) Ltd for R10 375 owed on an account incurred in 1986. The order is returnable on May 30.

The present owners of *Femme*, Emme Publications (Pty) Ltd, will be taking legal advice, company director Mr L Coetzee said. He emphasised that no summons had been served on the magazine.

Ms Jordan said she was unaware of the court action until contacted by *The Star*. She said she would also be taking legal action.

"The whole situation is damaging and libellous to the magazine and to me. The story, as far as I am concerned, is untrue," she said.

Strikers prevented from demonstrating

Two busloads of Rustenburg Platinum Refinery workers were allegedly stopped from staging a peaceful demonstration — to draw attention to their demands and their willingness to negotiate — at Johannesburg Consolidated Investments (JCI) head offices yesterday.

A National Union of Mineworkers statement said that after earlier negotiations with police, workers were allowed to proceed from the NUM offices to JCI's headquarters, but were then prevented from alighting from the buses.

At 56 days the RPR strike is "The longest-running in the history of mining in South Africa," according to the NUM — and it is continuing, with 547 workers at loggerheads with the management at Rustenburg Platinum Refineries.

OFFER SHOULD BE RETROSPECTIVE

The RPR strike began after the refinery's management refused to meet the workers' wage demands, the NUM said.

In an effort to reach a settlement, the union proposed that the company's 14,5 percent offer be paid retrospective to January 1 of this year. Contained within the proposal were the following demands:

- Six months' maternity leave for women workers,
- Lower job categories to get two additional days annual leave,
- Higher job categories to get one additional day annual leave,
- June 16 is declared a paid public holiday.

The mine's management has refused to meet any of these proposals, however, the union claims.

NUM said RPR workers had undergone hardships during the strike, often sleeping outdoors.

Their food supplies were allegedly severed by JCI management on a number of occasions and they had to go without food for several days.

Refinery workers reported to the plant everyday but did not work, NUM said. Management had said it would institute a lockout if workers left the premises — Sapa.

Mobil to continue 'as separate entity'

13/Day 2/5/89 (210)

MOBIL Oil would continue to operate as a separate entity within the Gencor group and would play an important part in Gencor's extension into energy-related projects, Gencor executive director and energy division chief Bernard Smith said.

He said Mobil would compete with Gencor's Trek Beleggings in the market. It would keep its name "in the medium term".

The Mobil Corporation of the US confirmed on Friday it would sell off its southern African interests to Gencor for an undisclosed sum.

Mobil would operate as it had been, "doing what it does best". There were no plans for rationalisation or

change, but Gencor would add some members to the Mobil directorate.

Smith said the acquisition would have an important impact on Gencor earnings a share. A Mobil JSE listing was possible, but issues had not yet been clarified.

Being part of Gencor would provide the Mobil organisation and staff members with many growth opportunities.

The sale is expected to be completed by the end of June and is subject to a formal agreement being drawn up and government approval where necessary.

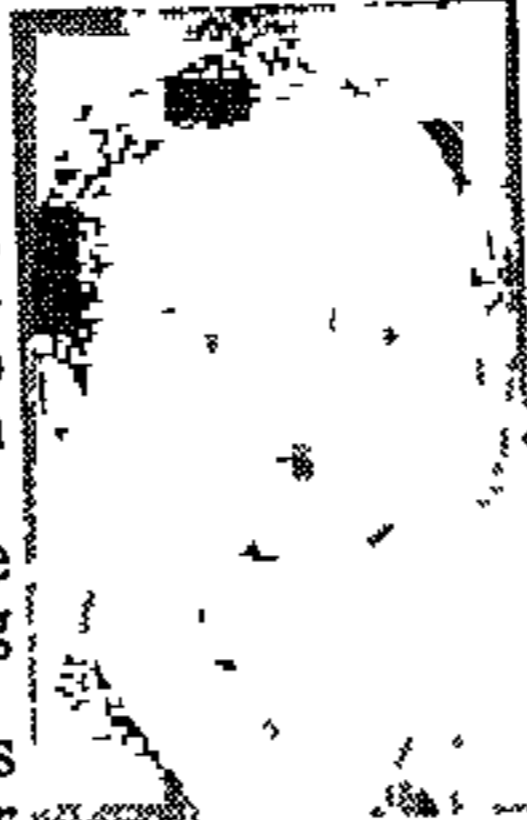

● SMITH

ZILLA EFRAT

Mobil Corporation chairman Allen Murray has cited business considerations, including the impact of recently enacted and proposed US legislation and regulations, as the major motivation for the sale.

The deal involves 12 Mobil-affiliated companies and the retail and commercial petroleum marketing networks operated by Mobil in SA, Namibia, Botswana, Swaziland, Lesotho, Transkei, Bophuthatswana, Venda and Ciskei.

The sale price has not been disclosed, but Mobil says it exceeds the local book value of the companies, estimated at \$400m.

Mobil Southern African chairman and MD Robert Angel said Mobil would continue to manufacture and market the same products and supply the same service.

He said present employment policies, practices and benefits would continue and all existing agreements and arrangements with the Chemical Workers' Industrial Union would be honoured.

AP-DJ reported the mostly black union had filed an urgent suit in the Industrial Court to stop the sale of Mobil assets until it negotiated a disinvestment procedure.

Union spokesman Taffy Adler said the urgent application was filed on Friday afternoon, but the two judges, appointed by the Department of Manpower, postponed a hearing until May 9.

Oil company to maintain funding

210

B/Dec 3/6/87

Mobil Foundation head pledges its work will continue

ADELE BALETA

WORK of the Mobil Foundation will continue in spite of the giant oil company's impending sale of southern African interests to Gencor

Mobil Oil stated it would extend funding to the foundation until the end of 1994

Foundation chairman Franklin Sonn said yesterday independence of the organisation from Mobil Oil Corporation, which donated R40m to fund it, was absolute

He added an executive meeting would be held soon with Mobil and Gencor to discuss independence of the organisation, future of Mobil staff seconded to it and funding

"We are confident of the future of our organisation. It will always be crucial for business to participate in such projects," Sonn said

In its first report last year the foundation, formed in 1986, said it had spent R8,3m on more than 90 community projects designed to make an important contribution to a unitary non-racial system

Sonn said its mission was "to support and develop programmes and any other activities that will impact on the current structures of society and help SA develop

into a non-racial, democratic society based on the principle of freedom of association"

The report stated more than half the of the R5,7m allocation was spent on education focusing on early childhood, curriculum and teacher development and alternate education

A total of R2,6m was spent on business and community projects

Education board chairman Ken Hartshorne believed a mistake was to use education to divide people rather than using it to give a common purpose

"I think there is a general feeling that money coming from the private sector should not be used to prop up the system. We should be looking at a future kind of education in a different kind of SA in a different society. That is the key criterion for the foundation," he said

The foundation's business and community action board supports two different types of programmes. One is aimed at business development and the other at development in communities

ly
ve
in
y
r-
r-
a,
ie
i-
t-
a
id
y
d
d
it
i-
is
d
if

E
F
T
C
i
a
L
7
-
ub
S
H
ad
id
ch
ar
H
p
de
is
J
le
5
7
do
o
r
I
h
r
p
p
r
r

6280

Oil company to maintain funding

8/Dec 24/07

110

Mobil Foundation head pledges its work will continue

ADELE BALETA

WORK of the Mobil Foundation will continue in spite of the giant oil company's impending sale of southern African interests to Gencor

Mobil Oil stated it would extend funding to the foundation until the end of 1994

Foundation chairman Franklin Sonn said yesterday independence of the organisation from Mobil Oil Corporation, which donated R40m to fund it, was absolute

He added an executive meeting would be held soon with Mobil and Gencor to discuss independence of the organisation, future of Mobil staff seconded to it and funding

"We are confident of the future of our organisation. It will always be crucial for business to participate in such projects," Sonn said

In its first report last year the foundation, formed in 1986, said it had spent R8,3m on more than 90 community projects designed to make an important contribution to a unitary non-racial system

Sonn said its mission was "to support and develop programmes and any other activities that will impact on the current structures of society and help SA develop

into a non-racial, democratic society based on the principle of freedom of association"

The report stated more than half the of the R5,7m allocation was spent on education focusing on early childhood, curriculum and teacher development and alternate education

A total of R2,6m was spent on business and community projects

Education board chairman Ken Hartshorne believed a mistake was to use education to divide people rather than using it to give a common purpose

"I think there is a general feeling that money coming from the private sector should not be used to prop up the system. We should be looking at a future kind of education in a different kind of SA in a different society. That is the key criterion for the foundation," he said

The foundation's business and community action board supports two different types of programmes. One is aimed at business development and the other at development in communities

y
e
n
n
r
t
c
l
e
r
t
a
d
y
d
i

DU
Pal
T
c
cla
ch
ist
anc
a
I
pr
u
pa
en
ju
ce
p
e
co
hid
y
st
C
go
tri
sh
at
de
cc
in
u
el
st
o
g
u
p
e
E
S
f
S

1987

8/15/89 (211)

Operatives to relieve artisans

Mine jobs package to benefit all

Staff Reporter

An agreement on a productivity package, which would have far-reaching beneficial effects throughout the mining industry, was reached in Johannesburg this week.

In joint statement, the Chamber of Mines and the Federation of Mining Unions — an umbrella body representing six artisan unions with a membership of nearly 14 000 — said the package, which took almost 10 years to negotiate, would create opportunities for artisans to earn more money.

Routine tasks

The agreement would also make provision for the appointment of operatives and underground section electricians, new categories of employees on the mines. It will open the way for the industry to develop and make use of the skill of employees of all races who do not have the qualifications to become artisans.

“Operatives will assume responsibility for a broad range of routine tasks currently performed by artisans. These tasks, often time consuming, are such that they do not require the skills of qualified artisans. By handling them over to operatives, artisans will be better able to devote more time and attention to the wide variety of

jobs which do demand their skills and experience,” the statement said.

Underground section electricians trained to a level nearly equal to that of artisans because of the special safety considerations that apply, would assume responsibility for a number of routine electrical tasks underground.

The package incorporates a series of productivity incentives aimed at encouraging artisans to use their skills more effectively and earn more money.

Featured in the package is a security of employment agreement, which embraces an assortment of job protection assurances for artisans.

“The appointment of operatives and of underground section electricians will open up a considerable range of new job choices for mining industry employees of all races.

“Opportunities will be created for employees to acquire new skills and those operatives who possess the necessary educational qualifications will be eligible for appointment as apprentices to enable them to qualify for full artisan status.”

According to the statement, underground section electricians would be required to possess the same educational qualifications as apprentices so they would be eligible for appointment as apprentices.

ANGLO American Properties (Amaprop) posted a net profit rise of 18.4% to R24,66m (1988 R19,88m) in the year to March.

With earnings up at 54.8c a share from 46.3c a

Amaprop posts net profit rise of 18.4% to R24,66m

share, the dividend was raised by 5c to 35c and, as a consequence, the loan stock interest was increased by 10c to 70c a unit.

The results reflected more buoyant conditions in the property market. A review of Amaprop's activities during the past year and the group's prospects will be covered in the annual report.

At the market price of 540c, Amaprop shares are on an historic earnings yield of 10.1% and dividend yield of 6.5%.

Anglo set to 'turn in record earnings'

LONDON — Anglo American will turn in record earnings next month when year-end results are announced, stockbrokers James Capel says

A report in the latest edition of International Mining Review, a James Capel publication, forecasts a 20% dividend increase and a large increase in equity accounted earnings

The latter is expected to be boosted domestically by Amic's good performance and internationally by De Beers and Amsa, which has extensive interests in South America

And while the contribution from gold earnings are expected to be lower because of the lower gold price, several Anglo

210

ROBERT GENTLE

51024/9/5189

subsidiaries have reported much improved levels of attributable earnings

These include Amcoal (up 58%), Amic (up 47%), Highveld Steel (up 114%) and Mondi Paper (up 56%)

Among major associates, chemical group AECI increased earnings 20%, industrial group Tongaat's earnings more than doubled, and engineering group Dornbyl benefited from strong consumer demand

The report says the contribution from De Beers, which enjoyed a highly profitable year, underpins the strength of the world diamond market

Although the report acknowledges the decline in profitability of many SA gold operations, it suggests this need not spell disaster

It says "Recent results from Vaal Reefs, Southvaal and Ergo are encouraging and demonstrate that the operations can move to higher grades at times of low gold prices"

The report concludes that Anglo shares, which offer "an almost unique spread of assets", will continue to outperform the gold index as it has done during the last 18 months until the gold price re-exhibits a bull trend

It rates Anglo shares as a strong buy

210
Mine bosses
call for unity

Star 12/21/69
Mine managers in the Free State gold fields have called on local communities and suppliers to rally behind the mines in their present crisis.

Reflecting growing concern about the viability of some of South Africa's oldest gold producers, the Association of OFS Mines issued a statement yesterday, calling on the mines, employees and associated businesses to unite to combat continuous cost escalation.

They said concerted action was necessary if the Free State gold fields were to continue as a community — Sapa

210

5/11/87 (15/87)

Anti-sanctions poll already under fire

NEW YORK — Even before it was released publicly, an authoritative Gallup poll showing that black South Africans overwhelmingly oppose US sanctions and divestment came under attack this week.

Senator Paul Simon said "I don't care how many polls you take, we know our duty and we will stand by it. All you have to know is who sponsored the study to know it is tainted."

Unbiased

The Chamber of Mines commissioned the internationally known Gallup poll organisation to conduct the most unbiased and statistically accurate sampling of the candid opinions of South Africans of all races and walks of life.

More than 2 000 individuals were questioned, say Gallup officials. Of the 1 400 blacks interviewed, samplings were taken in cities, small towns, villages and rural areas.

An additional sample of 200 squatters or shack dwellers living near major cities was conducted. People were interviewed by someone of their own ethnic group and in their native language in the privacy of their homes and without any identifying record kept of who they were or where they worked.

Tutu

What made the study controversial even before it was released was advance publicity quoting the report's main finding that South Africans of all races overwhelmingly opposed all kinds of sanctions and divestment.

Indeed, blacks say they believe foreign corporations can help to end apartheid quickly by helping to create jobs and improve education for them.

"I'll believe it when I see it," said Mickey Leland, a Democratic Party black

By Jim Srodes

House member who helped to lead the congressional push in 1987 that led to the first hard sanctions being imposed by the US.

The study will be released at a news conference which will be televised by satellite on Tuesday. It will feature statements by Gallup and Chamber of Mines officials in Washington and Johannesburg.

The results are especially controversial because Archbishop Desmond Tutu is expected here in a week's time to help Senator Simon and Ted Kennedy launch the new legislative drive to impose even tougher sanctions and divestment requirements on the 95 US companies still in SA.

Rob Jones, an executive with the American Committee on Africa, a leading protest group, said "There are

polls and there are polls and we will look at the Gallup sampling with interest.

"But we have to be guided in the final analysis by what the organised and recognised leaders of the anti-apartheid movement believe and they believe overwhelmingly that sanctions and divestment are successful."

"After all, when Mobil decided to pull out of South Africa last week, the black union only protested against the company's failure to negotiate the terms of its leaving with them. They did not protest at the decision to leave."

"If you look across the rest of the landscape to Cosatu, to the ANC, to the Council of Churches and to the leaders of that movement, all of them are united in their backing for economic sanctions and divestment. So I really don't know what difference this poll will make."

Star 18/1/89

Mine bosses v. 500 000

210
By MIKE SILUMA,
Labour Reporter

South Africa's most watched labour negotiations begin today when the country's biggest trade union meets one of the largest employers of black labour, the Chamber of Mines, to negotiate wage increases for about 500 000 workers

Because of the crucial role of gold in the country's economy, the outcome of the talks affect more than just the workers and the mining houses

Following its sixth biennial congress last month, the NUM pledged to seek wage increases in monetary, and not percentage, terms. It would demand a uniform minimum wage of R600/month for underground miners and R543 for their surface colleagues

Although the union declined to discuss percentages, some workers would, in terms of this policy, have their pay increased by up to 100 per cent

Speaking after the NUM congress, general-secretary, Mr Cyril Ramaphosa, said the demands were part of a programme to "drastically reduce" the pay gap between various categories of workers and to achieve a "living wage" in the industry by 1991.

NUM is also expected to seek improvements in working conditions

This position is likely to be strenuously resisted by the Chamber, which has already argued that in real terms, the wages of semi-skilled and unskilled workers in the industry have risen astronomically over the past 15 years

According to the Chamber, any drastic increase in miners' wages would place in jeopardy

at least 15 marginal mines presently struggling to keep their heads above water because of the low gold price, the high cost of production (including labour) and low grade ore

In turn, this would imperil thousands of jobs in an industry where at least 17 000 jobs have been made redundant in the past 17 months.

In the light of the above, it is possible that the Chamber will ask for separate talks to accommodate the marginal mines, while offering higher increases for non-marginal mines

Such a proposal would run counter to the union's stated aim of bringing the wages of members across the industry into line

Mr Ramaphosa has even suggested considering a system whereby profitable mines in a particular mining house would subsidise marginal mines in the same group.

From the NUM point of view differentiated minimum rates in each category would have the effect of dividing membership, with the union accepting a higher increase for some workers and less for others

According to the union, membership affected by the talks is spread out as follows across the mining houses

- Anglo American (111 030).
- Gencor (48 110).
- Rand Mines (18 618).
- Gold Fields (24 676)
- Anglovaal (4 107).
- JCI (4 269)

Meanwhile, the chamber is still locked in separate pay negotiation with the mainly white Council of Mining Unions. A Chamber spokesman said a second conciliation board meeting between the two would be held on Monday



Delegates at an NUM congress.

Barlows still leading the industrial field ⁴⁵⁰

Barlows remains South Africa's largest JSE-listed industrial company with total assets of R14 billion

The Financial Mail's Top Companies survey lists Remgro as second, with total assets of R7,7 billion, followed by CG Smith (R5,7 billion), Sasol (R5,4 billion) and SA Breweries

(R5,2 billion)

Compared with a year ago, CG Smith has moved up from fifth to third position and SA Breweries from sixth to fifth

Assessed in terms of market capitalisation, SA Breweries is first with R5,2 billion, followed by Barlows (R5 billion), Sasol (R4,5 billion), Remgro

(R3,9 billion) and Amic (R3,3 billion)

But if the market capitalisation net is spread wider to include non-industrial listings, SA Breweries drops to 10th position, being dwarfed by Congold (R17,3 billion), De Beers (R15 billion), Anglo (R13,9 billion), Lonrho (R11,1 billion),

5 Nov 1987

(210)

Wit Nigel's uphill task

To say that the market hasn't responded with alacrity to the news that Southgo has taken Wit Nigel under its wing, would be understating the issue.

In the wake of the announcement, Wit Nigel staggered up a couple of points from its 58c all-time low and at its ruling 65c can hardly be said to have attracted a host of buyers.

There are those who will protest that the shares have held up well in the face of the weaker undertone on the gold boards.

But in truth it must be acknowledged that Wit Nigel, having gone abortively through the hands of Peter George and Joe Berardo, will remain tainted until some hard, positive results are forthcoming.

That it is Southgo which has stepped into the breach hasn't helped the Wit Nigel image much, either.

For, while Southgo has achieved satisfactory results in the past year or so, they've been far from brilliant.

And Diagonal Street well remembers that the shares have tumbled from a 1987 high of 675c to the ruling 70c.

Yet it would be shortsighted to ignore the possibility third time lucky.

Southgo's plan for the mine's salvation is certainly more professionally structured than those pursued by the previous controlling shareholders.

It's a three-phase strategy that's worth examination.

The first recovery phase is the injection of 16,8 million of Southgo's Nigel Gold Holdings shares, which, it is hoped, will restore Wit Nigel's liquidity.

Indeed, Southgo predicts that Wit Nigel could be free of debt a year from now.

The second phase will be the removal of the debt overhang and the inflow into

210
Diagonal Street

JOHN SPIRA



the company's coffers of R120 000 a month worth of tributing income from Nigel.

As a result, Southgo claims, shareholders can reasonably expect a resumption of dividend distributions.

The third phase involves rationalising and developing Wit Nigel's mining activities.

Initially, these will focus on low (but much higher grade) production from underground, which tonnage will be handled by Nigel's recovery plant.

Priority is also being given to exploiting the Spaarwater section, which Southgo considers has a profitable and long-term role to play in Wit Nigel's future.

To expect the strategy to come to fruition on schedule would be shooting for the moon.

However, even if it takes a year or two longer than expected for the plan to come together, Wit-Nigel shareholders, bruised from years of broken promises, would be ecstatic.

Southgo shareholders, too, would benefit.

How would I rate the chances of success? At well below even.

But well above those of Wit Nigel's former management teams on the grounds that Southgo has the mining expertise to conjure payable gold from an area where so many others before it have failed.

23/5/54
Sawyer
(210)

Expert reports on mines

THE Government expects to receive an expert report drawn up over the weekend on possible assistance to save ERPM and Durban Deep mines.

Dr Org Marais, Deputy Minister of Finance, said the expert finance group had worked all weekend to complete the report.

An announcement could be expected from the Government over the next few days, he said

A number of options had been considered, he said.

Over-supply

Marais said he could not preempt the announcement. However he felt that if the Government could keep viable mines going, it was important to do so.

He said ERPM seemed to be "a mine with possibilities". At the moment it was just a question of the over-supply of gold which was affecting the price

The new Australian fields would be putting over 200 tons on the market this year but this would probably tail off to 100 tons next year.

Marginals

Marais disclosed that he would be investigating the position of all marginal mines. He had asked the chamber of mines to prepare a report on their long and short-term prospects.

The solution for the ERPM and Durban Deep crisis would have to take into consideration the position of all marginal mines

"We can't help them in such a way that we give all to them and leave nothing for others"

Barlows beats most expectations

By Ann Crotty

After an excellent performance in financial 1988, Barlows has reported interim figures for 1989 well ahead of most expectations

In the six months to end-March earnings were up 39 percent to 238,2c (171,6c) a share (on an additional 2,5 million shares)

A dividend of 51c will be paid — 31 percent up on the previous 39c.

Turnover was up 26 percent and operating profit surged 44 percent to R1,3 billion (R891,7 million), reflecting a sharp improvement in margins from nine percent to 10,3 percent.

Taxed profit, including associates, showed a 37 percent advance to R779,5 million (R570,8 million)

Attributable profit was 41 percent ahead at R438,2 million (R311,4 million)

The strong performance (most analysts were looking for an improvement of 30 percent), reflects a massive improvement at wholly owned Middleburg Steel where strong demand and favourable pricing lifted margins and pro-

duced a 100 percent improvement in profits

News of the results apparently filtered through to the market before the close of trade yesterday and helped to counter possible adverse sentiment from reports that two of the group's ailing gold mines might have to close

It also cushioned the share from the sharp general downturn in investor sentiment. In early trading the share dropped 125c to a low of R34,75, it recovered to close at R35,50

The weakening reflects a certain degree of irrational behaviour in view of the excellent performance and given the reasonably strong prospects for the second half

Management is cautious, which seems appropriate considering the degree of uncertainty in the group's trading environment, but believes the group should have a good year, despite the slowdown

If it can achieve a 30 percent earnings improvement for the full

year, EPS of 530c are on the cards. This means that at yesterday's close, the share was offering a prospective P/E rating of 6,7 times

A divisional break-down highlights the source of the growth performance. Despite the weak gold price, mining and mineral beneficiation (which includes Middleburg Steel) turned in a 69 percent advance at taxed-profit level to R249,2 million (R147,8 million)

The firmer coal export market also helped boost contribution

The industrial division performed well off a high base, with a 26 percent increase to R295,8 million (R233,9 million)

Contribution from food and pharmaceutical was up 33 percent to R205,8 million (R155 million)

The international division had mixed fortunes and its rand performance — there was a 24 percent improvement to R49 million (R39,6 million) — was helped by the decline in the rand/sterling exchange rate

Towns tremble over mines

SA 24/5/57

By Sue Olswang

210

The Roodepoort and Boksburg chambers of commerce anticipate serious economic setbacks if the Durban Roodepoort Deep and ERPM mines close as a result of the sliding gold price

ERPM (East Rand Property Mines) is a major employer in the Boksburg area, with more than 11 000 employees, while Durban Roodepoort Deep (DRD) employs approximately 7 000 mineworkers.

Spokesmen for both chambers yesterday said the closures would have "very serious" effects on businesses in Roodepoort and boycott-burdened Boksburg.

SUPPLY STORES HARD HIT

However, Mr Johann Viljoen, president of the Boksburg Chamber of Commerce and the Boksburg Alliance, said "one should not make too many waves at present because there could still be Government assistance and the mines would continue to operate"

"We hope this is what will happen because the effect . could be very serious otherwise," said Mr Viljoen.

Elder Altus Strydom, president of the Roodepoort chamber, said Roodepoort's mining supply stores would be hard hit by the closure of Durban Deep

"I imagine the effect would be serious, but I cannot be accurate because we do not know how many other mines are supplied by these same stores," he said

...the bank owed about R2,6bn in January this year, compared with R973m in January 1988.

JMF owes R23m, is worth R22,5m

REINIE BOOYSEN

JOE Berardo's mining group, JMF, today worth R22,5m on the JSE, owes creditor banks R23m.

Sixteen months ago the group, which has never reported a loss since listing on the JSE, was valued at close to R1bn.

Berardo, who owns a 75% stake, will not receive a cent for this stake, according to a spokesman for the consortium which took control two days ago.

The spokesman, stockbroker Norman Lowenthal, said the group was faced with liquidation, six months after Berardo forecast continued profitability for the group.

In his annual chairman's review, published in September, Berardo said:

"Despite the present difficult economic and political climate, I expect a continuing improvement in the group's profitability and its ability to turn its substantial and valuable asset base to good account."

Berardo is rumoured to have left SA for Madeira, the land of his birth.

On Wednesday another member of the consortium, Johannesburg attorney Gerald Rubenstein (of Fluxman, Rabinowitz & Rubenstein) told Business Day that JMF (Johannesburg Mining & Finance), the

□ To Page 2

R23m owed

group Berardo brought to the JSE in November 1987, owed its banks — First National Bank, Bank of Lisbon and Trust Bank — about R23m. He said it was unclear how much JMF owed other creditors.

Lowenthal said he was still trying to unravel the exact structure of the group, which consisted of 72 companies, which are linked via elaborate cross-shareholdings.

He said the consortium will not pay Berardo for his controlling interest in JMF. Instead the consortium will inject an undisclosed sum of money into the company, and the banks may be issued with debentures in lieu of their credit.

Meanwhile it emerged yesterday that JMF deputy-chairman Don Grant-Hodge has resigned his position on the board. His secretary told Business Day Grant-Hodge "was on a cruise for his annual holiday". She added that she was not certain whether

Grant-Hodge would return. Shareholders have questioned why JMF is facing liquidation if it has never reported a loss since listing on the JSE in a complex reverse takeover of Consolidated Granite in the nine months to March 1988, it declared an attributable profit of R14m. The next (interim) report for the six months to September 1988 reported attributable income of R2,8m.

Six months later the company was faced with potential liquidation, and takeover negotiations started with the Lowenthal-Rubenstein consortium.

Berardo has been overseas for some time now. JMF technical director Tony Netto told Business Day he could not remember when he last spoke to Berardo. He added "It must have been a couple of months ago".

□ From Page 1

Gencor's energy empire takes shape

210

STW 27/5/87

AS A visionary, every new undertaking for Mr Bernard Smith, senior general manager, special projects, Gencor, is an adventure into uncharted waters, as a realist, a challenge to create and build a bustling growth centre

With his gargantuan appetite for work, his determination and energy, one could be mistaken for thinking he has a blood relationship with the Trojans

His total devotion to every project in which he is involved, his technical brilliance and strong flair for leading from the front and his knowledge of the oil industry make him the ideal person to manage the production of oil from Moss gas and the refining and retailing of fuel through Mobil and Trek

Before Moss gas came along, Gencor had discussions with Soekor and the Central Energy Fund about oil exploration on the South African coastline. This gave rise to an agreement and it seemed logical that when the opportunity arose to participate in Moss gas that Gencor would be a partner

The company's mission is to grow its companies and find major new business opportunities. Clearly, the energy area is of these

North Sea

For some years it has been involved in a low-key way with oil exploration, mainly in the North Sea where it has an eight percent interest in the Alba field, along with most of the major oil companies

On Mobil, there has been a lot of speculation on what Gencor paid for the company but he would "rather not comment at this stage" but only to say that when the deal is finalised he will probably be chairman

He does not consider the Mobil pull-out as disinvestment. The company had been placed in a difficult situation over the Rangle Amendment which gave rise to the fact that its assets in South Africa were not being fully utilised. The amendment had resulted in Mobil

STAN KENNEDY

having to pay tax both here and in the US

Gencor, he says, sees the synergy of acquiring Mobil. It has an exploration venture with Soekor; it has a 30 percent stake in Moss gas and manages the project, and it is currently completing a feasibility study on the torbanite synthetic fuel project

"Gencor also has the major share in Trek and if you add Mobil to the refining and retailing, you start to have a useful vertically integrated energy company. So acquiring Mobil makes a lot of sense"

Consolidation

"What we hope to do is to consolidate all our energy interests into one really effective company that will probably, in due course, be quoted on the stock exchange"

Mr Smith has been on a winning streak all his working life and has risen to top positions in his field at regular intervals. He tends to take the long view of things and believes that hard work is the essential ingredient to anyone's success. He puts determination to succeed as another

At Wits he gained a mining degree and immediately joined Randfontein Estates as a surveyor before going into mining proper and becoming a shift boss

He spent a year in Swaziland developing a coal mine from grass roots — bringing a mine to life this way is a forte of his and he has done it many times — then going down all the roads one can travel on a mine before becoming consulting engineer

His departure from JCI in 1980 was probably the saddest day of his career. He had set his sights on becoming JCI chairman when Sir Albert Robinson retired. The job, however, was given to Mr Gordon Waddell and, being the same age, he quickly saw there that further promotion was out of the question.

He had been executive director JCI and chairman of all its gold-mining companies, as well as chairman of Rustenburg Platinum Mines

After physically looking around the world for a challenging post, he plumped for a job with BP in London as general manager, BP Coal International. Ambitious, though one would hardly notice it in his phlegmatic and relaxed manner, he saw that the incumbent chairman would not stay too long after BP acquired Selection Trust. In 1982, he took over as managing director and chief executive of BP Minerals International

Excitement, almost euphoria, grips him when he sets about a new mining venture from scratch

"It is just incredible to see what a major mine can do in an isolated area. There are new work opportunities, people become trained in skills they would otherwise not have learned and buildings and shops go up all over the place. It becomes a hive of activity where once it was desolate and the people's quality of life is enhanced"

Strategic thinking

His experience with BP and his exposure to the type of strategic thinking that goes into such a company and the way it handles and develops situations was a great learning experience for him

While he has been the architect of many mines and projects in South Africa, he never dwells on his achievements. What does absorb his time and thoughts are the things in front of him, the things still to be done

He is an optimist and believes that coupled with drive it can carry one through difficult times or generate opportunities that might not be identified by a realist

No sooner does one take the eggs away from the hen than it starts laying again. In a similar way, the completion of one project means the start of another for Mr Smith

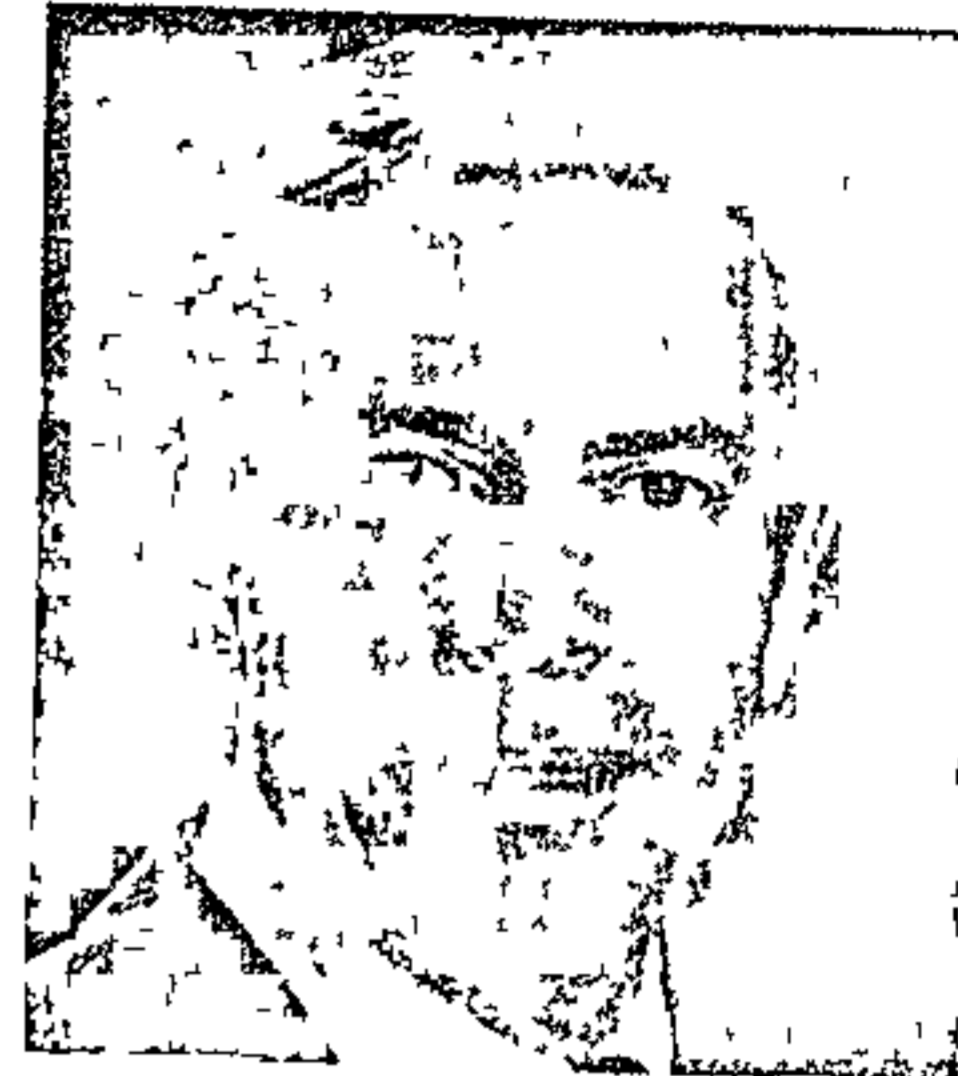

Bernard Smith — on a winning streak all his life

Berardo²¹⁰ likely to step down

5825/82
5/24/82

Johannesburg Mining and Finance Corporation (JMF) chairman Joe Berardo, is likely to step down as chairman if the bid by a local consortium to take over the cash-strapped company is successful

This was said by deputy chairman Mr DM Grant-Hodge when confirming that JMF was involved in negotiations with a consortium, headed by two prominent businessmen, Norman Lowenthal and Gerald Rubenstein

Such a move would be of benefit to the Group, he said "Among other things it will add value to the shares and it certainly will be putting funds into the company which should help solve the liquidity problems"

Mr Grant-Hodge did not want to speculate on what the increase in shares was likely to be if the bid succeeded, with the uncertainty prevailing in the present falling market, except to say that there would be definite benefits and changes — Sapa

Gencor seeks a record R1,5bn

S/Times 28/5/89

210 

CARTE BLANCHE



By David Carte, BUSINESS TIMES Editor

Datakor's acquisition last year of American computer major Unisys has paid off handsomely.

Sales of SA's No 2 computer company leapt by 245% to R362-million and taxed profit by 135% to R20-million in the year to March.

The group was able to service the 80-million new shares it issued for Unisys and earnings rose by 12% to 17,3c (1988 - 15,4c) A final dividend of 4,5c has been declared, making 7c for the year.

The result only meets forecasts made at the time of the takeover. It is nevertheless a pleasant surprise to a market expecting the worst after disappointing results from some rival computer companies.

"One of the unseen benefits of disinvestment," says chairman Nic Frangos, "is that it has put SA managements on an accelerated learning curve. I don't think anywhere in the world are business people learning so much so quickly. It's misguided for people to leave SA. The opportunities here are unparalleled."

Mr Frangos admits that multinationals continue to dominate computers worldwide and takes considerable comfort from Datakor's continuing links with Unisys.

Mr Frangos says rationalisation benefits still to be realised will push the company to greater heights next year in spite of a fast-cooling economy, the lower rand and higher interest rates.

He is looking for sales of R500-million in the current year. Orders in the past six

Datakor cashes in on quitters

ers dominated hardware and software choice. Now customers have closed the knowledge gap. They know better than any supplier what they need to serve their customers - and they demand flexibility.

"Suppliers no longer dominate the purchase decision. We can offer a variety of open systems."

Datakor has made a particular drive on banks. All but one of the large banks is on its Timeplex system. Unidata has 57 main-

GENERAL Mining Union Corporation (Gencor), SA's No 2 mining house, is coming to the stock market with the biggest rights issue in JSE history.

The fast-growing, highly rated mining house decided at a board meeting on Friday to ask shareholders for about R1 500-million.

It will offer 20 new shares for every 100 in issue at a price still to be determined. It will probably be at a small discount to the market price of R88.

Mossgas

Executive chairman Derek Keys says: "We do not have any particular projects in mind. The Mobil acquisition is already financed. We believe that Gencor should not come to the market with a rights issue more than every four or five years - and it's always best to look for finance when you don't need it."

Gencor recently bought Mobil SA at a cost said to be about R600-million cash. It also plans many other projects.

It is managing the Mossgas project and has the right to acquire 30% of it in two years.

New gold mines, such as Oryx, Karee Platinum and possibly the Poplar mine could need more millions.

Gencor is also expected to go ahead of its torbanite shale-oil project, expected to cost more than R1-billion.

Other companies in Gencor, such as Impala Platinum, Samancor and possibly Sappi and Malbak, could also hold rights issues, necessitating more cash in Gencor's coffers.

By David Carte

Controlling shareholder Federale Myndou is supporting the offer and will itself hold a 22-for-100 rights issue. It will be supported by major holders Sanlam and Rembrandt.

Sanlam, with 52% of Federale Myndou, will kick in roughly R450-million and Rembrandt about R250-million.

Richard Stuart, analyst at Martin & Co, lead broker to the issue, says the time is right for Gencor to use its paper to build its balance sheet for the next generation of projects.

"All parts of the group are working well and management under Derek Keys seems to have called all the plays right recently. Not surprisingly, Gencor enjoys strong shareholder loyalty."

"Mr Keys has demonstrated that if you give him money, he adds value. People like to give him money because he knows what to do with it."

Mr Stuart says institutions will not balk at the idea of rights issues every four or five years, provided Gencor has good projects.

Cooling

The weak rand is expected to boost the gold, coal and platinum mines, as well as Sappi, Samancor and Richards Bay Minerals, so things look good for Gencor in spite of the cooling SA economy.

An institutional fund manager outside the Sanlam group says Gencor is laying impressive building blocks.

It is diversifying out of gold into other minerals and energy. The industrial turnaround in Malbak is convincing enough for him to support the issue.

Gencor's move is the second in what is expected to be a spate of rights issues. Brokers and institutions say rights issues plus the privatisation of Iscor could absorb up to R8-billion in the next year.

On the one hand, companies are eager to tap unprecedented institutional liquidity. One estimate is that R23-billion is available.

On the other hand, many mines are being worked out and the time has come for new ones to be sunk. There are numerous promising prospects in gold, coal, platinum and diamonds.

Rainbow

Rembrandt company Hunt Leuchars & Hepburn has announced an issue to fund its R750-million Rainbow Chicken subsidiary.

Iscor is expected to be capitalised at R3-billion when it comes to the market, although probably only half of this amount will be tapped.

Other mining houses expected to come to the market soon are Gold Fields of SA and Anglovaal.

GFSA has indicated to parent Cons Gold the need for

● To Page 2

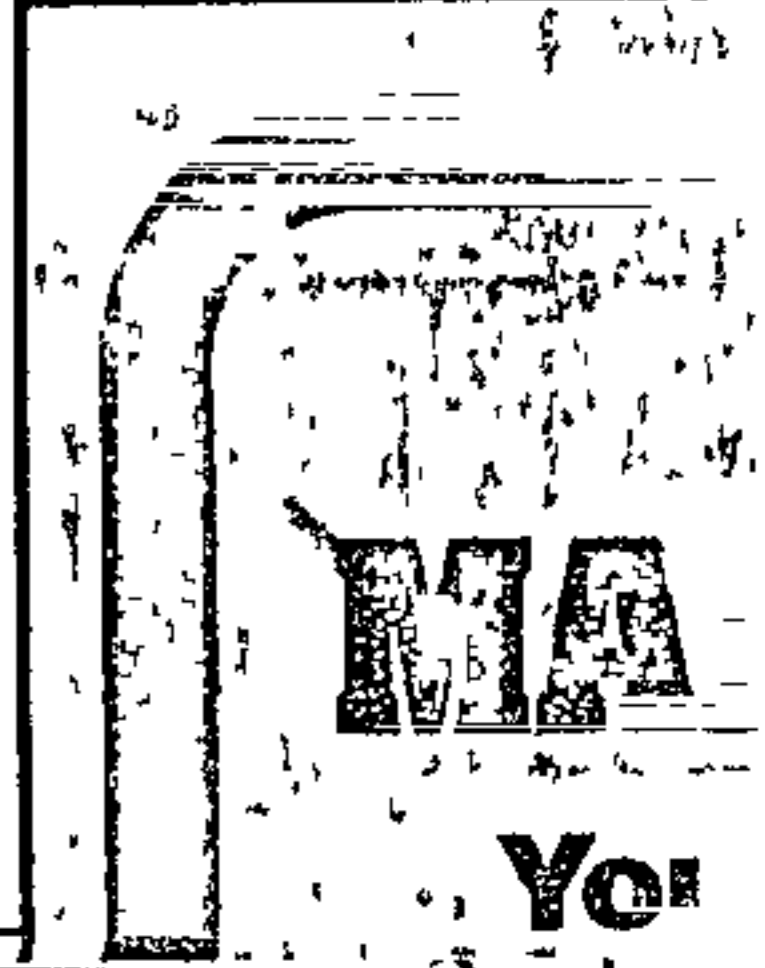

● From Page 1

more cash to fund projects totalling more than R1,5-billion. One of GFSA's big projects is its proposed Northam platinum mine.

Anglovaal needs money to fund a new mine at Bothaville. Its participation with associate Middle Wits in De Beers' Venetia diamond project may also require more

Gencor

money. Waltons and First National Bank are also expected to come to the market for money in the next year.

An institutional fund manager quips: "The ducks are quacking and companies are doubtless going to feed them with plenty of paper."

New owners pick up the pieces

The house that Joe built ruined

S/ Times 28/5/89

(210)

JOE Berardo is sitting in Madeira contemplating the loss of his self-built mining house, once valued at R1-billion.

A consortium of mostly anonymous SA business interests has taken control of beleaguered Johannesburg Mining & Finance Corporation, Egoli, West Wits, Carrijs and Corex

Mr Berardo, the penniless immigrant from Madeira who built JMF into a short-lived mining and industrial empire, and deputy chairman Don Grant-Hodge walked away from the group on Friday without a cent for their 70% stake.

Bleeding

They have been replaced on the boards of the five public companies in the group by consortium leaders stockbroker Norman Lowenthal and lawyer Gerald Rubinstein

Mr Lowenthal says "We have taken physical control. We still have some bleeding to stop, but the group's situation is not as bad as we thought it was. It is merely a cash-strapped company"

Mr Rubenstein says no evidence has emerged to confirm rumours that large amounts of company money have left SA

The new controlling shareholders, who refuse to be

By Ian Smith

identified yet, plan a R30-million recapitalisation, and hope to return the group to its mining roots

The recapitalisation will take the form of a cash injection, an issue of convertible debentures and a compromise with banks.

One of the loss-incurring industrial companies, Ply-products, has been sold. "The



JOE BERARDO

proceeds — a large amount — are in the bank," says Mr Lowenthal

Professional mining consultants are being appointed to advise JMF management, which is under the control of three of Mr Berardo's directors who have remained on board, and financial director Hendrik Buitendag, technical director Tony Netto and legal director Michael van der Watt.

Mr Lowenthal says negotiations for the holding con-

trolled by Mr Berardo, and Mr Grant-Hodge, were "friendly and constructive".

"They were concerned about the position of the minority shareholders. They have been co-operative."

The consortium, he says, has strong backing. Most of it is South African, but part of the money comes from abroad.

Mr Lowenthal says the mining operations, particularly West Wits, are showing positive cash flow. The deal has safeguarded the jobs of several hundred miners.

The group's industrial operations will be disposed of as they are brought back to profitability.

The prestige head office block in central Johannesburg will have to be completed and tenants installed before any attempt is made to sell it.

Mr Berardo started work in SA on a farm at R10 a month 25 years ago. He became a market gardener and supplier of vegetables to the mines. He pioneered the re-treatment of dump material. It was only after he showed that gold could be won from mine sands that Anglo American launched Ergo. His dump treatment company, Egoli, was listed in 1969.

JMF came to the JSE in 1987 through a reverse take-

● To Page 2

From Page 1

over amid a fanfare — it was the first mining house to be listed in nearly 30 years

Eighteen months ago the group hit its high point when its worth was close to R1-billion. Mr Berardo's wealth was estimated at R200-million. He was the friend of cabinet ministers and drove a gold-plated Rolls-Royce. He was chairman of the Bank of Lisbon

In the nine months to

Berardo

March last year JMF's attributable income was R14-million — R7,5-million from mining

But by September last year some of the cracks were beginning to show. Debt mounted and a weaker gold price began to hurt. JMF's earnings a share were 2,1c compared with 7,3c in the same six months of the previous year

Early this year panic set in and the share prices of all the group companies tumbled. JMF admitted it had cash-flow problems, but denied that it could not meet its debts

Early in March the JMF share price, which had once stood at a proud 300c, hit its low of 12c and the principal mining company, Egoli, was down to 60c from its high of 525c.

The shares were suspended this week, JMF at 18c and Egoli at 75c.

Gencor move likely to have followers

More firms 'to cash in at the JSE'

(2/10)
B. J. De...
24/5/89

ANALYSTS expect more top companies to follow Gencor with rights issues as institutions are sitting on at least R20bn in cash which could flow into equities

The abolition of prescribed asset requirements for pension funds and life offices has freed billions of rands to flow into equities, including privatisation, instead of into gilts or semi gilts

In spite of uncertainty over the direction of the JSE, analysts said the liquidity meant quality companies would have no problems in raising capital

The Gencor rights issue of about R1,5bn will be accompanied by a 22-for-100 issue by Federale Mynbou which is expected to raise about R880m, bringing the total demand on the market to almost R2,4bn

This issue will take place before the Iscor privatisation, which will probably demand at least R1,5bn from the market

Sanlam MD Pierre Steyn said yesterday. "The abolition of prescribed asset requirements means savings can be mobilised for privatisation and for expanding companies

"There is no doubt that other top companies will follow Gencor with rights issues this year. Companies are seeing their share prices on the JSE as being reasonably high, even after the recent downward movement"

Analysts said Gencor had timed its issue particularly well by getting in ahead of the Iscor privatisation. But some said the outlook for the JSE was uncertain

A sustained slump in the gold price could depress the market, pushing down Gencor's share price and reducing the capital it will be able to raise through its offer of 20 new shares for every 100 in issue

GRETA STEYN

Liberty Life joint MD Mark Winterton said the JSE had "suffered a bit of a setback because of the gold price

"Companies might find they have to offer quite a big discount on their share prices when raising new capital"

But he agreed institutional liquidity was a positive factor for the market

Gencor executive chairman Derek Keyes said "Although the offer price still has to be finalised, we will raise about R1,6bn, based on Gencor's market price of about R87. Our shares enjoy a good price and the institutions have surplus funds"

He said the company's research had shown that the idea of a Gencor rights issue would be favourably received by the market

Gencor is well regarded, especially after its 55% increase in interim earnings

Keyes said Gencor did not have any specific projects in mind and that the capital would finance its growth. "We believe Gencor should do a rights issue once every four or five years"

He said the capital would help Gencor, which has a R10bn asset base, to finance its expansion programmes and will enable the group to maintain growth momentum through speeding up development of existing business and making new investments possible

There has been speculation for some time that it might be interested in ConsGold's 38% share in GFSA, but a spokesman yesterday declined to comment on the talk

Gencor recently bought Mobil for an estimated R400m-R600m and Keyes said that had already been financed

More pressure on petrol slate

ZILLA EFRAT

THE falling rand, coupled with escalating international fuel prices, is certain to put pressure on the petrol slate

Rand 'will affect

THE weak rand would mainly affect the new local content programme — requiring extensive tooling up — where much of the equipment was imported and could result in huge forex losses, motor industry analysts said

Decision on ²¹⁰ mines needed 'within days'

By Sven Lunsche

Rand Mines has urged the Government to make a decision as soon as possible on whether or not to provide assistance to the two troubled RM gold mines, East Rand Proprietary (ERPM) and Durban Roodepoort Deep (DRD)

In advertisements placed today, Rand Mines confirmed that financial aid was necessary to keep the mines operating

"An early improvement in the gold price to levels which would enable these mines to operate profitably is not foreseen," the statement said.

DELAY

Last week, the Government indicated that it would delay the decision until the future of all South Africa's marginal gold mines had been discussed

After urgent requests by Rand Mines, a meeting between Deputy Minister of Economic Affairs and Technology Mr George Bartlett and Rand Mines representatives was convened at the weekend

Rand Mines director Mr Clive Knobbs reportedly stressed that a decision was needed within days not weeks, as ERPM needed assistance until a new shaft could be brought into production in five months' time.

This expansion would allow the mine to lift production by more than 100 percent in 1993

JUST



Gencor jumps the queue

By Derek Tommey

Gencor, the mining house controlled by Sanlam and Federale Mynbou, has jumped to the top of the queue of companies, previously headed by Iscor, who are planning to raise huge amounts of capital from the pockets of the cash-flush institutions this year

Gencor announced at the weekend that it is to raise just under R1,5 billion by a 20-for-100 rights issue at a share price still to be determined. It is expected to be slightly below the current market price of Gencor shares of R86

The announcement raises the question of why Gencor has come to the market at this time for such a huge sum?

Gencor's chairman, Mr Derek Keys, says that the group has no particular new project in mind for which the finance is required and the Mobil acquisition, reputed to have cost Gencor some R600 mil-

lion, had already been financed

Instead, the money would be used "to finance Gencor's growth programmes and to put the group, which presently has an asset basis of R10 000 million, in a position to maintain the momentum of its growth by means of the speeded up development of its existing businesses and the utilisation of new investment opportunities"

Mr Keys adds that the group has been successful over recent years in a number of large projects and undertakings and that at present a number of exciting projects are in the offing

However, analysts have suggested that with Iscor coming to the market in October for about R1,5 billion and possibly another R1,5 billion over the next year or so, with Eskom possibly following shortly afterwards, and with many of the major mining houses also likely to require substantial capi-

tal in the next year or so, pressure on the supply of investment funds is likely to increase fairly substantially

One important result of this could be a significant rise in the price of new capital

The institutions are reputed to have some R23 billion available for new investment. If this is true they must have a lot of cash in the money market earning 17 percent

And while it is part of the institutions' philosophy to take a long view and invest in the share market, they are not likely at present to want to knock their investment income by putting too much into low-yielding equities

So while new investment funds will be forthcoming Gencor, in going to the market now, is showing considerable shrewdness for it will probably get the funds it wants at a lower cost than, say, if it had waited until next year

Stu 30/5/89

Decision on Rand Mines 'needed soon'

By Sven Lunsche

210

Rand Mines has urged the Government to decide as soon as possible whether or not to provide assistance to the two troubled RM gold mines, East Rand Proprietary (ERPM) and Durban Roodepoort Deep (DRD)

In advertisements placed yesterday, Rand Mines confirmed that financial aid was necessary to keep the mines operating

"An early improvement in the gold price to levels which would enable these mines to operate profitably is not foreseen," the statement said

Last week, the Government indicated it would delay the decision until the future of all South Africa's marginal gold mines had been discussed.

STRESSED

After urgent requests by Rand Mines, a meeting between Deputy Minister of Economic Affairs and Technology Mr George Bartlett and Rand Mines representatives was convened at the weekend.

Rand Mines director Mr Clive Knobbs reportedly stressed that a decision was needed within days, not weeks, as ERPM needed assistance until a new shaft could be brought into production in five months' time

'Soundings' in ²¹⁰

Kalahari park

Star 11/6/81
By James Clarke

Gencor, the Johannesburg mining company, is being allowed to make "electrical soundings" in the Kalahari Gemsbok National Park. But it denies it is exploring for minerals.

What is the mining giant doing in a national park? Neither Gencor nor the National Parks Board is able to provide a clear answer.

The Star was tipped off that the National Parks Board had given Gencor permission to do mineral exploration inside the park's boundaries.

The National Parks Act forbids prospecting of any kind in the big national parks.

The chief director of National Parks, Dr Uys De V Pienaar, told me that Gencor had been doing an aerial survey across the Kalahari, from Botswana to Namibia. It had seen "something" from the air and had asked permission to follow it up on the ground.

Dr Pienaar said Gencor was "definitely not prospecting", but he said he did not know what in fact the company was looking for.

Anglo No 20 in Fortune League

STimes 4/16/81

210

tribution to equity accounted earnings fell marginally last year from R392-million to R391-million and diamonds' share rose by 94% to R679-million

In the final analysis, diamonds increased their contribution from 19.3% of the total to 25.7%. Gold's contribution slipped from 21.7% to 14.8%

Mr Relly says diamond earnings are expected to grow again in the current year after the recent dollar price increase and the rand's fall

Industry and commerce increased its contribution to the total from 16.2% to 18.8%, or R498-million

The 70% lift largely reflects excellent results from Amic, where Samcor is making satisfactory profits and Boart, Scaw, Mondri and Highveld are doing well, particularly in foreign markets.

Steps

But Mr Relly says that recent steps to dampen the economy and indications that commodity prices have peaked foreshadow a lower rate of earnings growth

The contribution from platinum and other mining

● To Page 2

By Ian Smith

ident that it will retain its long term importance to SA.

Anglo intends to spend between R170-million and R180-million on gold exploration this year — up from last year's R138-million

Attributable earnings which increased from R1 037-million to R1 245-million showed 20.9% growth, which might look pedestrian when compared with Gencor's 55% profit lift

Retained

But Mr Relly says the lower rate of increase in attributable earnings reflects the fact that the corporation's associates retained a greater proportion of their profits

It is not Anglo's policy to own 100% of subsidiaries and this makes it difficult to draw comparisons

The results of about 30 Anglo associates are equity accounted including major contributors like De Beers, Minorco Amic and JCI

Because they are not controlled by Anglo only dividend income is brought to account for attributable earnings

Mr Relly says "Accounting of their retained earnings is entirely realistic in the determination of our bottom-line equity accounted earnings in view of our significant shareholdings in those independently managed companies and the conservative accounting policies adopted by them"

The associate companies need to retain a greater portion of their earnings in times of high inflation and when funds are earmarked for new projects and expansion slows the increase in Anglo's attributable earnings

ANGLO American Corporation's R800-million earnings leap in the year to March has re-deemed the reputation of SA's mining and industrial juggernaut

The 46% earnings leap announced this week would place SA's premier mining house among the 20 most profitable corporations in the US as rated by Fortune magazine — in spite of a weak rand

Before the result, Anglo was looking sheepish because of the failure of Minorco's bid for Cons Gold

It also suffered in comparison with the more dynamic moves of rival mining house Gencor

Anglo rode high even though gold hardly glistered in the past year. Scintillating results from diamond monopolist De Beers and from industrial giant Amic pushed equity-accounted earnings to a record R2 645-million — 46.2% above last year's R1 809-million

Sleeping

Measured by shareholders' funds Anglo would rank 12th in the Fortune list of the top 500 US corporations — ahead of Texaco Anglo had equity of R28.5-billion (\$10.3-billion)

Chairman Gavin Relly believes the results give the lie to any suggestion that Anglo is a sleeping giant or that it has let development opportunities slip through its fingers

Mr Relly says "The results reflect the far sighted investment strategies adopted over the years which have resulted in a portfolio which is sufficiently robust to provide excellent growth despite the static earnings of the gold-mining industry"

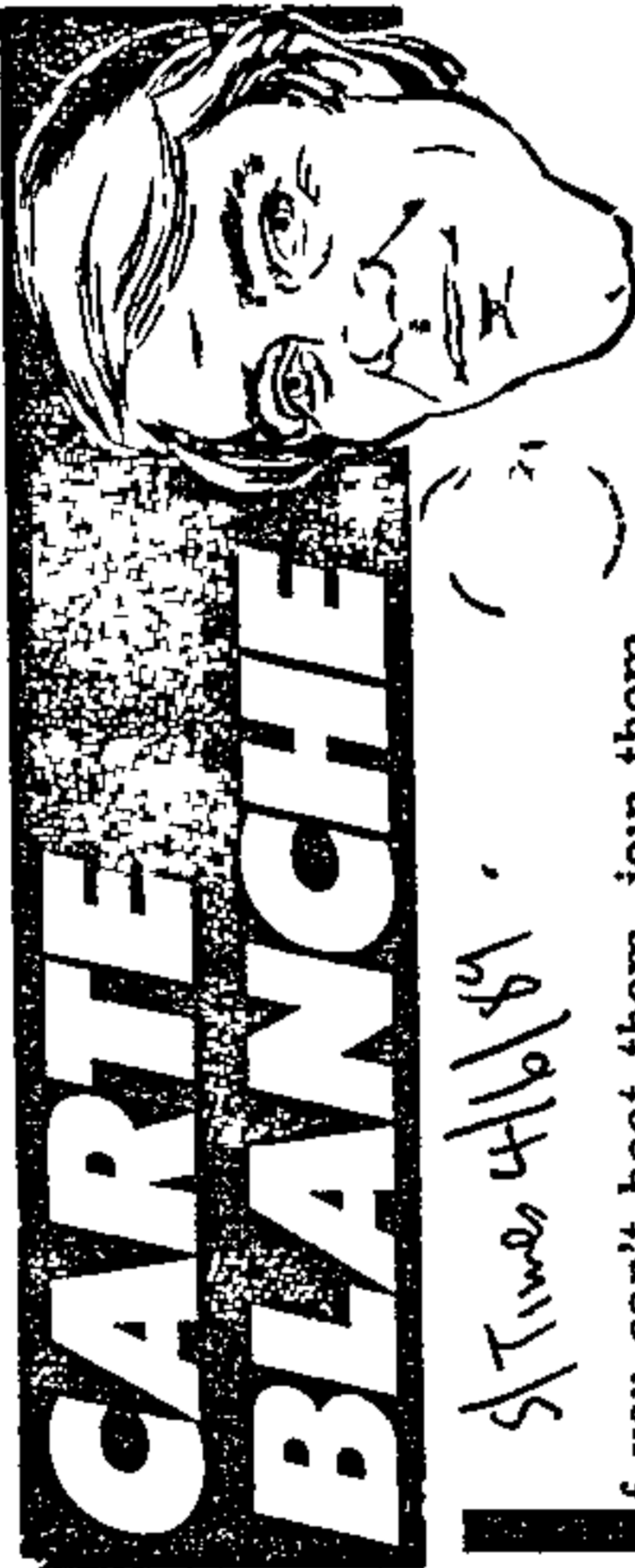

By David Carte, Editor

A helping hand from banking

cost to competitors

The Hogan system requires four times more hardware than ours," he says

The war with the banks goes on "They are not talking about it so much any more because the interest-rate pattern does not suit them so well"

Because building societies have longer-term deposits their cost of funds is slower to fall — or to rise They are thus currently at an advantage

Only Nedcor manages a higher return on assets than UBS

Mr Badenhorst recognises that banking is a minefield for the uninitiated That is why UBS has gone to such lengths to employ

If you can't beat them, join them

This seems to be the credo of Piet Badenhorst, chief executive of UBS Holdings

He has long complained that the playing field in financial services is not level, sloping appreciably in favour of bankers and assurers

He told the Investments Analysts Society this week that 90% of life assurance business, even a good part of pensions business, is deposit taking in disguise

Mr Badenhorst did not mention the assurers' biggest advantage — being in real assets such as shares and property, rather than in financial assets that are eroded by inflation

His solution to the UBS disadvantage? Get into insurance and banking through the purchase of 30% of Volkskas and 30% of Commercial Union UBS's life arm which sells mainly mortgage protection policies contributed a taxed profit of R10 million

Mr Badenhorst said "That was a conservative estimate of life profits after an actuarial valuation We know of a competitor that reported a profit of R21-million on a much smaller life arm"

As a result of diversification and thanks to equity accounting UBS Holdings was happy to report this week that something like 38% of taxed profit came from banking and insurance last year

Growth in the two new areas outstripped that in the building society White building society profits rose only 12.5% assurance profits rocketed 75% and banking profits by 20% plus Less than half of taxed profit came from the building society compared with 19.5% from banking and 18.6% from assurance

From Page 1

increased from R140-million to R200-million

Falling metal prices mean earnings should level off this year.

The revival in coal meant its contribution rose by 57% to R80-million Improved ex-

ports, the low rand and higher Eskom demand enables Amcoal to forecast an increase in earnings, but at a slower rate

"Export earnings and offshore investments ensure considerable protection

Anglo (210)

against the weak rand and the balance sheets of the associated companies are extremely sound," says Mr Relly

To round off a pretty picture, he says Anglo's balance sheet reflects minimum gearing and a large cash balance

Stew 6/6/89

Higher profits and dividends at Anglovaal ²¹⁰

Finance Staff

Three Anglovaal companies, Anglovaal, Anglovaal Holdings and Zandpan, have all produced record consolidated earnings and dividends for the year ending June 30.

A fourth investment holding company, Middle Witwatersrand (Western Areas), declared an unchanged final from lower profits

Anglovaal earned R176,0 million for the year a 21 percent increase on last year's R145,3 million. A final dividend of 510c (430c) has been declared making 760c for the year — 17 percent more than last year's 650c.

The increase earnings reflects higher estimated earnings from Anglovaal Industries, a sharp rise in the equity-accounted earnings of the Associated Manganese Mines of SA, increased dividends from the Anglovaal Group's gold mines and the consolidation of its recently-acquired Lavino Chrome Mine's earnings.

Against this, the group anticipates lower dividends from Prieska and also higher exploration expenditure.

Anglovaal's 5 percent participating preference shares are paying a final dividend of 260c (220c), making 390c (335c) for the year.

Its unsecured variable rate subordinated loan stock is paying interest of 42c (34,5c) a unit.

Anglovaal Holdings has increased its final dividend to 51c from 43c last year ago, making a payment of 75,5c (64,5c) for the year. Estimated taxed profit was 17 percent higher at R7 000 000 (R5 974 000).

Estimated consolidated taxed profit of the mining investment company, Middle Witwatersrand (Western Areas) earned R27,7 million (R31,2 million) after including a R9 million extraordinary payment and held its final dividend at 100c to make 150c (160c) for the year.

Income from Middle Witwatersrand's mining investments — including earnings from the recently-acquired Lavino Chrome Mine shares — was higher, but exploration and other costs also increased.

Zandpan which has a 19,6 percent holding of Hartebeestfontein, is paying 17c (15c) a share making 30,3c (25,6c) for the year.

Zandpan's estimated profit is R39,4 million, an increase of 18,5 percent on last year's R33,3 million.

WAGE GOVERNMENT

PAGES AND PAGES OF THE BEST JOBS IN SOUTH AFRICA

MANPOWER MIRROR by ROBYN CHALMERS

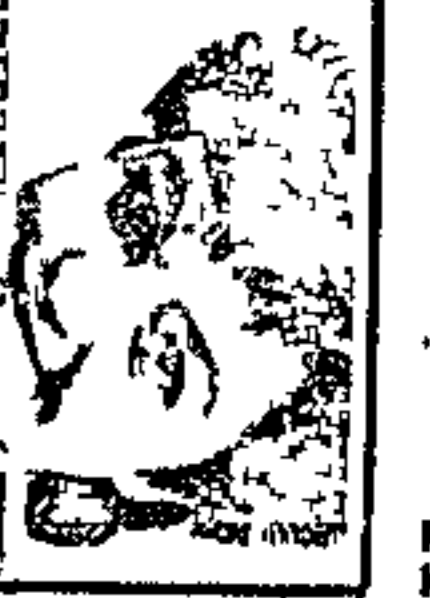

Bosses and Num dig in

THE Chamber of Mines has been lucky regarding wage negotiations because of news coverage highlighting the plight of struggling gold mines. Headlines such as '300 000 jobs on the line at 18 mines' and 'Gold price crisis threatens mines' are unlikely to plead the case of the National Union of Mineworkers (Num).

The sustained low price of gold has given the chamber ammunition in negotiations which are notoriously tough and require all the resources of two of South Africa's most hardened and experienced negotiators — the chamber's Johan Liebenberg and Num's Cyril Ramaphosa.

Num has placed full page advertisements in newspapers contending that the mining industry can pay a living wage. A graph similar to the one on the right accompanied the advertisements.

The advertisement says "Last year alone the gold mines made a total profit of R7 billion. The cost of the Num's wage demand for 1989 is only R1.3 billion. Our wage demand is for a national minimum wage of R600 per month for underground workers. For surface workers we want a minimum of R543 per month."

"The miners produce the wealth of South Africa. We do a dangerous job and deserve a living wage. The chamber calculates that Num's demands would mean a 118% increase in minimum wage. Mr. Liebenberg calls the demands irresponsible, and says they show that the union has not taken economic realities into account. He says wages for semi-skilled and unskilled workers have jumped by more than 500% in real terms since 1972.

Anglo American industrial relations consultant Bobby Godsell says these increases were absolutely necessary to do away with the wage differential but that the industry can no longer afford to grant such big pay rises. He maintains that the challenge now is to enhance the efficiency of the industry as a whole because SA must be competitive with the rest of the world if it is to stay alive.

The rationale behind Num's demands is a goal set by Mr. Ramaphosa to achieve a "living wage" in the industry by 1991. It is, however, difficult to determine what a living wage is because the figures given by various institutions which calculate it differ widely.

The University of SA's Bureau for Market Research says the supplemented living level for a family of five is R647.11 a month. If one takes this figure as the average living wage, then 88% of all black mineworkers earn less.

The chamber's minimum wages range from R278 for surface gold miners, and R260 and R278 for surface and underground coal miners.

The chamber's award of a 13.5% pay increase to the Council of Mining Unions last week is an indication of what it is willing to offer to Num.

For many years Num has been awarded higher percentage increases than CMU, which received a lift of 12% last year. Num got 13% to 16.5%, and the final agreement this year could be about that figure. The negotiations are likely to be

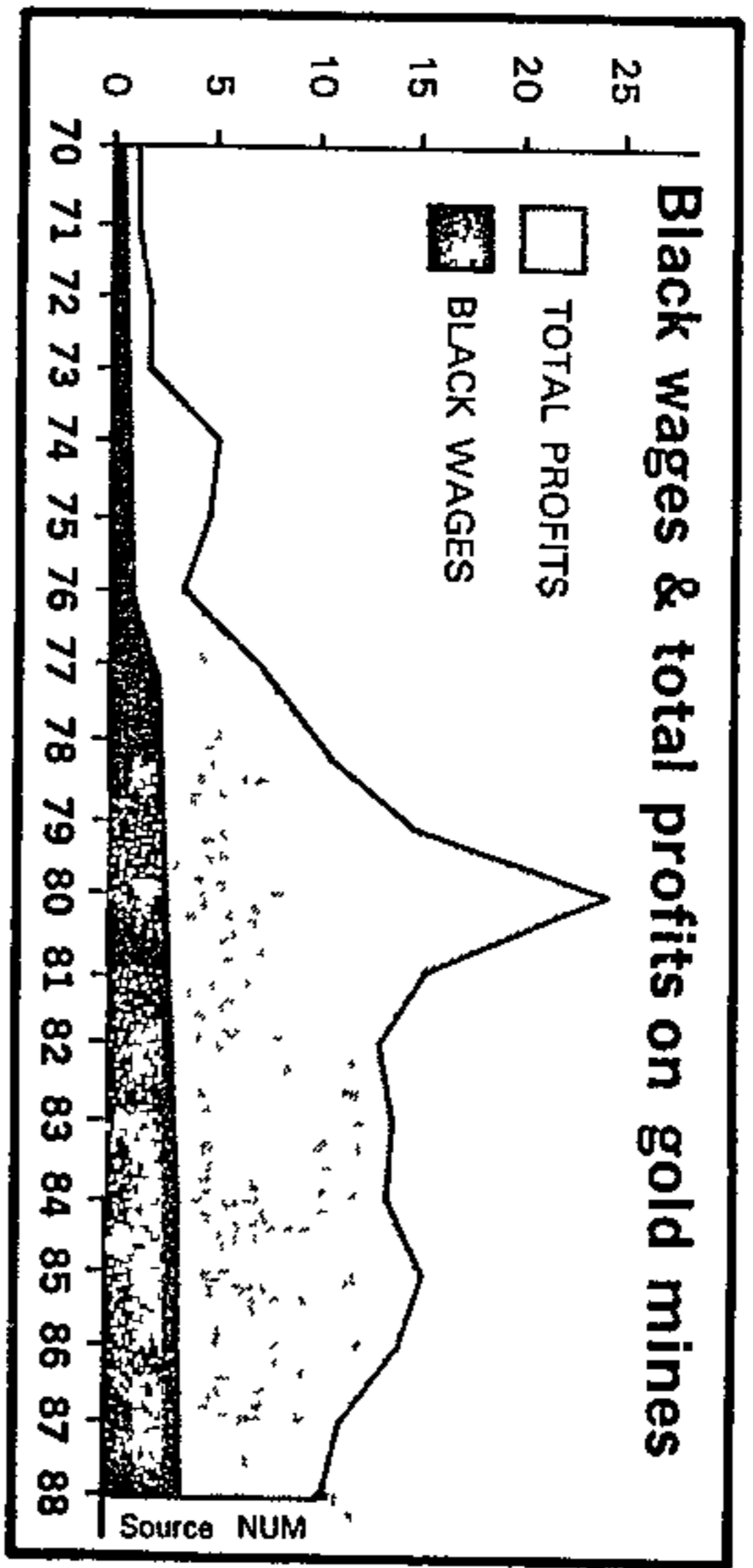

lengthy and difficult, possibly even going to dispute as happened in 1988. Num insists on wage increases in monetary, not percentage terms. Why Num is doing this is puzzling. Mr. Ramaphosa says members are poorly educated and do not understand percentages. But Num has an extremely bright economist working for it who could easily explain the facts and figures. On the one hand, SA has 18 marginal gold mines, employing 300 000 workers, a shaky gold price and accelerating working costs. On the other, workers have to contend with rocketing inflation. The negotiations are likely to prove as interesting and important as ever — the Num is armed with a strong mandate given at this year's annual congress, and the chamber will be watching its profits which are slowly being eroded.

Anglovaal, Ovaal, OMa a Spendings Spree

S/Times 11/6/89

210

CARTE BLANCHE



S/Times 11/6/89

At a lunch this week, I noticed that some eminent tablemates found it hard to contain their glee over "threatened civil war" in China and riots in Russia. I suppose this reaction from South Africans, who themselves have experienced riots and the threat of revolution in the past decade, is understandable — however tragic events in China and Russia have been in human terms.

Some may have felt good merely knowing that we are not the only ones finding reform exceedingly difficult. They might have hoped that there was a lesson in these experiences for a world expecting too much change too quickly.

Some were gleeful because they thought turmoil in these countries was evidence that communism was dying.

Others took comfort from communist discomfort on the not-unreasonable grounds that if the Reds were in turmoil, political and economic pressure on SA would be reduced.

Some worried that peace between the super-powers would lead ultimately to an imposed "democratic solution" of the SA question, much like the one being "foisted" on Namibia.

Events in China and in Russia would cause the West to take a much more cautious approach to apparent cordiality from behind the bamboo and iron curtains.

But the main reason for suppressed happiness was the possibility that trouble in the Far East would lift the gold price.

Gold bugs were banking on frightened investors in Hong Kong, Taiwan, Singapore, South Korea, not to mention mainland China itself, converting their money hoards

By David
Carte,
BUSINESS
TIMES
Editor

Naught for our comfort

appeared to be dumping Communism probability in its death throes, but this could be violent and ever so nasty for all of us.

The best outcome in Russia and in China for the whole world, including ourselves, is a peaceful one and a gradual move to a more democratic and capitalistic society. In that scenario, a fifth of the world would move gradually from Second World to First World living standards.

That would imply much more of a bonanza for us than a short-lived gold boom. As reliable suppliers of all sorts of commodities

By David Carte

ANGLOVAAL emerges as one of the most acquisitive companies in South Africa after the purchase this week by subsidiary Consol of Goodyear for R178-million.



BASIL HERSOV

The mining house, controlled by the families of chairman Basil Hersov and Clive Menell, and its subsidiaries have spent nearly R600-million on seven acquisitions and five minority takeouts in the past year.

The free-spending house is expected to announce the go-ahead for a R2-billion gold mine at Bothaville in the Free State soon. It may also have to contribute to De Beers' R300-million Venetia mine, in which it is a partner.

Cash

Nearly all Anglovaal's acquisitions have been for cash. At last balance sheet Anglovaal had debt of R956.3-million — but it had cash balances of more than R1-billion. It could thus have paid off all debt and had R52-million in the bank.

Anglovaal's aggressive spending has triggered speculation about a rights issue, but a complication is that the Hersov and Menell families have 51% of top company Avvaal. They would have to maintain outright control.

Jan Robbertze, head of Anglovaal Industries, stresses that subsidiaries follow their own strategic plans and arrange their funding.

There was no group master plan to build up cash of R1-billion and then to buy aggressively. Each acquisition

was made by the relevant subsidiary on its merits.

Mr Robbertze says: "One lays one's corporate plans over time. You can spend nothing for years, then several things in only a few months."

He says Consol needed to diversify out of packaging to maintain a strong growth record. With R55-million of cash in its balance sheet, Consol could afford Goodyear, but there could be additional financial arrangements.

Ideal

Goodyear is ideal for Consol. "It is medium weight in terms of capital intensity, like Consol."

"Consol's talents in technology transfer and in industrial relations will be valuable to Goodyear."

"Like Consol, Goodyear is not cyclical and prospects for the industry are bright. Tyres are consumable durables. They are used virtually regardless of economic conditions."

Consol managing director

Moratorium

Anglovaal Industries used the moratorium on transfer tax to take minorities out of South Atlantic and its subsidiaries, tea and coffee major TY Beckett, Globe Engineering, Steelmets and Avbak Food Holdings.

Beckett went into Avbak to form a giant food group, which dominates tea, coffee and biscuits — Bakers, Bau-mans and Pyotts.

This exercise cost R43-million cash plus 2.8-million AVI

● To Page 2

P.T.O.

Anglovaal

shares worth R131,6-million
— R174,6-million.

Siltek, AVI's electronics subsidiary, has bought Hewlett-Packard for an undisclosed sum and M&PD Electronics for R53,2-million.

Anglovaal Ltd on top of AVI holds the group mining interests. It has bought Lavino Chrome from Applied Industrial Minerals of the US for R78-million.

Anglovaal also bought 30% of North Sea & General, a UK company with interests in the North Sea, for R39-million. It bought 42% of AA Life Assurance for R32-million.

Anglovaal spent R40-million on prospecting its Oribi and Sun gold hopes near Bothaville. It is expected to spend as much in the second half. Analysts say the house

would not spend R80-million unless it was serious about starting. They estimate a mine will cost R2-billion.

But some wonder if Anglovaal's spending spree does not indicate that it has decided not to go ahead with a gold mine and to concentrate on energy and industry.

Anglovaal has not given any indication of the profitability of its latest acquisitions.

Rival tyre companies estimate that Goodyear makes between R23-million and R32-million after tax, in which case the price earnings multiple would be six to eight — a bargain for a high-tech market leader with more than 25% of the tyre market in SA. S/Times 4/6/87

Bad time for Haggie

Haggie's latest annual report is sending out a clear signal — the economy is beginning to hurt.

Consider that Haggie is owned 36 percent by Anglo-American (through Scaw Metals) and 36 percent by Gencor (through Malbank), the controlling monoliths of the mining industry, who are now adopting severe cost-cutting measures.

The mining industry is Haggie's main customer for wire rope and in 1988 the industry ordered less.

Then there's the sanctions issue. Some of SA's trading partners are curbing exports — a significant proportion of Haggie's products are exported.

Next problem is a militant labour force bent on wildcat strikes and lock-outs. In mid-1988, wage negotiations were deadlocked and a costly six-week lockout followed.

Despite these hurdles, turnover increased 10 percent, but volumes were marginally lower than in 1987, says chairman Grant Thomas.

Saved by a lower effective tax rate of 43,2 percent (1987: 46,5 percent), less tax was paid.

Capex of R56 million went to lifting debt 60 percent to R80,4 million (1987: R51,5 million). This means high interest expenses against a background of rising rates.

Price increases in steel supplies and the rising prices of copper and zinc strained margins, especially those of export products.

Haggie could be in for a tough time if mining continues to cut costs. Yet Mr Thomas is confident 1989 will be a year of real growth.

Sales rose 10 percent to R874,7 million (1987: R794,1 million), but operating income was almost unchanged at R116 million (1987: R114,9 million).

A R6,2 million provision for a possible drop in copper prices was charged against operating profits.

This was because subsidiary Macdem (Pty) carried some stock which was not hedged and as such was subject to windfall profits/losses arising from increases/decreases in the copper price.

Profits or losses arising from changes in the copper price relating to the unhedged stocks were not brought to account in Haggie's figures, hence the provision.

Net interest expense was R1,96 million (1987: R47,2 million). This difference alone meant that earnings for ordinary shareholders rose to R61,5 million (1987: R55,9 million).

If the effective tax rate had been unchanged, the results for both years would have been virtually the same, except for the reduction in sales volumes. Earnings per share were 319,7c (1987: 114c).



Haggie has three main divisions — steel-rod conversion, non-ferrous metals and light engineering.

Unfortunately, the sales and income contribution from each was not disclosed so that shareholders are unaware of what really helped in 1988.

The annual report features pictures of top management and plants, but offers little information.

In the US, annual reports feature detailed descriptions of operations, comparisons and an in-depth account of events.

In SA, however, annual reports don't give enough facts and figures and are often more optimistic than realistic.

Disposals included Jackson Metals for R16,1 million and Osborn Aluminium for R4,9 million. Both contributed only two percent of group pre-tax profits.

Acquisitions included the assets of Bradbury Rolled Metals for R6,1 million, the remaining 40 percent in the copper alloys business of Copalour for R20,3 million and 60 percent of James Neill for R5 million.

The balance sheet is sound, with ordinary shareholders' interest having risen to R324 million (1987: R286 million) at end-December 1988.

Debt has increased, primarily due to net acquisitions, redemption of R26,2 million in preference shares and high capex.

Management has opted to offset cash balances and short-term loans against total debt. By so doing, working capital seems to have improved to R231,2 million (1987: R191,4 million). In fact, it has declined to R195,6 million (1987: R14,88 million).

Net worth has increased to R16,84 per share (1988: R14,88), but this price is helped by high non-distributable reserves of R78 million (1987: R70,5 million).

The workforce numbers 8 175 (1987: 8 615). I believe Haggie will be hard-pressed to improve its bottom line in 1989.

Sales will rise through price increases, but improving volumes could remain difficult.

I hear Gencor is making a R1,5 billion rights issue. Given the extent to which Mr Thomas has increased debt, I am sure management will want to earmark some of the rights money to reduce outsider debt, especially the way interest rates are heading.

Star 12/6/89

KAY TURVEY

LARGE rights issues in Gencor and Premier, coupled with the privatisation of Iscor, are likely to increase institutional exposure to equities in a restructuring of portfolios made possible through the recent scrapping of prescribed assets.

This move is unlikely, however, to require the sale of government stock because institutional liquidity is high, about R30bn, and capital market immediate returns are favourable.

Liberty Asset Management executive director James Ingles said, al-

AlDca 12/6/89
Shift in the law could line up a lot of institutional spare cash for equities

though investment decisions would depend on individual views, there was now more flexibility.

Most institutions were still slightly under their equity targets, having taken a cautious view of the JSE since the market crash in October 1987, he added.

Prudential investment guidelines have been formulated but there was

still a lot of uncertainty. It was also unlikely there would be a significant shifting of assets until the final format became law, said Old Mutual portfolio manager Ardre Smit.

They were carefully looking at their liability structure, however, to ensure prudential exposure to assets. Southern Life executive director investments Jan Calitz said that to

switch from fixed interest securities to equities or property would not benefit portfolios in the short term, although longer term the freedom to invest in these inflation hedge investments would be good.

The expected immediate return on equities is 4.5%, and about 10% to 11% on property, whereas gilts give a return of 17%, although there is no capital appreciation.

Over the longer term equities tend to outperform gilts. In the past 10 years the return on a long bond has, on average, been 11% a year compared to 27.5% in equities.

Gencor to split shares after R1,47bn rights issue hits the market

GENCOR is to split its shares on the basis of 10 to one after holding the largest-ever rights issue, set to raise R1,47bn

The shares will be split as a result of demand for Gencor shares from smaller investors

This will occur after an additional 19,6-million new shares have been issued

Details of the rights issue, which will enable the group to participate in new ventures, were also announced by the grant morning house at the weekend

Gencor is to issue the 19,6-million new

shares to the holders of its ordinary shares, its preference shareholders, and holders of its debentures on the basis of 20 new ordinary shares for every 100 held

The shares will be offered at an attractive issue price of R75, which represents a 12% discount on Friday's trading price of R85.

This should ensure that Gencor's controlling shareholder, Federale Mynbou (Fedmyn), which is underwriting the issue, has an easy ride

KAY TURVEY

Gencor's executive chairman Derek Keys has said that the rights offer is not designed to raise funds for any specific project

In media statement Keys said "Gencor companies are involved in a number of projects which have exciting potential — to name a few, the stainless steel project with Highveld steel, the development of Oryx and Karree, Mossgas and the

Torbanite project — and we want to be in a financial position to give the go-ahead if and when the need arises"

He said the capital raised would make Gencor a much more powerful group, placing it in an excellent position to participate in opportunities which had good earnings potential for the group

Fedmyn, which holds a 54,5% stake in Gencor, is also to have a rights issue

Like Gencor, it plans to split its share capital 10-for-one after the issue

For every 100 ordinary or preference

shares held, shareholders will be offered 22 new Fedmyn ordinaries at a price of R65, reflecting a discount of almost 10% on Friday's ruling price of R72.

Fedmyn and its subsidiaries have indicated they will follow their rights in the Gencor offer and underwrite the balance. Sanlam also plans to follow its rights in the Fedmyn offer, taking up 51,4% of the shares offered

Sanlam's wholly-owned subsidiary, Sankorp, will underwrite the balance of Fedmyn's rights offer

Sanlam backs Gencor's rights issue to the hilt

By Derek Tommey

The Sanlam group has shown it has complete confidence in the continuing ability of Gencor's highly successful chairman, Derek Keys, to make investments grow.

The group says that through Federale Mynbou it is subscribing R804 million (54 percent) of Gencor's planned rights issue of R1,47 billion and that, in the most unlikely event of other shareholders not taking up their rights, it is prepared to underwrite the whole issue.

Both Gencor and Federale Mynbou are to split their shares on a 10-for-one basis

Gencor is one of the Big Five mining houses.

It operates more than a dozen gold mines and has extensive coal, base mineral and industrial interests. It recently acquired the South African interests of Mobil Oil

Gencor's rights issue has a number of unusual features. The first is its size. No South African company before has raised such a large sum of money at one time

Secondly, the money is not being raised for any particular project, though the cash will obviously help replenish resources after paying for Mobil

However, Mr Keys has explained: "Gencor companies are involved in a number of projects which have exciting potential the stainless steel project with Highveld Steel, the development of Oryx and Karee, Mossgas and the torbanite project. We want to be in a financial position to give the go-ahead if and when the need arises.

"With the R1,47 billion we're raising, Gencor will be that much more powerful a group and in an excellent position to participate in opportunities which have good earnings potential."

When Gencor's merchant bank, Senbank, announced the rights issue at the end of May it said the proceeds would be used primarily to finance Gencor's growth programmes and to enable it to accelerate the development of existing businesses

It said the Gencor group had been successful with a number of major projects and acquisitions. The money raised by the rights issue would enable it to maintain its growth momentum.

More succinct was the comment of a top stockbroker "If a man with Derek Keys's record wants money for new investments, Sanlam will be only too happy to give it to him"

And with Gencor reporting a 55 percent increase in earnings from R294 million to R456 million in the six

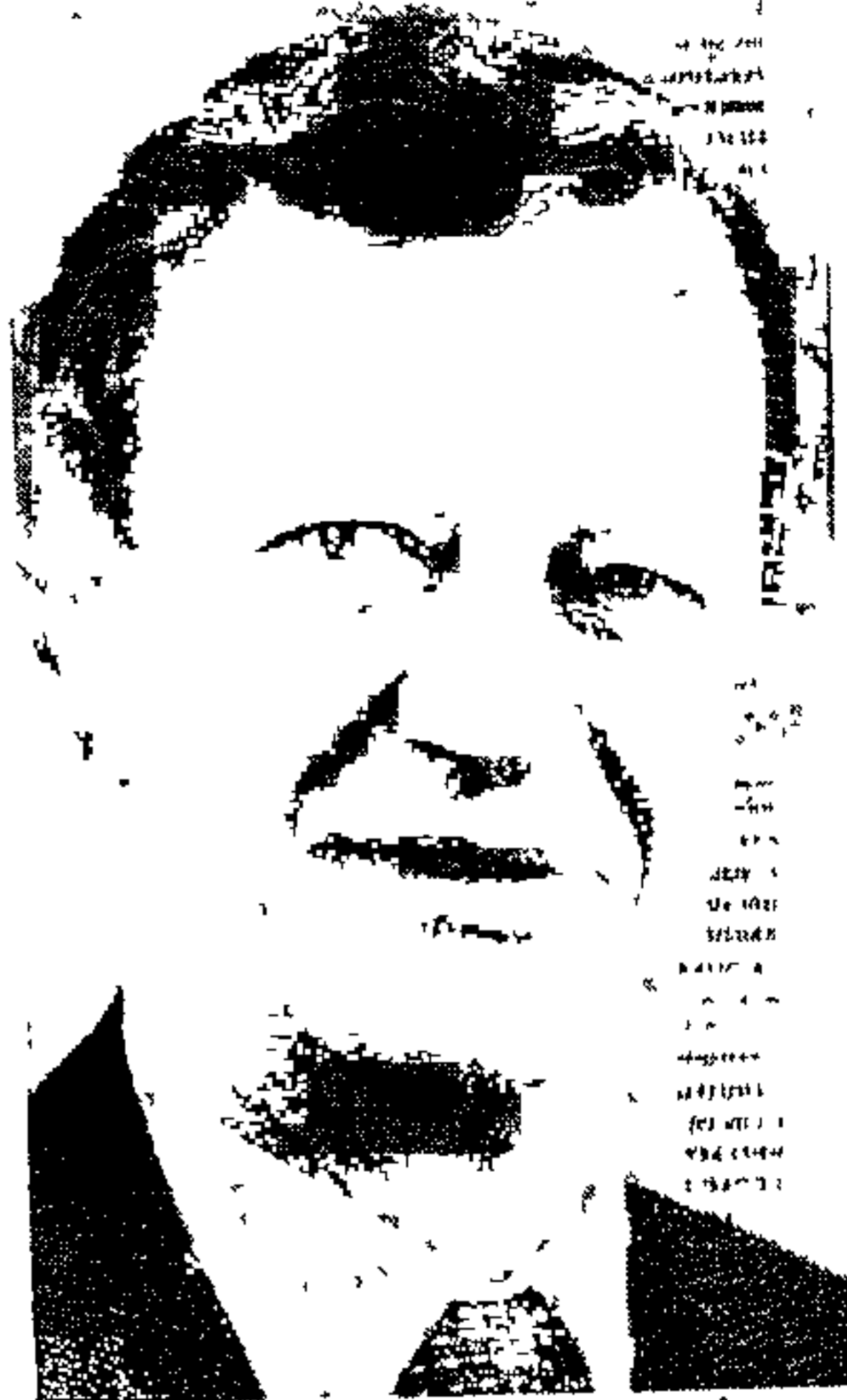

Derek Keys

months to February 1989, his comment seems apt.

The rights are being offered on what seems highly satisfactory terms. Gencor is offering 19,6 million shares on the basis of 20 for every 100 ordinary shares, or 100 compulsory convertible preference shares or every 100 convertible debentures held on June 23

The offer price is R75 a share, which is a discount of 12 percent on last Friday's closing price of R85.

Federale Mynbou, which has a controlling stake in Gencor, is raising R822 million in order to follow up its rights

It is offering 12,7 million shares in the ratio of 22 new shares for every 100 ordinary shares, convertible preference shares or convertible debentures held next Friday. This is a discount of about 10 percent to the R72 at which Federale Mynbou's shares closed on Friday.

Neither the new Gencor or Federale Mynbou shares will receive the final dividend for the year to August 31. Details of these final dividends will be announced this coming Friday.

As these could influence the outcome of the rights issue, Gencor and Federale Mynbou shareholders will be keenly waiting the announcements

It was just two months ago, at the end of April, that the two companies announced their interim dividends.

Gencor paid 120c and Federale Mynbou 108c.

In both cases the dividends were 20 percent higher than a year ago

SA 21/6/89

210

SA's mineral exports boosted by political turmoil in China

By Neil Behrmann

LONDON — The crisis in China is benefiting mineral exports of South Africa

Prices of antimony, manganese have risen sharply in the past fortnight, while South African coal is being routed to China via Hong Kong

Events in the nation could dampen efforts of the pro-sanctions lobby in the US Congress, say metals dealers. South Africa, the Soviet Union and China are key producers of strategic metals. Further sanctions against South Africa, could provoke counter moves in the form of reduced supplies of materials

Commodity traders worldwide are uncertain about the outcome of trade with China

Oil traders in particular are concerned

Sinochem, China's state import and export agency for oil products, temporarily closed its Beijing office and traded from a hotel, says Christopher Bellew a director of Czarnikow Energy

The Beijing head office is running on a skeleton staff and oil

trade into China has come to an abrupt halt

China currently exports 520 000 barrels a day of crude and Japan imports the bulk of this amount. Japanese companies have been closely monitoring events in China, says Weekly Petroleum Argus and they fear a nation wide strike. Meanwhile smaller independent oil traders in Singapore have stopped trading with China because they are worried that they will not be paid for supplies of oil products.

For other bulk commodities, trade with China is beginning to return to normality.

Trade and shipments of grain, fertilizers and iron ore are not being hampered by the cruel repression and crack down on dissidents, according to London ship brokers

"Yet markets in key strategic metals that are mainly produced in China, notably antimony, manganese, tungsten, titanium and arsenic are extremely nervous," says Oscar Prager, managing director of Ayrton & Partners, London metal merchants. During the past few years, re-

luctant metals consumers were persuaded that China was a reliable source of supply, says Mr Prager. But events of the past few weeks have damaged this good-will

There was such consternation, says Mr Prager, that merchants' metal stocks in Europe fell sharply as consumers increased their stocks to protect themselves from possible supply disruptions. Prices of antimony, a mineral used in batteries and titanium a key metal for jet engines jumped by more than 10 percent

Prices of all these speciality metals could rise further if Chinese supplies are threatened. South African manganese and vanadium producers and Consolidated Murchison, the antimony miner are in a strong position

China is the world's biggest producer of rice, wheat, cotton and coal. It is amongst the top ten producers of maize, aluminium, cement, crude oil, gold, iron and steel, manganese, tin, vanadium and a few other commodities. China cannot be regarded as

the major factor in the market of copper, aluminium, lead, nickel and zinc, says Jim Lennon, metal analyst at Shearson Lehman Hutton

"But given low levels of industry stocks and relatively tight markets, a small change in China's imports or exports could induce large swings in prices," he says

Other metals dealers, say however that there has been a considerable psychological impact on the market when China has entered the market in previous years. Copper in particular has fluctuated wildly on rumours of Chinese buying

Since China has tended to be an importer of most base metals, present unrest could reduce orders and be "mildly bearish," says Mr Lennon

But China is a notable tin producer and if there are any delays in Chinese exports, there could be a swift increase in tin prices

Rapid economic expansion and the needs of a billion people forced China to become a significant importer of raw material during the past few years

Prosperity depends on Government

By Mike Siluma
Labour Reporter

210

The actions of a National Party government re-elected after the September elections would determine South Africa's prosperity and the continued use of sanctions to fight apartheid, the outgoing president of the Chamber of Mines, Mr Colin Fenton, said in Johannesburg yesterday.

He told the chamber's annual meeting that many of the economic ills holding back South Africa's emergence as a first world nation stemmed from universal rejection of internal government policies.

"The best efforts of commerce and industry can constitute little more than a holding operation until an acceptable political dispensation is achieved," Mr Fenton said.

OPPORTUNITY

"At this stage there seems little doubt that Mr (F W) de Klerk and his party will be returned to power. How they use the opportunity presented is likely to determine our prosperity and the future of sanctions as an anti-apartheid strategy."

Mr Fenton said it was incongruous that unions such as the National Union of Mineworkers should support sanctions. "Yet the leadership of the NUM goes further (NUM) wage increase demands, from an industry it tries openly to cripple by sanctions, at a time when the profits of marginal mines are already squeezed by the depressed gold price, are pitched at some 118 percent."

Referring to the declining gold price, he said about half of the chamber's 33 gold mines could be threatened unless the price improved or other factors came into play.

Mr Fenton said all sectors of the mining industry showed a fall in fatality and injury rates last year.

Gencor 210

Fedmyn declare dividends early

To avoid confusion in the progression of their rights offers, both Gencor and Federale Mynbou have declared their final dividends early.

Gencor's final dividend for the year ending August 31 is 220c an ordinary share which together with the interim of 120c makes a total of 340c for the year.

Holders of Gencor's 8,5 percent variable prefs are to receive a final dividend of 225,25c per pref, also making 340c for the year and holders of Gencor's 12,5 percent unsecured debentures will earn a final payment of 171,25c.

The final dividend on the Fedmyn ords is 200c which with the 108c interim makes 308c a share.

Like the holders of Gencor's prefs and debentures, the holders of Fedmyn prefs and debentures will receive the same total payouts for the year as the holders of Fedmyn ords.

Gencor finance director Ton de Beer said "The new shares to be issued as part of our proposed R1 470 million rights issue will not rank for Gencor's final distribution as they will only have been in shareholders' hands for just over a month.

"However to avoid a ridiculous situation where Gencor and Fedmyn shares had two listings — one ex-div and one cum-div — we elected to announce the final dividends early and simply have one listing for each class of share — Sapa.

The week on the JSE

LYNNE PEACH 210

HIGHER than expected US inflation figures and international intervention halted the dollar's rise this week — and inspired a positive reaction from the bullion price *ster 24/16187*

But brokers say there is still no evidence of an imminent mass stampede into gold with institutions continuing to just nibble away.

However, there were some good gains in the gold sector over the week. Dries picked up 175c to reach 4050c, while Kloof advanced 35c to 3485c and Vaal Reefs was 10c higher at 30700c. Harties which paid a final dividend of 100c and went ex-div on Monday has, excluding the dividend, advanced 150c over the week to 2775 cents

One of Anglovaal's top gold producers, ET Cons, saw its share price rise from 6300c to a new yearly high of 7200c. This is on the back of its dividend for the year to June being increased to 415c.

Unauthorised strikes at many US coal mines had a positive impact on local coal shares. Trans Natal's price edged up 10c to 700c while Wit Colls gained 300c to 6300c.

The diamond sector remained firm with Anamunt advancing 500c to 81500c Friday, and De Beers rising 40c to 6350c.

Metals & Minerals companies Gefco and Msauli continued to go from strength to strength. Gefco's price appreciated by 85c to 365c, and Msauli's 25c to 825c.

In mining financials, the offer by Hanson Plc placed Consgold in the limelight. Its local share price leapt ahead 1050c to 9050c on the news.

Gencor has also remained firm, its price having risen from 8500c to 9200c. The market seems to be reacting favourably to the group's intention to split its shares after holding the largest rights issue yet to raise R1,47 billion for new ventures.

Another winner has been Fed Mynbou.

Its share price has advanced 1000c into new high territory at 8200c

Last weekend transport and motor group, Imperial, announced the formation of a fourth division — a finance, property and insurance division. The market did not repond favourably and its share price weakened from 680c to 675c.

Stockbrokers are expecting clothing manufacturer Trimtex to disclose earnings of 17c and a dividend of 7c, and are expecting news of a major deal. Trimtex is priced at 90c, having lost 5c during the week.

The JSE food sector continued to move ahead. ICG firmed to a yearly high of 1300c while Premier Group's share price increased 200c to 4900c on news of its restructuring.

New-comer Rainbow Chucken's share price advanced to 305c, compared with its closing price of 285c on June 15 when it was listed. CGS Food's price stagnated at 2700c as did Tiger Oats' at 19800c.

Speculation about Midas and Adco is rife. A stockbroker suggested that Midas may be buying Adco out, at a price in excess of 100c. Adco has moved up 5c this week to 90c while Midas's share price has risen by 25c to 1350c.

Inside
Out

ANNE
CROTTY



Ann Crotty who has been visiting her mum overseas, resumes her popular Inside Out column next Saturday.

Gefco the star of my portfolio

GEFCO is the star performer in the 1989 mining share portfolio I picked in January.

From only 105c the price of the asbestos producer has jumped by 235c or 224% to 340c as its prospects brightened after a management buyout from Gencor last August.

Much of its product is exported, and the decline of the rand against the dollar will help to boost rand receipts. However, the shares look fully priced.

MODERATE

De Beers did not let me down either — it is up by 58% from 4 240c to an all-time high of 6 700c.

Elandsrand did almost as well, rising by 56% to 2 650c. Parent Anglo American has also shone, climbing 44% to 9 250c.

Gold Fields Coal has picked up 31% to 850c, bringing the number of good performers to five. The other five have been moderate.

Lebowa Plats is up by 11% to 840c, Barnex up 8% to 430c, Anglovaal loan stock up

210 S/Tues 2/7/89.
16% to R36, and Middle Wits up 13% to R85. The only loser is Charter, 5c lighter at 3 475c. I still have hopes for it on the strength of its Minorco connections.

The mining portfolio has risen by nearly 30% in six months, and the JSE's mining production actuarial index has added about the same.

I also chose a general equity portfolio, of which W&A preferred ordinaries has been the feature. The 12% loan stock yields 6,8% on the current price of R62. It was R38 in January.

Unitrans has kept on trucking — up 80c or 36% to 300c after touching 340c in May. Waltons is up 25% at 560c, and Liberty is R30 stronger at R170. Amaprop, Riche-mont and Fedfood all climbed by between 14% and 18%.

But I have one unchanged in Curfin at 320c — although it hit 460c in January — and two losers in Lonrho, down

R5 at R18, and Bankorp, 40c easier at 380c.

The portfolio is 22% higher than in January — not as good as the JSE overall index, which is 32% up at 2 635.

Among the biggest climbers in the past 12 months have been Msauli, Gefco, Union Steel, Zaa-plaats, Bar-plats, Hiveld, Vansa options, Rooiberg, Marlin and Keeley — all non-gold mining and quarrying exporters.

HONOURS

Honours went to Omnia options, which added 467% to 170c on its parent's recovery outlook. Yorkcor, which proposes to split its shares, and Consol which recently did so, are the only other non-mining shares in the top batch.

Wooden spoons go to Ohio, down from 145c to 22c, Milly's two shares which both lost more than three-quarters of their value, and small mines Rogold, South Roodepoort, Sub Nigel and Cengold

Minerals Bill changes please mines ²¹⁰

ANDREW BUDDEN

THE SA mining industry has successfully pushed for significant changes to the new Draft Minerals Bill which was released pending promulgation in December.

Mines claimed that if enacted in its original form, the Bill would have significantly strengthened the position of surface rights holders — at the expense of existing mineral rights holders.

Several areas of dissention arose during preliminary negotiations. One was that the original Bill would not have protected existing mineral rights.

Two years after enactment of the Bill, existing mineral rights would have expired, and holders would have had to re-negotiate with surface rights holders to continue mining operations.

Mining sources last week said this area

had since been "addressed satisfactorily."

Mines also said the Bill would have removed the overwhelming power over surface use of a mining lease enjoyed by precious metal holders since 1976.

Before this, common law had supported mineral rights holders when it came to surface disturbance, saying that if the minerals under a property were sold, the new owner had the right to extract them, even if it meant disturbing the surface.

While farmers and agricultural authorities supported moves to protect their rights, mines raised objections. The final draft of the Bill is expected to be a compromise between the demands of these groups.

1 Day 3 1776

Report lobbies for substitutes

EC seeks to reduce use of SA minerals

BRUSSELS — The European Community wants to spread its network of minerals suppliers as wide as possible to avoid being dependent on SA, says EC internal market commissioner Martin Bangemann.

SA is a key supplier of minerals widely used in EC industries such as car-making, aeronautics and armaments

Sapa-Reuter reports Bangemann said in answer to a parliamentary question on mineral imports from SA made available yesterday: "The commission is aware of the community's high degree of dependence on external sources for its mineral supplies"

He said the commission believed the EC should seek alternative suppliers and substitute materials.

Neighbours

Several Frontline states could be developed as suppliers, the commission said. The Soviet Union and Australia also have rich mineral deposits.

The EC should also help SA's mineral-rich neighbours, such as Mozambique, reduce their dependence on SA railway systems and ports, Bangemann added.

In 1986, the last year for which full figures are available, SA supplied nearly 70% of the EC's vanadium, more than half its chromium and a third of its manganese and zirconium. All of these are used in steel production

It also supplied more than a fifth of the EC's platinum, used in catalytic converters to cut car-exhaust pollution

"Substitute products might, in the

medium term, entail higher costs. Substitutes for chromium are not available," Bangemann said.

As potential suppliers, Mozambique produced platinum, vanadium, zirconium, manganese and chromium. Angola had titanium and manganese. Zimbabwe had 11% of the world's known deposits of chromium, after SA's 83%

The Soviet Union had the second biggest known reserves of platinum, 17% after SA's 80%, and rich deposits of vanadium, manganese and some chromium. Australia had titanium, vanadium, zirconium and manganese

REINIE BOOYSEN reports a senior mining house executive said yesterday he was not aware Mozambique produced any platinum, vanadium, manganese or chromium

He said there was a long haul between talking about setting up a mining industry for these minerals in the Frontline states and actually doing so

"The bottom line is that European consumers have very little choice as far as most of these minerals are concerned. SA's mining industry is very well-established, and many of the minerals occur so abundantly here that we are a very competitive force in the markets."

The Star reported yesterday that Canada's steel industry would collapse if the Canadian government banned the importation of SA alloys. "If we lose their metals, we lose our steel industry," Dan Romanko, MD of the Canadian Steel Producers' Association was quoted as saying in response to criticism of sharp increases in Canadian imports from SA.

210

Blom ST 7189

MARGINAL GOLD MINES

Not safe yet

The violent plunge and immediate recovery in ERPM's price — it fell to 700c from the pre-suspension level of 1 475c before recovering to 1 250c — following the end to the share's suspension on the JSE indicates there are still investors prepared to take a chance on the troubled mine's recovery prospects

However, a look at the details of the survival plan negotiated by manager Rand Mines shows this share remains one for only the most ardent gold bugs. Investors lacking that kind of conviction should steer clear. The survival package merely gives ERPM some more breathing space, principally through the deferment of interest payments on its more than R300m debt burden.

Further, the help extended to ERPM — a particularly delicate case — ties in with government's stated policy of dealing with requests on an ad-hoc basis. No conclusions can be drawn about the official attitude to other marginal mines in trouble and there's no verdict yet on Durban Deep's request.

Interest payments, totalling about R35m a year at current rates, are to be capitalised and then paid out in three equal tranches during 1993/1994/1995. Existing loans from commercial banks will not be called up until 2002. Rand Mines is putting up another R20m in additional loans while the government is effectively putting in R18m a year to cover pumping costs but this assistance will be reviewed annually.

There is still plenty of scope for further derailment if production does not match forecasts or Rand Mines has the gold price wrong again. Chairman Clive Knobbs says that, provided the tonnage treated and recovery grades from the developing Far East Vertical Shaft (FEVS) are as predicted, the gold price averages about R33 500/kg for the next six months and grows steadily thereafter, then the latest financial arrangements will enable the mine to return to profitability in the next few years.

Rand Mines' latest forecast on the gold price is still at the top end of the scale of market views, which range down to about R32 500/kg. The current gold price is swinging around R33 000/kg but the continued growth scenario can be queried. It seems likely any recovery in the dollar gold price would be followed and possibly matched by a strengthening in the value of the rand against the dollar. That will restrict the increase in the rand gold price received by the mines.

With hindsight, ERPM should have closed down the older workings much sooner and concentrated on the FEVS. Money which should have been spent on FEVS was

instead used in keeping the old mine going. Knobbs says "Had we closed the old mine down we would have been well away by now on the FEVS. However, one of the main justifications for government in guaranteeing the original R220m loan was the provision of jobs. I don't think we would have got the money had we planned massive retrenchments."

Plans announced for Harmony bear out some of the comments made previously on the scope for cost-cutting within the industry (*Leaders*, June 30). Plans are to retrench 4 200 workers — 12,7% of the current



Rand Mines' Knobbs ... assuming gold will rise

strength of 33 000 — and slim down the management structure. Knobbs says this can be achieved without any drop in current throughput of about 9,6 Mt a year. The labour cuts are expected to save the mine R48m a year in operating costs.

Immediate query from analysts is why this action was not taken earlier. The mine has been under pressure for about 18 months and passed its final dividend last year. Knobbs says the mine started cutting back two years ago and has already reduced the labour force by about 2 000 workers over this period. However, the intention was to cut the numbers by natural attrition. He concedes labour strengths were probably too high but says this was a justifiable safety margin during commissioning of the No 4 shaft system.

Durban Deep shares are likely to remain suspended for another few weeks until the bid from Rand Mines Properties has been made and considered. The outlook for continued underground operations appears grim.

RMP will bid either to take over the company or acquire the bulk of its assets, which included freehold land holdings totalling 3 364 ha at the end of last year as well as a gold dump retreatment operation. Not all that land will be available for development. Some is covered by slimes dams, for example, but the mine owns ground along the Main Reef Road which would form valuable industrial sites, while the land extending south to Soweto could be used for black residential development.

Rand Mines has asked for an independent valuation of Durban Deep's assets which is essential given that it controls both companies. Knobbs declines to specify at this stage what Durban Deep would do with cash from RMP. Main options are to pay it out to shareholders after allowing for the costs of closing down the mine, or to retain it to fund continued operations in the event of a gold price recovery.

Brendan Ryan

SILTEK/M&PD

A bigger stake?

The day after a banquet this week to launch High Performance Systems — previously the SA subsidiary of Hewlett Packard, which Siltek acquired — Siltek, its electronics associate M&PD and holding company Grinaker, as well as cash shell Mooi River, all put out cautionary announcements.

It seems at this stage that Siltek is not on another takeover trail, but is consolidating its position. Market sources suggest that Siltek is keen to increase its stake in M&PD. M&PD's market capitalisation is now R177m. Should Siltek increase its stake to about 65%, as seems likely, this would cost it about R42m at the current price of R4. M&PD chairman Mike McGrath has about 35%, so it is possible the deal will involve sale of part of his holding (he would only need to sell 16% to give Siltek control) and an offer to minorities.

From Siltek's point of view the problem may be to find the finance. As it is now thought to have no borrowings, it would seem that bank finance would be readily available, but the policy is to attempt to maintain a net cash position. The HP purchase is thought to have used up the balance of Siltek's cash resources left after it bought its 41% holding in M&PD in February. It therefore seems likely that Grinaker has been included to help provide the finance needed for the deal.

Mooi River has around R80m cash and is apparently being warehoused by Volkskas Merchant Bank since the operational assets

Speculators promote tin share index to new heights

9/25 717184

210

Finance Staff

The tin share index was the most buoyant on the JSE in the first six months of this year (see graph), with an overall growth of more than 120 percent.

However, this steep rise did not reflect improved conditions in the tin market but heavy speculation in tin share Zaaipiaats that it would be a vehicle for the Zimco group.

This caused Zaaipiaats' shares to rise from 120c at the start of the year to over 800c in mid-May. Last Friday the share closed at 600c.

The 77,4 percent rise in the Steel index in the first half of the year was the result of booming export sales following the sustained rise in world steel production.

The rise in the Diamond share index was due mainly to the sharp rise in De Beers on growing world demand for diamonds, while the rise in the paper and packing

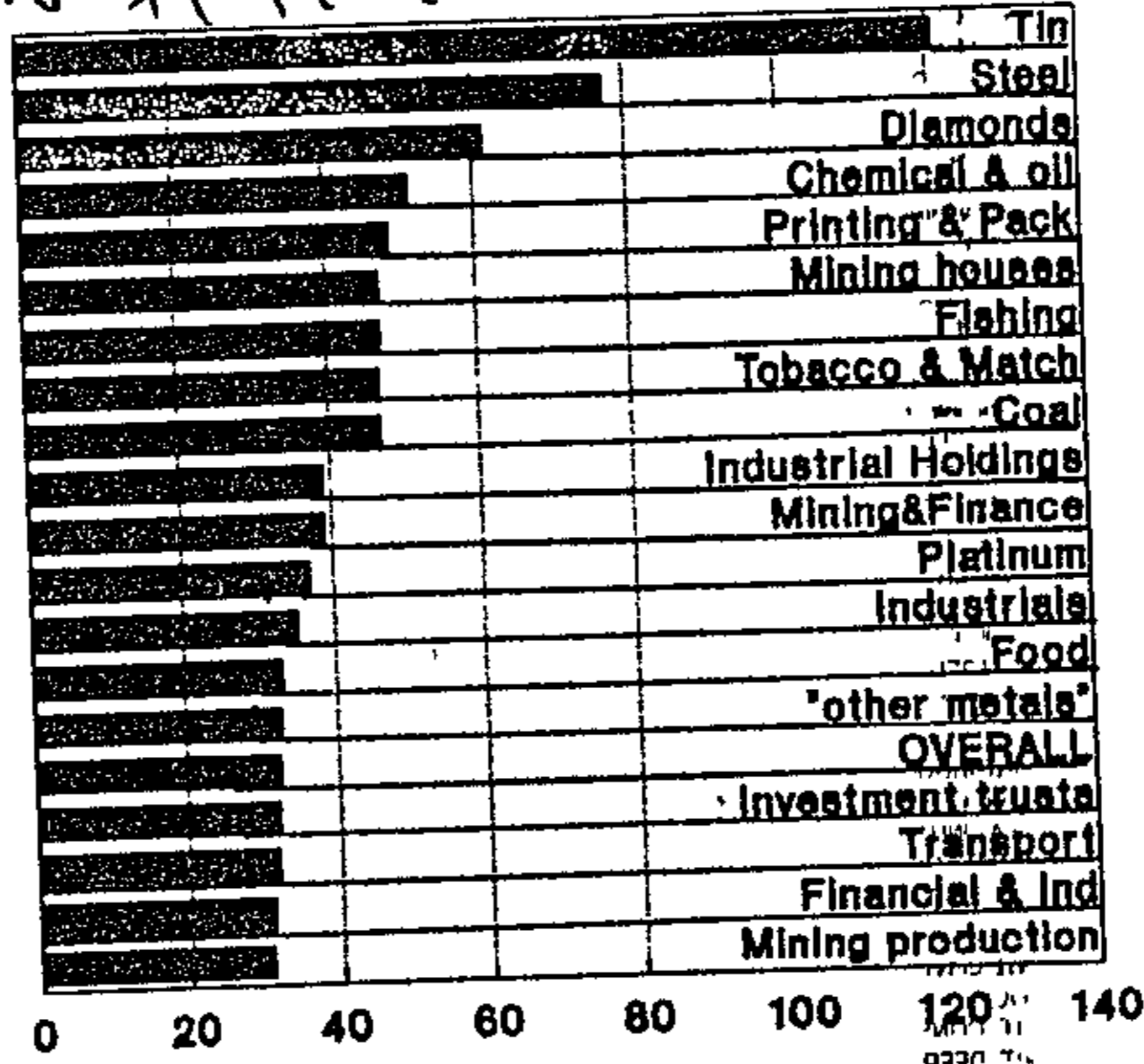

index was fuelled by the strength of Sappi and Consol.

The 47 percent rise in the Coal index was the result of booming export sales at higher prices. The Mining Finance index rose 39 percent, also as a result of the rise in Cons gold and Minorco shares.

The 35 percent increase in the Industrial

index reflected the strong rise in profits reported by many companies.

At the other end of the scale the Rand Mines sector showed a 6,6 percent loss, owing to mining profits being hit by the lower gold price and rising inflation.

The Banking index showed the smallest rise in the six months period of only 3,4 percent.

Mineworkers settle on wages as metal strike threat recedes

By EDDIE KOCH

INDUSTRIAL action in the mining sector has been averted as black miners ended their wage dispute this week, accepting employer offers of wage increases ranging from 13,4 percent to 21,5 percent.

A strike in the metal industry also seems unlikely as most unions have accepted an offer by the Steel and Engineering Industries Federation of South Africa (Seifsa) of increases of between 14 percent for labourers and 18 percent for artisans.

The increases for both sectors, which in the past have accounted for the biggest proportion of working hours lost during wage strikes, as well below the unions' initial demands but compare favourably with average increases won by organised workers in the first quarter of this year.

was based on different sets of increases at each of the major mining houses.

At Anglo American gold mines, wages will go up by between 18,4 percent for unskilled workers and 14,5 percent for skilled grades. The

corresponding figures for Gold Fields and Gencor respectively are 14,1 percent and 16,29 percent; and 13,9 percent and 21,1 percent. The National Union of Mineworkers (NUM) is not recognised at any JCI gold mines.

The increases raise minimum wages at Anglo mines to R399 for surface workers and R455 for underground workers. Minimum wages at Gold Fields and Gencor now stand at R323 (surface) and R357 (underground) and R356 (surface) and R420 (underground) respectively.

NUM's opening demand was for a minimum wage across the industry of R543 for surface workers and R600 for underground workers.

"Although the ultimate offers settled for were less than our bottom line we feel confident that within two years our demands will be realised," NUM said in a statement.

Figures compiled by the Institute for Industrial Relations indicate the average increase on minimum wages

won by unions in the first quarter of this year is 16,2 percent. Thus, although NUM's settlement represents a climbdown from its original demands, the organisation has managed to perform as well as most other unions — even though its bargaining power was seriously weakened by retrenchments and shaft closures at marginal mines.

Meanwhile the increase of 18 percent for labourers in the metal sector raises the industry's minimum wage to R3,56 an hour. The National Union of Metalworkers (Numsa), the biggest union in the metal sector, originally wanted increases ranging from 65 percent for labourers and 17 percent for artisans.

Although the final figures are also much lower than that called for, metalworkers will get a hike well above the mean minimum increases for industry as a whole in the first part of the year.

Final settlement in the metal sector has not, however, been achieved mainly because white workers belonging to unions affiliated to the Confederation of Mining and Building Unions are not prepared to accept an agreement that May Day be swapped for Workers' Day.

7-13/7/89.

Wwail

210

~~NUM~~ ~~NUM~~ ~~NUM~~

More join Anglo's esop

ANGLO American reports that 132 000, or 69%, of 192 000 eligible workers are now members of its group employee shareholder scheme (esop).

The directors say in the 1989 report that an important object of the scheme is the creation of a sense of stakeholding among all employees in the enterprise in which they are employed.

"Independent research conducted

during the year on the response of employee shareholders to the scheme has confirmed the strength of this sense of ownership.

"It has also provided evidence of a debate that is emerging regarding the mechanisms of the scheme and the activities of the companies in which employee shareholders work." Anglo's esop scheme was launched in November 1987 when the corporation allocated employees with a minimum of two years' service five shares each, paid for by the company.

Employees are required to keep

their shares in the Anglo Group Employee Shareholder Trust for at least four years, after which they are free to do with them as they please.

The scheme has been criticised by the National Union of Mineworkers (Num), primarily because it was not consulted. A repeat of this is being played by the National Union of Metalworkers (Numsa) over the Iscor esop.

Anglo is expected to issue 1.26-million shares to employees in the next five years — about 1.65% of equity. Num general secretary Cyril

Ramaphosa says the share offer gives no meaningful participation to workers.

When Anglo released its shareholder report towards the end of last year, it said about 64.4% of eligible employees had taken up the offer. Since then another 32 000 workers have taken the free shares.

Esops will continue to be a controversial issue for unions until companies negotiate the schemes with them. It will be interesting to see how many Anglo employees retain their shares after the four years are up.



210

MidWits to split shares 25 for one

Business Day Reporter

ANGLOVAAL'S mining investment, finance and exploration subsidiary Middle Witwatersrand (Western Areas) is to split its shares on a 25-for-one basis and to raise R50m through a cumulative preference share issue

The company's 9 673 436 ordinary 25c shares are to be sub-divided into 25 ordinaries of 1c each. The share-split should reduce the JSE share price from the current 8 900c to about 356c.

A statement by the company said this would improve the shares' marketability, and put them within reach of the smaller investor.

The effective date of the sub-division will be announced later.

Meanwhile, the company is to raise R50m through the issue of cumulative preference shares to a subsidiary of Ned-perm Bank.

Cost

210

The statement said the reason for the move was to ease MidWits's gearing, which has deteriorated since the company's 49% participation in two recent acquisitions by Anglovaal.

The first of these was the entire equity of chrome-mining company Lavino (SA) for R77,7m from its US-based parent; and the second was 29,9% of North Sea and General's ordinary equity for £13m, and £2,5m of NS & G's convertible unsecured loan stock at par, as well as a further £1m unsecured loan stock at a little over par.

The cost to MidWits of both transactions, would have been about R73m, depending on exchange rates.

NS & G is a UK-based natural resource company, with principal interests in industrial mineral deposits in the UK, as well as an open-cast Australian gold mine.

Since the beginning of the year, MidWits's ordinary shares have reached a high on the JSE of 9 200c, while their lowest price during this period was 6 950c.

EMPLOYMENT

THE TERMS AND CONDITIONS OF

Mid Wits ²¹⁰

announces

share split

Finance Staff

Anglovaal mining subsidiary Middle Witwatersrand (Western Areas) plans to split its shares on a 25-for-1 basis and also raise R50 million by way of a variable rate redeemable cumulative preference share issue.

Currently, the shares are trading at around R89 each and sub-division would lead to a price of about 356c a share, thereby putting the shares within reach of the smaller investor. The effective date of this sub-division will be announced later.

The R50 million raised from the preference share issue will be used to augment Mid Wits' general funding position.

Anglovaal says the reason for this is that the company's high liquidity, which has been a feature of its balance sheet over the last few years (at June 30, 1988, it had net current assets of R59,1 million), has been affected by Mid Wits' 49 percent participation in two recent acquisitions made by Anglovaal.

Guardbank makes a Gencor killing

SAGE bought Gencor shares, but wise Guardbank sold them even though both unit trust funds like the mining giant

The reason — Guardbank probably got more than R90 a share, but retained enough of the shares in its two equity portfolios to allow it to replace those sold at R75 in the rights offer and made a capital profit to boot

By Julie Walker

Guardbank Growth had a quiet June quarter, buying 20 000 Liberty Holdings and a bit of Government stock. It eased positions in chemical companies Sasol and AECL, and sold out of Safcor as the share price rose.

Its resources fund bought granite company Marlin, Amcoal and Winkelhaak golds and sold out of Rand-

fontein and Rand Leases

Guardbank says that although the short-term outlook is uncertain, it is confident that in the medium and long term, blue chips will move higher.

Sage bought De Beers, Samancor, JCI, Fedvolks, Walhold and Tongaat. It sold some Vaal Reefs and FIT. It noted sustained demand for equities.

UAL's older funds were

idle. The general fund bought 50 000 Amic and Mining & Resources picked up Northam, ET Cons and Palabora. It sold Barnex.

But Selected Opportunities went on a buying spree, adding Crulife, T&N Holdings, Rainbow, Combined Motors, Kohler, Sunpac, Untrans and Middle Wits.

UAL fund managers expect "a more modest level of corporate earnings and dividend growth that interest rates are approaching a cyclical peak and that the dollar gold price is consolidating."

Well done to Metfund for bringing the little-traded Cadswep into its top five. Cadswep jumped on a takeover bid for the British parent company.

Metfund added to current holdings and bought Driefontein, Trimtex, Bid Corporation and NEI Africa as well as four property trusts.

Its cash portion was reduced from 17,2% to 12,5%, whereas that of Southern Equity increased from 13,7% to 19,6% even though Southern says the medium-term outlook remains good.

Value

Southern believes gold shares offer value, and it put its money where its mouth is in Western Deep and Amgold. The mining fund added Driefontein and Gold Fields of SA. Both sold Doornfontein, and Barplats was also disposed of.

Standard remained cautious, and will try to preserve capital and maximise income. It believes there will not be much more downward pressure on gold at \$375, nor will it advance above \$400.

The Mutual fund portfolio managers did not trouble themselves this quarter, and the Gold fund made trifling changes.

More than R106-million of new money flowed into unit trusts in the quarter, both sales and repurchases growing.

Assets in the 31 trusts are R5,6-billion — 51% up on a year ago, and there are 537 000 unitholders.

US wary of 'unreliable' producers

SA may face R3-bn minerals forex loss

By David Braun,
The Star Bureau

WASHINGTON — The US Congress is taking steps to drastically reduce America's reliance on strategic minerals from South Africa and the Soviet Union over the next three years.

If successful, it would cost Pretoria nearly R3 billion a year in foreign exchange.

There are major implications for southern African countries as well, as Congress is seeking to reduce its reliance not only on South Africa but also on neighbouring states such as Botswana, Swaziland, Zimbabwe, Lesotho and Namibia which rely on South Africa's transport infrastructure to export their minerals.

Even congressmen who are normally opposed to sanctions legislation are supporting the measure, on the basis that the US cannot afford to continue de-

pending on potentially unreliable sources for strategic minerals.

The minerals targeted by Congress are chromite ore (chromium and ferrochromium), manganese ore (including ferromanganese), platinum group metals (including platinum, palladium, iridium, osmium, rhodium and ruthenium), vanadium ore (including ferrovandium and vanadium pentoxide), and cobalt metal and oxide.

Technologies

According to statistics supplied by the US Department of Commerce, the US bought minerals from this group to the value of about \$1 billion (R2,8 billion) from South Africa last year. In the first three months of this year, the US imported these strategic minerals at a total value of \$227 million (R636 million) from SA.

Congress plans to instruct the

US Secretary of the Interior to establish a mining experimental programme on critical minerals in terms of a Bill introduced in the House of Representatives last week.

The purpose of the programme is, within three years, to develop mining, mineral-processing and such other technologies as will be capable of substantially reducing US dependence on critical minerals produced in South Africa and the Soviet Union.

A specific clause in the Bill says: "The term 'produced in the Republic of South Africa' means those critical minerals produced in the territorial boundaries of South Africa and exported to the United States, and those critical minerals produced in sovereign nations adjacent to the Republic of South Africa but which can only be exported to the United States through the Republic of South Africa."

Star 17/7/89.

210

US wary of 'unreliable' producers

SA may face R3-bn minerals forex loss

By David Braun,
The Star Bureau

WASHINGTON — The US Congress is taking steps to drastically reduce America's reliance on strategic minerals from South Africa and the Soviet Union over the next three years

If successful, it would cost Pretoria nearly R3 billion a year in foreign exchange

There are major implications for southern African countries as well, as Congress is seeking to reduce its reliance not only on South Africa but also on neighbouring states such as Botswana, Swaziland, Zimbabwe, Lesotho and Namibia which rely on South Africa's transport infrastructure to export their minerals

Even congressmen who are normally opposed to sanctions legislation are supporting the measure, on the basis that the US cannot afford to continue de-

pending on potentially unreliable sources for strategic minerals

The minerals targeted by Congress are chromite ore (chromium and ferrochromium), manganese ore (including ferromanganese), platinum group metals (including platinum, palladium, iridium, osmium, rhodium and ruthenium), vanadium ore (including ferrovandium and vanadium pentoxide), and cobalt metal and oxide

Technologies

According to statistics supplied by the US Department of Commerce, the US bought minerals from this group to the value of about \$1 billion (R2,8 billion) from South Africa last year. In the first three months of this year, the US imported these strategic minerals at a total value of \$227 million (R636 million) from SA

Congress plans to instruct the

US Secretary of the Interior to establish a mining experimental programme on critical minerals in terms of a Bill introduced in the House of Representatives last week

The purpose of the programme is, within three years, to develop mining, mineral-processing and such other technologies as will be capable of substantially reducing US dependence on critical minerals produced in South Africa and the Soviet Union

A specific clause in the Bill says "The term 'produced in the Republic of South Africa' means those critical minerals produced in the territorial boundaries of South Africa and exported to the United States, and those critical minerals produced in sovereign nations adjacent to the Republic of South Africa but which can only be exported to the United States through the Republic of South Africa"

Anglo set to spend R8 bn over 4 years



GAVIN RELLY

Finance Staff

Anglo American is set to invest R8 billion over the next four years in Southern Africa, says chairman Gavin Relly in his annual review

Anglo has already earmarked R2,5 billion for planned and projected capital expenditure by the corporation's gold, coal and industrial interests this year, he says

An additional R200 million is going towards prospecting new gold mining areas in South Africa

A large chunk of the remaining R5,7 billion will be used to develop new technology to make mining of the mostly deep and costly new ventures less expensive

Anglo American, Mr Relly says, is also pursuing a vast range of other investment programmes in Southern Africa

● Several new mining ventures in the non-precious metals field are expected to be announced in the next 18 months

● Mondi Paper has just announced a R110 million greenfields timber project in the Eastern Cape and is planning a second pulp line at Richards Bay

● Highveld Steel, with Samancor, is examining a project to produce stainless steel for export.

Anglo is also keen to help develop Mozambique and might resume responsibility for part of the cashew nut industry, which became a state activity after independence

In a more stable security climate opportunities would exist for forestry, mineral and agricultural development and the exploitation of natural gas

Commenting on new rules in Zimbabwe governing private investment — minimal since the country became independent nine years ago — Mr Relly says that while clearer definition is needed in some areas, they reflect the government's firm intent to facilitate and encourage private investment

Anglo's associates in Zimbabwe, he says, have been enjoying more prosperous times thanks to higher international commodity prices. Chrome, nickel and sugar operations

have benefited.

Investments in Zambia have done well in local currency terms, but the chronic shortage of foreign exchange has limited dividend remittances, he says

While favourable copper prices have enabled Zambia Consolidated Copper Mines to declare its first dividend in eight years, payment to shareholders have not yet been cleared

In Botswana, Mr Relly says, favourable prices and record production enabled Selebe-Pikwe copper/nickel mine to reduce its debt, the burden of which continues to preclude dividend payments

The R900 million soda ash venture at Sua Pan, near Francistown, in which Anglo American is participating with AECI and the Botswana government, will meet Southern

Africa's soda ash and salt needs, thus saving substantial foreign exchange, he says

New equity investments in Namibia during the 1988-89 financial year included funding for the developing gold mine at Navachab

Despite its commitment to the Southern African region, Mr Relly says Anglo's policy of building up its overseas interests within its own relatively limited foreign resources, and based on its technical and financial skills, will continue both directly and in support of Minorco

Although Hanson's acquisition of Minorco's stake in Consgold will not promote Minorco's plan to become directly involved in natural resources management on an international scale, it will enable the company to take advantage of new investment opportunities

Cost reduction scheme pays off . . .

CMH TIMES 20/7/89

Sharp rise in Gencor mines' profits

JOHANNESBURG — The benefits of the steps taken by Gencor 12 months ago to reduce costs were reflected in the June quarterly results, in which the slightly lower tonnage milled was compensated for by the higher average yield and lower working costs, resulting in substantially higher after-tax profits

Total tonnage milled dropped to 4,40m tons (4,45m), but the average higher yield of 4,8 g/t (4,7 g/t), combined with the lower average working costs of R23 500/kg (R23 826/kg), pushed total after-tax profits sharply up to R169,3m (R96,5m)

Total capex was increased to R64,8m from the previous R37,8m

Average milling rate at 367 000 tons (371 000 tons) recorded a drop of 1,1%, but average yield was 2% up on the previous quarter, while average working costs per kg were reduced by 1,4%. Average capex for the mines was 71,4% higher at R5,9m (R3,4m)

Stilfontein's higher gold production of 1 225 kg (1 111 kg) as well as the R24m dividend received from Chemwes, were largely responsible for the sharp increase in the mine's after-tax profit of R27,6m (R3m)

Bracken recorded overall improved results and lower costs and higher gold production of 555 kg (544 kg) as well as an improved yield, increased after-tax profit to R1,5m (R459 000). The planned scale-down has reduced production to 54 000 tons a month at a marginally increased grade

West Rand Cons' reduced operating loss and restored overall profitability. The mine recorded an after-tax profit of R770 000 against a previous loss of R4,3m

Kinross recorded a largely constant quarter with a marginally lower milling rate, unchanged yield of 5,7 g/t and virtually unchanged gold production of 3 001 kg (3 000 kg). With well maintained costs, the mine posted slightly higher after-tax of R20,9m (R19,8m)

Chemwes after-tax profit was R2,9m against the previous loss of R93 000. The company declared a R30m dividend

Buffelsfontein contained costs and increased gold production to 3 664 kg (3 521 kg). This combined with lower costs and constant grade as well as a higher contribution from Beatrix, increased after-tax profit to R20,7m (R15,3m)

Unisel benefited from a higher gold price, higher milling rate and slightly improved yield, but an increased tax bill of R8,9m (R3,8m) resulted in marginally lower after-tax profits of R12,3m against the previous R12,9m.

Winkelhaak which started trial stopping at No 6 Shaft posted a higher after-tax profit of R28,5m (R21,4m)

Grootvlei improved average underground grade mined and is focusing on more profitable areas. The mine's after-tax profit increased to R561 000 (R167 000)

Beatrix recorded an overall good performance maintaining a constant milling rate, and yield as well as containing costs. These factors combined with a tax saving of R21m, sharply increased net profit to R43,4m (R18,2m)

Leslie's higher yield and higher gold production combined with lower working costs, pushed the after-tax profit up to R3,9m (R1,1m)

St Helena returned a steady performance and a programme to increase productivity has been introduced. Grade was steady at 5 g/t, while gold production was little changed at 2 650 kg, as was after-tax profit at R8,9m (R8,5m)

Marievale's yield and profit deteriorated resulting in a sharp drop in income before tax to R172 000 (R1,1m)

Oryx's shaft sinking exceeded expectations and the mine's after-tax profit was slightly up at R777 000 (R707 000) — Sapa

210

Funds raised on JSE down on last year

B/Dca

21/7/89 NEIL YORKE SMITH

THE amount of funds raised on the JSE in the six months to June 1989 was substantially down on last year's figure.

Figures issued by the JSE showed nine rights issues worth R229m took place in the six months to June this year. This compared with 16 rights issues which raised more than R575m in the period to June 1988.

The number of new listings fell to eight (14), representing market value of R279m (R287m). New companies listed via rights issues raised R118m this year as opposed to over R236m in 1988.

JSE president Tony Norton said the 1988 figures reflected a large degree of carry-over from the 1987 listings boom. Having decided to list, many companies were committed to going through with it, in spite of the depressed market.

The lower figures reflected poor market sentiment as well as a depressed gold price, said Norton.

However, he noted the growing number of backdoor listings taking place. The benefit of a backdoor listing was the company involved did not expose itself to an issue price, thereby avoiding weak market reception.

Gencor's rights issue and the Iscor listing would substantially improve the figures for the next six months, said Norton.

He expressed confidence in the market. He said a stronger gold price would significantly boost JSE confidence which would have a corresponding effect on the number of companies raising capital via the JSE.

210

Final 21/7/89

KEN MAXWELL

Underground change

New president of the Chamber of Mines Ken Maxwell brings an air of quiet dignity to the office

It's not his intention, he insists, to revolutionise the organisation. It's already in the process of being restructured to more accurately serve the needs of its mining house constituents.

Hence, any changes he introduces are likely to be more in emphasis than in substance.

That said, he has some general objectives which he would like to see implemented during his tenure.

A serious and reflective man, he has already put issues like improving communications between the mining houses and the parties it interacts with — from the trade unions to government and overseas contacts — and focusing on productivity, at the top of his list.

Maxwell talks sincerely and unpatronisingly of the mining industry's need for "participative management," for effective communication and "building bridges" in the widest sense. "The need for communication is one of my hobby horses," he says. "It helps build trust and greater understanding."

Wage negotiations between the chamber and the National Union of Mine Workers

ended amicably — for the second year running. It's something that Maxwell draws comfort from, though he adds both parties are at times still "frustrated by the differences in philosophical approach that emerge."

The subject of productivity is not introduced to the conversation lightly. From being one of the world's low-cost gold producers, SA has had the misfortune of being elevated into the high-cost league through a combination of the need for deeper mining and a decline in the average gold grades from around 7 gm/t in 1982 to closer to 5,2 gm/t in 1988.

This is a subject close to Maxwell's heart. He is an executive director of JCI and head of its Gold and Uranium division. "We simply have to keep costs down," he says. "We can't allow inflation in our working costs to continue as they are. That implies the need for greater productivity. It also calls for government to help curtail inflation."

It's ironic, but as a young man Maxwell swore he would never work on a mine. "At that stage engineering on the mines was extremely fundamental. Other opportunities were far more exciting."

But, as his BSc mechanical engineering



Ken Maxwell

degree at Wits was being sponsored by Anglo, he was obliged to spend his university vacations on the mines. He subsequently won a Rhodes Scholarship to Oxford where he obtained an MA, economics, politics and philosophy. He later went on to complete a management development programme at Harvard Business School.

Maxwell spent 20 years in the platinum industry, rising

from personal assistant to the chairman of Rustenburg Platinum, to marketing director and finally MD. He was appointed an executive director of JCI in 1982 and chairman of the Gold Division in 1986.

Married with two sons and a daughter, he reads philosophy, when time permits, jogs and participates in holiday water sports.

Like many concerned South Africans, he remains interested in a wide range of community affairs. He's a member of the Consultative Business Movement and sits on the council of one school and the board of trustees of another.

"In business," he says, "we have a responsibility to see if we can promote social and business development, in all spheres, to help unleash the various potentials that make up the mosaic of SA's people."

Start

24/7/88

inside
Out
ANN 210
CROTTY



Institutions chasing golds

GOLDS and mining financials stole the limelight again this week although the gold price was looking a little dodgy. Some people think the dollar may come down and that this would help gold. Just about the same number of people think it won't come down and gold is stuffed.

But it seems the institutions — who continue to boost their coffers with enormous quantities of lolly — reckon they may currently be a little under-exposed to the gold market. The major beneficiaries of this sentiment include Gencor, Anglo, Dries, Western Deep and Minorco.

Myles reckons this state of affairs is expected to continue for the next week or two, which means that the industrial board may be neglected. But as ever, keen to avoid being accused of holding a firm opinion, Myles adds that everything could of course change by Monday.

His mum had a vision the other night — she saw gold bottoming at \$355. Myles reckons this is as scientific a basis as any for an investment decision. But his Mum is a bit put out. Being a reasonably devout RC she puts a lot of store on apparitions and visions and what-have-you but reckons getting a glimpse of the gold price is decidedly infra-dig.

There seems to be a lot of take-over talk about a lot of companies in which the Krok brothers have a reasonably sized stake. There's Fleishman's — where talk is that Spareco is going to take control; it's not yet known whose shares they will be acquiring but the Krok brothers have 30 percent.

There's Lucem — where Ozz is speculated to be planning to buy out the minorities, chief of whom are the Kroks. And then a while ago talk about something going on at Furntech — in which the Kroks also have a stake.

But the Kroks are also involved in Twins with the Premier Group and there hasn't been any talk on that front — yet. Although, as Myles points out, there is a major reorganisation of Premier's interests currently on the go. He reckons that there could be plans for the Premier/Krok consortium to buy out the Twins' minorities — of which there are very few.

The FSI guys were very quick off the mark with Edworks — one of the benefits of having a very bright, keen and energetic management team.

Buying the shares should give them the edge over the other parties interested in the Edworks' assets. No indication as to whether Edworks will be redesigned to fit into the FSI structure or whether it will be maintained as a going concern.

What also seems uncertain at this stage is whether the assessed tax loss automatically falls to FSI. It must certainly be an attractive part of the deal.

Details of the Hunts/Natbolts/FS-Team deal are expected next week.

In the midst of all this action it seems a bit miserable to wonder when the FSI shareholders can expect to see the 1988 annual report.

Talk of a deal involving BTR-Dunlop. Myles' reckons that if there was to be a sale to a local party it's likely to be AVI rather than FSI because of size.

Kersaf has been strong recently, apparently on the back of expectations of good results. Myles heard a few whispers about Sol Kerzner and President Mangope wanting to lift their holding in Sun Bop through the acquisition of some of Kersaf's stake. But Kersaf's Ian Heron denies that there had been any discussions on this front.

210

S/Times 23/7/89

Back on the list

By Julie Walker

of the Kleinfontein and Protea dumps They are being treated in conjunction with

SA Lands Waverley and Simmer & Jack were sold before the consortium took control

TRADE in Johannesburg Mining & Finance's five listed companies will resume tomorrow after the rescue of Joe Berardo's abandoned empire by a consortium.

The rescuers are Norman Lowenthal, Gerald Rubenstein, David Abbott, Charles Turner of DMB and Monty Shechter on his own and others' behalf

The consortium bought 60-million shares, or 52%, of JMFC by the injection of R11-million of compulsorily convertible debentures

Also, R13-million of the banks' claims will be converted to debentures This means the JMFC has been recapitalised to the tune of R24-million A reduced interest rate of 6% will be payable on the remainder of the banks' claims of R5,8-million for two years, rising to 10% until repayment over five years

Companies in the JMFC group incurred extraordinary losses totalling R244-million in the year to March 1989

Of this, R193-million relates to mining assets, and the balance non-mining, which have been written down to approximate realisable values

The 72-company group structure has been simplified JMFC will own 64% of Corex and 53% of Egoli Egoli will still own 10% of JMFC

Egoli will have 59% of Carrijs, 60% of West Wits and all

Anglo weighs up rare minerals ⁽²¹⁰⁾

Staw 2417187

The new mining business division of Anglo American is studying the feasibility of producing titanium- and zirconium-rich heavy minerals from sand deposits adjacent to the western Cape coast in Namaqualand.

The deposits are located 50 km north of the Olifants River and are situated from one to 15 km inland.

Most of the deposits are located on farms owned by De Beers. The feasibility study is due for completion in mid-1990.

Annual production targets planned to begin in early 1992 are 100 000 tons of zircon, 25 000 tons of rutile and 1 000 tons of monazite.

Technical investigations related to the local upgrading of the titanium mineral, ilmenite, are also underway.

Wet concentration plant

At present a wet concentration pilot plant is being operated near the proposed mine site. The deposits, although broadly similar to the world's largest in Western Australia, present a variety of technical and infrastructural problems, the detailed solutions of which are being investigated, says Anglo American.

Effects of the proposed mining on the local environment are the subject of ongoing study and experimentation in conjunction with the relevant state and private institutions, Anglo says. — Sapa.



ALISTER COLQUHOUN

How ups &

THE concept of selling short is simple, yet many investors fail to understand how it is possible to sell something they do not own. The SA Futures Industries

UAL units on low throttle

ALISTER Colquhoun, executive director for UAL unit trusts' portfolio management, takes exception to my labeling his general equity fund idle in the June quarter in last week's wrap-up of the funds which bothered to send me a report.

No offence was intended — the fund bought 50 000 Anglo American Industrial Corporation shares and nothing else

I used the word idle, not in the sense of the first dictionary definition "lazy, indolent, unoccupied, useless, vain, purposeless or groundless", but in the second sense — "run slowly with throttle nearly closed".

GUARDBANK

Mr Colquhoun believes my throttle should be closed on account of my comments about another fund's performance in the June quarter

I thought that Guardbank had been clever in selling Gencor shares at more than R90 while retaining enough shares to follow the rights offer at R75. There should be no change in the number of shares ultimately held by Guardbank, but the fund

more than likely made a capital profit.

Mr Colquhoun questions whether or not it is smarter to retain the Gencor shares and sell the nil paid letters. His funds did that, and made more of a profit for unitholders when the cheaper dealing costs are taken into account.

The way Gencor shares are going — up to 9 225c this week — the best idea could have been to hang on to them

"We stuck to our policy of retaining our portfolio of only blue-chip shares," says Mr Colquhoun. "We do not waste unitholders' money with unnecessary dealing costs merely to display activity."

CHANGES

The Mining & Resources fund sold one shareholding, bought one and added to two existing shares

The Selected Opportunities fund made several changes, seven new holdings being introduced and some positions consolidated.

Mr Colquhoun would like to sell about 1% of the shares in the fund, but he cannot find a buyer

The higher-risk fund has appreciated by 32% in the 12 months to June, whereas the general equity fund climbed by 53% and mining and resources 47%.

210

Revitalised JMFC being relisted

210 Finance Staff
Johannesburg Mining and Finance Corporation's (JMFC) five listed companies — JMFC, Egoli, Carrigs, West Wits and Corex — are being relisted today.

Considerable speculation has ended with the announcement and the consortium, led by Gerald Rubenstein and Norman Lowenthal, seems to have restored the group to viability.

In tandem with this announcement, it has been disclosed that the consortium, in addition to Rubenstein and Lowenthal, consists of David Abbott, Charles Turner, on behalf of corporate consultants

DMB Securities, and Monty Schechter, on his own behalf and that of overseas investors

Control of JMFC has passed from Joe Berardo to the consortium by way of a transfer of 60 million shares, effectively representing 52 percent of JMFC in consideration of the consortium's injecting R11 million into JMFC by way of convertible debentures

As a result of this injection of capital by the consortium and agreement reached with the banks, whereby R13 million of bank claims will be converted into debentures, the company has been recapitalised by about R24 million

The remainder of the bank claims of about R5,8 million will be subject to a reduced rate of interest of six percent for two years, increasing to 10 percent until repayment in five years' time

After the restructuring JMFC will hold two major assets in the form of a 64-percent holding in Corex and a 58-percent holding in Egoli. Various non-mining assets have been housed in a third structure, but will be disposed of in due course

Egoli, in turn, will hold 60 percent of West Wits, 59 percent of Carrigs and 100 percent of dumps for retreatment, which are currently being retreated in association with Anglo American.

Extended family runs mega-buck empire

When Anglo American and De Beers proposed to Consolidated Gold Fields in 1986 that it should merge with their offshore investment arm, Minorco, they called the plan "Romans"

After American Barrick acquired an inspired stake in Consgold and the South Africans realised they would have to offer a premium for Consgold, the plan became "Friends" Inevitably, last year's hostile bid was called "Countrymen"

The joke says much about Anglo American and De Beers The stereotype Anglo-De Beers executive is educated in the English liberal tradition, often being finished at Oxford He may be more at ease with the British than the Boers

Yet the joke long ago turned sour in 44 Main Street, the group's pre-war pile in the heart of Johannesburg The failure to take over Consgold was the biggest setback suffered by Anglo-De Beers for many years and laid to rest the group's reputation for invincibility

It stimulated much heart-searching and some internal rancour about the causes of failure and the alternative strategy for the future

What really stung, however, was the realisation that the group's good works in South Africa and liberal credentials counted for little in the outside world

Anglo-De Beers lives in constant danger of bumping up against natural and political limits to growth in SA, and treads an increasingly precarious path as SA's future dissolves into as many possibilities as there are pundits

Anglo-De Beers' quoted companies constitute almost 60 percent of the Johannesburg Stock Exchange's capitalisation Last year Anglo's equity-accounted earnings was R2,64 billion De Beers' profits, including its share of associates' retained profits — R2,96 billion

Dominates diamond market

Their scope is colossal Anglo produces a fifth of the West's gold, while De Beers dominates the diamond market through control of the Central Selling Organisation (CSO), a cartel marketing 80 percent of stones sold in the West

In Britain, Minorco has 36 percent of Charter Consolidated, which also has 38 percent of Johnson Matthey But that is only the beginning

The quoted and unquoted interests include Highveld (SA's only steel producer), Mondi (one of the two major paper producers), Rustenburg (the biggest platinum producer), Southern Life (a leading insurance company), coal, base metals, property, car importing and distribution, the Argus newspaper group and a collection of engineering enterprises

The group, moreover, is virtually synonymous with the emergence of SA as an industrial nation, an emergence which in turn was associated closely with English-speaking South Africans

De Beers Consolidated Mines was formed by Cecil Rhodes in 1888 Anglo American was created by Ernest Oppenheimer in 1917 from capital raised in London and in the US to exploit the discovery of gold

In 1929 Sir Ernest also became De Beers chairman, and a few years later created the CSO The most extraordinary feature of the group is that this structure remains intact, partly preserved by an unusual family continuity

There have been only three chairmen of Anglo since its foundation Sir Ernest died in 1957, to be succeeded by his son Harry When HFO, as he is known, retired in 1982, Gavin Relly took over

De Beers' modern history is similar HFO followed his father in 1957, and then handed over to Julian Ogilvie-Thompson five years ago Moreover, the compact nature of the top management is likely to be reinforced if, as seems likely, Mr

Anglo-American and De Beers constitute an intertwined group whose quoted companies constitute more than half of the JSE's capitalisation The Independent newspaper of London examines these bonds.



De Beers chairman Julian Ogilvie-Thompson ... said to owe his position to mastery of the Anglo-De Beers web.

Ogilvie-Thompson succeeds Mr Relly at Anglo

Mr Relly is due to retire in about 18 months Mr Ogilvie Thompson will then emulate the famous HFO by being chairman simultaneously of Anglo, De Beers and Minorco Mr Ogilvie-Thompson said "I think there are advantages in going back to that system in due course It allows the company to look at the long term"

Another advantage is that the extended family retains a pervasive influence throughout the group The Oppenheimer family's holding is much greater than the modest holdings in group members held by the private company, E Oppenheimer & Son, and by other family businesses

A complex patronage system of marriages, friendship and service contracts binds together an otherwise disparate band, and draws in each fresh generation

The Minorco board includes Roger Phillimore, one of HFO's godsons and son of a director of Anglo companies, and Hank Slack, who is married to HFO's daughter Mary. HFO's son Nicky sits on the Anglo and Minorco boards, is deputy chairman of De Beers and chairman of the CSO

In all probability Nicky, who is 44, will slip into the chairs eventually vacated by Mr Ogilvie-Thompson And beaming benignly from a thousand office portraits is HFO, who disingenuously describes himself as a retired chairman

The personal network is inextricably part of the financial network. De Beers owns 38 percent of Anglo, and Anglo owns 32 percent of De Beers The pattern of impermeable cross-holdings is replicated throughout the group It stems logically from the character of the SA mining industry, in which a single company could rarely afford to finance a mine on its own But it has also been transformed into a unique control system

The group is proud of its social commitment, and executives are privately scathing about what they regard as the incompetence and corruption of the Nationalist government

Mr Ogilvie-Thompson said "We don't believe the last of the mines has been found in South Africa, either gold or base metals"

Nevertheless, Anglo in particular faces rising costs in its gold mines As one executive said "Everyone thinks this thing runs itself It doesn't It's damn difficult to keep the show on the road"

Exchange control makes exporting capital from SA difficult, so spending Minorco's cash pile of some £2 billion, probably bit by bit, is the best way of spreading risks Anglo and De Beers do not intend that their next move will be code-named "To be or nor to be".

Moderate increases for relisted JMF shares (210)

SHARES in Johannesburg Mining and Finance (JMF) and its four listed subsidiaries — Egoli, Carrigs, West Wits and Corex — all rose moderately on the JSE yesterday, the first day of relisting since

REINIE BOOYSEN

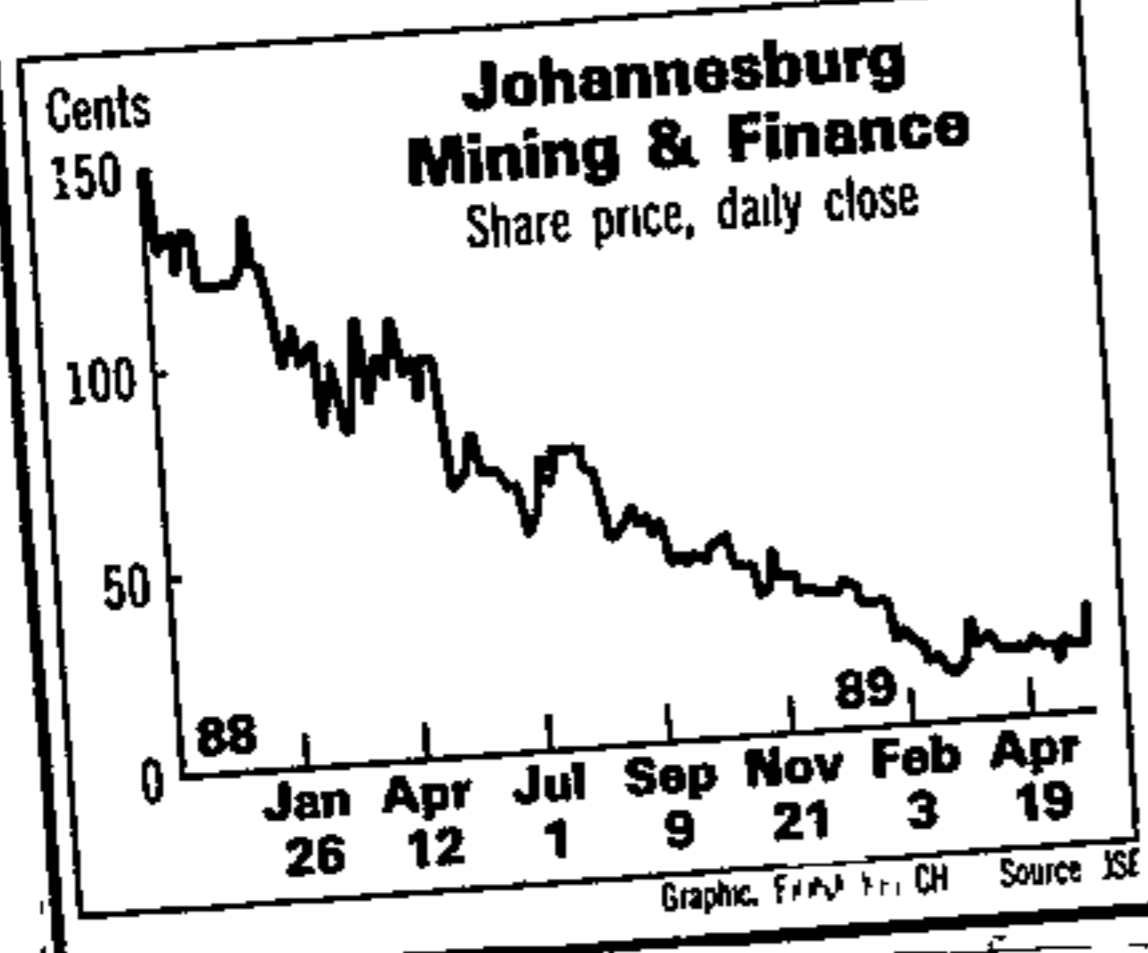

they were suspended on May 22. Details of JMF's restructuring under the new controlling consortium led by stockbroker Norman Lowenthal and attorney Gerald Rubenstein were also published yesterday.

JMF shares rose 10c to 28c — a very low base compared with the highs of 150c last year. Carrigs gained 35c to 65c, Egoli rose 75c to 150c, West Wits rose 35c to 75c and Corex rose 7c to 25c.

All five companies yesterday published results for the year to March. JMF made a loss, before extraordinary items, of R4,7m (1988 R14m profit). Egoli made a profit, before extraordinary items, of R1,5m. West Wits made a working profit of R3,3m (R6,2m), and Carrig Diamonds made a working loss of R298 000 (R545 000).

The consortium has also chosen to dispose of a number of assets, in addition to those that have already been sold. Egoli sold its 58% interest in Waverley and its 32% interest in Simmer and Jack Mines with effect from March 31 for an aggregate cash consideration of R5,9m.

- The following non-mining interests have also been sold:
- Plyproducts to P G Bison for R1,9m,
 - JMF's 49,4% interest in Sam Steele to Supreme Bond Trust for R1,5m,
 - Bas 4 Computers to Gavin Alan Osmond for R200. This excludes stock and debtors, which are expected to realise about R1m,
 - Johannesburg Mercantile and Investment Company to Duro Security Services for a net cash consideration of R1,2m, and
 - Electronic Control Systems and Digitising Systems to D Adam for a cash consideration of R120 000.

210 WMAI
4-10/8/89

Companies at the top — and they top the spenders' list

Weekly Mail Reporter

ANGLO and De Beers don't only occupy a dominant position in the economy. They are dominant too in corporate social spending

The Anglo and De Beers Group Chairman's Fund has funds of about R50-million a year to spend on social projects, whereas, for example, the 70 United States companies who are signatories to the Statement of Principles (formerly the Sullivan Code) spent a total of R86-million in the year to end-June 1988

The Chairman's Fund this week published a report on its activities, something it hasn't done since an *Optima* supplement in 1982. In the report, *Backing Initiative*, Chairman's Fund chairman Michael O'Dowd says the fund "seeks to put its resources into innovative projects at the cutting edge of constructive change"

Since 1973, the fund has attempted to be "proactive" to some extent rather than merely responding to applications for funds, although it donates to any cause it deems "socially constructive"

The fund and the educational trust, through which its education spending is channelled, both have "number one" and "number two" funds. The idea is that while the number one funds respond to requests for donations, the number two funds back large-scale innovative projects.

The original idea was that these funds, which finance the large "bricks and mortar" special projects, would themselves initiate these. In fact it's now more often the case that initiatives come from beneficiary communities — something O'Dowd sees as the most desirable state of affairs

"There is vastly more initiative and more will to start things than there used to be," O'Dowd said at a press briefing this week. He attributed this partly to deregulation but also to "a growing wave within the black community." He said there was an illusion that there was less money around than there used to be — in fact there was more, but not relative to the increased effective demand

Some of the fund's early initiatives may not look very innovative now but were pioneering in their time

O'Dowd pointed to the Chairman's Fund's involvement in building the first black tertiary institution in an urban area — the Soweto Teachers' Training College which opened in 1979 — which, he said, represented an important policy breakthrough at the time

He said the most spectacular new initiative at present was the Schools of the Resurrection — St Ansgars and Grace College, started by parents and community groups in response to the disruption of black education in 1985. "They grew out of street academies and have graduated to full-scale private schools," O'Dowd said. The fund is putting R15-million into building premises for the Johannesburg-based schools

The Chairman's Fund's policy is to support projects other donors might not. The typical "number two" fund project involves an organisation which is still being created, which has not track record and is in no position to do broad fund-raising.

Some of the initiatives succeed — some fail.

O'Dowd said Read (Read, Educate and Advance) had been one of fund's biggest success stories.

In *Backing Initiative*, O'Dowd stresses the fund's contribution to university and technikon education for black students

The fund has emphasised building residences and has backed Academic Support Programmes, in an attempt to address the particular difficulties experienced by black students

Alusaf deal raises queries on govt sale

210 Bday 9/8/89

GENCOR will effectively control more than half of Alusaf's share capital after yesterday's deal by which it bought a 30,7% stake in the Richards Bay aluminium smelter from the government-owned Industrial Development Corporation (IDC).

In contrast the public (and Alusaf employees) will be offered 20% of the company's shares before it is listed on the JSE.

DP Finance spokesman Harry Schwarz yesterday hit out at the deal "I would have hoped that the people of SA would be offered a greater stake in Alusaf. After all, it was their money, through taxation, which initially funded the development of the smelter."

But IDC MD Koos van Rooy last night defended the deal with Gencor: "The IDC believes Alusaf, because of its capital-intensive nature, requires a strong controlling shareholder with sufficient financial and technical know-how to support future diversification and expansion."

A highly diversified group of shareholders would not meet these criteria.

The IDC said yesterday that "a number of suitable companies with the required resources were invited to make proposals" to take over the IDC's "lead role" in Alusaf.

It was IDC policy "to divest itself of control of an operating company when the developmental role becomes less important and private sector investors are prepared to pay a commercial price for the shareholding and take over operational responsibility for the company"

Van Rooy declined to give the names of the companies which were approached. "It was fairly widely known that the IDC was entertaining proposals on Alusaf, so any

REINIE BOOYSEN

company with serious intentions of getting involved could have approached us."

In terms of the transaction, the IDC received R63m cash and a minority stake in an unlisted Gencor company, valued at R207m, in exchange for a 30,7% holding in Alusaf. Schwarz questioned the wisdom of acquiring a minority stake in an unlisted company. "It may have been more in keeping with the IDC's role if the transaction was concluded entirely on a cash basis, and the cash could have been used to fund new projects."

But IDC GM Louis Kingma said yesterday the IDC was satisfied by Gencor that the minority holding in the unlisted company would provide it with a steady source of income to fund its future commitments.

While Gencor holds 2,98% of Alusaf's shares directly, it has also acquired a 56% stake in Aluminium Investment Company (AIC), which controls 49,5% of Alusaf's capital. This provides Gencor with a further indirect holding of 27,72% in Alusaf, for a total of 30,7%.

Because Gencor controls AIC, it effectively speaks for 52,48% of Alusaf's shares.

Alusuisse, the Swiss-based company which initially provided the technical know-how for Alusaf's development, holds the rest of AIC's shares (44%).

Kingma said Alusaf would probably not be listed before the end of the year.

Gencor executive director Colin Officer said there was no plan for Gencor to enlarge its stake.

210
~~210~~
~~210~~

NUM hits out at Anglo racism

copy
13/8/89.

By CONNIE MOLUSI

THE Anglo American Corporation (AAC) has dismissed 11 miners from Vaal Reefs gold mine for using segregated "whites-only" facilities.

The NUM has accused the corporation of racism. The AAC said mine management attempted to deal sensitively with certain acts of defiance by NUM members - such as the use of the mine's senior change house at the No 7 and 8 shaft.

"However, where such attempts disrupt access to shaft lifts and pose a serious threat to safety, management will continue to take disciplinary action", AAC spokesman Paul Clother said 11 employees at the underground assembly point of Vaal Reefs No 2 shaft threatened to disrupt queues of team leaders and miners waiting to board the shaft lift.

Workers allegedly threatened the supervisor, who became violent. NUM condemned the AAC's alleged collusion with the South African police, as police were called in to arrest workers.

"Dismissals and other disciplinary measures will only heighten tension that might lead to confrontation," said NUM.

The union reported a number of defiance actions on Vaal Reefs mines, ranging from washing in the whites-only change rooms to using segregated canteens.

At Mintek, near Randburg, workers have been using a whites-only canteen and management has threatened the union with disciplinary action.

18/8/89

DE BEERS

210

Better than sales

Results from De Beers for the six months to end-June have quelled any fears that a slower rate of growth in sales of rough diamonds might mean a dour profit performance

Rough sales by the Central Selling Organisation (CSO) for the first half of 1989 were up by 5%, compared with the 41% advance seen in the 1988 first-half. In rand terms, the rise was vigorous, with a 26% increase. The currency effect also impacted on De Beers' figures, as did an expected improvement in the margin on the diamond account.

The interim diamond account was 39% higher at R1,332bn (R956m), while the margin was 22,5% (20,4%). Another big boost came from investment and interest income, which at present is strong enough to help offset a slowdown on the diamond operations. With dividend income derived largely from the stakes in Anglo American, Minorco and Amic, investment income was R95m or 40% higher at R338m. Higher interest rates boosted earnings from the large cash balan-

ces, which at end-December totalled R3,43bn and interest income was R241m higher at R349m

For De Beers there have been swings and roundabouts in international currency fluctuations. An indication of the role played by rand weakness is given in the decline of 17%-odd in the rate from US\$0,4316 at the end of the 1988 interim to June 30 1989.

However, one reason why the CSO sales rose more slowly in US dollars was that the 15,5% average increase in the price of gem diamonds, which became effective from the March sight, unexpectedly coincided with a strengthening of the dollar. This exacerbated the effect of the official price rise and made diamonds even more expensive in non-US markets.

It may not have affected the volume of diamonds sold, but it apparently did affect the quality — and it remains uncertain how long that situation will continue. A De Beers spokesman says that demand has basically remained strong and the March price increase has been absorbed by the market, but is unable to comment on the more recent sights.

If the shift in demand away from high-quality gems is sustained, then the higher margins which some analysts are predicting for the second half could be somewhat below expectations. The margin on the diamond account has tended in the past to be higher than in the first half, but the general trend in the margin — particularly when compared with last year's second half — will be influ-

enced by the type and quality of diamond sold

Nothing yet presages a major slowdown for De Beers. The interim advance of 50% in EPS excluding the share of retained profits of associates was at least as good as most analysts expected and surpassed some forecasts. But management does appear to be warning the market to anticipate a slower pace from the cyclical diamond business after the unsustainable growth levels of the past few years.

Since release of the CSO figures in July, the share has remained around R60, well below the 6760c high. The next six months will show how much consolidation is in store for De Beers at this stage in the cycle.

Andrew McNulty

BUSINESS

ALMOST one-fifth of the world's mining assets are currently on the move, and initial attention has been focused on South Africa as international mining houses try to rid themselves of the embarrassing "South African connection".

Nearly \$12-billion (about R32-billion) of mining assets worldwide are in the process of changing hands, according to a recent report by London-based merchant bankers Kleinwort Benson.

Heading the list is Consolidated Gold Fields' \$5.3-billion worth of mining assets. This week Gold Fields of South Africa (GFSA) became the first of its mining groups to be sold, following the successful bid for Consgold by industrial conglomerate Hanson PLC.

In Canada the world's second largest nickel producer, Falconbridge, is facing hostile competing bids by the US-based Amax group and Canada's largest natural resources group, Noranda, which this week teamed up with Sweden's Trelleborg. The offers value Falconbridge at over \$2-billion.

Some R32-billion in mining assets is changing hands right now, much of it the result of mining houses trying to move away from South African connections. KURT JENSEN reports

Finally, British mining giant RTZ has just completed its \$4.3-billion acquisition of British Petroleum's mining and mineral assets. These include some South African interests which have already been resold.

RTZ announced this week it had disposed of its 33.5 percent stake in local gold mine Umsel and a 12 percent holding in Gold Fields (Namibia) for a total consideration of R200-

Fifth of world's mining assets on the move - away from SA

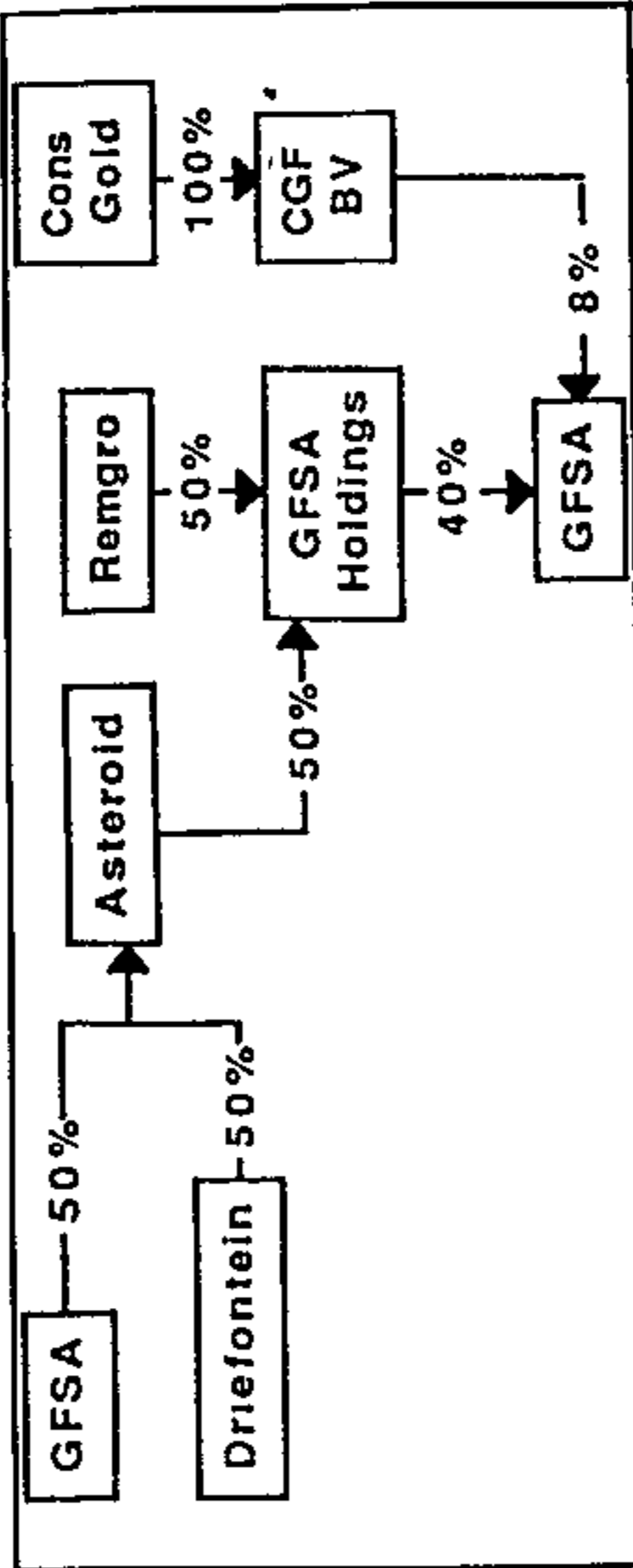

How Gold Fields is controlled, following the disinvestment

major stake in the Palabora copper mine, the Richards Bay mineral venture and control of the Rossing uranium mine in Namibia.

BP itself recently announced that it would sell its South African coal op-

erations and local producers are lining up to buy some of the assets. Included is the country's largest coal exporter, Middelburg Mines.

But for the time being Consgold's dismemberment by Hanson is in the spotlight.

Only one week after winning control of Consgold, Hanson sold the bulk of the UK mining giant's stake in GFSA for £368-million in cash to GFSA and the Rembrandt Group.

It is the biggest single disinvestment by an international group from South Africa.

Hanson is still left with an eight percent shareholding in GFSA and minority stakes in four other mines — five percent of Driefontein, 13 percent of Kloof, 15 percent of the Northam elkraal and 13 percent of the Northam platinum mine.

Hanson could follow its disposal of GFSA with the sale of three other valuable Consgold mining assets. Newmont Gold and Gold Fields Mining Corporation in the US, and Renison Gold Fields in Australia.

Anglo American's international investment arm, Minoro, is jostling for a position in the queue for these assets, after its unsuccessful bid for Consgold. It has \$2.4-billion to spend, now that it's collected cash from Hanson for its 30 percent stake in Consgold.

Both Anglo and Gencor were known to be interested in getting a foothold in GFSA.

But GFSA chairman Robin Plumbridge, in partnership with Anton Rupert's Rembrandt Group, used his company's strategically acquired 7.5 percent shareholding in Consgold as a lever to ensure the company's future independence.

As part of the deal GFSA will receive a 50 percent stake in GFSA Holdings by assenting the 7.5 percent interest to the Hanson offer.

This stake, which is valued at roughly £240-million and held through a company called Asteroid, is jointly owned by GFSA and Driefontein.

Asteroid and Rembrandt now have equal control of GFSA Holdings which in turn owns 40 percent of GFSA, giving both companies an effective 20 percent stake each in the mining group.

Rembrandt's 20 percent in GFSA comprises the 10 percent it acquired in July 1987 and the 10 percent interest which it took up in terms of preemptive rights over 30 percent of the shares.

According to Rembrandt director Johan Rupert, the £120-million price tag attached to the 10 percent stake had been paid off over the last few weeks through the financial rand at a cost to his company in the region of R800-million.

Funding has come largely from internal sources but analysts have questioned the approximately 20 percent premium Rembrandt paid above GFSA's current share price.

They point to GFSA's disappointing results for the year to end-June released this week. These would have given Rembrandt a return of just under three percent on its investment had it owned the additional 10 percent over the period.

In addition, Rembrandt will have to follow its rights if GFSA, as is likely, embarks on a major funding drive to develop various mining projects. Its Northam platinum venture alone will require an injection of R500-million by 1991.

Announcing the deal, Plumbridge said that the new shareholding structure would allow the group to adopt a more aggressive approach to new investment opportunities, as political pressures had made Consgold reluctant to increase its investments in South Africa and had thus prevented GFSA from raising additional capital or making major investments.

Rembrandt will certainly have to dig deep into its coffers when this expansion drive is given the go-ahead, but finally the huge outlays are likely to pay dividends.

GFSA owns a number of quality gold mines with long lives ahead of them and good south African mining assets are increasingly hard to find.

Durban Deep on the mend

Day 30/8/89

REINIE BOOYSEN

DURBAN Roodepoort Deep (DRD) — which was on the brink of closure three months ago because of mounting losses — may return to profitability before the end of the year as a result of the curtailment of underground operations

The company's shares, suspended since May 19, are to be re-listed on the JSE today

The government committee charged with the responsibility of adjudicating requests for assistance to mines has not yet responded to DRD's calls for help

Parent Rand Mines (RM) says the mine may even make a modest profit next year, provided grades and the gold price do not fall unexpectedly

Since end-June, when RM announced that unprofitable underground operations would be closed, the rate of ore milled from underground has been reduced from 140 000 tons a month to about 70 000t

This compares with a rate of about 300 000t/month during the September quarter last year

Underground operations have been re-

stricted to higher-grade, low-cost areas. In the process about 4 400 workers out of 8 000 have been retrenched

DRD MD Eddie Crocker said yesterday the shallower working areas would allow pumping operations to be curtailed

An announcement today adds that Rand Mines Properties has decided against making an offer to acquire DRD. Instead, it is to bid for some of the mine's property assets. The decision follows an analysis of the mine's assets and liabilities

RM gold and platinum division chairman Clive Knobbs said last night "So far, gold prices envisaged in the plan have been achieved and higher underground grades should come through as operations are progressively consolidated in a limited number of areas in the shallower part of the mine"

DRD is currently building up the level of its surface dump retreatment operations, from about 40 000t/month at end-June to about 60 000t/month

Confidence chasm for small miner

S/Times 3/9/89

210

WHEN a mining venture fails to live up to expectations, there are serious repercussions, not least of which is pointing of fingers.

The tendency of all the interested parties — promoters, investors, management and others — is to lay the blame at someone else's door

That South Africa needs to promote its mining, and especially its small-mining industry, is beyond question. But the challenges are compounded by the poor showing of some ventures

There are many opportunities for small mines to be developed, provided that the uncertainties can be reduced to a minimum for all contributing parties

BACKING

On one side of the confidence chasm is the entrepreneur who has a good prospect, but needs technical and financial backing. On the other side of the chasm is SA's financial muscle — always looking for a home, but seldom willing to take on too much risk

SA must bridge that chasm

In the past few years, institutions and individuals bought equity in small mines — mainly gold — which have not met their targets. There have been two common stumbling blocks

- Gross underestimates of capital requirements to develop a mine,
- Equally gross overestimates of ore resources

LIMELIGHT

Who should be held responsible for an investment turned sour? Should it be the management, which might not have run the mine as efficiently as it could have done?

Is the independent consultant at fault? Did he endorse something to comply with the wishes of the promoters of the venture?

Is it the fault of the institutions, which, had they done their technical homework, might have noticed that the financial projections were unrealistically high?

Could it be the sponsoring merchant bank or stockbroker, which enjoy the limelight of a new listing — and the raising fee for placing shares?

Or does the JSE swallow all the blurb and allow something not quite kosher on to its boards?

Much of the blame is generally apportioned to the consultant, who put his neck on the block and endorsed the project

Willo Stear of independent consultant Venmyn Rand makes strong comments on behalf of the breed

Dr Stear says "The estimate of ore reserves forms the basis of the entire worth of a mining project. Since ore-reserve analysis is the area most vulnerable to criticism, consultants and technical advisers should present valuation results that can stand up to scrutiny

AUDITOR

"A consultant is like an auditor. When he assesses the value of an orebody he normally reports the in situ grade. The grade actually recovered after mining and beneficiation often bears little resemblance to the original grade estimate for many reasons

"This can be a result of dilution through mining and metallurgical factors, among others. The fact that the mining company could not make the grade does not necessarily invalidate the estimated content of mineral in the ore-

body."

As an analogy, Dr Stear points out that an engineer designs a bridge, but if the builder uses the wrong materials and the bridge collapses where should the blame lie?

When a mining project seeks the professional endorsement of various consultants more than one opinion is called for — each referee receiving a fee

The promoters are then free to select the most flattering for inclusion in listing documentation

It happens throughout the world. It is to be hoped that SA can avoid the experiences which America and Australia went through, where many at best questionable prospects were listed on stock exchanges

The promoters made money, the minority shareholders — who often provide most of the capital — lost out

It is important to look at new mining ventures from the points of view of all parties. An entrepreneur could be guilty of romanticising the prospects of his venture, losing objectivity

On the other hand, potential investors might find it difficult to assess the prospect adequately because of the responsibility of investing other people's money, or the shame of buying a lemon, or the fear of missing out on a gem

My view is that an investing institution should seek an independent opinion from someone whom it trusts, and not be guided by the faceless endorsement in the venture's own literature

This idea could be extended by agreement that the consultant monitor the progress made at the mine after the listing

SA's mining industry needs to avoid any shockwaves which could batter investor confidence and jeopardise the chances of new ventures

I
v
v
h
g
n
sl
h
ft
O
is
11
by
er
7,
se
re
of
pr
nc
S
no
ca
ou
pl
lo
sto
ch
th
Ca
an
inc
cas
ma
say
any
res
bra
the
row
yea
ric
est
han
T
and
end
ben

by JULIE WALKER

CROSSING THE BRIDGE

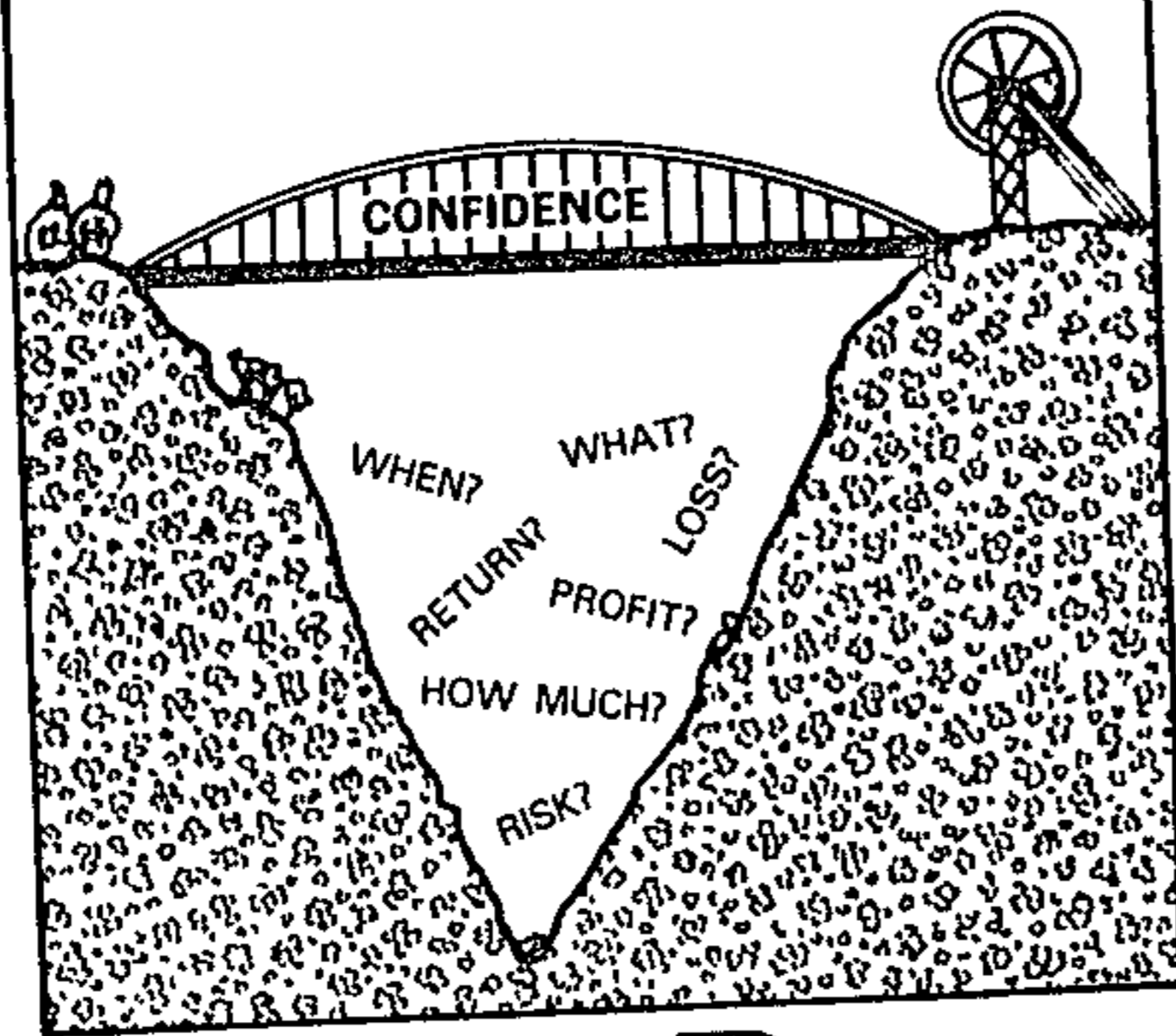

Genbel skirts ²¹⁰ earnings issue _{S/Times 3/9/89}

GENBEL strengthened to R61 after announcing a R300-million rights offer. The investment holding company whose interests are mainly in resource-based equities

manages a portfolio worth R2,5-billion. It is to raise the cash so it can follow investment opportunities

Some of this will include following rights offers made by companies in which Genbel has stakes. Genbel has a large holding in Randex — described as the prime exploration company in SA — which could also require cash should any of its mineral ventures warrant development.

The shares will be issued 15 for 100 at R53 — R8 cheaper than the ruling price and R17 below the net asset value of R70

Genbel's earnings growth in the year to June was a trifling 3% in spite of a swing out of golds

WEALTH

The directors refer to the "increase in wealth of shareholders of R21,60 a share (55%) arising out of an increase in the share price of R19 and a dividend of R2,60"

I call it the Galtieri syndrome — Argentina's in a mess so let's invade the Falklands

Genbel's earnings growth was poor, so let's talk about the increase in shareholders' wealth.

So much for "active management"

BERGERS shares were in demand this week ahead of results, which underline the high quality of the group's earnings

Listed in 1987 after R2,8-million was raised at 100c a share, Bergers commanded a high rating, topping 230c before the market collapse of October that year. The price is now 140c

In the six months to June 1989 Bergers lifted turnover by 26% to R30,8-million, and earnings a share grew 51% to 7,4c. With sales loaded in the second half-year, they could reach 30c

A twice-covered dividend of 15c puts the shares on a projected yield of 11,5% — not bad for the times

SPREAD

Last year's 37% tax rate is not expected to rise much because many of the trading outlets are outside SA in places where the rate is lower than 50%

At listing there were 142 stores in the family outfitting chain which is spread throughout the south-western Cape, homelands, platteland and neighbouring states

Aimed at the lower B to C income groups, Bergers is a cash-only business. Chairman Howard Mauerberger says that with so many shops, any political activity or unrest which might affect some branches can be carried by the group

There are virtually no borrowings, and the December yearend balance sheet is cash rich. Therefore, when interest rates are high, Bergers hardly suffers

There are 187 stores now, and the target is 200 by the end of the year. Shops are being upgraded, and those in

Pop quality at Bergers

_{S/Times 3/9/89}

poor sites moved to better premises. Expansion is funded out of the group's resources

EXPANSION

Mr Mauerberger says Bergers has been in business for 65 years, but only in the past decade has it undergone significant expansion. It now employs more than 1 000

The products sold are sourced mainly from SA suppliers, and about 5% is imported from the East. Bergers often procures raw materials and uses cut-make-trim factories to produce clothing to its design

In the last quarter, half of the stores will begin selling shoes

"This is an exciting development which should ensure that the turnover growth remains strong," says Mr Mauerberger

The average contribution to turnover from shoes in other total outfitters is about 20%, which augurs well for Bergers

A tailor-made warehousing facility should be in use before the end of the year. Its leasing cost should be offset by more efficient product handling and faster distribution to shops

COMPUTER

These advances will be managed by a new computer system also designed to con-

trol stock

Management expects that the value-for-money goods offered by Bergers will help sales to grow well above the rate of inflation, barring unforeseen circumstances

Mr Mauerberger is the major shareholder with a little more than 50% of the company. The other directors own 18%, institutions holding another 10%

STEAM

With the JSE's blue-chip industrials running out of steam, investors should put Bergers high on their shopping lists among top-quality second-tier counters

The retail sector's average price-earnings ratio is 8,7, so Bergers shares at 140c look cheap a little over four times prospective earnings in the light of sound prospects

PABXs
ELECTRONIC AND SEMI-ELECTRONIC (all sizes)

SIEMENS, PHILIPS, STC, PLESSEY, TELKOR

Most units repossessed

Installation and service guaranteed anywhere in South Africa.

Contact:

PABX EXCHANGE PTY LTD
Tel/Fax 339-2272 (8 lines)
Telex 422476

GFSALIBERTY

Strategic effects

210
Final
8/9/89.

With details of Gold Fields of SA (GFSAs) R1bn rights offer expected on Friday, analysts are pondering the strategic implications of the tie-up between Liberty Holdings and GFSAs's controlling shareholders, Remgro and Asteroid

Two points are puzzling. The first is why Remgro, having paid nearly R100 a GFSAs share for control, should apparently allow Liberty to acquire its stake through the underwriting agreement at a significantly lower price, probably about R75

The second is why GFSAs management, having carefully negotiated the deal with Remgro, which left it in joint control of GFSAs with Remgro, should agree to the new structure where Liberty appears to be the power broker

The answer to both may be that reality is not as it appears. Sources tell me Liberty will pay slightly above the going market price for GFSAs shares to get its stake in GFSAs Holdings

I am also told that there is no way Remgro would endanger its own interests by allowing the deal to be structured so that Remgro's position could be prejudiced by a Liberty/Asteroid alliance. Private agreements between the parties mean Liberty does not have this power and it will not have a seat on the boards of either GFSAs Holdings or GFSAs. GFSAs Holdings has 40% of GFSAs, giving it effective control. GFSAs Holdings is controlled 50/50 by Remgro and Asteroid, a company jointly owned by Driefontein and GFSAs

GFSAs Holdings will follow its rights in GFSAs, but will do so partly with money from Liberty, in return, Liberty will gain 20% of GFSAs Holdings. Asteroid and Remgro will dilute their stakes to 40% each. Liberty already has a direct stake in GFSAs of some 6%, but some of these shares may be required to lift Liberty's stake in GFSAs Holdings to 20%

GFSAs executive director Bernard van Rooyen says it is expected that after the rights issue, Liberty's holdings in GFSAs will comprise the 20% stake in GFSAs Holdings and perhaps another one or two percentage points held directly

Liberty executive director Farrell Sher says Liberty does not intend getting involved in the management of GFSAs. The group considers the stake purely an investment and control remains with Remgro/Asteroid. Van Rooyen denies there is any agreement between the three parties which limits Liberty's voting rights in GFSAs Holdings

"Liberty will have normal voting rights in GFSAs Holdings," he says. "The shareholders' agreement contains only normal provi-

sions such as pre-emptive purchase rights between the parties. We welcome Liberty's participation. They are people we can work with and their participation will make no difference to control of GFSAs which remains in the Remgro/Asteroid partnership. I would point out the significance of Remgro and Asteroid's stakes remaining equal at 40% "

The speed with which the rights issue was announced after the restructuring of control took some by surprise. Van Rooyen says GFSAs wants to take advantage of favourable stock market conditions

Spending the money would not appear to be a problem — GFSAs commitments to just two known projects will account for more than 40% of money raised. GFSAs has 67% of Northam Platinum, expected to come to the market for between R500 and R600m, so GFSAs's commitment here is around R370m. GFSAs also has 30% of Venterspost gold mine, which will hold a rights issue to raise about R200m and which will swallow another R60m of GFSAs's funds. Other projects include the Gamsberg zinc deposit near GFSAs's Black Mountain base metal mine in the northern Cape

Van Rooyen says GFSAs also likes to keep a "pot" of funds available to take advantage of unexpected opportunities, such as Newmont's divestment which allowed GFSAs to take over Tsumeb Corporation and O'okiep Copper and also gain control of Gamsberg

Brendan Ryan

JCI buys Canadian loader

By Stan Kennedy

The delivery of an Osciloader to Johannesburg Investment Company (JCI) by Bateman Mining Equipment (BME) is the first sale of the unit outside Canada

Built for the opencast and underground trackless mining market, the unit is claimed to be a major step towards changing the face of the local mining industry.

It is designed for continuous high-capacity loading of ore and is currently available in two model sizes, handling 450 t/h or 1 000 t/h.

Says Mr Geln Zille, BME managing director "The machine has many ad-

210

vantages over traditional loading methods and will bring the mining industry a step closer to true mechanised mining"

It ensures an unbroken flow of materials from the ore face to an in-line conveyor or ancillary haulage unit. Being electrically driven, it significantly reduces refrigeration requirements, excessive noise level and noxious fumes in deep level mining operations

Operating costs are expected to half those of load-haul-dumpers (LHDs) because of reduced maintenance, energy consumption and labour costs. The unit is crawler mounted

Market holds up well in face of huge scrip supply

Star 15/9/87

210

By Ann Crotty
 Investors on the Johannesburg Stock Exchange have poured an additional R3 billion into the market this year in the form of subscriptions to rights issues from a wide variety of companies.

Between now and Christmas they will be asked to fork out something like R6 billion — with Iscor alone accounting for a massive R3,7 billion.

In the face of all of this extra scrip, the market has not only held up reasonably well, but by mid-August it had surpassed the previous record reached in October 1987 — just before the crash.

The traditional sequence of events is for a series of rights issues to be followed by a market correction as investors digest the extra equity.

While a few analysts believe that the market is heading for a correction, the consensus appears to be that between now and Christmas the market will drift sideways with, at worst, a slight easing in prices.

International markets

But nothing as significant as a correction.

This assumes that international markets (particularly New York) hold up and that international economies remain strong.

The most important single factor underpinning the current market strength was the announcement in March that

the prescribed asset requirements (which obliged institutions to invest between 30 percent and 53 percent of their cash flow in gilts and semi-gilts) would be abolished.

The requirements have been replaced by guidelines designed to ensure that the institutions have a prudent spread of assets.

This meant that overnight the institutions had an additional R15 billion in the form of discretionary cash assets — funds which had previously been earmarked for the gilt and semi-gilt market.

Companies responded very quickly. Announcements of rights issues came thick and fast.

Among those who have already come to the market are Cengold (R2 million), Umdev (R19,76 million), Nigel (R15 million), Staalchem (R4,3 million), Sunpak (R16,2 million), Premier (R28 million), Punchline (R51 million), Zaaiplaats (R7,5 million), Royal (R19,5 million), Huntcor (R107 million), HLH (R147 million), Federaal (R828 million), Gencor

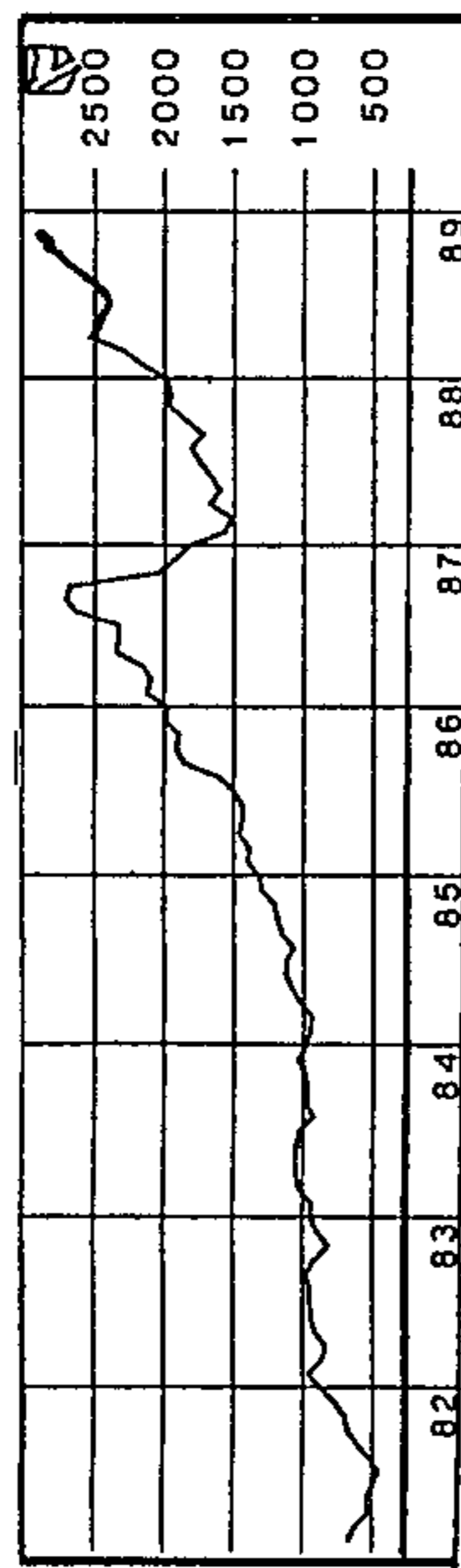

Stull to come are Genbel (R300 million), GFSA (R1,3 billion), Iscor (R3,7 billion), Bankorp (R390 million). This week's release of the details of the Iscor share issue caused some hesitation.

There are obvious signs that as the day to part with the big cash comes closer, investors are slowing down their chase for equity.

This mood is likely to dominate the market between now and Christmas. And it is likely that the level of activity may move into an even lower gear as the large issues approach deadline and the Christmas lethargy sets in.

As one analyst said yesterday, institutions are not accustomed to having this amount of scrip available to them and it is bound to make them cautious.

But not to the extent that a correction is on the cards.

The institutions appear to be very happy with these developments.

As one of the majors says "With the abolition of the prescribed requirements we now have considerable discretionary cash resources looking for investment opportunities."

"New share offers and rights issues give us the opportunity to move into a relatively expensive market without pushing prices even higher."

New opportunities

In the absence of these new opportunities, the institutions say that they would have had to wait on the sidelines for a correction.

All agree that in the context of the current institutional cash flow, the size of the issues is manageable, "but must take some steam out of the market".

From the companies' point of view, they have done well to avail themselves of the opportunities presented by a strong market and the change in prescribed asset requirements to get additional capital.

Although equity is considered an expensive source of capital — because it represents a permanent "cost" to the company — in view of the outlook for interest rates and the relatively high share levels, it has obvious attractions.

Those who have raised funds are now in the enviable position of having cleaned up their balance sheets ahead of what may be tough trading times.

210 ~~210~~

Bank's monthly statement of assets and liabilities under "other liabilities" which fell R1bn to R6,7bn

Despite the repayments, foreign reserves rose by R242m (US\$59m) to R2bn (\$726m) — mostly as a result of the lower dollar value of the rand. Foreign asset reserves include deposits and call money at foreign financial institutions, investment in Treasury bills and securities of foreign governments and other relatively liquid investments in foreign currencies.

Gold reserves were virtually unchanged by value from July at R3,4bn (\$1,2bn) though the volume dipped 58 000/oz to 3,74m/oz. Though the dollar price of gold fell, the rand gold valuation rose to R899,94 (July R886,11).

The Bank says "nothing significant hap-

Is the worst over?

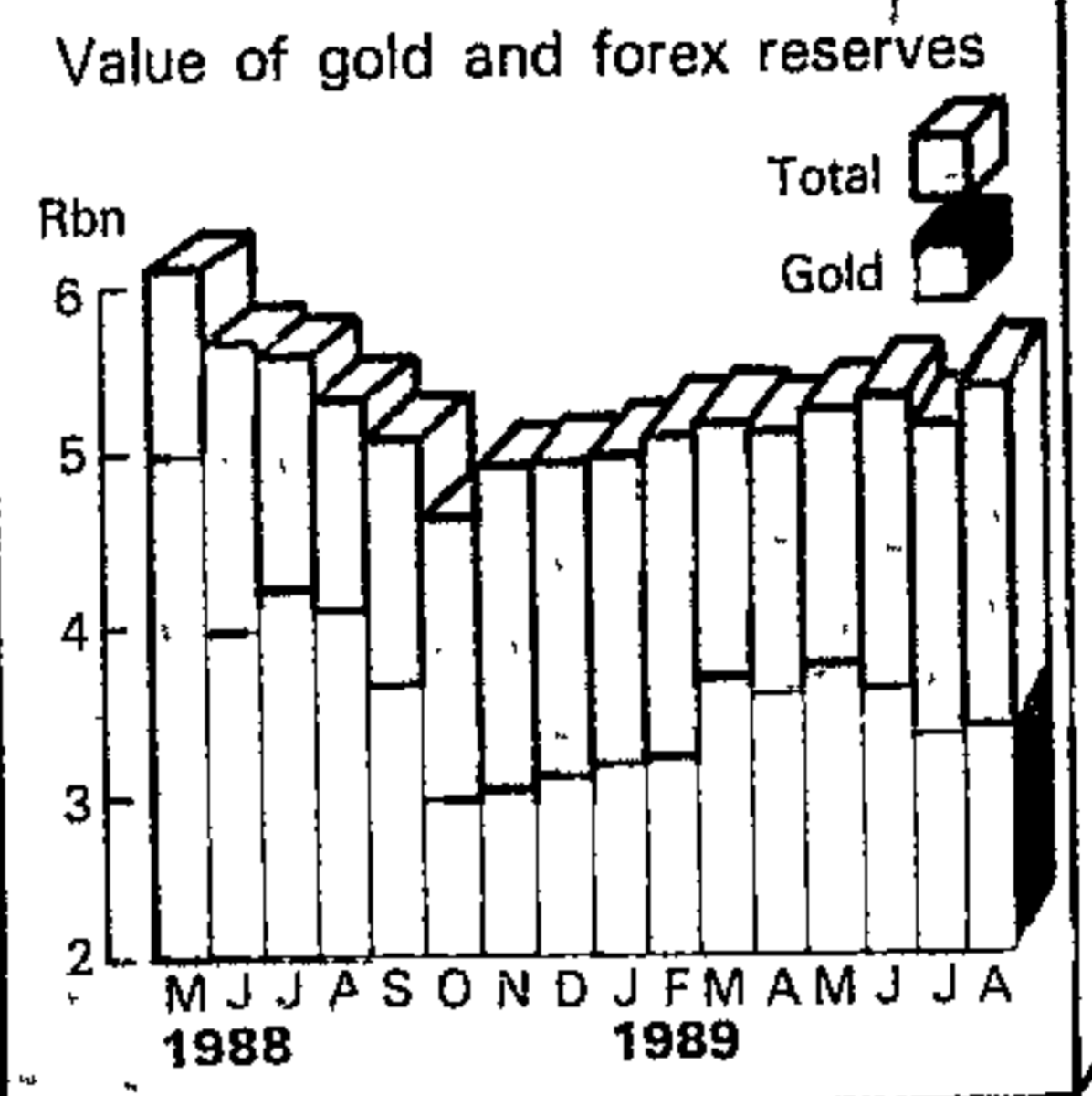

pened in August to alter the state of reserves," though an interest payment to creditors of US\$150m-\$200m in mid-September could affect this month's reserves.

But pressure is obviously off, indicating an easing on BoP. The current account surplus has topped R1bn for two months in a row.

Even so, based on July imports of R4,1bn (August figures are due this week), foreign asset reserves cover only 1,3 months' imports. "But the current account surplus could widen in the next few months to accommodate debt repayments and other capital outflows," says Rand Merchant Bank economist Rudolf Gouws.

"This goes hand in hand with the tapering off in the economy and reduced demand for imports," says Osborn. "Though July imports were disappointingly high, they may have been distorted by Untag imports and high Botswana imports. We expect a noticeable decline in the second half-year and reserves are likely to improve further for the rest of the year if gold holds."

But Barnardt fears an improved reserve situation will not lead to a relaxation in monetary policy. "A markedly strengthening dollar together with a falling gold price could cause a two percentage point rise in interest rates," he says.

15/9/89

RESERVES

210 ~~210~~

Still going up

August blew in better news for the gold and forex reserves, showing SA is in a slightly better position to honour foreign obligations. Despite a lower gold price, the value of total reserves rose — by R242m to R5,4bn. According to Nedbank chief economist Edward Osborn, this represents a US\$59m increase.

Though loan repayments are deliberately concealed by the Reserve Bank in foreign liabilities, Trust Bank economist Nick Barnardt believes "the rise would have been much larger had the Bank not reduced foreign liabilities by R1bn in August, following a substantial reduction in July." He says the better fundamental position of the balance of payments (BoP) in the second half of the year enabled the Bank "to repay short-term facilities in the past two months which had been used in the previous six months to shore up gross reserves."

These payments are reflected on the

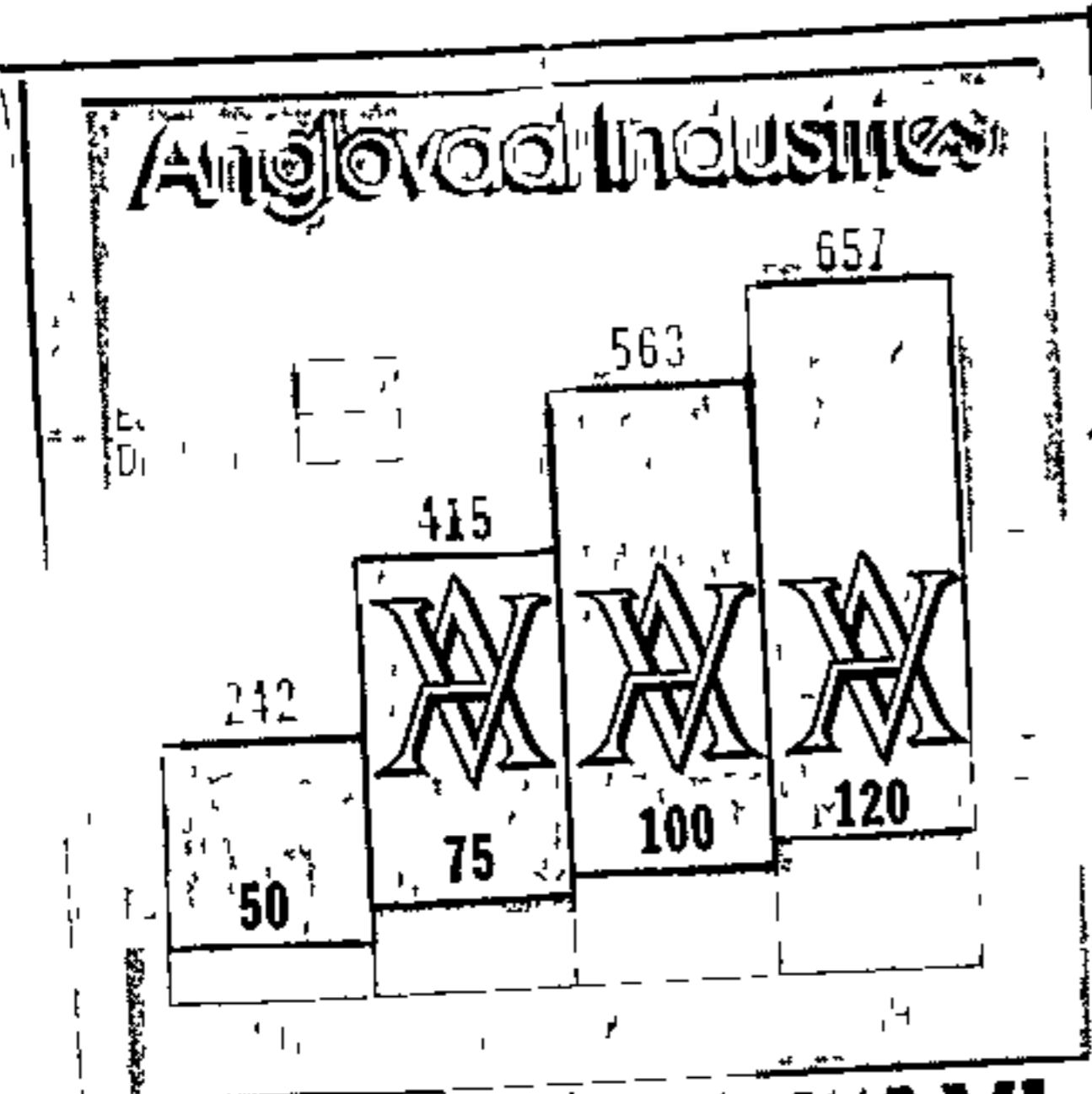

Restructured AVI turnover at R4,6bn

BRENT MELVILLE
 ANGLOVAAL'S acquisitive industrial holding arm Anglovaal Industries (AVI), reflecting the improved results in most of its subsidiaries, has pushed turnover to R4,6bn (R3,7bn) for the year to end June. The restructured group managed to bolster bottom line earnings by 17% to R164,6m (R140,1m), translating into earnings of 657c (563c) a share.

The dividend, announced at 120c (100c) a share and covered 5,5 times by earnings, places the share — currently at R48,50 — on a dividend yield of 2,5% versus the sector average of 4,4%. The share shows a P/E of 7,4 times as against the sector's 8,4.

Indicative of the sure-footed management of the group, investment income soared 127%, adding R48,8m (R21,5m) to a 22% growth in operating profit of R476,9m (R392,2m).

However, interest charges, due to in-

□ To Page 2

AVI results

creased borrowings, virtually negated the investment bonus — jumping 87% to R44,8m (R23,9m). And with the effective tax rate up to 44,2% (43%), tax charges chopped R212,6m (R167,8m) — leaving a lowered but still creditable after tax profit figure up 21% to R268,3m (R222m).

The share of earnings from associated companies increased to R12,5m (R5,7m) — largely as a result of purchases by Grinaker subsidiary Siltek.

Siltek has also made a bid for the outstanding balance of the M & PD shares. And Grinaker has offered its shares for a takeover of cash shell Mooi River Textiles into which it intends to reverse its electronics interests in the form of Grintek.

In addition AVI's packaging subsidiary Consol purchased the entire equity in disin-

vested US-based Goodyear Tyre which on the balance sheet showed an increase in gearing to 21% (11%), with the current ratio decreasing to 1,61 (1,7:1).

Chairman Basil Hersov is happy with the results of the AVI companies with the exception of Steelmetals, which recorded a loss. In the engineering sector subsidiaries Claude Neon, Globe Engineering and Tristel Holdings recorded sound performances.

Textiles, grouped within the Avtex stable, produced strong profit growth. And the dry foods and beverages sector reported satisfactory profit growth.

The acquisition of Goodyear is expected to enhance Consol's future earnings significantly, and Irvin & Johnson shrugged off a decline in frozen vegetable sales at the end of the drought.

□ From Page 1

18/04/15/9/89

(210)

Merger news - shares suspended

Monday 20/9/89

(210)

REINIE BOOYSEN

THE great paper shuffle in the light-weight mining industry continued with the news yesterday that Johannesburg Mining and Finance (JMF) — the fallen empire of one-time mining magnate Joe Berardo — was to merge with South East Rand Gold Holdings (Southgo)

The companies' combined market capitalisation is R102m — R62m for Southgo and R40m for JMF

Shares in JMF, subsidiaries Egoli, West Wits and Corex, and Southgo were suspended on the JSE yesterday JMF director Norman

Lowenthal said yesterday the terms of the merger would be announced on Monday.

The plan was for Southgo to become a subsidiary of Egoli, which is was the holding company of JMF's diamond and gold mining interests. Southgo shareholders would be offered shares in a JMF group company in exchange for their Southgo shares

Southgo chairman Glen Laing declined to return Business Day's calls

Only your signature can protect St Lucia's dunes from the miners

RICHARD Bay Minerals, according to well-informed sources, is going to insist on mining St Lucia's coastal dunes as soon as it has rewritten its environmental impact reports

The petition to save Lake St Lucia game reserve from becoming a mining area is the only method the public can use to stave off the miners

Meanwhile, one interesting difference between the St Lucia petition and the petition, 10 years ago, to save Kruger Park from a similar fate, has emerged according to petitioners "everybody" wants to sign the "Save St Lucia" petition

In the Kruger Park petition — for which The Star and the Wildlife Society reaped a decisive 130 000 signatures — some

JAMES CLARKE



people who were approached refused to sign, mainly because they believed Iscor was more valuable than the Kruger Park.

Another difference in this petition — hundreds of black people are signing. By last night, 36 000 signatures had been collected

A Pretoria Technikon student, Mr Calvin Stead, who delivered well more than 2 000 signatures to The Star, told me. "Nobody refused"

When Mr Tom Sutherland, on a No 22 bus to Cyrildene in Johannesburg, asked the woman sharing his seat to sign, she took the form to all the others on the bus

Two Std 5 children from Cyrildene Primary School, Lisa Dorfman and Menelaos Lagoudis, brought more than 2 100 signatures to The Star. An accompanying parent said "The children want to be able to see St Lucia the way it is now."

A Sandton woman said. "I went to the cake shop and I had to sign. Then I got to the hairdresser who had his own list I

said I had already signed but he insisted — sign, or he wouldn't do my hair"

Catherine Adams and her friends collected 1 210 in Fourways. Just over 500 signatures came from Edgars offices; other wads of signed petitions came from First National Bank's head office staff and from Nashua and South African Airways

Mining vs nature

The outcry over plans to mine the eastern shores of Lake St Lucia is subsiding slightly now that government is forcing Richards Bay Minerals to suspend its scheme pending a full environmental impact study.

This does not mean, however, that the debate over the proposed titanium mining operation is over, it will continue but in a more rational and less emotional tone.

The issue is simple which is more beneficial to the country — short-term cashing in on the favourable world titanium market or long-term benefits of turning the area into an international nature reserve and tourist attraction? Higher foreign exchange earnings are an immediate gain, and, to a lesser extent, more jobs. Long-term benefits are harder to measure.

The value of mineral deposits in the St Lucia area is pegged at R5bn, at current world prices. If 3 000 t/hour were mined 24 hours a day the company would need 15 to 18 years to work the 25 km strip between St Lucia and Cape Vidal.

Environmentalists can't throw any numbers about but they argue that the richness and diversity of the land and water systems of St Lucia represent a non-depletable and potentially greater source of foreign exchange as an international tourist reserve. The tourist windfall, they say, will be even greater if the estuary — the largest of its type in Africa — is linked with reserves further north, in accordance with still sketchy plans. What environmentalists cannot do at this stage is put a figure to this value, though they are working on projections.

An interesting feature of the St Lucia controversy is the depth of public support conservationists draw. The anti-mining campaign ranges from petitions circulated in Durban supermarkets to schools sending objections to the company's parent in Canada — Quebec Iron and Titanium.

Unexpected support comes from sugar farmers on the North Coast. After losing one of their big export markets when Canada hit the sugar industry with sanctions seven years ago, farmers are irritated that a Canadian company now stands to make vast profits by exploiting minerals in their backyard. ■



Norman Lowenthal and Gerald Rubenstein Picture: Oltman, Minnie

Berardo rescue duo do a Southgo coup

S/Times 24/9/89 *(210)*

AFTER saving Joe Berardo's mining empire, attorney Gerald Rubenstein and stockbroker Norman Lowenthal have pulled off another coup by bringing Southgo into the stable.

Southgo will join the Rubenstein-Lowenthal consortium in control of Johannesburg Mining & Finance Corporation (JMFC). Southgo and the JMF consortium will have 25,5% each of JMFC, which is to be renamed

JMFC is to take the minority out of Corex at 30c a share and will end up with 70% of Egoi

Frigate

Egoi will hold 77% of Southgo and 75% of Carrigs. Southgo will hold 100% of Johannesburg Mineral Corporation, 62% of Nigel, 60% of West Wits, 57% of Wit Nigel, 25% of Knights and all of Claw Coal

Southgo will acquire 60% of West Wits and 100% of Johannesburg Mineral Corp, which owns the Protea, Kleinfontein and Denver dumps for R65,9-million in Southgo shares at R1 each

Business Times Reporter

Egoi will thus come to own 50% of Southgo

Southgo will acquire Claw Coal, which has 11,3% of soon-to-be listed Frigate Group. Egoi will acquire 35-million Southgo shares.

Together, JMFC and Southgo will produce 5 400kg of gold a year worth more than R173-million at current prices. JMFC also produces diamonds worth R12-million a year. All the mines in the stable are cash positive

Mr Rubenstein and Mr Lowenthal have known Southgo's Glenn Laing and Roy Flowerday for years and helped the entrepreneurs to list it in common with most new mines. Southgo has struggled to meet targets, but is now on its feet

Mr Rubenstein pays tribute to Joe Berardo, who is believed to be in Madeira, saying "People scorn and laugh at the market gardener who made millions and lost them — but this country owes him

"He was the first to show that gold could be extracted from dumps, today a major industry. To save the minority shareholders, he was big

enough to walk away from his shares for nothing.

"When our consortium took over, JMFC had no money left from the R81-million sale of Marlin Granite. When Joe got into trouble, his attorney Monty Koppel came to see us to discuss a possible deal. The only way we could save the company was by taking Joe's 60-million shares at no cost

"The company had overdrafts of about R24-million. To save the company, we had to do a deal with the banks

Wheeling

"The company has been recapitalised. What we have done this week is pull off a true merger. Now JMFC and Southgo are being run by three men who know mining — Roy Flowerday, Glenn Laing and Monty Schechter."

The Rubenstein-Lowenthal team has been together wheeling and dealing for 30 years. They usually have a dozen deals on at a time, yet still find time for law and stockbroking

The old cronies were also involved in the restructuring this week of Adco and Micor, last week's controversial mi-

□ To Page 2

A mining investment

(210)

Bear in mind certain principles before using your money

THE first principle an investor should bear in mind when looking at a mining company is that by its nature a mine is a wasting asset, since the amount of ore in the ground is limited.

One day, even the richest mine is going to run out of ore. When that day comes, the company that owns the mine will stop mining, return as much of its capital as possible to shareholders - and liquidate itself

It is therefore of prime importance to an investor to know the life expectancy of the mines he is interested in.

In some cases, for instance some of the older Witwatersrand gold producers, that life expectancy might be only a few years

In other cases, for instance in some of the newer gold, coal, copper and other mining companies, the reserves of ore might be so extensive that no one can say when they are likely to run dry

Where the life of a mine is clearly limited, the wise investor will be looking to obtain not only an adequate return on his capital, but also the recovery of the capital itself, by way of the dividends the company will be able to pay until the day it bites the dust

This process is known as amortisation

A simple example of how amortisation involves a mine that is expected to close down after five years, is when it will sell its plant and any freehold land

Assuming the dividends over the five years are estimated at 20c

a year and the "break-up" operations seem likely to produce a further 60c a share, spread over a three-year break-up period, an investor can expect a total of 160c a share over eight years

The shares in this particular mine stand at 80c in the market and apparently offer a current return of 25 percent (calculated on the present dividend of 20c on the share price of 80c).

However, after eight years the shares are going to be worth nothing, so the investor must recover the 80c he has paid for them.

Therefore he decides to regard half the 20c dividend as a return of his capital and to keep a record showing a progressively lower cost price for the shares

The other half of his annual income from this share (10c) he regards as income, seeing the yield as 12.5 percent

This is a very elementary example of the principle of amortisation.

In practice, an investor might make much more complex calculations involving his personal tax situation and also the fact that, as his capital is coming back during the life of the investment it is available for him to reinvest somewhere else.

Of course, how accurate any of these calculations will be, depends on the soundness of the estimate of the life of the mine

Quite apart from the question of how long a mine will continue to produce ore, mining shares have many features peculiar to themselves which demand from an investor some knowledge of the technical terms used in mining

Nearly all the mining companies produce extensive statistics each year, while the gold mining industry also provides quarterly reports detailing tonnages milled, gold recovered, etc

When the price of gold is determined by the international market for the metal, accurate predictions are far more difficult, or even impossible, to make.

For one thing, earnings now depend not only on the market price, which is subject to unpredictable events throughout the world, but also on Government policy on gold sales

Other uncertainties in assessing gold mining shares include the normal hazards of mining - rock

bursts, for instance, the erosion of profits by higher working costs and the possibility of labour disputes.

Turning to industrial companies, the wise investor considers the macro picture of the world and national economies before turning his attention to particular companies.

The sort of questions to consider when thinking of investing in an industrial company include.

* Is there anything happening in the world economy which could affect the local market?

* What are the general prospects for industry, in the light of financial and commercial prospects for the country as a whole.

* What is the outlook for the sector of trade or industry with which the company is concerned?

* How does the company compare with its competitors? If it has no serious competitors is there a threat to its future because of its monopoly?

Next week we will look at how to go about buying shares and timing decisions to buy and sell.

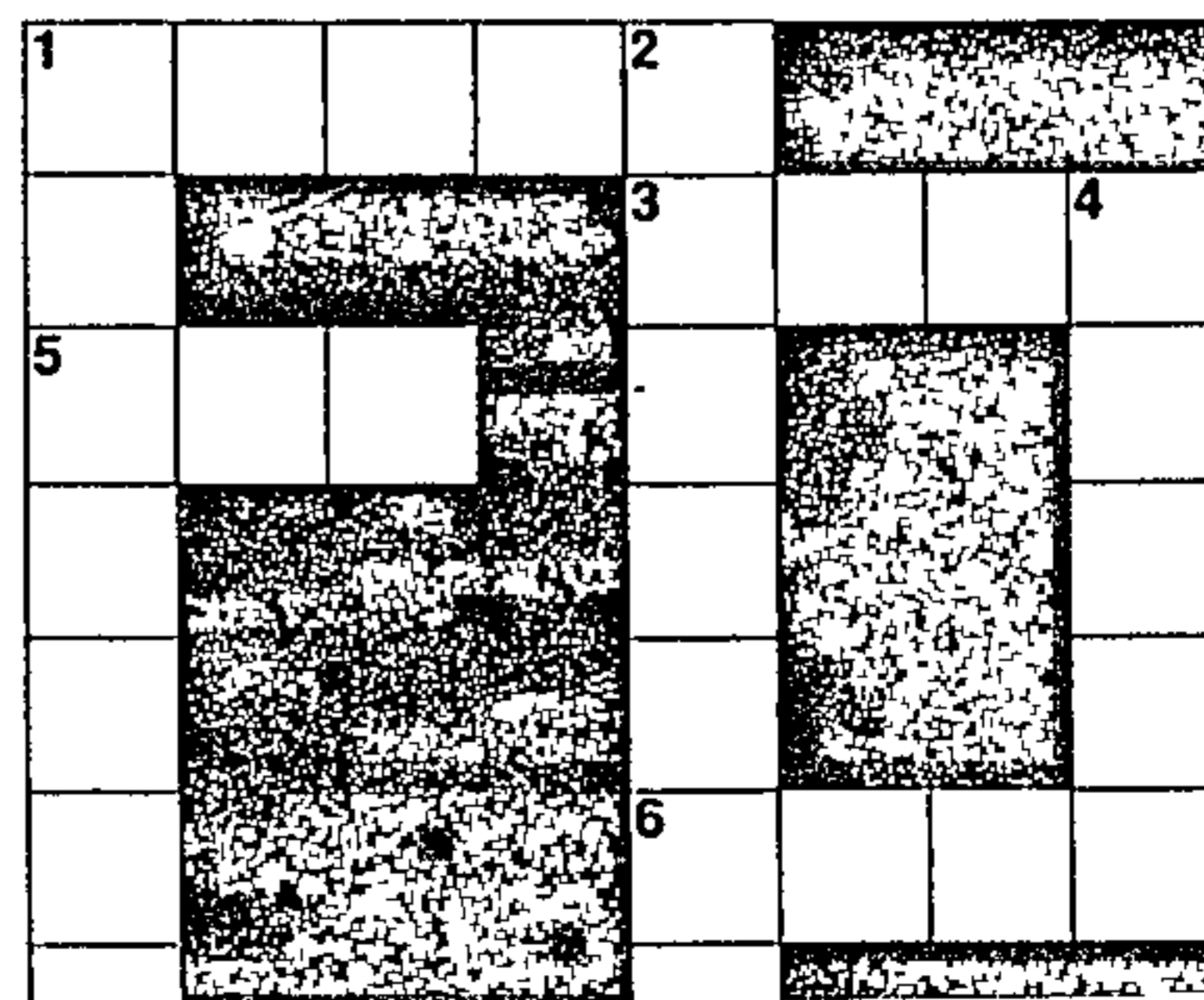

MEDIA SPOT

Chamber of Mines hits a first with its woodcut campaign

610cy 26/9/87
210

THE Chamber of Mines has notched up a 'first' with its new corporate advertising campaign currently appearing on television, radio and in print.

The campaign, conceptualised by Ogilvy & Mather, Rightford Searle-Tripp and Makin (Johannesburg), is the first in SA to use a woodcut technique.

It has resulted in a campaign which is striking and different, with a true "Africa" feel.

Capechi & Friends handled the production of the 40-second, animated television commercial, which features close on 500 individual woodcuts.

These woodcuts were carved by students from Durban Technikon. They also carved the cuts which will be inked and printed for the seven print advertisements.

The Chamber of Mines called for 11 versions of its radio commercial — in English and Afrikaans, and nine others in African languages.

According to O & M client service director Greg Garden, the prime ob-

CATHY VAN ZYL

jective of the campaign is to build the image of the mining industry as a whole and to gain the trust and support of its 750 000 employees.

Identification

It is also intended to create an awareness of just how important a role mining plays in the SA economy, and in the economies of the country's neighbours, to show mining's independence of government and illustrate the wide range of careers in the industry.

Garden says the Chamber of Mines chose the animated, wood-cut technique to rise above specific identification with race types, job categories and geographical locations.

At the same time, it highlights the common destiny shared by members of the target audience.

Garden says the Chamber has also commissioned an outdoor campaign, which will run in major mining areas, to concentrate on building pride and image.



Right The Chamber of Mines has earned congratulations for its new campaign, which hinges on the dramatic use of animated woodcuts.

B/day 27/9/89

(210)

Genmin plans huge development in CBD

A MASSIVE new head office development is being planned by the Genmin group for the financial district of the Johannesburg CBD within the next two years.

The multi-million rand development, if it takes place, will add impetus to the move to develop the western sector of the CBD.

Genmin, the management company established in March to take control of Gencor's mining operations, and Gencor head office are considering the demolition at least a portion of their existing offices to replace them with more modern facilities.

Four leading architectural firms are already at work considering the development options open to Genmin, which owns the properties and rents

VAL PIENAAR

space to Gencor.

One very real alternative is for Genmin to find a corporate partner to come in as joint owner and tenant of the new building. However, Genmin deputy chairman Brian Gilbertson said his company would be unlikely to sell any of its five head office properties.

"We want to consolidate our operations, and are looking at rebuilding on one of our two blocks on Marshall Street," added MD Steve Ellis.

"It's still too soon to be certain of what we are going to do, but it looks likely that the block bounded by Main, Marshall, Hollard and Simmonds streets will be demolished to make way for the new development."

The opposite block, bounded by Marshall, Anderson, Sauer and Simmonds, could be developed at a later stage, or even concurrently, he said.

According to Gilbertson, full ownership of the properties on these blocks is "virtually within Genmin's reach".

At this stage both Genmin and Gencor head offices are accommodated in five buildings. General Mining House and Jubilee House are on the block probably scheduled for demolition, while Unicorn House, Union Corporation Building and 80 Marshall Street are on the other block.

Between them, these buildings contain a total floor area — including common areas — of 34 000m².

Modern

"We have asked four architectural practices to examine the possibilities for the development of these blocks," said Hugh Frangs, manager, group architecture, at Gencor.

"A couple of the buildings are at least 50 years old, and the newest is about 20 years old. They simply are no longer suited to running a modern business," he said.

The older of the buildings, if built more than 50 years ago, could be protected under the Monuments Act, which could well complicate development plans for the area.

By Derek Tommey

Govt failing ²¹⁰ in efforts to help mining — JCI chief

The Government's efforts to promote the mining industry fall seriously short of what could and should be done, says MB Hofmeyr, chairman of the Johannesburg Consolidated Investment (JCI), in his annual statement.

The Government should abandon the retrogressive policy of ring-fencing, which is inhibiting the expansion of many existing mining ventures

It should also change the tax legislation to enable mining houses to perform their traditional catalytic role. *Stw 27/9/89*

The tax dispensation imposes penal charges on the profits from these operations, he says.

The coming year promises to be one of greater economic difficulty than this one.

The growth of the world economy has declined and

there are indications of recessionary tendencies in the US. If these should spread they could affect the dollar price of the major metals and minerals on which the fortunes of the group largely depend.

Internal and external uncertainties make it difficult to forecast group performance. But Mr Hofmeyr believes that "September 6 1989 could prove to be the day on which South Africa set out on a new course which could, with goodwill and reasonableness on all sides, lead ultimately to the establishment of a non-racial democratic society."

W. Mail

29 Sept - 5 Oct 1988



210

TWO-METRE high fences, rolls of razor wire, security checkpoints and queues of black workers with plastic identification bands on their wrists. These were my lasting impressions of a visit to the President Steyn Gold Mine near Welkom this week.

A NUM organiser called *Mancane*, a nickname he has earned for being short and slightly built, agreed to accompany the *Weekly Mail* on a tour to investigate union claims of endemic racism on the mine.

My first mistake was to arrive at the union offices in Welkom in a vehicle with the newspaper's name painted in bright blue on the side of the door — *Mancane* assured me that was the quickest way to attract some unwelcome attention

The only solution was to buy some white paper and tape and cover up the signs before setting out on our visit to the mine's three operating shafts.

We started at Number Four Shaft, where we found three black mine security officials dressed in paramilitary uniforms "*Wena aikhona ngena lapha* — you cannot come in here," was their response to our request for entrance to the shaft.

The small entrance was flanked by a two-metre fence topped with a roll of razor wire. A row of workers, each with plastic bands strapped to their

'We are like slaves... we are known by numbers'

Separate lift cages, inferior canteens, discriminatory treatment and racist attitudes. These are some complaints voiced by miners amid strict security and razor wire fences.

By VUSI GUNENE

wrists, waited outside the gate. As they passed the guards, they raised their hands to provide the identification required to enter the mine

A group of women sat on blankets next to their belongings on the lawn. "These people come looking for their husbands and usually the security officials call the miners on the public address system. Then these women have to wait for hours, and if the particular worker does not arrive they are told to leave the compound. There is little provision for them despite the fact that some of them might have travelled a long way," said *Mancane*.

We proceeded to Number One Shaft, where we met a group of union members, including Joseph Nya-

lunga, a member of the shaft stewards' committee.

"Brother, life on the mines changed drastically after our strike in 1987," said Nyalunga. "You see this wrist band (pointing to it). It has a code number. We are like slaves and we are known by our numbers.

"When we go for our shifts, we have to queue and show our wrist bands to security guards at a gate that can only accommodate one person — even though the security personnel had known us for as long as we have been employed here.

"Then from there you have to go through another security checkpoint leading underground. This is a sophisticated system and you need to have a computerised identity card together with the wrist band."

Further investigation revealed that while white workers also carry magnetic identification cards they are not required to wear armbands.

"From there we have to wait for the lifts at the crush station," said Nyalunga. "Ours is called a 'cage' and has three decks, with each allowing

for 35 workers. But often it is overcrowded with numbers varying from 45 to 50 each deck.

"Next to it there is a lift called 'Miriam' — it is small and used only by white personnel and team leaders. It has only two decks that accommodate 10 people each.

"Our cages leave at certain times while Miriam has no time constraints so that white workers do not have to wait for a long time to get to the surface at the end of a shift."

Workers also complained of racism underground. "Sometimes we miss our breakfast and take *phuzza mandla* (a mixture of sour mielie meal and sugar) which we mix with water and it sustains us for a long time. But underground you cannot eat. You will be told '*Sikhathi wena sebezana, wena ayikhona edla* — this is no time to eat you must work'. Yet white workers can take lunch boxes and flasks of tea with them underground."

Another major grievance relates to allegations of long delays in getting workers who are injured or get ill underground to the surface caused by careless attitudes amongst white supervisors. "If you get sick underground the white personnel accuse you of having a *babalalas* (a hangover) — but the whites get out very quickly when they are sick."



Conditions for black and white miners are very different

After a shift black workers are forced to eat in canteens far inferior to those frequented by white miners and team leaders, said a worker who introduced himself as Simon.

"In the dining rooms at the compound our diet is controlled like in prison. You only eat during certain hours. If you miss a meal it means you have to go hungry."

"And you cannot buy food and eat it inside the hostel. Management says that if we eat in the rooms we would make the hostels a health-hazard."

Warnings are given to workers who lose their monthly meal tickets and a worker who loses these twice during a month stands a chance of being dismissed, the workers alleged.

At the start of the campaign by black miners to defy racist regulations on the mine, management reacted by using security personnel and patrol dogs outside the canteens, toilets and change rooms, the workers said.

"One worker was mishandled and taken away on the second day of the defiance campaign while sitting in the

white canteen," said an old man called Shabangu. "But this won't stop us from fighting for normal race relations on the mine."

The Anglo American Corporation declined to comment on allegations raised by workers at President Steyn Mine and said allegations should be handled by NUM and management.

MINING — GENERAL

1989

OCT. — DEC.

DIAGONAL STREET BY

JULIE WALKER

WHEN one of the major mining houses overruns a development budget, institutional investors shrug it off. They believe they will get their money's worth in the long run.

When a min-mining house overspends, the same investors give the directors a roasting for frittering away shareholders' funds. Is it fair?

Take the example of Pietersburg gold mine Eersteling, which released its 1989 report this weekend. When the mine was listed, management company Severin Mining & Development (SMD) had owned the property for fewer than six months.

BUOYANT

That is not a long time to quantify an orebody. So because there was limited knowledge, a modest R24-million was raised to develop a small operation.

Perhaps SMD rushed in, but it took advantage of a buoyant stock market which collapsed only three months later.

By way of comparison — which I know can never be direct and people can always find excuses to shoot down such comment — a prospecting team spent seven years at Barbrook near Barberton. Barbrook was launched jointly by Rand Mines and Anglo American — two of SA's respectable biggies. Rand Mines manages it. By the time Barbrook

Rough Justice for Eersteling

S/T was 1/10/89

210

reaches full production of 25 000 tons a month it will have spent R120-million. It raised R31-million when it listed. Eersteling has spent about R55-million for a capacity of 20 000 tons a month. Yet Barbrook's market capitalisation is R327-million, whereas that of Eersteling is only R46-million. This is not to knock Barbrook, it merely illustrates a point.

More to Eersteling's credit is that SMD has been a major lender of R12-million to the company at below market rates. Using one's own money to back a project deserves more acclaim than using anonymous institutional funds.

LABOUR

Now that the Franka shaft has been completed production is building up at Eersteling. Chairman Steen Severin says in his report that the target should be reached early next year.

It appears that SMD learned as it went along at the mine. The original plan was for a dinky shaft system

which made no allowance for expanding.

Expansion would have involved a sub-vertical and even tertiary system. Because it takes 90 employees to operate a shaft, labour costs would have soared.

When the orebody's potential reserves became proven, a decision was taken to put in a proper shaft system. It will allow 20 000 tons a month to be hoisted — and the shaft can be deepened at the same time.

Even though double the amount of capital raised has been spent, it looks like a classic case of a stitch in time saving nine.

The company has also found that the percentage payability is higher than originally forecast.

Not too much is mentioned about the grade, but if the mine can produce 650kg of gold from 170 000 tons milled as it intends to do, the recovery will be a reasonable 3,8g/t. The orebody is spradric in gold content.

The plant has worked well, and Eersteling expects the current year's capex of R4,7-

million to be financed from operating profits.

So, at Eersteling almost everything in the bushveld is flowering. The shaft is tops, the plant's fine, the grade's okay, the workforce is working. The thorny issue is borrowing.

The poor gold price coupled with crippling interest rates put Eersteling in a spot. At 20% prime overdraft, the amount of debt grows by a fifth every year.

RIGHTS

Debt can be likened to short-term finance, but at these rates it can be considered at least a medium-term proposition to repay the outstanding amount before a dividend can be considered.

Long-term equity finance lasts forever, but a rights offer is likely.

Again on the plus side for the management, it did not rush to the shareholders for more money before it had something to show them.

There are 9 500 shareholders, nearly half of the shares being held by SMD and direc-

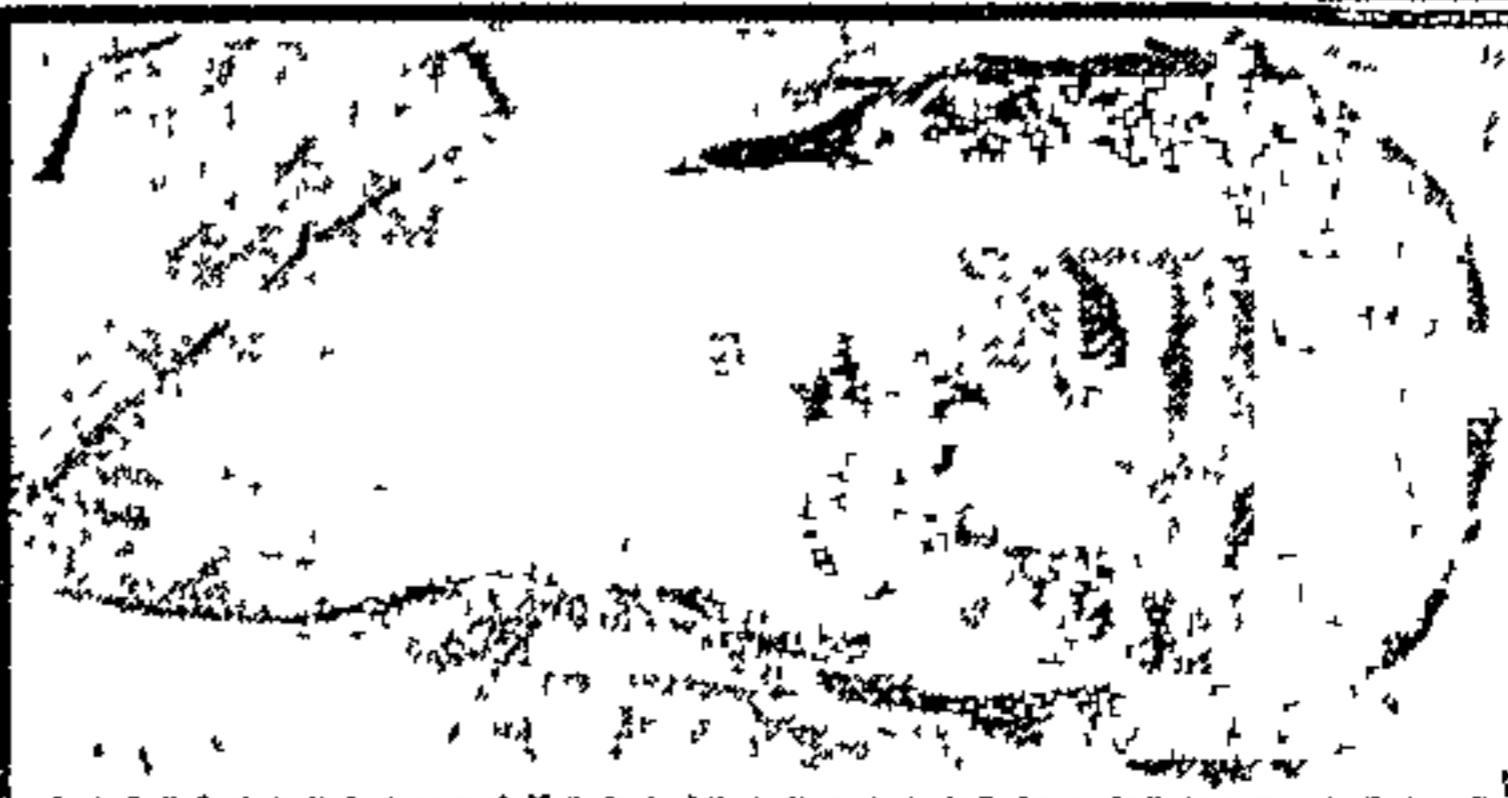
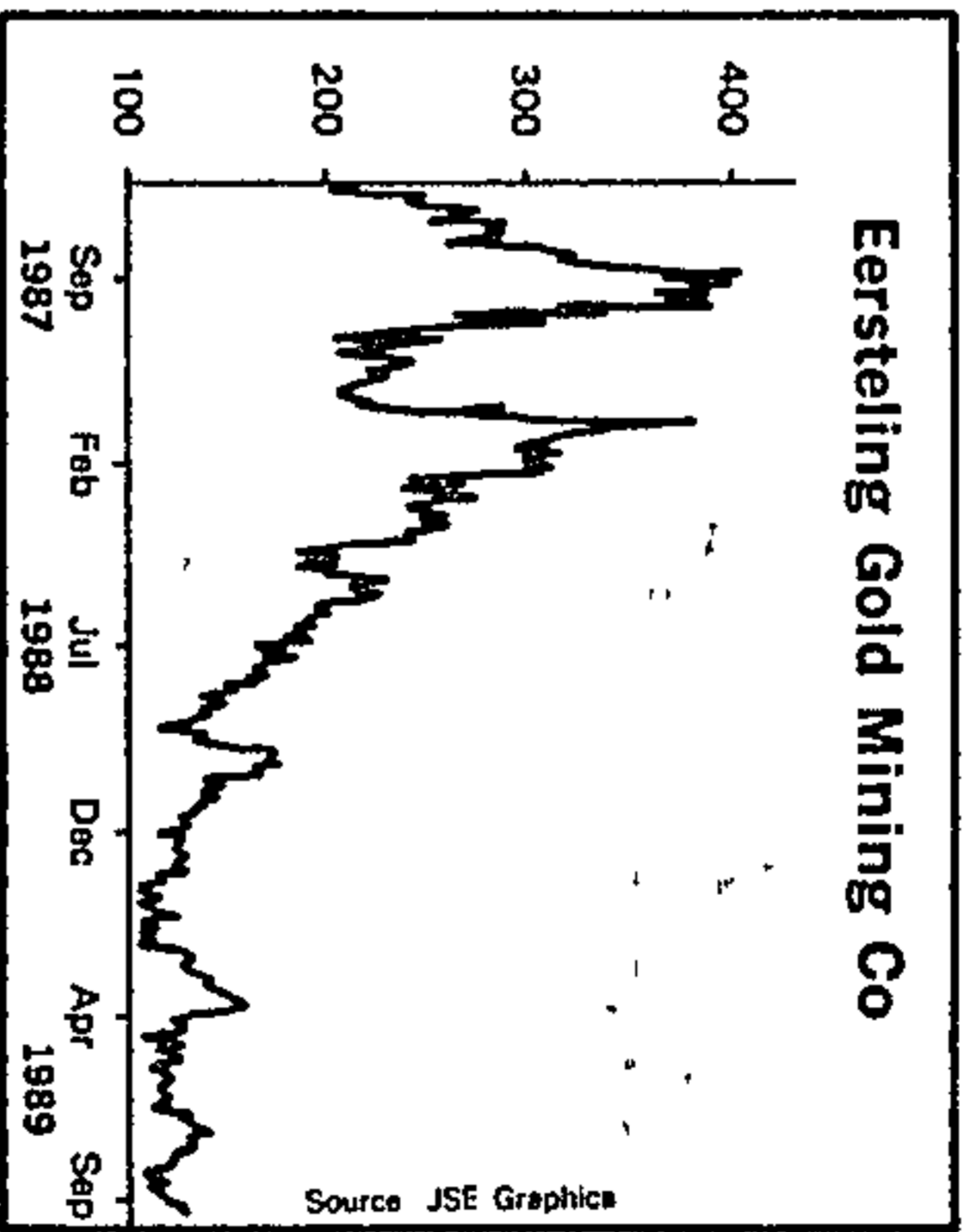

tors. Staff are encouraged to own shares.

Eersteling's share price is 115c, down from the 172c of a year ago but off the May 1989 low of 100c.

The mine is in a position to make profits without a high gold price — that would be a sweetener.

The management deserves credit for sticking at it through the difficult times, and minority shareholders should see some light at the tunnel's end. After all, the tunnel is hardly two years old.

Time off

THE JSE will be closed on October 9, the Day of Atonement.

Little business is done on working days which fall between weekends and public holidays and Tuesday, October 10, is Kruger Day.

Fedfood at R10 is peanuts

S/T was 1/10/89

FEDFOOD has fed many people through its five sectors of activity since it was started in 1977.

But managing director Jan du Toit is bothered because more than 40% of Fedfood's turnover comes from supermarket chains, the balance from 30 000 small retailers.

Nola, Ruto and Golden Harvest Cereals

Sumba is the Fedsnacks division and SA's leading producer of chips, rusks and peanuts. The promotional lion must be one of the best-known characters in advertising.

South Africans eat only 0,8kg of snacks each a year, whereas the Americans chomp nearly 6kg. I bet the

reduction of 20 percent in the number of counters. Mr Thomas says, liquidity is down somewhat in all... from the Sanlam stable have continued to bound ahead Sanlam Trust declared a 34.9c per unit dis- was 47 percent, after slightly reducing liquidity over the quarter from 28 to 25 percent

c-
P
le
P-
T-
r-

Aussie magnate linked to SA

The Star's Foreign News Service *SAV* Poseidon

MELBOURNE — Australia's business daily, *The Financial Review*, has questioned the South African influence behind the country's newest mining entrepreneur, Robert Champion de Crespigny

The paper says Mr de Crespigny describes the holdings as merely a "passive investment", but it adds "Speculation persists that South African interests may be more active than the minority shareholding suggests."

It says the rapid rise to prominence of Mr de Crespigny and his company, Normandy Resources, has "dazzled the Australian mining community"

A Melbourne accountant, Mr de Crespigny, 40, has made extraordinary progress in the last four years

It says the rise has "fuelled speculation about the extent of Mr de Crespigny's links with Harry Oppenheimer's Anglo American empire"

He has turned Normandy from a minor, R6 million loss-making company into a R1.5 billion gold, diamond and silver mining empire

It says it is well known that Anglo has a 10 percent stake in Normandy and that the Oppenheimer conglomerate has six percent of Normandy's major subsidiary,

The Financial Review suggests the South African interests, who had difficulty recently investing in Australia because of apartheid, have finally found a way to do so through Normandy

Uniserv expects offshore benefits

By Sven Lünsche
Over 20 percent of Uniserv's earnings in the financial year to end-February 1990 are expected to be derived from offshore interests, the company states in its interim report released today

that the acquisition of various foreign companies in March this year already boosted both earnings and net asset value by 12 percent over the interim period.

The directors state that during the interim period the rationalisation costs of the merger were higher than expected and had a negative impact on earnings, but that the problems had been resolved.

Reporting a 130 percent rise in attributable income to R4.29 million for the six months to end-August, the directors say

More benefits are expected in the near future from the operational and financial rationalisation benefits achieved through the merger of Uniserv and Sun Sky Courier

Although distributable income rose by 129 percent, earnings per share were only up by 36 percent

10/10/89

B/Dcn 4/10/89

210

Mineral exports fall in dollars, rise in rands

DURBAN — Mineral exports this year are expected to fall by 6,7% in dollar terms (to \$11,2bn) but rise by 10,1% in rand terms (to R30bn), the latest study from the Minerals Bureau shows.

Total sales should amount to R37bn (\$13bn), which compares with R33,6bn in 1988 (\$14,8bn)

Most volumes will be similar to those in 1988 with the exception of expected large reductions in sales of antimony and tin concentrates and rises of between 9% and 13% for copper, iron, manganese ore, dimension stone, aluminosilicates and tin.

Most of the 29,8% increase in sales is expected from non-gold minerals while gold should earn R20,1bn — based on an average price of \$385/ounce — up slightly from 1988s R19,6bn.

Gold mines are expected to mill more ore but at a lower grade to yield 608t, which will be 1,7% down on 1988. Gold will be responsible for 67% of SA's mineral exports.

Dollar earnings for silver should be 9,5% down and for platinum-group metals up by 12,4%.

Own Correspondent

The bureau says that interest in platinum continues unabated with a wide variety of buyers and users. The price should rise by about 20% (in rand terms) and 1,7% in dollar terms, which would see a rise of 24% in rand earnings and 5% in dollars.

Silver

The situation for diamonds is positive with increased demand being shown and a growth, since 1985, from four years of depressed sales "Appreciably" higher rand earnings are forecast

Interest in silver is falling with the gold price and the price is predicted to be 7,5% down on 1988 — the weakening rand should lift rand earnings by 6,7% to R79,7m

Coal exports did not fall as expected (an anticipated world surplus) but increased to 43-million tons from 42,4-million tons in 1987 as global demand for steam coal for power stations rose. This situation is not expected to change this year.

Expectations are for sales of 43-44-million tons in 1989

The bureau says export sales of antimony and zinc concentrates are likely to slump as local processing is rising

Western crude steel production should taper off in 1989 and ferromanganese and ferrosilicon export volumes should be marginally lower — also because of high prices

Iron and manganese exports are expected to continue expanding but chrome ore and chromium alloys are expected to grow marginally The dollar price for the alloys, at \$785 a ton, is about 39% higher than in 1987.

Total ferro-alloy tonnage and earnings at R3,3bn will be 57% higher and 33% up in dollar terms

Among the other processed minerals vanadium compounds and phosphoric acid are likely to perform well Vanadium supplies from other countries have either decreased or ceased altogether, putting strong pressure on SA supply sources

Total processed mineral exports should rise sharply (by 79%) to R6bn, or 52% up in dollars to \$2,2bn.

Bleak prospects damp celebration

SA'S powerful Chamber of Mines this week celebrated its 100th anniversary amid concern over the future of the nation's vital gold industry, which is being battered by the weak bullion price

SA's six big mining houses, which formed the chamber in 1889, face one of their toughest challenges yet because of the weak price — currently \$366 — falling gold production, escalating working costs, and the threat of closure hanging over many uneconomic mines

The bleak prospects cast a pall over yesterday's celebrations as mining executives pondered strategies to revive the flagging fortunes of the gold mines, which are among the world's deepest, most dangerous and expensive to run

"About half of the chamber's 33 producing member gold mines could be threatened in the next year or two unless the price improves or other factors come into play," said outgoing president Colin Fenton in his latest annual address

"Whereas up until 1985 SA was the lowest cost producer of gold out of five major gold producing countries, in 1987 it became the highest of the five," he said

The discovery of the fabulously rich Witwatersrand gold deposit in 1886 turned SA, a remote corner of the British empire, into a storehouse of wealth to rival India as the jewel in the imperial crown

In 1889 the Chamber of Mines was formed to promote mine-owners' interests

But SA's position as the world's leading gold producer has been eroded in recent years by steadily declining output and the discovery of new mines in the US, Australia and places like Papua New Guinea

Last year, total gold mine production in the Western world rose 11% to 1 538 tons,

the highest level ever recorded SA's output was 621 tons — 40,4% of the total compared to 70% in the 1970s and more than half in the early 1980s

The US was the West's second-largest producer with output rising by a third last year to 205,3t from 154,9t in 1987

Australian production jumped 37% in 1988 to 152t, according to an authoritative publication on gold by Britain's ConsGold

The production decline has had a big impact on the domestic economy, heavily dependent on gold for about 40% of total exports

Mining executives are confident, however, that the industry will weather the crisis and that SA can retain its position as the world's biggest gold producer

"We are very aware of the difficulties that the mines are facing, but we have also accepted that we are in a cyclical industry," said Chamber of Mines GM Tom Main.

"The SA gold mines are a long-life industry. An awful lot of our mines have been going for 40 or 50 years, whereas the new mines in other parts of the world have relatively short lives of five to 10 years"

Mining analysts say SA's strongest and richest mines can more easily ride out the gold price weakness than marginally profitable mines, which depend on high prices to sustain their demanding capital expenditure programmes — Reuter



● FENTON

NUM to march on Chamber's 100-year party

By VUSI GUNENE
and EDDIE KOCH

THE Supreme Court ruled late last night that a planned march by some 10 000 National Union of Mineworkers members (NUM) to protest against the Chamber of Mines' centenary celebrations could go ahead at the end of the month.

The union had planned to stage the march through the streets of Johannesburg tomorrow. But the Johannesburg city council prohibited the protest earlier in the week.

"Any march of such magnitude in the central business district will cause total disruption of the normal business activity," the council said.

The court decision that the march could go ahead on October 28 was the outcome of an urgent application by the NUM against the ban. Union press officer Jerry Majatladi said the union would accept the new date as this fell within the period of the Chamber's celebrations.

NUM executive members, including president James Motlatsi and general secretary Cyril Ramaphosa, will lead the march from the University of the Witwatersrand to the Chamber's Hollard Street offices.

NUM says the Chamber has spent thousands of rands on newspaper and television advertisements "to glorify the supposed economic wonder performed by it." yet earlier this year the refused to increase mineworkers' wages on the grounds that it could not afford to do so. "Mineworkers have nothing to celebrate since their experience in the past 100 years has been that mass retrenchments, mass dismissals, assaults by mine security, union bashing, working in unsafe places."

Since its inception the chamber has practised wage discrimination, with white miners earning 11 times more than their black counterparts from as early as 1911, it said.

The Chamber of Mines said in a statement last night: "On the basis that while the Chamber does not agree with what the NUM says but defends its right to say it, the Chamber welcomes the fact that it appears the NUM will be allowed to hold a protest march."

But the organisation rejected union claims of racism on the mines. "These allegations have no credibility when tested against the successful record of action by the Chamber over the past decade especially to eradicate discrimination in employment."

The Chamber noted that this week it had won an industrial court case challenging the white Council of Mining Union's refusal to admit black em-

'Mine closures will lead to forex losses'

Day

7/11/89
210
RIAAN SMIT

SA WILL suffer huge forex losses through the closure of gold mines and lack of development of new gold mines if government does not soon clarify the future tax dispensation of the industry, Old Mutual economist Rian le Roux warns in a report released last week.

The short-term loss of tax revenue is unlikely to be significant compared with the longer-term benefits to the exchequer accruing directly and indirectly from new large gold mines, he argues.

"In any case, total tax collection from the gold mines has declined very significantly in recent years from R2,4bn, or 18,6% of total central government tax collections, in 1980, to R1,8bn or 4,5% last year," he says.

SA gold production has declined 40% from a peak of 1 000 tons in 1970 to 620 tons last year because of a large drop in the average grade of ore milled, he says.

While the volume of ore milled has been on a consistently rising trend since 1970, the average grade has dropped from more than 13g/ton to around 5g/t at present.

"With the increasing depletion of higher grade ore, indications are that the deteriorating trend in South African gold production (both in absolute terms and relative to its international share) will continue.

He says that, given present conditions, large further declines are projected into the next century.

Although spending on exploration has increased more than six-fold from around R50m in 1980 to more than R320m last year, new mining ventures hinge on the following factors

□ It takes roughly eight years or more for a new project to reach the stage where gold production actually starts,

□ Prospects in the medium term for any major renewed bull market in gold are limited,

□ The exchange rate, which is particularly significant given a background of high domestic inflation and rapid increases in domestic production costs

Le Roux says that, in the absence of any meaningful rise in the international price of

gold (or a marked reduction in the domestic inflation rate), the authorities should take cognisance of the potentially serious financial squeeze to which the gold mines could be exposed because of the strong increases in domestic production costs.

"The authorities should incorporate in their exchange rate strategy the need to ensure the continued viability of existing and potential new projects."

He says special tax policy for gold mines could be devised to deal with this.

SA will suffer a forex loss equivalent to the total annual foreign debt repayments inside the net over the past three years unless government eases the tax dispensation for gold mines.

This amounts to \$400m annually if two marginal old mines and three at break-even are forced to close.

Although the Marais Commission on mining has proposed a number of changes to the present tax system applicable to gold mines, government has not made final decisions on a number of the recommendations, he says.

South Africa vs World gold production

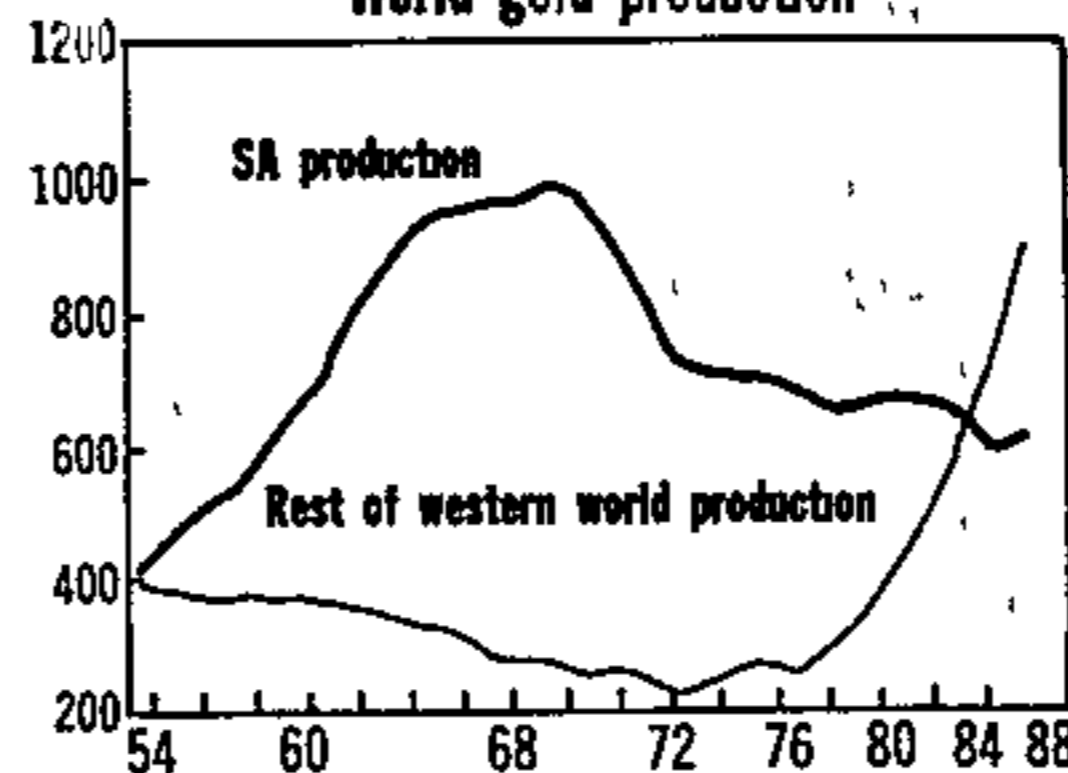

Graphic: LEE EMERTON Source: OLD MUTUAL

B/Day 13/10/89.

~~210~~

210

Mining taxes in need of reform in three areas

THREE areas of essential mining tax reform were identified at a conference in Johannesburg yesterday

Anglo American group tax consultant Marius van Blerck called for

- Further phasing-down of mines' marginal rates to achieve neutrality with other economic sectors,
- Relaxation of ring-fencing, and
- The exemption of certain classes of share transactions from capital gains tax

In the past 10 years the top marginal rate on gold mines had increased from 63% to 75%, the flat rate on diamond mines from 47,25% to 56,25%, and the flat rate in respect of other mines from 42% to 57,5%, compared with the current corporate tax rate of 50%. With royalties payable to the state, the effective rate for gold and diamonds was about 80% and 60% respectively, he said

In the past, the imbalance did not impose too much hardship because profit margins were high, but since 1979 mines' margins had come under pressure from higher taxes to fund rising government spending; from softening

JOHN STEWART

commodity prices and from declining grades and rising costs in the gold sector

While reforms had been initiated in the 1989/90 budget, Van Blerck suggested that ordinary company tax should be lowered to 40% and that the mining sector phasing-down schedule should aim at the new target

Decreases

A major constraint to mining industry growth, he said, was the introduction in 1985 of the ring-fencing provision that capital expenditure on a particular mine may only be set off against income from that mine. Even worse, expansion costs by a mine into an adjacent area were not deductible from its mining income if the expansion was deemed to be a mine.

"The latter effect dramatically decreases the rates of return on new mining projects and, unless relaxed, will simply rule out a number of the proposed new mining developments

brokers are so fond of speculating about," he said

In theory, the Receiver had the right to overrule this ring-fencing provision, but in practice this was seldom done because of the rationale for the provision to protect the tax base from fast rising mining capex costs

A compromise that presented itself would be to set off 60% of a mine's expansion capex against its tax base, provided that the reduction would not reduce the tax base by more than 30%, and a capital allowance of 10% applied against the remaining 40% of the cost of expansion

Finally, Van Blerck said many companies, including mining houses, with substantial share investments from past "greenfields" investments were inhibited from disposing of such investments because the gains might be taxable in full if held to be of a revenue nature. This fear was largely responsible for the relative illiquidity, or inertia, of the JSE. This could be overcome by a low-rate tax on real profits derived from share transactions, with an adjustment reflecting the period of holding

Unit trust managers are likely to stay in equities

B/Day 13/10/89

210

HIGHER interest rates and the 6% decline in the JSE overall index over the past two weeks are unlikely to influence unit trust managers to switch out of equities into fixed interest securities

That is the view of Unit Trusts Association chairman Roy McAlpine, who said in an interview yesterday, after the release of the association's quarterly statistics, that managers would probably not meaningfully reduce the equity content of portfolios in favour of cash or fixed-interest-bearing stock

The majority of fund managers would not be influenced by short-term market movements

While the equity market had taken "a bit of a breather" over the past few weeks, this had to be seen in the context of its sharp upward movement over the past



● McALPINE

SYLVIA DU PLESSIS

year "The public invests in unit trusts because they believe a portfolio comprised mainly of equities will achieve their long-term investment objectives of a return — capital plus income — in excess of the rate of inflation"

McAlpine said the performance of SA's 31 unit trusts over the past quarter illustrated the public's increasing awareness of their merits as a long-term investment

The statistics showed the combined market value of unit trusts grew to more than R6bn for the first time during the September quarter. This compared with the R5,6bn recorded in the previous quarter and represented an increase of 52,8% over the R4bn-mark of a year ago.

The industry attracted R153,2m in new money against the June quarter's R106,5m, in response to unit sales of R352,8m (R333,8m) and repurchases which declined to R199,6m (R227,3m)

McAlpine said the performance of the general equity trusts, which had achieved an average compound annual return (capital plus income) of 26,8% over the past

five years, reflected the long-term benefits of unit trust investment

The latest market value of the 13 general equity trusts was R4,7bn against the June quarter's R3,9bn. About 83% of the funds' assets were invested in equities, with 16% held in liquid assets and 1% in other assets

The largest percentage of the funds' assets (47%) was invested in the industrial sector, with 18% in mining financials and 12% in other minings

The R1,1bn combined portfolios of the 10 specialist equity trusts were invested mainly in the mining area — 24% in the gold sector, 24% in mining finance and 17% in other mining counters. These funds held 14% (R156,2m) of their combined portfolios in the form of liquid assets

McAlpine said the long-term performance of these trusts, which had produced a compound annual average return of 21,4% over the past five years, had been "very satisfactory"

The eight high-income trusts held assets with a total market value of R263,9m. These funds achieved an annual average total return of 15,1% for the past year

210 B.Saw 28/11/89

NEWS FOCUS

Rand Mines picks platinum route

BARLOW Rand chairman Mike Rosholt has sent an unambiguous signal to investors about the future of subsidiary Rand Mines, and of the R26bn-a-year parent itself platinum.

Analysts who have watched the development of the group's platinum interests with scepticism over the past two years may do well to heed Rosholt's signal.

The disappointments of the past — in the wake of the Loucas Pouroulis debacle — unfortunately spilled over to the new owners of Lekko-chrysos.

The mine, near Brits, was recently renamed Crocodile River, in an attempt to dissociate the company from its past.

Analysts have questioned virtually every technical and financial detail of

REINIE BOOYSEN

Crocodile River, and of the sister mine being developed at Kennedy's Vale in the eastern Transvaal.

But at the end of the day what really counts is the word of one man — Mike Rosholt. For he, like the directors of Rand Mines, has realised that the mining house faces an uncertain future without a major change in direction.

Its gold mines are mostly in the dying phase, and it cannot bank on the extremely cyclical coal market to ensure its future without discomfort.

Rosholt says "In the major venture Rand Mines has finally chosen (Crocodile River and Kennedy's Vale), it is going the route not only of a grassroots operation but in a completely new field for the group — platinum. And so I think it is appropriate at this point for

me to spell out why we think the risks are justified and why we believe the platinum operations will be important to the future of the Rand Mines group, indeed of the Barlow Rand group as a whole.

"In fact, we see platinum not only as a new leg but also as the 'catalyst' which will propel the Rand Mines group into the 21st century as a leading SA mining house."

Platinum therefore enjoys possibly the highest strategic priority at Barlow Park. Come hell or high water, Rand Mines, and the mighty financial resources of its parent, will make it work.

As a street-wise investor recently put it "When you're looking at a mining share, you must first and foremost look at the big daddy. If he's got lots of torn, the share's okay. If not, forget it."

But the bottom line for many JSE analysts is rank. One analyst says "I doubt very much whether Barplats Mines (the holding company of Crocodile River and Kennedy's Vale) will ever be No 1. When we advise a client on a share, we inevitably ask ourselves 'is that the best share he can buy?'"

The biggest problem for most analysts is the prospect that the profit from Crocodile River, which will shortly come on stream, will be used to finance the development of Kennedy's Vale.

This appears to offend the predominant culture on the JSE, which focuses single-mindedly on the short-term dividend return of a share.

Rand Mines may not be the No 1 platinum producer, but platinum appears set to become an important source of revenue down the track.



● ROSHOLT... spelling it out

Gencor income breaches R1bn-level

Opt Trans 27/10/89
J10

Own Correspondent

JOHANNESBURG — Gencor has again backed up promises with results

Attributable income — for the 12 months to August 1989 — is in excess of R1bn for the first time

It rose by 46% from a pro-forma R720m for the 12 months to August last year (there was a change in year-end, from December), to R1,051bn

After taking account of the September 10-for-one share split, earnings a share rose from 73,5c to 105,5c. The dividend for the year — 34c a share — is as declared at the time of Gencor's R1,5bn rights issue, and 26% higher than the pro-forma 27c for the comparable period a year ago

Executive chairman Derek Keys said yesterday "the effect of the entrepreneurial mood which now prevails in the group can be seen from the results

"Our companies are achieving real growth and at the same time exploring exciting acquisitions and new challenges"

He said "in the year Gencor put the last bits of the appropriate corporate structure in place with the recognition of energy as a fully-fledged division and the creation of Genmin as an autonomous entity entirely responsible for all our mining, metal and mineral interests"

Genmin remains the largest contributor to profit and earned 55% of the total

Its contribution — R577m — is almost double the comparable 1988 figure of R299m and reflects the significant improvement in earnings by its chrome/manganese operation Samancor, and related businesses

Keys said large percentage improvements, albeit off smaller bases, were registered by platinum, coal and mineral sands

"A good management performance was achieved by the gold division which produced a maintained contribution, notwithstanding many generally unfavourable external factors"

Pulp and paper producer Sappi was the second-largest contributor to group profit, with attributable income of R276m or 26% of the group total. This excludes R49m earned in the previous 12 months and not reported due to different accounting dates

Malbak achieved a substantial improvement in earnings but the rise in industries' contribution to Gencor is lower than the increase in Malbak's own earnings as there was some disinvestment in the year through Gencor selling certain of its holdings in Malbak for cash

Genbel and Gencor's investments contributed 17% or R181m to group income, a decline over the previous year which is mostly due to lower profits from the realisation of portfolio investments

Keys said "the testing times that lie ahead will require superior management so that the less favourable economic conditions do not impact too severely on the group"

He said "budgets indicate that we can maintain our earnings a share on the share capital as enlarged by the rights issue

"While this would not represent real growth in earnings a share on a year-by-year basis it would consolidate the quantum leap we took this year and keep us on a good longer term growth gradient. If our budgeted aim is achieved we will have no difficulty in increasing the dividend rate"

Drill breakthrough

Business Times Reporter

DEEP-level mining around the world could benefit from a South African-developed additive which will enable water to be more effectively used as a drilling fluid (210)

The additive will allow underground hydraulic drills to be powered by the static head of water available in most deep mines or from conventional power packs at the point of use

Rockdrill IR5 was devel-

oped by Karbochem at its Sasolburg factory in conjunction with the Chamber of Mines and equipment manufacturers

Tests show that when it is added to water, it is extremely effective in reducing wear, corrosion and biological contamination. Trials have also shown that IR5, which is oil free, does not have any adverse effects on gold or any other mineral recovery processes.

S/Twe, 29/10/89

B. Say 1/11/89

Amcoal profits up 64,6% *(9/10)*

ANGLO American Coal Corporation's (Amcoal) after-tax profit increased 64,6% from R79,4m to R130,7m for the half-year ended September 30

In its interim report the board says increased export prices and tonnages, a weaker rand/US dollar exchange rate, as well as higher cash deposits and interest rates were the main reasons for the significantly higher earnings

Earnings attributable to shareholders increased 72,3% to R129,4m (1988 R75,1m) and earnings per share at 517,8c (305,9c) increased by 69,3%

Amcoal earned 665,1c per share for the

RIAAN SMIT

year ended March 31.

The company declared an interim dividend of 125 cents per share (95 cents), an increase of 32% with 434 442 more shares in issue

The dividend cover increased from 3,2 to 4,1

Coal and coke sales for the half-year were down 8% to 21,8-million tons (23,7-million)

Sales to Eskom decreased by 12,3% due to the closure of Cornelia and New Largo

□ To Page 2

Mining dispute unfair — Mintek

By Winnie Graham

Dr Aidan Edwards, president of the Council for Mineral Technology (Mintek), believes mining companies are being treated unfairly because they want to extract titanium from the St Lucia Bay estuary and other South African beaches

"Where's the balance? I believe environmentalists have gone totally overboard in their attempt to stop mining operations on South African beaches."

Dr Edwards was commenting on the proposed mining of the St Lucia dunes as well as other titanium mining projects proposed along the South African coast

The mining industry, he said, was probably worth R1 000 million and a great earner of foreign exchange for South Africa.

He said he, too, did not want to see the environment destroyed, but neither did he believe 20th century people "with earphones on their heads" could go back to nature entirely. Things had to be kept in perspective.

"My challenge to The Star is to visit the Richards Bay Mining Company to see the reclamation work they have done after mining operations there. I have seen the



Dr Aidan Edwards . . . conservationists have gone overboard.

restoration work which is so thorough no one would know the difference."

He claimed the pine forests at St Lucia were "aesthetic pollution anyway". Far worse damage was being done by acid rain to the for-

ests of the eastern Transvaal than along the coastline.

Dr Edwards stressed no birds or animals would die in coastal mining operations.

"The mining will not be an overnight blitz," he added "It will take place over a number of years"

Small sections would be worked over two or three years and when the next section was started the sand would be replaced. Birds and animals would soon return

He said the media were doing to the mining companies exactly what was being done to South Africa overseas. The other side was not being given a chance to state its case because people were too belligerent to listen

He accepted that conservationists were entitled to state their case, but added: "Don't overkill"

Dr Edwards described titanium as a strategic material in the building of helicopters. It was strong and light and a necessary component in the construction of the blades. It was also the basis of all paints

"Titanium is found in the black grains of sand on beaches round South Africa," he added.

219

Star 2/11/89

R700m Anglo project for rezoned Kyalami

ANGLO American Properties (Amaprop) is to develop a R700-million project to the north and east of Kyalami race track

The decision follows the rezoning of Kyalami, north of Johannesburg. The motor-racing circuit may now be used six days a week and 17 races a year are allowed.

The area north and east of the track was bought by Amaprop five years ago for R12-million after owner Motorsport 2000 ran into financial difficulty and was forced to sell part of the property.

The track is now owned by Motor Racing Enterprises (MRE), a subsidiary of listed R100-million Entecor group, in turn a subsidiary of Tollgate.

The intention was to develop the area north of the track for housing. But the rezoning in favour of MRE has

By Don Robertson

prompted Amaprop to switch its plans and develop the area east of the track for housing.

The area north of the track will be turned into a light-industrial technopark and will be sold to companies allied to the motor trade.

Several motor and component manufacturers have applied for sites.

Noise

The first phase of the residential area will involve the sale of 217 stands of 1 200m² for about R65 000 each. Landscaping and services will cost about R40-million on 200ha. About 70 stands have been sold and houses are expected to cost at least R250 000 each, putting a price

on the area of about R200-million.

Investigations by Anglo American Property Services (Ampros) found that the noise caused by racing at the circuit would not be acceptable to residents. As a result, the developers decided to move the residential area to the east of the track. A wall to soften the noise has been built.

The northern area, 60ha in extent, will be developed as a technopark at a total cost of about R500-million after R60-million has been put in for services.

The Kyalami track itself will be developed. A nine-hole "target" golf course has been established. A cycling clubhouse is being built and the driver training skid pan will be opened soon.

MRE hopes to host a Formula One Grand Prix in 1991.

(910) S. Times 5/11/89

A SHOCK report on the parlous state of the gold-mining industry will land on Minister of Finance Barend du Plessis' desk this week.

A study by Old Mutual's mining and economic analysts warns that foreign-currency earnings of \$400-million a year — equivalent to total foreign debt repayments inside the net over the past three years — are at risk

This is the value of production of two mines which have applied for State assistance and three others which are operating at break even, says the report

The mines are being squeezed by soaring production costs and a low gold price. The study appeals for a tax break for the mining industry

Difficult

Government officials will not comment until they have read the report, but they say proposals by the Marais Commission on tax changes for the gold mines are being studied

The study says "The uncertainty regarding the future tax treatment of the gold mines merely serves to aggravate the already difficult task of assessing whether or not potential new ventures should be undertaken

"It will be in the interest of the industry as a whole to clarify as soon as possible the future tax dispensation"

Outgoing Chamber of Mines president Colin Fenton disclosed in June that the average production cost for gold mines last year was R695 an ounce — more than double the 1985 figure

He said SA had moved from being the lowest-cost producer among the five main gold-producing nations until 1985 to the highest-cost one in 1987

\$400m at stake as mines die

By Ian Smith

Old Mutual economist Rian le Roux says "Gold remains SA's largest earner of foreign exchange and is essentially immune to sanctions"

He says there has been only a moderate rise in the rand price of gold in the past three years — 5% from mid-1986 to mid-1989 — but production costs are rising rapidly. The average cost of milling a ton of ore jumped by 50% between the second quarter of 1986 and the corresponding quarter of this year

Mr Le Roux says "This has again raised questions about the future of the industry, particularly in the light of the rather unexciting prospects for the dollar price of gold"

Justifying a new tax strategy for the gold mines, the study says that SA cannot afford to treat net foreign-exchange earning industries, like the gold mines, in the same way as forex-consuming ones

"Unfortunately the present tax environment is in a number of ways more favourable to industry than to gold mining

"The higher marginal tax rate applicable to the gold mines compared with industrial companies and the fact

that in gold mining the tax base of one venture cannot be used to develop another are but two examples of this asymmetry

"The gold mines should be afforded a more favourable dispensation, particularly where this would encourage the development of new mines."

The short-term loss of tax revenue would not be significant against the potential longer-term tax flow to the Exchequer from development of large mines

Conflict

"In any case, total tax collections from the gold mines have declined very significantly in recent years from R2,4-billion, or 18,6% of total central Government tax collections, in 1980 to R1,8-billion, or 4,5%, last year."

Mr Le Roux says that although mines benefit from a falling rand, it could conflict with a determined anti-inflation drive in the short term

Gold production fell from 1 000 tons in 1970 to 620 last year, entirely because of a drop in the average grade of ore milled from more than 13 grams/ton to about 5g/t

"Given present conditions, substantial further declines are projected into the next century"

DE BEERS STRIKE

Claiming the spoils

The wage dispute between De Beers' mines and Cosatu's National Union of Mineworkers (NUM), which caused a national diamond mine strike, has been settled. The union accepted an 18% increase to bring the minimum wage to R653 a month.

In the final stages of negotiation the NUM had been pushing for a 26,6% increase. It started at 60% but assistant general secretary Marcel Golding claims the strike improved the confidence of union members, they have realised they can force De Beers to make small moves — away from a tradition of "making none at all."

The dispute prompted two three-day strikes (or six eight-hour shifts) by about

8 500 NUM members (the union claims 10 000, including about 2 000 sympathisers). Five mines and the De Beers geology division were affected.

The strike was suspended for a few days at the end of last month after the parties agreed to mediation. The union said De Beers had indicated it would improve its offer, which it did, from 17% to 18%. The union rejected this and resumed the strike.

It eventually settled, however, for the 18% increase together with a lump-sum payment backdated to May and recognition of June 16 as a paid holiday. The NUM also agreed to withdraw its demand for March 21 (Sharpeville Day) and October 1 (Kinross mine disaster) to be paid holidays.

Golding says that backing down on the wage demand was unimportant. "What is important is that, for the first time, we successfully shifted management's pre-strike position." He says concessions were a result of the NUM demonstrating it could bring out 98% of the work force and had the ability to use the strike weapon in a disciplined and tactical manner.

He says it was the company's agreement to backdate the offer, and grant the labour holiday, that made accepting 18% "a decision we could live with."

He adds the union was aware De Beers had stockpiled diamonds worth R4,8bn — enough to maintain sales for half a year — "but the company still responded to labour pressure. This included, at the height of negotiation, our refusal to endorse the company's exemption from the Basic Conditions of Employment Act — which provides that workers should have specific tea and lunch breaks."

"Normally, in terms of the exemption, they work up to nine hours at a time without these." However, the union continues to accept De Beers' exemption from the Act.

De Beers' industrial relations consultant Shane Leisegang says 8 100 employees went

on strike. "There are 9 900 employees in the bargaining unit, of whom 8 200 are NUM members, meaning that 82% of employees struck."

"At the final stage of negotiations, the NUM came down nearly 10% in its wage demand, while De Beers went up 1%. NUM had opened talks at 60% and De Beers at 10%. Obviously, the NUM will claim a victory, but it is untrue to say we offered June 16 as a paid holiday because of strike pressure. In fact, we made the June 16 offer before the conciliation board hearing."

"The strike cost them. They lost six shifts in pay. All the union got after resuming the strike was a uniform calculation of the lump sum, and not their demand to backdate the offer in its entirety — which would have included overtime pay, allowances, accumulated leave transmuted for cash, and pension contributions. The availability of the lump sum was conditional upon an early return to work."

Leisegang adds: "It is totally untrue to say De Beers' employees work nine-hour shifts without a break. For years they have been getting at least a 20-minute lunch break and two 10-minute tea breaks. It is a fairly informal arrangement as it is not possible to stop certain operations."

"De Beers is among the highest payers in the mining industry."

5/09/15/11/87

Anglovaal is to reduce number of share classes

 STEPHEN RICHTER 210

ANGLOVAAL intends to streamline and simplify its capital structure by reducing the number of classes of shares in issue from five to two. In addition, the mining house is to sub-divide its share capital.

Anglovaal's existing share capital comprises five share classes and the loan stock. The directors feel that by reducing the number of classes and sub-dividing the shares, their marketability will increase, while making it easier for the group to raise capital.

Therefore, Anglovaal plans to convert its "A" 50c ordinaries and the participating 5% preference shares into a single class of new ordinary shares of .01c each, to be known as "N" ordinary shares. The newly created "N" shares, together with the existing 50c ordinaries, will then be sub-divided on a 10-for-one basis.



An added feature of this restructuring is that the "A" ordinary as well as the participating preference shares only have limited voting rights.

But the "N" ordinaries will carry normal voting rights pro rata to their nominal value.

On March 31, Anglovaal will redeem the 6% preference shares at their par value of R2. But the 5% preference shares will be redeemed at a 20c premium above their R2 par value.

These redemptions will be made from retained earnings and take place independently of the abovementioned restructuring moves.

Redemption

As it now stands, loan stock holders are not entitled to participate in any Anglovaal equity rights offer.

But the directors feel that the terms of the loan stock should be amended to apportion future rights offers to ordinary and "N" ordinary shareholders on the one hand, and loan stock holders on the other.

This will be accomplished in a ratio proportionate to their respective total market values.

The redemption of both classes of redeemable preference shares will translate into a substantial premium above the last ruling market price. The preference dividends in both cases will be paid up to the March 31 redemption date.

The Anglovaal ordinaries and "A" shares both jumped 1500c yesterday to close at 42 000c on the JSE. The proposed sub-division will translate into a share price of 4 200c, which is much more attractive for the average investor.

To obtain a mere 100 Anglovaal shares, investors must currently shell out R42 000, compared to only R4 200 after the sub-division.

210 *Final* 17/11/89

SAMANCOR

Good for the long haul

Activities: Manufacturing ferro-alloys, mining manganese, chrome and other steel industry minerals.

Control: Gencor owns an effective 50% of the equity

Chairman: N C Officer, managing director H J Smith

Capital structure: 149,8m ords of 4c each; 268 000 part-paid ords of 4c Market capitalisation R2,8bn

Share market: Price 1 875c Yields 8,5% on dividend, 16,1% on earnings; PE ratio, 6,2, cover, 1,9 12-month high, 2 500c, low, 1 500c Trading volume last quarter, 1,72m shares

Financial: Year to June 30

	'86	†'87	‡'88	‡'89
Debt.				
Short-term (Rm)	59,3	21,6	45,0	63,4
Long-term (Rm)	55,8	37,8	27,7	12,3

Performance

	'86	†'87	‡'88	‡'89
Return on cap (%)	30,2	21,1	19,4	28,4
Turnover (Rm)	803	832	913	2 128
Taxed profit (Rm)	275,7	195,5	192,0	543,5
Earnings (c)	152,1	117,4	125,5	378,4
Dividends (c)	100	75	75	200
Net worth (c)	314	371	434
			434	630

* Thirteen months to March 31
 † Year to March 31
 ‡ Fifteen months to June 30

There is only one realistic way of evaluating Samancor as a long-term investment. The group has just completed its best trading period, with record sales and profits, but is close to embarking on a massive capital programme just as prices of ferro-alloys have weakened appreciably. If you can overlook possible short-term drawbacks, however, the share remains one of the better long-term investments.

The past 15 months' trading were outstanding. Ferrochrome demand and prices soared in the first half of calendar 1989 as world steelmakers scrambled for supplies and built inventories as a precaution against perceived shortages. By the second quarter, SA producers were selling ferrochrome at a record US\$84,5c/lb in the US, but by the third quarter had cut back to 82c with dire warnings from some producers of prices as low as 50c by early-1990. According to Met-

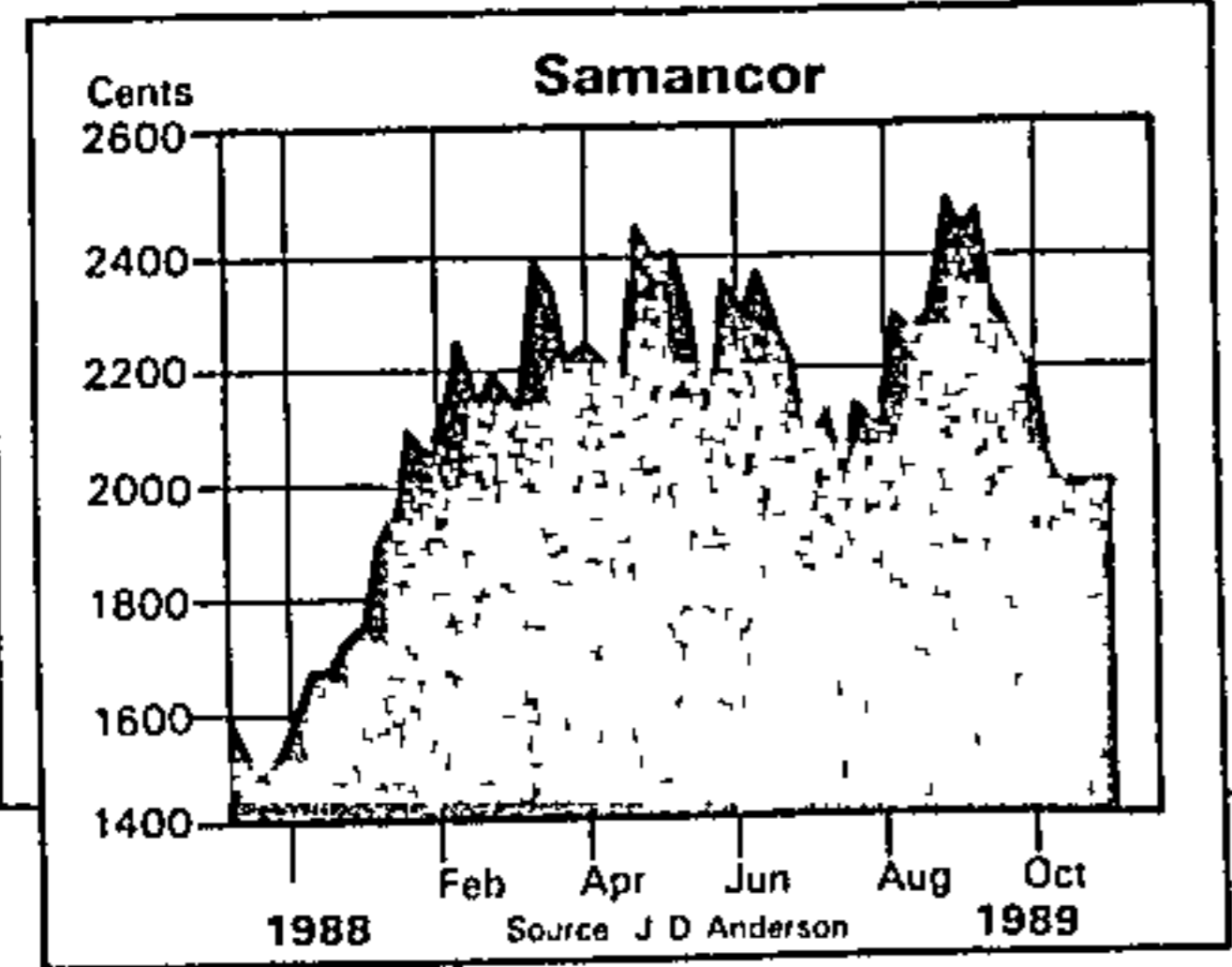

Samancor's Officer ... confident expansion

als Week low-carbon ferrochrome is now selling for as little as 62c in the US.

Chairman Colin Officer remains reasonably confident that progressive rand weakness will protect Samancor to an extent from lower dollar prices. Of course he needs to be confident. Samancor is completing major additions to production facilities that will lift annual capacity to 620 000 t. That capacity will not be fully available next year as, along with competitors, Samancor has been operating furnaces full-blast and deferring maintenance. Slackening demand will give breathing space to carry out periodic preventive maintenance.

The market is wary of the comparatively large additions to SA ferrochrome capacity coming on stream over the next few months, coinciding with de-stocking by world steelmakers. That is a short-term consideration and Samancor has plans to reduce its reliance on the comparatively volatile alloy business. Early in 1990 it will decide with Highveld on a joint venture to make stainless steel. Planning appears to be based on annual stainless capacity of about 300 000 t, which would absorb about 55 000 t ferrochrome and 15 000 t nickel.

Some competitors have pooh-poohed the idea, saying SA chrome-makers should not go into competition with major customers. That need not be taken at face value as output of crude billets is fully earmarked for Taiwanese steelmakers.

In manganese, the Mamatwan mine's sinter plant came on stream over a year ago and is delivering to Samancor's Meyerton ferro-manganese facility. Presumably manganese ore sales will flatten out or even decline as

world carbon steel production slows.

Samancor does not split the contributions to sales and profits of its various alloys and ores, nor does it disclose sales tonnages, so it is not possible to estimate with any accuracy the effect of lower ferrochrome prices and higher production of chrome and manganese ferro-alloys.

The past 15 months' 200c dividend includes 90c "extraordinary" payments, so presumably this year's payment could be reduced to 88c without implying a dividend cut. An 88c distribution is a 4,7% forward yield, not unacceptable given longer-term growth and development prospects.

Jim Jones

PUTCO *Final*

Ripe for break-up

Activities: Operating mass transport bus services in the Witwatersrand, Pretoria and Durban areas

Control: The Carleo family owns 52,5% of the equity.

Chairman: A Carleo; managing director J A Visser.

Capital structure: 26,43m ords of 40c. Market capitalisation R30m.

Share market: Price. 115c. Yields. 7,0% on dividend; 3,0% on earnings, PE ratio, 33,1, cover, 0,4 12-month high, 190c, low, 90c. Trading volume last quarter, 535 000 shares.

Financial: Year to June 30.

	'86	'87	'88	'89
Debt:				
Short-term (Rm)	0,4	4,0	3,5	2,3
Long-term (Rm)	60,8	51,0	nil	nil
Debt equity ratio	0,26	0,21	n/a	n/a
Shareholders' interest	0,64	0,66	0,68	0,66
Int & leasing cover	0,10	—	n/a	0,07
Debt cover	0,20	—	6,8	n/a

Performance.

	'86	'87	'88	'89
Return on cap (%)	nil	nil	7,7	(0,3)
Turnover (Rm)	299	285	302	346
Pre-int profit (Rm)	(8,0)	0,4	19,2	(0,8)
Pre-int margin (%)	n/a	n/a	6,4	n/a
Taxed profit (Rm)	(18,5)	(11,6)	2,4	0,9
Earnings (c)	(70,1)	(44,3)	9,1	3,5
Dividends (c)	nil	17,5	24,5	8
Net worth (c)	737	795	636	708

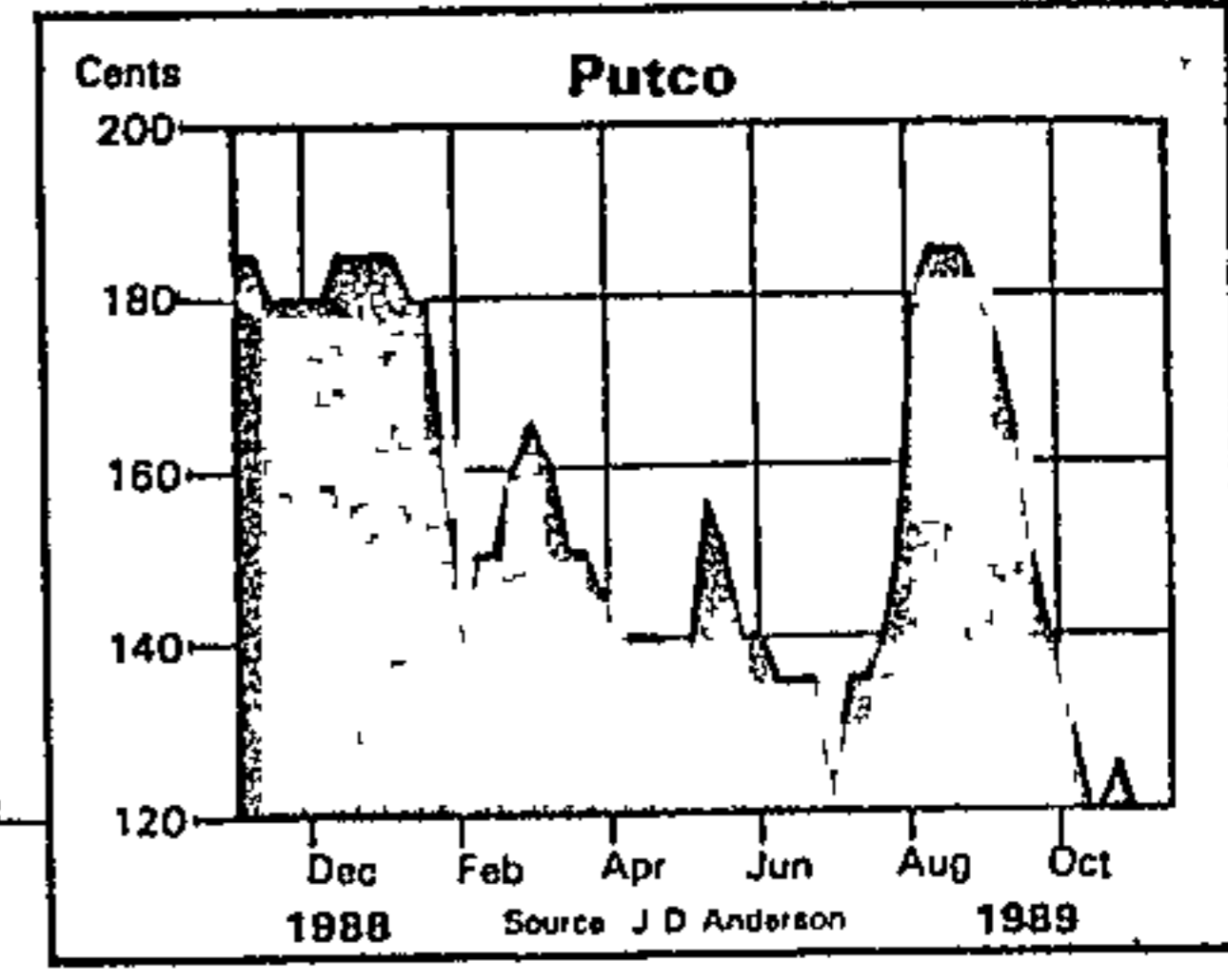

B/Day 24/11/89

Arban's performance dictated by Malbak

189 210

ANALYSIS: STEPHEN RICHTER

ARBAN Group Holdings is heavily involved in the mining industry and this should enhance the group's bottom line performance if the gold price continues to forge ahead. But for the time being, Arban's share price will be dictated by the movements of Malbak on the JSE.

Arban is committed to the gold and coal sectors, while the group's market shares in the base metals and platinum markets are improving rapidly. The Arban Engineering division has traditionally provided a range of conveyor belt maintenance and splicing equipment to most of SA's coal mines, and gold producers are using them more and more.

The Deebar and Martco divisions manufacture, market and distribute sophisticated electrical and electronic equipment to a significant number of gold and platinum mines. The coal industry is also making use of these products, while the group has found a significant overseas market in Australia.

The MCE division specialises in industrial process glassware and glass-lined equipment for platinum refining as well as other industrial uses.

Group MD Paul Langerman believes that the gold price must maintain its

current strength for another six to eight months before this will convince the mining companies to increase capital spending. If this occurs, he feels that there is growth potential in Arban's major businesses.

After financial 1988 results were affected by the sanctions imposed on the

the directors are optimistic that they will be able to pay a final dividend of approximately 3c a share.

Arban could therefore theoretically be selling for a much higher price than yesterday's closing level of 32c. This is because, at this level, Arban is selling on a forward earnings yield of 21,9c assuming earnings of 7c. The forward dividend yield is 9,4%. This represents good value for a company on the verge of benefiting from the improved outlook for the mining sector.

Unfortunately for potential investors, Malbak is also attracted to Arban and Malbak plans to make Arban the vehicle for its mining supplies operations. Consequently, Malbak took control of roughly a 50% stake in Arban effective October 1.

The purchase consideration will be settled by the issue of one Malbak ordinary share for every 24 Arban ordinary shares held. A similar offer will be made to minorities this year.

Using this formula, Arban appears to be selling at a slight discount in relation to Malbak, which closed at 850c yesterday. Therefore, Arban must rise to 35c for their values to be equal according to this formula.

The only way that Arban will show substantial gains from yesterday's closing price will be for Malbak's share to increase significantly. Otherwise, it appears that Arban should continue to trade around current levels.

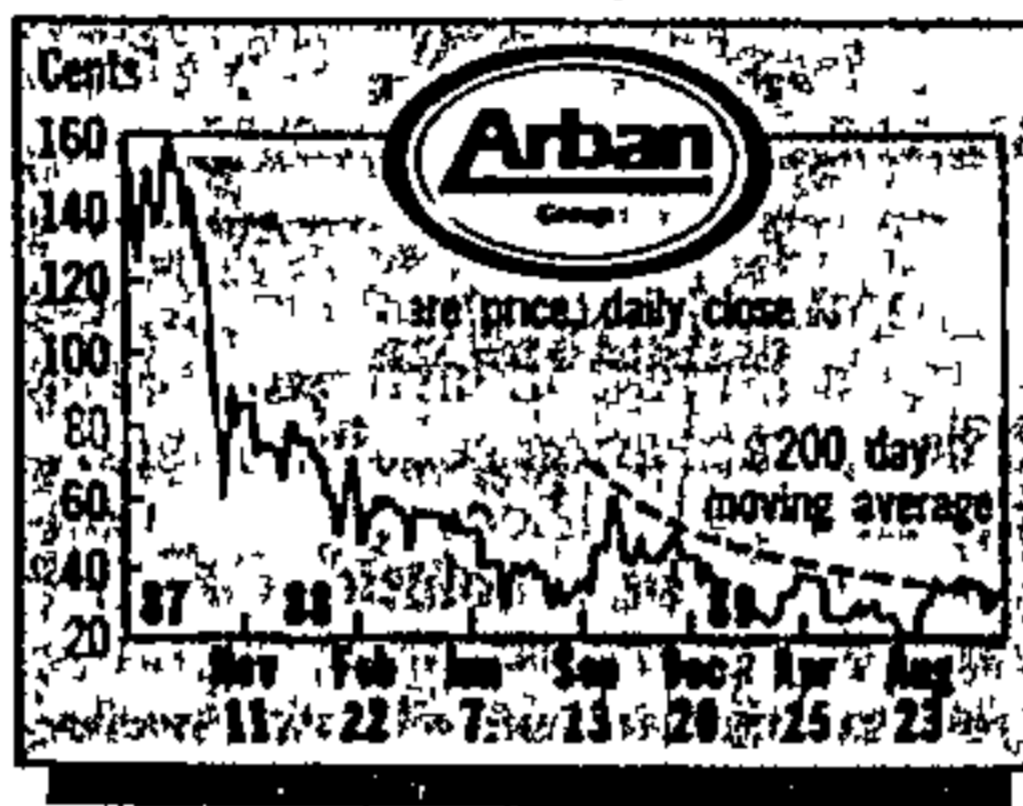

Graphic: FROM LUSCH Source: JSE

local coal producers as EPS dipped to 4,3c (8,2c), Arban's interim performance showed substantial improvement for the six months ended March as EPS recovered to 2,3c from 1,3c.

Langerman indicates that the group's recent restructuring (where it sold two divisions which did not fit in with its overall objectives), as well as the improved outlook for the local coal mining industry should allow earnings for the current financial year to recover to between the 6c to 8c area. Consequently,

A toast is in order, claims Chamber

210
Sowetan
04/11/89

This year marks the centenary of the Chamber of Mines. The National Union of Mineworkers (NUM) has dissociated itself from the centenary celebrations, saying black mineworkers have nothing to celebrate after what it termed "100 years of exploitation". The Chamber, in this article, contends that miners have much to celebrate



The Chamber of Mines claims that today there are about 5 000 blacks in the industry in jobs previously reserved for whites.

BORN partly through the representations of the Chamber of Mines to the Wichahn Commission a decade ago, the National Union of Mineworkers now chooses the Chamber's centenary to attack it and the industry it represents.

FOCUS

is not the foundation of apartheid but the economic system which has helped crack that foundation

From his opening paragraphs to the last (in a *Sowetan* article), Mr Cyril Ramaphosa's emotional broadside wildly distorts and confuses the facts

The Chamber's centenary is not the industry's. The current advertising campaign on television does not glorify the Chamber but pays tribute to the miner. The Chamber did not refuse to increase mineworkers' wages this year but negotiated increases of between 13 and 21.5 percent

There is no distinction between black and white wages but between skilled and unskilled Capitalism

Politics

To pursue a point by point rebuttal of Ramaphosa's rhetoric would be tediously unproductive while there are essentially two important points to be made

Firstly, Ramaphosa appears to have missed the new direction of politics in South Africa preferring to cling to the doctrine of irreconcilable conflict and a "revisionist" view of history which is as narrow and misleading as the view it is designed to correct

Secondly, with all its

pioneering warts, South Africa's mining industry is by any standards a practical celebration of enormous achievement. To paint it smaller is to under-rate the contribution to this country of the hard men from the four corners of the sub-continent who have laboured together to create an industrial revolution and tradition that has changed the face of this part of Africa forever

Lifeline

In the course of its history the industry has provided employment for an estimated 10 million black workers with extended families of perhaps 50 million. Their labour did not make them rich but provided an economic lifeline for some of the poorest areas of South Africa and the surrounding region. Today's requirements are for a more skilled labour force but job creation through expansion remains an industry goal

In the last decade the industry's opposition to apartheid has been expressed frequently and effectively. Its representations helped win full and equal trade union rights for all employees irrespective of race. Its efforts secured the abolition of the "scheduled person" definition from the Mines and Works Act, ending statutory job discrimination

The industry has also initiated legal action against Government and conservative unions over the training of coloured

winding engine drivers and the segregation of change houses. It has done so over restrictions on the number of people employed with blasting licences, which could limit the entry of blacks into jobs requiring this certificate.

Today there are about 5 000 blacks in the industry in jobs previously reserved for whites and employment is on the basis of equal pay for equal work

It has gone to court to achieve the admission of qualified blacks, Asians and coloureds to the Mine Employees Pension Fund

with the sometimes isolated location of mines the world over. They will continue to have a place in South Africa. But the industry is moving away from the migratory labour system with the progressive introduction of family housing and home ownership schemes, while hostel conditions and amenities have been continually upgraded.

South Africa has more than 90 percent of the free world's manganese and platinum ores, over 70 percent of its vanadium and chrome ores and a rich variety of other minerals

But gold is the basis of its mineral wealth, the ore buried deep in the earth's crust in narrow, broken seams embedded in the hardest and most abrasive rock known to man. The result is an underground environment unique in the mining world, and men who meet the challenge daily with innovative technology dedicated to safety and efficiency

Health

Over the years, the industry has been a leader in the health care of its workers bringing international experts to this country and helping to found the South African Institute of Medical Research to eradicate the lung disease of the past

The best possible treatment is afforded through modern clinics and specialist hospitals. Nowhere in South Africa has as much been done to identify the new scourge of Aids and in setting up monitoring and counselling systems.

Single-sex hostels go

Workers

South African mining employs nearly 750 000 people. It pays some R8 billion in wages, produces nearly 70 percent of foreign currency earned by exports and contributes about R4.3 billion in taxes. R10 billion is spent annually on local goods and services

The industry has promoted the development of road and rail networks, ports and power stations and educational institutions like the University of the Witwatersrand. East and west of Johannesburg and down to the Free State, many towns owe their existence to mining

There is much to celebrate.

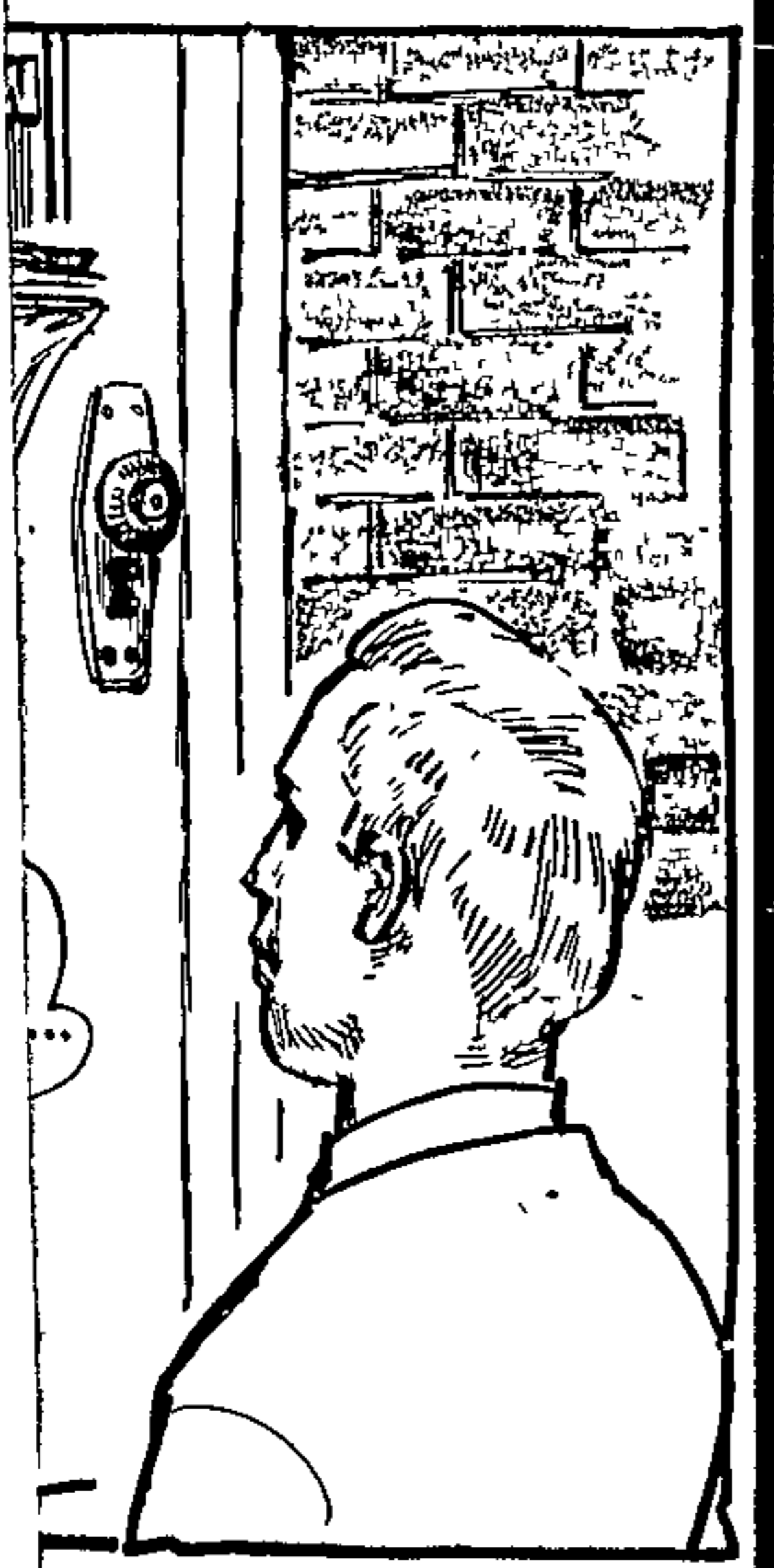

Political comment in this issue by Aggrey Klaaste and Joe Thloloe. Sub editing, headlines and posters by Sydney Mathaku. All of 61 Commando Road, Industria West, Johannesburg

The reproduction or broadcast without permission of articles published in this newspaper on any current economic, political or religious topic is forbidden and expressly reserved to The Argus Printing and Publishing Company Ltd under Section 12(7) of the Copyright Act 1978

• Write to the Editor at PO Box 6663 Johannesburg 2000. Nom de-plumes can be used but full names and addresses should be supplied or the letter will not be published



Graphic: FRANK MESSCH Source: JSE

Anglo ups six-month earnings to R599m

Business Day Reports (210)

ANGLO American's earnings for the six months to September were 31% higher, at R599m (R459m), largely as a result of improved performances by its diamond, platinum, base metals, coal and mining finance interests. *B/Dam 24/11/89*

Earnings a share for the six months were 260c (200c) and an interim dividend of 85c has been declared — 21% higher than last year's 70c.

Anglo's equity-accounted earnings increased by 29% from R1,018bn (443c a share) to R1,315bn (570c a share).

Directors say the rise in investment income, from R476m to R632m, was largely attributable to higher dividends from the mining, finance, diamond, platinum and base metals sectors.

The contribution from Anglo's gold and uranium interests to investment income fell from 38% (R181m) to 30% (R190m), reflecting "the impact of inflation on costs

□ To Page 2

Anglo earnings

relative to the marginal improvement in the rand gold price", which rose by only 2,1%, from R965 an ounce to R985. The dollar gold price, however, declined by 15% from \$453 to \$384.

Trading income increased by 46% from R191m to R279m, mainly due to Amcoal's improved results from increased export prices and tonnages and a weaker rand/dollar exchange rate.

Directors say a large part of the increase in taxation, from R132m to R210m, and of the increase in outside shareholders' interests in earnings, from R86m to R130m, are also attributable to Amcoal's improved results.

Other net income rose from R10m to

R28m, as higher interest and fee income more than offset increased prospecting costs. The net asset value per share rose by 47%, from 9 358c to 13 713c.

Retained earnings of associated companies, which are transferred to non-distributable reserve, rose by 28% to R716m. The sectors referred to above, with the industrial sector, were the major contributors. *B/Dam 24/11/89*

About the rest of the year, the directors say "Although difficult to predict, equity-accounted and attributable earnings for the year ending March 31 1990 are expected to show a lower rate of increase than that recorded for the first six months."

□ From Page 1

Government concessions on Minerals Bill

THE mining industry has extracted some major concessions from government on the controversial Minerals Bill due to go before Parliament next year but a significant disagreement and the industry remains largely represented by the Chamber of Mines has persuaded government to allow for the protection of diamonds and various other minerals against theft.

8/Day 29/11/89

REINIE BOOYSEN

which was to advise the Minister of Mineral and Energy Affairs on various aspects of mining. It is understood that the industry objected to the proposed introduction of levies by the council. But government, it is understood, is rock-steady in its plan to abolish the protection of land for mining purposes, which affects the common-law rights of surface owners. Industry representatives have been

loath to discuss precise details of the Bill because they have not yet seen the final version of the proposed legislation. Government's Deputy Mining Engineer, Kroos Auret, the leader of the task group which drew up the Bill yesterday confirmed that the principles contained in the final, third version, to be presented to Parliament next year, have been endorsed by the Cabinet. He said government's law advisers were in the process of polishing the

210

To Page 2

Minerals Bill

8/Day 29/11/89

exact wording of the Bill.

Auret said the mining industry and government had reached agreement in principle on the final form of the Bill. "To my knowledge there are no major areas of disagreement which remain," said Auret. But Chamber of Mines legal adviser Peter Anscombe said there were indeed some major areas of concern to the industry. There was uncertainty as to whether the new legislation would adequately preserve existing rights enjoyed by mining companies under the present legislation.

He said a notable example was the rights of holders of so-called "nomination agreements" in respect of Alienated State Land.

Anscombe said mining companies had spent vast sums of money securing nomination agreements, and added that there was considerable uncertainty to what extent rights flowing from these agreements would be preserved.

210

From Page 1

Soon after its publication late last year, the first draft of the Bill drew extensive criticism from the mining industry, and in particular the Chamber of Mines.

While government said the Bill aimed to rationalise SA's minerals law, and to reduce government's involvement in the mining industry, the chamber concluded that the Bill would enlarge rather than reduce government's involvement, and that it would grant unacceptably broad discretions and powers to government officials.

One major change to the Bill since publication of the first draft is an about-turn on the protection of certain precious stones and minerals from theft.

The original draft of the Bill intended doing away with laws restricting the possession of precious stones like uncut diamonds and tigers eye, and certain precious metals in an unwrought form.

RMP poised and ready to expand — report

Business Day Reporter

RAND Mine Properties (RMP) is well poised for expansion, and will give priority to expanding its interests in the year ahead, says chairman Dammy Watt in his chairman's statement. *By Dam 29/11/89*

Watt said RMP's prime goal was to identify and plan for new projects, be they of a property, or mining nature.

He said that negotiations for RMP to acquire certain of the property assets of Durban Roodepoort Deep were still in progress.

With more than R50m in cash at the September year-end, the group was un-

likely to need additional borrowings, said Watt. However, he added that should the need arise, short-term financing could be met from overdraft facilities which were already in place. *(210)*

RMP is unlikely to deliver an impressive earnings performance in the current year, said Watt.

"Based on available information, profit could be some 20% lower than the profit of R25,5m achieved in 1989," he said.

SOWETAN BUSINESS

Oh please, come off it Anglo

"In order to avoid replacing apartheid in reverse and a first world economy with a third world economy, it is essential that equal advancement be based on equal ability."

"To give a man a job because he is black would be as wrong as to give it to him because he is white. The deciding factor has to be the man's ability to do the job. And therein lies South Africa's challenge. The challenge to make school and post school education equal so that all South Africans can start out on merit", Anglo American has said in an advertisement placed in newspapers the country over in the past weeks.

The advertisement goes on to say that Anglo American is spending more than two hundred million rands in education and training for blacks and whites.

Like many others, I do know and appreciate the fact that Anglo is spending millions on education and, nearer home, developing small and black business.

Anglo and several other corporations, Barlow Rand for one, are spending a tidy packet in developing small business.

Both companies and others deserve mention and support for they are teaching us how to fish instead of giving us fish.

But I do have problems with denouncing

racism in reverse. The logic is inexplicable. South Africa's black community has been disadvantaged since the Anglos of this world came into being

Apartheid was at the core of all this discrimination and degradation. Although Anglo was one of the companies opposed to this policy, they continued to reap huge profits from it. What stopped them from paying black miners a living wage or allowing them to live with their families by providing them with decent homes as they are trying to now?

In any case apartheid resulted in the white community getting all the opportunities, while blacks

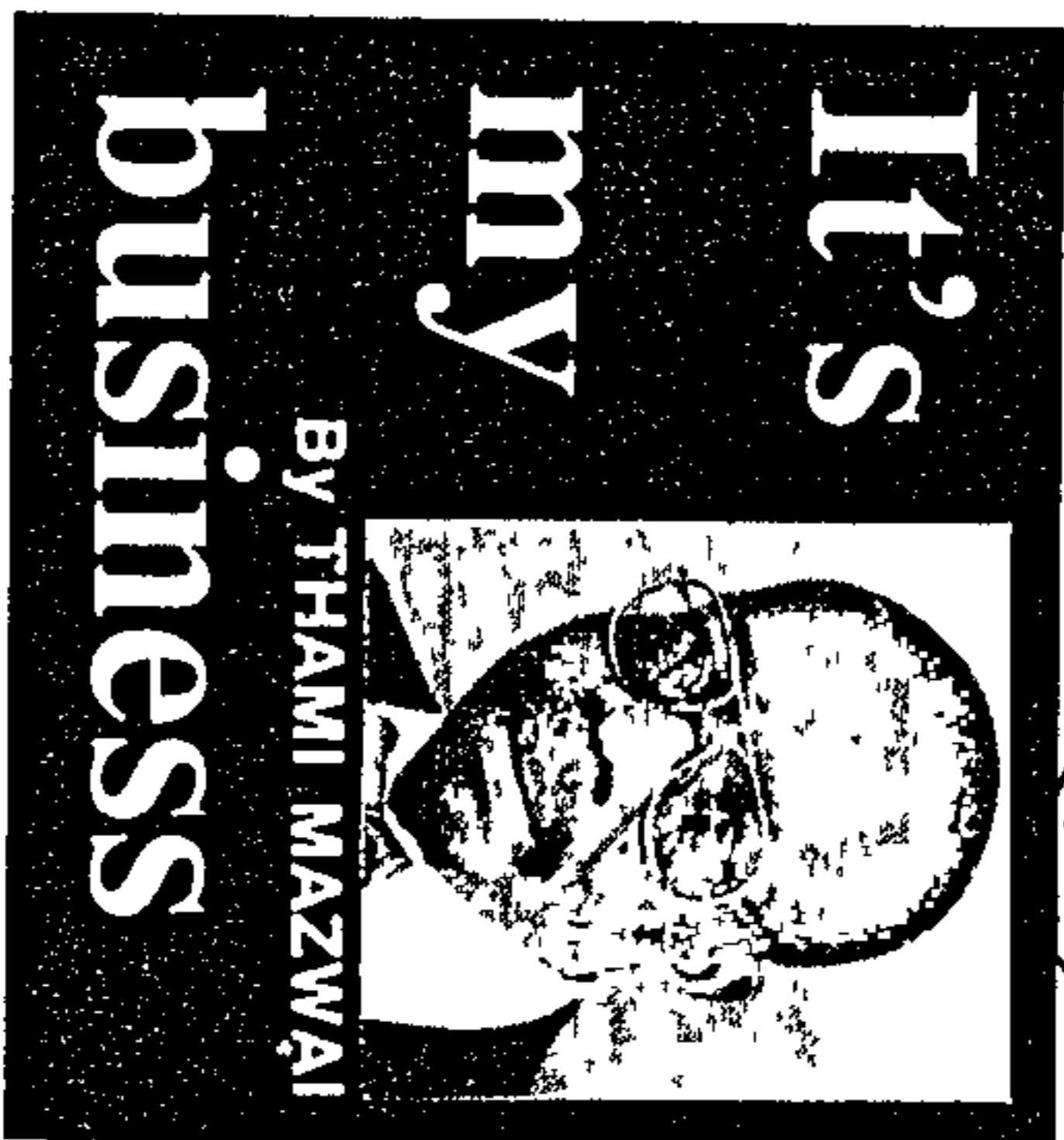

stayed at the bottom of the ladder. This is the legacy of practices such as job reservation which Anglo applied claiming it could not break the law. Now that we have a situation

where whites are at the top of the heap because of racism, let us not be told that reverse racism is bad. I fully agree that racism is evil, but people who benefited from it are

the last to tell us that. What this country needs is a programme to redress the economic and social injustices of the past. For instance when a white child is given a bursary, five others must go to black children.

For every rand lent to white businessmen, black businessmen must get five. Senior jobs must also be distributed along these lines. I am being very generous and have not taken into account what this economy owes black South Africa for the disparities of the past.

Just last year when First National Bank announced it would employ more blacks than whites as this was in line with the composition of the

population there was an outcry from the white community. One company even went as far as to say it believed in the best man getting the job. If there ever was a blatant display of racism this was it for this company knows that the best candidates would come from white South Africa, after all apartheid ensured this

It seems we have a situation where whites want to have their cake and eat it too. They benefited when apartheid was rigidly enforced, they are now talking of the best man for the job knowing full well that racism made them the best candidates for the jobs. I suggest Anglo have another think, what they are saying just does not sell.

210
Saxxoxw
28/11/89

Gencor assets amounted to R1,318bn in August

210 B/Day 11/2/89

GENCOR'S net cash and money-market assets were at R1,318bn at the August year-end, having been boosted by the house's recent R1,5bn rights issue

As the financial report, released today shows, this puts the group in a strong position to finance new projects or acquisitions. The report contains, for the first time, a detailed financial and investment review addressing key areas of interest for analysts, one of which is a detailed analysis of the financial resources available to the group.

The report shows that in addition to its considerable cash resources Gencor had portfolio investments with a market value at year-end in excess of R500m available to meet future financing needs.

The net cash increase arising from continuing operations totalled R276m and dividend, fee and interest income were the major contributors to this increase.

From the report one can also see that

Business Day Reporter

the gross balance of loans outstanding at year-end represented only 11,3% of equity and was well below the limits dictated by prudence and imposed by the company's borrowing powers, leaving Gencor in a very powerful financial position.

Distributions

Also of interest to analysts is the fact that Gencor earned 66,6%, or R700m, of its R1,051bn attributable income from dividends, while 42,8%, or R450m, was equity-accounted income.

The balancing items, the net R99m operating deficit, can (with the exception of R56m of expenses) be regarded as being of a cash nature. In broad terms cash income (dividends plus operating income of a cash nature) totalled R657m or 62,5% of Gencor's 1989 income, and distributions to shareholders totalled R333m. The distri-

butions were comfortably twice covered by cash earnings.

The report also highlights a change in Gencor's accounting policy, to include in extraordinary items an amount of R251m of net surpluses on the realisation of capital investments.

"The change in policy resulted from the recognition that decisions to realise capital investments are based on strategic considerations and the proceeds are ultimately re-invested in assets of a capital nature," it says.

"They are thus not available for distribution to shareholders and any related surpluses are more appropriately reported as extraordinary items."

The report says Genmin, the largest profit contributor to the Gencor group, anticipates further growth in the contributions from its metals and minerals, platinum and coal divisions, but forecasts that the group's gold contribution is likely to be maintained unless there is a major setback in the rand gold price.

TOP 100 COMPANIES

A SPECIAL SURVEY, DECEMBER 3 1989

W&A INVESTMENT CORPORATION

By David Carter

Fight Right Royals

IT TAKES an exceptional company to stay in the Business Times' top 20 for three consecutive years.

Consider that Toyota, which has won a double hat-trick, and Metalf, which won twice in a row, are not in the Top 100 at all this year.

Both remain fine companies, but eventually ran into rough motoring conditions and tough base years.

Companies that can hold their positions in the top 20 for three years are dubbed "Royals" companies, and this year there are eight compared to only four last year.

- W&A Investment Corp.
- Rembrandt Group
- Trenchor
- Irwin & Johnson
- Anglovaal
- Mannal & Federal
- Waltons
- De Beers

Sanctush, a Royal company several times in the past, missed "Royalty" this year by one place, ranking 21st.

W&A INVESTMENT Corporation is Business Times' top company for 1989.

The conglomerate — founded by Mannie Simchowitz and sold by the great entrepreneur to Jeff Liebesman's FS Industries two years ago — has given shareholders a return of 76.5%pa for the past five years.

A shareholder who invested R10 000 in W&A five years ago has seen his investment grow to R171 286. W&A ranked ninth in last year's top company list. It replaces one of its own subsidiaries — National Bolt — at the top of the pile.

As the graph on page 13 shows, shareholders had to have strong nerves to stay with W&A for the full five years, for the share price slumped from R77 to R37 in the great crash of 1987 shortly after FS took control. People laughed at the buyer and said "Just like Mannie to get out at the very top."

Conventional wisdom was that Jeff Liebesman had overpaid. But somehow the Liebesman team managed to rationalise and sweat the assets, reduce the staff and pull off one of the more remarkable corporate restructurings of recent times. After a startling run-up from R38 to R60 in the past year, W&A is at dizzy heights than even the great Mannie Simchowitz remembers.

Between 1986 (before FS took over) and 1988 W&A hoisted turnover from R720-million to R1 450-million and operating profit soared from R80-million to R177-million. Earnings a share have risen from R33c to 957c. Shareholders' hands have soared from R230 million to R861-million. And there is much better to come in the year to December 1989.

Running up in Business Times' Great Race between the best performing companies was Rembrandt Group. Rembrandt ranked third last year.

For the past five years, Rembrandt has been the ultimate rand hedge. It has also been creative domestically, sewing up control of and re-pairing Dorbyl, Volksskas, Momentum Life-Litegro and other interests.

Rembrandt has rewarded the faithful with a return of 63%pa for the past five years. That means R10 000 invested in Rembrandt in 1984 has been transformed into R115 063.

Ten years ago, investors were prepared to pay only four or five times earnings for Rembrandt "because its formation about the earnings sources is so sketchy".

But the tobacco multinational's true value started shining through as hundreds of millions of dollars of cash held off-shore swelled in rand terms towards R1-billion. The full value of the foreign assets was finally

210
3/12/89



THE TOP TEAM Terry Rolfe, Jeff Liebesman, Neville Cohen and Ivan Posniak of W&A

How strong nerves paid off

No 1 1984: R10 000
1989: R171 286

realised last year when the foreign interests were put into Liebesman and Rembrandt shares were distributed on a one-for-one basis.

The transaction amounted to a capital reduction. Naturally, the share price of Rembrandt dropped after Liebesman was backed out, but since Rembrandt holders received a free Rembrandt for every Rembrandt share, the value of the share was not affected. The share price of Rembrandt rose to R100 in the year to December 1989.

Rembrandt now represents South African assets only. It has staggered many analysts by being able to improve earnings and dividends in spite of the excision of R-

chemical. Johann Rupert has scored three triumphs in just over a year — first, the creation of Richmond, which added billions to shareholder wealth, second, acquiring effective control of Gold Fields of SA, and third, buying back out a right control of Richmans International from Philip Morris on bargain terms.

Business Times has frequently highlighted new corporate starts in the past. The Mozowski brothers' El-H&J Cables.

The new company will third, is another. Those who bought shares worth R10 000 would by now have seen their investment grow to R111 233. Elcentre is fundamentally an outstanding manufacturer, wholesaler and retailer of electrical goods. Through wise acquisition, it has come to dominate its market.

Trenchor has been prominent in Business Times rankings for several years. Last year it ranked fifth. It is one of Business Times' Royal

have sales of more than R1-billion. And it will be a strong counterforce in cables to Bill Venter's Powerch. W&A's National Bolt, now named Trenchor, has 35% of Elcentre and with such able operators in place, is content to be a sleeping partner.

Trenchor, the Jewell family's remarkable Namqua hand transport based conglomerate, came fourth in the rankings, returning 60.4%pa and boosting a R10 000 investment to R106 175 in five years.

This year's TOP 100 Companies

RANK	COMPANY	AVERAGE ANNUAL RETURN (%)
1	W&A Investment Corp	76.5
2	Rembrandt Group	63.0
3	Elecentre Corp	61.9
4	Trenchor	60.4
5	Delta Electrical	57.4
6	Messina	56.0
7	Irwin & Johnson	54.9
8	Anglovaal	52.0
9	Mutual & Federal	51.9
10	Gentvre	50.3
11	Times Media	49.2
12	Berzack Illuman	49.1
13	Middle Wilwaterstrand	48.5
14	Waltons	48.3
15	De Beers	48.2
16	Edgars	48.2
17	Masuli Abestor	48.1
18	Wilwaterstrand Deep	47.1
19	CNA-Gallo	47.0
20	Trans-Hex Diamonds	46.9
21	McCarthy Group	46.8
22	Samancor	46.7
23	JCI	46.0
24	Suncrush	45.7
25	Papkor	45.5
26	Malbak	44.3
27	FSI	43.7
28	Nalibit	43.5
29	Oceana Fishing	43.4
30	Cedbury Schwappes	43.1
31	Consol	42.6
32	Palabora Mining	42.3
33	Charmarve	41.7
34	Anglovaal Industries	41.4
35	Trek Petroleum	41.2
36	Fesser Alexander	41.0
37	COP	40.6
38	Rustenburg Platinum	39.5
39	Adcock Ingram	39.4
40	Ginhaker	39.4
41	SA Breweries	38.7
42	Ganvor	38.5
43	Lydenburg Platinum	37.9
44	New Central Wits	37.5
45	Sappi	37.4
46	Vogelstruif GM	37.0
47	Tiger Oats	37.0
48	Anglo American Corp	36.8
49	Pite Glass	36.8
50	SA Bias Blinding	36.3
51	UMIC	36.2
52	Anglo Steel Co	35.6
53	Common Fund	35.3
54	Mette & Ziegler	35.3
55	Highveld Steel	35.3
56	Barrow Rand	35.2
57	United Tobacco Co	34.6
58	Carxton	34.4
59	HLH	34.1
60	SA Eagle Insurance Co	34.0
	CG Smith	34.0

* Share price September '89, less share price paid and interest on dividends at 12% pa gives total yield. This is expressed as an average compound return per annum on original share price.

Unit trusts won't let anyone down

By Julie Walker

UNIT TRUSTS had a remarkable year to September, attracting the discretionary investment funds of 70 000 new unitholders to bring the total to 556 466

The total value of the 31 unit trust funds exceeded R6-billion at September 30, compared with just under R4-billion in 1988. During the year there was a net inflow of R544-million into unit trusts

Over the past five years, general equity unit trusts have achieved an average compound annual return of 26,8% — well ahead of the inflation rate over the period

The 13 general funds were 47% invested in industrials, 18% in mining finance and 12% in other mining

The specialist equity funds are almost all mining and resources based funds. They have achieved a compound rate of return of 21,4% over the past five years

The 10 funds were 24% invested in gold shares, 24% in mining finance and 17% in other mining shares

The eight high income trusts held assets with a market capitalisation of R264-million at September 30. In the last year they achieved an average total return of only 15,1%.

According to figures furnished by the University of Pretoria's Graduate School of Management's unit trust survey, UAL's general equity fund achieved the best return on a one year repurchase to repurchase basis.

The JSE's All-Share index climbed by 55,83%, but UAL's unit trust outperformed it with a rise of 56,47%.

New fund Norwich NBS did extremely well to finish in second place, with a rise of 55,71 — just under the rise in the All-Share index

UAL's unit holders had a good year because its mining and resources fund also came tops, with a rise of 53,92% in the 12 months to September 1989. The survey uses the JSE's Mining Producers index as the yardstick against which to measure the performance of

specialist equity funds. This index rose by 46,61%, while the All-Gold was up 38,71%

To make it three out of three, UAL's gilt fund made the best return for unitholders out of the eight income funds. It returned 17,9%, whereas the survey estimates the rate of rise in the consumer price index at 15,29% over the period.

The worst performers in the two equity categories still achieved good returns. The Standard Bank Mutual equity fund gave a return of 41,77%. Its management adopted a bearish view on the JSE and the fund remained highly liquid

Standard Bank Gold — the sole gold-only portfolio — did worst of the specialist funds, with an all-in return of 36,92%. It will probably do best this quarter after the leap in the prices of gold shares

The worst-performing income funds were both Senbank's. Its Gilt trust made 9,96%, while the High Yield fund achieved a paltry 9,21%.

According to the survey, Senbank's two funds will be placed elsewhere within the Bankorp group, probably before the end of the year.

The survey says that, since the announcement of the relaxation of prescribed asset requirements for pension funds earlier this year, Senbank's Gilt fund in particular has lost its raison d'être. The two could be the first casualties in a wave of unit trusts launched in 1987 which have not made the grade

The liquidity of the equity funds varies as much as does their composition.

At September 30, the liquidity among general funds

ranged from Sanlam Index trust's 8% to Lifegro's 27%. Four funds were more than 20% liquid, while the second-lowest liquidity was Sygro's 12%

Four funds were more liquid than a year ago, while eight were less so.

Among specialist funds the range of liquidity was from Sanlam Dividend's 6% to Guardbank's and newcomer Southern Mining's 22%. Here, eight funds were more fully invested than they were last year, only Sage holding more cash.

The survey also notes movements in the unit trust industry. It says Board of Executors and AA Mutual Life have announced their intentions to establish general equity funds next year.

It also notes negotiations with the Registrar of Unit Trust Companies for the relaxation of certain legal restrictions. More flexibility and autonomy for self-regulation is called for.

The major areas of dissatisfaction relate to the 5% rules — a fund may not own more than 5% of any company's shares, nor may it have more than 5% of its funds invested in one company.

Another issue is that unit trusts may not hedge themselves on the futures markets, yet pension funds may do so.

Unit trusts also seek a lightening of the rules whereby they may not compare their performance with that of other trusts — or, indeed, other investment channels. The survey has become a source of reference in this regard

It also refers to the developments at UAL, whereby UAL offers the chance to in-

vest in a customised basket of managed growth assets which will provide an investor with a guaranteed minimum return on his investments

An investor selects a minimum guaranteed capital performance to suit his financial plan. UAL offers guarantees ranging from a return of the capital invested to a maximum rate of the original capital invested, escalated at a compound rate of 5% a year

All guaranteed returns are after tax at a rate of 45%. The extent of the guarantee will affect the ultimate capital performance of the investment. A lower guarantee should yield higher capital growth

The investor may select a fixed investment period between four and nine years. The assets of this product will produce a limited amount of annual taxable income, with the bulk of the income tax burden arising on the maturity date

UAL trust also feature in Nedbank's home loan option introduced in May. Borrowers service only the interest on the home loan. Instead of reducing the capital portion, money is invested in UAL's unit trusts. The long-term proceeds from this investment should cover the capital liability and leave a surplus

The general public may also in the near future be permitted to join specific pension funds which invest directly via a unit trust channel

These funds will have to comply with the usual requirements, but the public will enjoy the same tax benefits as with a conventional pension fund

Now there is a plan to link a retirement annuity fund to the 10 largest general unit trusts. Each member's contributions are, according to his own preference, invested in a specific trust. The usual tax benefits also apply here

Unit trusts have let nobody down, and for the man in the street should continue to be the preferred investment vehicle for capital growth for the foreseeable future.

The Top 100 Companies 1989

Top this year

Rank	Company	Return (%)
1	York Timber Organisation	328,5
2	Zaalplai Tin Mining Co	284,8
3	Mason Ashes	285,7
4	Borzack Brothers Holdings	223,0
5	Charcoal Mining Investments	218,9
6	Crispold Exploration and Finance Co	208,4
7	Sea International Naphatatswana	184,0
8	Union Steel Co	178,1
9	Cometation Company (Africa)	173,0
10	Noncor	163,0
11	Bidcorp	160,2
12	Micor Holdings	158,0
13	Nightvold Steel & Vanadium Corp	148,0
14	McCarthy Group	148,7
15	NSJ Supreme Cables	148,8
16	Trans-Max Diamonds	148,2
17	Constal	145,1
18	Corrig Diamonds	142,8
19	Sander Industries	141,0
20	Kashym Investments	138,2
21	W&A Investment Corp	132,0
22	FS-Team	131,8
23	Commagamma Holdings	130,7
24	Merkor Group	130,3
25	Safite	130,1
26	Elcentro Corp	129,0
27	Yabang	129,0
28	United Transport Co	126,0
29	Clegg Holdings	125,0
30	MacPhail Holdings	123,7
31	Burbyl	123,5
32	General Tyre & Rubber Co	118,2
33	Wootra	118,0
34	Soro Group Holdings	117,2
35	Adcock Ingram	117,1
36	Waterloo	116,4
37	Mitellip	115,3
38	Elandsrand Gold Mining Co	113,1
39	Balfio Corp	112,6
40	Troncor	111,4
41	Autopaga	111,1
42	Alcom Group	109,3
43	Sho-Craft	108,0
44	Johannesburg Consolidated Investment	108,0
45	Currie Motors	105,9
46	Midas	103,1
47	Messina	102,0
48	RTB Group	102,5
49	Autoglyp	101,0
50	Board of Executors	101,0
51	Witwatersrand Gold Mining	100,4
52	Saffcon Investments	100,3
53	Standard Engineering	100,2
54	South Wits	100,0
55	Aida Holdings	99,0
56	Real Teachers & Nephers Holdings	98,1
57	Gwala	97,5
58	Royal	98,1
59	CRA-Galle	97,9
60	Canbury Schweppes (SA)	95,9
61	Milston	95,4
62	Argo American Coal Corp	94,8
63	Met	94,1
64	Standard Bank Investment Corp	93,5
65	Argo American Industrial Corp	93,2
66	Consolidate Frame Textiles	93,1
67	Spoll Consolidated Mines	92,3
68	Barlow Rand	91,5
69	Imperial Group	91,5
70	Bristol Industrial Corp	91,1
71	Martin Granite	90,4
72	Balfour Properties	89,9
73	Sofmarino and Nomies Holdings	89,0
74	Tempura Investments	89,0
75	General Mining Union Corp	89,0
76	Tiger Mats	89,2
77	Citizen	88,7
78	Knights	88,4
79	Mutual & Federal Insurance	88,2
80	Da Gama Textile Co	87,8
81	Fraser Alexander	87,3
82	Sithe	87,0
83	Southern Sun Hotel Holdings	86,9
84	Rastenburg Platinum Holdings	86,0
85	Korpal Investments	85,0
86	Jade	85,5
87	Sentrachon	85,4
88	Jazz Stores	84,0
89	SA Pulp & Paper Industries	84,0
90	Lucum Holdings	83,8
91	Halard	83,0
92	Witwatersrand Bus	82,9
93	Shield Trading Corp	82,5
94	Waisel	82,4
95	Sasol	81,5
96	Edgars Stores	80,4
97	Argus Printing & Publishing	79,9
98	Trek Holdings	79,2
99	Wayne Rubber	79,0
100	Marvest	78,5
	NBS Holdings	78,5
	Worloutela Colliery	78,5

Investors celebrate

210
Stines 3/12/89

FEWER mining stocks this year compared with '87 and '88 — thanks to a stagnant rand gold price and rising costs — make it tougher to analyse this year's list.

In 1987 there were 21 mining stocks, including 17 gold mines in the top 100

In 1988 there were 24 mining stocks and 16 golds. This year there are only 19 mining stocks and nine gold mines. Middle Wits is the only gold mining company in the top 20, though there are five non-gold mining companies.

Industrial company profits have been good and share values have tested new highs this year.

As a result, returns for shareholders overall have been better than last year, when the top company returned 62,2% pa against W&A's 76,5% pa this year. Last year the company ranking 100th gave a return of only 11% pa against this year's 23,8%. Last year many shares were still suffering the after-shocks of the October 1987 crash.

Investors

Motor companies have been less prominent this year because investors see clouds ahead. McCarthy was top motor stock, moving up from 64th spot to 18th. Asseng at 62 and Curries at 83, were the only others that made the list.

Because of tight margins, the financial services sector has been out of favour for the past year, so no bank made the top 100. Stanbic gave a return of 22% pa in the five-year period, Volkskas 12,1%, First National 11,1% and Bankorp 2,6%.

Nedbank had a good year, rising from 620c well above 800c — but the five-year record is not so impressive — nearly precisely zero percent per annum. But once Nedbank's low point becomes the base year, watch it scream up the rankings.

Last year's top company, Natbolt has fallen down the list to 26th spot. All goes well for the FSI company, which is now part of Teamcor, profiled elsewhere.

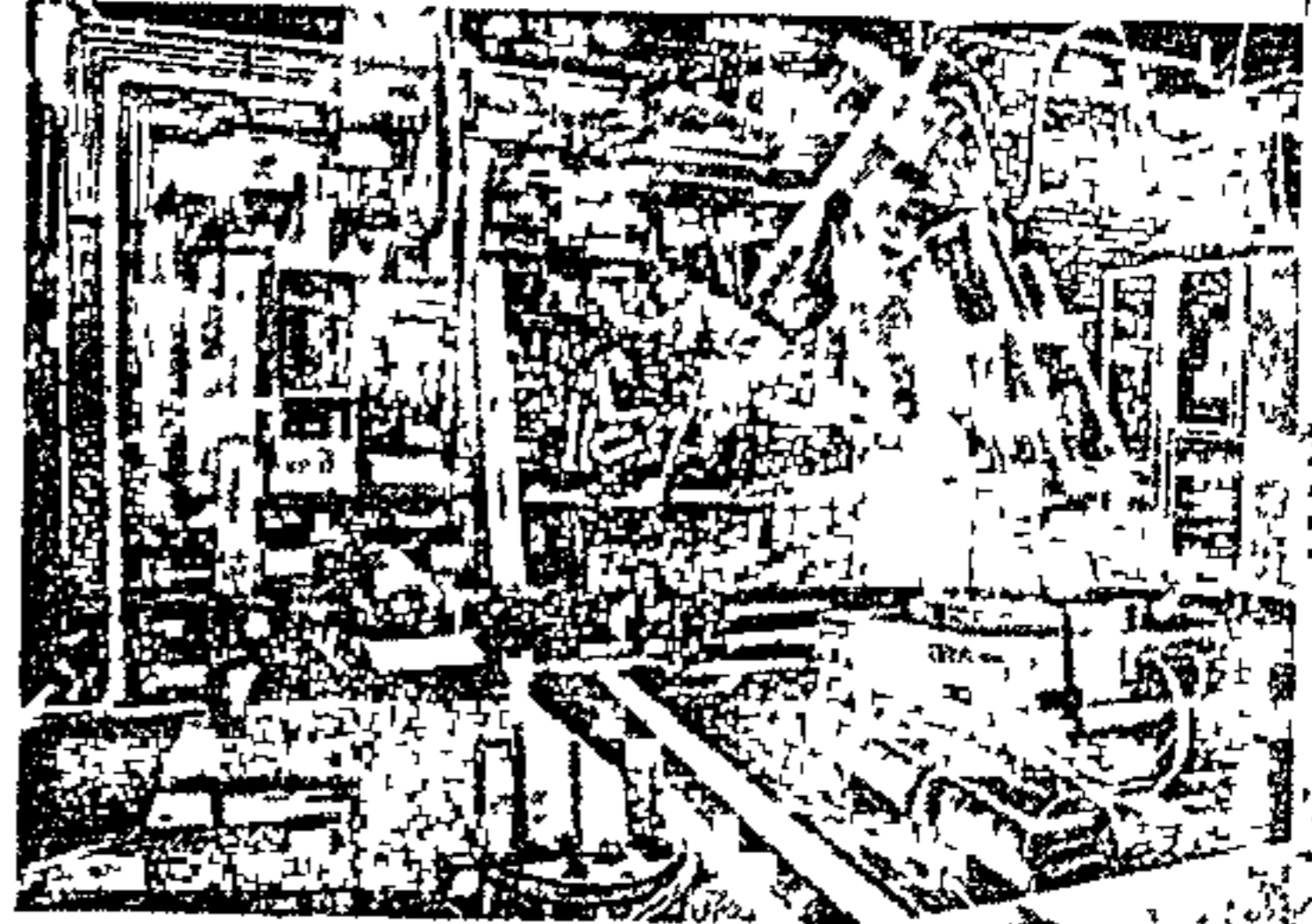

FEARS: Motor Industry automated but static

By David Carte

Natbolt was the beneficiary last year of a poor base year in 1984.

Waltons, winner for two years and runner-up last year, has continued to produce good results — but things are running less buoyantly these days.

It is also up against a higher base year, which explains why it ranked "only" 12th this year. Waltons is nevertheless a Royal company, having made the top 20 for three years in a row.

A reflection of harder times in motoring is that Toyota, holder of two hat-tricks as top company, and two-time winner Metair, did not make the top 100 at all.

Two other great companies that did not make the list were Altech and Pick 'n Pay, which ran into high base years and tougher competition in their sectors. Thanks largely to a continuing good performance in electronics, Grinaker moved up from 73 to 38 with a return for shareholders of 39%. Nampak

moved up from 78 to 60. Edward Bateman plunged down the list from 23 to 88.

When big companies, such as Rembrandt and De Beers perform, more investors benefit. It is more difficult for the giants to get to the top of the list because they have been highly rated for years.

The thing to bear in mind is that getting into the top 100 is an achievement in itself. It puts one in the top 20% of companies on the JSE.

Rewarded

Several large companies have performed outstandingly. While it is only in 39th position, SA Breweries has rewarded thousands of shareholders with a 39% return. Anglo and Amic investors must be happy with the annual returns of 37% and 36%.

Barlow Rand improved its position from 75 to 54 with an annual compound return of 35%, while Sasol fell from 73 to 97 with a still-good 24,2% pa growth.

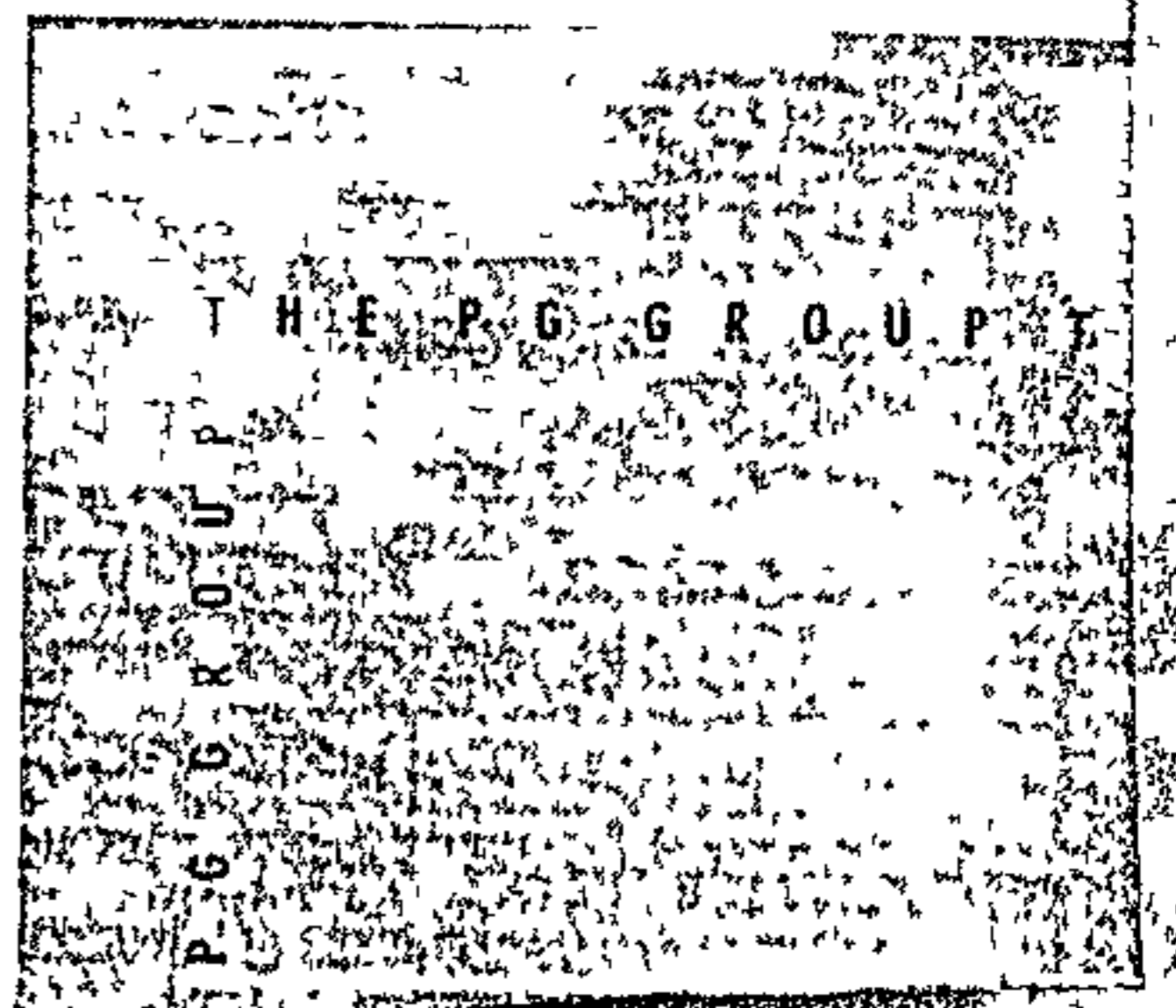

is year

	Return (%)
	320.5
	284.8
	285.7
	223.9
	210.8
	209.4
	184.8
	178.1
	173.8
	165.8
	162.2
	158.8
	148.8
	148.7
	148.6
	148.2
	143.1
	142.8
	141.8
	138.2
	132.8
	131.8
	130.7
	130.3
	130.1
	129.8
	128.8
	125.8
	126.8
	123.7
	123.5
	118.2
	118.0
	117.2
	117.1
	115.4
	115.3
	113.1
	112.5
	111.4
	111.1
	108.3
	108.0
	108.0
	105.8
	105.1
	102.8
	102.5
	101.8
	101.4
	100.4
	100.3
	100.2
	100.0
	99.8
	99.1
	97.5
	96.1
	95.8
	95.4
	94.8
	94.1
	93.5
	93.2
	93.1
	92.3
	91.5
	91.5
	91.1
	90.4
	89.8
	89.8
	88.8
	88.8
	88.2
	88.7
	88.4
	88.2
	87.8
	87.3
	87.0
	86.9
	86.8
	85.8
	85.4
	84.8
	84.8
	84.8
	83.8
	83.8
	82.8
	82.5
	82.4
	81.5
	80.4
	78.8
	78.2
	78.8
	78.5
	78.5
	78.5

Investors celebrate

210
S/Times 3/12/89

FEWER mining stocks this year compared with '87 and '88 — thanks to a stagnant rand gold price and rising costs — make it tougher to analyse this year's list.

In 1987 there were 21 mining stocks, including 17 gold mines in the top 100

In 1988 there were 24 mining stocks and 16 golds. This year there are only 19 mining stocks and nine gold mines. Middle Wits is the only gold mining company in the top 20, though there are five non-gold mining companies.

Industrial company profits have been good and share values have tested new highs this year.

As a result, returns for shareholders overall have been better than last year, when the top company returned 62.2% pa against W&A's 76.5% pa this year. Last year the company ranking 100th gave a return of only 11% pa against this year's 23.8%. Last year many shares were still suffering the after-shocks of the October 1987 crash.

Investors

Motor companies have been less prominent this year because investors see clouds ahead. McCarthy was top motor stock, moving up from 64th spot to 18th. Asseng at 62 and Curries at 83, were the only others that made the list.

Because of tight margins, the financial services sector has been out of favour for the past year, so no bank made the top 100. Stanbic gave a return of 22% pa in the five-year period, Volkskas 12.1%, First National 11.1% and Bankorp 2.6%.

Nedbank had a good year, rising from 620c well above 800c — but the five-year record is not so impressive — nearly precisely zero percent per annum. But once Nedbank's low point becomes the base year, watch it scream up the rankings.

Last year's top company, Natbolt has fallen down the list to 26th spot. All goes well for the FSI company, which is now part of Teamcor, profiled elsewhere.

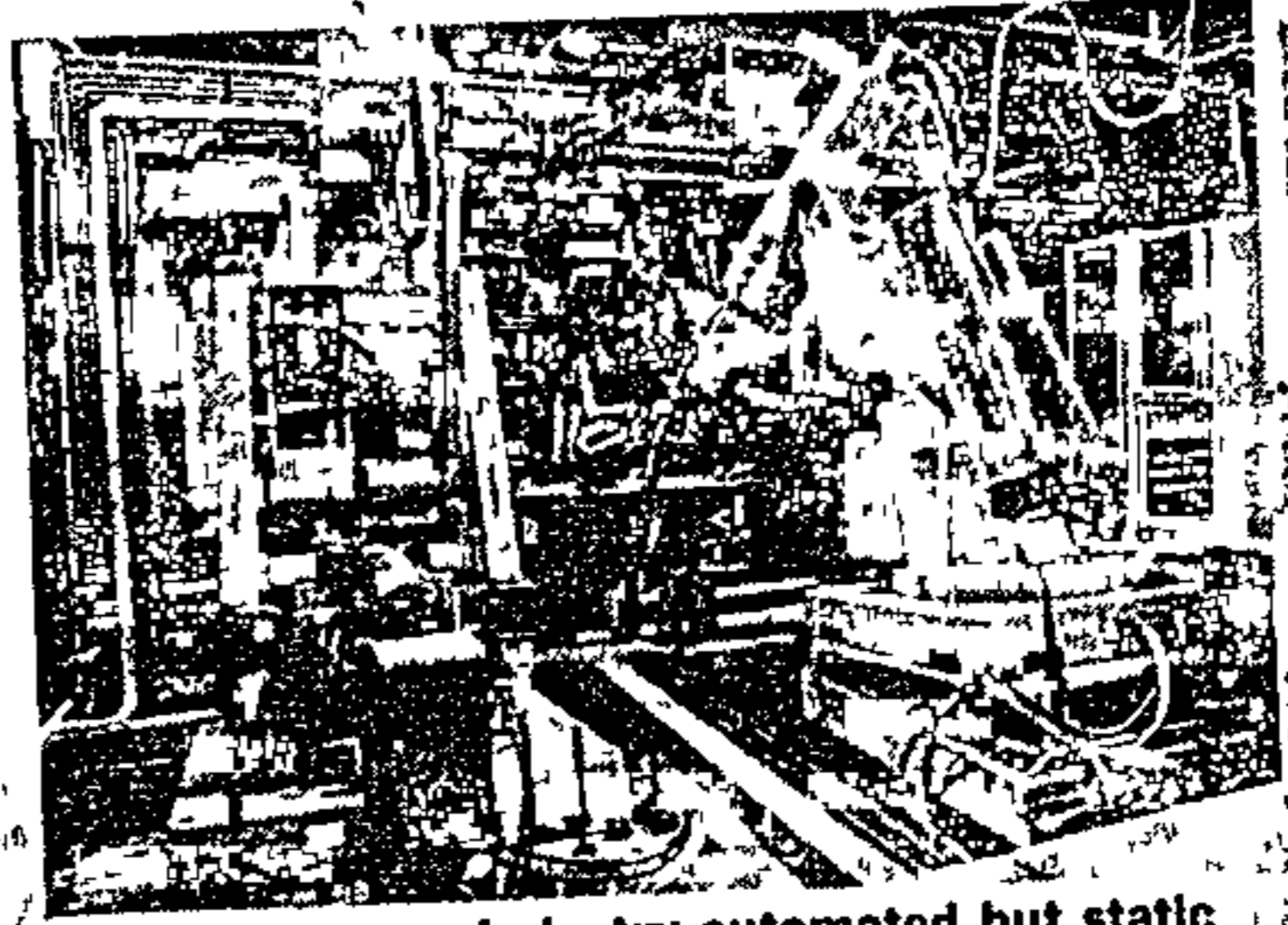

FEARS: Motor industry automated but static

By David Carte

Natbolt was the beneficiary last year of a poor base year in 1984.

Waltons, winner for two years and runner-up last year, has continued to produce good results — but things are running less buoyantly these days.

It is also up against a higher base year, which explains why it ranked "only" 12th this year. Waltons is nevertheless a Royal company, having made the top 20 for three years in a row.

A reflection of harder times in motoring is that Toyota, holder of two hat-tricks as top company, and two-time winner Metair, did not make the top 100 at all.

Two other great companies that did not make the list were Altech and Pick 'n Pay, which ran into high base years and tougher competition in their sectors. Thanks largely to a continuing good performance in electronics, Grinaker moved up from 73 to 38 with a return for shareholders of 39%. Nampak

moved up from 78 to 60. Edward Bateman plunged down the list from 23 to 88.

When big companies, such as Rembrandt and De Beers perform, more investors benefit. It is more difficult for the giants to get to the top of the list because they have been highly rated for years.

The thing to bear in mind is that getting into the top 100 is an achievement in itself. It puts one in the top 20% of companies on the JSE.

Rewarded

Several large companies have performed outstandingly. While it is only in 39th position, SA Breweries has rewarded thousands of shareholders with a 39% return. Anglo and Amic investors must be happy with the annual returns of 37% and 36%.

Barlow Rand improved its position from 75 to 54 with an annual compound return of 35%, while Sasol fell from 73 to 97 with a still-good 24.2% pa growth.

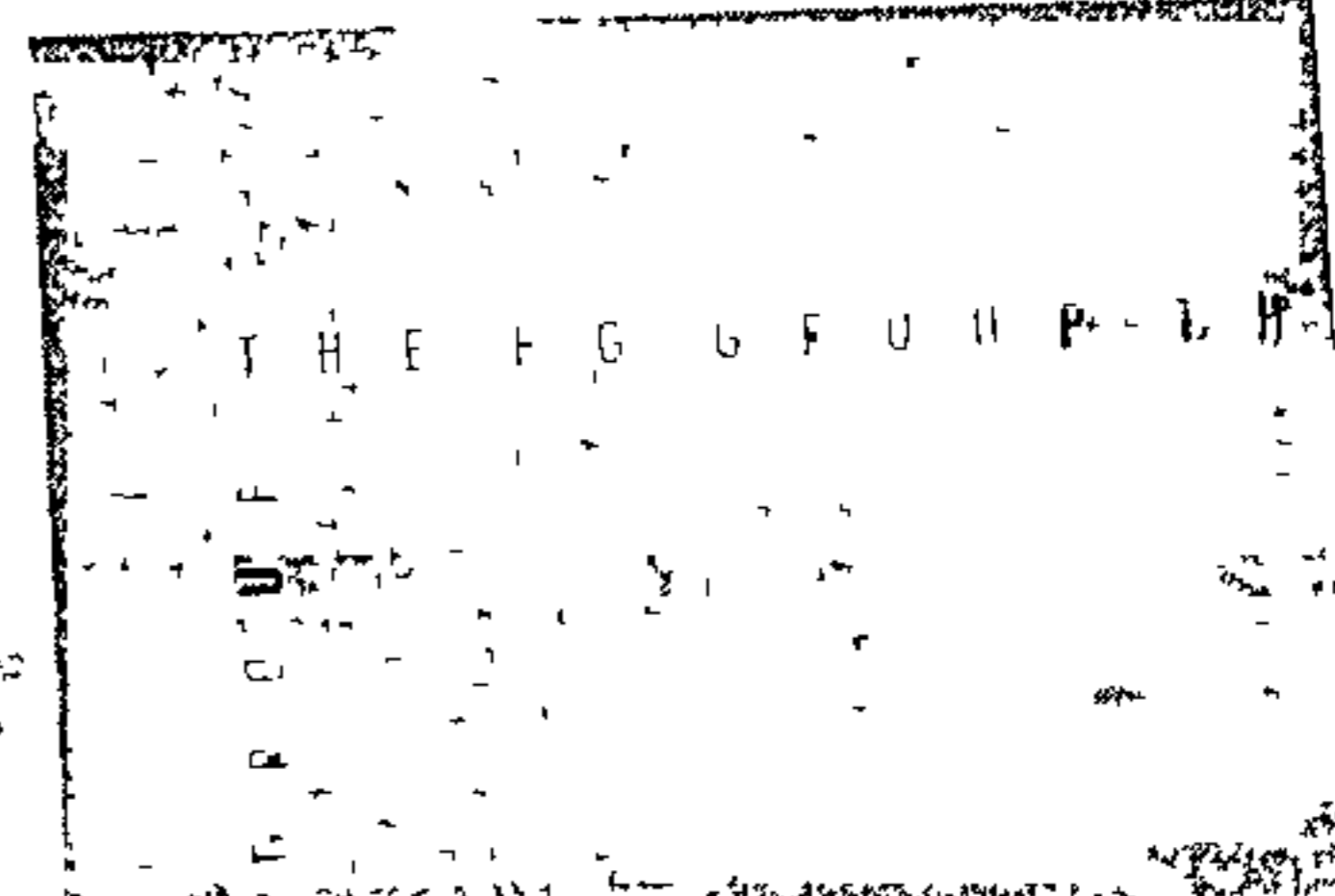

Diversity is group key...



BASIL HERSOV:
Cash buyer

A TWO-PRONGED approach to both mining and industry from the outset has stood Anglovaal in good stead over the last 55 years

During the last five years the family-controlled investment house was the eighth best performer in terms of annual compound return to shareholders. Off the top of one's head it is unlikely that Anglovaal's name would spring to mind as the best of the mining houses.

Anglovaal's chairman Basil Hersov is the son of one of the original co-founders, and deputy chairman Clive Menell is the son of the other. The fathers established Anglovaal in 1933 with a single gold mine — Mr Hersov senior was a mining engineer — but within the first year a cement business had been established too.

And so it developed, almost 50/50, whereas it is only recently that SA's other major mining houses have climbed on to the industrial bandwagon.

Basil Hersov says he joined the group when he was born, but more tangibly in 1949 following the death of his father. He says the group's philosophy has been instrumental in giving it room to grow, especially with regard to the long-term nature of mining projects.

Time horizon

With industrial ventures, it is easier to define a market, consider a time horizon and establish a company, but the development of mining projects can take years. This becomes more pertinent today, when most of the shallow, easily mined ore bodies have already been exploited.

"Exploration takes a lot of patience, a lot of seed money to grow the right crops and these can take a long time to germinate," says Mr Hersov. Acquisitions are carefully considered. Although Anglovaal appears to have been on a spending spree during the last year, Mr Hersov says that some of the companies bought had been on the shopping list for several years.

Almost everything is bought for cash, to which Mr Hersov attaches some importance. He believes that companies which issue shares for acquisitions often adopt an "it-costs-nothing" approach and over-dilute their assets.

Many of the businesses have been family-owned concerns themselves. The downside of all this is that it is very difficult to deal in Anglovaal shares, and indeed in almost all of its operating companies.

Today the diversified interests comprise a microcosm of SA's own economy.

On the mining side there are four managed gold mines — Eastern Transvaal Consolidated, Hartbeestfontein,

**No 8 1984: R10 000
1989: R81 137**

By Julie Walker

Lorraine and Village Main — which together with income from non-group mines supplied 19% of group income in the year to June 1989 and represented 23% of Anglovaal's investments.

Gold is also produced at the Consolidated Murchison antimony mine. Other metals and minerals include chrome-ore mining at Lavino, copper and zinc at Prieska, manganese and iron

ore at Associated Manganese, ferro-alloys through Feralloys, as well as Transvaal coal deposits.

Non gold mining and metal production earned 17% of Anglovaal's income while representing 26% of investments.

Operations at Prieska are being wound down, but another door should soon be opening at Venetia. De Beers has completed a feasibility study on the opening of a diamond mine on the Northern-Transvaal farm Prospects

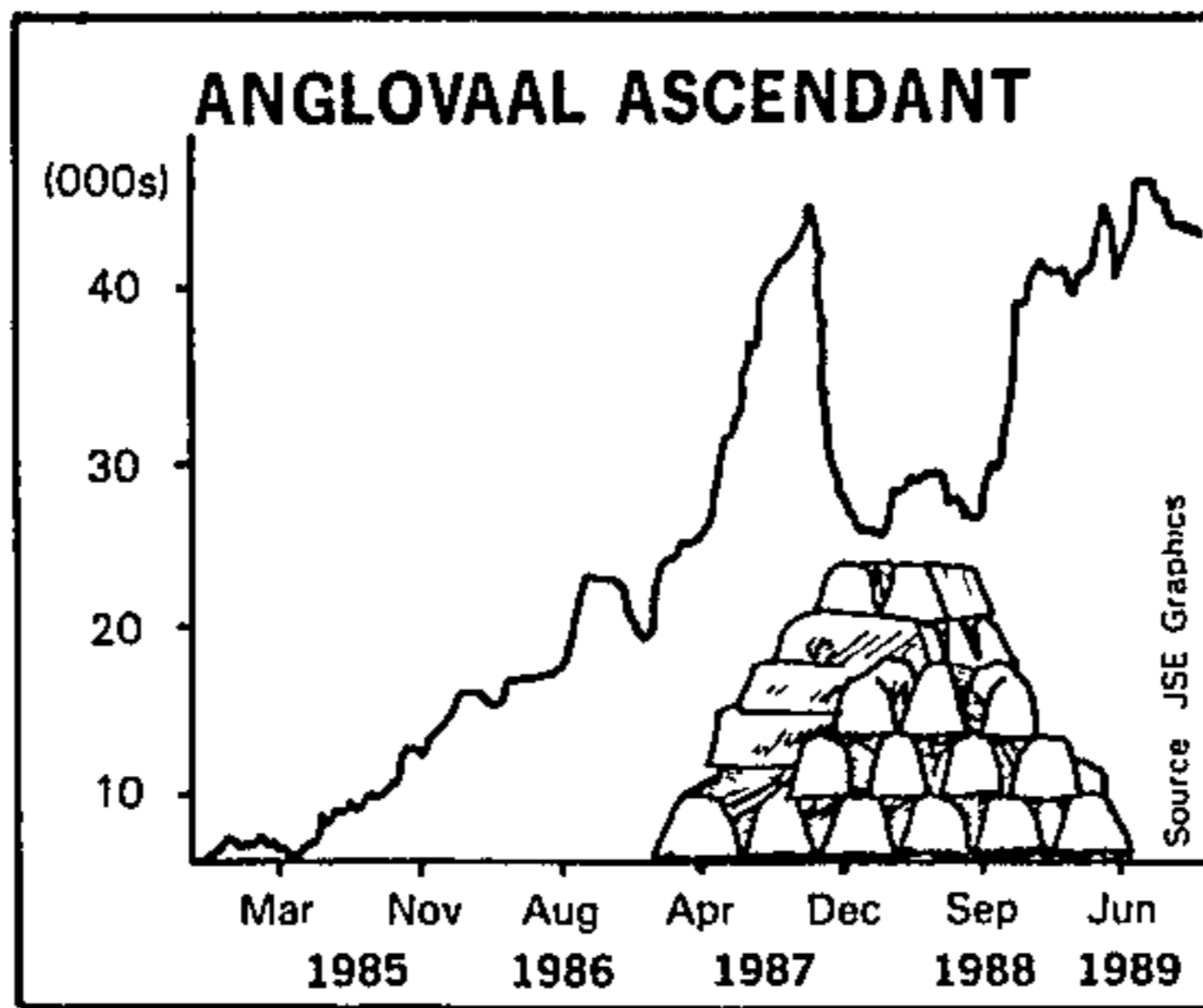

food, teas, coffees, desserts, spices and so on.

Subsidiary Pleasure Foods has yet to bring home the bacon after two years of flat earnings. It franchises and operates Wimpy, Golden Egg, Golden Grill, Juicy Lucy, Pizza Hut, Milky Lane and BJ's Pantry chains.

Another grouping of companies includes Anglo-Alpha, the Grinaker companies, and Siltek and its interests. Between them they represent 6% of Anglovaal's investments and earned the same in profit.

Siltek took control of 76% of Hewlett Packard — now Hi-Performance Systems — a few months ago.

Since the June year-end Grinaker's and Siltek's interests have been regrouped, and a new company Grintek has been listed through a reverse takeover of Mooi River Textiles.

Mooi River's business was sold to Avtex, whose subsidiaries make various textiles. It falls under a division labelled AVI Diversified Holdings, which is exactly that.

Diversified businesses include Claude Neon, Globe Engineering, Steelmetals, Gearmax and Tristel. Between them and Avtex, they made 17% of Anglovaal's bottom line.

During the year, minority shareholders in five Anglovaal Industries (AVI) companies were taken out in generous exchange for AVI shares.

The last but not least major arm of Anglovaal is Consol, the packaging giant. It makes glass, plastic and paper packaging, plastic sheeting, finished tableware and industrial minerals.

Effective from July 1 this year, it bought Goodyear which makes tyres, industrial rubber products, PVC food packaging and other films, thereby complementing Consol's existing operations.

Anglovaal's other large local acquisition this year is 42% of AA Life Assurance.

Overseas there have been developments. Anglovaal bought 29.9% of North Sea & General — now renamed Anglo Pacific Resources. At present it is made up of a block of cash and some mineral rights in the United Kingdom and in Australia. It is Anglovaal's intention to develop the mineral interests.

Mr Hersov says it is possible that a parallel group of industrial interests could be nurtured offshore.

Capital expenditure over the next three years is planned at R1.1-billion aside from the on going costs of mining exploration.

The Top 100 Companies 1989

Splits see Shares star

SHARE splits and subsequent reratings by investors were one of the features of the JSE during 1989. A 10-for-one subdivision helped York Timber into top slot in the year to September 30 1989 on an all in return consideration. The unsplit shares were the equivalent of 80c a year ago and are currently 250c after touching 300c early in September.

There were fewer than 900 000 shares in issue before the split, and trade averaged three small deals a month. The shares continue to be tightly held by family and management, but the directors hope tradability will improve.

Another share to star following a 20-for-one split is Berzack, which made fourth place among the biggest returns over 12 months.

Berzack shares were R60 — the equivalent of 300c — in January 1989, the day before the shares split. Initially the market was unable to value Berzack's prospects because it had been largely ignored by investment analysts on the grounds of poor tradability. It had traded at a large discount to book net asset value.

Yet early in October, Berzack shares changed hands at 1050c — 250% higher in only nine months. Even at the present 950c, Berzack trades on eight times historic earnings.

Its holding company Bivec split its shares five-for-one, and has gone from 240c to 750c before easing to 640c.

Tradability in Berzack is now in the hundreds of thousands rather than the few thousands which previously changed hands. Much of the scrip was held by family members who lived outside SA. The share split and rerating of Berzack gave them an opportunity to sell their holdings at realistic prices.

Two base metal mines occupy second and third positions among the year's biggest climbers. Tin was only 130c in December last year but speculation about its use

210

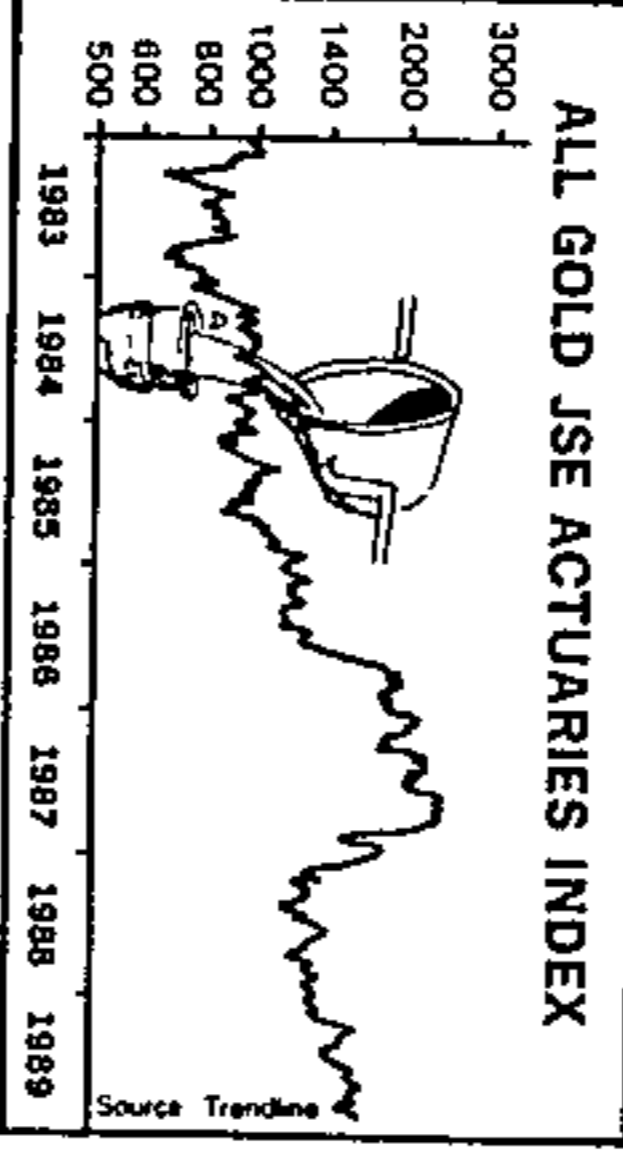
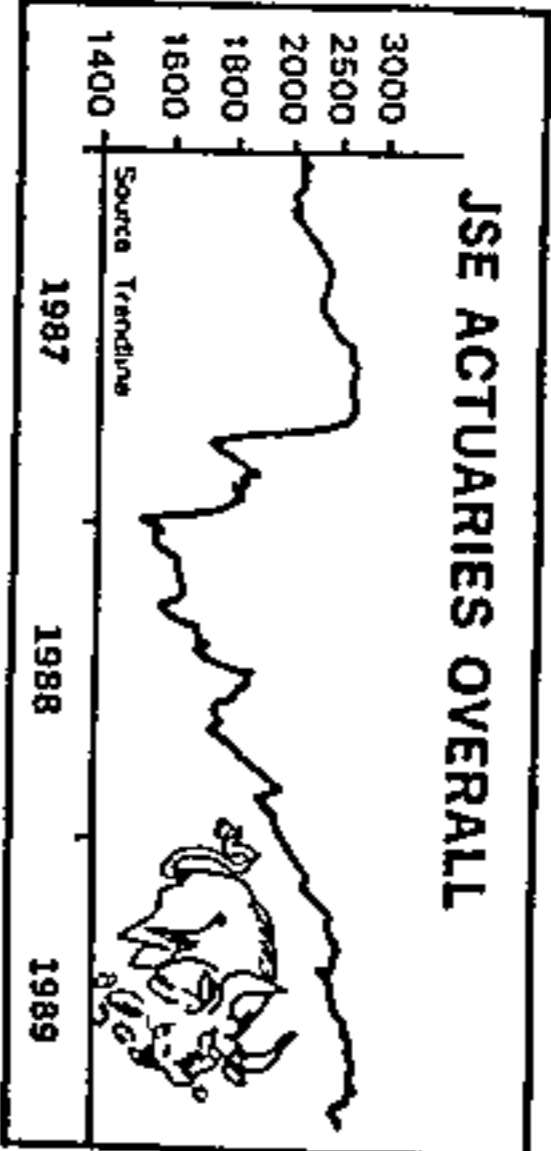

ALL GOLD JSE ACTUARIES INDEX

Msauli Asbestos zoomed under new ownership after a management buyout from Gencor. It climbed from 230c in December to 860c in June.

A boom in demand for Masauli's products from East-ern buyers improved earnings from a recently refur-bished mine and its 25% stake in the Von Brandis gold

proportion. During the year, Usko entered into a joint venture with Rho-Ex and launched Rho-Van — a vanadium mine in Bophutha-leswana. Usko will buy the vanadium for use in its steelworks.

Usko's shares climbed from 200c in December to 650c in May, but slipped to 300c after a decline in the price of vanadium on world markets.

Channel Mining managed to take fifth place after considerable underperformance in the past. Management changed during the year and the shares were rerated.

Tinting of the cutoff date was an important factor in Channel's inclusion among the climbers. Its shares went from 8c in November last year to 35c on September 21. They are now 25c.

Sunbop was the gambler's darling. Earnings from the Bophutha-leswana hotel chain climbed by 67% to 105 c a share in the year to June 1989, boosted not only by the continued success of Sun City but more by the highly profitable Marula Sun.

Sunbop's shares went from 620c a year ago to the current high of 1 675c.



LISTING FRENZY - frantic bidding for Iscor stock on the JSE

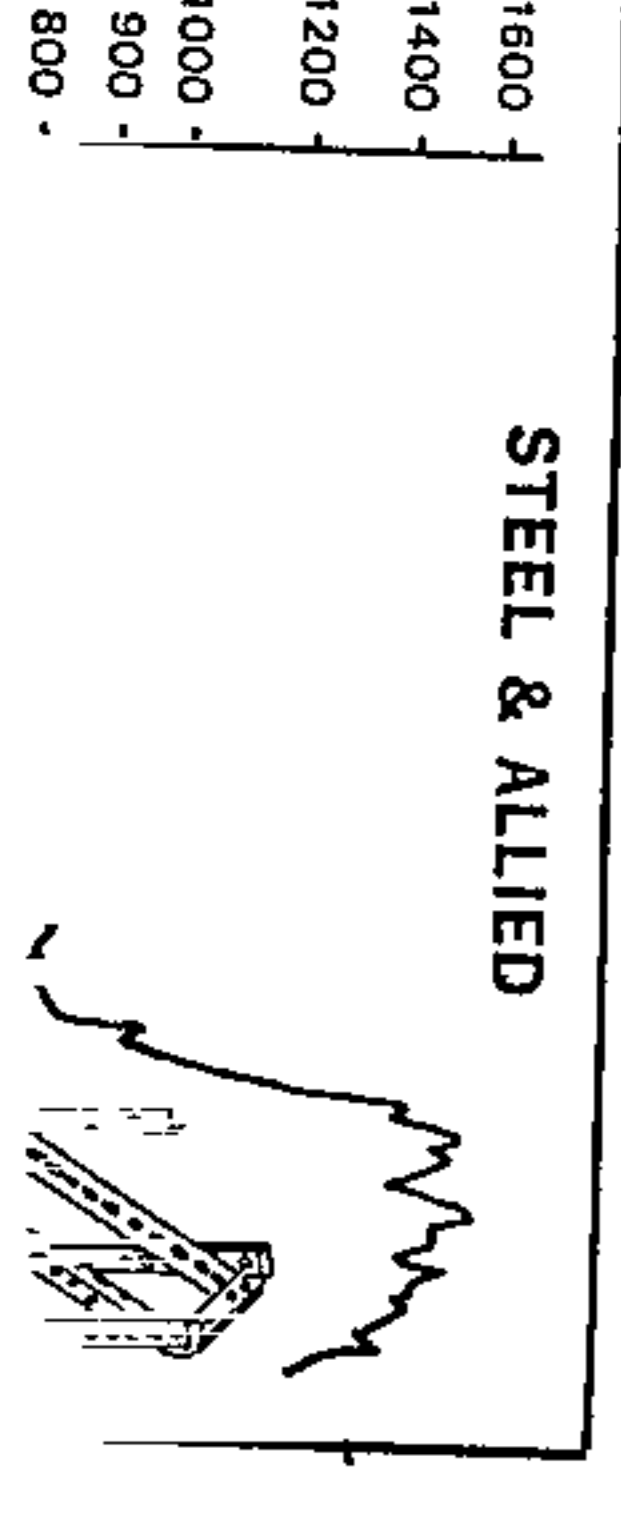
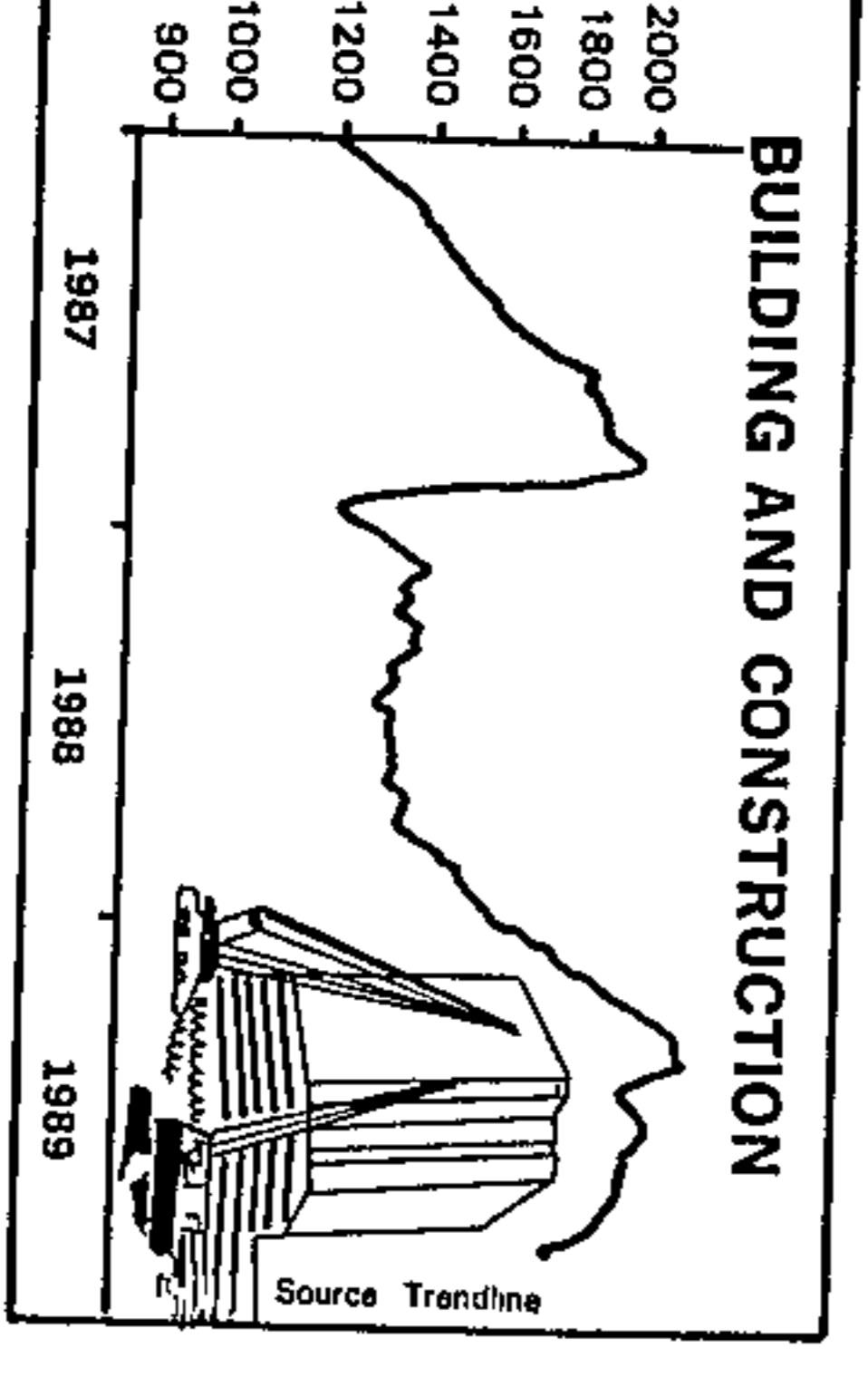
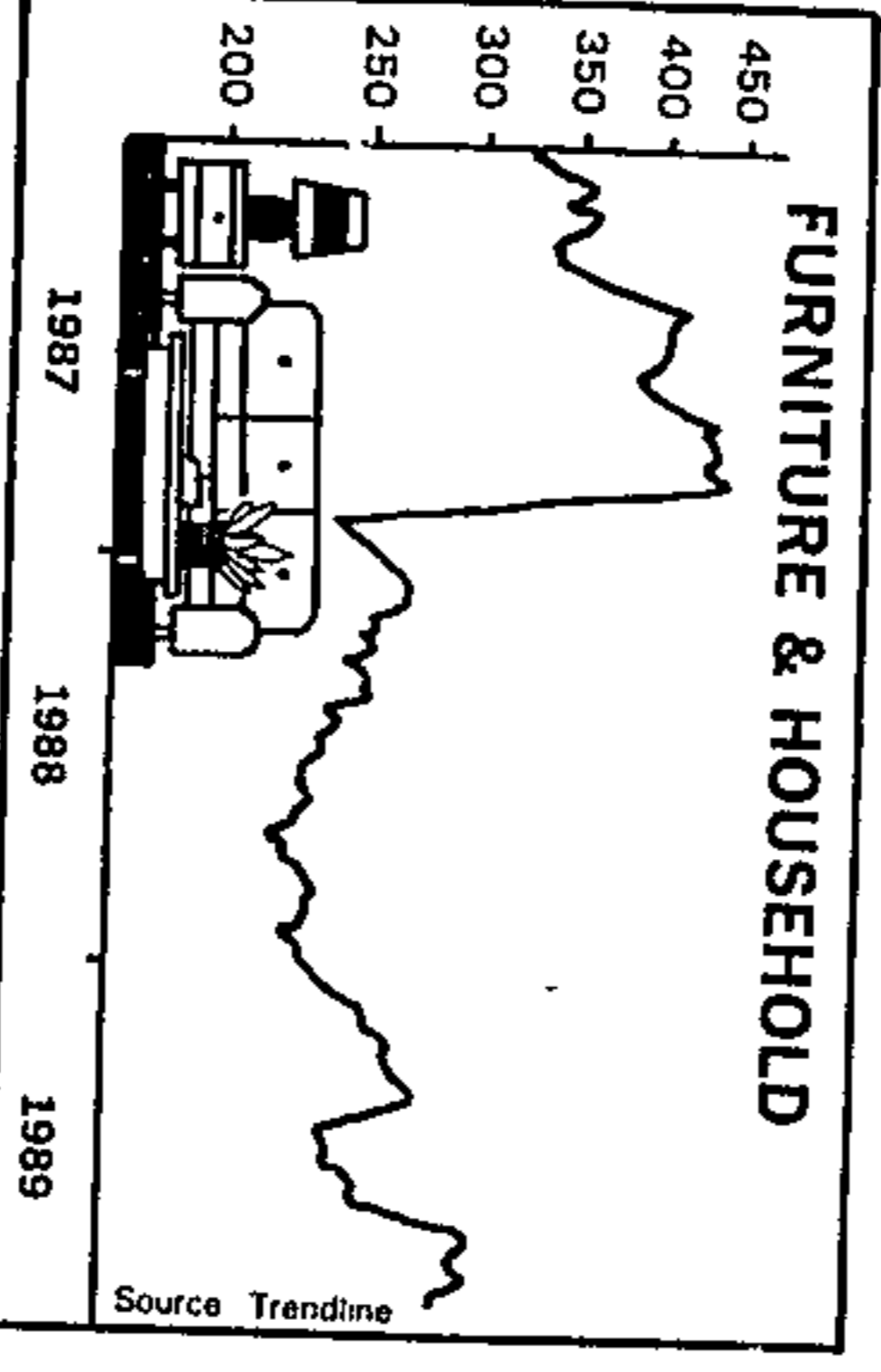
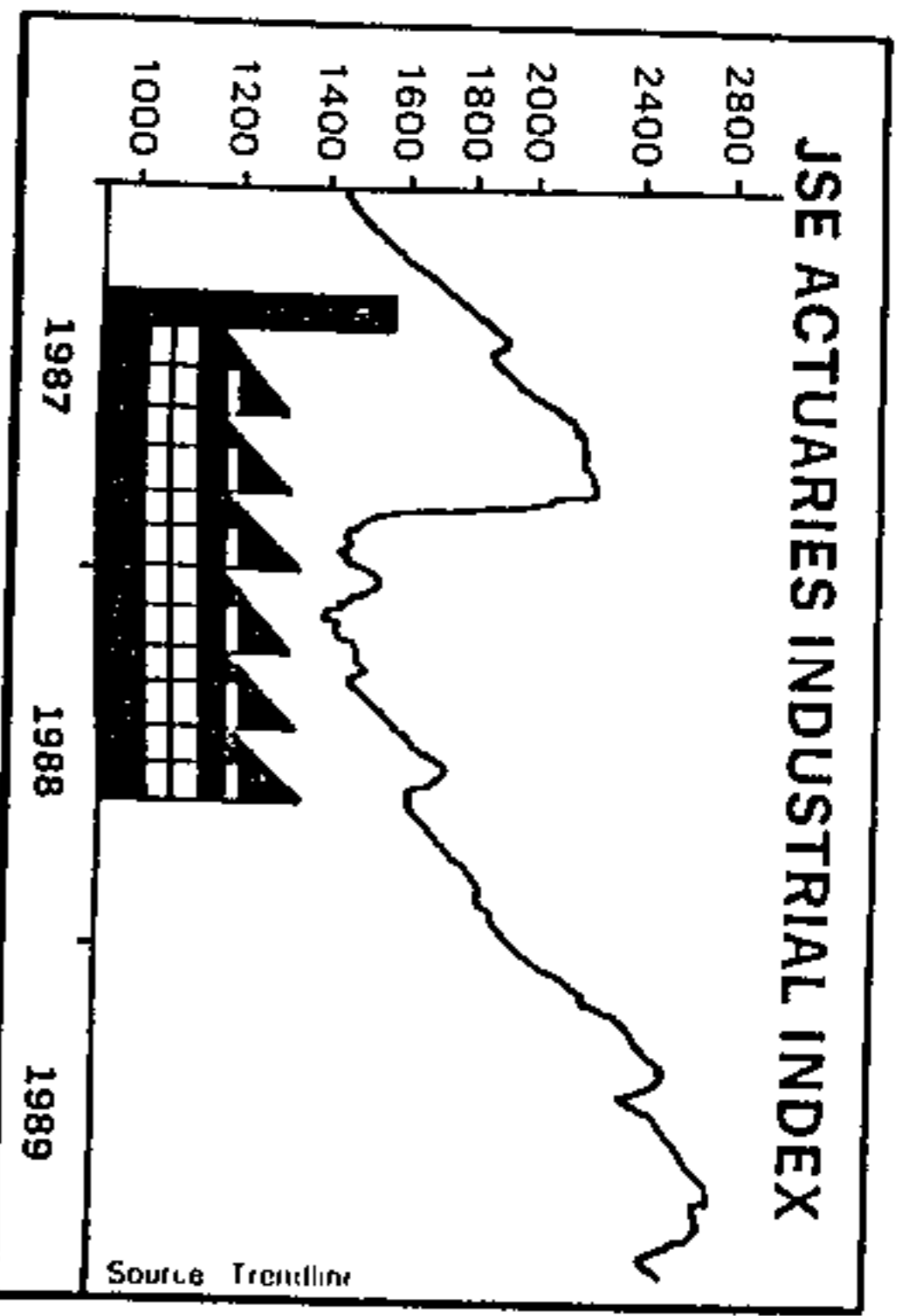



LISTING FRENZY . . . frantic bidding for Iscor stock on the JSE

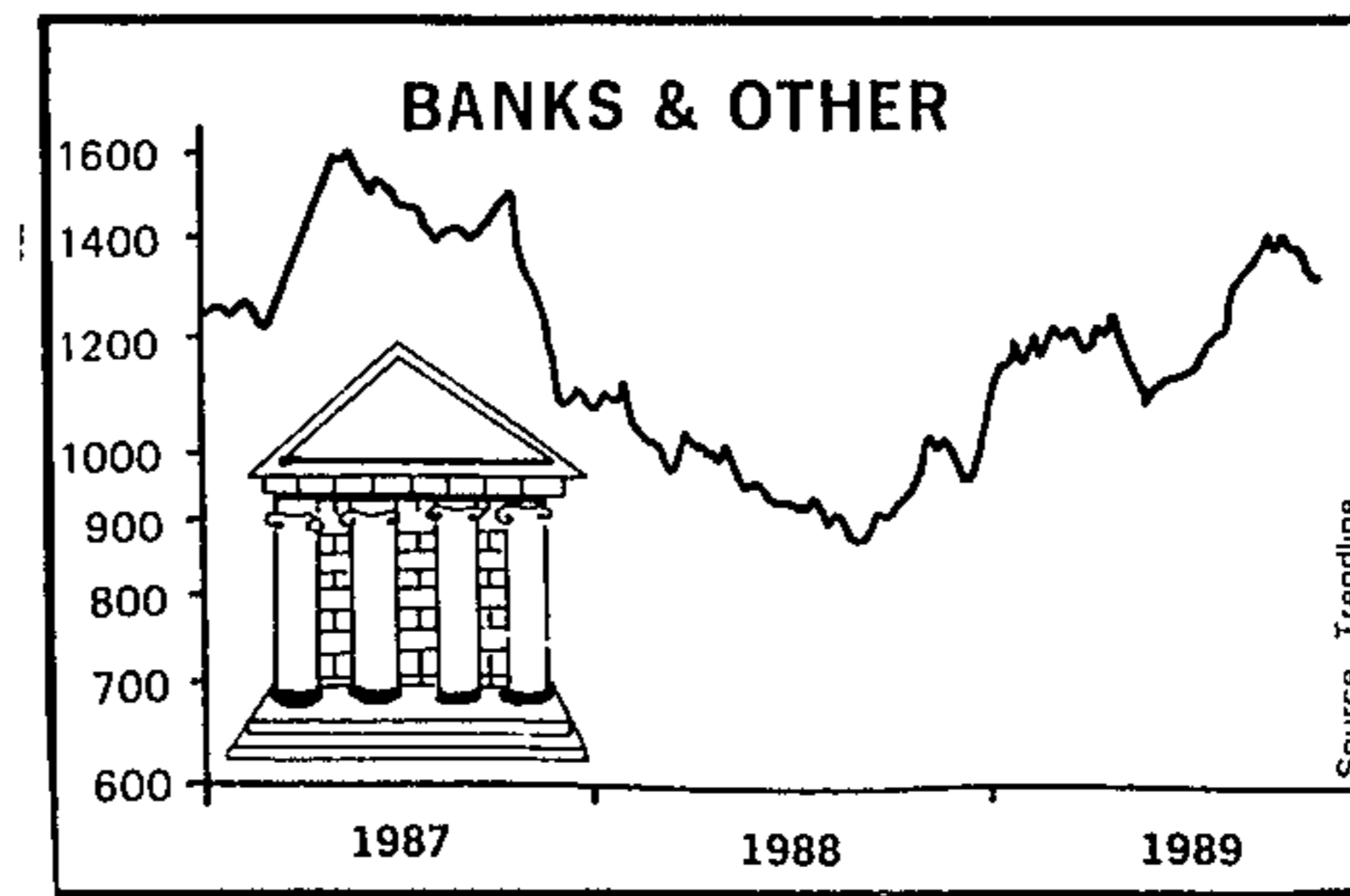
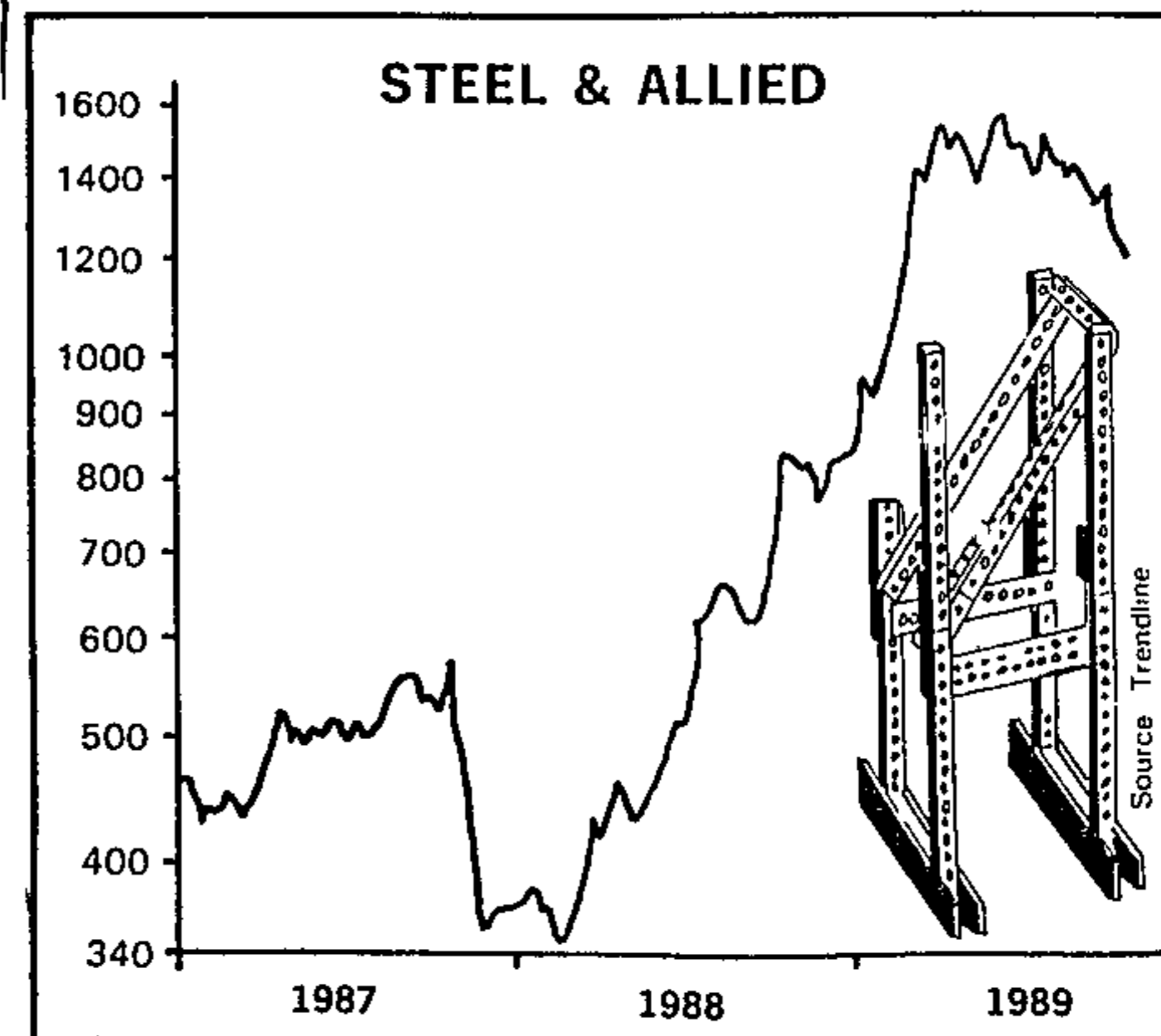
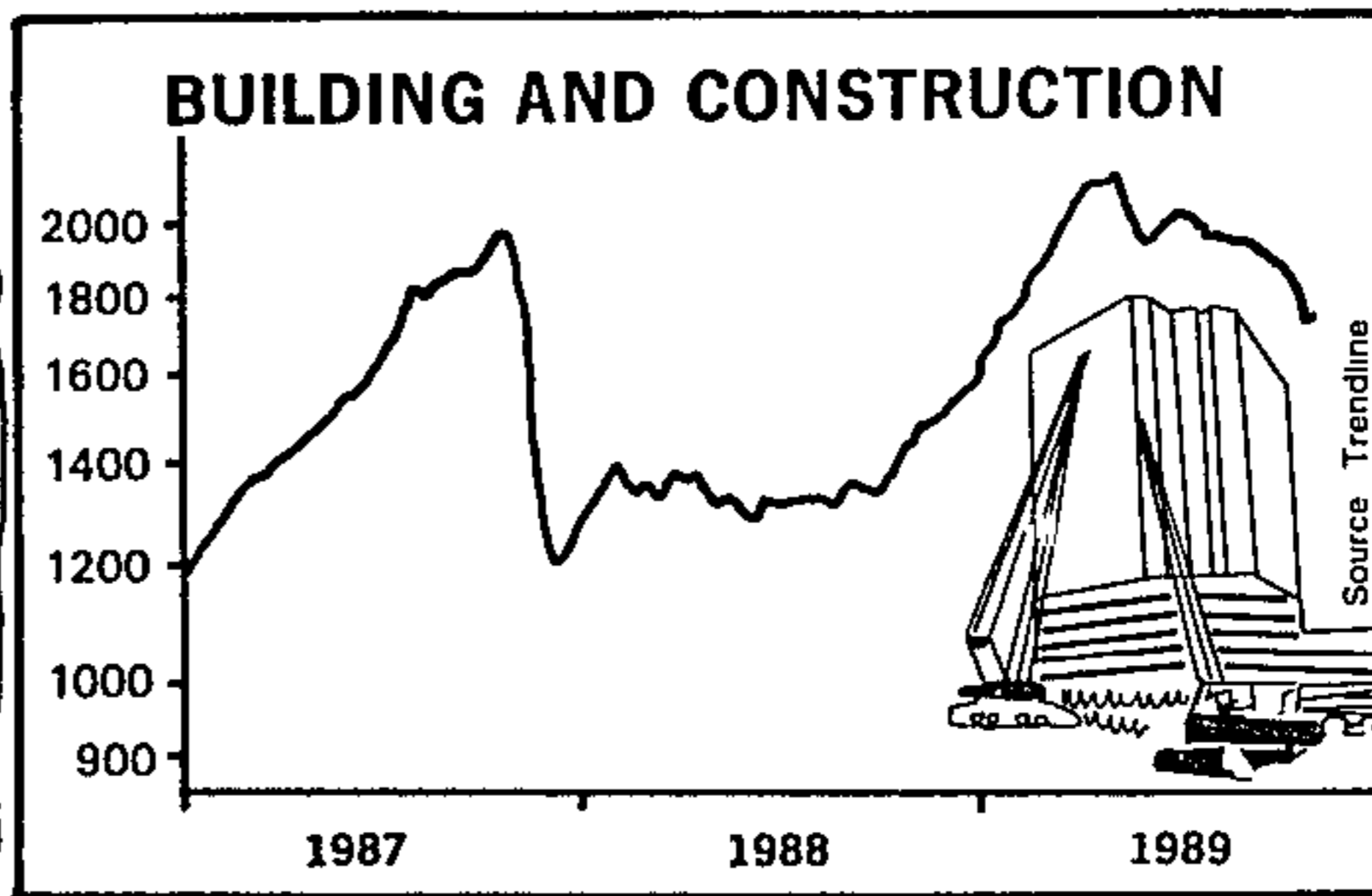
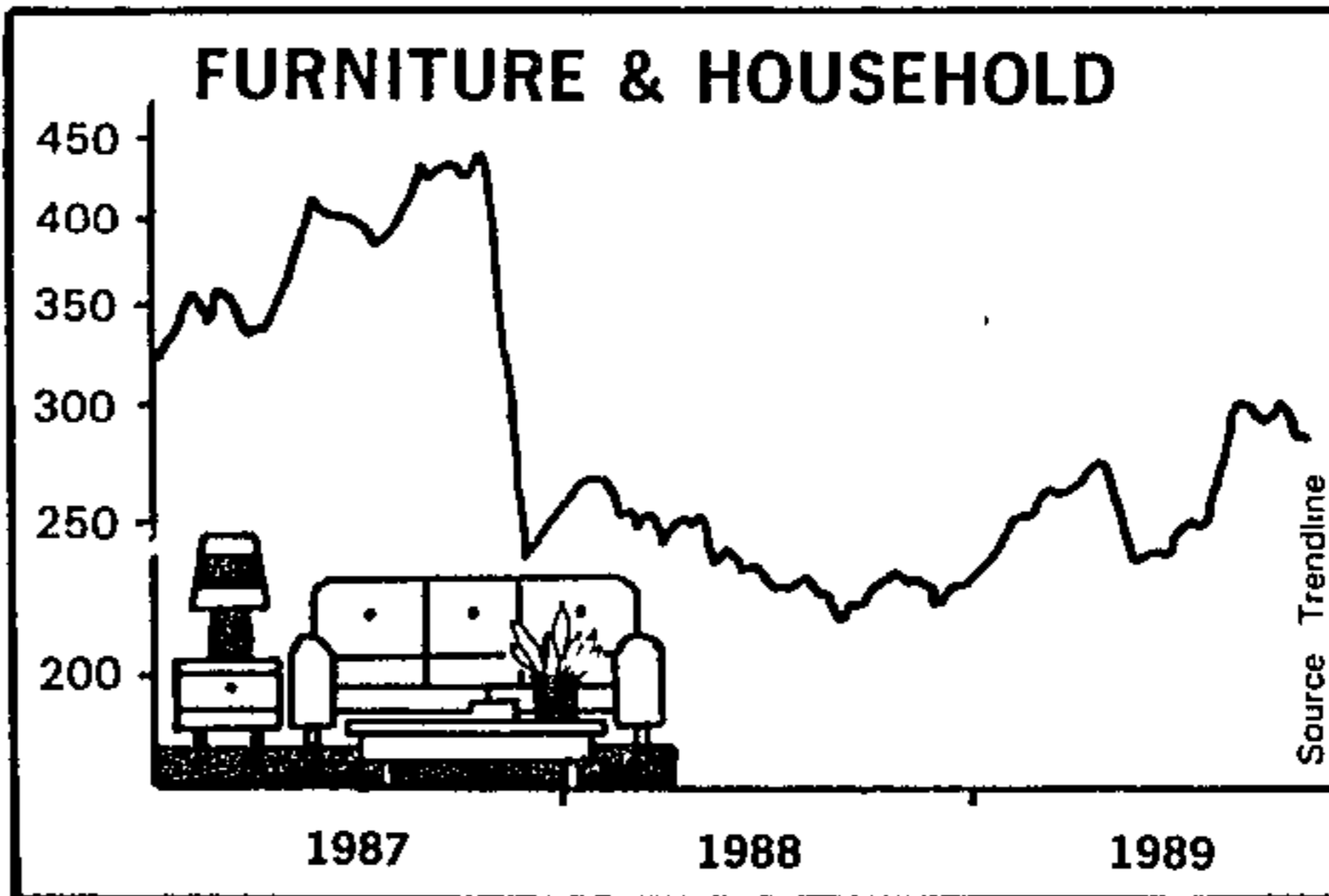
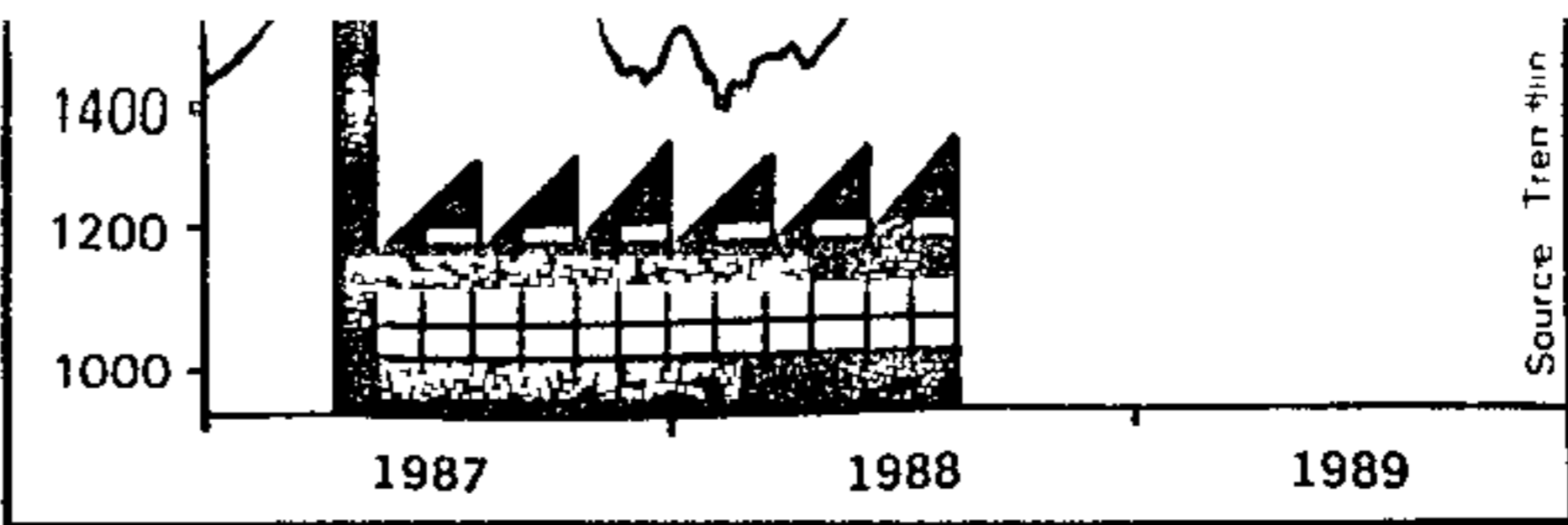

Randlord Robinson's treasures fetch £15m

LONDON — Nine paintings from the renowned collection left by SA mining pioneer Sir Joseph Robinson fetched just under £15m at Sotheby's in London yesterday

Swashbuckling Robinson, who died in Britain in 1929, founded the original Randfontein gold mining empire and was deeply involved in SA's political history, including the formation of Union in 1910

Above all, he had a sharp business eye and bought art as an investment for his heirs. Most of his reputedly huge collection, including the works sold yesterday, has been in storage or unseen by the public

Biday 7/12/89

IAN HOBBS

since his death

His wisdom showed as huge prices were raised, including a record £5.06m for a work by the Florentine master Bartolomeo di Giovanni, a panel titled The Argonauts in Colchis and dated 1487-1511. Another Florentine panel, attributed to "the master of 1487" and titled Departure of the Argonauts, fetched £4.62m. Also in the lot were works by Gainsborough and Sir Joshua Reynolds

Both the seller, a Robinson heir, and the

buyer were anonymous. It is believed, however, that more classic works from the collection are likely to be sold soon.

Robinson, given a baronetcy in 1908 for his pioneering role (with Cecil Rhodes) in the SA gold and diamond mining industry, retired to his magnificent Park Lane, London, home after the First World War.

In 1923, at the age of nearly 80 and wheelchair-bound, he decided to sell his fabled collection. But when he saw it displayed in the old Sotheby's sale room, he "fell in love with it" all over again. He put outrageous reserve prices on all the pictures — and only 11 were sold.

Gencor poised to deal with Sasol

AECI facing loss of huge contracts

B/Dam 7/12/89
210

GENCOR subsidiaries are negotiating to transfer some explosives contracts from AECI to Sasol, in a move which could cost Anglo American blue chip associate AECI R170m to R500m in lost sales.

A Sasol spokesman confirmed the negotiations last night. He said the company had "recently had commercial negotiations with Genmin". But Sasol was "unfortunately not in a position" to comment further.

All parties were tight-lipped on the issue as final details have not been resolved.

GenGold senior consulting engineer Kobus Olivier said "I can confirm that we are negotiating moving certain explosives contracts from AECI to Sasol. At this stage, the question of how much will be moved has not been finalised."

AECI MD Mike Sander said there was "nothing that special about the negotiations. They are just part of daily business".

Word that Gencor's mining interests were negotiating with Sasol started circulating on the JSE about a week ago.

One source believed the Gencor-Sasol negotiations could affect more than half of AECI's explosives turnover.

Asked how much money could be involved, Sander said the relevant division's executives were out of town and would be available only today to supply details.

Sander referred Business Day to the latest AECI annual report for the year to end December 1988. The report did not disclose separately its turnover from explosives, but it showed AECI Explosives and Chemicals Ltd produced R859m in turnover for the year.

An explosives industry source said operating companies in the Gencor group could

BARRY SERGEANT

account for as much as 60% of explosives sales to non-Anglo-associated companies. At best, AECI could retain as little as 30% (in money terms) of existing contracts, if the Gencor-Sasol deal was concluded.

On a rough assumption that AECI's R859m turnover was all produced from explosives and explosives accessories, the company could lose R170m to R500m when the negotiations were concluded. But the true figures could be anything between R100m and about R350m.

Analysts said Gencor was a large user of explosives as it was exposed to more hard-rock blasting than other mining houses.

Gold Fields of SA moved most of its explosives business from AECI to Sasol about 18 months ago.

Sasol has been in explosives for about three years and in its annual report to June 24 1989 it said "Sales of all explosives products showed satisfactory growth during the year under review. Increased marketing activities, on both the local and export fronts, enabled SMX (Sasol's mining explosives division) to contribute to group profits for the first time."

When the report was released, Sasol executives said an aggressive offshore marketing arm had been established.

Analysts said AECI's dominance in explosives had been linked to its supply of blasting accessories such as detonators. They believed Sasol had overcome this obstacle by importing technology and aggressively marketing its combination of products.

The analysts said the imminent contractual arrangement between Sasol and Gencor could severely test the customer loyalty of Anglo mines.

St Lucia

mining is
subject to

assessment

Star 21/1/89
DURBAN — No mining at St Lucia will take place until a full and independent environmental impact assessment of the proposed venture has been undertaken and the assurance given that it would not result in permanent environmental damage.

This was said by the leader of the National Party in Natal and chairman of Natal NP working group on the environment, Mr George Bartlett. He was commenting on the proposed mining at Eastern Shores, St Lucia, and related environmental issues.

"Our recently formed working group on the environment has been and still is giving serious attention to these matters ... We are of the opinion that in assessing this highly emotive issue a number of major considerations have to be taken into account."

JOBS

He said the proposed mining lease lay outside the Natal Parks Board land and inside the State-owned forestry land, and was located high up on the coastal dunes, way above the lake itself and the wetlands.

"Sight must not be lost of the fact that the present-day potential value of the proposed mining venture is approximately R7 000 million in 1989 rand values."

"The extraction operation will not only earn much and needed foreign exchange but will also create many jobs."

"Our working group is at present also actively canvassing the possibility of the creation of a large new game reserve encompassing St Lucia Lake, Mkuzi and Sodwana," he said. — Sapa.

am
eir
ck
p-
re-
ny
ds,
ith
ga
rg,

t
k's
to
me
in
of
CI.
he

The centre was sold because the bank now has its Sandown management training centre.

Mr Hoffmann says: "We think R20-million was reasonable. There is potential for expansion."

● From Page 1

counts to net asset value. There is little sense in being penalised further.

What is Sankorp's function? Why did it not stay part of the Sanlam life company portfolio? *3 Times*

Mr Daling says: "As you know, these investments were part of the investment portfolio and it is only after we stripped them out and exercised our control function through Sankorp that we managed to turn so many around. *16/12/89*

"I used to run Sanlam's portfolio investments and I can tell you there is a huge difference between merely investing and overseeing go-

Sankorp *210*

ing concerns. A portfolio manager is more concerned about what the market will think of a company's performance than its actual performance. He also cannot take the long-term view that a controlling company can.

"When the market is high, a portfolio manager is thinking about selling shares. At that stage, a company's management is often considering a rights issue, so there is often a contradiction in direction.

"I have no doubt that the establishment of Sankorp was one of Sanlam's better strategic moves."

Low-key Sankorp hits No 5 in profits

SANKORP, the unlisted holding company for Sanlam's controlled interests, is SA's fifth most profitable group.

After hoisting taxed profit by 55% to R823-million in the year to September 1989, Sankorp's equity-accounted earnings rank after those of De Beers, Anglo American, Barlow Rand and Gencor

By David Carte

The little-known behemoth narrowly shaded the taxed profits of Eskom and Iscor in 1985, the group had numerous problem companies and reported a loss of R6,2-million

With most underlying share prices, notably those of Gencor and Messina up sharply, the market value of Sanlam's huge conglomerate soared by 79% to R5,9-billion.

Plums

Business Times reported earlier this year that many Sanlam controlled lemons, such as Tedelex, Kanhym, Kohler, Messina, Abercom, Protea Nissan and Tradegro, had turned into plums.

Well, as the above number demonstrates, the fruit has continued to sweeten. The performance of Sankorp has been an important reason for the good investment results achieved by the life assurer in the past five years.

Still, returns from several subsidiaries, such as Bankorp, Tradegro, Sentrachem and Federale Volksbeleggings, are not up to scratch.

Chief executive Marinus Dalling hopes that by bringing these operations to satisfactory profitability, Sankorp can counter the effects of the looming economic slowdown. Mr Dalling says "Much of the improvement comes from Gencor. Gencor contributed R287-million, or fully 35% of equity-accounted earnings.

"Our investment in Gencor is worth R3,2-billion after we followed our rights at a cost of R416-million."

Distressed

Second-biggest profit source was former loser Automakers, holding company for Nissan and its busy pressing shops. Automakers turned over R2-billion and made more than R100-million after (minimal) tax in its most recent year.

Mr Dalling says "John Newbury and team have done a fantastic job at Automakers. Return on assets is still not outstanding, but you must remember we acquired Nissan in a distressed state through Messina. Our return on investment is looking pretty good even though we had to inject a lot of new money. There is much better to come."

Other major contributors to Sankorp in the past year were Bankorp (R69-million, or 8%), Anchusa (R50-million, 6%), Messina (R50-million, 6%), Sentrachem (R30-million, 3,6%), Santam (R23-million, 2,8%) and Tradegro (R22-million, 2,7%).

Sankorp received dividends and interest of R250-million last year, but Mr Dal-

ling warns that there is an anomaly in the numbers because Gencor Controlling paid three dividends in the year not two

For comparative purposes, dividend income was R200-million — up 33% from R150-million and there is every prospect of 30% growth in the current year. Dividends are paid straight to Sanlam.

The cash does not flow one way. Before he died, chairman Fred du Plessis announced that in the interests of greenfields real investment, the life assurer would make R2 billion of new money available to Sankorp companies in the next five years.

It will be up to them to find investment projects that create jobs and at the same time yield a good long term return. Sankorp and its subsidiaries will draw the money only as it is needed.

Divergent

The R416-million spent on the Gencor rights is not included in the R2 billion, which has yet to be touched. The Impala Messina platinum venture will soon require large amounts of money.

In spite of the success of its underlying investments Sankorp paid out more money last year than it received. It will spend R200-million to R250-million on recapitalising Bankorp.

Six weeks ago, when Clive Wolf became the seventh top man to leave Tradegro I at fronted Mr Dalling by suggesting that Sanlam's (and by implication Sankorp's) bureaucratic style might have been a cause.

He says "Bureaucratic is what we try hard not to be. We lay down no group policies of any kind and we don't ask downline companies for reports every month."

"We permit widely diverging company philosophies and cultures in the Sankorp group. We make it our business to keep out of the way, unless our intervention is absolutely necessary."

Foster

"We try to foster an environment in which management can flourish. As board members, we try to help with strategy."

"There are 21 people at head office, including support staff. There are only 10 managers on this staff, hardly enough to monitor every move our companies make."

Sankorp will never be listed because investment holding companies always trade at a discount. Already Gencor, Federale, Sentrachem and Tradegro stand at dis-

● To Page 3

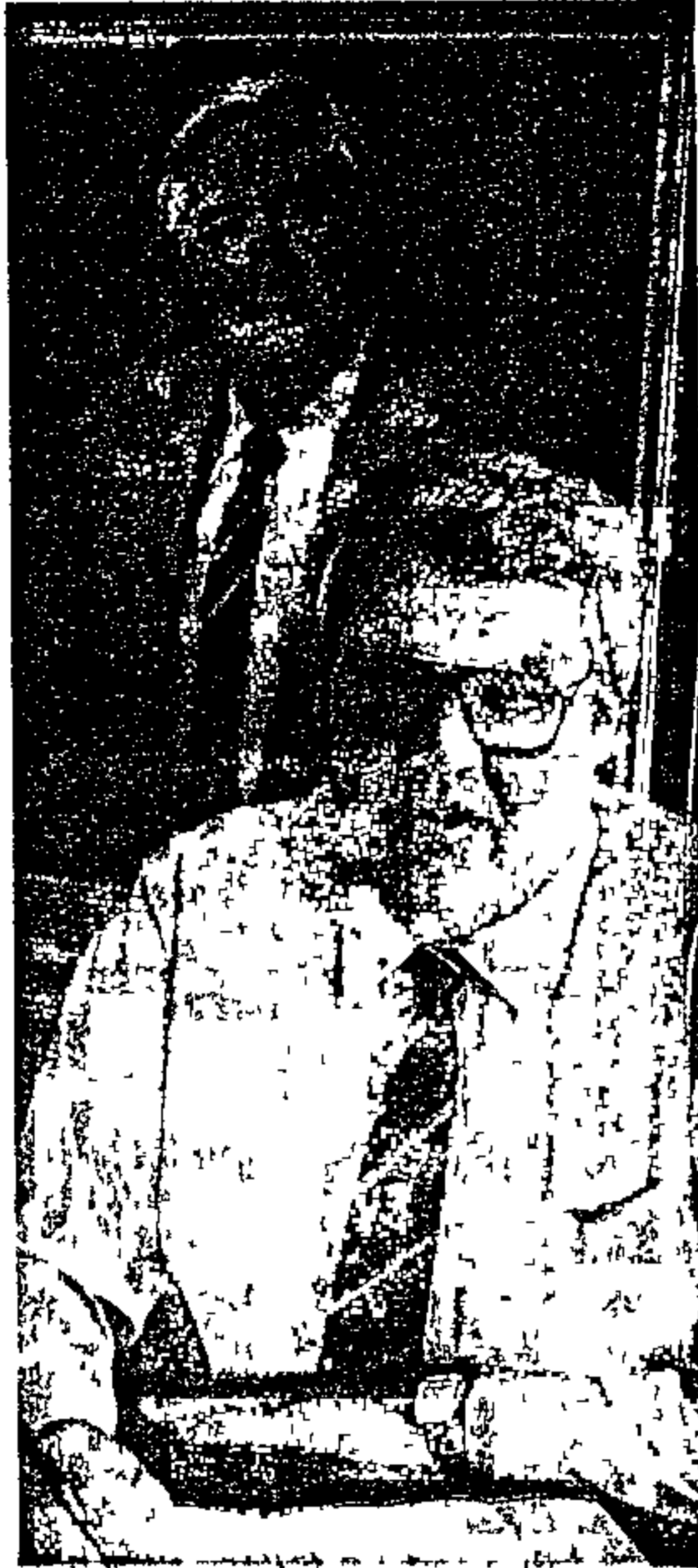

Over my shoulder in Johannesburg headquarters. Sankorp chief executive Marinus Dalling and portrait of former Sanlam chief executive Fred du Plessis. Picture: Pierre Ooosthuysen

Mid Wits soars on Venetia stake

By Julie Walker

MIDDLE Wits shares leapt by 25% to 650c this week when development of the R1 billion Venetia diamond mine was confirmed.

The Anglovaal mining holding company has been one of the stars of the sector on the strength of its mineral rights, having more than doubled in price this year. Announcements are expected soon on gold mining in the Northern Free State where Mid Wits has extensive interests.

The Venetia go ahead spurred buying of Mid Wits on a soaring JSE. Its shares were the equivalent of R3 in January, having split 25 for one recently.

Venetia will bring much-needed employment to the North-western Transvaal. Open-cast mining will be used to exploit two of the kimberlite pipes while another 13 are studied. An application has been made for

Messina — the closest town to Venetia — to be declared a free settlement area.

Diamond production should begin next year when the pilot plant has been upgraded. The main recovery plant should be completed in 1992, full production being reached the following year.

More than 3-million tons of ore will be treated annually, and 4-million carats of medium-quality stones produced.

Although De Beers will provide the capital and operate the mine, the holder of the rights to precious stones over the farm is Saturn Mining. It is 22% owned by Anglovaal and 65% by Mid Wits.

After recoupment of the initial capital outlay, profits will be shared equally between De Beers and Saturn.

Conscript cut could save a billion rands

By Charmain Naldoo

HALVING of national service could result in an annual saving of R1-billion for taxpayers.

This is the opinion of James Self, President's Council member and Democratic Party director of communications.

Government sources refuse to confirm the figure, saying announcements will be made soon about the restructuring of national service.

Mr Self says that determining the direct and indirect costs of national service is difficult. The amount spent on conscripts when compared with the total defence budget is minuscule.

Engineer

"This year's defence budget is slightly more than R9-billion. The lion's share goes on salaries for the Permanent Force, equipment purchases, research and development."

He arrives at the R1 billion savings figure by looking broadly at national service intake figures — an average of 27 000 a year — pay accommodation, food, entertainment, transport and arms.

"It's difficult to put a price on the indirect cost savings that will result from a year less in the army. Take an engineer who's invested a lot of money and time to get a degree. He then spends two years in the armed forces. You cannot easily put a price on his non-productivity as an engineer."

Confidence

Assocom statistician Ed Verburg says: "Considering that between 350 000 and 400 000 people come on the job market every year, the estimated 27 000 people taken in by the army amounts to a very small percentage."

Assocom manpower secretary Vincent Brett welcomes the reduction "from the point of view of the confidence that it engenders — it shows that our country is no longer at war."

This confidence will have a spin-off, working its way into the economy.

"But most of the people destined for national service are unskilled school leavers. This means a larger number of school leavers looking for jobs."

University of SA head of strategic Studies Deon Fourie says: "More people will be available for the economy much more quickly

TV flicker without flicker

By Don Robertson

A NEW TV system — the D2 Mac — is due to replace ageing PAL in the next two years. But it will not make existing TV sets obsolete.

The SABC is expected to start testing the D2-Mac in the next 18 months and could introduce it six months later.

High-density television (HDTV) using satellites for beaming programmes will be introduced in 10 years. HDTV doubles the number of lines on a TV screen to 1 250 to give a flicker-free picture.

D2 Mac was developed by the French Thomson Grand Public group, the world's third largest electronic company. It also developed PAL.

Federale Volksbeleggings subsidiary Tek has access to the new technology.

The SABC will change to D2 Mac without much expense.

Tek will start production of CD disc players in February and will consider the production of VCRs early next year.

Tek is considering the introduction of digital technology at its Port Elizabeth plant to meet the demands of the entertainment electronics industry.



A new gold mine to be established on a Orange Free State 8 kilometres south of Extensive d Ventersdorp Contact 1100 metres below ('Weltevreden') will previously known as The mine designed to reach a month, with work

the ly when the new system was implemented.



● SUNTER



● GUSH

210

Gush to quit Anglo executive position

By Day REINIE BOOYSEN 22/12/89

THE Anglo American group has announced a number of executive changes, the most significant being the resignation of gold and uranium division chairman Peter Gush, 51, from all of his executive appointments.

He is to be replaced in the gold and uranium division, as of April 1 1990, by fellow Oxford graduate Clem Sunter, 45, a rising star in the Anglo firmament better known for his widely publicised "high road, low road" presentation.

Sunter, already an Anglo director, now moves, as of January 1 1990, to the Anglo's inner sanctum — the "executive committee" — as an executive director in charge of the group's most glamorous business division.

He is also chairman of Anglo's "administration committee" and of Anglo American Property Services.

An Anglo statement yesterday said Gush was resigning in order to pursue "his own interests". It added, however, that he would remain a member of the board and would be available "to the Corporation for

□ To Page 2

P.T.O.

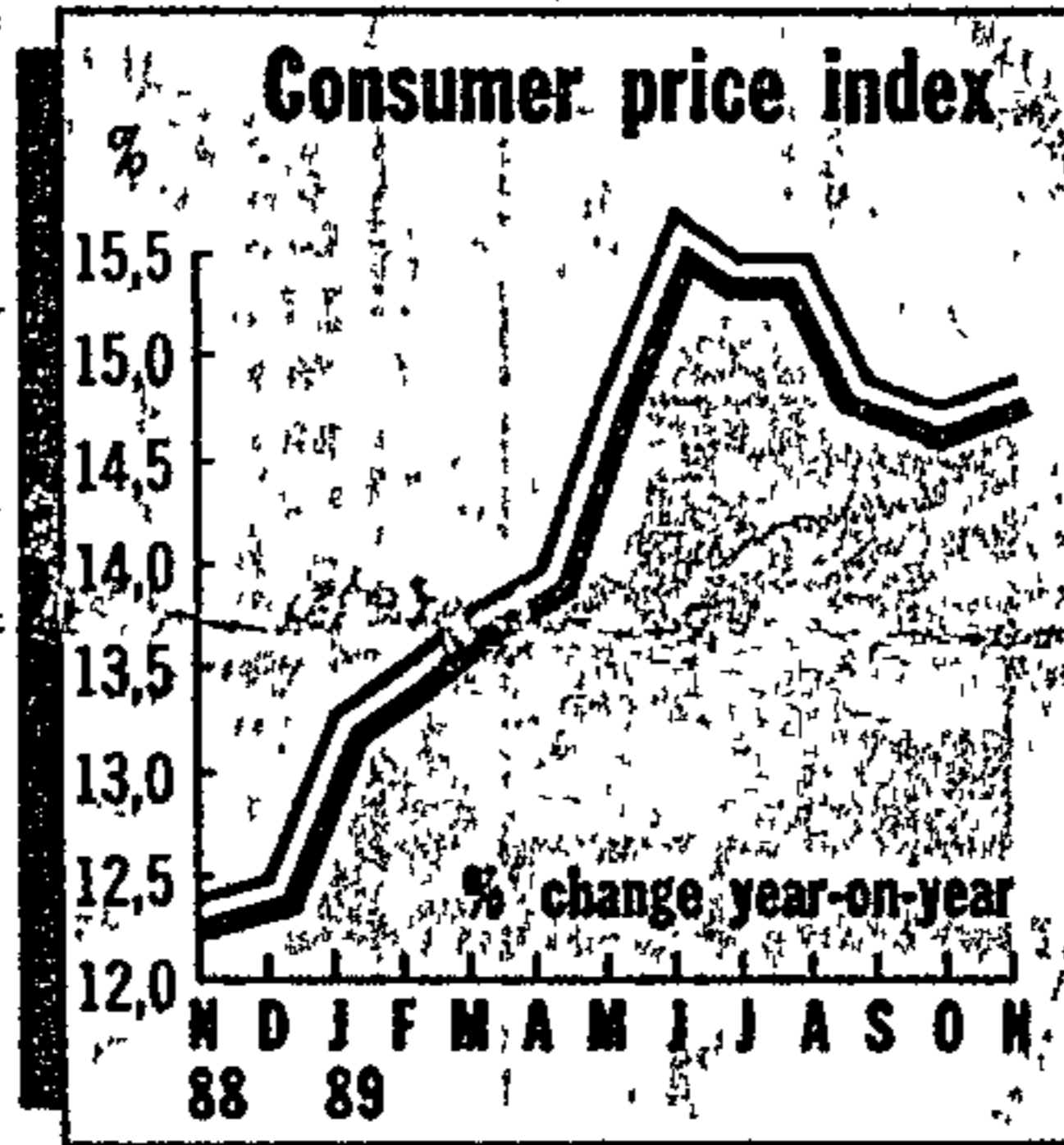

Graphic: FIONA KRISCH Source: CSS

P.T.O.

Anglo man

special assignments".

The other moves are:

□ The appointments, as of January 1 1990, of Peter Leyden, 58, and David Rankin, 58, to the executive committee. Leyden was already a director of Anglo and its sister company, De Beers, and he is joint MD of the Diamond Services Division. Rankin is MD of Anglo's coal division and was previously an Anglo director.

□ Jack Holmes, an Anglo executive director, becomes group technical director as of January 1, and Anglo director Theo Pretorius becomes technical director (mining) and deputy group technical director.

□ Anglo director Lionel Hewitt becomes MD of all the gold and uranium division

(210) □ From Page 1

operations from January 1.

Anglo chairman Gavin Relly said yesterday Gush had made a major contribution to the group's affairs for 25 years "as a key member of our finance division, then as the chief executive of the group's interests in North America and most recently as chairman and chief executive of our gold and uranium division.

"In his most recent role Mr Gush was the architect of the restructuring of our Free State mines into their present consolidated Freegold form. Under his leadership the gold and uranium division has responded effectively to its major challenges in the areas of exploration, cost controlling, safety and industrial relations."

Anglo puts Sunter in key post

By Sven Linnsehn
Clem Sunter's swift rise up the Anglo American corporate ladder continued yesterday, when he was appointed chairman and chief executive of the gold and uranium division

With effect from next April he will replace Peter Gush, who has indicated his intention to retire from his executive appointments in Anglo in order to pursue his own interests

However, Anglo American said yesterday that Mr Gush would remain a member of the board and be available to the group for special assignments

Speculation that he might join mining group JCI were denied by an Anglo spokesperson
Mr Sunter's appointment as

head of the gold division, historically the most important contributor to Anglo's earnings, came as a surprise to many analysts

He was only appointed to the board in July 1987 and has since then been in charge of administration and scenario planning

He is best known as the author of "The World and South Africa in the 1990s", in which he eloquently describes the political and economic options available to the country

Mr Sunter also becomes an executive director of the Anglo American board, to which De Beers' director Peter Leyden and Arnco's MD David Rankin were also appointed yesterday. The appointments to the executive committee, the most important deci-

sion making body at Anglo, become effective in the new year

Among other important promotions, Lionel Hewitt becomes managing director of all the operations of the gold and uranium division

Jack Holmes, already an executive director of the group, becomes group technical director, while Theo Pretorius will be appointed technical director (mining) and deputy group technical director

Anglo chairman Gavin Rilly said yesterday "It is with regret that we acknowledge Peter Gush's retirement from an executive role

"For the past 25 years he has made a major contribution to the affairs of Anglo American"



Clem Sunter