

~~ABER~~ MANUFACTURING - MOTOR INDUSTRY

1994

JANUARY - DECEMBER

rt

Car rental firms in bumper security bid

By MAGGIE ROWLEY
Deputy Business Editor

A MAJOR security clampdown is being implemented by the car rental industry following an increase in value of more than 20% in vehicles thefts last year

Among measures already in place, according to the big three — Imperial, Avis and Budget — are more selective rental criteria with clients being required to cover any excess on stolen vehicles, and the hiring of private firms to track stolen vehicles

In addition the industry is implementing improved housekeeping measures particularly regarding the early collection of vehicles from clients and is investigating employing electronic tracking systems for their rental fleets

Avis chairman Glen van Heerden, said thefts at Avis had risen 21% in value last year over 1992 with the number of units stolen showing an increase of 12,5% on the previous year

Total thefts from the industry last year,

he said, totalled about R15m to R16m — equivalent to that of 1989 when the industry was booming. Since then rental fleets had fallen in size by about 28%

"So in real terms the percentage of vehicles in the industry which were stolen last year represents a much larger increase, more in the order of 50%," he said

The increase in the number of hijackings of rented cars, particularly in the Transvaal, had been the cause of grave concern, he said

Clients, who were now required to cover part of the excess on stolen cars, had become more careful in preventing thefts

According to Tony Langley, MD of Budget Rent a Car, the number of vehicle stolen from his company last year was up 23,6% in value terms on the previous year

However, through the employment of outside tracking firms, recoveries were now in the order of 60%

Langley said cash rentals in the luxury car hire sector had been stopped and clients requesting luxury model cars were required to provide two credit cards for clearance purposes

CTS/1/94

192

Thefts of motor vehicles rented from Imperial Car Rental soared by 22% in value in the past year according to MD Carol Scott

She said while up significantly on the previous year, figures were still below those for 1989 when the SA car rental industry lost motor cars valued at R16m

Scott said they were self-insured so that theft figures were straight off their bottom line

These losses, however, had been offset by excellent growth in Imperial's used car division and continued success with its chauffeur driven rentals and taxi service

The industry, meanwhile, is forecasting an improvement in both volumes and profits for 1994 with car rental fleets being increased by between 5% and 15% at a total cost to the industry of more than R500m

Van Heerden forecast that the number of car rental days would show real growth of 8% this year but pointed out that it would require more than a couple of good years' growth to put the industry back at the peak levels of 1989

Numsa renews pressure on Samcor

NUMSA announced yesterday that about 2 500 Samcor workers would not report for work today at the company's Pretoria car manufacturing plant because of the continuing dispute over the taxation of year-end gratuities.

Numsa national organiser Gavin Hartford said an urgent meeting of the national bargaining forum had been called for today to review the dispute, which led to the early closure of Toyota and Samcor plants last year, both of which were hit by unprocedural strikes.

Hartford said Numsa members' action depended on the employers' response. In December, the Re-

ERICA JANKOWITZ

ceiver of Revenue confirmed that employers were correct in deducting tax from the ex gratia payments which formed part of the national bargaining forum wage agreement.

Hartford said Nissan, Delta and Volkswagen plants reopened last week after the year-end break and Toyota would follow suit today.

BMW and Mercedes-Benz would reopen on January 17 and 24 respectively.

"The situation in the industry remains tense in those plants which have resumed production as workers discuss an appropriate response to the decision of

the Commissioner of Inland Revenue," Hartford said.

Toyota human resources director Harry Gazendam said yesterday: "As far as we are concerned the issue which led to the illegal strike action last year has been clarified."

Manufacturing facilities would reopen as scheduled.

No agreement on gratuity tax

B/Sch

12/1/94

ERICA JANKOWITZ

AN EMERGENCY meeting of car manufacturers failed to reach agreement, on tax on year-end gratuities, but workers were expected to suspend industrial action pending the outcome of further negotiations, National Union of Metalworkers of SA negotiations co-ordinator Gavin Hartford said yesterday.

Speaking after the national bargaining forum meeting, Hartford said employers had agreed to furnish further information prior to a national shop stewards meeting scheduled for January 31.

Numsa and employers would meet on February 1 and 2 to try to conclude a national agreement on whether tax should be levied on gratuities and, if so, how this tax should be calculated. The delay in further meetings

had been caused by the staggered reopening of plants, the last of which was due to start production on January 24. (192)

Hartford said Samcor workers, who decided to continue the unprocedural strike which led to early plant closures in December, would meet today to discuss the outcome of the forum meeting. He expected the 2 500 workers to resume production in line with Numsa's national position.

He said tax deductions on the R300 ex gratia payment had ranged from R9 to R114 because the nine companies had used different methods to calculate the tax due. Both Numsa and employers had agreed a common position for the sector was necessary.

Motor strike ends

Toyota South Africa's manufacturing plants nationwide opened for production yesterday despite speculation about continued strike action by 19 000 National Union of Metalworkers of SA members. *Star 12/1/94*

The strike began last month when the motor industry deducted tax on ex gratia payments, a spokesman for the industry said yesterday. Numsa said the deductions were not part of the wage agreement signed at the National Bargaining Forum. —

Staff Reporter

192

[Handwritten mark]

Car sales to reflect good demand

(192) BD 13/1/95

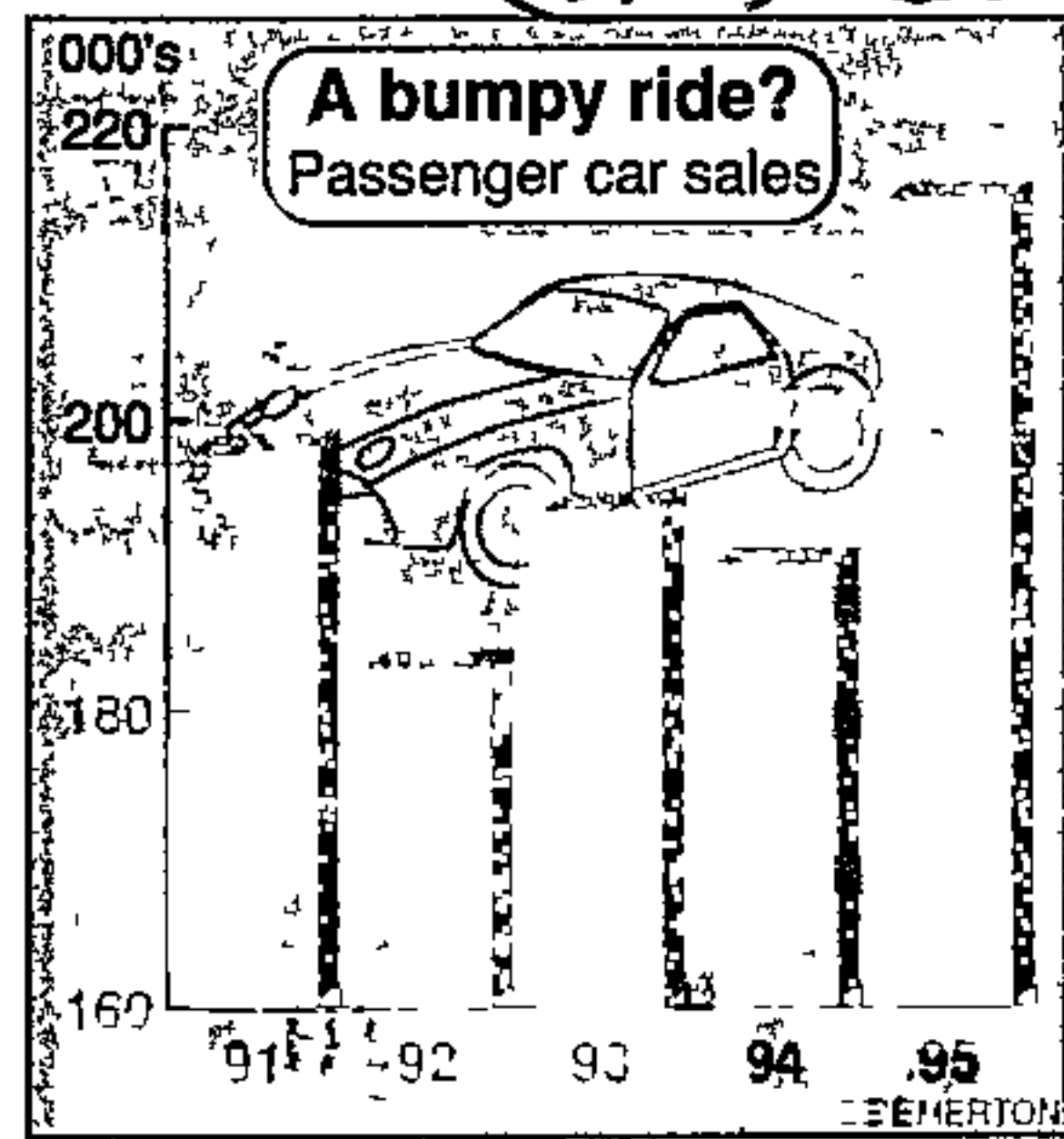

MICK COLLINS

NEW car sales figures for December will continue to reflect the market's firm undertone bolstered by underlying consumer and fleet demand, industry sources said yesterday

The figures, due for release today by the National Association of Automobile Manufacturers of SA (Naamsa), are expected to reach 14 500 — 8% higher than December 1993's 13 419 units. Sales of light commercial vehicles (LCVs) are expected to reach between 7 500 and 8 000 (6 935)

But the figures would be well down on November levels when 18 497 new cars were sold and sales of new LCVs, bakkies

□ To Page 2

Car sales (192) BD 13/1/95

□ From Page 1

and minibuses reached 11 144 units. However, analysts pointed out that December was traditionally a low volume sales month due to holidays and a general shutdown across the industrial sector.

Medium commercial and heavy truck sales are due to come in at a combined 350 units, nearly 13% up on November's 310.

While vehicle manufacturers remained "extremely bullish" for this year, last year's total car sales volume of about 190 000 units was "a bit disappointing", said Econometrix economist Tony Twine. "Before the strike the industry was looking for a market of more than 200 000 units. After the strike forecasts were revised down to between 192 000 and 195 000. December's figures are below expectations."

The industry was shaken out of its sanguine mood after the success of the April elections by the swiftness of the August

strike which paralysed the sector for 25 days. One industry source said new cars and LCVs bore the brunt of lost trade.

"Despite the strike, growth throughout the year was underpinned by replacement demand, strong demand for new models, a perceptible improvement in business confidence levels and indications of a firm economic recovery," he said.

Naamsa is expected to be bullish about prospects for the year, with an increase in gross fixed investment coupled with spin-offs from the reconstruction and development programme predicted.

An industry source said sales this year would be well above last year's. He estimated total passenger car volumes for the year would be 215 000 units, light commercial vehicles 117 500, medium commercial vehicles 4 500 and heavy trucks 6 500 — giving an overall total of 343 500 vehicles.

New car prices to rise in February

B/Say 14/1194

MICK COLLINS

NEW car prices are set to rise again next month, industry sources said yesterday

The news follows this week's announcement that BMW SA was to raise prices 2%-6% across its model range. Volkswagen raised prices 2,3% on January 1. (192)

A Mercedes-Benz SA spokesman said the company had kept prices well under inflation last year. "Our objective now is to keep price increases under 2% for the first quarter. However, on the S-class the price is expected to rise by 3,1% within the next few weeks. On our Honda range we estimate a 3% increase in February."

Samcor public affairs manager Dirk de Vos said the company expected to increase vehicle prices at the beginning of February by about 3%. "The increase in prices can be attributed to losses due to the exchange rate and the yen in particular, which have not yet been recovered. Our cost base is also continually under pressure due to our local and overseas suppliers."

Nissan SA marketing MD Stephanus Loubser said: "There will be an increase of about 3% in the second week of February."

Delta Motor Corporation said it was expecting a general price increase for the Opel and Isuzu range, also in mid-Febru-

ary. Product communications manager Craig von Essen said "The adjustment is expected to average approximately 3%."

Toyota marketing MB Brand Pretorius said he could not disclose the size of the increase yet. "We are involved in discussions with Toyota Motor Corporation Japan about our pricing strategy. Due to the sensitive nature of these discussions, as well as the fact that some local cost components are also under scrutiny, a specific announcement now will be premature."

A decision was expected within a week. Pretorius said Toyota was acutely aware of the affordability crisis the SA motorist was facing and every effort was being made to restrict price increases.

"Last year I indicated our firm intention to restrict the total price increase for 1994 to below 10%."

VW market planning manager Neal Brunton said "We see affordability and value for money as the cornerstones of our pricing policy for 1994. Pricing will be affected by factors such as the competitive nature of the industry structures as well as external economic influences."

Tractor sales soar as agriculture recovers

BIDAY 14/11/94
MICK COLLINS

IN A major indicator that the agricultural sector is on the mend, total tractor sales for 1993 jumped 41,6% to 3 122 units compared with 1992 (192)

The SA Agricultural Machinery Association (Saama) said in Johannesburg yesterday that December sales came in at 281 units, 124,8% higher than the same period in 1992 when 126 units were sold

Baler sales came in at 55 units in December from 30 in December 1992 while total 1993 sales were 446, 19,3% up on 1992 Combine harvester sales reflected the good wheat harvest with 19 sales in December, up from three in 1992 Total sales for 1993 improved 92,9% to 135 units.

Saama said the prospect of good summer crops and better earnings had encouraged farmers to replace some of their ageing tractor fleets. "The industry is cautiously optimistic about prospects for 1994 and initial indications are that at least 3 500 tractors should be sold this year"

"Many farmers will take advantage of the good summer conditions to make as much hay as they can Baler sales should, therefore, continue to be good over the next few months," Saama said

Star 18/11/94

Workers strike at VW over tax

Port Elizabeth — Workers at Volkswagen's Uitenhage plant have gone on strike over the taxation of a productivity bonus which was paid out last week.

The strike, which began on Friday, is unrelated to recent strikes at Toyota and Samcor over the taxation of a once-off gratuity payment last year.

The National Union of Metalworkers of South Africa (Numsa) said Volkswagen workers had been promised a R1 000 bonus if they reached certain production targets last year.

But because of increased overtime worked to reach the production target, as well as the bonus itself, most workers' earnings had been pushed to a higher tax bracket. On average, workers received between R600 and R700 after the R1 000 bonus was taxed, Numsa said.

A Volkswagen spokesman, George Platt, said production at the plant would resume today but negotiations on the dispute would continue. — Sapa, Ecna.

(18) (A2)
VW workers
end stoppage
CT 18/1/94
Own Correspondent

PORT ELIZABETH —
Workers at Volkswagen's Uitenhage plant return to work today after downing tools on Friday in defiance of 41% tax deductions from last year's bonuses

Numsa senior shop steward Mr S Williams said yesterday the workers had undertaken to return after the Receiver's rationale had been explained to them — overtime worked to earn a production bonus had placed them in higher tax brackets

Volksie gets (192) green light for Red China

The Argus Bureau

PORT ELIZABETH — Volkswagen's deal to build cars for China is on again, securing about 720 jobs at the Uitenhage plant

Managing director, Peter Searle said the company had been given the go ahead to resume the export of lefthand drive Jettas to China for the next six months

Under a new contract, worth R125 million, China had guaranteed to take a third of the original number of cars with the possibility that the order would be renewed in June

The contract was put on hold in November because of China's shortage of foreign exchange

ARG 21/1/94
The order secures the jobs of about 720 staff working on the China project

Motor industry's exports are soaring

Biday 21/11/94

FOLLOWING the lifting of sanctions, automotive industry exports soared 24% last year to R1,8bn, the National Association of Automotive Component and Allied Manufacturers (Naacam) said yesterday

Exports of completely built-up vehicles accounted for R530m, while component exports were R1,3bn. (192) (192)

Total automotive exports were R1,5bn in 1992 and R900m in 1991.

Naacam president John Brandtner predicted that exports would continue growing, eventually making up more than 50% of the component manufacturing industry's output

"The component industry's exceptional export achievement has come about via success in meeting international quality standards and the past four years' car market slump which has encouraged component manufacturers to find buyers elsewhere in the world."

The success was also a result of a commitment to skills training and excellent research and development.

"We have proven our industry's ability to address productivity and achieve global quality standards. This has helped us survive a four-year economic recession and has strengthened us to be more prepared and confident about our ability to face future challenges."

Brandtner said the motor industry de-

MICK COLLINS

velopment programme, which was likely to succeed the present local content programme, would encourage model rationalisation, which in turn would improve economies of scale in component manufacturing. This would further enhance the international competitiveness of component companies

He said exports were still being hamstrung by factors such as the soon to be abolished Phase Six of the local content programme, which prevented component manufacturers gaining direct access to export incentives.

Also hitting the industry was the high cost of capital equipment and raw material protection, and the uneconomic production runs caused by the small and highly fragmented local vehicle market.

"We need increased material local content in SA motor vehicles in order to achieve longer component production runs, lower unit cost, less dependence on expensive component imports and less exposure to exchange rate fluctuations"

Brandtner said SA components were being exported worldwide to manufacturers using SA parts as original equipment in vehicle production, as well as to major international parts wholesalers and distributors

Spares not affected

By CHERILYN IRETON

THE cost of motor spares and parts will not be affected by new changes to the law ^{2/1/94}

Deputy Trade and Industry Minister David Graaff said that they were specifically excluded from the new Trade Marks Act and Designs Act passed by Parliament last month (192)

His assurance follows claims by the National Motor Parts and Equipment Association, published in Business Times two weeks ago, that the cost of spares and replacement parts would soar if spares dealers were disallowed from selling replacement spare parts

"The Act makes it absolutely clear that any replacement parts will not be affected," he said

China resumes Volkswagen imports

VOLKSWAGEN SA yesterday confirmed that it was to resume exports of left-hand-drive Jettas to China. *Biday*

VWSA MD Peter Searle said an order for 3 800 units had been placed. *Zillig*

The order followed uncertainty about further exports after the project was placed on hold at the end of last year.

Worth about R125m, the order guarantees shipments until June and indications are that further orders may be forthcoming in the second half of the year. Since exports to FAW-VW China began in May 1991, VWSA has shipped 15 282 vehicles.

"This comes at a time when VWSA has achieved a significant improvement in productivity and quality, and this further enhances the positive future forecast for

MICK COLLINS

1994. It also secures the positions of about 720 employees employed exclusively for the China project for the duration of this contract," Searle said. *(192)*

The Jettas will be exported in semi-knocked down form to the FAW-VW Automotive Company in Chang Chung city. The company is a joint venture between Volkswagen AG in Germany and the Chinese government. In terms of the original plan VWSA was to have exported 30 000 cars, worth about R500m, by the end of 1994.

The Chinese government halted the imports in November in an attempt to stop the heavy use of foreign exchange which was overheating its economy. *(192)*

tions from some quarters suggest even higher growth this year. Already, however, some manufacturers are struggling to meet demand.

Labour issues are intensifying the problem. The current crop of stoppages is over the taxation of workers' 1993 year-end bonuses. Individual plant actions began before the motor industry's Christmas shut-down and continued this week, when Volkswagen became the latest victim.

This and a string of previous disputes have hampered several manufacturers from building up stocks. Nissan estimates that stoppages cost it 8 000 vehicles in lost production last year. Toyota says it is "very short" of some models. Arthur Mutlow, marketing MD of Ford and Mazda assembler Samcor, confirms that labour issues have contributed to "continuing shortages".

Other companies face similar problems. Nor are they confident matters will improve. Managements recognise that the run-up to the April election could be littered with stoppages and are anxious to build as many units as possible while they can.

Overtime work is an obvious solution, but members of the industry's biggest union, the National Union of Metalworkers, are reluctant. Individual requests have been made at plant level, but as Toyota marketing MD Brand Pretorius concedes "We aren't confident they'll agree".

There is confidence, though, that the vehicle market has finally bottomed out after several years of decline and is embarked on a gradual upward trend. Naturally, there are a few provisos. First, the election must go ahead, the result must be accepted, and the level of violence should decrease. Then the rand has to show it has landed from its freefall against some major trading currencies.

It is on the assumption of the first set of circumstances that manufacturers are basing their prediction of further sales increases in 1994. The National Association of Automobile Manufacturers, averaging its members' forecasts, estimates that car sales will rise from 193 666 to 200 000, light commercial vehicles from 96 534 to 103 000, medium commercials from 2 928 to 3 000, and heavy trucks and buses from 4 942 to 5 400.

On the other hand, if the election doesn't happen and violence worsens, Nissan marketing MD Stephanus Loubser warns that "the vehicle market could decline by up to 15%, unemployment would rapidly escalate and it would be likely that several companies will be forced to close".

On the question of the rand holding steady, signs are that it is unlikely to repeat last year's 40% collapse against the yen, which caused the prices of Japanese-sourced cars to rise by an average of 17%. Facing no such problem with the rand-Deutschemark exchange rate, price increases of German-sourced vehicles could be controlled more effectively, some to under 10%.

Early forecasts for this year are that, the rand permitting, average price increases will be held to around 10%. If so, market interest will strengthen. But, if there is a repeat of the runaway price spirals of recent years, the recovery could be stopped dead in its tracks.

There are two other intriguing aspects to the car market now. The UN has put out feelers to buy an initial batch of 1 000

FM 21/1/94 **December vehicle sales**

Cars	Total	%*
Corolla 2 314, Camry 1 043, Cressida 1, other 9		25,1
Golf/Jetta (new) 1 429, Golf/Jetta (old) 58, Citi/Fox 955, Audi 145		19,3
Sentra 991, Maxima 90, 200SX/300ZX 6, Fiat Uno 716		13,4
Ford Laser/Meteor 369, Telstar 376, Mazda 323 448, Mazda 626 446		12,2
Astra/Kadett 1 381, Monza/Kadett 57, Rekord 59, Calibra 4		11,2
3-Series 1 157, 5-Series 291, 7-Series 40		11,1
Honda Ballade 674, M-Benz W124 309, W140 45, W201 2, other 4	1034	7,7

*% of the total car market

	1993	1994	% Change
December	13 419	13 022	+3,0
Jan - Dec	193 666	182 908	+5,9
November (16 189) - December			-17,1

Light commercials

Toyota 2 604 (37,5% of the market), Nissan 1 390 (20,0), Samcor 1 251 (18,0), Delta 1 054 (15,2), VW 594 (8,6), AAD 42 (0,6)

	1993	1994	% Change
December	6 935	6 484	+7,0
Jan - Dec	96 534	92 429	+4,4
November (8 238) - December			-15,8

Medium commercials

Toyota 55 (32,5%), Samcor 37 (21,9), Nissan 21 (18,3), Delta 25 (14,8), M-Benz 13 (7,7), AAD 8 (4,7)

	1993	1994	% Change
December	169	202	+16,0
Jan - Dec	2 928	3 278	+10,7
November (2 291) - December			+26,2

Heavy commercials

M-Benz 240 (65,7), Nissan 25 (19,5), Delta 27 (7,2), MAN Truck 26 (6,9), Toyota 22 (5,8), Teco 11 (2,9), ERF 9 (2,4), Iveco 7 (1,9)

	1993	1994	% Change
December	377	370	+1,9
Jan - Dec	4 942	5 413	+8,7
November (482) - December			-21,8

Total vehicle sales

Toyota 6 048 (28,9%), Nissan 3 259 (15,6), VW 3 181 (15,2), Samcor 2 927 (14,0), Delta 2 607 (12,5), BMW 1 488 (7,1), M-Benz 1 287 (6,2), others 108 (0,5)

	1993	1994	% Change
December	20 900	20 078	+4,1
Jan - Dec	298 070	284 028	+4,9
November (25 138) - December			-16,9

Source: NATIONAL ASSOCIATION OF AUTOMOBILE MANUFACTURERS OF SA

BUSINESS

vehicles for the election observers it is sending to SA. More orders will follow (192)

And there is interest among luxury car makers at the prospect of a huge batch of potential customers once a new set of government Ministers and officials is installed after April. But how much of that will go to existing SA companies? It's surely not coincidental that the Swedish car maker Volvo is returning to the local market in March with luxury imported cars.

Given Sweden's long history of support for the ANC, it would be surprising if Volvo did not win a significant slice of the new business.

MOTOR INDUSTRY

Labouring ahead

Demand may be picking up but can car-makers supply? Labour disruptions at SA vehicle assembly plants are frustrating manufacturers' attempts to take full advantage of a gradually strengthening market (192)

Car sales rose 6% last year and total vehicle sales increased by 5%. Early predic-

R200m job project started

ET 21/1/94

An assessment by the UWC's economics department concluded that the IDT's initial relief programme was an "impressive intervention".

The findings, presented yesterday, concluded that by the time the R100m had been allocated, some 68 000 temporary jobs, often successfully targeted at the poorest of the poor, had been created.

It found that through the project rural communities were beginning to display initiative and assume responsibility for their own development.

Own Correspondent

JOHANNESBURG — A R200 million project to provide jobs for more than a million people in rural areas was launched by the Independent Development Trust (IDT) yesterday.

The two-year Community Employment Project (CEP) will develop skills in rural communities and build up basic infrastructures which will continue after the project.

Funding has been provided by the IDT, the National Economic Forum and the TBVC

states. The IDT has also approached international donors.

IDT director of health and rural development Dr Sholto Cross said at a news conference here the plan would build on what had been achieved by the relief and development programme launched in 1992.

While the initial programme focused on drought afflicted areas, the new project would be extended to rural communities countrywide.

He said communities would decide on the projects in their areas. Scores of applications

had already been received to fund the erection of schools, community centres, roads, water projects and vegetable gardens.

As well as supporting innovative schemes for land reform and resettlement, the IDT will co-ordinate the efforts of various development agencies.

IDT spokesman Mr Jolyon Nuttall said by targeting rural areas, the project aimed to unlock the potential of these communities. It would be a "primary attack on the tap roots of poverty", he said.

Crack of dawn



That poll that predicted an ANC landslide — was that before or after the ANC said they were going to increase the tax on smoking?

DIICINIECC DBIEF

SA's motor industry exports soar by 24%

ET 21/1/94

(192)

Own Correspondent

JOHANNESBURG — Motor industry exports soared 24% last year to R1,8 billion, following the lifting of sanctions, the National Association of Automotive Component and Allied Manufacturers said yesterday.

Exports of completely built-up vehicles accounted for R530 million, and component exports were R1,3bn. Total automotive exports were R1,5bn in 1992 and R900m in 1991.

The association's president, Mr John Brandtner, predicted that exports would continue growing, eventually making up more than 50% of the component manufacturing industry's output.

● Volkswagen SA yesterday confirmed that it was to resume exports of left-hand-drive Jettas to China. VWSA managing director Mr Peter Searle said an order for 3 800 units had been placed. The order is worth about R125m.

Massive bust — 2

By JACKIE C

POLICE arrested two busi with a massive haul of p value of more than R60 000 night.

One of the men was arrested when police found hi than 100kg of shelled per

Shortly afterwards, police man at a house in Droom found freezers packed wi Two men, aged 49 and 41 in the Somerset West Ma connection with the haul. The police were acting



Car sales crash warning

Business Staff

MOTOR manufacturer Nissan has warned that the car market could plummet by 15 percent this year "if the elections do not take place on their due date"

While optimistic for 1994 — Nissan Marketing MD Stephanus Loubser expects passenger car sales to rise by 7,5 percent to 205 000 units this year — he says that a sharp rise in the level of violence or postponed elections would spell disaster for the industry

"Unemployment would rapidly escalate and several vehicle component manufacturers and car dealers could be forced to close," he said at a Press briefing

Mr Loubser added immediately though that prospects for the industry had improved markedly since the third quarter of last year, as reflected in the five percent rise in total vehicle

sales to just under 300 000 units for 1993

In line with his forecasts of 2,2 percent growth in the economy and an average inflation rate of eight percent, he expects vehicle sales of 320 000 units over this year

At the same time, however, vehicle prices look set to rise by 10 percent this year mirroring the expected fall in the exchange rate of the rand against the yen

The higher prices have already led to a marked shift in consumer buying habits, with up to 75 percent of sales accounted for by so-called small cars, Mr Loubser said

An additional bonus for the industry could come from the expected arrival of 5 000 UN observers

Mr Loubser said that the UN had already "inquired" about the delivery of 1 000 vehicles

(192) ARCT 24/11/94

Agriculture buys 5% more diesel

MUNGO SOGGOT

WHOLESALE diesel sales to agriculture in the first 10 months of 1993 were 5% up from the same period the year before, according to a survey released by the Central Statistical Service (CSS) yesterday.

Econometrix economist Tony Twine attributed the increase to better summer rainfall crops — in particular the maize crop, which weighed in at 8-million tons in 1993, compared with 3-million tons the year before. **25/11/94**

Twine said more diesel would have been used to harvest the crops, and to transport the produce afterwards.

In December last year the SA Agricultural Machinery Association said total tractor sales in 1993 had risen 41,6% from the year before.

"The growth of the agricultural sector's contribution to GDP in the second and third quarters of 1993 was phenomenal," Twine said. Contribution to GDP in the second quarter was 35% larger than in the first, and in the third quarter it was 31% up on the second ~~(1992)~~ (1992).

However, the CSS survey showed that diesel sales in October 1993 dropped 17,3% from September.

Twine said this fluctuation followed a similar pattern in wholesale petrol sales caused by supply distortions that surrounded September's fuel price increases. The price of diesel went up 6c on September 15.

He said the fall in sales in October could be explained by "pre-emptive stocking before the September price increase".

Guarded support for ANC health plan

THE Pharmaceutical Society of SA yesterday welcomed the broad principles of the ANC's health policy but questioned its possible tendencies toward nationalisation

Executive director Boet van der Merwe said the planned encouragement of the pharmaceutical industry to sell most of its production to the state smacked of nationalisation

"Health care should remain a dual system between the private and public sectors provided there is an aggressive drive to root out inefficiencies," said Van der Merwe.

"That the growth of private health care services is to be discouraged is a matter of concern.

"While the plan proposes to raise funds through increased taxing of alcohol and tobacco, the state will remain hard-pressed for health care funds"

He said it was desirable rather to minimise state involvement and expenditure by encouraging the private sector to serve those who could afford it

Stimulation of the private sector to develop health care services and systems to serve lower income groups equitably and cost-effectively was the more attractive option, he said

"Although it is envisaged that national health insurance is to be funded by employees and employers,

more details are required.

"The private sector already funds a form of medical insurance for part of the population, through shared funding of medical schemes and 'top-up' health insurance," he said.

"Being privately administered, of which the medical scheme portion is non-profit making, the state and private sector could co-operate in extending such in-place expertise and facilities."

Van der Merwe added that where the ANC document referred to "private practitioners", the society needed assurance that this was a generic term for all healthcare professionals, including pharmacists.

"The society applauds moves towards formalising patients' rights," he said, adding that it was encouraging to see private practitioners and private hospitals would play an important role in the national health system.

"Likewise, that health personnel will be multi-disciplinary.

The Pharmaceutical Society supported this concept, as it did that of integrating aspects of traditional healers' practices within the health-care framework.

Van der Merwe said his society also welcomed the ANC's recognition of the need to retain statutory bodies in a more co-ordinated manner — Sapa

Agriculture buys 5% more diesel

MUNGO SOGGOT

WHOLESALE diesel sales to agriculture in the first 10 months of 1993 were 5% up from the same period the year before, according to a survey released by the Central Statistical Service (CSS) yesterday.

Econometrix economist Tony Twine attributed the increase to better summer rainfall crops — in particular the maize crop which weighed in at 8-million tons in 1993, compared with 3-million tons the year before.

Twine said more diesel would have been used to harvest the crops, and to transport the produce afterwards.

In December last year the SA Agricultural Machinery Association said total tractor sales in 1993 had risen 41.6% from the year before.

"The growth of the agricultural sector's contribution to GDP in the second and third quarters of 1993 was phenomenal," Twine said.

Contribution to GDP in the second quarter was 35% larger than in the first, and in the third quarter it was 31% up on the second.

However, the CSS survey showed that diesel sales in October 1993 dropped 17.3% from September.

Twine said this fluctuation followed a similar pattern in wholesale petrol sales caused by supply distortions that surrounded September's fuel price increases. The price of diesel went up 6c on September 15.

He said the fall in sales in October could be explained by "pre-emptive stocking before the September price increase".

Delta denies having plans to import Saabs

DELTA Motor Corporation said yesterday it would be premature and incorrect to say it had plans for the introduction of Swedish manufactured Saab vehicles to SA. *B/D*

Referring to the reports as speculative, Delta MD Willie van Wyk said expected changes in the motor vehicle industry in SA did not favour the local assembly of Saab vehicles. *26/11/94* *(92)*

However, he said Delta potentially had access to the many products available in

MICK COLLINS

the General Motors stable, including Saab, and "we will take advantage of that fact in structuring our future operations".

Delta, which was formed after General Motors pulled out of SA in 1986, manufactures the Opel range of vehicles.

Van Wyk said: "Press reports regarding the possibility of Saab vehicles being assembled by Delta Motor Corporation in Port Elizabeth are at best, speculative."

Motor companies 'must gear up for competition'

(192) BD 30/1/95
LOCAL car manufacturers will have to look at ways of reducing costs and improving their competitive situations in response to Board on Tariffs and Trade recommendations on a new dispensation for the industry, says National Association of Automobile Manufacturers of SA (Naamsa) director Nico Vermeulen

Companies would have to concentrate on producing high-volume models for the domestic market, as well as becoming integrated into the international market through exports

While the board recommendations would not suit everyone, manufacturers had to face them.

Several manufacturers have already geared themselves up to face the increased competition. Capital expenditure by manufacturers more than doubled last year over the previous year in expectation of increased international competition

Manufacturers expected further investment this year

Some companies have already announced their plans

Audi announced recently it would start producing its A4 model this year.

Aggressive production and sales targets were expected to lead to a four or fivefold increase in SA Audi sales in two years

MARCIA KLEIN

Naamsa said recently that further rationalisation of domestically produced models was likely and vehicle and component exports would remain a key priority "to optimise volume and achieve economies of scale"

Vermeulen said the development programme for the industry would coincide with an expanding domestic market

While there was some concern in the motor industry regarding the full effect of recommendations on a new dispensation for the industry, Naamsa has forecast higher sales for calendar 1995

It has said it expects an increase of more than 12% in unit terms, which would be one of the highest year-on-year growth rates in the past decade

The period for comment on the Board on Tariffs and Trade's December 9 proposal on a revised dispensation for the motor industry had expired two weeks ago, although some industry sources said they believed there had been an extension for late submissions

A board spokesman said last week comments were being evaluated and would be "summarised in the report on the revised dispensation" for the industry

Aussie plan may be used to rejig SA car industry

The Argus Foreign Service

(192)

MELBOURNE — Australian's car industry plan will be recommended to the South African government as the blueprint it should follow for restructuring the country's highly protected automotive sector

ARCT 3/11/94

Dr Daniel Bosman, a member of the South African Board of Tariffs and Trade, has said, according to the Australian Financial Review, that the basic principles of the Australian system should be followed

As part of his evaluation, Dr Bosman has visited Australia to look at the motor industry here

Robert Johnston, chairman of Toyota Australia and of the government's trade body, Austrade, believes there will be some resistance to South Africa changing its present system

Mr Johnston, who has just returned from South Africa, says job losses will be inevitable and this was worrying some people

As Australia has rationalised its car industry, cutting the number of models and lowering tariffs, worker numbers have fallen from 70 000 to 41 000

■ The growing popularity of diesel cars is extremely bad for human health, according to the authors of a UK government report on air pollution

The report vigorously attacks the green image of diesel and says the engines produce high levels of gases and soot, causing breathing difficulties and cancer, reports the Financial Times

The motor industry, which as a producer of both petrol and diesel cars maintains it has no axe to grind, immediately launched a scathing attack on the report

It said that in reaching its conclusions the report had failed to take account of continuing enormous progress in diesel engine technology which rendered most of the criticisms invalid

The industry fears that uncertainties created by the report may slow the new car market's recovery from one of its steepest declines

Production of some cars could grind to a halt

Weekend Argus Reporter (192) Aug 2/4/94

PRODUCTION of a number of cars made in South Africa could come to a halt within in the next year if a proposed development plan for the motor industry is put in gear

The plan, released by a government-appointed sector task group, entails ditching the 15 percent import surcharge and a phased reduction of duties on imported cars from 100 percent to 45 percent over seven years

Domestic manufacturers would also be penalised by the part-forfeiture of duty-free allowances on imported components for models under-shooting steadily increasing industry targets

If accepted, the scheme will start on July 1, 1995, with maximum penalties reached by 2002

“twin” currently sell at about the numbers specified initially from July for manufacturer, Samcor to avoid penalties — 625 a month, he says.

Manufacturers have not idled over the vagaries of the future Model updates have been skipped by some — like Toyota with the delay in introducing the Camry and the new-shape Corolla, while Samcor missed out the last international revamp of the small Mazdas a few years ago

If the plan comes to pass, all will inevitably react with speed Analysts say BMW would be only too happy to import its 5 and 7 series at lower duty rates and concentrate on its viable 3 range, while the rationale behind Mercedes's concentration on its S-series would become more apparent as imports made up most or all of the remainder of its current spread

Opposed by the assembly companies' National Association of Automobile Manufacturers (Naamsa), the plan aims to reduce the number of car, bakkie and minibus models produced by the seven assembly companies from 39 to 15 Task group head Derek Riley has intimated a reduction in the number of assemblers (seven) would not be unacceptable

Econometric economist Tony Twine says that while conjecture on the effect of the proposals is at best haphazard — not least because of the socio-political implications of the job losses that would result from model-loss — it is no secret that most or all of the Mercedes-Benz range, Samcor's Lasers and Meteors, and Volkswagen SA's Audis “don't make the cut” Neither do Delta's Rekords

The ageing Mazda 626 and its Ford Telstar

Delta confirms it has plans to restructure

ERICA JANKOWITZ

DELTA Motor Corporation last night confirmed reports that it was to embark on a restructuring process aimed at flattening its management structure, concentrating on core business areas and gearing its operations for global competition.

The move followed an internal study to investigate its line organisational structure, business practices and manning levels, Delta said. *Business Day 4/2/94*

The study was commissioned to "assist in defining a clearer picture of the gap between our existing organisation state and the type of organisation required to meet future business needs in line with the best practices of top-performing international companies". (192)

"Certain deficiencies" were discovered that would receive Delta's "immediate and ongoing attention as a first step in a continuing improvement process".

Delta yesterday obtained an urgent Supreme Court interdict preventing the National Union of Metalworkers of SA (Numsa) from distributing details of the investigation's findings, which it regarded as confidential.

Business Day had been threatened with legal steps to prevent it publishing the information, and the Evening Post in Port Elizabeth decided against publication when Numsa withdrew a news statement containing details of the report.

Yesterday Delta outlined the steps required as streamlining management and supervisory structures, and "realigning manning levels within indirect non-value-adding support functions and activities not contributing directly to our core business".

To achieve this, employees approaching retirement age had been "canvassed" to establish whether they would be prepared to accept early retirement packages subject to the need for company retention of skills in critical business areas".

Delta said hourly paid workers directly involved in the manufacturing and assembly process would not be affected by the process, which was aimed mainly at whit-

To Page 2

Delta

ting down unnecessary layers of management. However, reductions in staffing levels would take place only in consultation with employees, Numsa and the SA Iron, Steel and Allied Industries' Union, in line with industry agreements. (192)

Business Day 4/2/94

From Page 1

Numsa said it would oppose any plans to retrench hourly paid workers and "rather concentrate our efforts on reducing the value-adding costs in the company — by reducing the number of managerial and salaried staff"

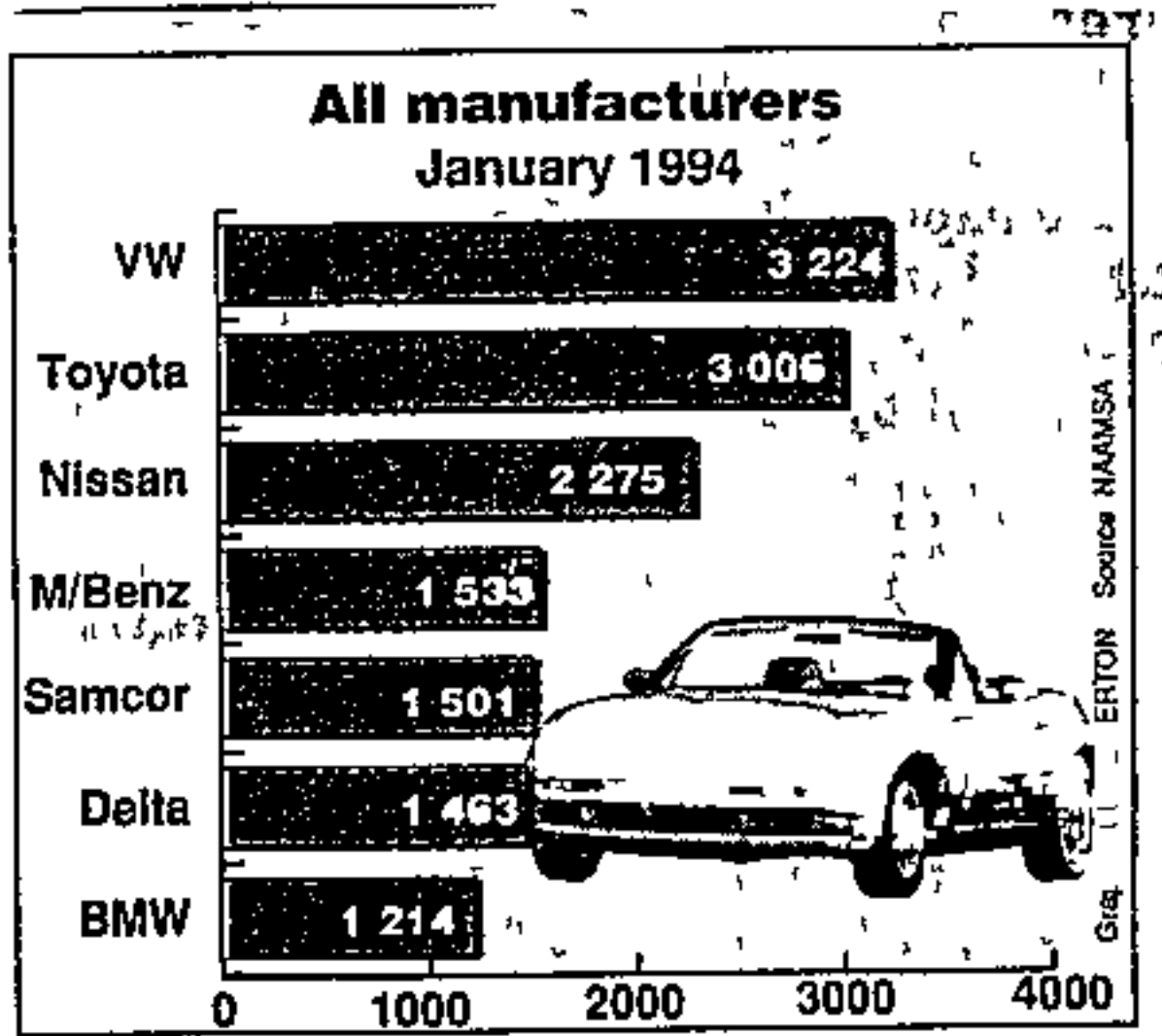

January car sales continue upward

MICK COLLINS

THE upward trend in new car sales continued in January despite widespread industrial action that depleted inventories

Figures released yesterday by the National Association of Automobile Manufacturers of SA (Naamsa) showed January new car sales at 14 218 units — an improvement of 5,4% compared with the 13 484 units recorded in January last year, and 799 units or 5,9% better than December.

One of the month's features was that VW, with 3 224 passenger cars sold, overtook traditional market leader Toyota, which sold 3 006 units *Biday*

Naamsa said industrial action in December had resulted in shortages of certain new cars and light commercial vehicles, which affected January's sales

Sales of new light commercial vehicles, bakkies, and minibuses, at 6 542 units, showed a marginal decline of 32 units or 0,5% compared with last January's 6 574 units. Compared with December there was a decline of 393 units or 5,7% *912,194*

Sales of vehicles in the low volume medium and heavy truck segment of the market declined 12,9% and 22,25% respectively compared with last January *(192)*

Naamsa forecast modest improvements in new vehicle sales this year, but this depended on a further recovery in the economy and sociopolitical stability

Toyota marketing MD Brand Pretorius said 1 900 units had been lost as a result of strikes "This left our dealer stock at lower levels than we would like. This will be corrected in early February"

Nissan marketing MD Stephanus Loubser said "We remain confident that our expectation of a 7,5% rise in the total vehicle market for 1994 will be met"

Things beginning to look up for buyers, say car-makers

(192) ARU 9/2/94

□ Blood expected to flow as industry faces overseas competition

ANTHONY DOMAN
Motoring Editor

CAR buyers, punch-drunk after years of soaring prices, will find things going their way for a change as South Africa's motor manufacturers prepare for an unprecedented round of bloodletting, a top industry executive has forecast

The planned dropping of import tariffs and protection of local industry would mean enforced rationalisation — and it was uncertain whether unprotected we would be competitive with the rest of the world said the passenger division head of Mercedes Benz of SA Peter Cleary

He told Cape Town media yesterday that within five years South Africa no longer would have seven manufacturers, using Australia (which went from five manufacturers to three) as an example

"It is going to be a bunfight," he said "The consumer should be the winner for the next few years"

MBSA could end up making only its C Class, the Honda Balade and the Mitsubishi L200 bakkie, he said

At the present import duty of 110 percent, imports are not competitive with locally built cars. As the duty is phased out, certain models will become competitive — already, local assembly of the superluxury S Class will end at midyear. If the duty was cut to 40 percent, imports would compete strongly with local cars

The company said in a statement it would enter 1994 with "an aggressive value-oriented marketing strategy" to prepare for "one of the most momentous years in its history"

Cost-cutting and improved efficiency, competitive pricing, innovative financial deals and greater customer satisfaction had all played their part in a new pricing structure for higher volume models. MBSA has in fact increased its market share — now 10,3 percent — for the third year in a row

Strangely, it's not just the mid-range models, traditionally MBSA's big sellers, that are selling well

Buyers don't seem to care whether or not it is "politically correct" to drive a vast luxury saloon. Sales of the new S-Class — launch prices about R350 000 and R420 000 — are well ahead of expectations

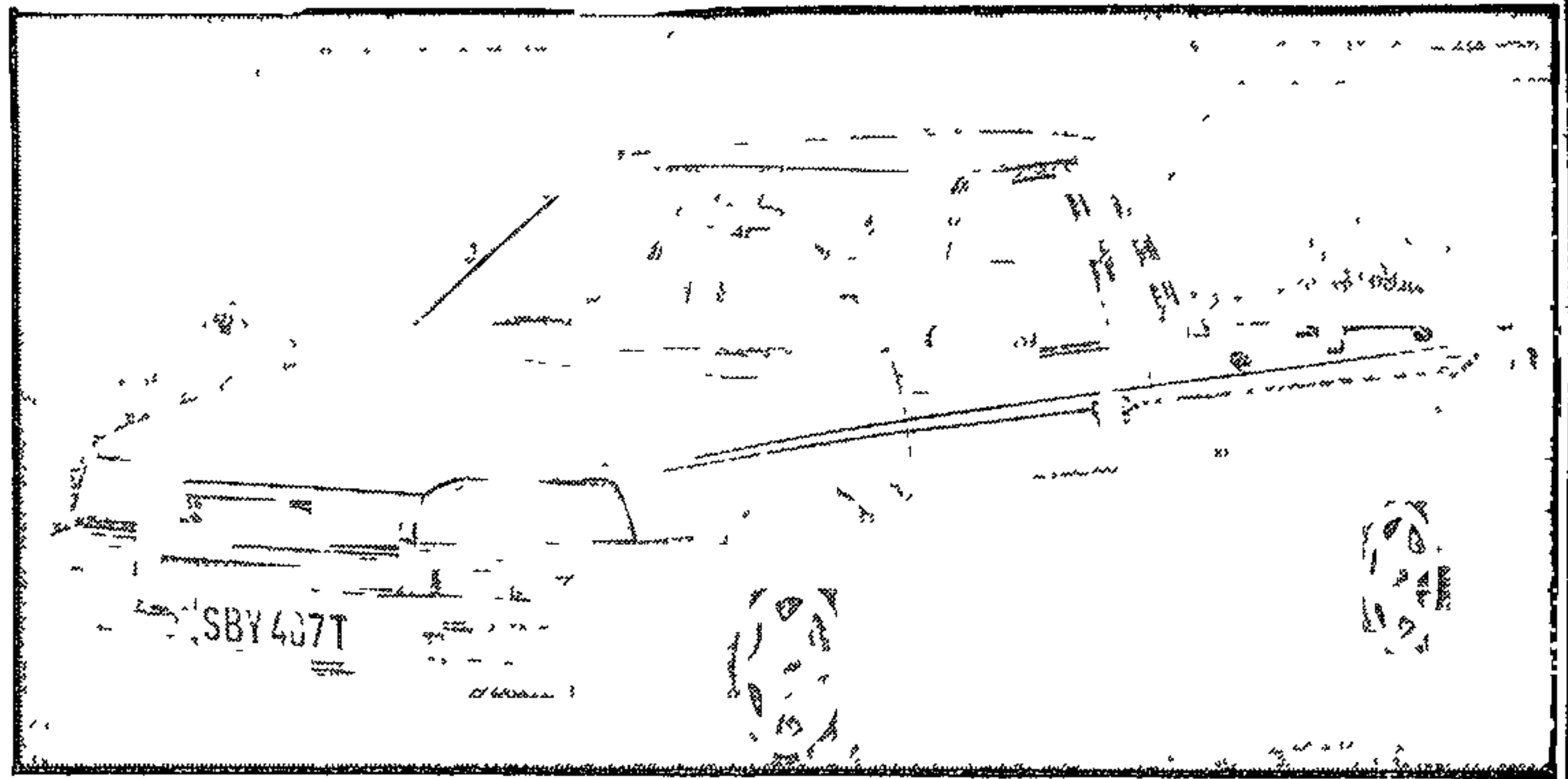

NEW LOOK: Styling of the new Mazda Rustler and Ford Bantam bakkie range was done in-house by Samcor's styling studio — its first big project

Samcor bakkies brace for another sales war-on-wheels

Motoring Editor

THE new halftonner-and-a-bit from the South African Motor Corporation is aiming to take 60 percent of its market segment — and that means it's open season on the longstanding favourite, the Nissan 1400

It was never mentioned by name but only the blind would have misread the suggestion at the launch of the new Ford Bantam and Mazda Rustler in the Transvaal last week

Initial production is geared for 600 sales a month, which presupposes that the little bakkies will increase their market share from 34 percent to 40 percent

"Ultimately we are looking for 60 percent," said Samcor Marketing MD Arthur Mutlow

Topping the range is a fuel-

injected 1600, which in Samcor's words "adds a performance element we have not seen in this market before now"

Optional extras specifically for this range include radios, alloy wheels and canopies. The Bantam Explorer and Rustler Drifter offer luxury equipment as standard

During the launch proceedings we drove carburetted 1300 and 1600 models and were quite impressed with the 1300's punchiness, even at Reef altitudes

Less impressive was the (ouch!) vinyl upholstery, but then the vehicle is a workhorse, after all. The 1600 showed a reasonable turn of speed — but the surprise packet is evidently

going to be the fuel-injected model, which passed us going away

Not surprising, when you look at the numbers 77kW at 6 500 r/min, peak torque of 132 Nm at 5 000, 0 to 100 km/h in 10.5sec and a top speed of 172km/h

There are five models in each range — and even the most basic 1300 gets a five-speed gearbox

The new model is described as a true amalgam of the two marques, being based on the old Ford Bantam and the present Mazda 323

Comfort has also been emphasised — with legroom, for instance, claimed to be 66 percent better than that of the competition

Mercedes has 2 aces up its sleeve

Motoring Editor

A BIGGER-ENGINED Honda and a comprehensive range of Mitsubishi bakkies are two of the aces up the sleeve of Mercedes-Benz of SA this year

The Mitsubishi L200, to be launched towards the end of this year, will be a full range of one-tonners. Engines will be diesel or petrol, and configurations long or short wheelbase in two-wheel and four-wheel

drive. MBSA is hoping to capture about 10 percent of the market

But first the company plans to launch a 1.8 litre Honda Balade in March. This will be no more powerful than the present 160E model, but will have better low-down pulling power

By midyear the small C Class should be available, at prices about 20 percent above

the old 190 model, which started at R90 000

The luxury segment of the market was down to 4,1 percent from 5,6 percent in 1990

The "large" segment — occupied by cars such as the Toyota Camry, BMW 3 Series, Jetta, Mazda 626/Ford Telstar — had grown to 10.9 percent. Mercedes-Benz C class would fit neatly into this market, a spokesman said

Carmakers look to expansion⁽¹⁹²⁾ as sales grow_{ARG 9/2/94}

Business Staff

CONFIDENT of firm growth in sales this year, car manufacturers are expanding production facilities, with Nissan the latest to announce a large R110 million programme.

Carmakers' optimism was fuelled by the latest sales statistics, which showed a continued strong gain in January on the back of a marked upturn in consumer spending.

Announcing details of Nissan's capital expenditure programme, Nissan marketing director Stephanus Loubser said the group could not afford to delay investment decisions until after the election.

Nissan had already initiated a R57 million spending programme at its Rosslyn factory, mainly on new paint shops and a wheel assembly plant, and was planning further investments of R54 million, Loubser said.

Figures issued by the the National Association of Automobile Manufacturers (Naamsa) yesterday show that car sales of 14 218 units in January were up by 5,4 percent on January 1993 and by 5,9 percent on December.

However, sales of light commercial vehicles at 6 542 units were 0,5 percent lower than in the same months last year, while medium and heavy commercial vehicles showed year-on-year declines of 12,9 and 22,3 percent respectively.

Industry leaders said yesterday the January figures were encouraging as they were achieved, despite a shorter selling month, in the teeth of the late school holidays.

Volkswagen overtook Toyota as market leader in the car sales category for the first time since August 1992.

Naamsa expects modest improvements in new vehicle sales this year.

"However, this remains dependent on further recovery in the economy and the attainment of socio-political stability following the impending elections," it said.

Controls help McCarthy Retail improve margins

BIDAY 18/12/94

REFLECTING a strong performance by all its trading operations, turnover at diversified motor group McCarthy Retail rose 20% to R3,2bn from the previous year's R2,6bn for the six months to December 31

Operating profit rose 25% to R159m (1992 R127,2m) while pre-tax profit was up 26% to R130m against the previous year's R103m. The improved margins reflected tighter cost controls and zero budgeting introduced across the group a year ago, according to CE Terry Rosenberg

Attributable profit for the six months rose 13% to R63,4m (R56,3m) which is equivalent to earnings a share on a diluted basis of 32,8c (29,1c). Undiluted earnings were up from 36,3c to 41c

An interim dividend of 9c (8c) was declared. The McCarthy Group —

MICK COLLINS

the investment holding company which derives its sole income from its stake of 87,8% in McCarthy Retail — raised its earnings a share on an undiluted basis by 12% to 54,4c (48,4c). An interim dividend of 11,8c (10,5c) was declared

Rosenberg said vehicle distribution arm McCarthy Motor Holdings raised its pretax profit by 22% and increased its share of the national dealer market for cars and commercials from 13,4% to just under 14%

"However, considerable pressure on margins for

new vehicles resulted in a fall in the ratio of operating profit to sales"

Furniture and appliance group Beares showed a better-than-budget increase of 21% before tax

The group's clothing division Clobea (trading as Bee-Gee) showed a 29% increase in profits while Game Discount World, although behind budget, was 22% up on the previous year

(192)
Rosenberg said the group did not expect second half earnings to match those of the first, but earnings for the full year should be ahead of the previous year

Big increase in sales of farming equipment

^{B/Dan}
PRETORIA — Agricultural equipment sales had soared this year following good rains and favourable agricultural conditions, SA Agricultural Machinery Association chairman Gerrie de Jong said yesterday.

Tractor sales of 240 units in January marked an 80% increase over 1993 and constituted the highest monthly sales in four years. ¹¹¹²¹⁹⁴

Baler sales had also improved 50% and combine harvesters were up 700%, he said. ⁽¹⁹²⁾

Equipment manufacturers were confident of continued buoyant demand through 1994 due to the good farming conditions, the imminent summer crop harvesting season and the large amounts of hay and forage in need of baling.

Weekly statistics from the Water Affairs Department indicated a much improved position for most reservoirs in the country compared to last year.

ADRIAN HADLAND

Reservoirs in the Vaal River system registered 52% of storage capacity, up from 48% last year, with four dams at 100%. The Vaal Dam had improved from 33% of storage capacity in February 1993 to 42% this month.

Reservoirs in the Upper Orange River area registered 59% of capacity against 1993's 27%, while the western Transvaal was up to 35% (33%), the eastern Transvaal was at 45% (36%), the eastern Cape had improved to 64% (44%) and reservoirs in the Natal region were up to 61% this week from 44% in early February last year.

The only area of SA which showed a decline in the amount of water in dams and reservoirs was the western Cape. Reservoirs held 57% of their storage capacity this month compared with 60% in 1993.

'Forum a blueprint for other towns?'

(192)

By ANDREW BROWN

HIGH production costs and prices in SA's motor industry are preventing competition on the local and international market, said Motor Industry Task Group chairman, Derek Riley

He was attending a presentation with other top-level business people at Atlantis Diesel Engines yesterday. Encouraging business's to nurture co-operation with



CHAIRMAN
Derek Riley

their trade unions and employees rather than confrontation, Riley felt that the Atlantis Forum had made the industrial town a blueprint for similar decentralised areas

Riley said there were many difficulties in the motor industry that needed addressing, such as the exorbitant tariff rates of 115%, high production costs and expensive cars.

"South Africa is not likely to be very

competitive right now but all this will hopefully be reported to the Minister of Finance Derek Keys on March 4," he said. Asked about the future of local content in the industry, he said that it was planned to phase restrictive tariffs and import surcharges out by 1999.

He envisaged that the motor industry would have become more competitive by the year 2003. "It has already started happening," he said.

21/5/2004

Motor industry task group tours Atlantis

192 CV 15/2/74

By AUDREY D'ANGELO

ATLANTIS can be "a beacon for the rest of SA," because of the spirit of co-operation existing there between labour, management and the community — who realise they must work together to market the town's industrial potential — Noel Williams, chairman of the Atlantis Development Forum, said yesterday.

He was speaking to members of the Motor Industry Task Group and other leading industrialists from all over the country who visited Atlantis yesterday and toured some of its factories.

Derek Riley, chairman of the Task Group, said he had arranged the visit so that other members "could feel the vibes of Atlantis and see for themselves what had been achieved" in the field of labour relations and productivity.

Contrasting this with the disastrous effect of labour disputes in the motor industry in the last few years, Riley said it showed how much better it was to discuss matters at establish-



ATLANTIS GROUP ... From left, Grant Thomas, chairman of Malbak, Derek Riley, chairman of the Motor Industry Task Group and Fritz Körte, CE of Atlantis Diesel Engines (ADE), at a presentation by the Atlantis Development Forum yesterday.

Picture: Andrew Brown

ment level. "At establishment level people will almost certainly come up with a common sense solution."

"I salute the Atlantis community for showing what can be done through consultation rather than confrontation."

Malbak chairman Grant Thomas, whose group has four factories in Atlantis, announced a donation of R60 000 to the forum.

He said he had just returned from England and the US. Many

frowned on.

- An end to violence.
- SA people investing here before they did.

Admitting "these points have been made so often they are in danger of sounding trite," Thomas said that because of this there was a real danger that they might not be taken seriously and this would "prevent our bright future."

Referring to the work of the Atlantis Forum, Thomas said it might seem too small to affect the future of SA as a whole. "But it is from groups like this that national pride comes. This sort of thing is infectious."

Williams, thanking West for starting the Atlantis initiative, said all organisations and political parties were welcome to join the Development Forum. Without it, the town "would have fallen apart."

Danny Olifant, vice-president of Cosatu, said the community of Atlantis were "marketing ourselves".

They would draw up advertisements and were opening a Business Information Centre so that visitors could see what was being manufactured in Atlantis and be given reasons for investing there.

- A sensible, Western-style democracy.
- A "morally sound — by which they mean no bribes or back-handers" — entrepreneurial business environment where making a profit was not

Midas remains steady despite merger talks

B/S/CM 1512194

MARCIA KLEIN

MOTOR supply group Midas yesterday cautioned shareholders that the company was involved in negotiations (192). The share closed unchanged at 290c. It reached a yearly high of 330c in January and a low of 160c in April last year. Analysts said the cautionary could refer to McCarthy Retail increasing its 36,3% stake in Midas or to "some amalgamation" with W & A's motor parts group Varex. In the interim to end-August, Midas halted its slide, reporting attributable profit of R2,2m (R3,8m loss).

Analysts said it appeared Midas was on the road to recovery. The company had been rationalised and top management changed. Its prospects were good, given that it was in motor parts and that the age of vehicles on the road was increasing.

If it were to enter into a partnership with Varex or to buy a part of Varex, it would be securing market share in an alliance with its competition, an analyst said.

VW plant to reopen after strike action

ARL 17/2/94
SHARON SOROUR
Labour Reporter

CRIPPLING strike action by spray painters at Volkswagen's Uitenhage plant, which shut down production for two days, has ended, with workers set to start work today

The company was granted a Supreme Court interdict yesterday, ordering workers to return to work, and to follow procedures.

Company spokesman Brian Smith said the National Union of Metalworkers of South Africa had played a "positive role" in persuading the strikers to follow agreed procedures.

In the illegal and unprocedural action 55 Numsa members demanded that management upgrade their status from "grade 3" to "grade 4"

Loss of production cost the car manufacturer more than 600 units since the action began at midday on Monday

Volkswagen threatened to dismiss the workers, saying if it "gave in" to their demands, it would be seen to be giving in to "mob rule"

Union officials could not be reached for comment

The company said job grades at all South African motor manufacturers were regulated by the National Bargaining Forum, and spray painters at all but one motor manufacturer were at the grade 3 level

Enhance value

Pretorius is quick to point out that value is not only determined by price "Value goes much further than that. Our philosophy is to enhance value all the time. We are looking at every aspect of the ownership experience and we say, what else can we do to add value and I think we have made reasonable progress," he says.

The perception that Toyota cars are cheap is wrong, he says. "Our prices are competitive but we are not less expensive. Toyota is a market leader and our competitors are always pricing their cars and pickups at exactly our level," he says.

Last year the company sold almost 90 000 vehicles and took the biggest slice of the market — 29,4 percent (Forty-five percent of the minibus market, almost half of the total sales going to the black market).

This is the 13th consecutive year that the company has held a leading position for total car sales.

So why are the company's sales improving even though we are told of a recession?

Pretorius says a strong replacement demand underpinned the new vehicle market last year. "Although total sales grew, buyers were going for the smaller cars," he says.

Buyers are in a Catch-22 situation in that their cars are old and they need to be replaced. But the cost of new cars is so daunting that people are buying down.

The industry is this year forecasting a growth of 6 percent. These forecasts are based on the hope that the economy will pick up this year — especially after the election in April.

Pretorius says there will be more confidence in the political future of the country. Already, business confidence is improving, the country is expecting a bumper crop of 10 million tons of maize this year, inflation is under control, the international economy is improving and further declines in interest rates are predicted. Also, many billions of rands have been earmarked for reconstruction projects — housing and electrification — and this will further boost the economy.

He says plans are also afoot to address the affordability crisis. This is caused by the weak exchange rate, weak market and too many manufacturers.

This includes trying out the Australian model of rationalising the motor manufacturing industry and down-scaling the different types of models in a range.

There is also a task force dealing with this issue and its announcements are expected soon.

Sales are predicted to top 317 000 units this year — which is actually 35 percent lower than the 1981 sale of 453 000.

But what makes Toyota tick as successfully as it is?

Soul searching

Pretorius says there is a lot of soul searching in the corridors of TMC itself. The management's philosophy of equal opportunity and consultation places the company firmly on the right road.

Recently, the company was involved in a soul-searching exercise. This involved taking groups of staff members through a working session where the strengths and weaknesses of the company were discussed.

"We use the theme creating hope. We identify obstacles-relationships in the company and also talk about leadership style," he says. A list of categories was compiled and these were: What are the strengths of the company (what should be kept), aspects that are worrying the workers (what should be done away with), and new things the company needs to start.

The sessions resulted in a Care Document, and this document is set to position the company for the future and chart the way forward.

"We hope in the end we will have a common vision, a common dream for the company, and then shared values. If we want to achieve that dream what should we do, how to work together and it's an effort to create better understanding, to get all the people to respect human dignity, to live according to our management philosophy of equal opportunity, to empower all the people, consult — create a framework within which our company will be a success," says Pretorius. But ultimately, it is the dealer who is in the

Thursday February 17 1994 SOWETAN

17/2/94
Sowetan

Big celebrations at Toyota

By Musa Zondi Motoring Staff

THE MAKERS OF SOUTH AFRICA'S most popular cars celebrated this week.

Toyota Motor Corporation celebrated its success. This is the achievement by the manufacturer of 500 000 Toyota Corolla and 400 000 Hi-Lux bakkie sales.

This success has been achieved as a result of the company's philosophy of total ownership satisfaction which is bearing fruit, says managing director Mr Brand Pretorius.

This experience covers things such as the features of the car, cost of replacement parts, cost of servicing, resale value, long-term reliability and the durability of the vehicle.

"We definitely offer the best value," says Pretorius adding that given the demanding and discriminating nature of South African customers, the sales figures attest to this.

13TH YEAR Group 192

keeps lead for total sales:

front-line. It is the dealer who determines the success of the product. Manufacturers just work hand in glove with them to ensure success.

Pretorius says Toyota has more black dealers than the rest of the industry put together. He also boasts of their company being the first one to have a black area manager. There are other achievements but he says he would rather not boast about that aspect.

He says the motor industry is moving into a colourless society.

The strong replacement demand underpinned the new vehicle market last year. Although total sales grew, buyers were going for the smaller cars.

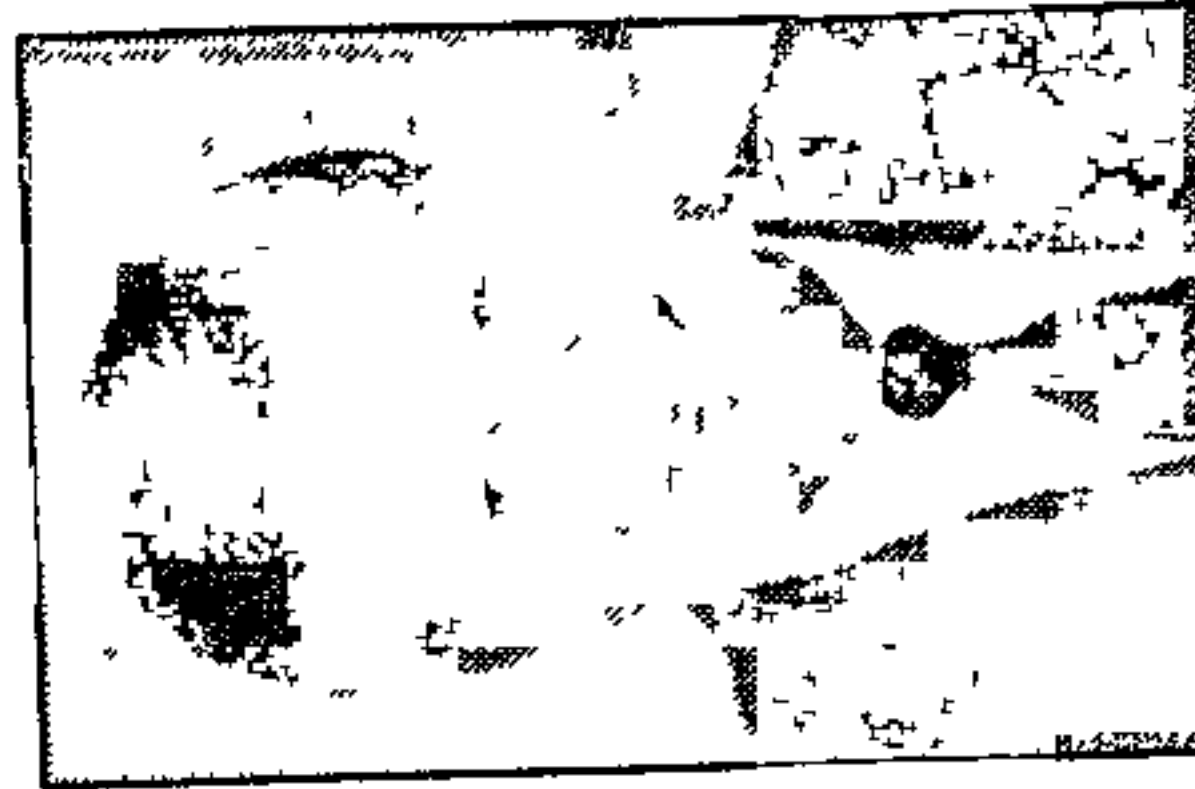

Brand Pretorius

Spares turnaround helps Vektra's earnings spurt

BIDAY 17/2/94

MICK COLLINS

A TURNAROUND in its spare parts and motor dealership business saw Vektra Corporation boost turnover 43% from R484,7m in 1992 to R691,6m in the year to end-December.

However, as a result of the restructuring of the group's parts business, the 1992 and 1993 results are not strictly comparable

The first of the W&A companies to report, Vektra saw net profit improve 135% from R2,8m to R6,6m and earnings a share shoot up 133% from 23,9c to 55,6c.

An increased final dividend of 12c (9c) was declared to make the total for the year 18c (15c)

The London- and JSE-listed company reported a pre-tax profit of R15,5m compared with the previous year's R4,7m. However, as the directors point out, changes in UK accounting requirements also boosted the comparison with 1992

Chairman Alan Schlesinger said an important factor responsible for the group's improved performance — achieved in difficult trading conditions — was better expense and asset management.

"Both operating divisions — Venture Motor Holdings and Varex Corporation — produced results which were pleasing in the circumstances. In each case, the prudent manage-

ment of resources and a strong emphasis on internal efficiency contributed to sound performances," he said

Announcing the results for its first full year of operation at the same time, Varex reported a turnover of R346m and fully diluted earnings of R17,3m which translated to 69,2c earning a share.

In the 10 months of its existence in 1992, turnover was R268,9m and earnings were R14,7m or 63,5c earnings a share. A final dividend of 22c was declared for a total of 33c. The full dividend in 1992 was 30c.

The directors said the increase over 1992 was significant, as the two months in 1993 not included in the comparison had been slow from a

trading point of view.

Schlesinger said the process of consolidating and rationalising Varex's component business had progressed according to plan. (192)

He said all divisions had traded satisfactorily, with the retail operations in the northern Transvaal performing particularly well.

"Intense competition and the disruption of trading by political events reduced the operating margin for the year to 7,4% against 9% last year. Management did well, however, to increase volumes in intensely competitive markets.

"Good asset management by Varex contributed to a reduction in interest paid from R2m in the 10 months of 1992 to R535 000 in 1993."

Schlesinger said the proposed acquisition of Alert Engine Spares had been shelved because the Competition Board had approved the deal only after the expiry date for the completion of conditions precedent.

Turning to Venture Motor Holdings, which houses Williams Hunt, SA's largest Delta dealership, Schlesinger said the turnaround had become evident in Venture in 1993.

"In a highly competitive market, margins were reduced slightly, but this was more than offset by a significant increase in the company's sales volumes," he said.

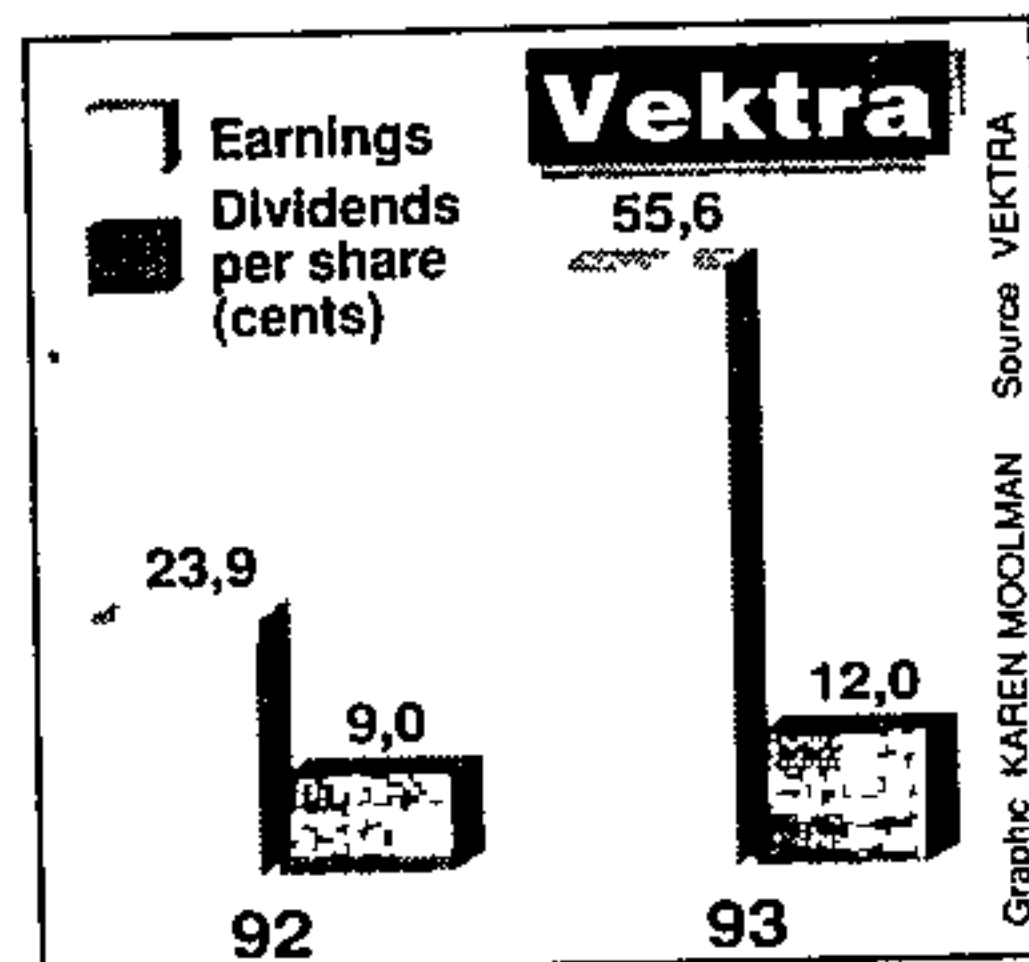

MOTOR INDUSTRY — 1
Fu. 18/2/94
Warnings from Oz

Australia's motor industry plan, on which SA looks like basing its own industry's long-term strategy, has cost about 20 000 jobs among car and components manufacturers, say analysts there. And worse may be to come.

Government and industry are divided on the success of the plan so far. Government officials say the industry is taking on the internationally competitive shape the nine-year-old plan was intended to achieve. They argue that the number of manufacturers is down to realistic levels and that a sharp reduction in the number of locally built car models is creating high-volume, cost-effective manufacturing (192).

The motor industry itself — or what is left of it — doesn't dispute the need to achieve world competitiveness. But there are questions about whether the potential long-term gains are worth the intense short-term pain.

The answers are of great interest to the SA motor industry, which is awaiting details of an intended long-term programme. A government-appointed industry task group is putting finishing touches to proposals which are due to be presented soon to Trade & Industry Minister Derek Keys.

The group started work in October 1992, acting on broad guidelines laid down by Keys. These included the need to reduce the number of locally built car models, to make them more affordable, protect the balance of payments and encourage employment growth.

In most respects, these are akin to the targets of the Australian plan when it was implemented in 1985. Naturally, there are differences but fundamental similarities between the two countries — the size of the markets and an overabundance of manufacturers and car models — made Australia's experience a natural model on which to base the SA industry's blueprint.

Last week's announcement by Ford Australia, that it is to stop local production of the Laser and Capri ranges and close its Sydney assembly plant, suggests that even after nine years the motor industry there is still coming to terms with the government's plan.

The Sydney shutdown, scheduled for September, will cost 400 jobs. Most workers on



the Capri production line in Melbourne will be transferred to other Ford jobs — but even they can't rest easy

Ford Australia president John Ogden refuses to give a firm commitment on the firm's plans in Australia. After September its only remaining locally built car range will be the medium-sized Falcon.

Ford is already committed to spending Aus\$250m on the latest Falcon range but there is increasing speculation that, once this model has run its course (possibly by 1997), Ford might withdraw totally from local production and opt for full imports. If that happens a further 7 000 jobs will go. Industry Minister Peter Cook confirms Ford won't make promises on its long-term future. He blames many of Ford's problems on its failure to develop an export strategy.

That's an oversimplification, says Ford, which contends one of the main problems is the steady erosion in import tariff protection. Currently 30%, it is being reduced at the rate of 2.5 percentage points a year towards a 2000 target of 15%.

By contrast, Gatt permitting, the SA task group is expected to recommend long-term tariff reductions stop at around 30%.

Ford considers the eventual 15% to be too low. At the existing 30% protection, little more than half the 1985 starting level, the rate of imports has already increased to the point where they constitute almost one-third of car sales. Even with continuous cost reductions, local companies aren't confident they can compete at 15%.

Companies have asked government to reconsider the target but the response so far has been negative. Toyota, which is investing nearly A\$700m in a new Melbourne plant, admits it's not comfortable with 15%. Says consultant Ian Lovell "This is an expensive gamble but one we can't avoid. We couldn't improve our quality any further with the old plant so we have to go ahead with a new one if we want to compete."

Mitsubishi, with A\$500m of investment in the pipeline, and General Motors-Holden with A\$110m, admit to similar misgivings.

Another obstacle, in some eyes, has been the "horrendous" duty payable for failing to build at least 30 000 of any one car model. This penalty was largely responsible for Nissan halting production last year.

Government, though, is largely unimpressed with these complaints and asserts that its plan is on track. Former Industry Minister John Button, who devised the plan, envisaged the reduction of Australian-made cars from 13 to six or fewer, and manufacturers from five to no more than three.

The latter has essentially been achieved. Toyota and GM-Holden are effectively one, having merged many operations under United Australian Automotive Industries. The Toyota Corolla is also marketed with the Holden badge under another name, while Toyota puts its own badge on one of Holden's larger models. Add Ford and Mitsubishi, and that makes three.

With the demise of the Laser and Capri,

January vehicle sales

Cars	Total	%*	
Golf/Jetta (new) 1 266, Golf/Jetta (old) 50, Cit/Fox 1 685, Audi 223		22,7	
Corolla 2 148, Camry 846, other 12		21,1	
Sentra 1 479, Maxima 104, 200SX/300ZX 6, Fiat Uno 686		16,0	
Honda Ballade 1 105, M-Benz W124 375, W140 50, W201 1, other 2		10,8	
Ford Laser/Meteor 362, Telstar 423, Mazda 323 342, Mazda 626 358, Pajero 16		10,5	
Astra/Kadett 1 339, Monza/ Kadett 42, Rekord 72, Calibra 10		10,3	
BMW 3-Series 1 014, 5-Series 168, 7-Series 31, other 1		8,5	
*% of the total car market			
	1994	1993	% Change
January	14 218	13 484	+5,4
December (13 419) - January			+5,9
Toyota			
January	6 542	6 574	-0,5
December (6 935) - January			-5,7
Mitsubishi			
January	209	240	-12,9
December (168) - January			+24,4
Other			
January	262	337	-22,2
December (377) - January			-30,5
Total			
January	21 231	20 666	+2,7
December (20 900) - January			+1,6

Source: NATIONAL ASSOCIATION OF AUTOMOBILE MANUFACTURERS OF SA

local production will be concentrated on five models — three from the Toyota-GM combine, and one each from Ford and Mitsubishi.

Button is in no doubt about the success of his master plan. He says "An industry with a relatively small local market, a large number of plants and no significant exports was incapable of producing good-quality cars without high and costly levels of protection. Investment, production technology and management skills need to be concentrated in viable plants."

Lovell cautions, however, that government

mustn't be complacent. The danger of overkill can't be ignored.

"Government sees the number of companies and models at target levels, and the investments we are all making, and so it is patting itself on the back and saying everything is all right. It isn't. We're in a declining tariff regime and facing the vagaries of international currencies. We're doing our bit to be competitive. Now the government must play its part, too."

MOTOR INDUSTRY — 2

Heat on converters

In a R14m joint venture between the German Gillet company and Samcor, a fourth "canner" of catalytic converters (which installs finished catalysts into converter assemblies) will commence production in Port Elizabeth this April.

"We expect gross sales revenue of about R40m/year and could double output on a two-shift basis, depending on orders. We are looking at a 150 000 a year supply of canned product to a major European vehicle manufacturer," says Samcor component export director Rob Boyd.

This investment takes place against a backdrop of growing industry uncertainty. Converter manufacturers and the National Association of Automotive Component and Allied Manufacturers (Naacam) are locked in a dispute over continuing Phase Six local content incentives.

The R220m/year Catalytic Converter Interest Group (CCIG), representing local "coaters" and "canners" of catalytic converters, wants continuation of the lucrative Phase Six incentives (as promised by government in 1989) in order to grow into a significant player in the multibillion dollar global market. But the R6,5bn/year Naacam feels CCIG members are being grossly spoiled by the Phase Six programme.

The latter allows car manufacturers to include the Platinum Group Metals (PGM) value of catalytic converters when claiming rebates under the local content programme. This enables converter manufacturers to "load" their prices to local car makers — without which they could not compete with European manufacturers.

The Motor Industry Task Group (which is investigating a new motor assembly and components industry plan for SA) suggests the catalytic converter PGM content be "capped" at maximum platinum and rhodium price levels of US\$360 and \$1 000/oz. On Tuesday, prices stood at \$397 and \$825/oz respectively.

But Naacam executive director Denzil Vermooten goes beyond this, suggesting that "the (components) industry must progressively move towards eliminating the value of raw materials from the envisaged (new) export facilitation formula." Naacam members fear their incentives under Phase Six are being gobbled up by the PGM value.

VLEISSENTRAAAL

Fm 18/2/94

Beefing up growth through JSE

Giant meat group Vleissentraal has decided to forgo the peace and comfort provided by the Co-operative Act and join the fray inside the Johannesburg Stock Exchange bullring

In the process, a major new player in the food processing and processed leather industry sectors has been born, and looks set to make waves

As part of a major restructuring exercise, the R3bn/year co-operative has transformed itself into a holding company (Vleissentraal Beherend), with three major divisions — co-operative, feedlots (known as Oskor) and a R1,5bn/year industrial holding company, Kolosus, which will be listed on the JSE

Kolosus MD Tito Vorster says the consolidated industrial holding group will exclude Vleissentraal's agency and feedlot activities but include its fresh meat, meat processing and abattoir, as well as all its hide tanning and fellmongery (dealing in sheepskins) operations. Brand names in the group (not all are 100% affiliates) include Spekenam, Bull Brand, Supreme, Kovisco, Gants (meat division) and the Sams fresh meat retailing division

Kolosus will have three major divisions — the R320m/year Leather Resources division, all set to increase the range and quality of its leather products, the R800m/year Food Technology division, which will focus on market growth in the rural market, and go into partnership with black entrepreneurs, and the R290m/year Brand Investments (which currently includes Bull Brand and the Gants meat division), the Kolosus arm that will concentrate on mergers and acquisitions

"We will look for synergistic opportunities. Various discussions are under way and we expect to announce important strategic alliances in the current financial year," says Vorster

He says Kolosus is looking for about R180m to expand its food-processing and value-adding activities, especially in the hides and skins areas. About 45% of the shares in the new company will be sold to the public and the capital used to finance downstream expansion. But Vorster does not expect the Kolosus listing to occur in the group's current financial year (ending May 31) — or at any time during 1994. "I expect us to go for a listing in 1995 — as soon as the investment climate is right"

In going the listing route, Vleissentraal will follow in the footsteps of the Langeberg fruit canning co-operative. Since selling off

half its shares to the Tiger group, Langeberg has prospered greatly, multiplying values for its shareholders, half of whom, originally, were farmers (3) Meat

By adding value to its core food activities, Vleissentraal's Kolosus would follow another good example — Foodcorp. Under the leadership of late CEO Dirk Jacobs, the former loss-making Kanhym was turned into a highly profitable, value-adding food processing group

Currently, Vleissentraal affiliate Fellmongers Export Co exports most of its high-quality, semi-processed pickled pelts (sheep skins) to leather garment manufacturers in Europe, the Middle East, the Far East and the US. By going further downstream, turnover of Kolosus's Western Tanning and King Tanning operations, which cover the automotive, shoe and furniture industry markets,

holders (through their stakes in the primary co-operatives) should be happy with the proposed listing move. Once involved with the JSE, they may well become more familiar with JSE bulls than those of the four-legged variety

MOTOR INDUSTRY — 1
Fm 18/2/94
Warnings from Oz

Australia's motor industry plan, on which SA looks like basing its own industry's long-term strategy, has cost about 20 000 jobs among car and components manufacturers, say analysts there. And worse may be to come

Government and industry are divided on the success of the plan so far. Government officials say the industry is taking on the internationally competitive shape the nine-year-old plan was intended to achieve. They argue that the number of manufacturers is down to realistic levels and that a sharp reduction in the number of locally built car models is creating high-volume, cost-effective manufacturing (192)

The motor industry itself — or what is left of it — doesn't dispute the need to achieve world competitiveness. But there are questions about whether the potential long-term gains are worth the intense short-term pain

The answers are of great interest to the SA motor industry, which is awaiting details of an intended long-term programme. A government-appointed industry task group is putting finishing touches to proposals which are due to be presented soon to Trade & Industry Minister Derek Keys

The group started work in October 1992, acting on broad guidelines laid down by Keys. These included the need to reduce the number of locally built car models, to make them more affordable, protect the balance of payments and encourage employment growth

In most respects, these are akin to the targets of the Australian plan when it was implemented in 1985. Naturally, there are differences but fundamental similarities between the two countries — the size of the markets and an overabundance of manufacturers and car models — made Australia's experience a natural model on which to base the SA industry's blueprint

Last week's announcement by Ford Australia, that it is to stop local production of the Laser and Capri ranges and close its Sydney assembly plant, suggests that even after nine years the motor industry there is still coming to terms with the government's plan

The Sydney shutdown, scheduled for September, will cost 400 jobs. Most workers on

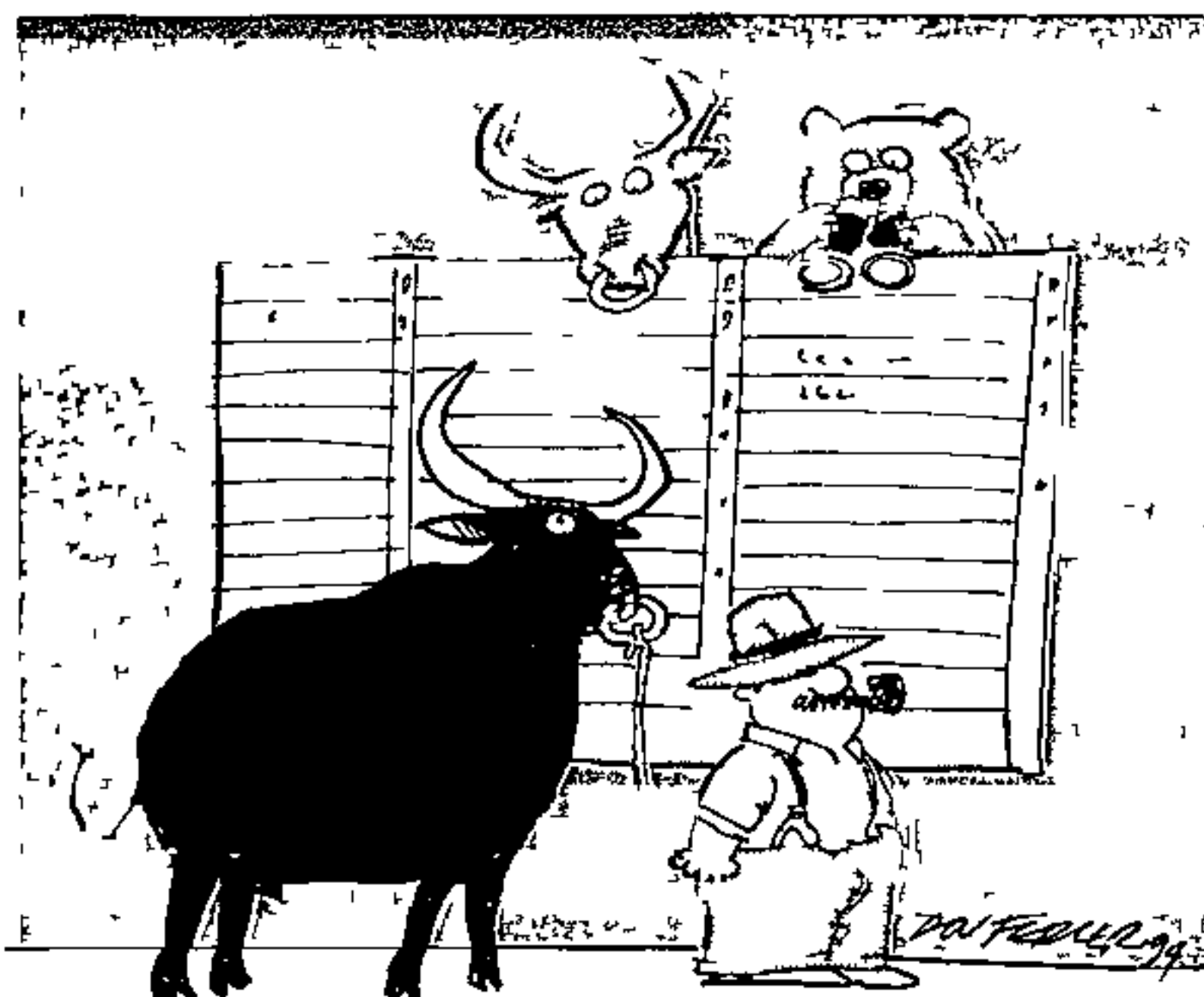

will be increased

Vorster is confident of getting the equity capital to finance the expansion. "Our capital worth of about R380m and net profit of R32m in the financial year to May, 1993 provide a sound base on which we will build"

The Co-operative Act does not allow raising equity capital — only for borrowing funds from members, commercial banks or the Land Bank. Fortunately, a recent amendment to the Act now allows co-operatives to register themselves as public companies — and thereby to go for a listing

Vleissentraal, a so-called central co-operative, is owned directly by 34 active primary co-operatives and does not have to get a majority "yes" vote from thousands of farmer members for its incorporation and public listing

Given the rise Langeberg's farmer members have enjoyed in their share's value since its listing, most Vleissentraal farmer share-

P.T.O →

Uitenhage workers heed stayaway call

B) Day Own Correspondent 24/2/94

PORT ELIZABETH — Production was brought to a standstill at Volkswagen yesterday as a result of the one-day stayaway called by the PAC in Uitenhage to mark a day of mourning for the late Apla chief Sabelo Phama Gqweta.

And Goodyear spokesman Mike London said that of the company's 800 workers, 350 reported but left after a meeting to respond to the PAC appeal to attend Phama's memorial service.

He said in view of the clashes between the PAC and ANC in Uitenhage in February 1990, the workers who reported for duty took the decision to leave work to go and sort out the matter peacefully. (192) ~~192~~

Volkswagen spokesman George Platt said workers in Kwanobuhle "were prevented from coming to work this morning. This resulted in absenteeism of about 45 percent, making normal production impossible". Those who reported for duty were sent home. ~~192~~

In Port Elizabeth, however, workers reported for duty and pupils attended classes.

In Umtata, PAC president Clarence Makwetu recommitted the organisation to peaceful participation in the elections only minutes after senior Apla officer Juma Yonana declared it would "continue hitting wherever necessary".

Both men were addressing a memorial service for Phama, who was killed in a car crash in Tanzania.

Report by M Sefiso, EP Newspapers, 19 Baakens St St. PE, and B MacLennan, Sapa, Press Gallery, Parliament

Sales climb on used cars

THE country's largest vehicle distributor, McCarthy Motor Holdings, has increased its turnover from used car sales by nearly 30 percent to R1,3-billion *CIPRESS*

This means that the company sold the equivalent of over R4 million in used cars on every one of 280 trading days in the year *27/2/94*

"Our continued growth in the used car market is a result of a long-term strategy of not being dependent on new vehicles," says chairman Theo Swart

"The extent to which that strategy has succeed-

ed is illustrated by the fact that used car sales now account for around 25 percent of the total annual turnover of the company"

He says the private buyer is struggling to afford a new car in the tough economic conditions at present *(192)*

"The ordinary purchaser now counts for less than 20 percent of new car sales," he says

"Another factor is the return to the market of people who have been holding on to their old cars for longer than normal and now find it uneconomical," he says

Delta lays off salaried staff members

PORT ELIZABETH — Delta Motor Corporation yesterday announced that it had retrenched 50 salaried employees

A further 70 staff and management employees had accepted early retirement packages offered by Port Elizabeth's largest employer

Delta is expected to make another announcement later this month on the future of the some of the indirect hourly-paid staff. The company is not releasing any details at this stage as it is still engaged in negotiations with unions

The National Union of Metalworkers was prevented from releasing any details after a court order against the union last month

Delta obtained the order to prevent

newspapers from publishing details contained in a report commissioned by Delta that showed management was top-heavy

Human resources director George Stegmann said staff employees had been told of their "separation" yesterday, effective at the end of March (192)

"In the face of increased overseas competition — reduced protection levels for the industry locally and the need to achieve levels of productivity and efficiency which are globally competitive — it is imperative that Delta realigns its structures, core processes and systems to meet projected business requirements," Stegmann said

Own Correspondent

Shock as Delta ⁽¹⁹²⁾ ARG 1/3/94 reduces staff levels

The Argus Bureau

PORT ELIZABETH — Motor manufacturers Delta are retrenching 50 senior staff members along with 70 employees taking early retirement packages

And there could be more retrenchments — of hourly-paid employees — at the end of this month

The retrenchment announcement comes after weeks of uncertainty, with employees aware of possible layoffs — in spite of management denials in January that they were “talking retrenchments”

Human resources director George Stegmann said the “limited reduction in staffing levels” followed a decision by the directors at the end of last year to “restructure the organisation of the company to meet the challenges of extensive and rapid changes” in the industry

A report circulated among newspapers last month by the Union of Metalworkers (Numsa) outlined Delta’s “top-heavy” management in relation to industry norms

The report was given to Numsa by Delta management, but Delta obtained an interdict preventing the publication of the details. Delta said it would cause “unnecessary harm”

“We’ve known all along that there was something wrong. That report alone showed it. Yet our directors insisted that everything was rosy and all they needed was the early retirement packages,” an irate employee said

The shock announcement to staff yesterday means that many breadwinners will be unemployed — joining the city’s overcrowded unemployment market

Mr Stegmann said 70 people had accepted the early retirement package, which was offered to management level staff over 55

“However, reduced manning levels required in the organisation for restructuring made it necessary to relinquish the services of a further 50 personnel,” Mr Stegmann said

These staff were told formally yesterday of their retrenchment. Mr Stegmann said 20 “accumulated staff vacancies” would not be filled

Referring to the retrenchment packages, Mr Stegmann said packages would be “consistent with length of service”

Referring to possible retrenchments of hourly-paid workers, Mr Stegmann said “A potential reduction in levels of non-production, hourly-paid employees, effective from the end of March, is being discussed”

He said consultations were taking place to ensure all alternatives to retrenchment were explored

Toyota runs up higher profits ⁽¹⁹²⁾

CF 2/3/95

From CHARLOTTE MATHEWS

JOHANNESBURG — Car manufacturer Toyota SA improved earnings a share by 14,3% to 275,1c in the year to December 1994 compared with 1993 despite the industry strike, higher component prices and a decline in market share

Turnover grew to R4,9bn from R4,6bn and operating income was 11,3% better at R183,0m, showing operating margins improving to 3,7% from 3,5% previously

Toyota's directors said this was still unacceptable. It stemmed from another depreciation of the rand against the yen, making the average cost of imported components steeper and in-

creasing the net excise account as well

Because of competition in the market place, this could not be offset by price increases. Toyota's market share in 1994 was 26,8% from 29,4% in 1993, mainly because of the political turmoil in KwaZulu-Natal which disrupted production

Attributable income grew to R111,8m from R97,8m and a more generous 50c (42c) dividend was announced on a reduced dividend cover

The total new vehicle retail market should grow by about 13% in 1995 against 1994 as the economy improves. Toyota plans to sell over 100 000 new vehicles and to achieve a 28,5% retail market share

Market gains aid Toyota recovery

Biday 3/3/94

MICK COLLINS

IN A major recovery, motor vehicle manufacturer Toyota posted a 34,3% rise in turnover to R4,6bn (R3,4bn) for the year to end-December

The improvements were the result of a significant increase in market share and the fact that the group faced no major industrial action during the year

Attributable income rose 58,7% to R97,8m (R61,6m) which translated into earnings a share of 240,6c (151,6c) The dividend grew 47,5% to 42c (28,5c)

After-tax income showed an increase of 51,8% at R94,6m (R62,3m) due to a lighter tax rate which dropped to 42,4% (55%) This was mainly due to a reduction in the nominal tax rate, offset by the introduction of secondary tax on companies (192)

However, operating income came in only 17,4% higher at R164,3m (R140m) as the trading margin at 3,5% (4,1%) narrowed due to a substantial deterioration in the rand/dollar exchange rate, particular-

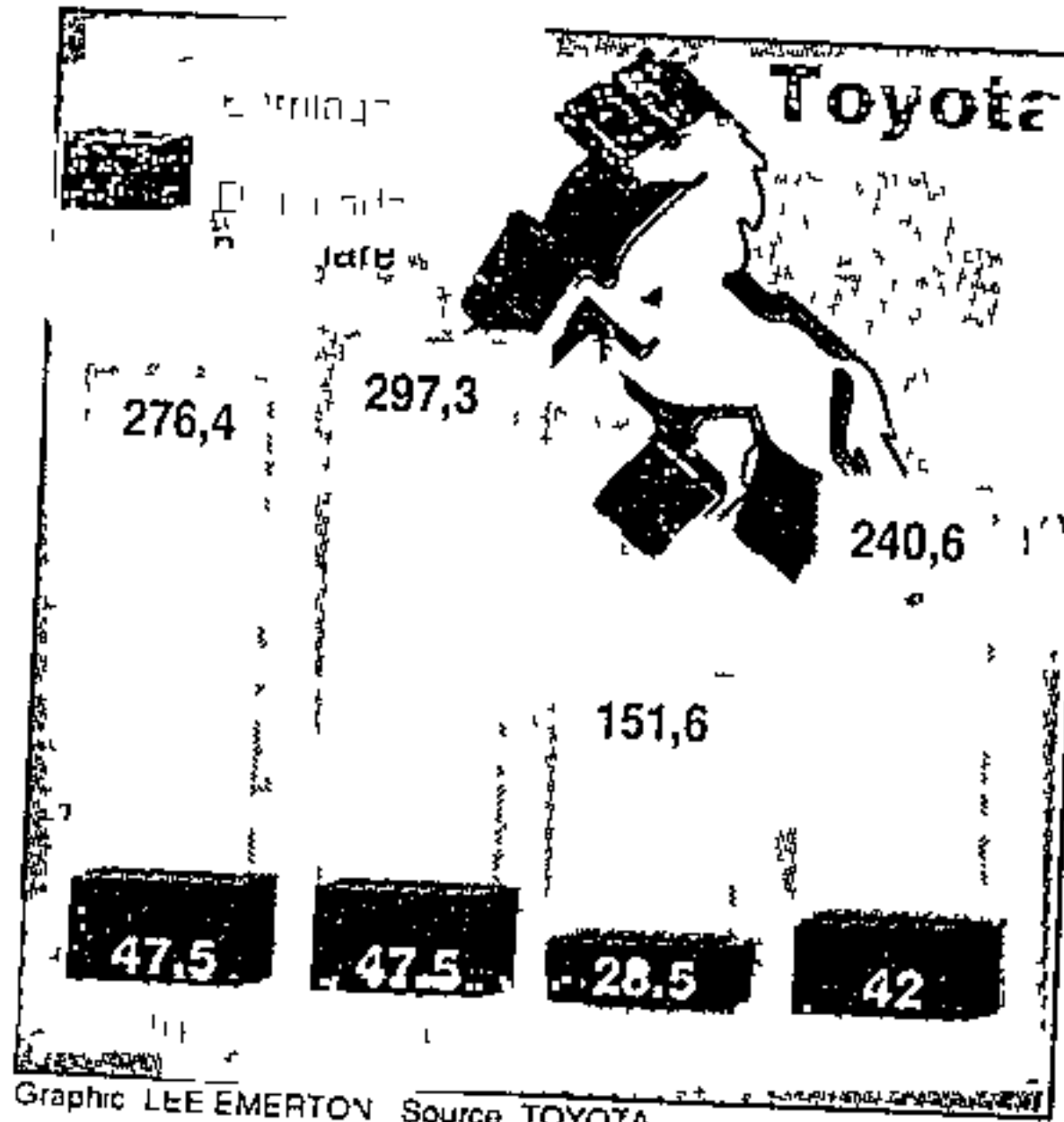

Graphic LEE EMERTON Source TOYOTA

ly during the first eight months of the year. The deterioration caused an average increase in the cost of imported components and a concomitant reduction in rebates against the excise account of about 30%

□ To Page 2

Toyota

Biday 3/3/94

□ From Page 1

over the previous year. Due to competitive pressure, the increase in cost could be only partially offset by price increases

Chairman Bert Wessels said the year had shown a modest improvement for the motor industry (192)

"In total 298 070 new vehicles were sold compared to 284 028 the previous year, an increase of 4,9%. Toyota's sales increased from 76 751 units in 1992 to 87 491 units in 1993, an increase of 14%. These resulted in an improvement in Toyota's market share from 27% in 1992 to 29,4% in 1993"

He expected the new vehicle retail mar-

ket to improve by as much as 6% over 1993. "Although an improvement in the national economic situation is expected, it remains uncertain whether the detrimental and unacceptable level of violence in the country can be curbed"

Wessels warned that industrial relations could also be affected by political events. He said Toyota aimed to maintain a retail market share of about 29% this year. But the potential for relative movement of the yen against other currencies was uncertain. Such movement could have a marked effect on the group's performance

XX

Motor parts maker Metair takes off at full throttle

B/Say 8/3/94

MICK COLLINS

MOTOR component manufacturer and distributor Metair Investments surged ahead in the year to December, reporting earnings up 260% to 517c a share compared with the previous year's 144c a share.

Metair, whose major shareholder is Toyota holding company Wescor, saw turnover rise 55% to R565m (R365,7m), mainly as a result of improved trading conditions

The trading margin widened from 3% to 8% which resulted in a 291% increase in operating profit to R46,8m (R11,9m).

Tax, although at a lower rate, came in 379% higher at R15m (R3m), but did little to dent after-tax income, which rose 260% to R31,6m (R8,8m)

Attributable income soared 75% to R27,8m (R15,9m), which resulted in the 260% improvement in earnings a share. The year's dividend was raised 225% to 130c (40c). Dividend cover improved from 3,6 to 4 times

Group chairman Elisabeth Bradley said Metair's results and those of almost all its subsidiaries were much improved compared not only with 1992, when prolonged industrial ac-

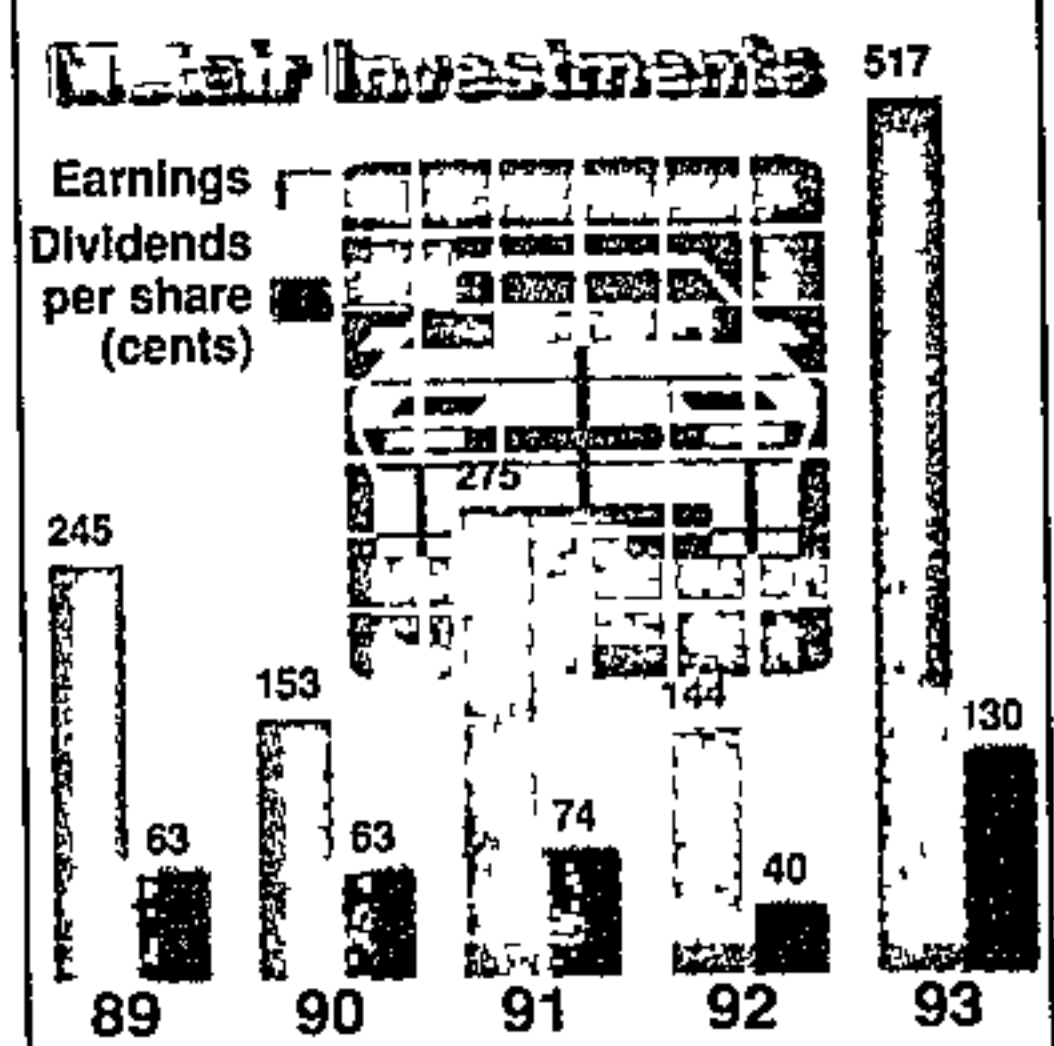

Graphic: KAREN MOOLMAN Source: METAIR INVESTMENTS

tion severely affected production, and also with previous years

She said trading conditions were somewhat better in 1993 with vehicle sales increasing 5% to 298 045 units

The group also had fewer labour problems and new projects had come on stream

"All these factors contributed to the improvement. In addition, capital projects commissioned during the previous year have now started to pay dividends. With a healthy cash flow, loans to fund these investments have almost all been repaid at the end of the year."

Bradley said this was reflected in

the lower interest bill. It could be seen also in the reduction in interest bearing debt.

"The balance sheet shows a healthy gearing position with shareholders' funds representing 61% of total assets," she said

The positive cash-flow was achieved despite the increased shareholding acquired in the past two years in Hella SA and First National Battery Company. First National Battery became a 71% subsidiary and Hella a 100% subsidiary

The disposal of Metlink in 1992 generated cash and the aggressive revaluation depreciation policy of the group had helped to conserve it, Bradley said.

The consolidation of the results of First National Battery and Hella accounted for 30% of the 55% increase in turnover

Net asset value a share increased 23% from R28,86 to R35,45

"Operating income as a percentage of turnover increased from the 3% of last year to 8%, which demonstrates the group's potential when not hampered by political and labour disruptions," Bradley said

"Taxation at 32% reflects a further absorption of tax losses as reported during the last annual accounts"

First Volvos arrive in Durban since Sweden's boycott of SA

192
ARG 9/3/94

Motoring Editor

AS some importers hold their breath waiting for the go-ahead on the new, reduced import duty — a figure of 80 percent has been agreed to — others have forged on without waiting

The first Volvo cars to arrive here since Sweden started its trade boycott two decades ago were unloaded in Durban this week

Brought in by Volvo's South African partner, Durban-based quoted company Combined Motor Holdings (CMH), 64 luxury cars totalling R12 million were offloaded, CMH said in a statement

Through Swedish Car Distributors (Pty) Ltd, a subsidiary of CMH, dealerships trading under the name of Swedo Car have been established in Johannesburg, Pretoria, Cape Town and Durban.

While the cars are manufactured and assembled entirely by Volvo Europe, full parts and service will be provided locally. A comprehensive range of mechanical and body parts has already arrived in South Africa. Local service personnel have embarked on an ongoing training programme by Volvo technicians in the use of special tools and test equipment to meet Volvo's international standards

The first four models to drive on to South African soil are the Volvo 850 GLT sedan, Volvo 850 GLT Turbo, Volvo 850 Estate and Volvo 850 Estate Turbo, all of which are available in automatic or manual

The 850 front-wheel drive series is a new generation of Volvo featuring four technological world firsts: an integrated side impact protection system, an automatic seatbelt adjuster, a special patented rear-wheel suspension system and a unique transverse five-cylinder, 20-valve, 2.5 litre engine.

As Sweden's major car manufacturer, Volvo has a presence in almost 100 countries with a wide-ranging network of 2 000 dealerships and 2 700 service workshops worldwide. Volvo sold 304 000 cars in 1992

During its 23-year involvement in the local motor industry prior to Sweden's disinvestment, Volvo sold 33 000 cars in South Africa, 10 000 of which are still running today

● While strictly speaking not an "import", Hyundai are being seen more and more in Cape Town. The southern African distributors of the Botswana-assembled Korean cars advertised the opening of their Foreshore showroom this week

port.

Stock shortages trim new car sales

By MAGGIE ROWLEY
Deputy Business Editor

A SHORTAGE of stock contributed to the number of new car sales falling by 1,9% in February to 17 818 units against the corresponding month the previous year, according to figures released by the National Automobile Association of SA (Naamsa).

While down on a year ago, February car sales showed a significant 11,2% improvement on January this year when 14 220 units were sold with total vehicle sales up 15,7% month on month.

Sales of new light commercial vehicles, bakkies and minibuses however were up marginally on February 1993 at 8 140 units against 8 105 and 24,4% higher than January this year when 1 598 units were sold.

A mixed showing was put in by the low volume medium and heavy commercial truck segments of the market. Medium commercial vehicles sales were up 8% at 255 units over February 1993's 236 units, while heavy trucks and buses were down 10,5% at 349 units against 390 units in February 1993.

However the February figures for both segments of the market reflected fairly sharp improvements on the previous month with sales up 23,2% and 33,2% respectively.

According to Naamsa, steps by vehicle manufacturers to address the low inventory position in respect of certain models should contribute to a further improvement in sales during the current month.

Brand Pretorius, MD of Toyota SA said the February sales were disappointing if the underlying influences in the market were ignored.

The year to date figure, he pointed out, reflected a drop of 1,1% at a time when the industry was forecasting growth of 6% for the year.

"But it should be taken into account that generally the industry is currently experiencing a shortage of stock."

A secondary negative influence in the market at present was the uncertainty relating to the build up to the elections.

"It should be stressed though that the major growth in the market is only expected in the second half of the year with up to 55% of sales for the year expected to take place then.

Heavy demands

"The forthcoming election is placing heavy demands on industry to supply new vehicles for the various electoral and peace keeping agencies. Hire car companies are grabbing any new small and light cars they can lay their hands on now and this is likely to create some distortion in the market in the short term. February's sales show that small and light cars took 75,12% of all sales."

Pretorius said the situation should normalise in the immediate post election period and, given stability after the elections, the forecast of 6% growth was still a possibility.

"The light commercial vehicle sector of the market is virtually on a par with last year and the same applies to the medium com-

mercial vehicle market. The heavy vehicle sector continues to cast a shadow over the whole market though with sales lagging by 16% on a year to date basis. However, orders for certain models indicated there was some light at the end of the tunnel.

He added that February saw Toyota bounce back from its stock shortages experienced in January to record an overall market share of 30,4%.

Delta's sales and marketing director John Cuming said the month on month increase in vehicle sales indicated the "growing business and consumer confidence".

"Consumer confidence is resulting in increased demand for credit across the spectrum from bonds to instalment sales to leasing and even overdrafts. The key factor has been the reduction in interest rates and the expectation of a further cut which we still expect after the election which will be positive for vehicle sales, particularly passenger cars."

Cuming said that in spite of the encouraging indicators and their anticipation of an improved year for vehicle sales, they recognised the large unknown of the elections and it was too early to revise their initial forecast of 198 000 new passenger vehicles and 111 000 new commercial vehicle sales this year.

VWSA public affairs manager Percy Smith said they were pleased to have maintained a satisfactory market share of nearly 19% of the passenger vehicle market in spite of the production hiccoughs experienced at their Uitenhage plant in February.

(192) CT9/3/94

New car sales' revival wanes

B/Day 9/13/94

MICK COLLINS

Toyota	4 376
VW	2 983
Nissan	2 812
Delta	1 772
Samcor	1 734
BMW	1 117
M/Benz	1 022

Graphic LEE EMERTON Source NAAMSA

THE revival in new car sales waned in February as stock shortages hit the motor manufacturing industry

Figures released yesterday by the National Association of Automobile Manufacturers of SA (Naamsa) showed February's sales at 15 818 units — a decline of 301 units or 1,9% compared with the 16 119 unit sales recorded in February 1993 (192)

However, the month's new car sales improved by 1 598 units (11,2%) compared with January's 14 220 vehicles

Naamsa said demand in the car and light commercial vehicle sector remained

□ To Page 2

Car sales

B/Day 9/13/94 From Page 1

strong, but shortages of stock for certain models had contributed to "slightly disappointing" sales figures (192)

Sales of light commercial vehicles, bakkies and minibuses at 8 140 units showed a marginal improvement of 35 units (0,4%) compared with the 8 105 units sold last February. Compared with January, light commercial sales recorded an improvement of 1 598 units or 24,4%

Sales of vehicles in the market's medium and heavy commercial truck segments were mixed, showing an improvement of 8% for medium commercial vehicles and a decline of 10,5% for heavy trucks and buses over February 1993.

But both sectors recorded sharp improvements compared with January's sales, rising 23,2% and 33,2% respectively

One of the month's features was Toyota regaining its top position from VWSA with sales of 4 376 units, giving it a market share of 27,7%. VWSA took 18,9% of the market with 2 983 units sold, with Nissan — 2 812 units or 17,8% — in third spot.

Toyota SA marketing MD Brand Pretorius said "Vehicle sales for February are disappointing if the underlying influences in the market are ignored. The year to date figure reflects a drop at a time when the industry is forecasting growth of 6% for the year. A further negative influence in the market is the uncertainty related to the build-up to the elections. But major growth is expected only in the second half with up to 55% of sales expected then"

Nissan SA marketing MD Stephanus Loubser said it would take months to achieve optimum stock levels and shortages of models persisted in February

"Backlogs are still being experienced but these are being addressed"

Delta director John Cuming said the market had performed much as expected "The positive vehicle results reflect growing business and consumer confidence" However, despite the encouraging indicators "we recognise the large unknown of the elections"

Nissan to boost capacity with R111m

Own Correspondent

JOHANNESBURG — Motor vehicle manufacturer Nissan is increasing production capacity as part of a R57m short-term investment programme, with a further R54m capex in the pipeline.

The net effect will be a 20% increase in capacity from the 58 000 units a year to nearly 70 000 units.

Nissan said yesterday the move would take care of any need for capac-

ity increases over the next three to four years. This was part of its commitment to improving the productivity of its manufacturing operation and product quality.

Nissan SA marketing MD Stephanus Loubser said the company's capex programme aimed to raise productivity consistently and was in line with its aim of providing affordable products.

The company had already committed R26m at its Rosslyn assembly plant

to upgrade capacity and the paint finish of passenger and light commercial vehicles.

"In addition a new automated wheel assembly plant will improve productivity of this aspect of vehicle assembly, while a new semi-automated chassis assembly line will put highly critical dimensional accuracy at the leading edge of technology."

The company has also spent R20m on the construction of a new paint

shop at its Rosslyn truck works which would increase the paint quality and anti-corrosion characteristics of its entire heavy commercial vehicle range.

The National Automobile Dealers' Association (Nada) is to push motor manufacturers to allow multi-franchising, particularly in the rural areas where volumes are low and its members are struggling.

Nada national chairman, Ray Neth-

investment

(192) CT 10/3/94

ercott said at a regional seminar in East London yesterday that manufacturers were "living in Disneyland" if they believed SA would not follow the international trend in this direction.

"They love to have their foot on your windpipe, but they know they can't operate without us."

"What I am saying to the manufacturers is this: we will work with you, but don't fight us at every turn."

Nethercott added that multi-fran-

chise operations could have dedicated space on their showroom floors for different manufacturers, but rationalise in the area of parts and administration.

He predicted that the SA vehicle market would increase from 298 000 units last year to 317 000 this year.

He was "extremely bullish" for the next two years, but thought the pace of growth might slacken in 1997.

Nissan increases production capacity

MOTOR vehicle manufacturer Nissan is increasing production capacity as part of a R57m short-term investment programme, with a further R54m capex in the pipeline

The net effect will be a 20% increase in capacity from the 58 000 units a year to nearly 70 000 units.

Nissan said yesterday the move would take care of any need for capacity increases over the next three to four years. This was part of its commitment to improving the productivity of its manufacturing operation and product quality.

Nissan SA marketing MD Stephanus Loubser said the company's capex programme aimed to raise productivity consistently and was in line with its aim of providing affordable products

MICK COLLINS

The company had already committed R26m at its Rosslyn assembly plant to upgrade capacity and the paint finish of passenger and light commercial vehicles

(192)
"In addition a new automated wheel assembly plant will improve productivity of this aspect of vehicle assembly, while a new semi-automated chassis assembly line will put highly critical dimensional accuracy at the leading edge of technology."

The company has also spent R20m on the construction of a new paint shop at its Rosslyn truck works which would increase the paint quality and anti-corrosion characteristics of its entire heavy commercial vehicle range.

METAIR Rm 11/3/94

Sum of the parts

Successful implementation of new management strategies, sounder labour relations and a 5% increase in vehicle sales during 1993 saw automotive component maker Metair Investments lift earnings 250% to R29,3m

Admittedly, this is off a low base 1992's profit of R8,1m was the lowest since the R5m of 1986 Turnover jumped 55% to R565m, though chairman Elisabeth Bradley says the consolidation of First National Battery Company (71%-held) and Hella SA (100%) distorts the figure These accounted

FOX

Rm 11/3/94

for almost a third of the turnover increase Pre-tax margins widened from 3% to 8% and operating income tripled to R46,8m

The R15m tax charge was substantially up, though the effective rate remains low at 32% (26%) This is mainly because of utilisation of tax losses but export allowances helped Though exports are small in relation to other sales, MD Alan Plummer says management intends to increase this (192)

Metair's balance sheet remains healthy Capital projects commissioned during previous years have started to pay dividends and loans have almost been repaid from strong

MORE EFFICIENT

Year to December 31	1992	1993
Turnover (Rm)	366	565
Pre-tax profit (Rm)	11,9	46,8
Attributable (Rm)	8,1	29,3
Earnings (c)	144	517
Dividends (c)	40	130

cash flow Interest paid dropped 18% to R12,6m, still high compared to borrowings of R15m (R36,6m) Plummer says the average interest rate is artificial, distorted by a funding structure used to finance capex two years ago

Capex of R12,8m in 1993 is well down on previous years An increase this year will depend largely on recommendations made by the Motor Industry Task Force, due to be released in June-July

The share, at R19, has appreciated almost 75% since the release of interim results in August, but still remains 46% below NAV With 60% of sales going to new vehicle production, any further boost to profits will depend mainly on increased activity in this market

Marylou Greig



BU

A new era too for used cars

AFFIRMATIVE action is poised to steer the quality used car market to new heights - as more and more South Africans move into jobs that carry car allowances as part of the executive package

This is the prediction of Darryl Jacobson, managing director of two of South Africa's largest used car distribution groups - Car Bar and Burchmore's Car Auctions

The black community currently accounts for about six percent of the cars sold by the two groups, says Jacobson

"Last year there was a 10 percent increase in the volume of cars we sold to black buyers," said Jacobson.

"Now, with the population of black corporate executives set to rise dramatically, the black sector will become one of the pillars of the used car business (192)

"Many of these new executives will be in the market for a new car. But there is a growing overall trend in South Africa towards saving car allowance cash by buying and running quality, low-mileage used cars"

Price war dents

CAPE TOWN — Curnow M&G, a supplier to the spray-painting and panelbeating trades, reported a 24,5% decline in earnings to 3,7c (4,9c) a share in the year to December 1993 as a result of a price war and restructuring

The company was restructured and rationalised since its takeover from FSI last year. Curnow was bought by Cape-based Elzet Group and was merged with Elzet-owned Harveys, a leading automotive refinishing distributor in the Cape.

Turnover rose 16,5% to R54,46m (R46,83m), but restructuring and rationalisation affected profits.

Operating profit fell 24,1% to R2,33m (R3,07m) after write-offs from the merger

Curnow M&G

15/3/94
EDWARD WEST

and pressure on margins caused by fierce competition, especially certain market segments on the Reef where there was a price war.

The final dividend was held at 1c, bringing the payout for the year to 2c (192). Chairman Peter Brunnschweiler said the merger had made for exciting synergies between Harveys and Curnow and had resulted in a strong 15-branch network in the automotive refinishing specialist market.

To bed the merger down properly, extensive rationalisation of products, outlets, personnel, procedures and controls was undertaken, he said.

Star 17/3/94
**Wesco has
better year**

Motor industry investment group Wesco Investments has reported a 58 percent rise in attributable income to R39,2 million for the year ended December 1993 from R24,7 million a year earlier

Income before taxation increased 10 percent to R150,4 million (1992: R136,2 million) as finance lease charges fell to R4 million (R9,7 million)

Attributable income was boosted by a positive R6,8 million from associated companies ~~(R2,2)~~ (1992)

Earnings a share climbed 80 percent to 472c a share from 261c but Wesco declared an unchanged final dividend of 86c a share.— Sapa

Autoquip passes dividend because of high gearing

6/Dec 18/3/94
CHARLOTTE MATHEWS

MOTOR parts distributor Autoquip Group improved attributable income 7,5% to R846 000 in the six months to December (R786 000) but passed its dividend in view of its high gearing

According to figures released today, Autoquip's earnings a share were 7,7c (7,0c). Turnover increased nearly 10% to R32,7m (R29,8m), reflecting a slight market improvement. Chairman and MD Bruce Coquelle yesterday attributed this to stronger used-car sales (192)

Autoquip's finance charges lifted to R886 000 (R843 000) on the back of higher interest-bearing liabilities, shown on the balance sheet at R9,8m (R8,5m) Coquelle said he expected asset and liability levels to fall "materially" by financial year end

Gearing was now about 93% and the group was aiming to bring it down to about 75% by financial year

end The dividend would continue to be passed until gearing had reached a satisfactory level.

Autoquip has three divisions wholesaler and retailer of wheels, performance tyres and automotive accessories Autoquip, and specialised automotive parts distributors Partquip and Partco Autoquip had been consolidated and repositioned, Coquelle said Partquip and Partco were strengthening their market positions and growth was expected

MOTOR INDUSTRY

Fun 25/3/94

Painful plan for car-makers

192

A proposed new development plan for the motor industry could persuade manufacturers to halt local production of some vehicles as early as next year. If accepted in full, analysts say, it could also force some firms out of business.

The report, released this week, relates to cars and light commercial vehicles, including bakkies and minibuses. It is the work of a government-appointed task group headed by company director Derek Riley.

The task group, which includes representatives of vehicle and components manufacturers, organised labour, the Motor Industries Federation, AA and government, recently began a separate investigation into the future of heavy commercial vehicles.

At the heart of the plan for light vehicles are proposals to reduce import tariffs on vehicles and impose duty penalties on vehicle manufacturers failing to meet minimum annual production targets. The aim is to force the industry to discontinue production of low-volume cars and light commercial vehicles and allow limited imports to replace models no longer made locally.

The report complains that the Phase Six local-content programme has encouraged a proliferation of models, increased protection, diminished competitiveness and helped push up prices far beyond the inflation rate.

International competition

Says Riley "The new plan tries to create a situation whereby we can be sure of a motor industry. There has to be pressure put on the industry to perform to better price and quality standards."

The Riley plan sets out to introduce international competition by reducing protection, to discourage assembly of low-volume models and increase volumes of those that remain, to reduce model proliferation, improve economies of scale and reduce the complexity facing components companies, to encourage exports of vehicles and components, and to develop human resources and productivity and ensure long-term employment stability.

As things stand, built-up vehicle imports are subject to a 100% import tariff plus a 15% surcharge. The task group has already recommended that the surcharge should be scrapped instantly and the tariff reduced to 80%, with a further drop to 70% next year. Thereafter it suggests the tariff should fall in stages to 45% by 2002.

Over the same period it recommends that the tariff on imported components for vehicle manufacture should be reduced from 50% to 30%. The average tariff on parts for the after-sales market would stay unchanged at 20%.

Duty penalties on below-volume local production would be imposed by the forfeiture of duty-free allowances. The report recommends that vehicle manufacturers' volumes should be assessed in two ways — factory average and individual models.

Factory average is the result of dividing total annual production by the number of model ranges. Ranges are deemed to be all variants off a single design base, for instance Toyota's Corolla-Conquest, Volkswagen's Golf-Jetta, and Ford's Laser/Meteor/Rustler bakkie ranges.

From July 1 1995, any manufacturer with a factory average below 7 500 units a year would forfeit a 10% duty-free allowance, which translates into an effective 5% duty penalty on the company's products. This target average would increase to 15 000 units by 2002, with the penalty for non-compliance reducing gradually to 3%.

On the face of it, companies such as Toyota could use their highest-volume models to pull low-volume ones through the average. That, though, would counteract one of the plan's main aims, to reduce the number of models built in SA. To avoid this, the average is assessed on a manufacturer's four lowest-volume models.

The idea is that companies would replace low-volume vehicles with imports. Higher-volume vehicles would then be brought into the equation, raising the average safely above the target.

The National Association of Automobile Manufacturers of SA says the penalty system is based on the current car/light commercial vehicle market of about 293 000 units a year. As the market goes up, so do the penalties. "They become highly punitive," the association says.

A further penalty regime is recommended on individual model ranges failing to meet a second set of targets. Any range not up to 4 000 units a year by mid-1995 would be hit by an immediate 17% loss of duty-free allowance, equal to a duty penalty of just over 8%. On a sliding scale, the higher the volume, the lower the penalty, which would

be reduced to zero once production reaches 12 000. By 2002, the minimum figure is slated to be 11 000 and the zero-penalty target 20 000.

Take a manufacturer that fails to measure up on both counts — factory average and individual model targets. Until it halts production of low-volume vehicles, it could initially face combined penalties of more than 13%. "Any company in this situation — and there are almost certainly some that will find themselves there — will go out of business fast," says an analyst. "In my view, a plant will need 30 000-40 000 units and two models to survive."

Based on current market forecasts, a number of companies must be worried about their future if the duty penalties are imposed as recommended.

The seven major manufacturers are too many for the size of the local market and task-group members have admitted that it would be no bad thing if the number were reduced.

The problem is that if the casualties were to include companies such as Mercedes-Benz or Delta, it would devastate their regional economies. Mercedes' demise would wreck the Border region, and Delta's would cause huge

damage to Port Elizabeth.

Though Riley stresses that union representatives on the task group have accepted the need for a smaller industry, it is hard to see an ANC government accepting a plan that could cause major hardship in one of its main regional support bases.

Despite the report's wish to "provide the industry with time to restructure and modernise," the proposed starting date of mid-1995 leaves little time for companies to prepare. Riley says the task group was unanimous on July 1 1995 as a starting date. Vehicle manufacturers, however, say that while there may be broad agreement with the plan's objectives, there is too much of a rush to achieve them.

The report sets out to achieve three primary targets for the industry: an average of 20 000 units for each local model by 2003, a reduction in the number of models from 39 to



FM 2513 194 (192)

BONUS FOR BIKERS?

Motorcycle prices could fall by as much as 39% if government accepts the motor industry task group's recommendation for a lifting or reduction of import duties

The report says motorcycles are used mainly for business in SA and that there is no local manufacturing industry to protect. It agrees with importers that the duty structure needs changing.

It says motorcycles are subject to customs duties ranging from 10% to 15%, a surcharge of 15% and ad valorem duties reaching as high as 32%. The removal of these "could allow price reductions of 18% to 39%".

15, and imports of built-up vehicles — less exports — not to exceed 15% of the local market. However, industry officials warn the share could go higher.

The report contains other significant recommendations. For instance, it proposes that all excise duties levied on motor vehicles should be discontinued from mid-1995. And it calls for the establishment of a permanent Motor Industry Authority to monitor the sector and oversee its development.

To encourage exports, it suggests extending the number of industry sectors that may take advantage of certain export credits. Until now, only vehicle manufacturers have been allowed to use export credits to import more without penalty. In future, this right would extend to components companies and even nonmanufacturing import-export trading companies.

In conjunction with this, built-up vehicles could be imported to the same value as built-up exports, or to two-thirds of the value of exported components and tooling. Until mid-1995, it is recommended that the full value of raw materials should be included in export values. Thereafter, in general, only local added value will receive an incentive.

Scrap local content

The report recommends a starting minimum local-content level of 52,5%. Unlike existing formulas, export earnings will not contribute to this figure, which will rely solely on the value of locally manufactured vehicles. However, it is also suggested that this minimum local requirement should be scrapped after 1999.

Riley confirms that the report was adopted by a majority and was not unanimous. With so many different factions represented on the task group, it was always unrealistic to expect otherwise.

One of the dissenters, the IDC, has submitted its own "much tougher" recommendations to Trade & Industry Minister Derek Keys. The National Association of Automobile Manufacturers complains that the report was compiled in a hurry and has

suggested the task group should be given extra time to produce a more acceptable version.

Riley concedes that the report isn't perfect. "We've tried to produce a balanced report. The objectives set originally are, however, unlikely to be achieved because the recommendations are rather too cosy. To be honest, it's not as tough as I would have wished."

David Furlonger

SA EXPRESS AIRLINES

Flying into headwinds

There's a counter labelled SA Express Airlines (SAX) at the domestic departure section of D F Malan airport, but no-one is queuing in front. That's because SAX, the ANC-linked regional airline formed with the assistance of SA Airways, hasn't been granted a licence to fly yet.

It missed its planned mid-March start-up date (*Business* December 10) and the new end-of-April target may also be a tad optimistic unless the Licensing Council, which resumed hearings this week, decides in the airline's favour. Among the issues under discussion are safety, ownership and competition.

The council will have to sort through SAX's complicated organogram to determine whether control is held by South Africans, which is the law, or by Canadians. SAX is the trade name of Southern African Airline Holdings, a company formed by the ANC-aligned Thebe Investment Corp and a Canadian consortium led by Lardel Holdings.

Thebe's interest in SAX is through its holding in Alliance Airline Holdings, which is the majority (51%) shareholder in Southern African Airline Holdings. Canadian-led SA Enterprises will manage the airline and is the minority shareholder.

In addition to Letaba Airways and Airlink, Aircape also originally objected to the council granting SAX an operating licence. Aircape withdrew its objection, however, because it was satisfied that the shareholding falls within the requirements of the Air Services Licensing Act, says Flitestar GM Glynn Nortje, a former MD of Aircape. He denies emphatically that he withdrew because of political pressure to please the ANC. "The Act demands that 75% of the shareholding of an SA airline must be South African. On paper SAX's shareholding meets that requirement. The Act does not demand that 75% of the effective control must be South African."

The council's Johan Bierman says 86% of the voting power will be South African, "but the two remaining objectors argue that the company may be run from Canada."

Airlink joint-MD Barrie Webb says "Who is in control of SAX? Is it the Canadians? If it is, it's a violation of the Act, which demands that an SA airline be 75% controlled by South Africans. Whether that con-

trol must be financial or can be exercised by votes is debatable."

None of the airline's three top officials, William Deluce, Don Wallace or Michael Grey, has been available to comment on any of the ownership, safety or financial issues surrounding the company.

Deluce, a Canadian, is SAX's CE and chairman of Lardel, which has investments in Air Ontario, Canada 3000 and Austin Airways. In 1989, when he was president and CE of Air Ontario, one of its aircraft crashed in Dryden, Canada, killing 24 people. The presiding judge at the commission of inquiry into the crash blamed Air Ontario's management and operation for the incident, according to Bierman.

Bierman says the crash was one of the best documented air accidents in Canadian history. "The Canadian civil aviation authorities criticised him (Deluce) for not maintaining adequate control over safety matters."

So far, none of the 12 Canadian-built De Havilland 50-seat, turbo-prop commuter aircraft, bought for a reported US\$150m with huge Canadian government financial aid to shore up the ailing manufacturer and save 2 600 jobs, is in SA yet. The airline also has an option on another six planes.

Civil Aviation Commissioner Japie Smit is grateful for the delay because his staff has not yet been trained to give those aircraft certificates of airworthiness or to sign off on the completion of repairs and maintenance on them. "There aren't any (of the Canadian De Havillands) on the SA register, so staff don't know the aircraft yet, they will have to be trained on the aircraft themselves."

In addition to the safety and ownership issues, SAX's would-be competitors — with perhaps one eye on their own margins — have grave doubts about the airline's ability to stay afloat financially. "We are questioning the viability of the exercise," Webb says. "Some of the figures in their application don't gel with the market as we know it, and their revenue projections are over-ambitious."

Letaba Airways MD Ken Geldenhuys says he is concerned about the shareholding and finances. "We don't want any more airlines going down the tube because they didn't do their homework, or did it and padded it. It's impossible for them to be financially viable."

"We're talking of R500m of aeroplane that will have to be repaid over 10 years. That works out at R4,16m a month without starting an engine, putting fuel in any of its aircraft, paying rent for offices, paying for essential maintenance and spares, paying any of its crew, or any interest being paid. If they get an average of nearly R400 per passenger, net, one way, before Vat, which is a totally ridiculous figure, they would have to carry 11 000 passengers a month just to pay for the aircraft."

"A typical Durban flight costs R300, one-way, of which the airline nets R235 on a full plane. Using that example, SAX would have to convey 18 500 passengers a month, which

Mixed reaction to car industry plan

B/Kay 25/3/94

MICK COLLINS

THE proposed motor industry development programme had the potential to stimulate economic growth, generate job creation and provide South Africans with affordable vehicles, the National Association of Automotive Component and Allied Manufacturers (Naacam) said yesterday.

Reacting to the release of the motor industry task group's report on the vehicle manufacturing industry, Naacam president John Brandtner said the report should be refined and adjusted before being made law.

He said the report was the culmination of the first attempt by all players in the automotive industry jointly to formulate an industry policy that put national interests before sectoral concerns.

"Naacam was committed from the start to achieving a constructive contribution, which would be achieved only if there was a mutual willingness to compromise. In many instances Naacam compromised on issues possibly detrimental to some members, but such compromises were essential to the interests of the automotive industry as a whole and to its long-term viability."

He said Naacam believed the proposed development programme to be an important milestone in the process of restructuring the automotive industry. "To ensure, however, that this radical break with the past realises its full potential, much fine-tuning has yet to be done. "Since considerably lower protection levels currently apply to components compared with vehicles, and to avoid excessive and sudden damage to the component-manufacturing industry and its 40 000 employees, the lower-

ing of protection by means of reduced import duties should be monitored carefully to ensure that local components are in fact fitted as the development programme intends."

He said measures such as duty-free allowances to manufacturers which adversely affected local material content should be balanced carefully.

"Also, in the interests of employment, the mandatory minimum local content level should not be discontinued in July 1999. It should either be maintained or the duty-free allowances to vehicle manufacturers on component imports should be modified accordingly." (192)

National Association of Automobile Manufacturers of SA (Naamsa) director Nico Vermeulen said. "Naamsa believes the development plan proposals should be seen for what they are — namely a set of recommendations that require careful evaluation, thorough testing and refinement."

"To this end Naamsa will be submitting further proposals to the motor industry task group and government in due course."

Automobile Association technical services GM Johan van Vreden said the AA still believed the tariff structure was far too high and would not in any way bring car prices down.

"I don't believe the report puts enough pressure on the motor industry to bring motor vehicle prices down. The manufacturers managed to engineer a soft landing."

He said the report in itself was a well balanced document, "but I have to criticise the duties."

● Comment: Page 6

Toyota falls short of target

Star 12/4/94

BY STEPHEN CRANSTON

Toyota's results for the year to December, although they showed an 59 percent increase in attributable earnings, fell short of what had been expected at the beginning of the year, says chairman Bert Wessels.

Writing in the annual report, Wessels says that this was mainly because the rand weakened dramatically against the yen and that the average increase in the cost of imported components, and concomitant reduction in rebates against excise account, was 30 percent.

Its Japanese principal, Toyota Motor Corporation (TMC), suffered a reduction in profit due to economic developments in Japan and the strengthening of the yen.

TMC was thus limited in its

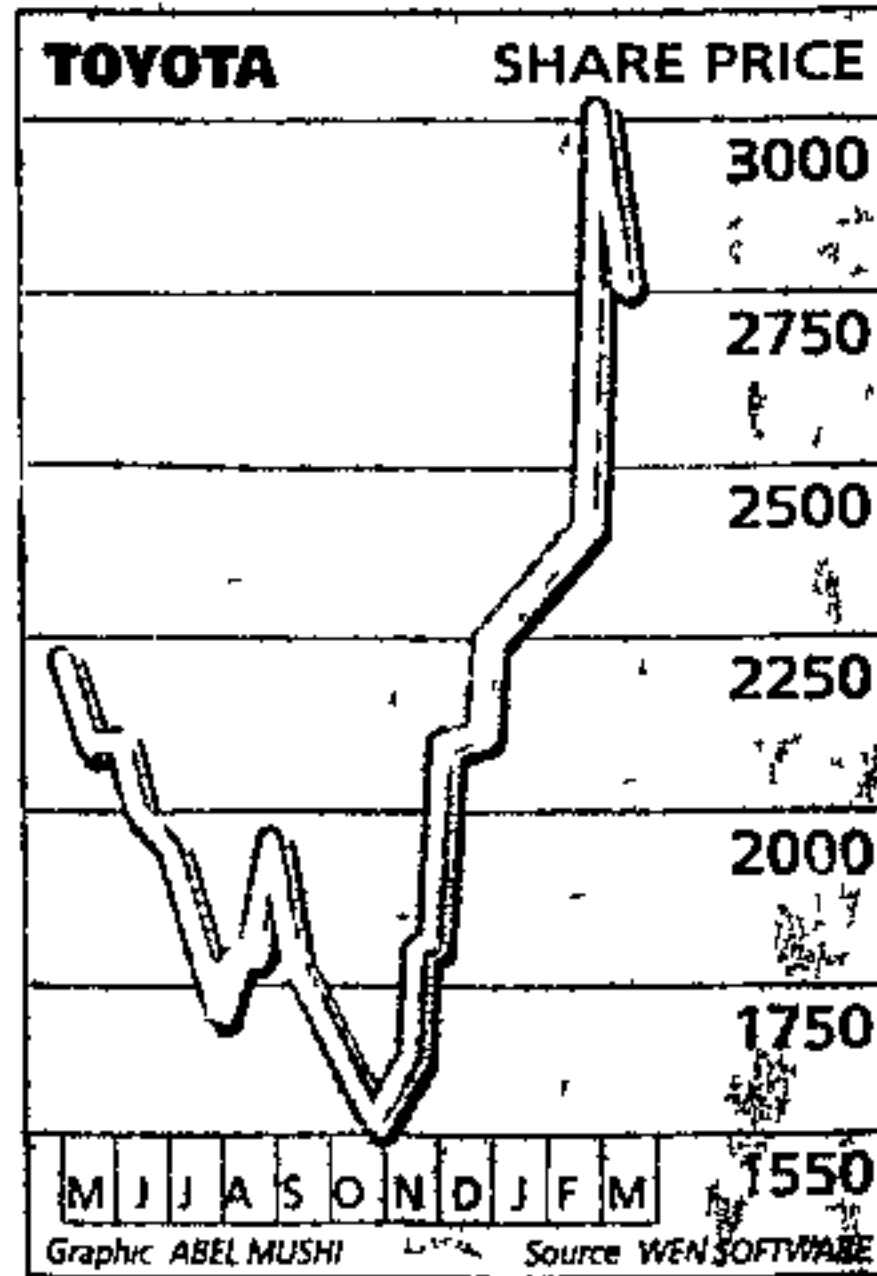

ability to assist Toyota South Africa to soften the effect of the substantial increase in the value of the yen against the rand.

There is no suggestion that TMC would like to take an equity stake in Toyota SA at

this stage, but discussions continue on ways to help Toyota SA sell in the rest of Africa.

Agreements have been reached for limited exports to Malawi, Zimbabwe and Mozambique.

Toyota is progressing systematically with the expansion of facilities, maintenance and improvement of the model range and enhancement of the efficiency of production facilities.

The upgraded Corolla range was launched in September and this range alone had a 17,7 percent share of the total car market, though this was still below its 18,6 percent share in 1992.

The Toyota Hilux, however, increased its share of the one-ton sector from 34,7 percent to 37,3 percent.

Toyota underestimated the

demand for its Venture multi-purpose vehicle and could only partially meet demand, so facilities and capacity are being expanded to increase production.

Wessels says that depending on social, political and economic developments, this year should show a reasonable improvement in the motor industry.

But competition will remain fierce, with unavoidable pressure on profitability.

Toyota has done well in a flat car market in recent years, and it looks cheap on a P/E ratio of 11,2, compared with a 17,8 average in the industrial index.

But there is a perceived risk in the share until the future of the industry and its tariff arrangements have been cleared up.

Joint operation seeks to boost exports

Star 12/4/94

BUSINESS STAFF

Safto (South African Foreign Trade Organisation) has joined hands with Tradeplan, the largest trade plan facilitator in the UK, in an operation aimed at helping SA companies secure new export markets.

"In its own way, this operation is going to cause a revolution within the South African market place, affecting not only established exporters, but also new potential exporters

who need to expand their customer base to other parts of the world," says local Tradeplan spokesman Michael Carvalho.

His Rivonia-based company, CMD International, holds the South African licence for Tradeplan.

Carvalho said yesterday Tradeplan kept an up-to-date information base on more than 20 million companies worldwide, and was able to find genuine trade partners for manu-

facturers or service industries in virtually any country in the world.

He said: "No other export operation can offer a success rate of over 97 percent achieved in finding export partners in the countries targeted."

He said the cost of Tradeplan's service for securing orders and finding new trade partners was often less than 50 percent of the cost of sending one executive on an export

trip for 10 days.

Safto now offered this service and could also offer a free advisory service on the most cost-effective way to ship goods and handle all the paperwork involved, said Carvalho.

He said the joint venture between Safto and Tradeplan dated back six years to help members of the European Union find new markets for their products outside the common market.

WAREHOUSES

site project or erection of and roof only



FERROX CONSTRUCTION

Box 4218, Leipoldsvlei 1743
Tel: 769-1066/7/8
A/H 472-2043, 674-1742

UNIT TRUSTS

It's about making the right choice

✓ BOE Growth Fund

Call your investment advisor, or
BOE Regional Sales Office on
0800-024110 or BOE Unit Trusts
on 0800-210087



BOE
UNIT TRUSTS

The Star
CLAT

THE

ING

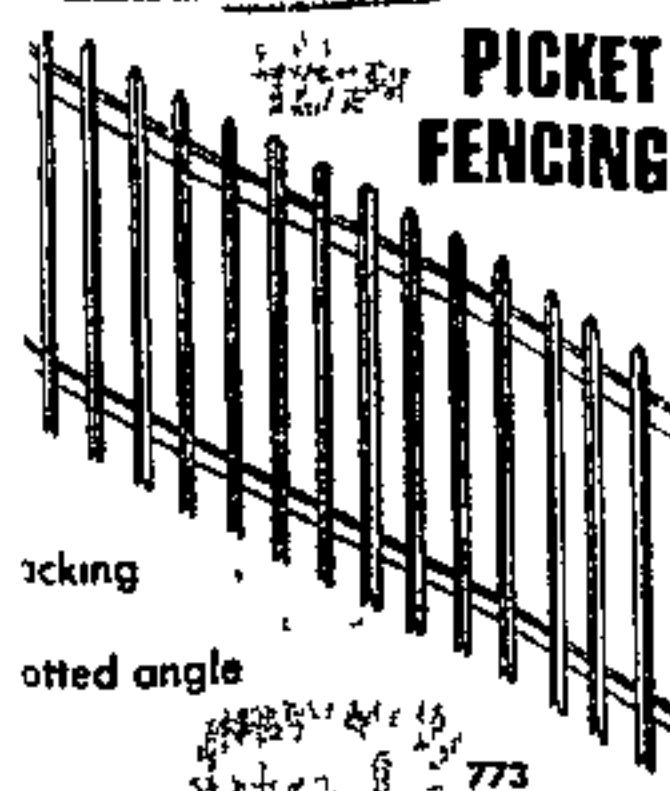

PICKET FENCING

acking
otted angle

FACTORY

randworth
functional office furnis

NEW PHONE No 334-8
FAX

CORPORATE MANAGEMENT & MEDICAL DESKS WORKSTATIONS & CHAIRS

Toyota aims to increase market share by year end

(192) B0 12/4/95

MARCIA KLEIN

TOYOTA SA hoped to produce and sell more than 100 000 vehicles and increase its market share to 28,5% (26,8%) in the year to December, executive chairman Bert Wessels said in his annual review

He said total new vehicle sales increased by only 1,7% to 303 133 in 1994. Toyota's sales were 7,3% lower at 81 133 units, and its market share dropped from 29,4% in the previous year, largely due to political turmoil in KwaZulu/Natal which affected production

Despite these factors, Toyota had announced a 14,3% rise in earnings to 275,1c a share on 6,5% higher turnover of R4,9bn for the year to end December

Wessels said Toyota was spending about R70m on expanding facilities for expected production of more than

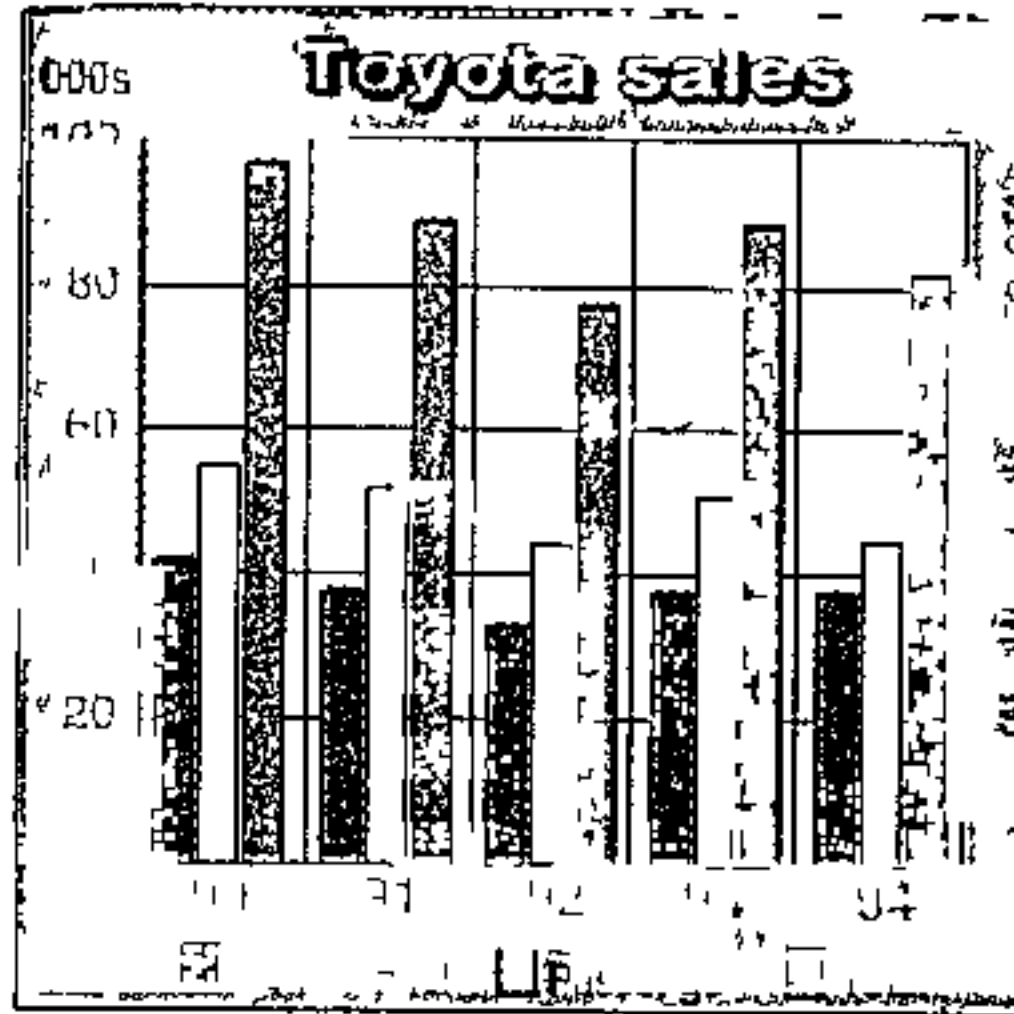

500 units a day

He expected 1995 to be "more settled" than 1994

The company still needed flexibility "to recover production lost for any reason" and to protect sales growth. To this end, it had ensured it could double-shift any model where single-shift capacity was exceeded.

Apart from the increased plant ca-

capacity, the paint shop would be modernised and new technology introduced to improve quality of finish. Toyota would focus on eliminating the production bottleneck on the Hi-Ace, Venture and Stallion models.

Wessels expected the motor industry to show improvement in 1995. But competition would intensify, "with pressure on profitability".

Commenting on financial 1994, Wessels said the improvement in income was "gratifying" considering disruptions in production during the election and the five-week motor industry strike in the third quarter.

The weakening of the rand against the yen resulted in higher imported component costs. Wessels said careful management of Toyota's foreign exchange exposure "appreciably reduced the impact".

Local material savings and efforts to control overhead costs also contributed to the increased earnings.

By AUDREY D'ANGELO
Business Editor

Car sales braked by shortages

A SHORTAGE of stock caused new car sales to drop by 1 000 in March compared with the same month last year, the National Association of Automobile Manufacturers of SA (Naamsa) said yesterday.

It said demand had exceeded supply. And it pointed out that sales in March last year were artificially boosted by a rush to buy ahead of a rise in VAT.

Brand Pretorius, MD of Toyota Marketing (SA), said that although sales were lagging behind those in 1993 it was too early to revise forecasts downwards. There would be growth if reason-

able political stability were achieved after the election.

New car sales last month totalled 17 591 compared with 15 818 in February and 18 666 in March last year.

Toyota remained the market leader with a total of 4 675 sales compared with 3 578 Volkswagens and 3 002 Samcor models — made up of 1 506 Fords and 1 496 Mazdas.

Light commercial vehicle sales

totalled 9 640 compared with 8 140 in February and 10 174 in March last year.

Naamsa director Nico Vermeulen said demand for new cars and commercial vehicles had remained strong during March. But shortages of certain models because of lost production time "remained a constraining factor facing most vehicle manufacturers."

Underlying strong demand for motor vehicles in most categories

was expected to continue. "However, this could be tempered by the climate of uncertainty and instability related to the socio-political transformation process currently taking place in SA."

"At the same time the multiplicity of public holidays and non-production days in the SA vehicle assembly industry in April will do little to address the stock shortage position."

Pretorius said in the light of the

March figures "we may have to accept that our forecast for the year of 205 000 passenger car sales may be on the optimistic side."

"Up until late last week we were still comfortable with this forecast but political events since then are likely to inhibit the market."

"We will, however, wait for political and social trends to settle down a bit before we decide

whether to revise this forecast downwards.

"Forecasts for the year have been made with the expectation of political stability following the election, with a return to normality quite quickly after a new government is installed."

"The expectation in the light of current developments in Kwa-Zulu is that matters may only begin to stabilise towards the end of the second quarter and this is likely to disrupt production capacity through until June at best."

"This is a pity really, because the post election period has the capacity to usher in a prosperous economic phase with increased employment opportunities."

Confusion over car sales

Star 13/4/94

■ BY STEPHEN CRANSTON

Manufacturers are drawing very different conclusions from the March car sales, which were 11,2 percent up on February, but still 5,7 percent down on March 1993

John Jessup, marketing director of Nissan SA Marketing, talks of the vitality experienced in March and draws comfort from the fact that sales for the first quarter were very much in line with those of the first quarter of 1993

He expects that in the post-election period all sectors of the vehicle market will continue improving, and that overall there will be a 7,5 percent sales growth for the year

But Toyota Marketing MD Brand Pretorius says the group's forecast of 205 000 car sales for the year — a six percent improvement — may be optimistic

"Up until late last week we were still comfortable with this forecast, but political events since then are likely to inhibit the market"

Toyota will bear the brunt of any downturn as its manufacturing facility is in Durban and draws much of its labour from KwaZulu

Pretorius says produc-

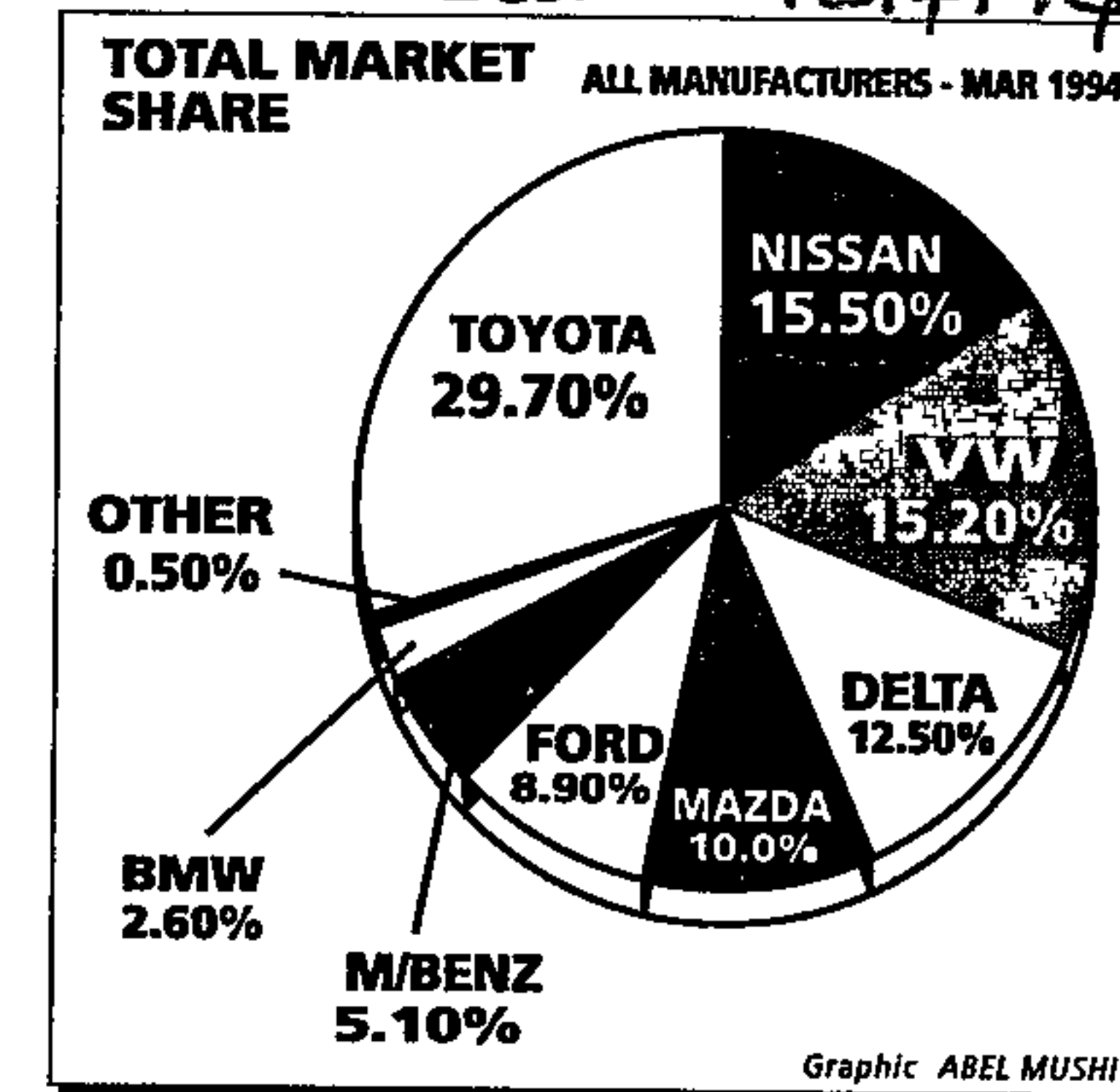

tion capacity could be disrupted until June at best

"This is a pity as the post-election period has the potential to usher in a prosperous economic phase with increased employment opportunities"

The overall stock shortage has enabled manufacturers to destock on less popular models, but generally sales exceeded production by an unacceptable margin

Much of this can be excused by the unrest in Bophuthatswana, a major source of components

Nissan, with its plant at Rosslyn, on the fringe of Bop, lost 1 500 units to

industrial action

Nissan's market share of 15,5 percent compares with an average of 17,7 percent over the past 12 months

Volkswagen's sales are high Marketing director Graham Hardy says that uncertainty and instability prior to the election are factors retarding sales, although he predicts a resumption in the upward trend afterwards

VW's market share in the first quarter was 20,6 percent, a dramatic improvement on the 15,4 percent in the same period last year

Arthur Mutlow, MD of Samcor Marketing, says that after severe product

shortages in January and February, Samcor was able to meet requirements in March (192)

What is not reflected in these figures, however, is that March was the most successful export month since the completion of the Sao Penza programme for the UK

Samcor stopped production in the Easter period and will shut for the week starting April 25.

But Mutlow says every effort has been made to ensure sufficient inventory levels for April

The backlog in demand for the Ford Bantam and Rustler ranges has not yet been overcome and demand continues to outstrip supply for the Mitsubishi Pajero

Sales of light commercial vehicles — essentially minibuses and bakkies — at 9 640 units were down 5,3 percent on March 1993, but there was an encouraging 18,34 percent improvement on February

Medium commercial vehicle sales improved by 27,8 to 326 units from February, but were still below the 345 sold in March 1993 There was a 47 percent improvement in heavy truck sales to 513 from February and this was above the 506 sold in March 1993

Fm 1514194

192

The plan sets out to force the industry to discontinue production of low-volume cars and light commercial vehicles and allow limited imports to replace models no longer made locally. It aims to achieve this through a steep reduction in tariffs on imported vehicles and heavy duty penalties on local production of low-volume ones.

By creating a small but stable, world-competitive SA motor industry, it hopes to bring an end to inefficient production and high-priced local vehicles.

Built-up vehicle imports are now subject to a 100% import tariff plus a 15% surcharge. The task group has already recommended the surcharge be scrapped forthwith and the tariff reduced to 80%, with a further drop to 70% in 1995. Thereafter it suggests the tariff should fall in stages to 45% by 2002.

Over the same period, it wants tariffs on imported components for vehicle manufacture to be reduced from 50% to 30%.

Duty penalties on below-volume local production would be imposed by the forfeiture of duty-free allowances from mid-1995. Some companies would be forced to drop local production of several vehicles almost instantly. Minimum-volume targets to escape penalties would be raised each year.

Eventually, the task group foresees a cost-effective minimum level of 20 000 vehicles a year off each model platform — defined as a single design base, for instance, Toyota's Corolla/Conquest, Volkswagen's Golf/Jetta and Samcor's Mazda 323/Ford Laser/Meteor/Rustler.

Critics say, however, the proposal is so harsh it will probably put several vehicle and components companies out of business. Whether a new ANC government, with its strong Cosatu labour support, would accept a policy that threatens tens of thousands of jobs must be open to doubt.

According to Herbertson, the main problem is that the recommendations are so complicated it is impossible to gauge exactly what will happen. Proposals on duty-free allowances and import-export complementarity are "incredibly complex." They might prove both impossible to administer and to make sensible predictions on their impact.

For instance, he sees no need for flexible annual import-duty reductions on imported vehicles and components between 1995 and 2002. He favours a constant, straight-line rate of reduction.

Likewise, he rejects the need for a Motor Industry Authority to oversee the industry's development. "Should the programme itself be significantly simplified, the need for an authority and its cost will fall away."

Herbertson suggests the task group has not considered sufficiently the likely social consequences of its recommendations. He also disagrees with many of its conclusions on what is responsible for the motor industry's current weakness. Too many of those conclusions are based on hearsay rather than considered research.

He rejects the report's assertion that the

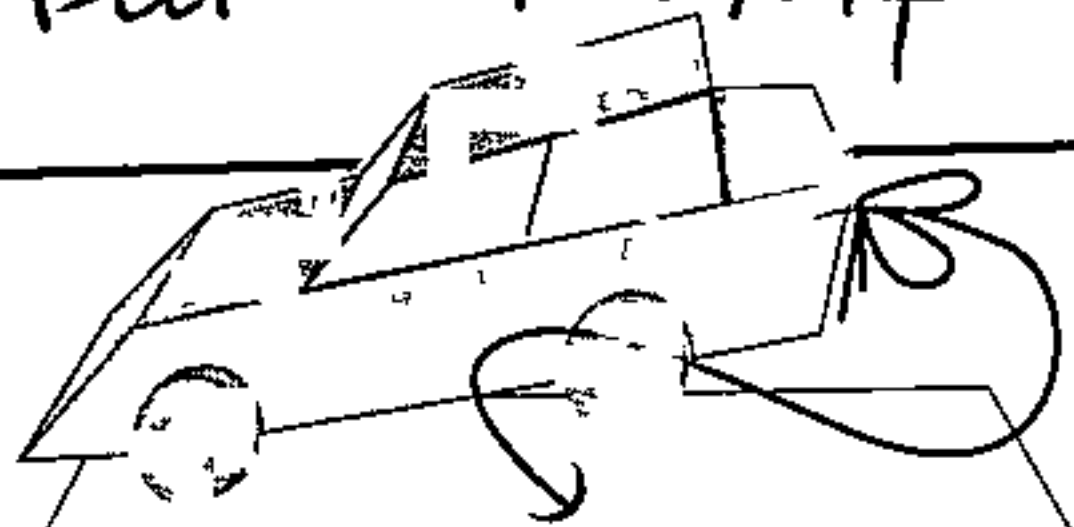

March vehicle sales

Cars	Total	%*
Corolla 3 396, Camry 1 244, other 35	4 675	26,6
Golf/Jetta (new) 1 690, Golf/Jetta (old) 127, City/Fox 1 600, Audi 161	3 578	20,3
Ford Laser/Meteor 820, Telstar 686, Mazda 323 823, Mazda 626 614, Mitsubishi Pajero 59	2 378	17,1
Sentra 1 355, Maxima 116, 200SX/300ZX 6, Fiat Uno 920	2 471	13,6
Astra/Kadett 1 873, Rekord 65, Monza/Kadett 62, Calibra 9	2 009	11,4
Honda Ballade 909, M-Benz W124 224, W140 63, other 9	1 195	6,9
3-Series 609, 5-Series 92, 7 Series 22	723	4,1
Legacy 2	2	0,01

	1994	1993	% Change
March	17 591	18 666	-5,8
Jan - March	47 629	48 269	-1,3
February (15 818) - March			+11,2

Light commercial

Toyota 3 459 (35,9% of the market), Samcor 2 220 (23,0), Nissan 1 883 (19,5), Delta 1 339 (13,9), VW 679 (7,0), AAD 60 (0,6)

	1994	1993	% Change
March	9 640	10 174	-5,2
Jan - March	24 322	24 853	-2,1
February (8 140) - March			+18,4

Medium commercial

Toyota 106 (32,5%), Delta 101 (31,0), Samcor 72 (22,1), Nissan 29 (8,9), M Benz 16 (4,9), AAD 2 (0,6)

	1994	1993	% Change
March	326	345	-5,5
Jan - March	788	821	-4,0
February (255) - March			+27,8

Heavy commercial

M-Benz 208 (40,5%), Toyota 105 (20,5), Delta 64 (12,5), MAN 55 (10,7), Nissan 51 (9,9), ERF 14 (2,7), Tyco 14 (2,7), Iveco 2 (0,4)

	1994	1993	% Change
March	513	506	+1,4
Jan - March	1 124	1 233	-8,8
February (349) - March			+47,0

Trucks

Toyota 8 345 (29,7%), Samcor 5 294 (18,9), Nissan 4 360 (15,5), VW 4 257 (15,2), Delta 3 513 (12,5), M-Benz 1 429 (5,1), BMW 723 (2,6), other 149 (0,5)

	1994	1993	% Change
March	28 070	29 691	-5,5
Jan - March	73 863	75 176	-1,7
February (24 562) - March			+14,3

Source: NATIONAL ASSOCIATION OF AUTOMOBILE MANUFACTURERS OF SA

motor industry is a burden to the rest of the community. Rather, he believes that it helps to create hundreds of thousands of jobs, while direct and indirect taxation on the industry and motorists earned the Fiscus R14,65bn in the 1992/1993 financial year — 19% of total R76bn revenue.

□ Vehicle sales in March were buoyant despite a decline against the corresponding 1993 month, say industry marketers. March

1993 sales were inflated by pre-emptive buying ahead of an April increase in Vat.

Stock shortages of certain models continue to dent some companies' performances. Nissan's John Jessup says the fact that the overall market so far in 1994 is in line with 1993, bodes well for the rest of the year once pre-election uncertainty is over.

Fm 1514194
MOTOR INDUSTRY

Not happy with the plan

The proposed development plan for the motor industry is a "seriously flawed piece of work," says Samcor MD Robert Herbertson. Not only will its recommendations create an overregulated industry but it also displays a lack of understanding on many important issues, he adds.

Sharp criticism

Herbertson's company manufactures Ford, Mazda and Mitsubishi vehicles. The plan is set out in a report presented to Trade & Industry Minister Derek Keys last month by the government-appointed Motor Industry Task Group (*Business* April 1). In one of the sharpest individual criticisms yet of the report, Herbertson describes the industry structure envisaged by the report as Byzantine.

192

Car makers may face closure

CF 15/4/94

192

From MICK COLLINS

JOHANNESBURG — At least four of SA's seven major car manufacturers could be forced to shut down if the proposed motor industry task group recommendations were implemented, industry sources warned yesterday

The four, including one luxury car maker, would "find the going difficult" under the new dispensation, which could lead to huge job losses in areas where unemployment was already high

The scheme, proposed by the government-appointed motor industry task group, centres on the industry ceasing production of low-volume vehicles and allowing limited imports to replace models no longer manufactured in SA. This would be accomplished with harsh duty penalties on local production of low-volume

models and a reduction in tariffs on imported cars

But sources said the plan would "never see the light of day" as an ANC government — with its strong labour backing — would firmly reject the proposal

National Association of Automobile Manufacturers in SA director Nico Vermeulen said the association supported a mechanism to encourage a reduction in the number of models produced locally. But it could not support a rationalisation mechanism "that would threaten the continued existence of the major established vehicle manufacturers"

Volkswagen SA MD Peter Searle said some mergers and rationalisations over the next 10 years were possible. "But the seven motor manufacturers in SA are all strong offshoots of motor companies from around the globe. So mergers are not going to happen quickly or easily"

He said the task group report

failed to recognise the time period needed to get the industry viable. "So bringing in imports is not going to solve the problem — it is going to lead to model proliferation." It could also lead to a reduction of the market and "we might end up with some casualties and less manufacturers"

Nissan SA marketing director John Jessup said manufacturers who made smaller and more affordable cars "should be safe". Also, manufacturers prepared to reinvest in their production programmes with "a strong export base" should survive. Major dealer networks would probably merge "sooner rather than later"

Toyota SA marketing MD Brand Pretorius said it was premature to speculate before the final structure of the development programme was clarified

Samcor finance executive director Gideon Wolthers said mergers were not likely as there were no apparent synergies

Proposals threaten major car makers

BINAY 15/4/94

AT LEAST four of SA's seven major car manufacturers could be forced to shut down if the proposed motor industry task group recommendations were implemented, industry sources warned yesterday.

The four, including one luxury car maker, would "find the going difficult" under the new dispensation, which could lead to huge job losses in areas where unemployment was already high (192)

The scheme, proposed by the government-appointed motor industry task group, centres on the industry ceasing production of low-volume vehicles and allowing limited imports to replace models no longer manufactured in SA. This would be accomplished with harsh duty penalties on local production of low-volume models and a reduction in tariffs on imported cars.

But sources said the plan would "never see the light of day" as an ANC government — with its strong labour backing — would firmly reject the proposal.

National Association of Automobile Manufacturers in SA director Nico Vermeulen said the association supported a mechanism to encourage a reduction in the number of models produced locally. But it could not support a rationalisation mechanism "that would threaten the continued existence of the major established vehicle manufacturers".

MICK COLLINS

Volkswagen SA MD Peter Searle said some mergers and rationalisations over the next 10 years were possible. "But the seven motor manufacturers in SA are all strong offshoots of motor companies from around the globe. So mergers are not going to happen quickly or easily."

He said the task group report failed to recognise the time period needed to get the industry viable. "So bringing in imports is not going to solve the problem — it is going to lead to model proliferation." It could also lead to a reduction of the market and "we might end up with some casualties and less manufacturers".

Nissan SA marketing director John Jesup said manufacturers who made smaller and more affordable cars "should be safe". Also, manufacturers prepared to reinvest in their production programmes with "a strong export base" should survive. Major dealer networks would probably merge "sooner rather than later".

Toyota SA marketing MD Brand Pretorius said it was premature to speculate before the final structure of the development programme was clarified.

Samcor finance executive director Gideon Wolthers said mergers were not likely as there were no apparent synergies.

Worker unrest may hit car sales

5 Times
(Buss)
1714/99
PREDICTIONS of a 6% increase in car sales this year could be stymied by stock shortages if political instability extends well beyond the elections, writes **DON ROBERTSON**

Manufacturers forecast sales of at least 205 000 cars compared with 193 666 in 1993. But labour disruptions in the run-up to the elections, the number of lost production days this month and the likelihood that more time will be wasted will leave assemblers short of vehicles

March sales at 17 591 were 11,2% better than the 15 818 in February, but 5,7% lower than the 18 666 sold in the same month last year. March 1993 sales were boosted by buying ahead of increased VAT *(192)*

Car sales for the first quarter fell by 1,3% to 47 629 from 48 269 in the first three months of 1993

Last month's improvement did not reflect the true state of the market. It is believed that buying by the Independent Electoral Commission, car-rental companies and the government accounted for at least 3 000 vehicles. This suggests that fleet owners and the public were largely out of the market in what is usually its best month

Toyota Marketing managing director Brand Pretorius says "There is a strong likelihood that political instability will continue into May, June and July"

The possibility of labour instability continuing into the second half of the year is also feared. Wage talks are due in July and August. Industry sources say trade unions are likely to be aggressive in their first negotiations under a new government. They will probably want to show they have great power

The National Association of Automobile Manufacturers of SA (Naamsa) is, however, optimistic that modest improvements in vehicles sales will be recorded for the year

Nissan thinks the overall market will increase by about 7,5% this year

Toyota in Natal and Nissan and BMW in Bophuthatswana suffered more severely from labour disruption than Mercedes-Benz, Delta and Volkswagen in the Eastern Cape and Samcor in Pretoria in March

Toyota maintained its top spot in the first quarter. Volkswagen narrowed the gap between it and Toyota with a big increase in market share

Samcor lifted its market share by 73% in March. Nissan and BMW had a particularly bad March

Top-selling models in March were Corolla, Astra and Golf-Jetta

Light commercial sales rose to 9 640 from 8 140 in February, but were lower than the 10 174 in March 1993

Cautious support for car industry plan

TOYOTA yesterday gave guarded support for the motor industry task group's proposals for Phase VII of the local content programme. *Bidoy 2/14/94*

The company said Phase VII would have to reduce the number of models in SA to have any meaningful effect, and "it will not be totally comfortable for all players"

The scheme centres on the industry ceasing production of low-volume vehicles and allowing imports to replace them. *(192)*

Executive chairman Bert Wessels said the programme would clear the way for cheaper cars. With its top-selling Corolla and Hilux models, Toyota was well placed

MUNGO SOGGOT

to cope with the new system, although it would not be immune to its effects

Costs would drop, as the programme would reduce duties on CKD (completely-knocked down) and result in narrower product ranges. SA car prices would fall when local manufacturers were faced with competition from imported vehicles

However, duty-free allowances on imported cars should not be "excessively threatening" to local manufacturers, and rationalisation should not lead to excessive job losses, Wessels said

2114194
Toyota chief foresees lower prices

BUSINESS STAFF

The Motor Industry Task Group's (MITG) proposals for Phase 7 of the local content programme has the potential to reduce the cost of vehicles — in real terms — by 10 to 15 percent over the next eight years

That's the positive message from Toyota SA executive chairman Bert Wessels.

"Toyota SA is conceptually supportive of the MITG proposals. We are deeply concerned about the deterioration in the industry as a whole

"This has largely come about because of price escalations that have created an affordability crisis and led to a decreased market.

"It is Toyota's view that the MITG proposals will go a long way to facilitating more affordable vehicles in the future"

Wessels says this does not



Bert Wessels ... an affordability crisis.

mean we will see an immediate drop in vehicle prices with the introduction of the programme.

Reduced CKD duties, the anticipated rationalisation of product ranges and greater economies of scale should help

drive costs down
"The biggest inducement to increase efficiency and reduce prices will come from increased competition from imported, fully built up vehicles which will benefit from a reduction in duties through the programme"

Wessels urges that the rationalisation process must not lead to excessive job losses

"Conversely, we have a concern that unless we effectively address the affordability of vehicles through a programme with teeth then the industry will be under threat of total collapse

"For this reason we are fully supportive of the volume provisions of the programme, as this will lead to high volume cost efficiency and provide job security. This situation will be encouraged through high duty-free allowances on volume models"

He says vehicle exports will

have an important role to play under the MITG proposals

"Toyota Motor Corp Japan (TMC) is fully supportive of this element and our efforts in this area.

"Last year we exported over 2 000 units to Africa and this should go up to 2 500 for 1994, but we are setting our sights a lot higher for the future as markets outside Africa open up to us through TMC"

Toyota's objective is to improve its own efficiency after the disruptions of the pre-election period.

"We consider an average annual productivity improvement of 2,5 to 3 percent over the eight-year period of the programme (a total of 25 percent) as a realistic minimum objective

"Irrespective of the final detail of the MITG programme, Toyota SA is confident that the outcome will be a stronger local industry"

192

Commercial Crime Unit
it was critical to make provi-
sion to ...
organisation (Safra)

FM 22/4/94

Activities: Assembles and distributes Toyota and Hino motor vehicles

Control: Wesco 50%

Executive Chairman: A J J Wessels

Capital structure: 4,1m ords Market capitalisation R104m

Share market: Price 2 535c Yields 1,7% on dividend, 9,5% on earnings, p e ratio, 10,5, cover, 5,7 12-month high, 3 100c, low, 1 550c Trading volume last quarter, 353 000 shares

Year to Dec 31	'90	'91	'92	'93
ST debt (Rm)	29,5	34,4	65,3	41,9
LT debt (Rm)	49,7	204,8	398,2	340,2
Debt equity ratio	0,09	0,26	0,44	0,29
Shareholders interest	0,61	0,56	0,53	0,59
Int & leasing cover	390,4	—	19,2	5,4
Return on cap (%)	18,7	14,1	7,1	9,4
Turnover (Rm)	3 118	3 467	3 453	4 638
Pre-int profit (Rm)	251,1	233,3	138,5	200,0
Pre-int margin (%)	7,9	6,7	4,0	4,3
Earnings (c)	276,4	297,3	151,6	240,6
Dividends (c)	47,5	47,5	28,5	42,0
Tangible NAV (c)	2 013	2 258	2 551	3 076

there was an accompanying reduction in rebates against excise account of about 30% over 1992 Toyota Motor Corp (TMC), too, suffered lower profit due to economic developments in Japan and the strengthening of the yen, particularly against the US dollar That limited TMC's ability to help Toyota SA to soften effects of the much stronger yen against the rand

Chairman Bert Wessels says Toyota SA's 34% rise in turnover last year stemmed equally from price rises and volume increases Though attributable income rose a creditable 59% to R97m, 1991's R121m was far out of reach The increase could have been smaller, the effective tax rate fell from 55,5% to 42,4%

Toyota

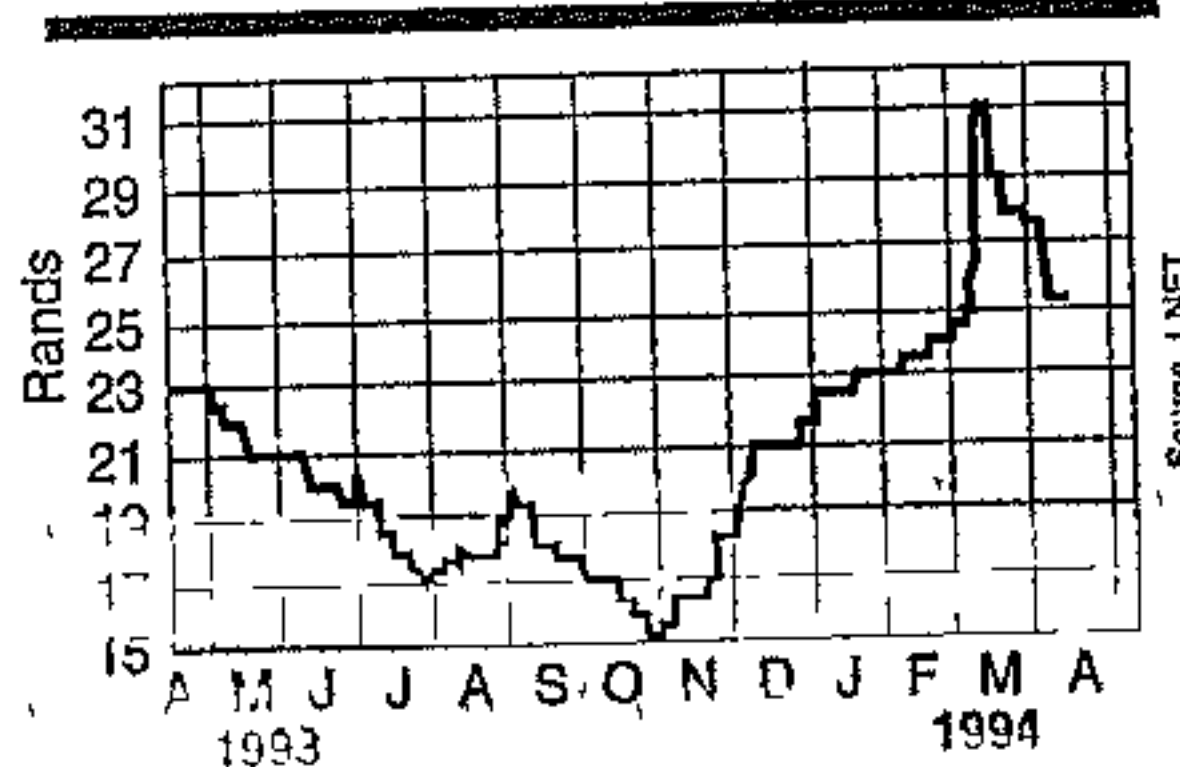

TOYOTA FM 22/4/94 Currency hurdle

At the beginning of 1993 Toyota looked set to recover fully from the previous year's 49-day strike and 50% drop in earnings That is, until the rand weakened substantially against the yen, because of competitive pressures the higher cost could only be partly offset by price increases (192)

The yen fell from an average Y45/R in 1992 to Y35/R in 1993 This pushed up the average cost of imported components and

A new product proved promising The Venture, an affordable multipurpose vehicle, exceeded expectations and demand could only partly be met When the Venture was launched, planned production was 400-500 units a month To meet demand, facilities and capacity are being extended to increase production to about 1 000 a month Toyota achieved a share of 29,4% of the total car market last year — an increase in retail sales of 14%

The balance sheet strengthened during the year, interest-bearing debt to shareholders' interest fell from 44% to 29% Also, current assets have increased only 11,7% over 1992 Stock rose 35,3%, largely due to changes in the exchange rate and a work stoppage at the

FM 22/4/94



Toyota's Wessels
higher prices and unit sales

plant during the last week of production in 1993 This increase was cushioned by effective credit control

Parent company Wesco, which also holds a 36% stake in engineering group Metair, increased EPS four-fifths to 472c off a low base and turnover climbed 35% Improvement came from both Metair and Toyota New projects and changes in Metair's structure saw profit up from R8,8m to R31,6m

Toyota's price climbed steadily from the end of October last year until early March Once preliminary results, which fell short of expectations, became known, the counter lost over R5 in four weeks The exposure to the yen might be deterring investors from what could be a good long-term investment

COMPANIES

FM 22/4/94

Activities: Manufactures and markets industrial engineering automotive and consumer products

Control: BTR plc (52,1%) ~~192~~ 192

Chairman: A M D Gnodde, MD C R Hooper

Capital structure: 23,8m ords Market capitalisation R666m

Share market: Price 2 800c Yields 6,3% on dividend, 11,4% on earnings, p e ratio, 8,8, cover, 1,8 12-month high, 1 550c, low, 3 100c Trading volume last quarter, 402 000 shares

Year to Dec 31	'90	'91	'92	'93
ST debt (Rm)	3,5	4,1	7,2	8,2
LT debt (Rm)	0,4	0,1	28,0	19,7
Debt equity ratio	n/a	0,02	0,02	n/a
Shareholders' interest	0,5	0,56	0,54	0,59
Int & leasing cover	15,2	8,8	15,0	24,2
Return on cap (%)	28,9	21,9	17,5	17,6
Turnover (Rm)	701	672	668	690
Pre-int profit (Rm)	134,3	89,7	91,3	94,3
Pre-int margin (%)	19,2	15,1	13,7	13,7
Earnings (c)	287	239	244	319
Dividends (c)	165	165	165	175
Tangible NAV (c)	1 027	1 095	1 182	1 326

December 1993

Admittedly, the deferred tax rate adjustment of R11,4m and the 36% decline in finance charges to R3,9m had much to do with the apparent reversal of two years' of earnings decline. But MD Mike Smithyman says the group has maintained market share in a number of key areas including tyres.

The motor division, made up predominantly of tyres, accounts for just less than 40% of sales. Despite marginal volume growth of 1%-2% last year and continued pressure on prices from imports — now absorbing 20% of the local market — Dunlop achieved a small increase in market share in the replacement market. The main impetus for industry growth comes from the replacement market, new cars account for less than 20% of the total car tyre sales.

Like others in the industry, management continues to lament low-cost imports of new and second-hand products. Obligated to use expensive locally sourced raw materials in the manufacturing process, the uncompetitive SA tyre industry has been hard hit by imports (much of which escape the 25% duty) flowing through neighbouring countries.

BTR Dunlop

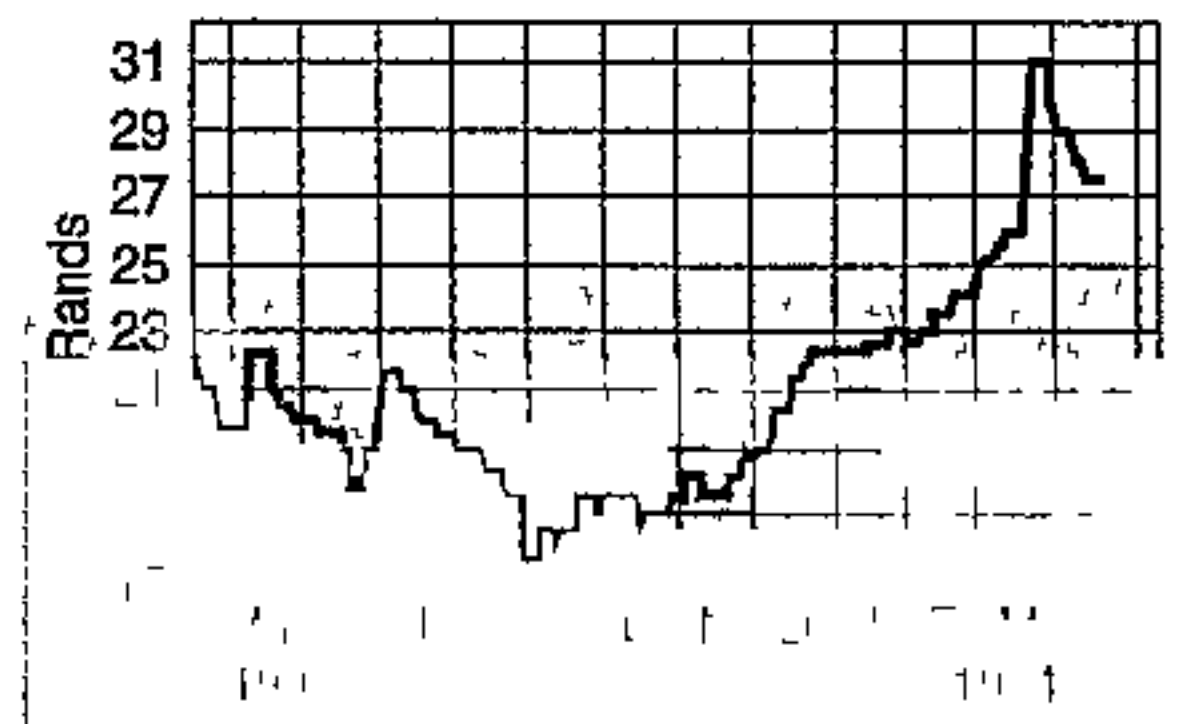

Almost 55% (R341m) of sales revenue is from the engineering and industrial divisions. Deferment of major projects in the mining and construction industries resulted in marginal growth in sales. The increasing availability of imported products is a further negative factor, says Smithyman, who expects some relief from the introduction of new products.

Cash flow has strengthened after the slower volume growth and constrained profits of the previous years, R52m operating inflow compares favourably with 1992's R35,2m. At year-end there was net cash of R15m (1992 net borrowings of R4m). Management is budgeting for R29m capex this year — similar to that spent in 1993.

INCOME SOURCES

	Sales		Trading profit	
	1992 Rm	1993 Rm	1992 Rm	1993 Rm
Engineering/Industrial	341	372	48	49
Motor Industry	260	262	35	36
Consumer Products	67	55	8	9
	668	689	91	94

With sales keeping up with budget, Smithyman believes a small improvement on 1993's EPS of 272c (excluding the deferred tax adjustment) is possible.

Earnings will be sensitive to economic recovery and a 12% increase is possible. This puts the share on an inexpensive forward p e of 9,4. Though the counter has recently softened from R31 in March to R28, the potential for earnings growth should support the price.

Marylou Greig

BTR DUNLOP

FM 22/4/94
Import pressures

Serving the automotive, mining, engineering and consumer goods markets, BTR Dunlop has done well to lift EPS 31% for the year to

Cheaper motor-cycles on the cards

5 Times (Buss)

THE price of motor-cycles could eventually be reduced by between 18% and 39% if import, ad valorem and surcharge duties are dropped — as recommended by the Motor Industry Task Group (MITG)

The decision rests with the Board on Tariffs and Trade. It has received an application for relief from the Association of Motorcycle Importers and Distributors (Amid)

Motor-cycle import duties range from 10% to 15%, the surcharge is 15% and ad valorem charges are as much as 32,5%.

The MITG report says motor-cycles are used mostly by business and du-

By DON ROBERTSON

ties result in additional input costs. There is no SA motor-cycle industry to protect. The state would forfeit R30-million in income if duties were dropped. 244194

An early decision on the application is not expected.

Motor-cycle dealers have suffered a sharp drop in sales, largely because of rising prices, exacerbated by the rand's fall against the yen.

Dealers say most sales — 83% in 1993 — are to the commercial sector.

Motor-cycle sales in 1983 totalled

47 780, falling to 24 500 in 1985, 12 920 in 1988, 9 980 in 1990 and 8 170 last year. Of last year's sales, 82,8% were motor-cycles below 200cc. They are used mainly for the delivery of small parcels. (192)

The removal of ad valorem duties alone would result in an immediate reduction in retail prices. ~~R44~~

Amid says importers and distributors have cut profit margins in an effort to contain retail prices.

The retail price of 50cc motor-cycles ranges from R8 700 to R11 000. A 500cc motor-cycle costs about R30 000 and a 750cc machine about R37 000.

Row erupts as workers demand trust money

By DAWN BARKHUIZEN

A ROW has erupted over a multi-million community trust fund established by the Ford Motor Company when it pulled out of South Africa eight years ago

A group representing more than 2 000 workers, who were retrenched when the motoring giant disinvested, are demanding an investigation and audit of the Algoa Bay Charitable Trust chaired by Port Elizabeth churchman, the Rev Mcebisi Xundu

The former workers claim they have been trying in vain to get benefits from the fund since 1987.

With new trustees in control, they fear the fund will be liquidated after a change in government

However, the trustees said misconceptions about the objectives of the trust had led to the controversy

They said beneficiaries had to be charitable, educational or ecclesiastical institutions of a public character

Unemployed workers did not fall into any of these categories

But the former workers,

most of whom still cannot find jobs, say attempts to investigate the fund have been blocked and repeated applications for assistance have been turned down.

They are demanding access to the accounts and have threatened to take legal action to obtain minutes of trust meetings

Ford's initial donation of R8,9-million now stands at R11,9-million and it is administered solely by South African trustees

Attempts to get comment from the Ford headquarters in Canada this week were fruitless

Until last year the fund was held in trust by two attorneys and Idasa director Alex Boraine. Its earnings were distributed by the Port Elizabeth Community Chest

New trustees, including Mr Xundu and advocate Fikile Bam, have been appointed and they intend making the allocations themselves

Mr Edries Sirkhotte, a spokesman for the former workers, said the severance packages they

received when Ford pulled out were "appalling"

He said every time a meeting was held with trustees, the workers were given new conditions which they had to meet — but they were still refused any money (192)

Last Sunday the former workers marched on Mr Xundu's church to protest

In a statement Mr Xundu said the trust kept proper records, had its books audited each year by an established firm of accountants and was accountable to the Master of the Supreme Court

"The misconception about the objectives of the trust has unfortunately led to unrealistic expectations and public controversy," said Mr Xundu

A spokesman for the trust said on Friday a cheque for R2-million was on its way from the Johannesburg investors for distribution this year

The money would be banked until the trustees had assessed applicants and made allocations in July this year, the spokesman said

SI Times 24/4/94

COMPANIES

Dead-end ahead for minibuses taxis

S. Times (Buss)

By DON ROBERTSON

THE proposed development programme for the motor industry, Phase VII as it will be called, could herald the end of minibus taxis.

The Motor Industry Task Group (MITG) has made several recommendations for rationalising the motor industry. One is to force manufacturers to drop the production of low-volume models.

Unless a minimum of 4 000 units of a particular model are made each year, manufacturers would forfeit duty-free allowances. The programme is intended to come into effect in July next year. Required volumes would increase each year until 2003 when the minimum would be 11 000 units.

Neither Nissan nor Toyota, the main suppliers of minibuses to the taxi business, would meet the minimum levels this year, nor do they intend to increase production next year.

It is estimated that South Africa has at least 150 000

minibus taxis.

Seven or eight years ago, the taxi business was growing and minibus manufacturers competed vigorously for customers.

But demand for minibuses has dwindled in the face of rising unemployment, higher vehicle costs and deposits in instalment deals. Insurance premiums have also jumped.

In 1991, Nissan made 3 600 E20 minibuses, most of which were 16-seaters for the taxi business.

Production of the E20 will stop later this year because completely knocked down (CKD) kits will no longer be available from Japan. This year's production will total about 1 000.

In the boom year of 1988, Toyota made 9 500 Hi-Ace models, more than half of which were 16-seaters. This year's planned production is about 2 800 ~~2 444~~ 2 444.

Delta, Samcor and Volkswagen were also in the taxi business. Delta stopped pro-

ducing the minibus last month. Samcor introduced a range of the Mazda Madison and the Ford Spectrum in 1992 for taxis and sold 1 100 units that year. Last year it sold 791 ~~(192)~~ (192).

Volkswagen, which holds most of the leisure market for minibuses, produced 7 360 Kombis in 1990, of which 900 were 15-seaters. It stopped production of 15-seaters in 1992. It plans to build 5 000 this year and would be the only manufacturer to qualify in terms of the new regulations.

If SA production of minibuses ceases, the vehicles would have to be imported.

The MITG suggests that manufacturers running out of a model be allowed to import the equivalent vehicle at a 50% duty. This compares with current duties of 115%. Imports would be restricted to 75% of previous sales volumes.

This concession would have little effect and would increase the cost of vehicles currently priced between R75 000 and R95 000.

Both John Jessup, mar-

keting director of Nissan Marketing, and Brand Pretorius, managing director of Toyota Marketing, say there is no certainty about minibus supplies next year.

Motor manufacturers and others involved in the industry have until May 15 to comment on the MITG proposals. One issue will be minimum volumes.

It is possible that the new government will offer a dispensation for the taxi business for socio-political reasons. It is also possible that one manufacturer could become the sole supplier of minibus taxis to meet the minimum volume requirements.

Reggie Mutsi, secretary for the SA Black Taxi Association (Sabta), says taxis carry 2,1-million people a day compared with 750 000 by bus. They travel 440-billion kilometres a year, use 3,5-million litres of oil, 800-million litres of petrol, spend R800-million on spares and provide jobs for thousands.

He believes the taxi business deserves special consideration.

Metair prospects 'hinge on restructuring laws'

B/Day 25/4/94

MUNGO SOGGOT

MOTOR component manufacturer Metair Investment's prospects for 1994 will hinge on the impact of Phase Seven — which will cut production of low-volume vehicles and allow imports to replace them — and the fate of the rand, says chairman Elizabeth Bradley

Bradley said in the annual report all Metair's companies — including Armstrong Hydraulics, Smiths, Supreme Spring Systems, Hella, and Motorrubber — imported components which made them vulnerable to a weak rand

The implementation of Phase Seven of the local content programme would force Metair to restructure Greater international competition would stretch the company's ability to adapt and innovate

But MD Alan Plummer said Metair was prepared for the inevitable major rationalisation of the motor industry. With moderate economic growth the company expected to increase earnings this year, provided political disruption was minimal

Metair — whose major shareholder is Toyota holding company Wesco — boasted a 260% jump in earnings to 517c a share on a 55% rise in turnover to R565m for the year to December

Bradley said Metair's efficiency drive during four years of negative growth meant turnover had risen while costs had been contained

She said the rise in earnings followed a bad year — in which the company had been hit by strikes — so it did not reflect "normal operational improvement". Compared with the past five years the results showed

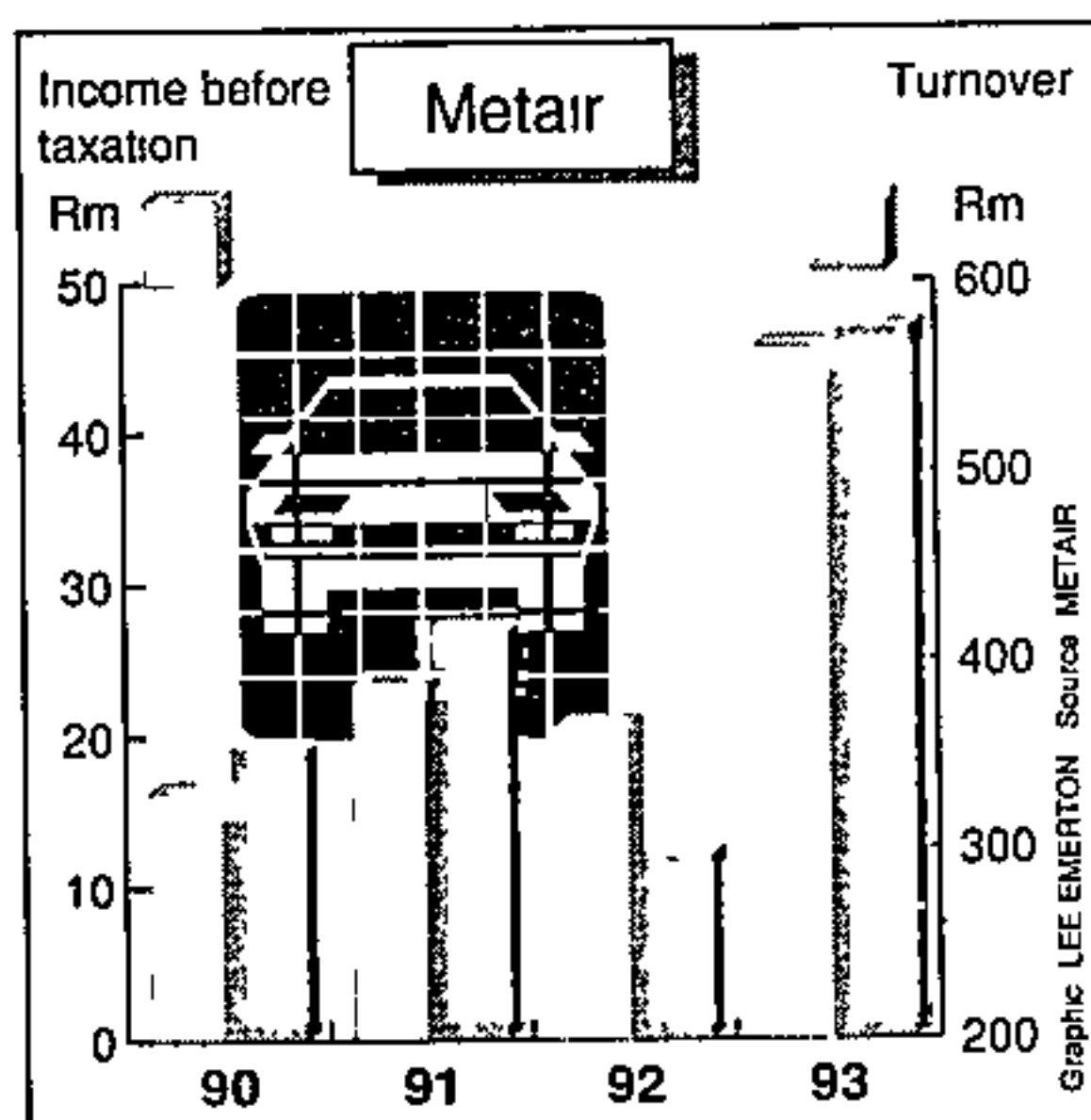

a "satisfactory real rate of growth"

During 1993 labour relations had been less volatile, although there had been some "major confrontations over trivial issues"

Metair had increased its 40% stake in Hella SA to 100%, buying out the shares of German holding company Hella KG

Plummer said the company had benefited from a 5% increase in new vehicle sales, the first hike in several years

He said most of Metair's subsidiaries increased their market share "The group was perhaps fortunate that it benefited from additional localisation business placed by major original equipment customers before the full impact of Phase Seven was apparent"

Bradley said although this week's elections would return SA to "international respectability" there was potential for an unstable and unpredictable environment

CMH maintains its positive trend

Business Day 25/4/94

MOTOR retailer Combined Motor Holdings (CMH) lifted attributable earnings 40% to R6,2m — its third consecutive annual rise — for the year to February, on sales which increased 26% to R698m (R555m)

The Durban-based group — which holds franchises for Ford, Nissan, MMI, Mercedes Benz, Honda, Toyota, and Delta — announced a final dividend of 10c, bringing the full year dividend up 29% to 12c (9,3c)

Director Stuart Jackson said "Group earnings during the year mirrored very closely the changing political outlook of the country. Unfortunately increased violence, work stoppages and the uncertain political outlook during most of 1994 has placed a damper on consumer spending and curtailed earnings growth"

Operating income rose 41% to R14,9m from R10,6m in 1993. Interest payments increased to R5,5m (R4m), and tax climbed 44% to R3,3m from R2,3m. Earnings climbed to 32,5c (23,2c) a share.

Jackson said the group's trend of increased earnings hinged on the

MUNGO SOGGOT

political parties' acceptance of the election results, and their commitment to working together to rebuild a stable economy (192)

Swedish newcomer Volvo — the first Swedish company to leave SA in the 1970s — recently teamed up with CMH, which will distribute the Volvo 850 and Volvo 960 in SA.

CMH dealerships trading under the name Swedo Car have been set up in Durban, Johannesburg, Pretoria and Cape Town. Volvo Cars International MD Jan Jurland said the company aimed to sell between 500 and 600 cars in SA this year.

CMH chairman Maldwyn Zimmerman said "While the cars are manufactured and assembled entirely by Volvo Europe, full parts and service will be provided locally"

CMH has undergone a major change in its JSE fortunes over the past year. The share closed at its year high of 155c on Friday — up 29% since the start of the year — against a year low of 65c a year ago. The share is thinly traded, however CMH directors hold the bulk of its equity.

Midas back in the black

B. Nooy 25/4/94
PETER GALLI

MOTOR supply group Midas moved back into the black in the year to February, posting an attributable profit after extraordinary items of R6,71m from a R20,34m loss in the same period the year before.

A final dividend of 11c a share was declared on the back of earnings of 64,3c a share, bringing the year's total dividend payment to 16c a share. No dividend was paid the previous year.

CE Sarel de Vos said the return to profitability was due to the elimination of non-core business, the containment of expenses and tight management control.

Turnover rose 5,4% to R251,69m (R238,76m), and operating profit rose 30% to R11,7m (R8,96m), while interest paid was nearly halved to R2,87m (R5,04m), leaving pre-tax profit of R8,83m (R113 000).

A lower tax bill of R988 000 (R1,22m) left a taxed profit of R7,84m (R1,1m loss). Attributable earnings of associated companies rose to R947 000 (R690 000), resulting in net income of R8,79m (R413 000 loss). An unexplained extraordinary item of R2,85m (R17,84m) reduced the attributable profit to R6,71m (R20,34m loss) (192)

McCarthy Retail now holds 79,8% of Midas's issued share capital.

Shortages and depressed demand knock car sales

Bl Day 20/4/94

MUNGO SOGGOT

THE motor industry had struggled to keep production at 1993 levels in the first quarter, while sales had dropped despite the anticipated upturn in demand to cater for election watchers, manufacturers' figures show.

Car sales in March had totalled 17 591 units versus 18 666 the year before, the National Association of Automobile Manufacturers of SA (Naamsa) said

Naamsa director Nico Vermeulen said predictions of a surge in sales to cater for foreigners observing the elections had been far too ambitious "Naamsa has repeatedly stated that because observers are in SA for a limited time, they are not buying cars."

But car rental companies had bought more cars in anticipation of higher demand

Avis MD Grenville Wilson said the company had increased its fleet 20%, buying 1 200 cars to cater for election watchers

A BMW spokesman said monthly

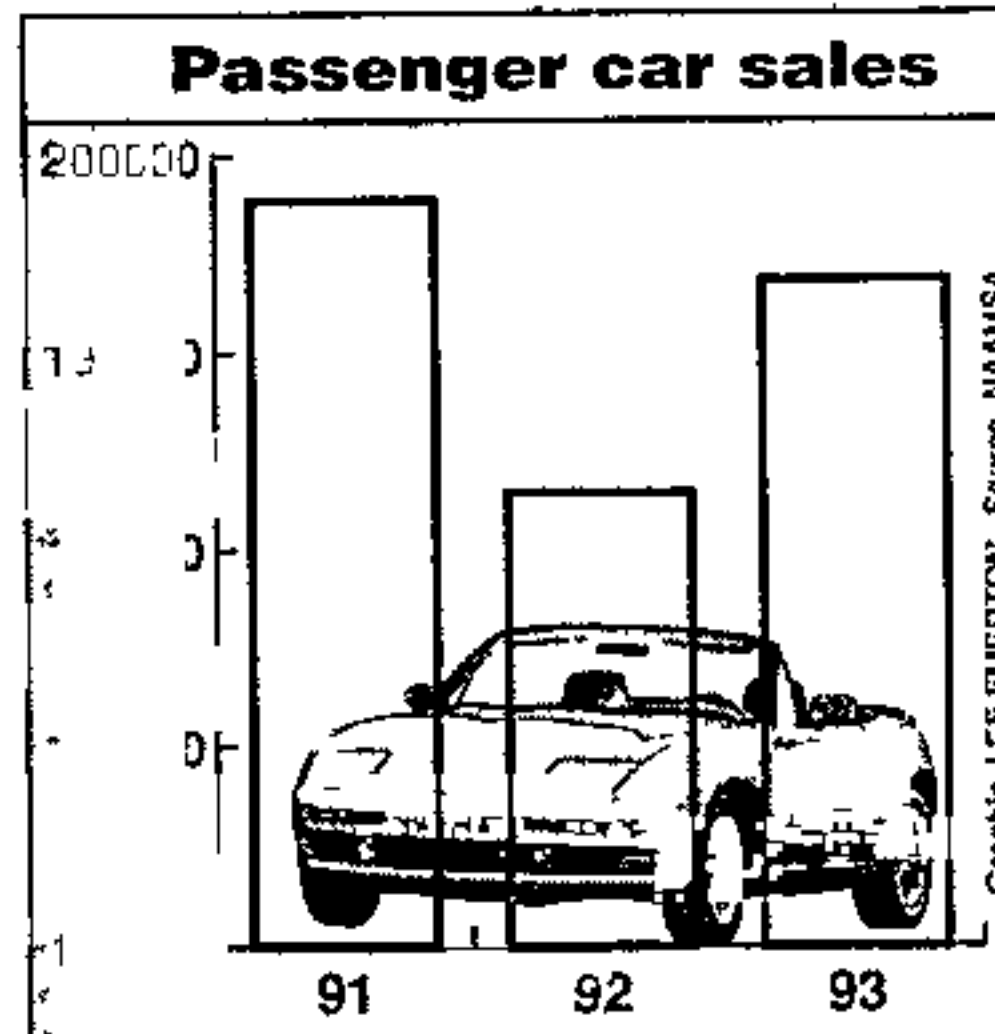

sales over the past three years had depended on the number of cars the company could build "We have waiting lists for all our cars"

Events in Bophuthatswana had affected production About 1 200 cars could not be completed because of problems faced by suppliers in the region

BMW had built only 780 cars in March, compared with a monthly average of 1 360 But employees had been working overtime to reduce the

backlog

He said it was unlikely that Swedish manufacturer Volvo's return to SA would dent BMW's market share

Buyers were holding back until after the elections, but this would not affect BMW because it already had a long waiting list

Toyota marketing MD Brand Pretorius said the company had scaled down its 1994 sales forecast of 205 000 passenger vehicles But, given reasonable stability, there would be growth in the sector

Toyota had also been affected by recent events in Bophuthatswana

A Samcor spokesman said the vehicle market for the first quarter had been reasonably active, but sales had been hampered by shortages caused by labour disruptions and buyers waiting for the outcome of the elections

A Volkswagen spokesman said car sales for the first quarter had totalled 9 785, compared with 7 442 last year

Nissan sold 7 481 cars in the first quarter — excluding cars earmarked for export — compared with 7 736 during the first three months of 1993

copy #5

Ventel board splits over special 'claims' meeting

Bl Day 26/4/94

THE Venter Leisure and Commercial Trailers (Ventel) board has split over the decision by major shareholder and deputy chairman Michael Katcs to call a special shareholders' meeting to discuss potential claims by the company

Ventel spokesman Michael Levinsohn said yesterday the meeting would allow shareholders to vote on a number of controversial issues that could result in the dismissal of company founder and director Jasper Venter

He said the company believed it had "material claims" against the original vendors of the business — including the Venter family and its associated companies

"Certain of the claims relate to breach of warranty and misrepresentation that stem back to the original sale contract more than two years ago," he said

But Venter and chairman Pienkes du Plessis yesterday said they distanced themselves from the decision as the matter had not been discussed with them

"We object to their unilateral approach and have no knowledge of the details of the claims. I feel the financial results and claim details should be published as soon as possible in the interests of all shareholders," Du Plessis said

"As chairman I have not yet been informed of the financial status of the company and cannot believe that the claims could have a material effect on the results"

Katcs decided to call a special shareholders' meeting in terms of the Companies Act last Monday. On the same day, a board meeting to resolve issues involving a breach of fiduciary duty by a director end-

PETER GALLI

ed without a decision

The JSE then warned the company that its listing faced suspension and even termination if it failed to publish its financial statements by the end of the month. The company and the JSE had previously met to discuss the matter

Levinsohn maintained that the potential claims "could prove to be significant" and that their effect on the company's results for the year to December 1993 could be "meaningful"

"We feel it is essential that shareholders have maximum disclosure and are informed of all the facts"

The company's accountants Price Waterhouse and lawyers Moss Morris were examining how these claims could best be included in the financial results. This would be put to shareholders and the results would be published shortly after the meeting, Levinsohn said

"Ventel has no short-term debt, we currently have R4,7m in cash in the bank, our creditors are always paid and we have kept major institutional shareholders apprised of the situation," he said

Excluding the possible claims, the company had made a profit for the year and had maintained market share over the past year. In the 15 months to December, the company declared a dividend of 9,2c on earnings of 25,7c a share

The share price plunged to a 12-month low of 15c last Thursday from a 95c annual high on April 30 1993, but had gained some ground and was traded at 22c yesterday. At this price it has a dividend yield of 35,54% and an earnings yield of 85,09%

Shortages hamper car sales

Star 10/5/94

Supply constraints remained the dominant feature of the new vehicle market in April, the National Association of Automobile Manufacturers (Naamsa) said yesterday.

While demand for new cars and commercial vehicles remained strong in the month, the high number of public holidays and non-production days contributed to ongoing shortages of most model derivatives, Naamsa said.

New car sales at 14 033 units were 891 units, or 5,9 percent, down on April last year when 14 924 new cars were sold.

April this year recorded a decline of 3 558 units, or 20,2

percent, compared with March when 17 591 new cars were sold.

Sales of light commercial vehicles, bakkies and minibuses at 7 052 units showed a decline of 80 units, or 1,1 percent, compared with the corresponding month last year when 7 132 were recorded.

Compared with March this year, new light commercial vehicles recorded a substantial decline of 2 588 units, or 26,85 percent.

Sales of vehicles in the low-volume medium and heavy commercial truck segments recorded declines of 26 percent, or 12,94 percent in the case of medium commercial vehicles

and a decline of 30 units, 7,8 percent, in the case of heavy trucks, compared with April last year.

Both sectors recorded substantial declines this April, compared with March.

Fundamentals

"Improving economic fundamentals, rising business and consumer confidence following the stable outcome of the election and an expected upturn in the economy should underpin demand for new vehicles generally in the months ahead.

"Steps by vehicle manufacturers to expand production to satisfy market requirements

should contribute to an improvement in sales.

"On the negative side, the continued weakness in the exchange rate of the commercial rand against foreign currencies and the attendant upward pressure on vehicle prices, represented a source of concern," Naamsa said.

Despite the fact that sales in each of the four sectors this year, on a year-to-year basis, were trailing corresponding levels achieved in 1993, the industry remained hopeful that, for the year as a whole, modest improvements in vehicle sales levels generally would be achieved, Naamsa said — Sapa.

Vehicle sales take a knock

SUPPLY constraints remained the dominant feature of the new vehicle market during April, the National Association of Automobile Manufacturers said

While demand for new cars and commercial vehicles remained strong during the month, the high number of public holidays and non-production days contributed to ongoing shortages of most model derivatives, Naamsa said

April new car sales at 14 033 units were 891 units or 5,9 percent down on April last year when 14 924 new cars were sold

April this year recorded a decline of 3 558 units or 20,2 percent compared to March when 17 591 new cars were sold

Sales of light commercial vehicles, bakkies and minibuses at 7 052 units in April, showed a decline of 80 units or 1,1 percent compared with the corresponding month last year when 7 132 were recorded

Compared to March this year, new

light commercial vehicles recorded a substantial decline of 2 588 units or 26,85 percent (192)

Sales of vehicles in the low volume medium and heavy commercial truck segments of the market recorded declines of 26 percent or 12,94 percent, in the case of medium commercial vehicles and a decline of 30 units or 7,8 per cent in the case of heavy trucks — compared to April last year

Both sectors recorded substantial declines during April this year compared to the previous month

"Improving economic fundamentals, rising business and consumer confidence following the stable outcome of the 1994 elections and an expected upturn in the South African economy would underpin demand for new vehicles generally during the months ahead" **ART 10/5/94**

"Steps by vehicle manufacturers to expand production to satisfy market requirements should contribute to an improvement in sales during the months ahead" — Sapa

Chrysler set on SA Jeep project

CHRYSLER Corporation plans to sell Jeeps in SA in a joint venture with a local manufacturer and a black business group which could create up to 3 400 jobs

Chrysler vice-president Leroy Riche, in SA earlier this week for the presidential inauguration, said "We want to get involved and plan to take a 30% stake in a company which will be formed especially for the purpose. Our only hesitation is unhappiness with the phase seven proposals in the motor industry local content programme. We feel they will harm the small player and cost the country jobs."

The phase seven proposals, designed to promote exports and force manufacturers to stop producing low-volume vehicles, would allow limited imports to replace models no longer manufactured in SA.

Although the motor industry task force recommended progressive scaling down of

TREVOR BISSEKER

tariffs on built-up vehicle imports and imported components, Riche felt the plan was inappropriate for a country wanting to create jobs and promote small business.

The Chrysler plan, which Riche said was "about 14 months down the line", was to import Jeeps from the Toledo, Ohio, factory in knocked-down form for assembly in SA. "That way we would still get economies of scale and be able to create jobs here."

Chrysler would take 30% of the new company. The partners would be a local manufacturer "with a paint shop" (30%), a consortium of black businessmen (30%) and employees (10%). The consortium would help establish black entrepreneurs as component manufacturers, making items such as steering wheels and glass parts for the Jeep.

81 Day 1315194
192

Chrysler to sell Jeeps in SA ⁽¹⁹²⁾ ~~(192)~~

From TREVOR BISSEKER

JOHANNESBURG — Chrysler Corporation plans to sell Jeeps in SA in a joint venture with a local manufacturer and a black business group which could create up to 3 400 jobs ^{CT 13/5/94}

Chrysler vice-president Leroy Richie, in SA earlier this week for the presidential inauguration, said "We want to get involved and plan to take a 30% stake in a company which will be formed especially for the purpose. Our only hesitation is unhappiness with the phase seven proposals in the motor industry local content programme. We feel they will harm the small player and cost the country jobs."

The phase seven proposals, designed to promote exports and force manufacturers to stop producing low-volume vehicles, would allow limited imports to replace models no longer manufactured in SA.

The Chrysler plan, which Richie said was "about 14 months down the line", was to import Jeeps from the Toledo, Ohio, factory in knocked-down form for assembly in SA. "That way we would still get economies of scale and be able to create jobs here." It is not known where an assembly plant would be sited.

Chrysler would take 30% of the new company. The partners would be a local manufacturer "with a paint shop" (30%), a consortium of black businessmen (30%) and employees (10%). The consortium would help establish black entrepreneurs as component manufacturers, making items such as steering wheels and glass parts for the Jeeps.

MOTOR INDUSTRY
 Apr 20 1994
Little short-term relief

Hopes that the proposed new motor industry development plan will create a dramatic swing towards more affordable vehicles are not likely to be realised. Even if the new government accepts the plan in its present form, short-term relief will be limited.

Toyota SA chairman Bert Wessels says that, though the plan will contribute to making vehicles more affordable, motorists shouldn't expect it to cause a prompt drop in prices. He adds "In real terms, it has the potential to reduce vehicle costs by 10%-15%" over the eight years the programme is scheduled to run.

The plan, presented to the former government in March, seeks to encourage cheaper cars and light commercial vehicles through the creation of a smaller but world-competitive motor industry. Its main tools are duty penalties designed to force manufacturers to limit domestic production to high-volume, cost-effective vehicles and a reduction in import tariffs on built-up vehicles and components.

Whether the 10%-15% relief predicted by Wessels is enough to drag the market out of its slough is hard to gauge. Severe stock shortages are stalling current attempts to take advantage of increased market demand. Seesawing monthly sales figures for individual manufacturers support their argument that the market reflects what is available

BUSINESS

rather than demand

Still, it is worrying that car and total vehicle sales so far this year lag those for the same period last year.

Mercedes-Benz SA car marketing director Peter Cleary echoes others in the industry when he says it will be at least July before

supply catches up with demand

After that, marketers generally agree that the market will show growth. Increased business and consumer confidence following last month's general election should contribute, as should more foreign investment.

As ever, though, clouds are gathering. Despite the hope among some companies that the market can return to something akin to old buying habits, that is not likely. Having become used to keeping vehicles longer, companies and individuals probably won't feel the same urge to replace them as frequently as in the past.

The second danger is the exchange rate against foreign currencies. The rand's latest weakening will raise import bills for components and place upward pressure on vehicle prices. As the National Association of Automobile Manufacturers of SA comments, this is "a source of concern".

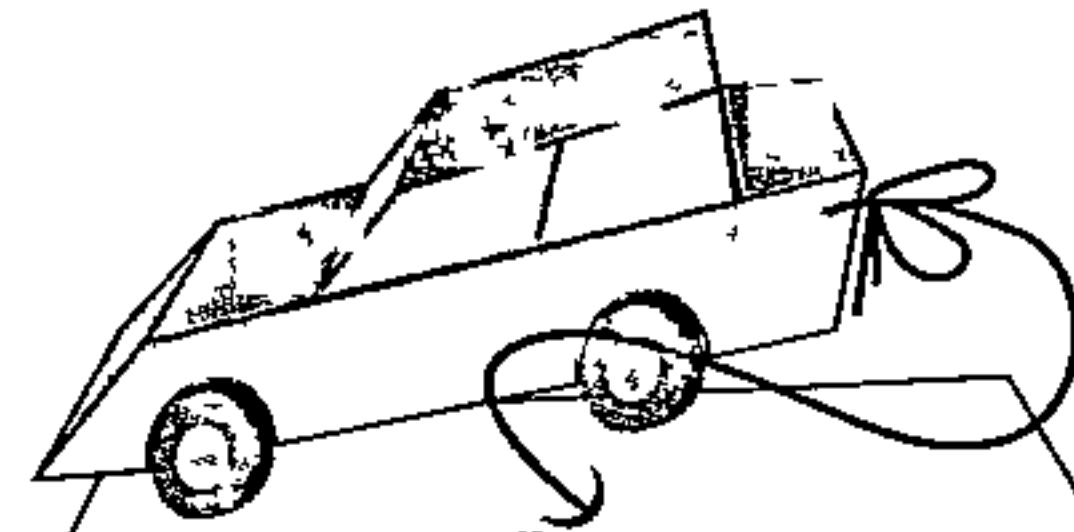

April vehicle sales

Cars	Total	%*
Corolla /Conquest 2 258, Camry 934, other 6		22,8
Golf /Jetta (new) 1 515, Citi/Fox 1 240, Golf /Jetta (old) 56, Audi 166		21,2
Sentra 1 144, Maxima 100, 200SX/300ZX 2, Fiat Uno 758		14,3
Astra/Kadett 1 501, Monza/Kadett 72, Rekord 34, Calibra 8		11,5
Honda Ballade 1 199, M-Benz W124 283, W140 60, W201 1, S124 1, other 4		11,0
Ford Laser/ Meteor 364, Telstar 264, Mazda 323 431, Mazda 626 322, Mitsubishi Pajero 43		10,1
3-Series 1 101, 5-Series 145, 7-Series 20		9,0
Legacy 1		0,0

	1994	1993	% Change
April	14 033	14 924	-6,0
Jan - April	61 662	63 193	-2,4
March (17 591) - April			-20,2

Light commercials
 Toyota 2 411 (34,2% of the market), Nissan 1 618 (22,9), Samcor 1 416 (20,1), Delta 1 115 (15,8), VW 444 (6,3), AAD 48 (0,7)

April	7 052	7 132	-1,1
Jan - April	31 374	31 985	-1,9
March (9 640) - April			-26,8

Medium commercials
 Toyota 64 (36,6%), Delta 37 (21,1), Nissan 37 (21,1), Samcor 20 (11,4), M-Benz 17 (9,7)

April	175	201	-12,9
Jan - April	963	1 022	-5,8
March (326) - April			-46,3

Heavy commercials
 M-Benz 113 (31,9%), Toyota 76 (21,5), Nissan 62 (17,5), MAN 36 (10,2), Delta 27 (7,6), Tyco 17 (4,8), Iveco 14 (4,0), ERF 9 (2,5)

April	354	384	-7,8
Jan - April	1 478	1 617	-8,6
March (513) - April			-31

Total vehicle sales
 Toyota 5 749 (26,6%), Nissan 3 721 (17,2), VW 3 421 (15,8), Samcor 2 860 (13,2), Delta 2 794 (12,9), M-Benz 1 678 (7,8), BMW 1 266 (5,9), other 125 (0,6)

April	21 614	22 641	-4,5
Jan - April	95 477	97 817	-2,4
March (28 070) - April			-23

Source: NATIONAL ASSOCIATION OF AUTOMOBILE MANUFACTURERS OF SA



Bradley *emphasising quality*

Fun 2015/94
 ment strategies, sounder labour relations and a 5% increase in vehicle sales. Chairman Elisabeth Bradley cautions that this figure is distorted by the consolidation of First National Battery Co and Hella SA which, together, account for almost a third of the increase.

Pre-tax margins widened from 3% to 8% and operating income increased threefold to R46,8m. Interest paid dropped 18% to R12,6m, still high compared with borrowings of R15m (R36,6m). MD Alan Plummer attributes this to a distortion by a funding structure used to finance capex two years ago.

(192)
 The report does not detail results of individual activities but Plummer says all subsidiaries were profitable except Motorubber, where a return to black ink is expected, boosted by cost reduction actions implemented last year.

Plummer is confident that Metair is prepared for the challenges ahead brought about by SA's commitment to Gatt Tariffs will be reduced by at least one third and the proposed reduction on motor vehicle components is from 50% to 30% over an eight-year period. "This," he says, "translates into a reduction of costs in real terms of about 2%-3% a year by the component industry if it wishes to stay competitive."

Quality levels are constantly improving and though the achievement of international quality standards has always been a group objective, Plummer says even more emphasis is being placed on it, given the likely changes in the industry. "Manufacturing facilities have been upgraded and we have strong links

Fun 2015/94
METAIR
Prepared for change

Activities: Makes motor components
Control: Wesco 42%
Chairman: E Bradley, MD A D Plummer
Capital structure: 5,7m ords Market capitalisation R194m
Share market: Price 3 400c Yields 3,8% on dividend, 15,2% on earnings, p e ratio, 6,6, cover, 4,0 12-month high, 3 500c, low, 1 100c Trading volume last quarter, 12 000 shares

Year to Dec 31	'90	'91	'92	'93
ST debt (Rm)	4,2	8,1	21,3	5,4
LT debt (Rm)	26,2	35,9	15,3	9,6
Debt equity ratio	0,22	0,16	0,18	N/A
Shareholders' interest	0,62	0,58	0,64	0,65
Int & leasing cover	4,0	4,3	1,8	4,7
Return on cap (%)	13,5	14,1	9,8	18,0
Turnover (Rm)	330	390	366	565
Pre-int profit (Rm)	25,6	35,3	27,4	59,4
Pre-int margin (%)	7,6	9,0	7,4	10,4
Earnings (c)	153	275	144	517
Dividends (c)	63	74	40	130
Tangible NAV (c)	2 063	2 571	2 994	3 545

After three years of wild gyrations in earnings growth, 1993 saw Metair Investments again firing on all cylinders. Off a low base, earnings jumped 260% to R29,3m.

(192)
 In the year to end-December, gross cash flow at the vehicle components supplier almost trebled to R65,8m (R24,6m). Much of this was used to retire R22,6m debt, to purchase operating assets and increase the stake in Hella SA to 60%.

Turnover jumped 55% to R565m from a successful implementation of new manage-

Metair Investments

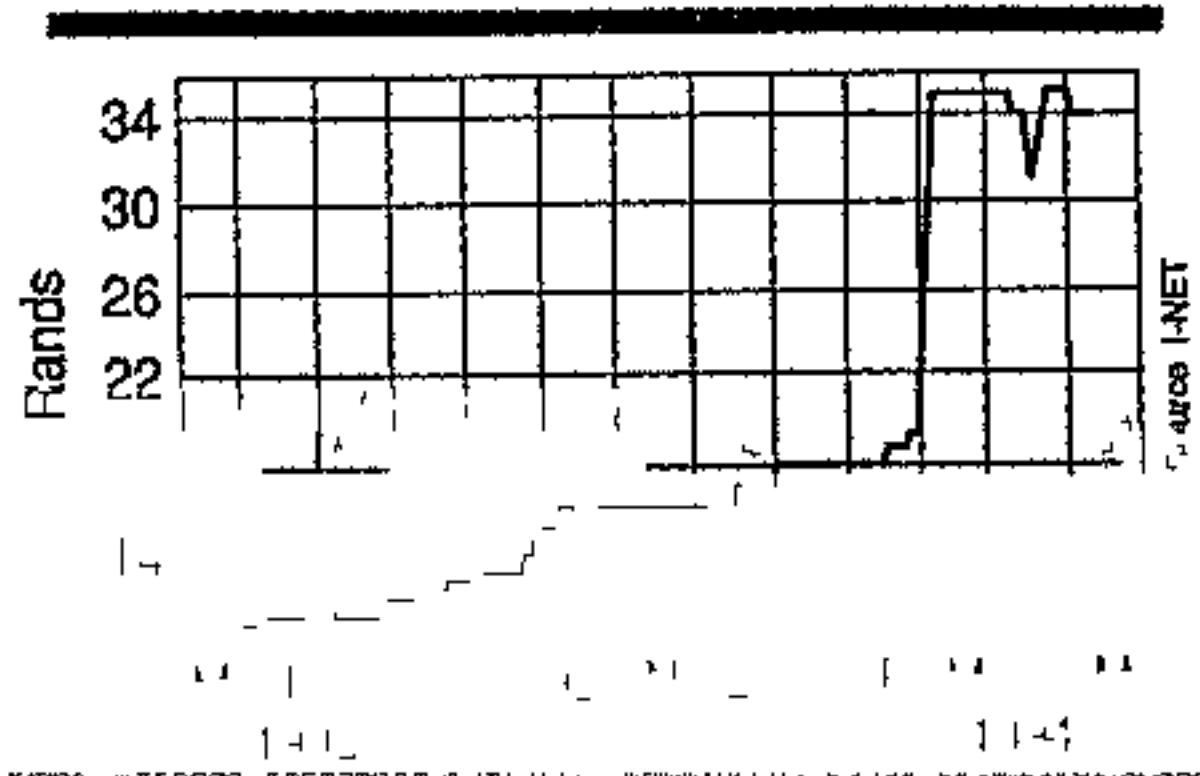

Fun 2015/94
 with Japanese and German licensors for technology."

With no apparent strain on the balance sheet, the annual dividend should follow earnings.

(192)
 But with 60% of Metair's sales going to new vehicle production, any profit improvements will largely reflect the level of activity in this market.

Marylou Greig

Car prices likely to increase soon

THE motor industry was bracing itself for price increases prompted by the weakening rand and shrinking margins, manufacturers warned at the weekend.

Samcor, Volkswagen, Toyota and Nissan said the rand's depreciation would push up the costs of components, and that the industry's scope to absorb such increases was limited.

(192)
The industry is reliant on imports from Japan and Germany of components which make up about half the cost of a new vehicle. The rand has fallen 15,7% against the yen and 13,5% against the Deutschmark since the start of the year.

Sales of new passenger cars are already 2,4% behind 1993's sales on a year-to-date basis, but this has been attributed largely to a lack of supply.

MICK COLLINS

Samcor's finance executive director Gideon Wolthers said the weak rand would have a detrimental effect on the cost of vehicle assembly. While local manufacturers were reluctant, in the current competitive environment, to increase vehicle prices, "you may very well see prices going up". The extent of such increases was difficult to estimate.

A Volkswagen spokesman said that if rates remained where they were or declined further there would "be pressure on prices. Our next quarterly increases are due for July 1 but at what level they will come in we don't know."

Because of the competitive nature of the

□ To Page 2

Car prices

industry the full increase could never be passed on to the consumer, he said.

Toyota sales director Johann van Zyl said the company was evaluating the situation. It had not made any decision on price increases yet.

All manufacturers would have to look at prices if the rate stayed where it was or deteriorated further. "We don't know if this is just a short-term setback in the rates."

A Nissan spokesman said the situation was "pretty severe".

(192)
The rand had fallen 45% against the yen during the past two years. The continuing decline would have a huge effect on margins as motor manufacturers would have to absorb extra costs. "If we increase prices it drives customers away from showrooms. There is no way we can pass on the full effect to the consumer."

A BMW SA spokesman said the company's forward planning was such that it

had anticipated the currency drop in the period leading up to and after the elections. "But we will be watching the situation and if the value of the rand continues at the present level or deteriorates further we will have to reconsider our pricing policy."

An analyst said although the effect might not be immediate as the motor companies had taken forward cover, it would be felt towards the end of the year.

He said first-quarter increases in new car prices on a year-on-year basis were 16%. They had been expected to drop to 12% in the second quarter.

Econometrix economist Tony Twine said the immediate effect of the weaker rand would be somewhat muted "but a maintenance of the present position will virtually ensure that the decline in car price escalation will be reversed by the end of 1994".

□ From Page 1

From MICK COLLINS
JOHANNESBURG —
The motor industry was bracing itself for price increases prompted by the weakening rand and shrinking margins, manufacturers warned at the weekend

Motor industry braced for price increases

192
CT 23/5/94

Samcor, Volkswagen, Toyota and Nissan said the rand's depreciation would push up the costs of components, and that the industry's scope to absorb such increases was limited

The industry is reliant mainly on component imports from Japan and Germany which make up about half the cost of a new vehicle. But the rand has fallen 15,7% against the yen and 13,5% against the Deutschemark since the start of the year.

Sales of new passenger cars are already lagging behind 1993 by 2,4% on a year to date basis but much of this has been attributed to a lack of supply.

Samcor's finance executive director Gideon Wolthers said the weak rand would have a detrimental effect on the cost of vehicle assembly. While local manufacturers in the present competitive environment were reluctant to increase vehicle prices, "you may very well see prices going up". The extent of such an increase was difficult to estimate.

A Volkswagen spokesman said if rates remained where they were or even declined further there would "be pressure on prices. Our next quarterly increases are due for July 1 but at what level they will come in we don't know yet".

Due to the competitive nature of the industry the full increase could never be passed on to the consumer, he said.

Toyota sales director Johann van Zyl said the company was evaluating the situation and had not made any decision on price increases yet.

All manufacturers would have to

look at prices if the rate stayed where it was or deteriorated further. "We don't know if this is just a short-term setback in the rates."

A Nissan spokesman said the situation was "pretty severe".

The rand had fallen 45% against the yen over the past two years. The continuing decline would have a huge effect on margins as motor manufacturers would have to absorb extra costs. "If we increase prices it drives customers away from showrooms. There is no way we can pass on the full effect to the consumer."

A BMW SA spokesman said the company's forward planning was such that it had anticipated the currency drop in the period leading up to and after the elections.

Declining rand

"But we will be watching the situation and if the value of the rand continues at the present level or deteriorates further we would have to reconsider our pricing policy."

An analyst said although the effect might not be immediate due to the motor companies taking forward cover, it would be felt towards the end of the year.

He said first-quarter increases in new car prices on a year-on-year basis were 16% and had been expected to drop to 12% in the second quarter.

Econometrix economist Tony Twine said the immediate effect of the weaker rand would be somewhat muted "but a maintenance of the present position will virtually ensure that the decline in car price escalation will be reversed by the end of 1994".

Tractor numbers dwindle

THE next five years may prove crucial for agriculture following a sharp drop in tractor power over the past decade, SA Agricultural Machinery Association secretary Jim Rankin said *Bay*

During the past 10 years the number of tractors in operation had fallen 43% and the decline was expected to continue beyond the end of the decade, he said in his latest Agfacts newsletter *(192)*

The total number of tractors in use fell to below

120 980 last year from more than 211 000 in 1983, he said. *24/5/94*

It is expected to fall further to about 72 500 in the year 2005.

This was despite a projected rise in sales from just over 4 000 envisaged for 1994 to 5 000 in 1998 and 6 000 in 2005, he said.

Although the quality of the "tractor park" would improve with current good sales, the next five years would be critical in terms of the availability of tractor power. — Reuter.

and Consumer dings Limited

(the Company")

Republic of South Africa)
o 63/02648/06

... ..

Waiting lists for many car models

CONSUMERS were being forced to wait up to three months for new vehicles as production disruptions in the motor industry began to feed through, sources said yesterday. *Bay*

All seven motor manufacturers yesterday reported lengthening waiting lists, with some estimating lead times of up to four months on certain models. *24/5/94*

Samcor marketing MD Arthur Mutlow said despite increased production customers had to wait four to six weeks for delivery of top of the market Mazda MX-6 cars

The Mitsubishi Pajero had a three-month waiting list while the half-ton Ford Bantam and Mazda Rustler 1600 and fuel-injected models had waiting lists of up to two months. In the small car market, demand for Ford and Mazda models was outstripping supply with customers having to wait more than six weeks.

Sources said supplies had been hit by labour disruptions over the past four months

Mercedes-Benz said there was a three-month waiting list for its six-cylinder vehicles, including the E280, the E320 and the S-class range. Of the Honda models there were delays for the Honda 180E, which had about a four-week waiting period

Prospective BMW 3-Series owners had to wait about two months for delivery, 5-Series about one month and 7-Series "no more than a few weeks"

The unexpected high demand for BMWs during the past six months had taken the company by surprise and "the production catch-up programme we introduced some months ago is

MICK COLLINS

rapidly reducing delays". The various disruptions during the first quarter had added to delays but since the elections production had gone smoothly

Toyota SA said it had been affected by lost production days as a result of the recent spate of public holidays and the week-long closure during the elections. It was also still suffering from the effects of a week-long strike at the end of last year.

"All models of passenger and commercial vehicles are affected," a spokesman said. *(192)*

A VW spokesman said the waiting lists for Volkswagen and Audi products varied from region to region. "One may wait one month for a specific model in Port Elizabeth but two months for the same car in Cape Town. One may even have to wait four weeks for a certain model and up to four months for another."

Nissan national sales director Lester Millar said waiting periods varied across the range of Nissan products. Certain Uno models were in short supply with waiting times of three to four weeks while at the other end of the market there was a three- to four-month waiting period for the Sanu Double Cab

Delta sales and marketing director John Cumming said specific models were in shorter supply than others — the Astra 160iE, the Kadett 140 and the recently introduced Astra and Kadett 160iS models

But it was difficult to establish the length of waiting lists as these differed among provinces and dealers, he said.

Biday 25/12/94

Mercedes in talks on axed 'sit-in' workers

EAST LONDON — While former Mercedes Benz of SA workers dismissed in 1990 continued occupying the company's administration block yesterday, senior officials from Mercedes, Cosatu and the provincial government were negotiating to resolve the problem. Spokesmen for the par-

Own Correspondent

ties said the officials involved in the discussions would comment today (19/12)

The meeting comes in the wake of an announcement by Mercedes that it would give a R1m training package to the 528 workers dismissed for occupying the

plant in 1990.

The company would contribute half of the amount while the other half would be sourced from its industry work security fund.

This money would enable the dismissed workers to receive basic adult education training or training in specific skills.

No surprises from Ventel

■ BY STEPHEN CRANSTON

The long-delayed Venter Leisure and Commercial Trailers (Ventel) results for the year to December have finally been published, amid little surprise they were so bad *Star*

Earnings per share were down almost two-thirds from 18,5c to 6,4c *2515194*

Turnover is not disclosed, but it fell by 16,25 percent on a turnover index.

Spokesman Michael Levinsohn says the luggage trailer division, traditionally the strongest profit-generator, was hardest hit by depressed consumer spending. But the commercial trailer and export divisions were "solid".

The luggage trailer business is highly dependent on the level of consumer finance, which has been depressed.

Taxed income fell 65 percent to R3,23 million and there was an extraordinary loss of R657 000 caused by writing down a loan to the Share Incentive Trust to reflect the changing market value of the trust's shares *(192)*

But benefits could accrue to the company if its claims against one of the directors, Jasper Venter, are successful.

Levinsohn says that there are reasonable recovery prospects. In order to counter slow credit demand, a finance package has been launched to facilitate the purchase of trailers.

Ventel maintained a dominant market share, and won the German TUV quality approval rating, giving it an edge in exports as it is the only SA light trailer manufacturer to get the award.

Work to resume at Toyota plants

8 Day 25/5/94

Own Correspondent

DURBAN — The 6 000-strong workforce at Toyota SA's Durban plants would resume work today, a National Union of Metalworkers official said last night.

The company closed all operations at its Prospecton plants on Thursday afternoon after workers embarked on "go slows" to back up demands, including the removal of two employees from a certain department.

Union official Douglas Mbambo said workers agreed at a mass meeting yesterday to return to work today. However, they warned that their demands, relating to issues such as the provident fund, car leasing and medical aid, should be addressed within two weeks.

"If these matters are not addressed they

said they would embark on other measures to achieve their demands," Mbambo said.

He said workers of one department started a "go slow" on Thursday in an attempt to have two employees, one of them a foreman, removed from the department. (192) (192)

When the demand was not met, colleagues from other departments joined them in solidarity "go slows" which culminated in the company closing all operations this week, Mbambo said.

The company's management had been informed about the decision to return to work, he said.

Govt plans new policy on vehicle emissions

THE Mineral and Energy Affairs Department said yesterday it would develop a national policy on vehicle emissions in preparation for the planned introduction of unleaded petrol.

A working party had been formed in conjunction with the departments of National Health and Population Development and Environmental Affairs.

It would include representatives of government, the oil industry, the motor industry, the Automobile Association, academics and other interest groups.

The Minerals and Energy Affairs Department said a new policy was needed to meet changes brought about by vehicle emissions control technology, liquid fuel formulation — specifically the introduction of unleaded petrol — urban growth and the drive for a

MICK COLLINS

better environment.

"Clear policy is needed to guide the introduction of motor vehicle emission control technology and regulatory measures," it said.

The introduction of such measures could have profound effects on the motor industry, the petroleum industry, mass transport policies, alternative engine technologies and urban design, it said.

The department wanted the best possible information on current and anticipated environmental pollution levels caused by vehicle emissions.

Policy development would be divided into three phases. The first information session would discuss with interested consultants draft specifications for phase one.

2615194

Workers' sit-in continues at Mercedes-Benz

EAST LONDON — The sit-in at Mercedes-Benz of SA by workers fired three years ago and now demanding reinstatement continued for the third day yesterday. "There's no change at this stage," company spokesman Delene Stroh said. About 70 workers out of a group of 500 fired after a nine-week strike in late 1990 are demanding unconditional reinstatement. Mercedes-Benz has said it would not consider re-employing the workers and has instead offered to set up a R1m retraining scheme to help them find other work. The National Union of Metalworkers of SA, representing the dismissed workers, has rejected the offer and is calling for reinstatement. Numsa has been unavailable for comment since the workers began their sit-in — Reuter.

265/94 (192)

Ex-workers' sit-in ended

EAST LONDON — Seventy former Mercedes-Benz workers who had staged a sit-in since Monday were evicted from the company's Settlers' Way administration block in East London last night.

The eviction, by members of the local police riot unit, was authorised by a Supreme Court order handed down in Grahamstown on Wednesday ~~192~~ 192

The workers were briefly detained and released soon after 9pm. — Sapa CT 27/5/94

'Unprocedural' strikes cost VW R20m

B/Nay 30/5/94

ERICA JANKOWITZ

A SPATE of unprocedural strikes at Volkswagen's Uitenhage plant had lost the company nine days' production and R20m-R25m in revenue this year, the company said on Friday

Two days were lost last week when workers downed tools as a result of apparent racist attitudes of management

Company spokesman Percy Smith said this issue was resolved late on Friday with the National Union of Metalworkers of SA (Numsa) agreeing all workers would return to work this morning (192)

The company obtained a court interdict on Friday declaring the strike unlawful and forcing workers to end the action. The

strike was preceded by an office occupation, with workers preventing three staff members from leaving

"VWSA cannot tolerate this type of ill-discipline by Numsa members," VW human resources director Brian Smith said. Union shop stewards and officials agreed "this type of undisciplined and unprocedural behaviour cannot be allowed"

Smith said national and regional government structures had called for companies to contribute funds to reconstruction and development, which VW supported. But businesses needed to be viable to do so

Numsa action
at VW unclear

Own Correspondent

PORT ELIZABETH — It was unclear last night if the National Union of Metalworkers would continue work stoppages today following the closure of Volkswagen's Uitenhage plant on Friday (192) (192)

A statement by Numsa yesterday said the "dispute still exists", but did not say whether Numsa would obey last week's court ruling that the workers should return to service. (S)

VW workers ¹⁹²
continue strike

PORT ELIZABETH
The strike at Volkswagen's plant in Uitenhage continued yesterday

ET 3/5/94

Workers who reported for duty held meetings with their union shop stewards despite a court ruling last week that the stoppage was illegal

The strike started on Wednesday when workers on the A3 Golf and Jetta line downed tools and accused supervisors of "racist attitudes, baasskap and victimisation" It spread to other lines — Sapa

Strike a threat to jobs ^{VW}

Own Correspondent

PORT ELIZABETH — Volkswagen warned yesterday that thousands of jobs at its huge Uitenhage plant, and "many more" in the automotive industry, could be lost, unless workers end an illegal strike and obey their union's instruction to return to work today.

The Eastern Cape's largest employer, of over 7 000 people, has lost R78 million — R13m a day — during the work stoppage which was in its sixth day yesterday.

Saficon puts lean years behind it

Star 2/6/94

■ BY STEPHEN CRANSTON

After a few dismal years, Saficon increased earnings fourfold to 63c a share in the year to March

The dividend has been raised from 4c to 15c

There was a particularly welcome turnaround by building materials trader Boumat, which saw operating profit in the second half that was almost 50 percent higher than in the first

Boumat's turnover was up six percent to R1,3 billion. After improved operating profit, a fall in finance charges from R8,23 million to R5,50 million and a fall in the effective tax rate from 51,9 percent to

40,1 percent, its attributable earnings increased by 68 percent to R12,9 million and earnings per share by the same percentage to 42c

Boumat's dividend is up from 6c to 10c and its gearing is a sound 22 percent

Saficon group CE Kurt Hipper says that Boumat's total assets increased by 12 percent, thanks to a planned increase in stocks at year-end to cover any disruption of supplies during the election period and to a higher debtors' book from increased turnover in March

Hipper says Boumat is budgeting for further improvement in the current year

Saficon's motor investments,

which include Lindsay Saker and Cargo Motors, experienced early signs of an upturn

Group sales of Mercedes and Volkswagens increased by 6,5 percent, compared with a national sales increase of 5,8 percent. Volkswagen/Audi increased market share

Hipper says that there was an erratic supply of vehicles because manufacturers underestimated demand and were faced with labour disputes

Group turnover increased slightly to R2,88 billion and operating profit was up 42 percent to R68,7 million

The effective tax rate fell from 51,9 percent to 40,1 percent and net interest paid from

R29,1 million to R23,1 million

Attributable income totalled R22,5 million, compared with R5,1 million in the previous year

Hipper says that car dealers should increase sales volumes and market share during the current year and Boumat should benefit from the recovery in the building industry

Saficon's gearing increased from 14 percent to 34 percent and net worth from 602c to 650c, which is also its current market price

Saficon's pyramid holding company Saker's Finance & Investment increased earnings from 24c to 105c a share

Its dividend is up from 5c to 24c

Motor upturn helps put Saficon on recovery path

MICK COLLINS

MOTOR retail and building products group Saficon Investments increased earnings fourfold to R22,5m for the year to March as a result of a better performance from subsidiary Boumat and an improvement in trading conditions in its motor business.

Group turnover rose 7% to R2,9bn but better margins saw operating profit increase 42% to R68,7m. Earnings a share rose to 63c (14c) and the dividend increased to 15c (4c).

Lower interest rates on reduced borrowings, a lower tax rate and the increased share of Boumat's earnings from its larger share in that company contributed to the improvement.

Chairman Sidney Borsook said fiscal 1994 had been a much better year for the group and "we are satisfied with the outcome as a first step on the road to recovery".

He said the group was budgeting for further improvement in 1995 but cautioned that the budget had been

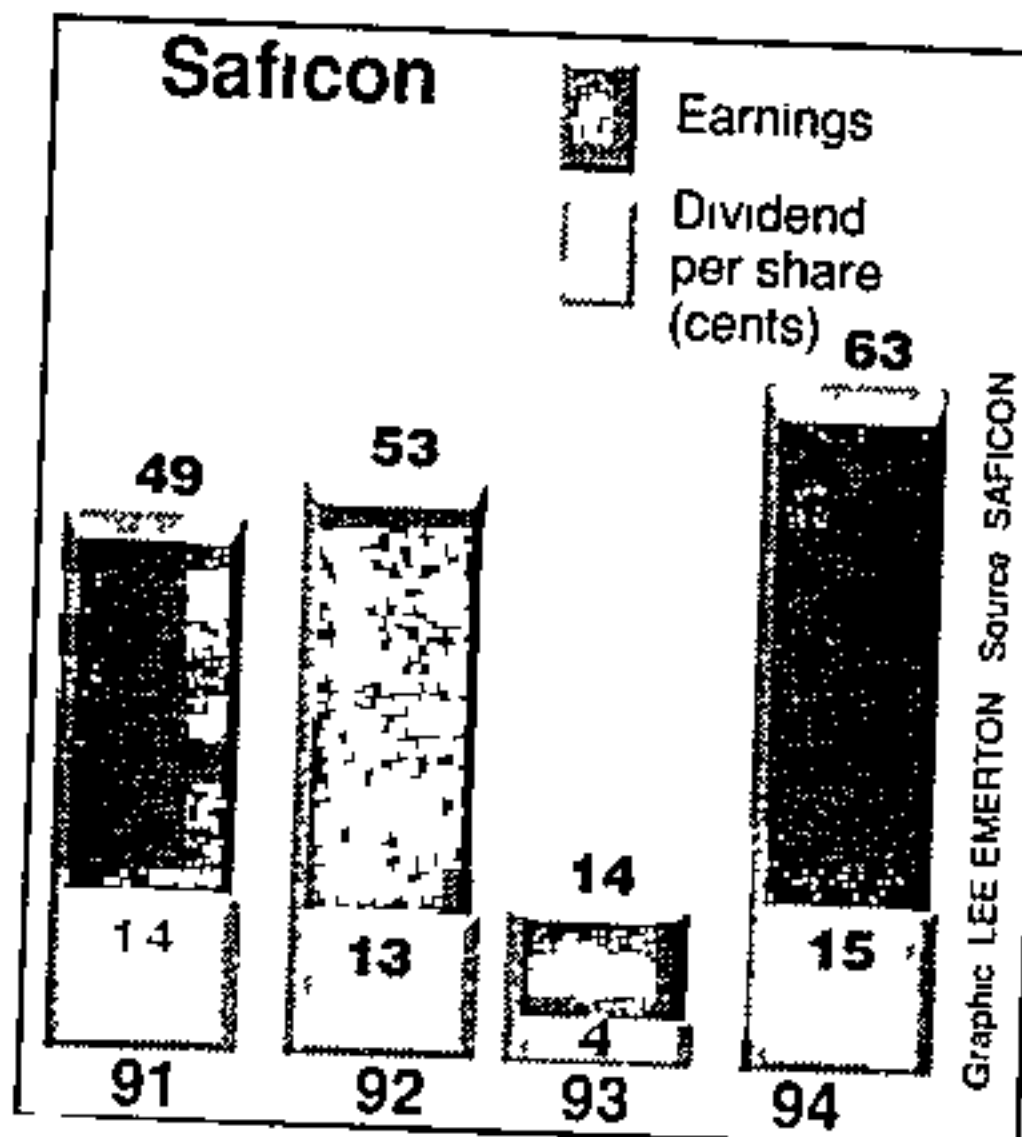

based on the assumption that there were no disruptions which would have a significant negative affect on the economy or on Saficon's business activities (192) (22)

Despite a further deterioration in the building industry which remained "fiercely competitive" Boumat's turnover rose 6% to R1,3bn. Shareholders' earnings rose 63% to R12,9m which translated into earnings a share of 42c (25c). The dividend for

the year was increased to 10c (6c). Operating income increased from R24,7m to R26,2m but group CE Kurt Hipper said operating profit for the second half at R15,7m was almost 50% higher than in the first half.

Hipper said Boumat's financial position was sound and total assets increased 12%, more than the 6% rise in turnover. "This is due to a planned increase in stocks at the year end to cover any disruption in supplies during the election period and to higher debtors flowing from high turnover in March."

Commenting on overall operations, Hipper said that for the first time in five years the motor industry showed a slight upturn. National dealer passenger vehicle sales increased 5,8% and the group's sales of Mercedes Benz/Honda and Volkswagen/Audi passenger vehicles rose 6,5%.

Saker's Finance and Investment Corporation, which derives its income solely from its 50,4% holding in Saficon, saw earnings rise to 105c (24c) a share and a dividend of 24c was declared (5c).

Five-day strike costs VW R80m

5/Day

ERICA JANKOWITZ

PRODUCTION at Volkswagen's Uitenhage plant resumed yesterday after a five-day strike that cost about R80m in lost revenue, spokesman Percy Smith said

However, a recovery plan which included overtime and additional production days had been discussed and would probably be implemented early next week

National Union of Metalworkers of SA (Numsa) shop steward and Cosatu president John Gomomo said the strike was sparked by management's apparent reluctance to deal with worker grievances

He said workers and the company were equally to blame for the strike, but management should have discussed the grievances at the earliest opportunity to resolve the issue. "They seemed to be prepared to lose millions when they are in deep financial trouble" 3/6/94

Workers had raised a list of 10 grievances on May 5 and went on strike only 14 days later when it was obvious that man-

agement would not deal with the issues, he said. Grievances included the perceived racist attitude of a supervisor who VW refused to discipline and the company's "lean manufacturing" programme which had placed undue workloads on some departments (192) (192)

Smith said VW was concerned about the implications of the strike on local suppliers and VW dealers. The "unprocedural industrial action" had strained relations between management and the union.

Gomomo agreed, but said the union would act responsibly and co-operate on recovery plans. "We need each other even though the relationship is shaky."

Labour researchers suggested the problem may have been exacerbated by Numsa's leadership problems, with the union losing several officials and shop stewards to regional and national government

R807m blow stalls motor industry

BIDAY 31/6/94

MICK COLLINS

THE recent spate of public holidays and industrial action had cost the motor industry R807m in lost revenue since the start of the year, the National Association of Automobile Manufacturers of SA (Naamsa) said yesterday

It said nearly 15 500 units, 5,5% of the estimated 295 000 new cars and light commercial vehicles which were expected to be sold this year, had been lost

This would slice about 6% from the industry's wholesale R15bn turnover, which analysts warned would feed straight through to the industry's bottom line

Tax losses to government, excluding VAT, were estimated to be about R90m, but including VAT the loss would be close to R200m, Naamsa said (192)

Naamsa director Nico Vermeulen said the disruptions would have an effect not only on sales in May and June but he could not see a return to normality before the second half of July

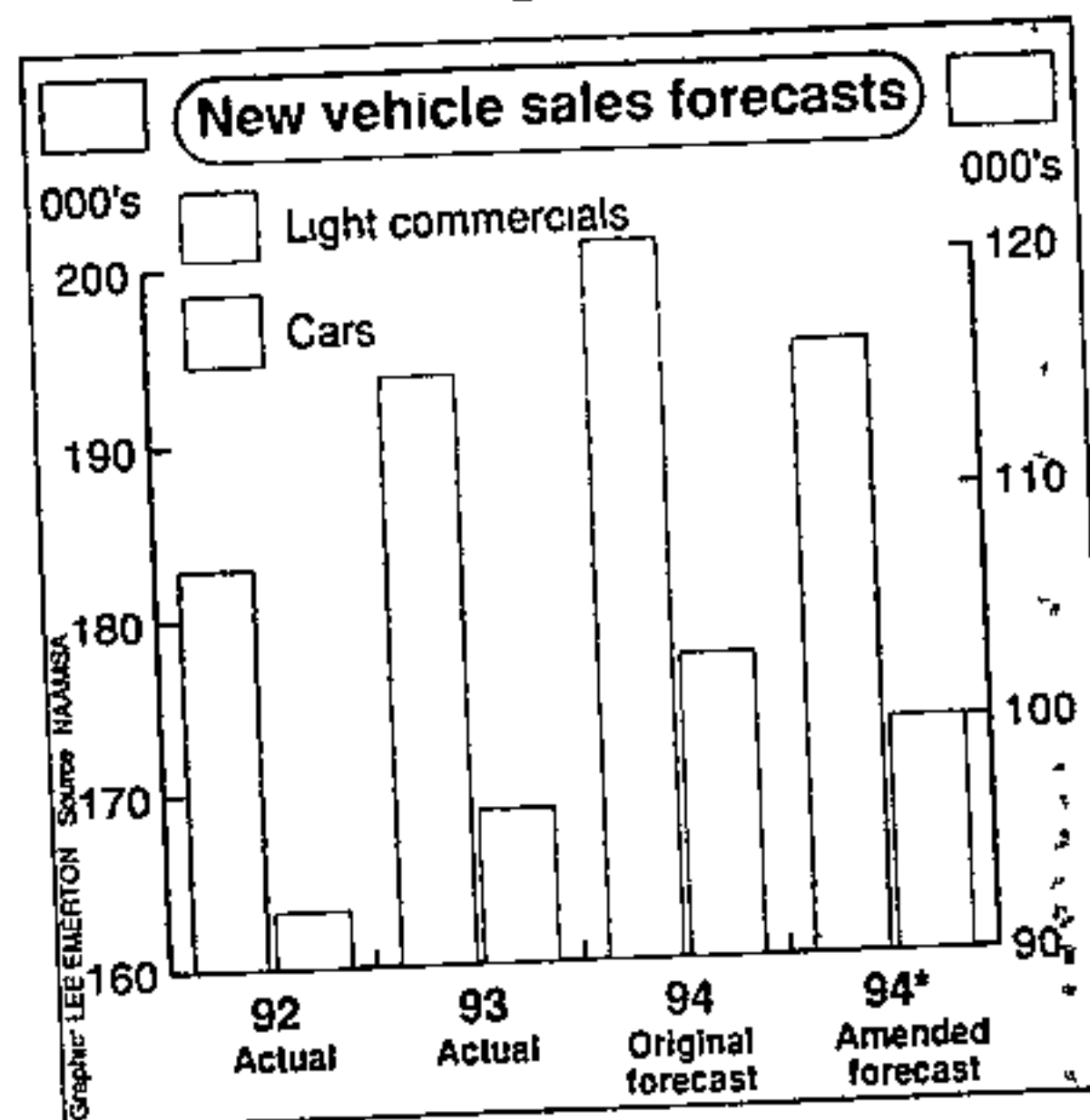

In some cases attempts were made to work in time lost, but in other cases this was not achieved

"There are no winners in this type of environment. We can hope only that common sense will prevail if jobs are to be

To Page 2

Motor industry

BIDAY 31/6/94

preserved and the motor industry is to remain viable" (192)

He said the majority of manufacturers had been affected, with most of the units lost in the past few weeks being due to unprocedural industrial action.

Input across the spectrum of the industry had been affected - local component manufacturers, the motor manufacturers themselves, employees as well as dealers who were sitting with abnormally low inventories. The industry's ability to export had also been dealt a blow

Vermeulen said "unnecessary unproce-

dural action" had to end for the industry to remain viable and avoid further job losses

Econometrix economist Tony Twine said matters should settle down with the elections out of the way. But it was usually about this time of year that the industry started to see the first signs of trouble related to annual wage bargaining.

"The little ray of hope that does exist is that the unions are no longer carrying the role of being the political voice of the labour force. One hopes that the unions will be less political in their demands and more realistic in terms of the economics in coming wage discussions," he said

From Page 1

Holidays cost motor industry R807m

Own Correspondent

JOHANNESBURG — The recent spate of public holidays and industrial action had cost the motor industry R807m in lost revenue since the start of the year, the National Association of Automobile Manufacturers of SA (Naamsa) said yesterday.

It said nearly 15 500 units, 5.5% of the estimated 295 000 new cars and light commercial vehicles which were expected to be sold this year, had been lost.

This would slice about 6% from

the industry's wholesale R15bn turnover, which analysts warned would feed straight through to the industry's bottom line.

Tax losses to government, excluding VAT, were estimated to be about R90m, but including VAT the loss would be close to R200m, Naamsa said.

Naamsa director Nico Vermeulen said the disruptions would have an effect not only on sales in May and June but he could not see a return to normality before the second half of July.

In some cases attempts were made to work in time lost, but in other cases this was not achieved.

"There are no winners in this type of environment. We can hope only that common sense will prevail if jobs are to be preserved and the motor industry is to remain viable."

He said the majority of manufacturers had been affected, with most of the units lost in the past few weeks being due to unprocedural industrial action.

Input across the spectrum of the

industry had been affected — local component manufacturers, the motor manufacturers themselves, employees as well as dealers who were sitting with abnormally low inventories.

The industry's ability to export had also been dealt a blow.

Vermeulen said "unnecessary unprocedural action" had to end for the industry to remain viable and avoid further job losses.

Econometric economist Tony Twine said matters should settle

down with the elections out of the way.

But it was usually about this time of year that the industry started to see the first signs of trouble related to annual wage bargaining.

"The little ray of hope that does exist is that the unions are no longer carrying the role of being the political voice of the labour force. One hopes that the unions will be less political in their demands and, more realistic in terms of the economics in coming wage discussions," he said.

192 CT 3/6/94

COMPANIES

Midas 'will see earnings growth' after restructuring

Biday 3/6/94
MUNGO SOGGOT

RESTRUCTURED motor supply group Midas would see an "acceptable real growth" in earnings this year, but only a marginal increase in turnover, CE Sarel de Vos said in the annual report

Midas — in which McCarthy Retail has an 80% stake — pushed earnings to 64,3c a share (16,9c loss a share) for the year to February

"The group has emerged from a dramatic period of restructuring — which involved the elimination of non-core business — with a 30% improvement in operating profit," he said

The implementation of Phase VII of the local content programme — which would cut production of low volume car models and allow imports to replace them — could "offer opportunities to companies operating in the accessories market"

A team of eight senior executives were reviewing the strategic direction of the group in an exercise called Project High Performance

De Vos said Midas would focus on introducing improved stock management systems, preventing stock losses with better security and strengthening its human resources department

He said the Midas Parts Centre chain had increased its number of outlets.

FM 31/6/94
Raptor

COMPANIES

RAPTOR

Good for some

Activities: Runs a motor garage and service stations Sells new and used motor vehicles
Control: Southern Motor Holdings 65%
Chairman: D A Khonat, MD E S Moonda
Capital structure: 3.6m ords Market capitalisation R13,1m

Share market: Price R4 Yields 12,3% on dividend, 17,2% on earnings, p e ratio, 5,8, cover, 1,4 12-month high, R4, low, R2 Trading volume last quarter, nil shares

	†'91	'92	'93
ST debt (Rm)	0,24	0,14	0,93
LT debt (Rm)	—	0,09	0,74
Debt equity ratio	n/a	1,2	n/a
Shareholders interest	0,23	0,17	0,14
Int & leasing cover	1,3	n/a	n/a
Return on cap (%)	35,5	42,1	36,4
Turnover (Rm)	25,3	41,0	50,6
Pre-int profit (Rm)	1,8	2,6	2,9
Pre-int margin (%)	7,2	6,5	5,7
Earnings (c)	†85	83	69
Dividends (c)	45	25	49
Tangible NAV (c)	38	96	115

† 16 months ‡ Annualised

Raptor Motor Holdings is a business within a business Based in Rustenburg, it does well at the operating level, increasing operating

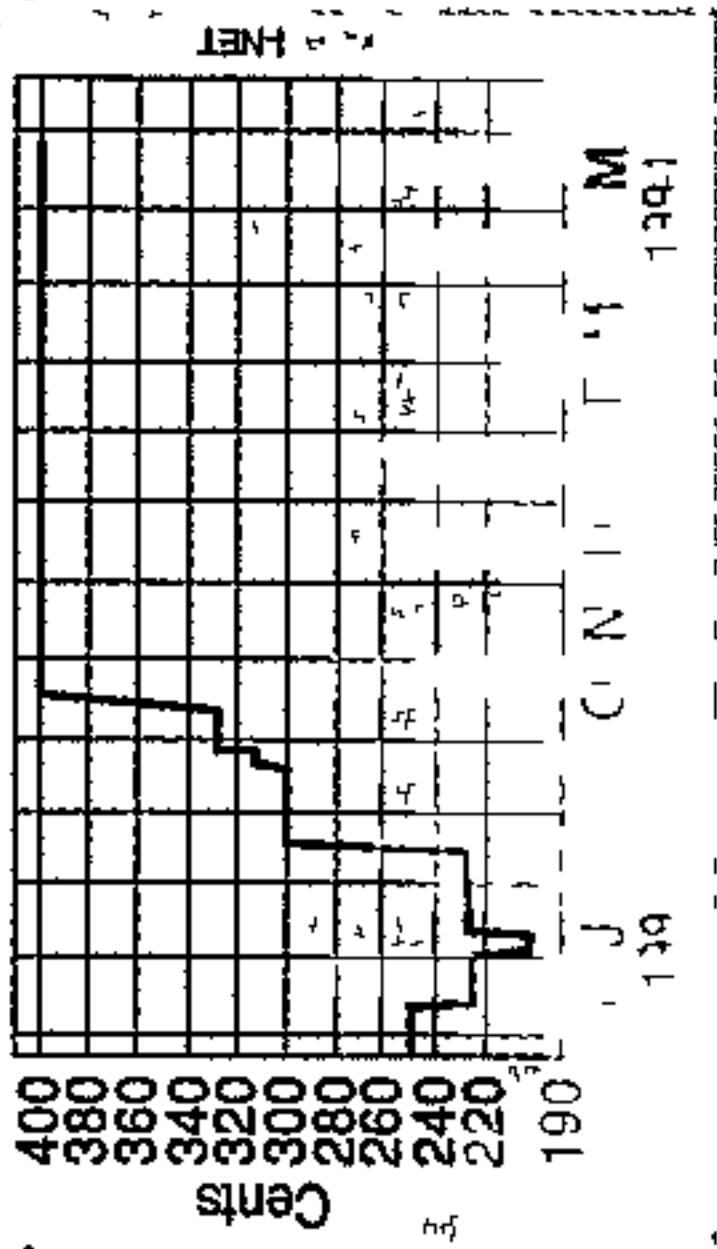

profits in its 1993 financial year by 10% to R2,9m on a 23% rise in turnover

That shows margins under pressure, but it's a creditable performance in what was a difficult year for the motor industry Chairman Dawood Khonat notes the slump and says the group is not looking at expanding by acquisition The aim for now is to maintain market share and profitability

The second part of the business is what happens to that "profitability" Raptor has used up its assessed tax losses and had to pay R706 000 in taxes in 1993 That took the shine off the operating performance, depressing net income and, ultimately, earnings to a decline of nearly 18% (1992)

Against this, Raptor saw fit to nearly double its dividend payout to 49c a share, reducing dividend cover to 1,4 times Altogether, the company paid out R1,6m in divi-

dends, against retained income of R646 000 The dividend increase should make shareholders ecstatic, but there are not many minorities Of the 3,26m issued shares, 3,22m are held by directors What is not revealed in the annual report is Raptor's holding company According to the JSE, however, 65% of the equity is held offshore on the Virgin Islands by a company called Southern Motor Holdings

And there are common directorships between Southern and Raptor, including that of chairman Khonat So Raptor continues to pump its earnings out of the country, through inflated dividend payouts, to the tax-free Virgin Islands

Last year, when the FM made the same point (though the dividend was less generous then), we noted that this was really a matter for the Reserve Bank, which appeared to be satisfied The same must apply this year

All that has really changed is that the share price has nearly doubled in value since the 1992 annual report was reviewed But that's merely of academic interest -- there are only a few thousand shares for investors who might be interested

It remains hard to understand why Raptor is allowed to keep its listing

Shaun Harris

VAALTRUCAR
Fm 31/6/94
Rationalisation pays off

Activities: *Retails new and used motor vehicles and spares*

Control: *S F Germishuizen 47%*

Chairman: *S F Germishuizen*

Capital structure: *16,5m ords Market capitalisation R5m*

Share market: *Price 30c 11,1% on earnings, p e ratio, 9,0 12-month high, 35c, low, 20c*

Trading volume last quarter, 15 000 shares

Year to Feb 28	'91	'92	'93	'94
ST debt (Rm)	3,18	6,16	4,63	3,0
LT debt (Rm)	1,26	1,32	0,96	0,55
Debt equity ratio	0,30	0,84	0,80	0,45
Shareholders interest	0,36	0,28	0,32	0,33
int & leasing cover	1,59	n/a	1,09	1,74
Return on cap (%)	12,2	(0,4)	6,5	8,4
Turnover (Rm)	138,3	121,0	86,7	92,3
Pre-int profit (Rm)	4,2	(0,1)	1,7	2,0
Pre-int margin (%)	3,0	(0,1)	2,0	2,2
Earnings (c)	5,7	(17,0)	(8,9)	3,9
Dividends (c)	3,2	nil	nil	nil
Tangible NAV (c)	60	43	34	38

Extensive rationalisation and streamlining have borne fruit for motor retail and spares group Vaaltrucar Remedial action over the past two years contributed to an eleven-fold increase in earnings to R636 000 (1992)

In the year to February, operating income jumped an impressive 17% to R1,98m on turnover up almost 7% at R92,3m Lower borrowings and declining interest rates trimmed the finance charge 27% to R1,1m

An 18% fall in the tax charge is the result of a lower effective tax rate on increased profits Behind the number, says chairman Sarel Germishuizen, is an agreement with the Receiver on plantation and farming interests As such, he says, it is in no way related to the year's profits

The balance sheet continues to improve Total debt declined 36% to R3,6m and gearing almost halved to 45% Cash flow improved substantially, funds generated by operating activities amounted to R3,2m in 1994 (1993. R142 000 deficit)

The sectoral breakdown reveals the biggest gain in turnover came from new vehicle sales, at 41% (33%) of the total Despite

Vaaltrucar

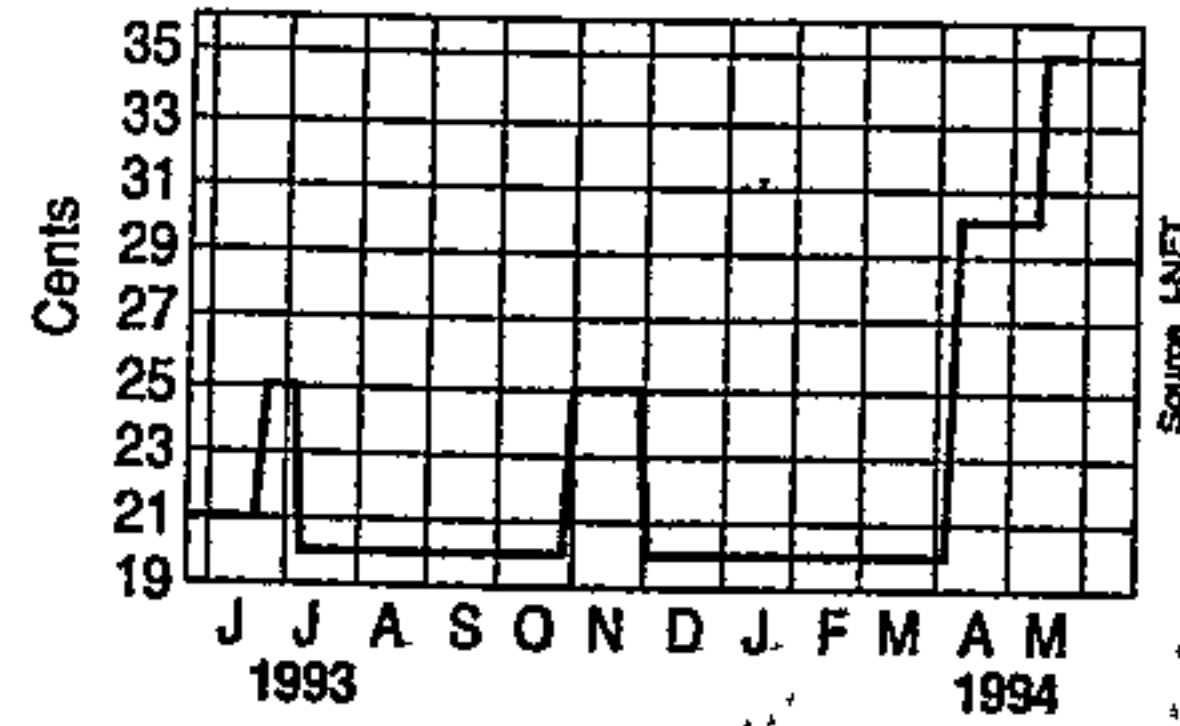

Fm 31/6/94
 accounting for 15% of assets employed, the contribution to sales of used vehicles fell from 30% to 23%, weaker demand was felt even more strongly at operating level, where the contribution fell from 43% to 23%

Service and petrol, by far the smallest operation in terms of assets employed, made a significant contribution to operating income By far the bulk of assets, around R3m, are in property, whose real return is realised only on disposal

Germishuizen says there has been a noticeable uptick in trade since the election, which bodes well for this year Management conservatively forecasts maintained earnings (192)

The share at 30c is just off its annual high, though still at a discount to NAV Fully rationalised and streamlined, it is well placed to benefit from improved business confidence

Marylou Greig

SA's BMWs for world markets

BMW SA will start exporting its cars early next year.

By DON ROBERTSON

The German parent has given its approval for the move because its SA subsidiary's vehicles meet its own high standards.

About 1 000 3 Series cars will be exported to south and south-east Asia, initially in right-hand drive, but eventually in left-hand drive as well. The plan is to build up exports to between 5 000 and 6 000 within four to five years.

BMW will become the first, by far, of SA manufacturers to meet recommendations of the government-appointed Motor Industry Task Group (MITG), which among other proposals, requires that the industry become globally competitive and that exports be increased.

About R110-million has already been spent at BMW's Rosslyn production plant to upgrade facilities and a further R40-million to R50-million will be required

next year for the final touches.

BMW is the largest SA exporter in the industry and sales this year are expected to rise to about R650-million compared with the forecast industry total of about R1,8-billion.

The SA operation is the largest supplier of leather seats to the BMW world market and is the only manufacturer of BMW cars outside Germany. A second world manufacturing plant will open in America next year and a third is being considered in Mexico.

"Our move into the world market is a healthy process and something we have to do if we are to survive in the long term. We cannot rely on protection forever," says managing director Rainer Hagemann.

It will, however, not be an easy process.

"Our product costs about R10 000 more than the Ger-

man car a year ago. We have brought this down to about R5 000 and we hope to reduce the difference further. The cost of transporting cars to Europe would further reduce our competitive edge, hence the decision to sell to Asia, where transport costs are at about a break-even level," says Mr Hagemann.

It is hoped that the cost of local components will also be stabilised. BMW has spoken to suppliers and has asked them to keep prices down. This can be achieved if volumes are increased through exports.

"We have shown them how German component manufacturers have kept costs down. Some have come over, others have not. If they are unable to meet our demands, we import the components," says Mr Hagemann.

Labour costs more in Germany than in SA, but the lower cost of components far outweighs this benefit, he says.

The export of compo-

nents from SA for inclusion in German vehicles has caused no problems in the past, but the export of fully built-up cars is a another matter.

"The perception is that SA is at the bottom of the line in car production. We have researched this and we hope to overcome it as we have in the case of leather seats. Auditors come over from Germany every four to six weeks to check our quality standards. We also hope to be given the internationally accepted ISO9000 quality standard rating in July," according to Mr Hagemann. (192)

"We will also have to prove that we can deliver, and on time."

Also in line with MITG proposals, 7 Series production will be discontinued towards the end of the year. The new 7 Series will then be imported in fully built-up form. The 5 Series will be run out next year.

This is in line with plans to stop the production of low-volume models

Motor strike: Eastern Cape split over worker walk-out

Art 6/8/94

192

TO most white workers the motor strike is a "black communist plot" designed to bring white business to its knees and a portent of things to come. White workers who have never been involved in any form of strike action find it incomprehensible that people are giggling about salaries when many people are desperately seeking jobs and the Eastern Cape is just starting to emerge from a four-year recession.

Many coloured workers feel the same way. So do blacks who are unemployed and desperate for work.

For the workers it is a difficult time. They know that those most likely to suffer are their families. Yet they believe firmly that important gains, promised to them in a post-apartheid South Africa, are at stake.

They are deeply committed to seeing through any action which will lead to better opportunities for them and their children.

But coming close on the heels of the Pick'n Pay strike — during which shoppers witnessed strikers urinating on fruit and vegetables and a woman carried a placard saying "we are not against the Jewish religion" (when approached she did not know what it meant) — to most people the strike is a threat.

It is something which is going to bring the economy to its knees. Something which is going to spread, with more and more workers demanding fat increases. The

■ In what was once known as the Detroit of South Africa the strike in the motor manufacturing industry, which has already cost R770 million in lost turnover, is an emotive subject. A report by Weekend Argus correspondent **PAT CANDIDO** in Port Elizabeth.

component manufacturers are already warning of retrenchments and short time, which could cost millions. Organised commerce and industry warn that the strikes are not contributing to the reconstruction and development programme.

In other words, few people have anything nice to say about the strikes or strikers.

Martheanne Fimmemore, deputy director of the industrial relations unit at the University of Port Elizabeth, said she was fully aware of the very negative effect the strike was having on attitudes and race relations.

But she pointed out the issue was far more complex and could not be dealt with in simplistic terms by people who did not have the full facts.

She said the strike was a post-election industrial problem. "Before the election many businesses thought things would continue in much the same way it did in the past.

"Workers believed things would change and old apartheid obstacles and practices would be removed. Workers are extremely

aware of the disparities from the apartheid system.

"As an informed observer, one sees the reality of the situation and it is easy for me to see the problems on both sides and the real grievances."

She said it was also easy for people caught up in a group, in solidarity with each other, to take risky decisions. The media supplied snippets of information and not the real nitty-gritty, so that people saw strikers toy-toying and just "being difficult and demanding".

On the other hand, managers often did not understand the realities of the situation and still had to learn it was a post-apartheid South Africa. But while the consensus was that the strikes were unnecessary, a disaster for the economy and a foretaste of things to come, there was a serious intent on the part of Numsa officials who are deeply aware of the often hurtful criticism aimed at them.

"If I had to worry about all the things being said about me, I would not sleep at night," said Numsa official Gavin Hartford.

"As it is I have hardly had any sleep anyway. I know people see the strike simply as something breaking down the fragile economy. But we have 250 hours of negotiations and have covered important ground which is very constructive for the future viability of the industry.

"We have certainly made progress but have come unstuck on the wage issue. We have to meet the needs and expectations of our members."

"Most of the motor industries have a global infrastructure and know about strikes. Worldwide, the motor industry is going through major changes and a recession. It is only the companies which have made major changes with high levels of education and pay which are going to survive."

"In dollars, a South African earns four dollars compared to 25 dollars in the States for the same job."

"About 80 percent of our workers are illiterate and there is a desperate need for a massive upgrading programme."

"Equipment in the industry here is about 30 years behind the times. I have been called all kinds of names but there are very sensitive and real issues being discussed here. We are not doing this for fun."

Manufacturers have estimated that the strike, which started on Monday, costs the industry more than R110 million a day and there are genuine fears that the component industry could soon become involved.

Extraneous factors fudging car sales

Star 9/6/94

■ BY JOHN SPIRA

Extraneous factors are fudging car sales statistics and making them a less reliable economic indicator than usual

May car sales, at 14 394 units, showed a fall of 1 106 (7,1 percent), compared with May 1993. The figure was a modest 361 units (2,6 percent) up on April sales.

The data should be viewed against the background of public holidays in April and May and the industrial action various makers faced.

The National Association of Automobile Manufacturers (Naamsa) says abnormally low inventories dominate the car and light commercial vehicle markets.

Improving economic fundamentals, rising post-election business and consumer confidence and an expected upturn should underpin demand in the months ahead.

"However, it is imperative that counter-productive, unprocedural action, which most manufacturers have experienced in recent weeks, should

end."

Brand Pretorius, MD of Toyota SA Marketing, calculates May sales raised the year-to-date total to 76 056 units — 3,4 percent down on the 1993 period (192).

"The supply situation must improve substantially and quickly if the industry is to show any real growth.

"Sales for May represent an accurate assessment of the industry's ability to supply under the restraints imposed by labour instability."

Although demand was reasonably strong, there was a large element of "double counting" in the car order bank, with customers duplicating orders to bring delivery dates forward.

He expects demand to peak in June, but the upturn might not be as pronounced as some believe.

Stephanus Loubser, MD of Nissan SA Marketing, says "The industry's performance was disappointing, given the underlying recovery of the economy and the generally good news on the political front."

Star 10/6/94
Farmers buy more tractors despite fears

There has been a revival in tractor sales, according to the SA Agricultural Machinery Association

This was despite uncertainties surrounding the election period, the maize price and the new po-

litical dispensation, chairman Gerrie de Jong said yesterday

"Tractor sales in May were almost 60 percent higher than for the same month last year," he said — Pretoria Bureau

(192)

Bumper crop boosts tractor sales

TRACTOR sales in May soared 60% above last year's level to 317 units, the SA Agricultural Machinery Association (Saama) said yesterday.

Sales of 1 404 units during the first five months of the year were almost 50% up on the same period in 1993.

Saama said forecasts for total tractor sales for 1994 ranged between 4 200 and 4 500 units, about 40% higher than total tractor sales for 1993.

Econometrix economist Tony Twine said this year's bumper maize crop was behind the upswing. He said the two very good years for agriculture had also pushed up sales of medium and heavy trucks.

MUNGO SOGGOT

Medium truck sales were up 68% on the previous year, and heavy truck sales rose almost 40% ~~1016/194~~

Ford tractor operations director Aubrey Gouws said the rise in sales could have been even higher if manufacturers had been in a better supply position. (192)

"We couldn't supply our order book for one single month this year."

Gouws said the maize harvest had been the second largest yet, and many farmers had replaced their tractors — which had an average age of 12 years.

Car prices jump by 75%

By PETER DENNEHY

NEW car prices have rocketed over the past three years by an average of 75% — and buyers are having to downgrade their choices to more affordable models

A Cape Times survey of a dozen new vehicle prices now and three years ago indicated the 75% price rise on average

Manufacturers said this figure was too high, but explained the shocking increases by saying the value of the rand had slid against that of the Japanese yen and the German mark

Mr Nico Vermeulen, director of the National Association of Automobile Manufacturers of SA, said that in 1991, the average increase was 29%, including the change-over to tax-inclusive prices. The following year, the average increase had been 11%, and last year it had been 15%.

Meanwhile, VAT had risen from 10% to 14%. So if one added

12% hike expected this year

the 29%, 11%, 15% and 4%, one was already at 59% without taking into account the effects of compounding the increases

This year, it seemed that new car prices would increase about 12%, Mr Vermeulen said

Mr Ray Nethercott, chairman of the National Automobile Dealers' Association, confirmed that some models of cars had undergone price increases of over 70% in three years. He blamed the slide in the value of the rand against other currencies. The rand had depreciated 60% against the Japanese yen in the

25/11/94 (192) ~~1994~~

past three years, for example

Even the cheapest cars have risen sharply in price since 1991. The Uno 1100 Fire rose over three years from R20 755 to R33 336 — a 61% hike

The situation is similar higher up in the market. Cape Times files show that bottom-of-the-range new BMW and Mercedes Benz cars cost R44 660 and R99 965 three years ago, compared with R89 700 and R162 563 respectively now — 101% and 62% up respectively

Growth

Mr Nethercott said that the escalation in prices had forced a buy-down — “those who used to buy more expensive cars now go for something cheaper”

Apart from the buy-down, the price rises had caused the total market to shrink. However, there would be year-on-year growth in new vehicle sales even by the end of this year, because the economy was expected to grow, he said

Motor industry production lost 'is not recoverable'

8/Day

13/6/94

THE huge production losses suffered by motor manufacturers over the past six months through output disruption would never be recovered, industry sources said at the weekend

Industry analysts said it would be difficult if not impossible to make up the losses, which are estimated at more than R800m

The National Bargaining Forum — the industry's annual wage talks with the unions — complicated matters further with the possibility of an overtime ban during negotiations

Although bargaining should be resolved by the end of this month, past experience had shown that negotiations tended to drag on "into the next month or two"

The analysts pointed out that sales were down on the year to date because of supply shortages. Although there was some market buoyancy it was not strong enough to support extra sales, even if the losses were made up

Toyota, Nissan, VW, BMW and Delta all reported lost production, which was hampering supplies to dealer networks

The National Association of Automobile Manufacturers of SA (Naamsa) said lost production had cost the industry 15 500 units or 5,5% of the estimated 295 000 new car and light commercial vehicles which were expected to be sold this year

VW, which has been hard hit by industrial

MICK COLLINS

disruption, said it was unlikely the industry would ever recover the total units lost since the beginning of the year

Regarding more recent stoppages, VW had put together a plan for this month to catch up, including overtime and weekend production

But some manufacturers said losses could be made up. Toyota executive chairman Bert Wessels said if the company got co-operation from the unions it would be able to make up the shortfall in two to three months

However, during past bargaining forums the unions had been known to withdraw all overtime. The company had received no commitment from the unions to make up for days lost over the election period "and we are still experiencing sporadic industrial action"

Nissan marketing director John Jessup said there was a backlog which "we will endeavour to catch up as much as possible". Since the elections, relations had been smooth, apart from a few minor disruptions which were not as severe as those experienced in the second half of last year

BMW had lost between 800 and 1 000 units during the Bophuthatswana uprising but the company had introduced a "catch-up programme" which would see production back to normal by the end of July

'Overhaul' for truck sector

THE heavy truck sector was likely to face a major overhaul when the second motor industry task group report on the local vehicle manufacturing industry was released, sources said yesterday.

They said if the first report by the task group was anything to go by, the heavy duty truck sector was in for "radical adjustments".

Task group chairman Derek Riley said the second report would be ready for release by August.

He said the report was likely to contain significant changes to the structure of the local heavy duty vehicle industry.

But he refused to be drawn on its contents, saying the majority view had not yet been ascertained "but there will certainly be recommended changes which government will have to decide whether or not to accept".

Meanwhile, a final proposal on the first part of the group's report on cars and light delivery vehicles was still some way down the track, the Board on Tariffs and Trade said (192).

Board member Daan Bosman said until all submissions from the parties concerned had been tendered, the board would have to bide its time.

The group's original report had been handed over to the board by

MICK COLLINS

government and the final report would be submitted to Trade and Industry Minister Trevor Manuel.

But industry sources said the deadline, which was set for last Friday, had been "informally" extended.

National Association of Automotive Component and Allied Manufacturers executive director Denzil Vermooten said "the final draft is expected to be implemented by July 1995".

Analysts said the task group's recommendations would be tough on most manufacturers because the extent to which they would be able to import components duty-free would be determined by each plant's achievement of minimum production volumes per model, and its ability to export.

The report recommended that a new tariff-based development programme be in place by July 1995.

It was aimed at eliminating many local car models which some analysts said could lead to a drop in the number of manufacturers.

It was highly critical of vehicle prices and the number of models in production.

Star 15/6/94

Dismissed 70 want jobs back

East London — Police arrested 70 former Mercedes-Benz of South Africa (MBSA) employees at the plant last night after they had forced their way into the factory. The group demanded to be re-employed.

They are to be charged with trespassing, and will appear in court today or tomorrow.

This follows an MBSA deci-

sion, taken after urgent consultation with its parent company in Germany, to lay a formal complaint against all protesters.

A group of former employees, believed to be the same people arrested last night, were detained three weeks ago after occupying the company's administration block for four days.

They were evicted after MBSA

obtained a Supreme Court interdict against them, but were released when the company decided not to press charges (192).

MBSA spokesman Shane Hegarty said the company would not reinstate the dismissed workers, and urged them to reconsider a previous MBSA offer of a R1 million training and job creation programme — Sapa.

MOTOR INDUSTRY
Competing at the top end

Luxury car manufacturers see signs of renewed buoyancy at the top-priced end of the car market. Some analysts say the appearance of new imports is helping to stimulate buyer interest.

Luxury cars have been hurt by huge price increases that have beset the car market since the mid-Eighties. The buying-down trend towards cheaper models has resulted in the luxury segment occupying only a fraction of the overall market.

Yet companies say the luxury market has bottomed out now and, though they don't expect it to attain previous heights, they are optimistic.

Audi, which claims 29% of the market for cars in the R140 000-R200 000 price bracket, confirms that luxury sales are up this year. BMW says the sector is exceeding expectations, adding that, as with smaller vehicles, production disruptions have created stock shortages and sales figures don't necessarily reflect demand.

Established local luxury car makers Audi, BMW and Mercedes-Benz are increasingly facing challenges from a variety of new luxury imports. Toyota's top-of-the-range Lexus is already established as a limited-volume import and now Nissan has just launched its flagship Infiniti sedan in SA. Volvo and others are also trying to carve niches.

The arrival of another Nissan imported newcomer, the four-wheel-drive Patrol station wagon, highlights the growing choice available to buyers with cash to spare. At R220 000, the Patrol joins a burgeoning list of top-line, off-road models, including the Mitsubishi Pajero, Isuzu Trooper, Land-Rover Discovery, Toyota Landcruiser and Ford Explorer.

Audi, itself considering importing the Avant estate car to SA, says the appearance of imports, though in small numbers, is add-

ing to pressures in an already overtraded market.

But BMW says the new arrivals are to be welcomed and that existing luxury car makers aren't losing out. "We believe this is stimulating the overall market rather than taking a bite out of the existing cake. This proves that competition is generally good for business."

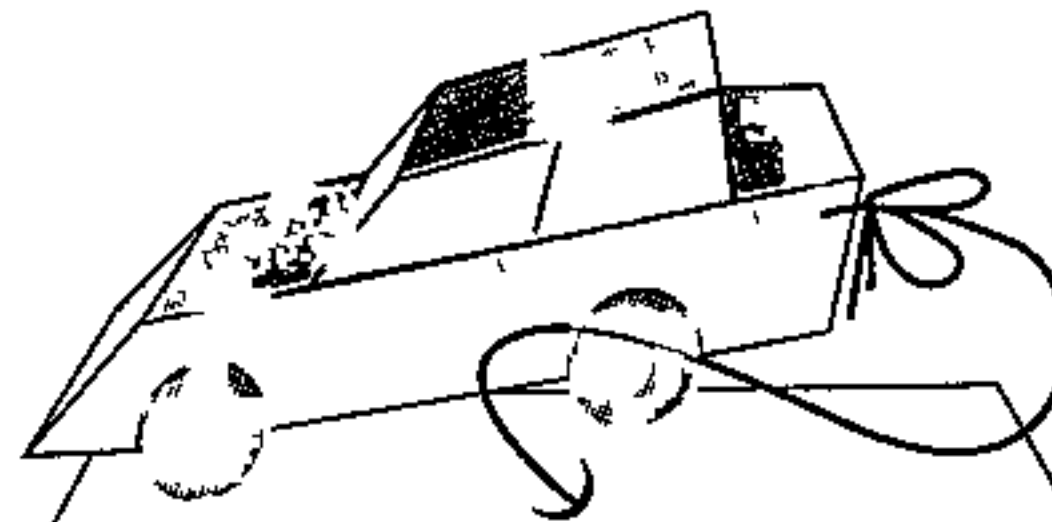

May vehicle sales

Cars	Total	%*
Corolla /Conquest 2 211, Camry 1 160, other 5		23,5
Golf /Jetta (new) 1 306, Citi/ Fox 1 124, Golf /Jetta (old) 69, Audi 133		18,3
Sentra 1 264, Maxima 81, 200SX/300ZX 11, Fiat Uno 953		16,0
Ford Laser/ Meteor 403, Telstar 305, Mazda 323 657, Mazda 626 448, Mitsubishi Pajero 62		13,0
Astra/Kadett 1 486, Monza/ Kadett 137, Rekord 44, Calibra 3		11,6
Honda Ballade 1 101, M-Benz W124 264, W140 40, other 1		9,8
3-Series 962, 5-Series 145, 7-Series 17		7,8
Subaru Legacy2		0,0

*% of the total car market

	1994	1993	% Change
May	14 394	15 500	-7,1
Jan - May	76 056	78 693	-3,4
April (14 033) - May			+2,6

Light commercials
 Toyota 2 509 (31,6% of the market), Nissan 1 947 (24,5), Samcor 1 698 (21,4), Delta 1 383 (17,4), VW 374 (4,7), AAD 36 (0,5)

May	7 947	7 565	+5,0
Jan - May	39 321	39 550	-0,6
April (7 052) - May			+12,7

Medium commercials
 Toyota 99 (33,7%), Delta 78 (26,5), Samcor 77 (26,2), Nissan 30 (10,2), M-Benz 10 (3,4)

May	294	179	+64,2
Jan - May	1 257	1 201	+4,7
April (175) - May			+68

Heavy commercials
 M-Benz 211 (46,9%), Toyota 88 (19,6), Nissan 44 (9,8), Delta 36 (8), MAN 33 (7,3), Tyco 21 (4,7), ERF 10 (2,2), Iveco 7 (1,6)

May	450	376	+19,7
Jan - May	1 928	1 993	-3,3
April (354) - May			+27,1

Total vehicle sales
 Toyota 6 072 (26,3%), Nissan 4 330 (18,8), Samcor 3 650 (15,8), Delta 3 167 (13,7), VW 3 006 (13,0), M-Benz 1 627 (7,0), BMW 1 124 (4,9), other 109 (0,5)

May	23 085	23 620	-2,3
Jan - May	118 562	121 437	-2,4
April (21 614) - May			+6,8

Fun 17/6/94

192

VW's Citi gets plenty mileage

THE sales success of the Citi Golf, which has dominated the SA hatchback market since its "re-launch" in 1984, continues unabated.

The Citi Golf celebrated its 10th anniversary last week, when a new upmarket model, the Ritz, was launched.

In May, it held a 7,8% share of the total passenger car market, taking its total slice of sales to 8,4% in the first five months of the year. In the period to April, it had a 29,2% share of the hatchback market, followed by Uno with 18,1% and the Conquest with 15,8%. Its own big brother, the third generation Golf 3, had only 9,9% of the market.

The Golf, seen as the natural successor to the Beetle, was introduced to the SA market in May 1978. From then until it was "run out" in 1984, sales of the original Golf numbered 133 319. Since then, re-launched Citi Golf sales have reached 106 249.

South Africa is the only country in the world still producing this "old" model and, although the company

will not give details, it is understood that local content is well above 90%.

When the new Jumbo Golf was introduced in 1984, Volkswagen realised that it no longer had a model in the small, city-type market

The Citi Golf was consequently "re-launched" as a cheap 1,3l model with the "red, yellow, blue" slogan that became one of the most successful advertising campaigns in the motor industry, says marketing director Graham Hardy.

It then cost R7 630 Today, with modifications over the years, it costs R37 740

The car had a "life of its own", according to a Volkswagen spokesman. In 1985, the Citi 1600 came to the market, followed in 1988 by the 1800 Sport Six years later, the fuel-injected Citi made its debut. During those years, the Citi Golf was apparently unphased by the launch of the second generation Golf 2 and then the Golf 3 in November 1992

By DON ROBERTSON



SITTING PRETTY . marketing director Graham Hardy with Volkswagen's long-distance runner

ation sees little movement of the north



Govt urged to unshackle motor industry

■ BUSINESS STAFF

The constraints shackling growth in the motor industry need to be urgently reviewed and, where necessary, lifted

This is the plea to the Government by Theo Swart, chairman of McCarthy Motor Holdings, who believes deposits on HP/installment credit sales should be abolished and that private leasing should be introduced as soon as possible

His views are supported by Toyota, one of the largest local manufacturers, and the National Au-

tomobile Dealers Association.

Swart
"If the Government were to take just these two steps, national sales of new and used cars would be boosted by in excess of R1 billion a year (192)

"In the process, thousands of much-needed jobs would be created — not only in the motor manufacturing/assembly industry, but also in the vehicle distribution/maintenance sector, the banks and other associated branches of commerce and industry," says Swart

At the same time, the

Government would collect more revenue by way of VAT and other taxes.

Swart contends that the immediate impact of lifting the two restrictions would be to improve new and used car sales by five and 15 percent respectively 2116194

"It is time the banks be given the discretion as to who is creditworthy enough to buy a car without a deposit and who should be asked to pay a deposit — and how much.

"In the US, private leasing now accounts for 25 to 35 percent of cars sold nationally"

Govt urged to re-introduce private leasing

(192)

CF 21/6/74

Business Editor

CARs also would mean that more jobs would be created and the government would collect more in tax if deposit or hire purchase sale were abolished and private leasing re-introduced. A leading figure in the industry

lower than expected. In the first five months of 1974, car manufacturers reported that they may be required to trim production year on year. The reason for this is in the second half

sales fell short of the 70,000 at the end of May compared with 72,000 in the first five months of 1973.

The National Automobile Dealers Association (NADA) and the South African Association of Automobile Manufacturers (SAAAM) have prepared an official report to encourage the introduction of private leasing structures. The report highlights the need to encourage the car industry

NADA estimates that private leasing could be counted for between 20 and 25 per cent of sales in the 1970s.

Theo Swart, chairman of the Motor Holdings - which has 13 per cent

of the dealer market for cars - said the 10 per cent minimum deposit requirement should be lifted on the whole of the passenger car market for 1974.

He also urged the government to consider the need for a deposit and allow a 10 per cent minimum deposit for hire purchase sale by 1975 and a 5 per cent by 1976.

Step by step

If the government were to take the step by step method of reducing deposit requirements, it could be achieved by well over 100,000 cars.

In the process of introducing private leasing, jobs could be created not only in the motor manufacturing and assembly sector but also in the vehicle distribution and maintenance sectors and a related machine structure and industry.

At the same time the government would collect a minimum additional revenue by means of VAT and other taxes.

To the Motor Holdings, the introduction of these measures would not only make car financing more viable for South Africans but, by stimulating demand, create economies of scale which would make the country more competitive in export markets.

Motor trade plan for R1-bn sales boost

192
ARG 22/6/94

BRUCE CAMERON
Business Editor

CAR sales could be boosted by R1 billion a year if the government eased financing restrictions on the industry

This is the view of McCarthy Motor Holdings chairman Theo Swart

Mr Swart said the new government should urgently review and lift some of the constraints that are stifling growth in the motor industry

He said deposits on HP/installment credit sales should be abolished and private leasing should be reintroduced as soon as possible

"If the government were to take just these two steps, national sales of new and used cars would be boosted by well over R1 billion a year

"And, in the process, thousands of much-needed jobs would be created — not only in the motor manufacturing/assembly industry but also in the vehicle distribution/maintenance sector, the banks and other associated

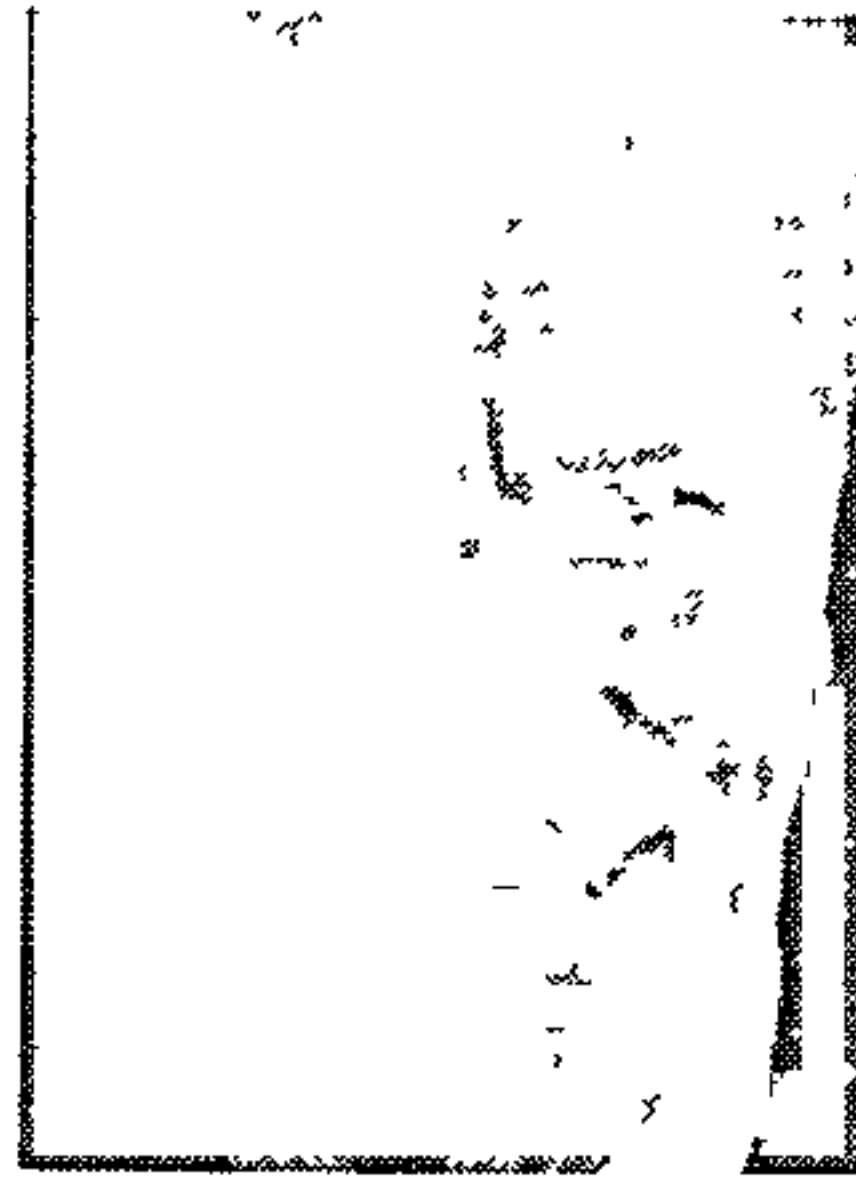

Theo Swart

branches of commerce and industry

"At the same time, the government would collect significant additional revenue by way of VAT and other forms of tax"

Mr Swart said he could not think of one good reason why deposits on instalment sales should persist and why private leasing — which was once in force — should continue to be withheld from the cash-strapped person in the street

The immediate impact of lifting these two constraints/restrictions would be to improve new car sales by five percent and used car sales by 15 percent

Mr Swart said the 10 percent minimum deposit required on instalment sales has been the Achilles heel of the passenger car market for far too long

"It is time that banks be given the discretion as to who is creditworthy enough to buy a car without a deposit and who should be asked to pay a deposit — and how much"

He said his company recently took a random sample of 50 ordinary credit customers off the database off a sister retail company

"Virtually all 50 were creditworthy enough to buy a car — yet only a few had the capacity to put up the deposit"

Mr Swart said in the United States today private leasing was the fastest growing aspect of car purchasing — accounting for between 25 and 35 percent of cars sold nationally

Vehicle exhaust industry probe

CT 23/6/94

From MICK COLLINS

192

298

JOHANNESBURG — The Competition Board is to launch a formal investigation into the vehicle exhaust industry, following the recent tie-up between the sector's top two companies

Outlets trading as Fastfit, Kwikfit, Mr Xhaust Mr Tyre, Sonic and Speedy Exhaust Services were involved in the investigation, board chairman Pierre Brooks said

The investigation was prompted by the board's discovery that SA's largest manufacturer of exhaust systems had entered into an agreement with the second largest producer

Brooks said Bosal holding company the Emerian Corporation had entered into negotiations with Longmile Ltd, the holding company of Grapnel, in terms of which Emerian would acquire Longmile's exhaust system, exhaust pipe and towbar business

Both companies were also involved in the retail fitment side of the R60m-a-year market. It was alleged that the companies controlled about 75% of the market, which constitutes the major portion of the after-market fitment of exhaust systems

Fm 24/6/97

Activities: Warehousing, distribution and marketing of automotive products

Control: McCarthy Retail 80%

Chairman: T Rosenberg, MD S J de Vos

Capital structure: 14.9m ords Market capitalisation R89.5m

Share market: Price 590c Yields 2.7% on dividend, 10.9% on earnings, p e ratio, 9.2, cover, 4 12-month high, 600c, low, 180c Trading volume last quarter, 1.6m shares

Year to February 28	'91	'92	'93	'94
ST debt (Rm)	24.6	31.3	18.0	14.0
LT debt (Rm)	—	2.0	1.6	0.6
Debt equity ratio	0.45	0.48	0.46	0.32
Shareholders' interest	0.58	0.54	0.47	0.53
Int & leasing cover	1.6	1.8	1.0	4.2
Return on cap (%)	11.3	13.6	5.8	13.3
Turnover (Rm)	242	284	293	252
Pre-int profit (Rm)	10.6	15.8	5.1	11.7
Pre-int margin (%)	4.4	4.6	0.6	3.0
Earnings (c)	31.5	60.7	(16.9)	64.3
Dividends (c)	8.5	16	nil	16
Tangible NAV (c)	366	393	285	314

sumed dividend — to 1992 levels Essentially, Midas is again the business it used to be about five years ago before some unwise diversification got it into trouble

What went wrong? Sarel de Vos, who took over as MD at the beginning of last year, says Midas diversified into businesses which appeared to be allied but proved otherwise De Vos and deputy MD André Dry set about selling or closing the bleeders In the 1994 annual report, this shows in R54m turnover representing discontinued operations

Some of the discarded businesses, such as suppliers to mass merchandisers Champion Chain and Hyperquip, were clearly a departure from the core Others, including Kawasaki, appeared to have more synergy De Vos says that even though the former motorcycle division was a good business, "about the only synergy was that the products also had wheels" (192)

Most of the costs associated with rationalisation — which in effect reduced the business from four to two divisions, or as De Vos quips from a four- to a two-stroke operation — were absorbed last year Now profitability has been restored, backed by a stronger balance sheet Debt is down, which, with streamlined inventory control, has nearly halved interest payments to R2.9m

Staff has been cut from 950 in 1992 to 641 De Vos says morale and commitment is high though

With dividend payments resumed, four times cover is the highest in seven years Sharpening the focus has gone beyond

Midas

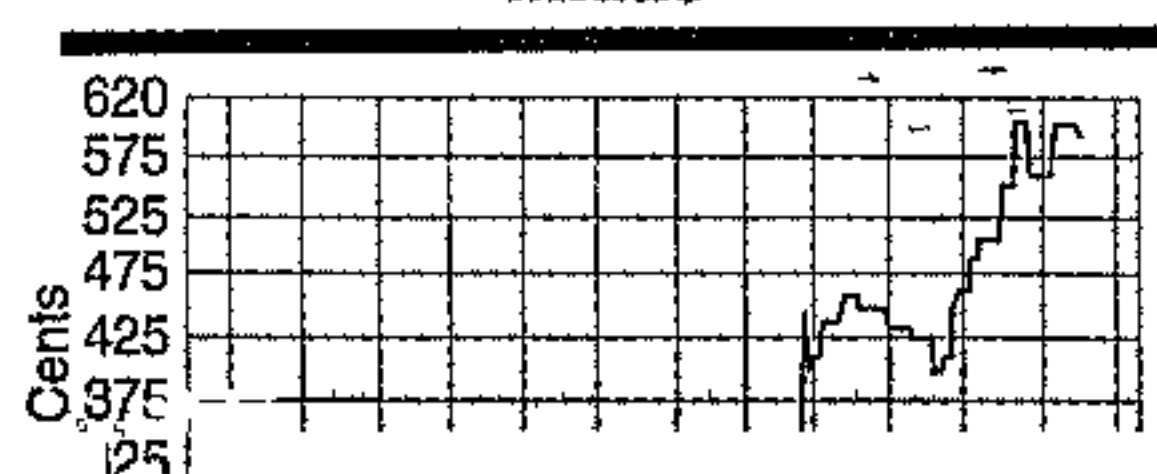

Fm 24/6/94



Midas's De Vos looking at what the market wants

getting rid of poor performers Dry says functions where Midas does not have expertise such as information technology have been sourced out — in this case to main shareholder McCarthy Retail

"This business is all about controlling working capital We are concentrating on stock, debtors and creditors," says Dry

To ensure real growth is kept up, Midas has been working with consultants De Vos says the group is becoming more market driven "We used to get a product and build a market around it Now we look at what the market wants" (192)

Franchise operations form an important part There are about 280 outlets — among the highest number of franchises in SA (*Business* June 10) They performed satisfactorily in the 1993 crunch year but, says De Vos, can be improved For example, he believes that, as a franchise organisation, Midas is not getting the full benefit of collective buying power

De Vos says Midas' primary long-term goal is to create wealth for shareholders Turnover will remain under pressure, largely from shrinking margins and competition in distribution "In the Eighties, turnover growth was fuelled by high inflation We don't see that being repeated, instead, we will have to improve efficiencies in the distribution channel," he says Though turnover will remain under pressure, he is confident of real growth in earnings

The share has appreciated strongly since Midas returned to profitability, trading at more than double the price when the 1993 annual report was reviewed The first cautionary in February, which led to McCarthy Retail's four-for-five offer to minorities (raising its stake from 36% to 80%), appears to have added impetus

Share price gains will probably slow down Yet a p e ratio of 9.3 is cheap relative to the sector There seems to be little doubt that Midas will be able to sustain its return to earnings growth and there's probably still considerable value in the share *Shaun Harris*

MIDAS Fm 24/6/94

Back to its roots (192)

Midas, which is involved in most aspects of the automotive parts business, flies a long row of new SA flags outside its head office in Midrand It's hard to resist seeing the flags as a symbol of the group's transition

A year ago, Midas appeared to be heading for disaster Corrective action was in place but could not stop the interim's negative EPS of 14.3c sliding to 16.9c by year-end Now the benefits of a strict cost-cutting and refocusing programme are starting to come through, boosting earnings — and the re-

COMPANIES

Fm 24/6/94

Activities: Operates in the retail motor vehicle industry through six franchises

Control: Directors 72,7%

Chairman & MD: M Zimmerman

Capital structure: 19m ords Market capitalisation R39m

Share market: Price 205c Yields 5,9% on dividend 15,9% on earnings, p/e ratio, 6,3, cover, 2,7 12-month high, 780c, low, 70c Trading volume last quarter, 485 000 shares

Year to February 28	'91	'92	'93	'94
ST debt (Rm)	2,3	7,3	11,0	9,1
Debt equity ratio	nil	0,28	0,34	0,23
Shareholders' interest	0,40	0,36	0,37	0,35
Int & leasing cover	4,3	2,9	2,7	2,7
Return on cap (%)	16,3	11,5	11,8	13,0
Turnover (Rm)	367	416	555	698
Pre-int profit (Rm)	10,9	9,1	10,6	15,0
Pre-int margin (%)	3,0	2,2	1,9	2,2
Earnings (c)	22,9	19,4	23,2	32,5
Dividends (c)	10,7	9,3	9,3	12,0
Tangible NAV (c)	139	149	176	213

creased violence, work stoppages and the uncertain political climate dampened spending and curtailed earnings growth for the traditionally better second half

Nonetheless, a particularly pleasing aspect is the increase in the year-end ratio of operating profit to turnover to 2,2% (1993 1,9%) Chairman and MD Maldwyn Zimmerman argues that this important ratio, which has declined in the group and in the industry in recent years, is a sign of the tough and competitive conditions faced by the motor sector

(192)

Combined Motor

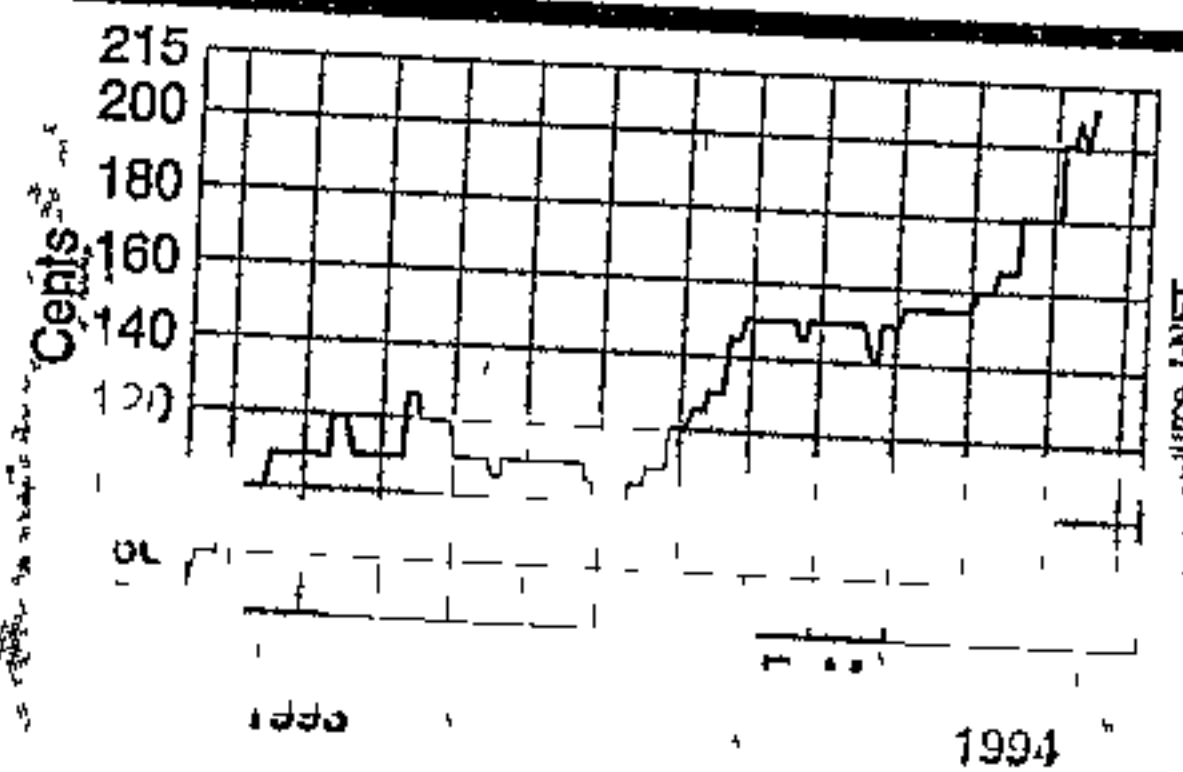

The industry produced sales of 194 500 cars in 1993, an upturn of 6% Not bad, considering it would take 10,7 months of average gross earnings for an employee in the transport equipment manufacturing industry to buy the cheapest car available in SA — between two and four times higher than that needed in countries such as Germany, Japan and the UK

CMH's 38% increase in interest paid was largely attributable to the acquisition in July of a new dealership serving Alberton and Germiston as well as the inevitably higher cost of financing stock

In March, the group entered the imported vehicle market, signing an agreement with Sweden's Volvo Cars International to import cars These will be made and assembled entirely by Volvo Europe but full parts and service will be provided locally Initial sales targets have not been set so the effect on CMH's earnings for this year is unclear

Though the counter is on a 180c annual

COMBINED MOTOR HOLDINGS
Fm 24/6/94
Bumpy driving

Combined Motor Holdings (CMH) achieved the (almost) impossible in 1994 Trading in the depressed motor industry, it lifted EPS by 40% to 32,5c (192)

Attributable earnings closely mirrored the changing political outlook Growth was experienced during the first nine months, when there was some optimism and political stability The interim report showed earnings rising 34% and this trend continued through the third quarter of the financial year In-

Fm 24/6/94
high, its 5,5 p/e is almost half the average for the motor sector More than 70% of the equity is held by the directors, so tradeability of an otherwise attractive stock is limited
Kate Rushion
(192)

BMW SA scoops Land Rover deal

CT 28/6/94 (192)

From BOB KERNOHAN

AN IMPORTANT new international link is to be forged between a SA manufacturer of luxury cars and a major European vehicle-maker, it was revealed last night.

But details of the link between BMW SA, in Pretoria, and the Rover Group in Britain were scant.

The news was disclosed in an announcement by the local distributors of the successful Land Rover models, AAD in Johannesburg, that it was losing its business from the British company.

AAD said it had been advised by Rover International "that it proposes to enter into an alliance with BMW SA following the acquisition of the UK's Rover Group by BMW AG in Germany.

"In consequence, the Land Rover distribution agreement between Rover International and AAD will fall away on November 30, 1994."

Rover — previously Levland —

had manufacturing operations in South Africa, including its own plant in Cape Town in the 1970s, and later sub-contracted to Sigma (now Samcor) in Pretoria for the assembly of its Rover model.

But the cars were withdrawn in the early 1980s, and SA's only remaining link with the once-famous but often-troubled British group was through the import by AAD of Land Rovers and the more upmarket Range Rovers.

BMW in Germany took over the British company last year in a shock move, as Rover had been expected to link up internationally with Honda of Japan.

BMW SA spokesmen could not be contacted after the announcement was made late last night.

But the new link could prove an important one to BMW SA, both in terms of local product and African distribution rights.

Most local major manufacturers have expensively priced and profitable four-wheel drive pickups, which are accounting for more sales in the commercial

vehicle market, both as workhorses in off-road conditions and as recreational vehicles.

BMW will be guaranteed overall incremental volumes.

Also, with SA now politically acceptable, BMW in Pretoria could become an important link in the distribution of Land Rovers throughout the African continent. Land Rovers are widely used in Africa, particularly in former British colonies.

BMW also recently announced it had been awarded a major export contract by BMW International.

AAD chairman and CE Roman Szymonowicz said last night Rover International had assured the company the step was not related to AAD's performance, "as we have grown the marque to the point where record volumes are being achieved".

AAD would now concentrate on new product opportunities — a number of which were "close to fruition" — to compensate for the loss of Land Rover, he said.

TRACTOR SALES

Ploughing ahead

117194
With tractor sales expected to jump 40% above last year's total, the highly competitive industry's confidence level is returning to pre-drought levels. May tractor sales, at 317 units, were almost 50% higher than the previous May and the SA Agricultural Machinery Association forecasts this year's sales to range from 4 200 to 4 500 units. The major factor? The bumper 12,5 Mt maize crop.

Massey Ferguson SA, which has been trading as a division of Cape Town-based Boeresake Co-operative, has found the going so good that it is going public under its own name today in order to allow employees, dealers, clients and co-operative members to buy into the business. The company was judged 1993 Distributor of the Year, out of about 150 distributors worldwide, by the Massey Ferguson Group UK (192).

"We are issuing private debentures to the value of R20m as a capital base for the company's future growth," says Boeresake CE Lukas Rautenbach. "Since May 1991, we have been growing at about 60% a year and for the first four months of the year our market share jumped to 32% of the national total, which makes us number one for the year to date. This compares with only 14% in 1991."

Boeresake's GM management services, Pierre Retief, expects Massey Ferguson SA to go for a JSE listing in two years, should the sales trend continue. "This would depend on a continuation of favourable climatic patterns and the opportunities that could result from the government's new agricultural policy (with its focus on upgrading black farmers)."

Overall, the growth in tractor sales has come off a dismally low base (3 122 in 1993, against the 1981 all-time record of more than 24 800 units) but the outlook is influenced by more than just the good weather. "While still vague at this stage, the ANC's new agricultural policy could hold exciting future possibilities for the tractor market," says John Deere MD Bert Pepler. "We are carefully watching developments."

Pepler reports an "excellent" sales improvement for John Deere and says his group is experiencing an increase of more than 100% in sales turnover, with units sold so far about 67% above the total for the same period last year. 117194

Ford Tractors' Dirk de Vos says his company's May market share — 32,2%, compared with 26,3% for the year to date — put Ford ahead of Massey Ferguson that month. He ascribes the improvement to a better stock position. "We have not been able to meet demand any month this year so far, due to a supply backlog. Things are now looking up" (192).

The Italians return

Marketing director of Reumech Gearratio (a division of the Reunert Group), Mike Terblanche, says his company relaunched the Italian Landini tractor into the local market at the end of May.

Ten models, in combinations of two- and four-wheel drive, all assembled locally and some fitted with ADE diesel engines, are on offer.

Reumech is aiming for a 4% market share in the first year, gradually increasing to 7,5%, which was Landini's market share when it stopped doing business here in 1991.

Massey Ferguson's phenomenal growth (attributable profit before tax is expected to jump 380%, to R8,2m in the year end June) is ascribed to its new, "no bells and whistles" 290 SE (55 kW) and 399 SE (76 kW) models placed on the market about a year ago. The company's unfulfilled order book now stands at about R40-R45m.

Says Rautenbach: "These models initially sold at a 20%-25% discount to its competitors and unit sales have jumped by 88% in the first four months of the year. Apart from the ruggedness of our new models, we also save on assembly by letting ADE to do the whole job for us at their Cape Town plant. Other companies do their own assemblies. We find that the experts can do a better and more cost-effective job." ■

Delta (192)

secures

offshore CT 5/7/94

scoop

EAST LONDON — Delta Motor Corp has secured the rights to market Opel passenger cars to countries using leaded fuel, the corporation said yesterday

“Contrary to some time ago, where Opel marketed their products mainly in Europe, Opel is moving to a global market penetration,” said GM (Europe) executive director of passenger cars Manfred Wolf

“Talking specifically about countries with leaded fuel, like SA, we now have programmes — or plans — to sell Opel products in India, Russia, north and central Africa, Indonesia, Pakistan, China, the Gulf States and through GM to Brazil”

Delta, which is based in Port Elizabeth, took over the production of Opels after GM pulled out of SA in the 1980s

Exports

Delta MD, Willie van Wyk, said the new agreements would create valuable export opportunities for Delta

“It is particularly encouraging that Adam Opel in Germany, one of the world’s leading manufacturers of passenger vehicles, regards Delta as a competent high quality manufacturer and a reliable source of its Opel Astra products for other countries,” said Van Wyk.

Vehicle companies call for financing rules to be eased

MOTOR manufacturers have called for vehicle financing restrictions to be eased in an attempt to boost car sales to the private sector.

Industry sources said yesterday that any measure to free financial constraints shackling the industry would be welcomed.

Toyota SA, Nissan SA, Delta Motor Corporation, Samcor and McCarthy Motor Holdings said private leasing should be reintroduced and purchase deposits should be scrapped.

Sources said such moves could lift sales by more than R1bn a year, while generating thousands of new jobs.

Private individuals can only lease a vehicle when proof can be provided that it will be used to generate income. On an instalment sale there is a minimum deposit of 10% and a maximum repayment period of 54 months.

Nissan SA Marketing MD Stephanus Loubser said cutting vehicle costs was vital for moving the market into a "phase of healthy growth".

The recession and the erosion of private disposable income had been bad for the sector. In addition, the weakness of the rand against the yen and the Deutschmark had resulted in vehicle prices rising in

MICK COLLINS

excess of the CPI.

Dropping deposit requirements and allowing private individuals access to leasing would provide some relief.

Toyota SA Marketing MD Brand Pretorius said financial institutions, the motor industry and a body representing consumer interests should examine all the proposals and the possible ramifications. "Such a relief measure should cover both new and used cars to make the step meaningful".

However, one danger was that many customers could be pulled into the market in an "artificial manner" and the industry could run into a demand vacuum in three to four years.

Delta Motor Corporation marketing director John Cuming said it was essential that all opportunities to bring more buyers into the market be explored.

McCarthy Motor Holdings chairman Theo Swart said new jobs would be created in the motor manufacturing industry, in the vehicle distribution/maintenance sector, the banks and other associated branches of commerce and industry.

At the same time government would collect significant additional revenue through VAT and other forms of tax.

New car sales ^{CF 8/7/94} ⁽¹⁹²⁾ accelerate 24%

By AUDREY D'ANGELO
Business Editor

NEW car sales soared last month to 18 465 — 23,8% more than the disappointing 14 394 in May and 18,2% more than the 15 622 in June last year

Sales of light commercial vehicles and heavy trucks also improved. So did sales of tractors, which were 75% higher than in June last year when agriculture was still recovering from the drought.

Nico Vermeulen, director of the National Association of Automobile Manufacturers of SA (Naamsa), said demand had improved since the election. Sales were now in line with industry forecasts for the year.

Improving economic fundamentals, rising business and consumer confidence and expectations of an upturn in the economy should continue to underpin demand.

But, pointing out that lost production days leading to a shortage of stock were partly responsible for lower sales earlier this year, Vermeulen said a stable industrial relations environment was essential for the industry — particularly during the wage negotiation period.

Brand Pretorius, MD of Toyota

Sales of tractors up 75%

Marketing (SA), warned that the higher June sales "should be viewed with a degree of caution as the market was affected by abnormal circumstances."

He pointed out that the June sales had been bolstered by pent-up demand because of an earlier shortage of stock.

Sales had also been pushed up by fears of a VAT increase and of higher prices due to the weaker rand.

There had also been "some very aggressive sales campaigns during the month — some of them close to stock clearance sales."

"An objective analysis leads us to average out the sales performance of May and June which would indicate a real market of around 16 000 passenger vehicles for June which is only marginally up on June 1993."

But, Pretorius said "Toyota's view has always been that any meaningful and sustained in-

crease in sales will only take place in the second half of the year and this now seems a real possibility.

"Looking forward to July we would estimate that 16 500 passenger vehicle sales would be a reasonable market and a base to build on for the rest of the year."

"Given that there is labour stability across the industry we believe that a passenger vehicle market of 200 000 units is possible for 1994. This would be the best performance for the industry since 1990."

Naamsa figures show that 10 137 light commercial vehicles were sold in June compared with 7 994 in May and 8 019 in June last year.

Sales of medium commercial vehicles edged up to 299 compared with 294 in May and 212 in June last year.

Sales of heavy trucks rose to 505 compared with 450 in May and 437 in June last year.

Toyota remained the market leader with sales of 3 744 new cars. Volkswagen sold 3 318 and Nissan was in third place with 2 957.

Samcor sold 2 499 cars made up of 1 654 Mazda and 845 Ford. Delta sold 2 139, BMW 2 119 and Mercedes Benz 1 687 of which 1 263 were Honda Ballades.



Buoyant car sales suggest economy in recovery mode

Star 8/7/94

■ BY JOHN SPIRA

June car sales, at 18 465 units, were 18,2 percent higher than the 15 622 of June last year, reflecting distinct signs of an embryonic economic recovery.

The previous two months' statistics offered little indication of the state of the economy because they were distorted by the election, the plethora of public holidays and strikes.

The June 1994 figure is a substantial 28,3 percent up on the previous month, though much of the increase can be ascribed to the unusual set of circumstances ruling during May.

In the face of the distortions, the National Association of Automobile Manufacturers (Naamsa) notes that demand for both cars and commercial vehicles had improved after the election.

"Vehicle sales are generally running in line with in-

dustry forecasts for the year"

Year-to-date sales total 94 521 units — fractionally ahead of the comparable 1993 period, despite the disruptions to production in April and May.

According to Naamsa "Improving economic fundamentals, rising business and consumer confidence following the post-election euphoria and expectations of an upturn in the South African economy should continue to underpin demand for new motor vehicles in the months ahead."

Environment

"During this fragile period, it is essential for the industry that a stable industrial relations environment exist — especially during the agreement negotiation period."

Arthur Mutlow, managing director of Samcor Marketing, says sales volumes in June were the highest since March

1993, with cars recording the strongest market since 1990.

"This supports our forecast for a minor upswing in the vehicle market this year, notwithstanding a sluggish and disrupted first few months."

Toyota SA Marketing managing director Brand Pretorius, after averaging out May and June sales, finds there was a "real" market of around 16 000 passenger vehicles for June — only marginally up on June 1993.

"Supply constraints did, however, inhibit sales to a degree in May. Year to date there is a definite indication of growth."

He accordingly predicts July car sales of 16 500 and sees 200 000 units as a possible figure for the full 1994 calendar year, given that there is labour stability across the industry.

"This would be the industry's best performance since 1990."

New car sales soar 18,2%

Biday

MICK COLLINS

NEW car sales leapt 18,2% to 18 465 units last month as rising business and consumer confidence pushed the market to its strongest level in four years, motor industry sources said yesterday 8/7/94

Releasing its monthly figures, the National Association of Automobile Manufacturers of SA (Naamsa) said sales in June rose 2 843 units compared with June 1993 and showed a sharp uptick of 28,3% or 4 071 units compared with May (192). Naamsa said demand had improved since the elections and sales were now in line with industry forecasts for the year.

□ To Page 2

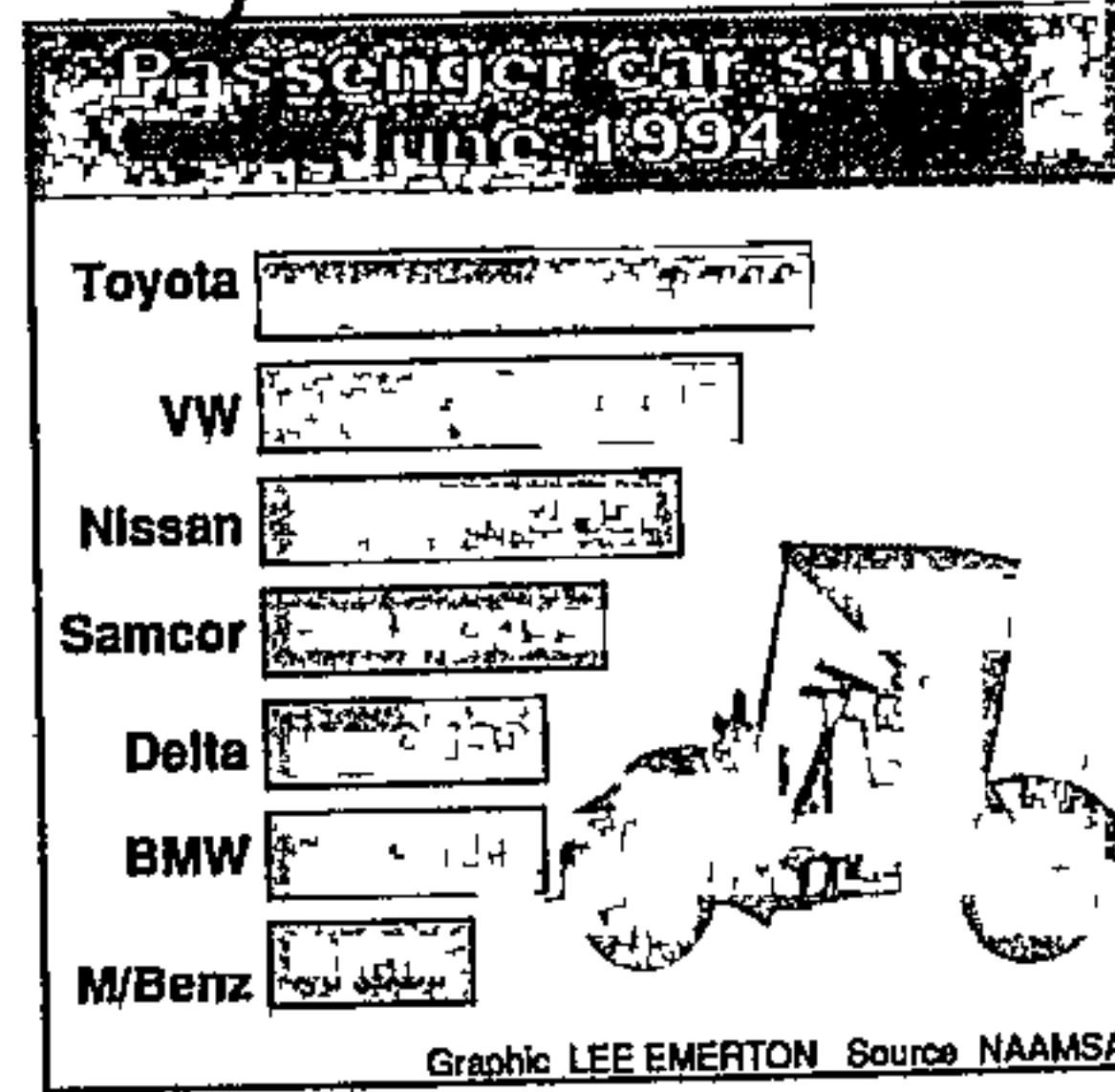

Car sales

Biday 8/7/94 □ From Page 1

Improving economic fundamentals and expectations of an upturn in the economy should continue to underpin the market

But the association warned that during "this fragile period" it was essential that there was a stable industrial relations environment — especially during wage negotiations

Major players VWSA, Delta, Samcor and Nissan said the sales reflected the market's underlying strength (192)

But Toyota said the increase should be viewed with caution as the market was

affected by abnormal circumstances. Fears of a VAT increase and price hikes in the face of exchange rate depreciation had helped push sales up

Sales of new light commercial vehicles, bakkies and minibuses reached 10 137 units — 26,4% more than June 1993 and 27,5% more than May's 7 944

The low-volume medium and heavy commercial sector also showed improvements from June 1993, with mediums rising 87 units or 41%, and heavy trucks and buses 68 units or 15,6%

Femco's income rises after sale

By AMANDA VERMEULEN

MOTOR industry supplier Femco Technology Holdings lifted net attributable income after extraordinary items to R7,4m in the year to March against a loss of R2,5m in the previous period **Business Day**

Earnings a share before extraordinary items increased 68,9% to 4,9c after dilution from the issue of an additional 3,4-million shares. The board again said no dividend would be declared. **817194**

Extraordinary items of R6m arose from profits of the sale of 50% of Auto Cable

Turnover increased 5,6% to R133,5m and operating profit increased to R6,9m (R6,5m) **(192)**

A reduction in finance charges to R5,4m (R6,3m) boosted pre-tax income to R1,4m

Net income before extraordinary items increased to R1,4m (R714 000)

X

Maize crop improves tractor sales

TRACTOR sales in June jumped 75% above last year's level to 439 units, adding momentum to the upward trend in sales that started at the beginning of the year, the SA Agricultural Machinery Association (Saama) said yesterday.

Saama said the scrapping of import protection on six cylinder engines boosted sales of tractors in the 70 to 100 kilowatt power range. Most manufacturers were now selling tractor models in this power range with imported engines.

8/17/94
(192)

MUNGO SOGGOT

But Saama warned of future price increases resulting from the weakening rand exchange rate.

Econometrix economist Tony Twine said the same circumstances which propelled the 60% increase in May — namely a bumper maize crop — were behind the June increase.

Saama said there was a 40% rise in combine harvester sales to 44 units, reflecting harvesting requirements as a result of the big crop.

VAREX/VEKTRA 8/7/94
Candidates for sale

The greatest interest surrounding Vektra and its subsidiaries, Venture and listed Varex, are not their respective performances this year. Instead, investors are carefully watching what cash-strapped parent W&A intends to do with these assets (192)

Indeed, cautionary notices have already been issued and it is clear that Vektra, a UK company listed on the London and Johannesburg exchanges, is a prize which has attracted many potential suitors. Vektra is 75% held by W&A, known to be pursuing a

The question is what kind of price to apply to this operation. Vektra's is 12, Varex's is 9,4. The usual rule of thumb for unlisted companies is about 6, though I can't believe W&A's managers would agree to such a low number, if for no reason other than that it's unlikely the conglomerate will relinquish its position without a nice premium justified by control and the London listing.

Nevertheless, assuming a modest 8,0 price places Venture at R60m, excluding debt. That gives a final figure for Vektra of between R230m and R250m. Assuming the

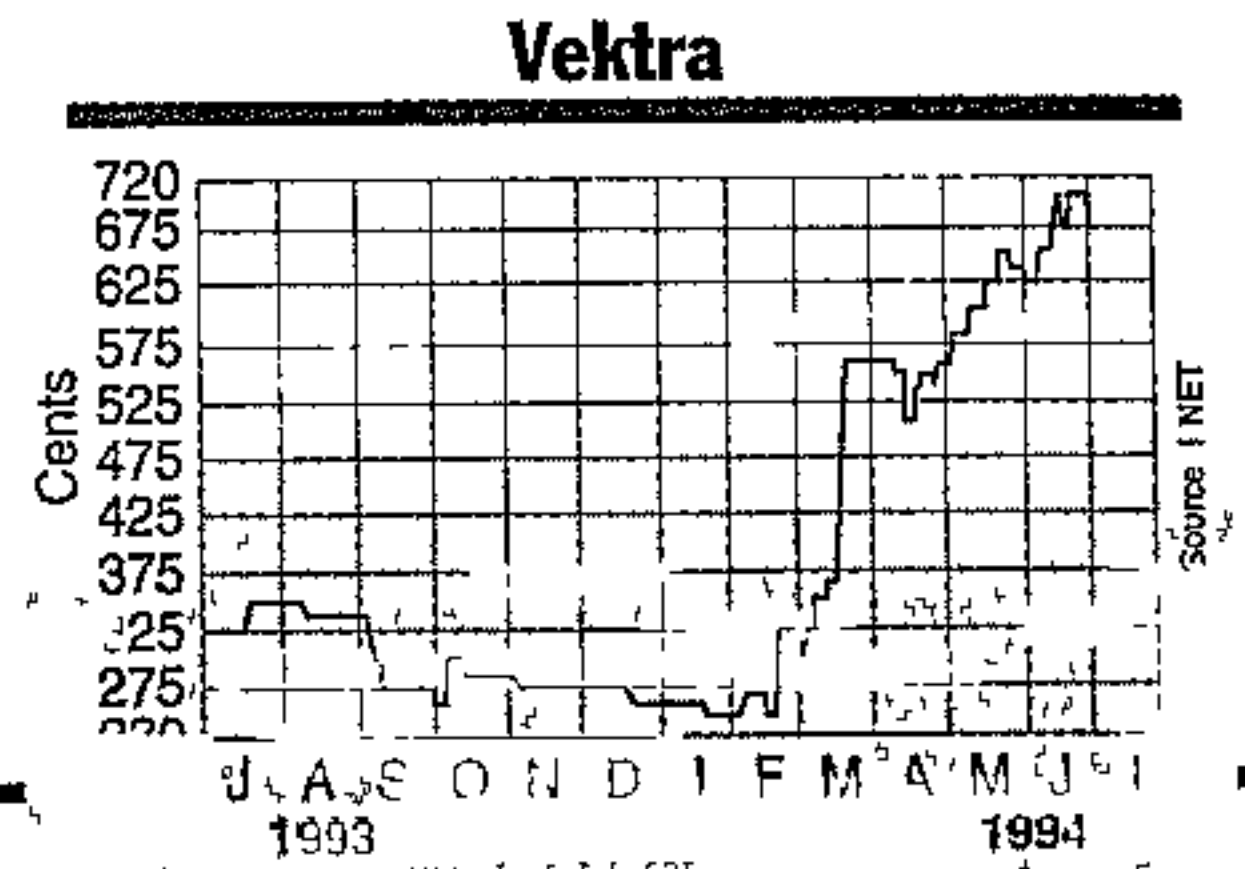

Activities: Distributes nondiscretionary automotive replacement parts and has motor dealership interests

Control: W & A 75%

Chairman: A Schlesinger, Joint MDs I Bell & R Crockett

Capital structure: 11,9m ords. Market capitalisation R177,8m‡

Share market: Price 675c. Yields 2,7% on dividend, 8,2% on earnings, p/e ratio, 12,1, cover, 3,0. 12-month high, 700c, low, 250c. Trading volume last quarter, 493 000 shares

Year to December 31	'90	'91	'92	'93
ST debt (Rm)	4,5	6,3	25,2	32,4
LT debt (Rm)	16,1	27,7	36,3	87,1
Debt equity ratio	0,3	0,5	0,7	0,5
Shareholders' interest	0,4	0,5	0,4	0,34
Int & leasing cover	1,5	1,3	1,4	2,0
Return on cap (%)	17,9	18,5	11,5	9,4
Turnover (Rm)	475,5	493,5	484,7	691,6
Pre-int profit (Rm)	28,1	25,5	23,9	30,8
Pre-int margin (%)	5,9	5,2	4,9	4,5
Earnings (c)†	46	38	44	55,6
Dividends (c)	16	13	15	18
Tangible NAV (c)	165,6	179,1	59,3	97,4

* Re-stated for change in accounting policy † Undiluted ‡ Includes compulsorily convertible debentures

course of selected asset sales so as to reduce its gearing (*Companies* July 1)

Vektra holds 72% of Varex, a major distributor of nondiscretionary motor vehicle replacement parts. Varex's current share price of 650c gives its ordinaries a total value of R65,5m, coupled with the compulsorily convertible debentures (15m in issue) now at 750c (R112m), total market cap is R177,8m. That implies a value in W&A's hands of about R128m.

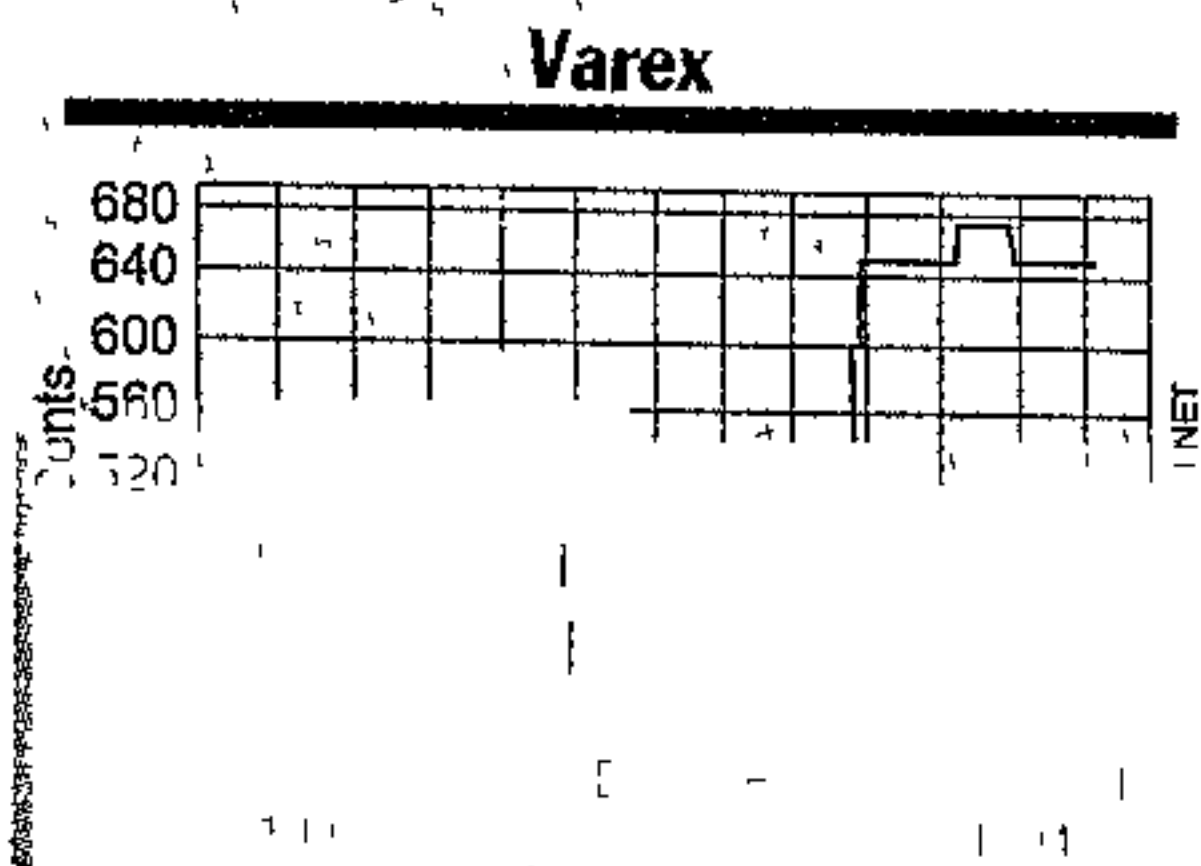

Next is the value to be imputed to Venture, the unlisted motor holdings company. Vektra doesn't give away much about its subsidiary, but note 12 to the financial statements reveals an operating profit of R7,4m on franchised operations — an oblique reference to Venture's business.

8/7/94 (192)



Varex's Schlesinger
demand much improved

lower figure, it puts R165m into W&A's war chest (though, admittedly, by a convoluted method because W&A will probably buy Venture out of Varex and may list the operation separately — though that is likely to be some years away). Investors will be forgiven for getting somewhat mixed up with all the Vs — Vektra, Varex and Venture are guaranteed to induce confusion.

The pity is that the operations of the two listed companies have been somewhat neglected by investors. That is sad because both show stout recovery from the recession. Vektra returns a bottom line of R6,6m (1992 R2,8m), which translates into 55,6c/share (1992 23,9c/share). Not surprisingly, the dividend increases modestly by 3c to 18c and the dividend cover is strengthened to 3,1 times (1992 1,6).

All this is a far cry from the heady days of 1989, when Vektra's EPS were 179,7c but it does reflect a return to an upward momentum. The balance sheet is similarly improved: loans have reduced, cash on hand has increased significantly and shareholders' funds have risen appropriately.

Varex is concerned almost exclusively with motor parts. It had a substantial improvement in demand, with turnover up 29% to R346m. Disappointingly, that didn't find its way through to operating profit which was barely R1,5m better. This dilution relates to a huge increase in administration and secretarial fees, depreciation and rentals, though chairman Alan Schlesinger says much of this is accounted for by 1992's 10-month accounting period. Frankly, it must be rather chastening for those at the sharp

end of the business.

The intention is for W&A to retain unlisted Venture, the motor sales businesses operation, and to sell its controlling interests in Vektra and Varex. That will be a pity because the turnaround is already in evidence, but given W&A's urgent need to reduce debt, it is probably unavoidable.

David Gleason

Star
Tractor
8/7/44
sales rise

June sales of agricultural machinery continued to reflect improved confidence levels, the Agricultural Machinery Association said yesterday

Tractor sales of 439 units were almost 75 percent higher than those in June last year and sales for the year to date almost 55 percent up on those for the same period last year

Sales of tractors in the 70-to-100 kW engine power range have been stimulated by lifting the protection on six-cylinder engines

(192)
Most manufacturers are now selling tractor models in this power range with imported six-cylinder engines.

Combine harvester sales were almost 40 percent higher than those in June last year, with the year-to-date figure over 60 percent higher than for the same period last year

These sales reflected the harvesting requirements for the excellent maize crop this season, but sales would now taper off as the crop was brought in, Saama said
— Sapa.

Motor industry warns about production lost to strikes

Biday 11/7/94

MICK COLLINS

THE motor industry could not withstand any further loss of production due to industrial action, sources warned at the weekend

Analysts said it was essential that the dispute declared by the National Union of Metalworkers of SA (Numsa) with vehicle assemblers be settled quickly

Work stoppages and unscheduled holidays have already cost the industry lost production of 15 500 vehicles or 5,5% of the estimated 295 000 new car and light commercial vehicles expected to be sold this year. The losses have cost the industry R800m in revenues

A Naamsa spokesman said the assemblers could not afford any further losses. The industry had lost production in May due to the election and public holidays "which we are attempting to catch up on"

The industry was already struggling to meet growing demand

Econometrix economist Tony Twine said vehicle assemblers had been living hand to mouth in supplying dealers virtually throughout 1994 "There is precious little buffer stock to carry them, their dealers and customers through a prolonged loss of production"

Numsa said at the weekend that workers were determined to get an agreement in princi-

ple from employers

The union sources said there were a lot of issues at stake including anomalies in pay rates "The wage structure in the industry is a very big problem" (192) (52)

There were huge expectations among the union's membership and despite some agreement having been reached "members can't live on policy consensus — they live on cash" "If we are not able to find a bridge there will be a confrontation. A lot depends on what happens over the next two weeks"

The Automobile Manufacturers Employers' Association (AMEA) said the dispute was not an official dispute in terms of the statute and would not become so until Numsa chose to submit an application for a conciliatory board

"We presume they will only take that decision according to progress made at further meetings we hope to have soon," AMEA spokesman Dave Gillam added

"There are a number of issues on the table many of which have got long-term implications, and good progress has been made" He said all the parties were conscious of job and employment security in the industry

MOTOR INDUSTRY
Turning the corner

Rover, the British motor group controlled by German car maker BMW AG, is expected to decide on its future in SA this week (192)

Rover recently announced plans to cancel its distribution agreement with Associated Automotive Distributors (AAD), which has distributed the UK company's Land-Rover products in SA since 1987. AAD assembles the base-line Defender model at its Blackheath, Cape Town, plant and imports others,

BUSINESS

including Range Rovers

BMW and Rover officials are in Munich to discuss options in SA. The final decision rests with Rover but it's likely that the Rover agency here will be handled by BMW SA. It is not known whether the local company will

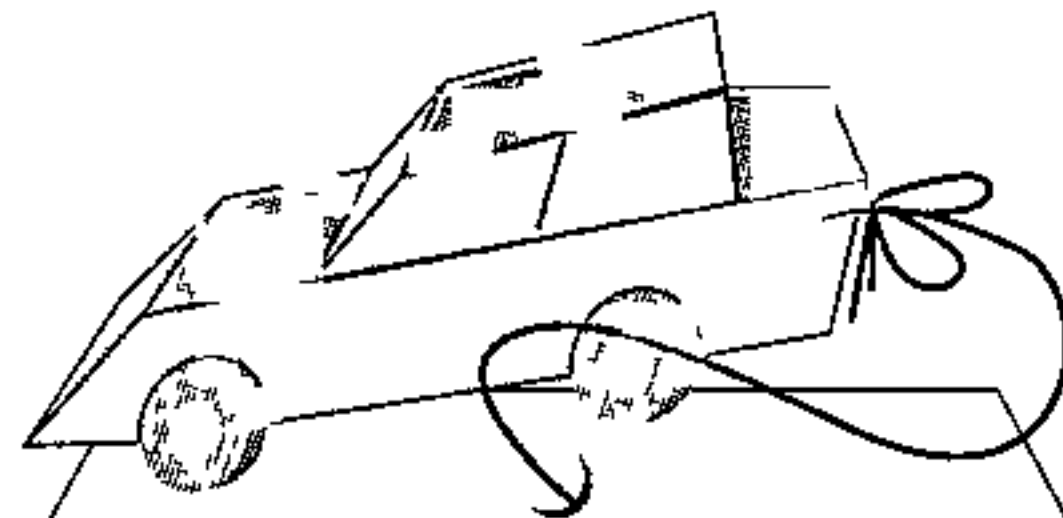

June vehicle sales

Cars	Total	%*
Corolla /Conquest 2 719, Camry 1 021, other 4		20,3
Citi/Fox 1 623, Golf /Jetta (new) 1 429, Golf /Jetta (old) 104, Audi 162		18,0
Sentra 1 648, Maxima 108, 200SX/300ZX 8, Fiat Uno 1 193		16,0
Ford Laser/ Meteor 523, Telstar 322, Mazda 323 1 101, Mazda 626 477, Mitsubishi Pajero 76		13,5
Astra/Kadett 1 987, Monza/ Kadett 108, Rekord 40, Calibra 4		11,6
3-Series 1 718, 5 Series 339, 7-Series 62		11,5
Honda Ballade 1 263, M-Benz W124 341, W140 68, W128 1, other 14		9,1
Legacy 2		0,0

*% of the total car market

	1994	1993	% Change
June	18 465	15 622	+18,2
Jan - June	94 521	94 315	+0,2
May (14 394) - June			+28,3

Small cars

Toyota 3 133 (30,9% of the market), Nissan 2 562 (25,3), Samcor 2 203 (21,7), Delta 1 585 (15,6), VW 598 (5,9), AAD 56 (0,6)

June	10 137	8 019	+26,4
Jan - June	49 458	47 569	+4,0
May (7 947) - June			+27,6

Medium cars

Toyota 115 (38,5%), Delta 63 (21,1), Samcor 49 (16,4), Nissan 48 (16,1), M-Benz 21 (7,0), Iveco 2 (0,7), AAD 1 (0,3)

June	299	212	+41,0
Jan - June	1 556	1 413	+10,1
May (294) - June			+1,7

Large cars

M-Benz 100 (37,2%), Toyota 62 (17,1), Nissan 45 (12,7%), MAN 50 (14,1%), Delta 45 (12,9%), Volvo 25 (7,1%), ERF 21 (6,2%), AAD 2 (0,6%)

June			15,6
Jan - June			
May (14 394) - June			

Other

Toyota 71 (21,1%), VW 3 916 (11,3%), Delta 38 (11,5%), BMW 2 119 (7,2%), M-Benz 1 296 (4,4%), other 159 (0,5%)

Ju			
Jan - June			
May (12 000) - June			

Source: NATIONAL ASSOCIATION OF AUTOMOBILE MANUFACTURERS OF SA

have equity in the operation or simply manage it for Rover and BMW AG

BMW SA officials do not want to comment before an official announcement but insist Rover customers in SA will not suffer. Dealers will continue to offer sales and support services. Informed betting is that, rather than put Blackheath staff out of work, the Land-Rover Defender will continue to be built in the Cape rather than at BMW SA's Pretoria plant (192)

Gaining the Rover agency would be a welcome fillip for BMW SA as the SA market finally shows signs of the mild upswing that vehicle manufacturers have been insisting all year was on the way

Thanks to last month's major improvement on June 1993 (car sales rose 18%, light commercials 26%, medium commercials 41% and heavy vehicles 16%), the 1994 market has to date at last overtaken 1993. Given half a chance, manufacturers are confident this year will show a marked improvement.

To get that half chance, they must avoid the production disruptions that characterised the first few months of this year, but prospects aren't good. Failure to reach agreement in the motor industry's latest pay negotiations was this week still contributing to a series of stoppages at manufacturers' plants. With managers and unions still far apart and no signs of a settlement, more disruptions look likely.

Still, some companies have enough time to indulge in quarrels. Toyota, having complained that Nissan's brief "Everything keeps going left" advertising flurry undermined its ad campaign, is disputing Nissan's claim that the Maxima is market leader in the 3 138 cc luxury sports sedan category.

Hardly surprising, says Toyota, when one considers how many Maximas Nissan sells to itself, notably for employees' company cars. Take those away and Toyota's 3 138 cc Camry heads the category. Indeed, it adds, other recently launched medium-car rivals also rely heavily on inhouse purchases.

Nissan's reply is "So what?" It points out that every company's sales figures include such deals and argues that because the Maxima comes only with a 3 138 cc engine, inhouse sales are bound to influence unduly performance in that category. Rivals with various engine sizes are able to spread the effect across a range.

In any case, a spokesman says, who cares? A sale is a sale. No-one has queried them in the past. Why start now? ■

Single-unit car sales inflate makers' figures

STimes (RUSS)

17/7/94

192

By DON ROBERTSON

STOCK shortages caused by labour disruptions have depressed motor vehicle sales this year.

But the shortage can partly be explained by single-unit sales — those cars which are bought by the manufacturer itself for its staff or for demonstration purposes

But for the "shortages" sales to the public could have been 7.4% higher in 1993 and 6.4% up in the first five months of this year.

Single-unit sales are included in the monthly sales figures released by the National Association of Automobile Manufacturers of SA (Naamsa) and are used as a barometer of economic activity. Monthly sales reports from Naamsa have mentioned stock shortages of certain derivatives as a factor in what has, until June, been a poor selling year.

In 1993, 14 358 of the total 193 666 cars sold were bought by the seven manufacturers for their own use. In the first five months of this year, 4 791 cars of a total 76 047 were self-purchases.

These single-unit cars will eventually be sold on the second-hand market.

In some cases, single-unit sales are quite substantial. Samcor's performance has been well below expectations, particularly the mid-range Tel-

star and Mazda 626. Of the 2 163 Telstars sold in the five months to May, 588 or 27.1% were single unit sales, while 294 Mazda 626s, or 13.3% were kept by the company for senior management use.

A spokesman says there was a shortage of Telstar and Mazda 626s last year, but they are now more readily available and are being offered to management and staff as company cars.

More normal retentions are between 3% and 5% of total sales, with single-unit sales tending to be lower in volume models. The number of cars kept by each manufacturer also depends on the size of the staff.

Single-unit sales also allow volume figures to be "expanded" to the benefit of a particular manufacturer. Nissan recently claimed that the Maxima was top of the sales charts in the three-litre passenger market.

"The Maxima has beaten its main rival, the Toyota Camry, for nine out of the 16 months since January 1993, and they have shared two months," according to a recent Nissan news release.

In 1993, Maxima sales were 1 910, while the Camry sold 1 750. Single-unit

sales of the Maxima, however, were 347 while Camry kept only 61 for its management, leaving 1 563 and 1 689 dealer sales respectively. In the first five months of 1994, Maxima sold 513 units, of which 115 were single-unit sales, while the Camry three litre sold 481, of which 61 went to staff.

Referring to in-company purchases this year, a Nissan spokesman says that Toyota has a bigger range of Camrys including two-litre models and, therefore, has wider model choice which it can give to senior employees. The Maxima is a three-litre model only.

During the same period, however, Nissan sold 27 111 cars and gave 2 538 to employees, while Toyota sold 49 142 but kept only 2 482 for its staff. Both have similar staff complements.

But all is not bad. Total June sales volumes were the highest since March 1993, with car sales the best for this month since 1990. The improved June totals for cars and light commercials also took year-to-date figures above last year's for the first time in 1994.

June car sales were 18 465 compared with 14 394 in May, taking the total for the year to 94 521 against 94 315. Light commercial sales were 10 137, up from 7 947. The total for the year rose to 49 458 compared with 47 569.

Motor industry
strike threat

(192)
APR 20/194
JOHANNESBURG. — Pay talks in the motor industry are at a critical stage and industrial action will follow if agreement is not reached by Friday afternoon.

The SA Metal Workers Union said today it had reduced its pay rise demand from 23 to 15 percent. Employers were sticking to their seven-percent offer. — Sapa.

Signing to end Numsa pay issue

ERICA JANKOWITZ

THE National Union of Metalworkers of SA (Numsa) and motor manufacturers would meet in Port Elizabeth tomorrow in a bid to settle wages, while normal production was expected to resume at all but one of the strike-affected plants today, sources said.

Indications were that Numsa and the Automobile Manufacturers Employers' Organisation (Ameo) would sign a 10,5% wage settlement agreement, despite Numsa's demand that its 11% final demand be met.

Ameo vice-chairman Harry Gazendam said employers were not open to further negotiations, but had invited the union to a signing ceremony. Numsa national organiser Gavin Hartford indicated the union would attend the meeting.

Gazendam said employers had interpreted Numsa's decision to return to work as the ending of the five-and-a-half-week strike and a signal to manufacturers that normal production would be resumed.

"It is now essential to set about repairing the damage to the industry and the economy in an atmosphere of reconciliation without further disruption and under the umbrella of a formalised agreement." He warned that it would take the industry 12 to 18

months to make up lost production, but he was confident plant-level agreements would be signed ensuring overtime and Saturday work.

Hartford said the National Bargaining Forum allowed for voluntary overtime. Members would probably agree to this until at least the end of the year when the industry traditionally shut down, to make up for lost wages. Sources estimated strikers lost about R75m in wages.

Manufacturers were gearing up to resume production today in terms of Numsa's strike suspension, announced on Monday. Volkswagen's Uitenhage plant, however, was expected to start up tomorrow as a report-back meeting on Monday was not well attended. Another was scheduled for today.

Volkswagen spokesman Raymond Hartle said the firm was optimistic that workers would report for duty tomorrow, although this was one of the two plants which rejected Numsa's proposal to suspend the strike.

Delta Motor Corporation in Port Elizabeth announced plans to recruit 400 extra workers to man a second shift in its body shop. This was planned prior to the strike, but postponed as a result of the action.

Atlantis workers picket motor components plant

ARLT 22/7/94 (192) (192)

Staff Reporter

STRIKING workers at a motor vehicle components manufacturing plant in Atlantis picketed outside the factory throughout the night after the company had obtained a Supreme Court order authorising the removal of strikers.

The workers, all members of the National Union of Metalworkers of South Africa (Numsa), went on an illegal strike after declaring a dispute with Safety Transport Inter-

group (STI) during wage talks.

A union spokesman said workers had originally demanded a 23 percent wage increase but backed down to 15 percent after negotiations.

The company is offering eight percent.

"We are continuing negotiations," the spokesman said.

STI managing director Soren Elvin-Jensen said "Most of the workforce returned to work today and most of our production lines are back in operation."



Anglo American gold and uranium division West Rand GM Jim McCluskie, left, and MD Nap Mayer at the division's quarterly results announcement yesterday. Picture Robert Botha

Strike fears erode price of Toyota shares by 9%

Bidewy 22/7/92

GEOFFREY WIDAN

TOYOTA SA, the car industry's only JSE-listed player, had more than 9% lopped off its share price this week as fears of a strike sent investors diving for cover

The shares, which traded at a March high of R31, changed hands on Wednesday at R24, with no trades yesterday as industrial action fears heightened (192)

Investors had recently become unnerved, with fears of a strike spilling over from disruptions at Pick n' Pay which had been costly, said George Huysamer analyst Chris Pretorius

Toyota SA's turnover last year was up 34%, with attributable income rising 59% to R97m. This was less than the company's target, and partly attributable to rand weakness against the yen

The rand bought 45 yen in 1992, 35 yen last year and less than 27 yen yesterday

Rand weakness had increased costs for sourcing components for the industry but, because of competition, the higher costs could only be partly offset by price hikes

As a result, Toyota SA was looking to source engines and other components from its parent company's overseas operations,

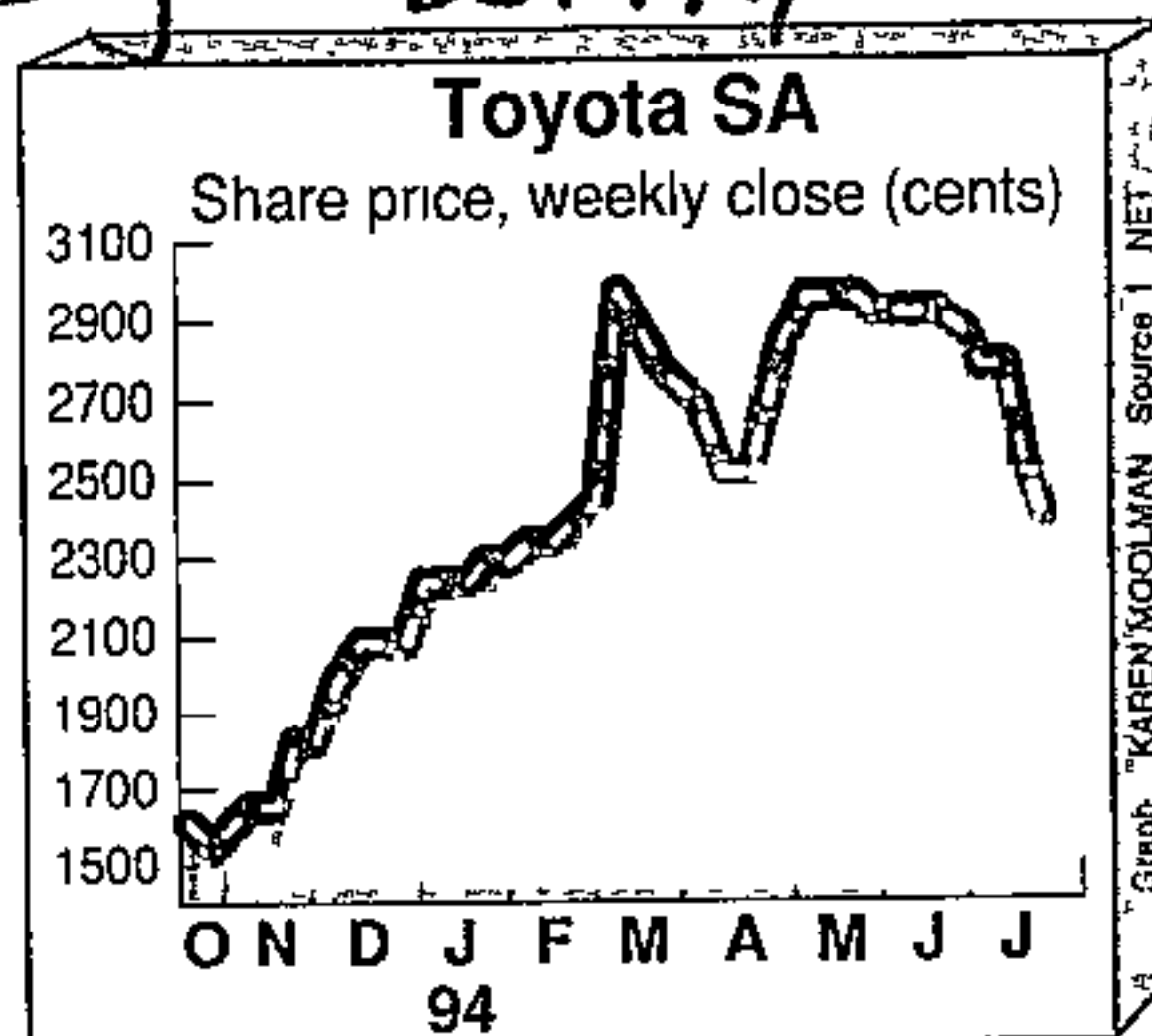

where the rand was stronger

Pretorius said currency weakness was not the major reason for the lower share price, as this had been largely costed in. He said that yen-sensitive components made up less than 30% of the cost of a vehicle, and could have contributed only partially to the share move. If the Numsa issue was settled soon, it would be back to business for Toyota.

Toyota SA group financial director Peter Robinson said that while talks were still taking place, he was confident industrial action could be averted.

Motor industry faces widespread strikes

ET 23/7/96 ~~192~~ 192
Own Correspondent

PORT ELIZABETH. — The South African motor industry is faced with widespread strike action following the declaration of a dispute yesterday between the Automobile Employers Organisation (Ameo) and the powerful National Union of Metalworkers (Numsa)

In what has been called "major muscle flexing" on the part of the unions, Numsa yesterday said it would conduct a strike ballot next week. Ameo has expressed concern over the strike action, saying it could cause irreparable harm to an ailing industry

Union spokesman Mr Gavin Hartford said Numsa was prepared to negotiate until midnight on Wednesday.



Workers strike to 'end apartheid'

ET 27/7/94

(192)

Own Correspondent

PORT ELIZABETH — The powerful National Union of Metalworkers (Numsa) will go on strike next week unless there is a definite move by motor industry management "to end apartheid" on the factory floor

Reacting to an Automobile Employers' Organisation (AMEO) statement which this week warned that thousands of

jobs could be lost, Numsa said the strike was not fundamentally about the annual wage increment

Instead it was about correcting wage structures which had been inherited under apartheid

It said despite the industry-wide strike ballot, which starts today, it remained committed to seeking a resolution with AMEO — but was adamant that

wage imbalances should be addressed within a two-year time frame

AMEO yesterday warned that strike action would cost the motor industry R100m a day and threaten the job security and earnings of 300 000 employees

The organisation warned that the industry's ability to support the Reconstruction and Development Programme could also be undermined

It said education, training and community development projects — on which it planned to spend R87m as part of the RDP — would be retarded by the threatened strike

The industry has already lost 19 000 passenger vehicles this year "through unprocedural strike action by Numsa members and unscheduled plant closures as a result of the election"

Hard time ahead for Toyota's Africa cars

Motoring Reporter

TOYOTAS for Africa — that is the latest call at the factory in the PWV

Yes, and here we are talking about Toyotas made for less than smooth roads, too

Special versions of the popular Corolla and Camry models are to be exported to markets north of the Limpopo as South Africa's top-selling car maker joins other local manufacturers on the road to Africa

These cars are now available with "harsh and dusty road packages" to cater for the road conditions encountered in certain parts of the continent, Toyota spokesmen have confirmed

The changes to the Corolla specs were developed in Japan, while the Camry is a development by the local lads at Prospecton

Both models were also put through their paces in accelerated endurance tests at the Toyota Research Centre in Eston, the only such Toyota facility in the world outside Japan until the cowboys built one in Arizona recently.

The "harsh and dusty road package" for the Corolla 130 and 160i models includes stiffer suspension with increased ride height of up to 20mm, reinforced turret mountings for the front suspension struts, metal protection plates under the engine and fuel tank, metal protectors instead of plastic ones for fuel and brake pipes, additional dust sealing on the rear door child locks, a pull-out National Panasonic radio with short wave, and a pre-cleaner in the engine's air intake route to help extend the life of the paper air cleaner element

The Camry 200 and 220 models offered with the special package also feature the suspension mods, metal protection underneath, radio and a pull-out aerial instead of the electric automatic one used here

192 APR 21/7/94

Strike crisis faces motor industry

192 ~~452~~ CT 29/7/94

Own Correspondent

PORT ELIZABETH — The motor industry lurched closer to a crippling nationwide strike yesterday after another round of wage talks failed to reach agreement, in spite of urgent pleas by political and business leaders

The National Union of Metalworkers (Numsa) and the Automobile Employers Organisation (Ameo) emerged from intense negotiations here at lunchtime

Although both sides say the door is still open for last-ditch talks, Numsa officials believe a strike is "imminent".

The results of a national strike ballot, which began on Wednesday, should be known today. Union leaders are confident of a mandate from their members

After yesterday's negotiations, there were further signs of a strain in Cosatu/ANC relations when Numsa officials said they were upset by a statement by ANC regional leader Mr Linda Mti and other politicians calling for a settlement

They said politicians, such as Mr Mti, should first approach the labour movements before they made statements to newspapers. Mr Mti said this week that the motor industry crisis was a threat to the Reconstruction and Development Programme in the region

R100m a day

Numsa said it appeared that Mr Mti did not understand all the issues. They said they were committed to the RDP and were merely trying to improve employees' working conditions

The strike will cost the motor industry an estimated R100 million a day in lost production and Ameo has warned that the earnings and job security of 300 000 employees could be threatened

Both parties have committed themselves to negotiations until midnight on Sunday, but Numsa will go ahead with strike action on Monday if what it terms "the apartheid wage gap" — the gross injustices within the pay levels — is not addressed in a two-year time frame

ANDY'S BIG **MAN'S SHOP**
LARGE SELECTION OF
KNITWEAR
 ALL SIZES INCL LONG UP TO 5 XL
 282/4 Victoria Road, Woodstock. Tel 47 4313

Cape Times
 Top of the Times
 FOUNDED 1876 ★ 488 4911 SATURDAY, JULY 30 1994 **R1,10**
 (Country R1 20) Prices include VAT
 UNIVERSITY OF CAPE TOWN
 SALDRU LIBRARY
 2004
 Cape Town

VERSATILE CO-ORDINATES
 FOR WORK • TRAVEL OR WEEKENDS
 Easily interchangeable — styles and colours
 Washable Linen • Jade • Navy • Caramel
 JACKET (PLUS) SKIRT (PLUS) SLAX (PLUS) SHORTS
 SIZES 10-18
 35 MAIN RD RONDERSCH
 PHONE 585 5513 / 585 9585
Liian salmon THE PLACE TO
 QUALITY NEVER GOES OUT OF STYLE
 DEPEND ON

Last ditch bid to prevent motor industry strike

PORT ELIZABETH — Last ditch talks will take place today after car industry workers voted for industrial action yesterday.

The National Union of Metalworkers of South Africa (NUMSA) was given a 78% mandate by its motor industry members yesterday to take industrial action hours after another day of national wage negotiations failed in Port Elizabeth.

Although both parties earlier committed themselves to negotiations

until midnight tomorrow, NUMSA said last night negotiations would end today with the tabling of a final offer by employers.

More than 35 000 workers countrywide had cast their ballots by yesterday, and the Independent Mediation Services of SA made the result known last night.

If members support the strike route, motor plants could be faced with a strike of about 19 000 NUMSA members from Monday afternoon.

However, in a final attempt to avert the threatened strike, employers will table a final offer today that will be negotiated by NUMSA and the Automobile Employers Organisation (Ameo).

The negotiations are taking place at the Midland Chamber of Industry Offices in North End.

NUMSA members have been told to report for work on Monday morning and to attend general meetings that will be held at plants around the

country later in the day, where ballot results and the detailed final offer will be reported to members.

UNION SLATED FOR 'ANTI-JEW' DEMO
 See PAGE 2

The union's demands are for a 15% wage increase, worker education and wage parity among white and

black workers.

Until yesterday, Ameo had stuck to its 9% offer.

NUMSA national collective bargaining organiser Mr Gavin Hartford said a decision would be taken at the general meetings on Monday about whether to settle the dispute by accepting the final offer or to go ahead with industrial action.

A strike could cause the motor industry an estimated R100m a day in

lost production, Ameo warned.

Volkswagen Spokesman Mr Ray Hartle said that "Volkswagen's position is that all jobs are in jeopardy unless a settlement is reached."

"The impact can't be overestimated," he added.

"Volkswagen employs 7 100 people and 17 000 in total through the supplier network," he said.

Mr Ed Emmett, liaison manager for Delta, said a strike would cost the company R9 million a day.

NUMSA has said that percentage increases are not the issue at stake. The union says the "apartheid wage gap" and the time frame in which wage imbalance problems brought about under apartheid are resolved, must be addressed.

Ameo has said the automobile industry planned to spend R87m on education and training this year and has proposed to eliminate wage differentials over three years — Own Correspondent, Staff Reporter

1
2
3
4

Mercedes Benz plant fails to open

B Day

16/8/94

ERICA JANKOWITZ

MERCEDES-Benz of SA failed to restart production yesterday and end a crippling two-week motor manufacturing strike when an insufficient number of workers reported for duty, company spokesman Delene Stroh said.

A "significant number" of workers arrived at the East London plant. However, production could resume only if about 90% were willing to break the strike.

Delta Motor Corporation in Port Elizabeth announced it would try to open its plant today. Stroh said Mercedes would again open for normal production and hoped a larger staff complement arrived.

Meanwhile, talks between the National Union of Metalworkers of SA (Numsa) and the Automobile Manufacturers Employers' Organisation (Ameo) continued after intervention at the weekend by Labour Minister Tito Mbowem and Deputy President Thabo Mbeki, the union said.

Numsa spokesman Roger Etkind said the initial round of negotiations was unlikely to broker an agreement between the parties. The union was planning for prolonged strike action.

Although talks broke down last week with only half a percentage point separating the parties, Ameo had taken some persuasion to come back to the negotiating table, insisting 10% was its final offer.

The National Automotive Component and Allied Manufacturing Association said the strike had cost component manufacturers about R220m in lost turnover as no parts had been delivered to vehicle assemblers in

the past 10 days. Temporary plant closures and employee retrenchments had started in the component sector.

Etkind warned manufacturers that worker resolve would not be broken by the attempts to reopen plants and offer workers the 10% wage increase immediately. If employers insisted on setting a benchmark for other industries, members would not respond positively. "Employers have misread the situation if they think they can divide us by advertising that they are re-opening the plants. They forget that this strike is the result of a transparent and democratic process culminating in a ballot in which our members voted overwhelmingly to take this action."

Delta and Mercedes indicated there was a strong economic rationale behind their attempts to resume production, although Delta said it recognised workers' right to strike.

Mercedes indicated it had serious problems with the National Bargaining Forum which it believed should be attended to urgently. The company acknowledged the forum had an important role to play in formulating industry strategy and enforcing fair minimum employment conditions, but believed plant-level negotiations were required to supplement these minima.

Sapa reports hundreds of striking motor industry workers gathered at the Durban City Hall yesterday to press their 12% wage increase demand (192) (35)

Motor talks may resume

1972
1972

CT 16/8/94

Own Correspondent

PORT ELIZABETH — Auto industry unions and employers could resume formal negotiations following secret weekend talks between them and the government

There were informal talks between the National Union of Metalworkers (Numsa) and the Automobile Manufacturers Employers' Organisation (AMEO) at Toyota in Johannesburg yesterday following talks with Labour Minister Mr Tito Mboweni and Deputy President Thabo Mbeki on Sunday

Numsa said in a statement yesterday that the employers had been persuaded to return to the negotiating table

AMEO called yesterday's meet-

Employers provocative — union

ing "informal discussions aimed at finding a constructive resolution"

It confirmed that meetings with the government had led to further discussions between Numsa and AMEO

Meanwhile two motor manufacturers said yesterday they would open their doors for normal production today and urged striking workers to return to work

Delta in Port Elizabeth and Mercedes Benz in East London said their invitation to strikers was a serious attempt to try to minimise hardship all round

But Numsa accused them of being "provocative" and trying to divide its members by opening for normal production during a national strike

Mercedes tried to resume production yesterday, but too few employees returned to sustain normal production

Delta, in a public statement and press advertisements, has also invited its workers to return to work today

In a statement yesterday, the union said employers had misread the situation and were wrong in thinking they could divide union membership

Vehicle makers open plants

CT 17/8/94
Own Correspondent

JOHANNESBURG —
Delta Motor Corporation
and Mercedes Benz
motor manufacturers
opened their plants yes-
terday despite continu-
ing strike action which
brought the industry to a
halt almost three weeks
ago.

Although neither man-
ufacturer attracted suffi-
cient numbers of workers
to justify starting the as-
sembly line, both em-
ployed workers who re-
ported for duty.

Delta declined to be
specific about the actual
number of workers who
arrived at its Port Eliza-
beth plant yesterday,
saying this would "put
undue pressure on the
current process."

Mercedes was equally
coy, saying only those
who presented them-
selves for work had been
employed gainfully at its
East London plant.

Both companies con-
firmed they would again
try to resume production
today.

National Union of Met-
alworkers of SA (Numsa)
spokesman Mr Roger Et-
kind said he believed
workers had merely
been employed as
sweepers, but this was
denied by the com-
panies.

A Delta spokesman
said the National Asso-
ciation of Automobile
Manufacturers of SA met
yesterday, but no
spokesman was avail-
able as talks with Numsa
resumed shortly after-
wards.

McCarthy Retail rides high on back of trading divisions

Star 29/8/94

■ BY CHARLOTTE
MATHEWS

Improved performances by both trading divisions of McCarthy Retail — Prefcor and McCarthy Motor Holdings — contributed to a 25 percent rise in profit before extraordinary items to R111,6 million in the year to June 1994, compared with the previous year.

Turnover lifted by 17 percent to R6,2 billion, but pre-tax income was 49 percent better at R239,2 million on better operating profit and a lower interest bill.

The tax rate rose to 41 percent in 1994 from 35 percent in 1993, both as a result of higher secondary tax on companies (STC) and a liability arising from the merger of the two operating groups. Deputy chairman

Terry Rosenberg said on Friday the normal tax rate was likely to be lower again in 1994/95.

Earnings a share, before providing for the dilution that will occur on the conversion of the compulsorily convertible debentures, were 71,3c (57,6c).

After providing for the dilution, earnings a share were 61,1c (48,2c). A final dividend of 13,5c brings the total dividend to 22,5c (1993: 19c).

On the balance sheet, the ratio of interest-bearing debt to permanent capital dropped to 12 percent from 19 percent, showing a reduction in short-term borrowings to R93,6 million from R156,9 million.

Rosenberg said McCarthy Retail should continue to show real growth in earnings.

The 1994 results were encouraging in view of the volatile trading environment created by unrest, crime, labour instability and lack of consumer confidence (192).

Growth in profit contrasted with a 1 percent rise in real private consumption expenditure.

In particular, the new vehicle franchises maintained their 13,1 percent market share and Budget Rent-a-Car lifted market share to 23,5 percent.

Furniture stores Beares were ahead of budget and the Bee-Gee clothing chain had an excellent year.

McCarthy Group, which owns 84,9 percent of McCarthy Retail, has declared a final dividend of 16,2c (14c) a share on consolidated earnings a share of 93,9c (76,3c).

Losses mount in R1,5bn auto strike

CT 18/8/94
Own Correspondent

JOHANNESBURG — Informal talks between manufacturers and unions continued yesterday in a bid to end a strike by about 25 000 motor industry workers, which enters its 14th day today

By yesterday manufacturers were estimated to have lost about R1,5 billion in turnover

Manufacturers expressed concern over their projected inability to catch up with lost production between now and the year-end shutdown, normally scheduled for mid-December

Toyota spokesman Mr Roger Houghton said the company was already more than 5 000 vehicles behind its production target when the strike began. Each day added a further 420 vehicles to this total, and Toyota had

~~(192)~~ (192)
little chance of making up the shortfall

Other manufacturers were in a similar predicament, with backlogs which stemmed from the week-long shutdown over the election period and industrial action earlier this year

Suppliers and dealers were also feeling the pinch and component manufacturers had started laying off workers with the massive drop in demand for products, manufacturers said

● Firestone employees downed tools at the Port Elizabeth factory yesterday in sympathy with a shop steward they said had been treated unfairly

● All tyre industry employees are expected to gather at the Numsa regional offices this morning to discuss the tyre industry wage negotiations

BUSINESS

Strike takes toll of motor index

BY CHARLOTTE MATHEWS

The three-week-old strike in the motor industry has taken its toll of the JSE's motor sector index, which mostly reflects motor manufacturer Toyota's share price

The motor sector index was at 4073 at the beginning of this week, slightly off its low of 3985 last week, but still 20 percent below its 12-month high of 5106 reached in June. (192)

At the same time, Toyota's share price was down to R22 from between R29,50 and R30 in May and June, but a little better than last week's low of R21,25.

Toyota is the only listed motor manufacturer in the sector.

The other sector components are motor dealerships and component manufacturers, who, although not directly affected by labour stoppages, will also suffer from the backlog in production

Some motor dealerships make a significant part of their profits

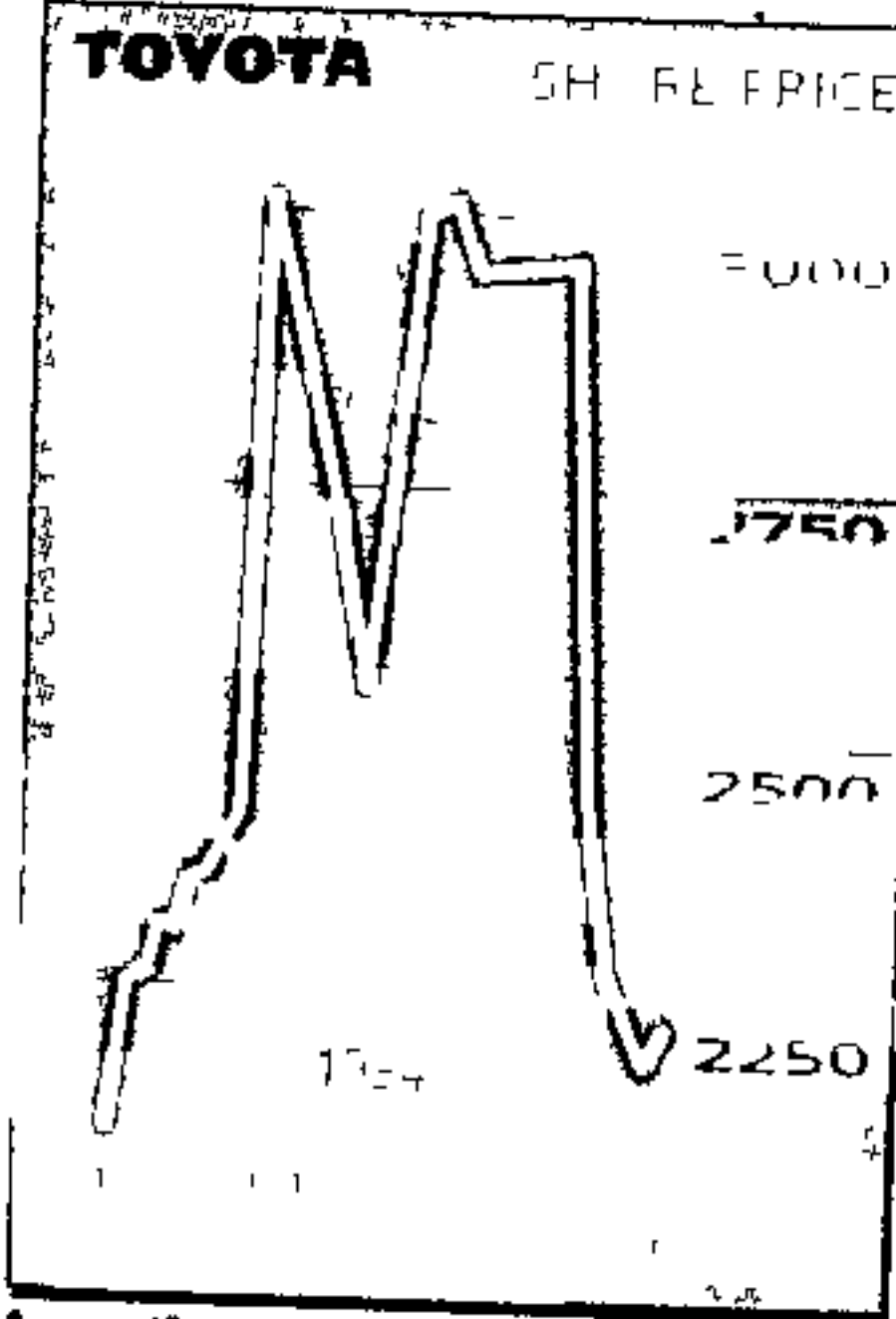

from the used-car sector

However, availability of used cars is also a problem around the industry, says Eastvaal Motors director Dawie Lange.

"We are being affected by the strike in all areas. Since new vehicles are in short supply, you cannot trade in used vehicles for new ones.

"We are also influenced by the

shortage of components for various vehicles."

Although the strike affected the whole industry, so individual market share was not being lost, the industry had to continue to cover the overheads of its huge investment in plant and machinery, even though there was no production.

Some production could be made up — at a cost of having to pay workers overtime — but earnings would undoubtedly be hit, analysts agree

The small increase in Toyota's shares towards the end of last week was ascribed to the perception that this offered a buying opportunity.

Analysts are reluctant to recommend an investment in the sector even if the shares look cheap in the short term, because they consider the motor industry too cyclical

They agree Toyota is a well-run company, but say it has been hit by a strike before and is likely to face the same problems.

Another blow for strike-hit car industry

ROGER FRIEDMAN (192)
Labour Reporter

THE embattled motor industry has been dealt another blow, with the white SA Steel and Allied Industries Union declaring itself in dispute with the Automobile Manufacturers' Employers Organisation over wages. ALLG 18/8/94

The industry has been effectively shut down since about 25 000 National Union of Metalworkers of South Africa (Numsa) members went on strike over wage increases 17 days ago.

Steel and Allied Industries Union spokesman Johan Prinsloo said the union had "no choice" other than to declare a dispute.

The union had about 1 850 members in the motor industry, most of them artisans.

Union Eastern Cape area manager Pieter Veldtman said the union was demanding a 12 percent wage increase, while employers were offering nine percent.

The union offered to meet employers halfway — 10,5 percent across-the-board — but the employers were sticking to 10 percent.

The union meets its employers tomorrow.

● Numsa's leadership was locked in a meeting to discuss developments in Port Elizabeth today after "informal talks" with their employers failed at the weekend.

The union is demanding a 12 percent wage increase, while employers are offering 10 percent.

● The Steel and Allied Industries Union is still pursuing an interdict forcing Volkswagen to allow its members to work in spite of the Numsa strike.

Delta 'encouraged' as workers trickle back

The Argus Bureau

PORT ELIZABETH. — Delta motor corporation says it is encouraged by the turnout of workers since it restarted production on a limited scale this week

Human resources director George Stegmann said the growing number of employees who had returned had been used effectively

"Over the past three weeks this strike has cost our company about R135 million in lost turnover and our employees nearly R45 million in lost wages," he said

"This loss has grave consequences for them and their families in what is an already depressed Eastern Cape region — as well as impacting on Delta's ability to support the community"

Mr Stegmann said Delta remained committed to finding a negotiated solution to the pay strike at the earliest possible opportunity

New bid to end motor strike

MOTOR manufacturers offered a supplementary monetary award to striking workers in return for a commitment not to embark on any unprocedural industrial action for the duration of the agreement, Automobile Manufacturers Employers' Organisation vice-president Harry Gazendam said yesterday. *BIDay*

Employers had not increased their base offer of a 10% increase on actual wages. But they offered a one percentage point ex gratia payment to all workers for the six months beginning January 1 1995. This would be calculated on their basic wage and paid out weekly, but not added to their base rate, he explained. *19/8/94*

In return, workers would agree not to embark on unprocedural industrial action,

ERICA JANKOWITZ

to recover the units lost in the current strike and to stick to build schedules.

The offer was put to the National Union of Metalworkers of SA's auto shop stewards' council meeting yesterday and discussed by the SA Iron, Steel and Allied Industries' Union. It was tabled during informal talks between the parties this week following government intervention last weekend. *(192) (192)*

Gazendam said Deputy President Thabo Mbeki and Labour Minister Tito Mboweni had been constructive and non-prescriptive in their approach and had urged the parties to seek "innovative solutions"

□ To Page 2

Motor strike

BIDay 19/8/94

Meanwhile, the Mercedes-Benz plant in East London did not open for production yesterday because of the lack of significant attendance, spokesman Delene Stroh said. The company reopened on Monday, but did not attract sufficient workers to make any production worthwhile. On Tuesday and Wednesday, some limited production was managed at Mercedes and the Delta Motor

Corporation in Port Elizabeth

Delta said there was similar attendance yesterday and both plants said they would open again today. *(192) (192)*

The three-week strike by about 25 000 workers is estimated to have cost manufacturers more than R1,65bn in lost turnover and strikers millions in lost wages

□ From Page 1

No settlement of auto strike in sight

Star 19/8/94

■ BY JOVIAL RANTAO
LABOUR CORRESPONDENT

Fifteen days later and with more than R1,5 billion in turnover lost, a settlement still seems out of reach for the parties negotiating to resolve the strike by 25 000 workers in the motor manufacturing industry (192)

The Automobile Manufacturers Employers' Organisation (Ameo) and the National Union of Metalworkers of South Africa yesterday remained tight-lipped about progress made

Sources close to the two-day informal talks said Ameo stood firm on its 10 percent final offer but was prepared to pay a further 1 percent in the

form of an ex-gratia payment

■ More than 600 workers at Langeberg Foods in Boksburg went on strike yesterday, demanding the reinstatement of a shop steward

■ The Food and Allied Workers Union announced yesterday that the three-week-old strike by 378 workers at the Enterprise Food Company in Germiston had been resolved.

■ The strike by 309 workers at the Kagiso Town Council, on the West Rand, where workers have demanded the reinstatement of a dismissed shop steward and payment of ex-gratia money, enters its seventh day today

Increased vehicle sales put Vektra in overdrive

MICK COLLINS

INCREASED sales of new and used vehicles saw motor dealer Vektra's net profit more than double to R4,6m for the six months to June

The W&A-owned company pushed turnover up 40% to R431m, after the 1993 acquisition of Nissan dealerships which increased contributions

Operating profit rose 27% to R16,7m while earnings a share more than doubled to 38,6c. An unchanged interim dividend of 6c was declared

The company said a strong performance from unlisted Venture Motor Holdings was another major factor in the improvement in the group's results

Automotive components subsidiary Varex increased attributable profit marginally to R3,9m (R3,6m). The company bought out minority interests in line with its objective of

running all its outlets as wholly owned businesses | 918/94

Turnover was up 16,2% at R187m despite intense competition

The company incurred substantial development costs to consolidate its market position, which resulted in operating profit increasing only 8,2% to R11,5m

Earnings a share on a fully diluted basis increased marginally to 28,2c (27,9c). An increased interim dividend of 12c (11c) was declared (192)

Car industry offers new money award

cont. 19/2/94 (192)

Own Correspondent

JOHANNESBURG — Motor manufacturers offered a supplementary monetary award to striking workers in return for a commitment not to embark on any unprocedural industrial action for the duration of the agreement, Automobile Manufacturers Employers' Organisation vice-president Mr Harry Gazendam said yesterday.

Employers had not increased their base offer of a 10% increase on actual wages. But they offered a one percentage point ex gratia payment to all workers for the six months beginning January 1, 1995. This would be calculated on their basic wage and paid out weekly, but not added to their base rate, he said.

In return, workers would agree not to embark on unprocedural industrial action, to recover the units lost in the current strike and to stick to schedules.

The Mercedes-Benz plant in East London did not open for production yesterday because of the lack of significant attendance, spokesman Ms Delene Stroh said. The company reopened on Monday, but did not attract enough workers to make any production worthwhile. On Tuesday and Wednesday some limited production was managed at Mercedes and the Delta Motor Corporation in Port Elizabeth.

Delta said there was similar attendance yesterday, and both plants said they would open again today.

Auto strike statement

Make up lost time, demand employers

Star 20/8/94

THE auto industry workers' strike, more than two weeks old, has cost manufacturers more than R1,5 billion in turnover and more than R40 million in wages, reports Labour Reporter JOVIAL RANTAO.

THE Automobile Manufacturers Employers' Organisation (AMEO), currently involved in talks to resolve the 16-day-old strike by motor assembly workers, has, as a settlement precondition, demanded a guarantee that workers would make up for production lost during the strike

This was disclosed yesterday by the National Union of Metalworkers of South Africa (NUMSA), which declared there would be no settlement from the union's side without an improved offer from AMEO on the workers' basic wage.

In a statement, the union said its National Auto Shopsteward Council — the highest decision-making body in the sector — found nothing in the employers' repackaging of their offer.

Employers, who have made a final offer of 10 percent, have put forward various options for ex-gratia payments, none of which, according to NUMSA, would improve the basic wages of workers. NUMSA, which had reduced its demand of 12 percent to 10,5, has reverted to the original demand.

See Page 4

"The nature of AMEO's offers make clear that it does not understand what our members require

"We can spell it out very clearly so that there is no further confusion: there will be no settlement from our side without an improved offer from employers on our members' basic wages. It's as simple as that," NUMSA said in a strong-worded statement.

The union said it had made numerous concessions during the dispute.

The last was the provisional agreement to postpone the beginning of the exercise to correct wage anomalies to next year.

Harry Gazendam, AMEO's vice-chairman, expressed disappointment that NUMSA had rejected employers' offer of a supplementary increase and maintaining of the old production schedule.

He said employers had approached the negotiations consistently and rationally and believed the offer was an excellent one. "I'm deeply disappointed," he said.

Gazendam said AMEO had proposed that the parties should consider a "final-offer arbitration" — where an arbitrator reviews the position of the two parties and decides on one of them. This, he said, was rejected by NUMSA.

Gazendam said that although no informal talks, encouraged by government intervention, or negotiations were scheduled, the AMEO would do all it could to resolve the matter.

NUMSA has also declared its commitment to resume negotiations.

The strike has cost manufacturers more than R1,5 billion in turnover, workers more than R40 million in wages and the Government more than R250 million in taxes.

No deal, say auto workers

JOVIAL RANTAO
Weekend Argus Reporter

~~192~~ (192) ARG 20/8/94
AUTOMOBILE industry employers, involved in talks to resolve the 16-day-old strike by motor assembly workers, have demanded a guarantee that workers make up production lost during the strike as a settlement pre-condition.

This was disclosed yesterday by the National Union of Metalworkers of South Africa (Numsa), which said there would be no settlement without an improved offer from the Automobile Manufacturers Employers' Organisation (Ameo) on the workers' basic wage.

In a statement, the union said its

National Auto Shopsteward Council found nothing in the employers re-packaging of their offer.

Employers, who have made a final offer of 10 percent, have put forward various options for ex-gratia payments, none of which would improve the basic wages of workers, the union said.

Numsa, which had reduced its demand of 12 percent to 10,5, has reverted to the original demand.

Ameo vice-chairman Harry Gazendam expressed disappointment that Numsa had rejected the employers' offer.

In spite of the deadlock, both sides have committed themselves to continuing negotiations.

Target set for car tariff cuts

THE Board on Tariffs and Trade has recommended that tariffs on imported motor vehicles and parts be gradually cut to 30% by 2003 — a move that could inflict far heavier than expected blows on low-volume SA car production

The board said the decision stemmed from the industry's current position and long-term strategic objectives, and the need to comply with GATT

The Motor Industry Task Group — a task force representing government, unions and industry — had recommended a 45% maximum import tariff by 2002

The board's chief director Alwyn Kraamwinkel said the proposals would be discussed with interested parties. The proposals were a revamping of Phase 6 of the local content programme, the board did not envision a Phase 7

B1 Day 22/8/94
MUNGO SOGGOT

The National Association of Automobile Manufacturers of SA said at the weekend that it would call on the board to clarify the reason for the revision

Director Nico Vermeulen said the board seemed to have rejected the task group's rationalisation proposals, which included trading off higher imports with export credits for SA producers. Instead, it had recommended further long-term tariff reductions on imported vehicles as a way of encouraging the phasing out of low-volume domestic production (192) (333)

The board also recommended that vehicle manufacturers — as opposed to importers — enjoy a duty-free allowance

To Page 2

copy 2/18

Car tariffs

B1 Day 22/8/94 From Page 1

on imported components. This allowance would drop in line with the gradual cut in import tariffs (192) (333)

The board said vehicles imported in semi-knocked down form should be liable for the same duty as components

Econometrix economist Tony Twine said GATT representatives had revised their recommendations on SA tariff structures after the task group had submitted

its proposals to the board

Twine said the steeper cut would have significant implications, probably changing the "mode of business" for the industry. The industry might not be able to produce as many cars, but it would be able to import at lower tariffs. This would protect some of the smaller manufacturers, which could switch from production to act as wholesale importers

Car tariff move could hurt producers

Own Correspondent

JOHANNESBURG — In a move that could inflict a heavier than expected blow to South African car production, the Board of Tariffs and Trade has recommended that tariffs on imported motor vehicles be gradually cut to 30% by 2003.

The board said the decision

stemmed from the industry's current position and long-term strategic objectives, and the need to comply with GATT.

The Motor Industry Task Group — a task force representing the government, unions and industry — had recommended a 45% maximum import tariff by 2002.

The National Association of

Automobile Manufacturers of SA said at the weekend that it would call on the board to clarify its reason.

Director Mr Nico Vermeulen said the board seemed to have rejected the task group's rationalisation proposals, which included trading off higher imports with export credits for SA producers. Instead, it had recom-

mended further long-term tariff reductions on imported vehicles to phase out low-volume domestic production.

The board also recommended that vehicle manufacturers enjoy a duty-free allowance on imported components.

~~SA~~ Economist Mr Tony Iwine said the steeper cut would

have significant implications, probably changing the "mode of business". ~~CT 22/8/94~~

The industry might not be able to produce as many cars, but it would be able to import at lower tariffs. This would protect some of the smaller manufacturers, who could switch from production to act as wholesale importers.

Auto strike: No end is in sight

JOHANNESBURG

There is no end in sight to the strike by motor assembly workers

The National Union of Metalworkers of SA (Numsa) general secretary, Mr Enoch Godongwana, said the latest employer offer "offered a basis for settlement"

However, the refusal of the Automobile Manufacturers Employers' Organisation to re-open negotiations on this basis and its insistence that the package was its final offer, was unacceptable

192
22/10/94

Strikes shut car parts makers

3/Day

ERICA JANKOWITZ

EIGHTEEN motor vehicle parts manufacturers had stopped production by the end of last week, with more expected to follow as the strike by about 25 000 motor vehicle assembly workers continued into its fourth week

2318194
National Association of Automotive Component and Allied Manufacturers president John Brandtner said some member companies had been forced to lay off workers temporarily and others were working shortened weeks "with some working only two days a week"

The strike had cost automotive component manufacturers about R300m to date, with costs escalating by about R20m a day

Brandtner said some manufacturers who focused on the export trade were curtailing operations as they could not get parts from sub-suppliers who had closed

"The signal being sent to international customers bodes ill for the automotive industry's long-term export-growth plans"

He also warned of cost implications once the strike ended "The moment vehicle manufacturers speed up production to make up for lost time, component manu-

facturers will also have to increase production, which would result in costly overtime, assuming of course that unions support requests for overtime"

The industry would have to recover these costs without becoming uncompetitive compared to imported components

"As costs escalate beyond the industry's ability to pass cost increases on to customers, we will see an erosion not only of our financial viability but also of our ability to compete with imports This will have a severely detrimental effect on our potential for future growth and job creation"

Meanwhile, there appeared to be no end in sight to the motor strike yesterday as employers indicated they were unable to attend a proposed meeting of the national bargaining forum "for logistical reasons"

They hoped a meeting would be scheduled this week, although Automobile Manufacturers Employers' Organisation vice-president Harry Gazendam said "no solution was readily at hand"

192 (12) ● See Page 14

Striking car workers return to bargaining

ROGER FRIEDMAN
Labour Reporter

192

DEADLOCKED negotiations between the National Union of Metalworkers of South Africa and the Automobile Manufacturers Employers' Organisation resume today in Port Elizabeth under the auspices of the National Bargaining Forum

Numsa is demanding a 12 percent across-the-board wage increase, while the employers are offering 10 percent

Ameo spokesman Roger Houghton said the three-week-old strike was costing the industry more than R100 million a day and workers R3,5 million a day in lost wages.

But Numsa spokesman Gavin Hartford said union members remained resolute in their stand and it was "theoretically possible the deadlock could go on for ever".

Mr Houghton said the union had rejected his organisation's latest offer on Friday.

"It's deadlocked. I don't know how, but we'll have to reach a compromise somehow," he said.

The employers' latest offer was 10 percent across-the-board with an additional one percent "ex-gratia payment" between January and June next year, subject to various conditions.

Mr Hartford countered that the cornerstone of the union's stand had always been an improved base-rate, not ex-gratia payments subject to conditions

Although the union was demanding a 12 percent wage increase it had already indicated it was prepared to move off this figure

And the union had already compromised on the time-frame over which apartheid-created wage anomalies had to be rectified by the employers, Mr Hartford said

Call to clarify car industry tariffs

THE motor industry called on government yesterday to clarify its position on tariff protection for the industry, which could be crippled by a harsh programme

The Board on Tariffs and Trade has recommended that import tariffs on cars and components be cut gradually to 30% by 2003 — a move that would deal a heavier than expected blow to the motor manufacturing industry

National Association of Component and Allied Manufacturers (Naacam) president John Brandtner said the board had rejected most of the motor industry task group's proposals. The group, which represented union, government and industry, had recommended a 45% import tariff by 2002.

Brandtner said the board's proposals exceeded agreed GATT levels in an attempt to make SA a "lily-white" signatory of the GATT agreement after years of excessive trade protection. A decision had to be made by the end of the year as the industry was "on hold in terms of any future invest-

BIDOU

MUNGO SOGGOT

ment decisions" *21/18/94*

GATT regulations stipulated a new tariff programme would have to be in place at least 180 days before July 1995 ~~(1995)~~

The task group's negotiations on the future of the industry had shown that industry players had too many vested interests to "formulate its own destiny without a clear direction from government" *(192)*

Naacam feared the board's proposals — which aimed to use only tariff measures to regulate the industry — were oversimplified. The proposals made no mention of the task group's model rationalisation programme, which aimed to encourage manufacturers to concentrate on high-volume models and stimulate "badly needed" economies of scale.

"Naacam is concerned that after 30 years of local content programmes, the local content philosophy has been scrapped under the board's new proposal."

Standard #4

X

[Faint, illegible text at the bottom right of the page]

Motor industry calls for clarity on tariffs

192
Own Correspondent

JOHANNESBURG — The motor industry yesterday called on government to clarify its position on tariff protection for the industry, which could be crippled by a harsh programme

The Board on Tariffs and Trade (BTT) has recommended that import tariffs on cars and components be gradually cut to 30% by 2003 — a move which would deal a heavier than expected blow to the motor manufacturing industry

National Association of Component and Allied Manufacturers (Naacam) president John Brandtner said the BTT had rejected most of the motor industry task group's proposals. The group, which represented union, government and industry, had

CT 24/8/94
recommended a 45% import tariff by 2002

Brandtner said the BTT proposals exceeded agreed General Agreement on Tariffs and Trade levels in an attempt to make SA a "lily-white" signatory of GATT after years of excessive trade protection. A decision had to be made by the end of the year as the industry was "on hold in terms of any future investment decisions"

GATT regulations stipulated a new tariff programme would have to be in place at least 180 days before July 1995

The task group's negotiations on the future of the industry had shown that industry players had too many vested interests to "formulate its own destiny without a clear direction from government"

Motor industry talks stalled in fifth week

PORT ELIZABETH — There is no indication when motor manufacturers and unions will resume formal talks to resolve the strike, which is about to enter its fifth week. ~~(192)~~ (192)

The National Bargaining Forum yesterday failed to get all parties to meet. CT 24/8/74

Employers said a proposed meeting time was inconvenient, but the Automobile Manufacturers' Employers Organisation (AMEO) said informal talks were continuing by telephone. AMEO was committed to finding a solution.

New wheels are way beyond most of us

□ Car prices compare well with those overseas, but salaries don't

STEADILY rising car prices are forcing more and more ordinary salary-earners from the new car showroom to the used-car lot. Moring Reporter **HENRI du PLESSIS** and Labour Reporter **ROGER FRIEDMAN** investigate.

ARE new cars too highly priced in the new South Africa? No, say local manufacturers. Our cars are often cheaper than their equivalents in Europe, they point out.

Several new models on the country's roads today, are between six percent and 10 percent cheaper than the same cars on the autobahns, interstates or English country lanes, they claim.

Unbelievable? Yes. But technically true.

It's the affordability that is the problem.

Many cars here are slightly cheaper in real terms than overseas, says Mercedes-Benz marketing director Peter Cleary, among others.

"It has been shown for instance that a certain Golf in Britain is six percent more expensive than the same model here," he said during the launch of the new compact Mercedes C-Class this week.

"Our C-Class has been intro-

duced here at the same and lower prices than in Germany."

If the exchange rate is taken into account and duties on imported components are deducted, locally made cars are at least priced favourably, compared with the same models overseas.

What about inflation? Here are some local prices since 1992. Inflation over the period has been calculated at 18.2 percent.

The Toyota Corolla 1.6 GL went from R41 833 to R54 755, a whopping 30.8 percent increase. The 1994 Camry 200i weighs in at R80 552 against its predecessor 1992 Cressida

(bottom of the Meteor range) rose 25.7 percent from R35 464 to R44 597 and the Nissan Sentra 200 STi 24 percent from R74 175 to R91 930.

Among the fancier wheels, the BMW 525i jumped 21.5 percent from R147 730 to R179 500 and the Mercedes Benz 200 E 27 percent from R127 905 to R162 563.

According to manufacturers, the main reasons for the increases were raised specification levels and the exchange rate.

The Japanese marques have suffered most as the yen has risen meteorically against the rand over the past year, they said.

As did the German mark and sterling, but to a lesser degree.

In 1992, you could get 44,455 yen for your rand — now, you get 27.2 yen, says Toyota marketing director Brand Pretorius.

"While Toyota has one of the highest local content percentages in the country, our exports are low and this influences the duties we have to pay on those components we import,"

BMW's Deon Ebersohn believes local manufacturers are under pressure, partly due to relatively high labour costs.

"All local manufacturers saw it as their duty to create jobs instead of automating their factories. We therefore employ more people for each unit produced," he said.

Labour unrest and strikes did not have a real influence on costs, as it only delayed production, he said.

Why then, are the most new cars on the market here either company-owned or sponsored?

In a word: Affordability. A South African sales manager

earning R5 000 a month would have to move in with his in-laws and save every cent of his salary for 13 months to afford a relatively good hatchback costing R65 000.

His equivalent in the United States, earning about \$2 800 a month, need only save for five months to afford the identical car, which costs \$13 400 there.

Across the Atlantic, the British sales manager earning about £2 200 a month would require about seven

months' salary to afford the identical, £15 000 car.

If the sales managers wanted to exchange their hatchbacks for more upmarket sedans, but received no salary increases, the South African would have to save for 23 months, while the Briton would require just ten.

This is clearly where the key to the issue

"Obviously, salaries in Germany are much higher — a clerk in Ger-

many probably earns four times as much as his contemporary in South Africa, but he is possibly five times more productive." Mercedes's Mr Cleary said.

Compared with EC and US salaries, South Africans are at the short end of the stick, industry sources agree.

The accelerating cost of wheels

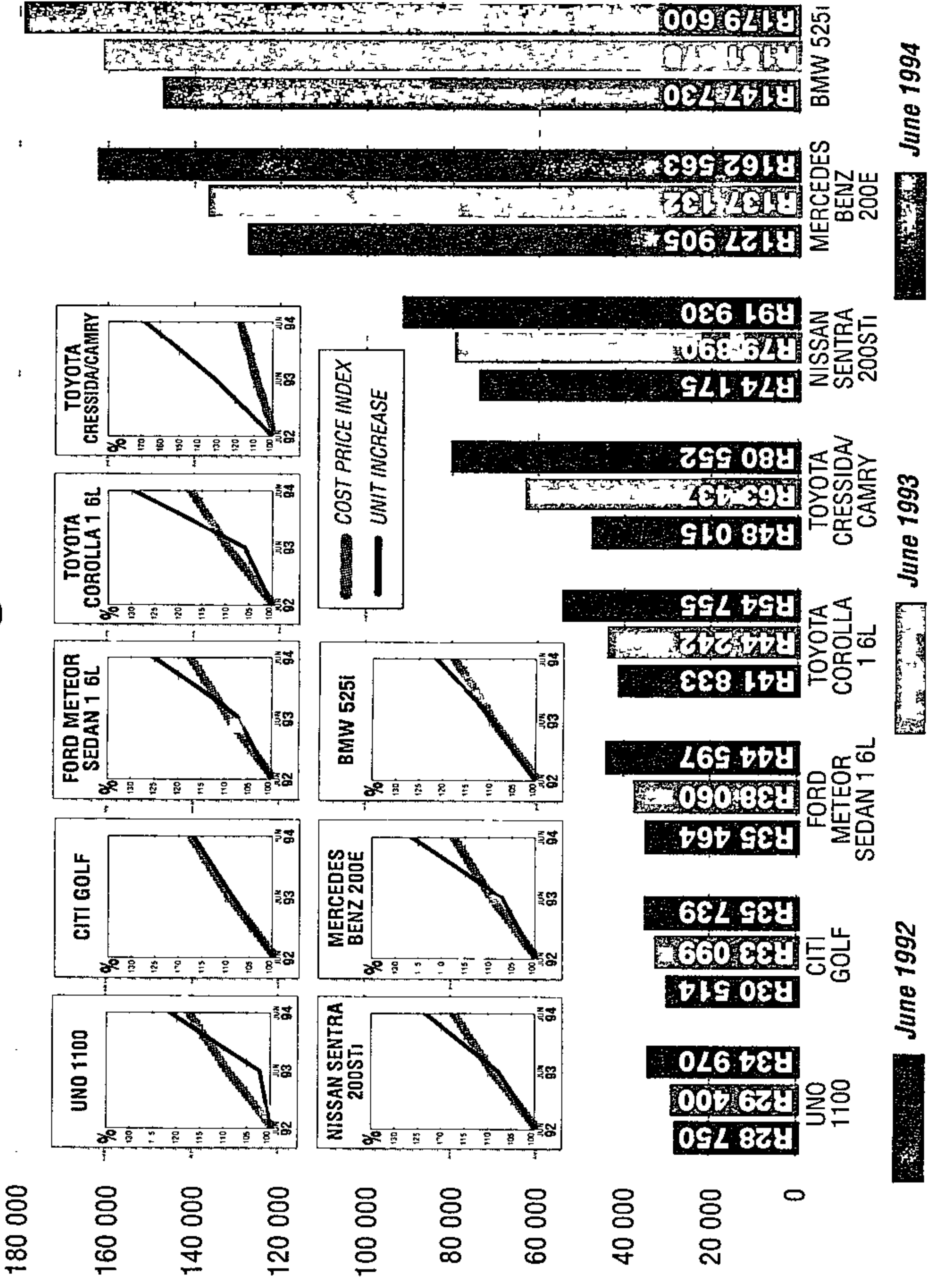

Sparkling performance from Imphold

SAT 25/8/94

■ BY CHARLOTTE MATHEWS

Diversified motor and transport group Imperial Holdings (Imphold) achieved a 62 per cent increase in attributable earnings in the year to June to R70,7 million on the back of good performances from all divisions, especially car rental and finance

Executive chairman Bill Lynch said yesterday the group had had a successful year in which it had concen-

trated on bedding down the R250 million of acquisitions made in the last three years

He forecast another successful year, with all businesses set to benefit from the upturn, especially local and foreign businesses, leisure travel, transport, motor trading, vehicle rental and leasing and consumer-related insurance

Turnover rose 37 percent to R1,5 billion, but operating profit was only 23 percent higher

at R134,1 million because of the acquisition of lower-margin businesses and the over-traded markets in which the group operates (192)

In response, the group concentrated on higher productivity, customer service and good financial management

On an increased number of shares in issue, earnings were 31 percent better at 76,8c a share. A dividend of 29,3c (22,4c) a share has been declared

81
25

COMPANIES

Uncertainty over incentive plan

PLAYERS in the autocatalyst industry have called on the government for clarity on its support for the industry.

Sources said uncertainty surrounding the future of Phase VI of the government's export incentive scheme had already cost the industry a number of orders from overseas motor manufacturers.

They said the period of the phase-out of Phase VI needed to be published, so that the industry knew what the goal posts were and had time to wean itself off incentives.

The autocatalyst industry — which is currently uncompetitive on world markets — would need support until it had built up enough demand to make it efficient in terms of economies of scale.

Samcor components export director Rob Boyd said SA autocatalysts were un-

MICHAEL URQUHART

competitive in price as well as in flexibility of supply. *BIDAY*

However, given sufficient time and protection under Phase VI to build up volumes, the industry could become competitive over the next three to five years.

He said the only reason autocatalyst manufacturers had come to SA was because they were promised subsidies until mid-1997. Because autocatalysts were an export business, the potential sales volumes were enormous. *20/8/94*

Current SA production was in the region of 1.3-million units a year, compared with total world production of 40- to 45-million units a year. Total production capacity in SA was about 6-million units. *(192)*

Govt loses R20-m a day in taxes

Strike crippling motor industry

Star 20/8/94

BY ABDUL MILAZI

The 20-day-old motor industry strike is one in which no one appears to be a winner. Even if it ended today, it would take until mid-1995 for the industry to recover.

The action by automobile workers is crippling the motor industry, with about R2 billion already lost in production, tax and wages, the Automobile Manufacturers Employers' Organisation (AMEO) said yesterday.

AMEO acting chairman and labour specialist Harry Gazendam said manufacturers were losing R100 million a day in lost production, amounting to R1,9 billion since the beginning of the strike (192) (192)

The Government is also losing — to the tune of R20 million a day in taxes, totalling more than R300 million to date.

Workers are losing about R3,5 million in wages a day and have already lost more

EVERYONE is suffering in the motor industry strike, which has cost SA about R2-bn

than R50 million since the beginning of the strike.

Gazendam said that the R2 billion lost would probably never be recovered. He said if the strike ended today, it would take manufacturers until at least the middle of next year to recover fully.

At least 18 car-parts manufacturers have closed since the beginning of the strike and more were expected to close as the strike continued.

Gazendam said the effects of the strike were slowly reaching the industry's downstream level: the dealers, car-ferry services and small components shops.

Many car dealers in and around Johannesburg said they were sitting with huge orders but no cars to sell.

Sales at Clarke Nissan in Randburg had dropped from 80 to 20 cars a day since the beginning of the strike.

Clarke Nissan fleet sales manager Brenda Bathalomeau said the strike had hit them at a time when Nissan had just launched a new product. She warned that companies would be forced to re-trench as a result.

The strike was also beginning to hit salesmen, many of whom were paid on a commission basis.

However, salesmen interviewed said they had not been affected yet, but feared the coming days could be tough.

Clarke Nissan's fleet sales consultant Pam Howse said she still made between R3 500 and R6 000 commission, but feared she would make less if the strike continued. Already the signs were there, she said. She had a large order for Unos, but there were none in her showroom.

Car strike 'a catastrophe'

(192) (192) ARG 26/8/94

The Argus Foreign Service

tions in South Africa.

HAMBURG.— The car strike in South Africa has thrown Mercedes-Benz operations in the country back at least two years, chief executive Christoph Koepke said in the German daily Die Welt.

"The strikes are a catastrophe", said Mr Koepke, who heads Mercedes-Benz opera-

Die Welt agreed that the strikes had come at a bad time. "Just when foreign investment has to be drawn into the country, confidence in the process of economic stabilisation is being undermined. American firms have already declared that planned investments were being put on ice."

LI 27/8/94

New offer could end auto strike

(192) ~~192~~
Own Correspondent

PORT ELIZABETH — After talks between Labour Minister Mr Tito Mboweni and four motor company chief executives here yesterday, the manufacturers made a new pay offer that is expected to end the national strike

The Automobile Manufacturers Employers' Organisation (AMEO) said it was increasing its offer from 10 to 10,5%

Although there was no immediate response by the National Union of Metalworkers (Numsa), the union had indicated acceptance of 10,5% when talks stalled on 10% earlier in the dispute

Last night AMEO chairman Mr George Stegmann of Delta appealed to both Numsa and the Iron and Steel Workers' Union to take the new offer back to their members at report-back meetings scheduled at all seven manufacturing plants on Monday

Honorary consul José
Ruy team early 1995
said the economy

Car strike batters exports

S Times (Buss) 28/8/94

By DON ROBERTSON

THE strike by 25 000 assembly line workers could have a major impact on the motor industry's fledgling export market.

The stayaway is already affecting Volkswagen, which is contracted to supply China with 17 000 Jettas, a long-term order worth R350-million this year alone.

Ernie Barber, Volkswagen's finance director, says he is concerned about the harmful effects of the strike.

"We are currently negotiating with our Chinese customers to reschedule shipments of Jetta," he says. "We are acutely aware of the negative impact industrial action has on our ability to negotiate future orders"

In 1992, exports of completely built-up units (CBUs) amounted to R50-million, rising to R313-million in 1993 CBU exports

this year are forecast at R685-million and total exports, including components, were expected to exceed R2-billion.

Projections formulated by manufacturers in July — the strike began on August 1 — put domestic new car sales at 200 000 and light commercials at 102 500, but the National Association of Automobile Manufacturers (Naamsa) says these figures "appear optimistic" (192)

Industrial action and public holidays, particularly during April, have contributed to 15 500 vehicles being lost to production in the first six months of the year.

OR
AS
he
he
n"
o-
u-
ill
it,
or
ut
r,
gn
re
a,
id
r-
w
id



LABOUR CORRESPONDENT/JOVIAL KANTAO
MONDAY STRIKEWATCH

THE PARTIES	DISPUTE	STATUS
Numsa v Auto manufacturers	25 000 want 12% Offer: 10% + 1% ex gratia payment	4th week of legal strike Tense talks continue
Numsa v Tedalex	450 demand 25% across board Offer: 9,5%	2nd week of illegal strike
SA Chem WU v Dulux, Alberton	200 unhappy about treatment of casual workers	3rd week of illegal strike Talks go on Pickets
Numsa v NF Die Casting (2 plants in Alrode)	200 sacked at first plant after protest about alleged racism of a boss	150-200 in second plant start illegal sympathy strike. No talks

OTHER MATTERS

Num v Chamber of Mines	200 000 want 11% across the board Final offer 9,75%	Agreement to be signed today
	Plus second dispute over education and training	Conciliation board being set up.
Num v De Beers	6 000 want 15% across the board Offer 9,7%	Conciliation board to meet this week
MWU v Chamber of Mines	20 000 want 10 to 12% increase. to 8,5%.	Conciliation board.
Num v Richards Bay Minerals	4 000 want 10% Offer: 8%	Conciliation board being set up
Nehawu v KZ/Natal hospitals (King Edward VIII, Clairwood, Addington, others)	4 000 demand higher wages, better working conditions, racial equality	Interdict threatened

'Last chance to end car strike'

Port Elizabeth — Volkswagen and Delta have jointly made an impassioned plea to workers to accept the latest offer of a 10,5 percent wage increase before the motor industry suffers "irreparable damage"

The industry's worst-ever nationwide strike enters its fifth week today and fears are mounting over the spin-off effect on component manufacturers

In a joint statement yesterday, Delta managing director Willie van Wyk and Volkswagen counterpart Peter Searle said report-back meetings for employees today were critical and a last chance to end the strike

The Automobile Manufacturers Employers Organisation (Ameo) made the new offer — a 10,5 percent increase on actual wages backdated to July 1 — on Friday, following surprise talks between Labour Minister Tito Mboweni and four motor company chief executives

Talks between the organisation and the National Union of Metal-

workers of South Africa stalled earlier when employers offered 10 percent and the union indicated it would accept 10,5 percent **29/8/94**

"I think our offer is extremely reasonable and it meets the indications of the union two weeks ago," said Van Wyk last night

"Hopefully the union leaders see it that way and will encourage their workers to come back to work. **(192)**"

When the new offer was made, Ameo chairman George Stegmann, of Delta, said the strike had cost the industry R2,2 billion in turnover, the Government R400 million in taxes, and employees R70 million in lost wages

Searle and Van Wyk urged employees to "seriously consider" the damage the strike was doing to the Port Elizabeth-Uitenhage economy

And an unquantifiable and "most-damaging" cost would be the loss of credibility for the motor industry, which was trying to become export-orientated — Sapa

Strikers' meeting today tipped to refuse pay deal

192 ~~192~~ ARG 29/8/94

The Argus Bureau

PORT ELIZABETH.— Motor industry strikers gathered in the Eastern Cape today amid speculation that they would refuse the latest offer of a 10,5 percent pay increase from management.

It will be known only late tomorrow whether normal production will be resumed this week.

The strike by members of the National Union of Metalworkers of South Africa is now dragging into its fifth week, and has cost an estimated R2 billion.

In spite of impassioned pleas from the chief executives of Delta and Volkswagen in Uitenhage to strikers to accept the latest 10,5 percent offer before irreparable harm is done to the industry, there are doubts that strikers will be happy with offer.

Two weeks ago they indicated they would accept a 10,5 percent increase, but the Automobile Manufacturers' Employers' Organisation (Ameo) rejected this demand, saying they would not go beyond 10 percent.

On Friday Ameo made the 10,5 percent offer at a formal national bargaining forum

meeting shortly after Labour Minister Tito Mboweni met the chief executive officers of four manufacturers and was briefed on developments by Numsa officials.

Numsa general-secretary Enoch Godongwana said he had the impression strikers might not accept the offer being discussed today.

He said an Ameo advertisement showed employers were offering a 10 percent increase, plus a further one percent supplementary monetary award that in effect would equal the 10,5 percent increase.

The major difference thus far had been over whether the one percent would be added as a supplementary award or whether it would be added to the 10 percent base rate demanded by Numsa.

He said Numsa members would look on the extra one percent as a total increase of 11 percent and it was possible they would not accept the final Ameo offer of 10,5 percent.

Gavin Hartford, Numsa national organiser and chief negotiator, would not expand on recommendations, but said if there was a settlement strikers would return to work on Wednesday.

From MICK COLLINS
JOHANNESBURG —

New car sales were expected to plunge 30% this month, and next month's figures would go into free fall as the full effect of the motor industry strike hits home, sources said at the weekend

This month's sales would be down to about the 12 000 level from an original forecast of more than 17 000 units August was traditionally a good month "but this has now been wiped out by the strike", one source said

National Association of Automobile Manufacturers of SA (Naamsa) director Nico Vermeulen said September sales would reflect the "chronic" position

"There was some stock in the pipeline in the initial part of August and while the industry will report sharply reduced sales for the month the real crunch will come in September," he said

Manufacturers had stock

Strike puts the skids under new car sales

CT 29/8/94
levels that kept supplies going for two to three weeks when the strike started on August 1 "But most inventories ran out 12 days ago" (192) (S)

The strike by 25 000 assembly workers is now entering its fifth week.

The National Union of Metalworkers of SA is expected to report to its membership today on a new across the board wage offer of 10,5% from the Automobile Manufacturers Employers' Organisation (Ameo) The offer is backdated to July 1 The union had indicated acceptance of 10,5% when talks stalled on 10% earlier in the dispute

Ameo said at the weekend that the strike had cost the industry R2,2bn in turnover, and government more than R400m in rev-

enue Suppliers, meanwhile, are estimated to have lost R20m in revenue each working day, and several component manufacturers halted production last week

Econometrix economist Tony Twine said dealers started to get "the dregs" of the delivery pipeline on about August 10, but this had since dried up

"We will see that September will be extremely problematic Once the strike is over the rate of production in the first few days will be critical as to how retail sales for the month will turn out"

If workers decided to go back to work this week the industry could just about scrape 10 000 units in retail sales for September "by the skin of our teeth", he said

S
RE
U
S
TF
th
be
st
ar
se
af
st
a
J

US group injects R3.6m

Mercedes workers accept new pay offer

EAST LONDON — Striking Mercedes-Benz of South Africa employees here unanimously decided yesterday to accept the new pay offer by the Automobile Manufacturers' Employers' Organisation

The new Ameo offer of a 10,5% increase on actual wages backdated to July 1 was made last Friday

Border chairman of the National Union of Metal Workers of South Africa Mr Ludwe Bakaco said Numsa would be forced to end the five-week-old strike if the majority of workers at other motor industry plants also accepted the offer

He described the meeting with the 2 000 hourly-paid MBSA workers as "very constructive and positive"

Their decision would be tabled by MBSA shop-stewards at a national meeting of auto industry shop-stewards in Port Elizabeth today

Delta Motor Corporation indicated workers had not accepted the 10,5% offer and were sticking to their demand of 12%

CT 30/8/94 (192) 155
They confirmed white-collar workers were called in to help complete a number of Isuzu units that were close to completion before the strike

The company's corporate communications manager, Mr Ed Emmett, said all available labour resources were concentrated on completing these units — including office staff

A Volkswagen spokesman said that despite speculation the company had no intention of calling in white-collar workers to work on the VW China export cars

MBSA employees spoken to said the offer was reasonable and they hoped other striking workers would take the same view

A final decision on whether to accept the offer or continue with the strike will be taken tomorrow after plant level report-back meetings by the shop stewards

Mr Bakaco said the strike would continue if the majority of motor manufacturing plants rejected the 10,5% offer

Decision today on 10,5% car offer

192
ARG 30/8/94

PORT ELIZABETH — A final decision is expected today on the latest pay offer to striking car workers and the industry has warned it is considering importing vehicles

Automobile Manufacturers Employers' Organisation deputy chairman Harry Gazendam said a negative response to the offer would have disastrous implications for assemblers, component suppliers and dealers.

He said the employers would not change their offer and if faced with a prolonged strike would have to "seriously look at importing vehicles"

In that case the industry would have to be rationalised, with a major impact on the labour force — but the industry would not be destroyed.

Asked if employers would ask the government to intervene or ask President Nelson Mandela to decree a strike settlement, Mr Gazendam said they would "not be so presumptuous as to prescribe to govern-

ment what it should do".

Mercedes-Benz employees indicated yesterday that they would accept the 10,5 percent offer but Delta workers said at a mass meeting they would not return to work until they were given 12 percent

A final decision on the offer will be taken by shop stewards of the National Union of Metalworkers of South Africa today.

Employees at plants around the country held meetings yesterday to decide on the offer, which was raised from 10 percent on Friday after a meeting between employers and Minister of Labour Tito Mboweni.

Numsa Border chairman Ludwe Bakaco said the union would be forced to end the five-week-old strike if most strikers accepted the offer.

A Delta spokesman said today there had been many reports of strikers intimidating workers but they had not been referred to the police for fear of the consequences. — Sapa

Acceptance of offer in balance

It's make or break for auto sector

Star 30/8/94

■ BY JOVIAL RANTAO
LABOUR CORRESPONDENT

Employers in the motor industry, which has been paralysed by a strike involving more than 25 000 workers, will know today whether their revised offer will be accepted by members of the National Union of Metalworkers of South Africa.

Numsa's national auto shop-steward council is to meet in Port Elizabeth today to review the decision on whether their members would accept the Automobile Manufacturers Employers Organisation's (Ameo) revised offer of 10,5 percent.

By late yesterday, indications were that the majority of the seven manufacturing plants involved in the strike were against accepting the offer.

The South African Motor Corporation (Samcor) said striking workers at its Pretoria plant had rejected the increased wage offer following plant-level discussions.

Earlier reports indicated that strikers at the Delta Motor Corporation in Port Elizabeth had also rejected the offer.

If workers reject Ameo's offer, the shop steward council is unlikely to overturn its decision — dashing hopes of a resolution

to the strike, which is in its fifth week.

Ameo has made an appeal to Numsa members to favourably consider the offer, which was made after Numsa rejected an offer of 10 percent plus a 1 percent ex-gratia payment in January (192) (192)

Ameo moved from 10 to 10,5 percent on Friday, following another non-prescriptive intervention by Labour Minister Tito Mboweni in the dispute.

Mboweni held two separate meetings with Ameo and Numsa on Friday.

Ameo vice-chairman Harry Gazendam said the revised offer was made in the interest of resolving the strike.

Two weeks ago, Numsa offered to accept a 10,5 percent increase but reverted to 12 percent after Ameo refused to move from 10 percent.

The strike has cost manufacturers more than R2 billion in turnover, the workers more than R50 million in wages and the Government in excess of R300 million in taxes.

The strike has also had knock-on effects in the component manufacturing sector, where more than 5 000 workers have been laid off and many more put on short time.

Motor sector strike set to continue

ERICA JANKOWITZ

NATIONAL Union of Metalworkers of SA members voted yesterday on whether to accept employers' revised wage increase offer of 10,5% and end the motor strike which entered its fifth week yesterday.

However, Union officials felt the offer might be rejected. Reuter reported last night that Samcor said workers at its Pretoria plant had rejected the offer. There were also reports that Delta workers in Port Elizabeth had also refused to accept the offer. Numsa is demanding a 12% rise.

The union said it would hold a shop stewards' council meeting in Port Elizabeth today, after which employers would be told the outcome of the vote.

Numsa general secretary Enoch Godingwana said workers had been confused by the different offers tabled by the Automobile Manufacturers Employers' Organisation and advertised in newspapers. The first offer was for a 10% increase on base wages, plus an additional 1% for six months from January. This had been interpreted as an 11% offer. (1924)

The 10,5% new offer was therefore unlikely to find favour, although it met an unmandated union settlement proposal tabled in the first week of the strike.

Yesterday, the SA Iron, Steel and Allied Industries' Union, representing skilled workers, accepted the 10,5% offer. Yster en Staal said it had been mandated by members to mediate between Numsa and Aameo so that production could resume.

Motor workers spurn latest wage offer but lower demand to 11%

THE National Union of Metalworkers of SA yesterday rejected a motor employers' revised offer of a 10.5% wage increase, but revised its demand from 12% to 11% and mandated its negotiating team to achieve the target "by whatever means possible".

After an all-day auto shop stewards' council meeting yesterday, Numsa said members "decisively rejected the 10.5% offer tabled by employers after a four-week strike as it is not seen as a serious attempt to settle the dispute".

The half percentage point separating the parties could be achieved as an add-on to

the basic wage or "in any other form which may result from negotiations".

Numsa called on employers to return to the negotiating team as soon as possible and said it expected its revised position to allow a speedy resolution of the dispute.

However, speaking before Numsa rejected the offer, Automobile Manufacturers Employers' Organisation vice-president Harry Gazendam warned that a negative response would have disastrous implications for assemblers, component suppliers and dealers. Sapa reports that he said the industry was considering importing

vehicles as all production had halted since the strike began on August 1

He said employers would not change their offer, which he described as final. If it was rejected, the industry would have to be rationalised, which would have major implications for the labour force. SA could follow the Australian example, where the motor industry halved the number of models produced, stepped up imports and became more viable.

Numsa denied reports of a split in its

franks, saying Mercedes-Benz workers who had voted to accept the 10.5% offer had agreed to abide by the majority decision and would not return to work today.

Mercedes spokesman Delene Stron confirmed the company had not been finally informed of the workers' decision. "But the plant was open this week and 'some' production" had been achieved on two lines.

Delta Motor Corporation had also achieved limited production for the past few weeks, a company spokesman said.

Meanwhile, 21 component manufacturers had been forced to close temporarily

because of lack of demand for products, National Association of Automotive Component and Allied Manufacturers president John Brandtner said.

About 8 000 workers had been laid off temporarily as a result, he said. Others were earning well below their normal wages as short time had been introduced.

Naacarn had appealed to Labour Minister Tito Mboweni to prevent the strike — now in its fifth week — from devastating the industry. "Urgent, top-level intervention is necessary if we are to rescue our manufacturing capability."

Union holds out for 0,5%

Auto workers reject final offer

Star 3/18/94 (192)

■ BY JOVIAL RANTAO
LABOUR CORRESPONDENT

The five-week strike by 25 000 workers in the motor industry is to continue after workers decisively rejected employers' final wage offer

The National Union of Metalworkers of South Africa (Numsa) yesterday reduced its demand from 12 to 11 percent, effectively rejecting the 10,5 percent offer by the Automobile Manufacturers Employers' Organisation (Ameo)

The decision to revise the demand was taken at a national auto shop steward council meeting in Port Elizabeth yesterday to consolidate man-

dates from workers who had held meetings on Monday to consider the employers' offer

Numsa spokesman Roger Etkind said the shop steward council had mandated Numsa's bargaining committee to achieve the 0,5 percent — which constituted the current difference between the employers' offer and the union's latest demand — by any means necessary

And Numsa said yesterday that contrary to reports, Mercedes-Benz delegates and workers were fully committed to the decision to continue the strike

Ameo vice-chairman Harry Gazendam said al-

though he had not been officially notified of Numsa's position, it was distressing that workers had rejected the employers' offer

"We've tried everything in our power to resolve the dispute," he said, adding that employers would be willing to manipulate their package within the confines that they had outlined

Ameo's offer came after Numsa rejected an earlier offer of 10 percent plus a 1 percent ex-gratia payment in January. Ameo moved from 10 to 10,5 percent on Friday, following another "non-prescriptive" intervention by Labour Minister Tito Mboweni.

Heavy (192)

vehicle

0731/8/94
price cut

JOHANNESBURG. —
Mercedes-Benz South Africa is to cut the price of its heavy vehicles by 2,5% on September 12 despite a strike that has cost it about R370 million in turnover

MBSA chairman Mr Christoph Kopke said it was the first price cut in the local motor industry

Demand was rising in the long-term, but the strike had limited sales.

"The demand is there. It just depends on whether we can catch up," board member Mr Peter Senger said

He said MBSA would record an unprecedented 3 000 new car and truck sales for August, despite the five-week strike

However, if the strike continued for two more weeks the company might lose up to R75m

Mr Senger said the strike was jeopardising the industry's plans to boost efficiency. — Sapa

Mercedes to raise output

MERCEDES Benz SA (MBSA) would increase its production from 21 000 vehicles this year to 35 000 next year, chairman Christoph Köpke said yesterday **5/15/94**

Köpke said the company would also reduce the price of its heavy vehicles 2,5% on September 12 — in what he said was the first price cut in the SA motor industry

MBSA had clocked up a record turnover of R435m in July. It had also achieved record retail sales in August despite the 21-day strike at its East London plant which had wiped out R371m in turnover

He said MBSA's 10,5% wage increase settlement would be hard to justify to international investors

Köpke said the motor industry tariff proposals outlined by the Board on Tariffs and Trade — which rejected several proposals by the industry, unions and government in favour of a gradual cut in import tariffs to 30%

MUNGO SOGGOT

by 2003 — were "basically good. We can live with them" **3/18/94**

He dismissed talk that the company would leave SA, and said it intended to be the most efficient local manufacturer by 1996

He said the motor industry was better placed than others to survive the removal of tariff barriers because it overcame Phase VI of the local content programme, which forced more efficiency **(192)**

Management Board member Peter Cleary disputed the perception that all SA car makers "ripped off" the consumer. He said the company's new C class car — which would form the backbone of MBSA's high volume production strategy — was 5,6% cheaper than in Britain and 6,8% cheaper than in Germany

Board member Peter Senger said MBSA's profit for 1994 was likely to be sharply up on 1993's R28m

Numsa rejects latest pay offer

CT 31/8/94 (192)

PORT ELIZABETH — Striking motor industry workers have rejected the 10,5% pay hike offer from employers after a meeting of National Union of Metalworkers of South Africa (Numsa) shop stewards yesterday

Numsa has, however, revised its wage demand from 12% to 11% Numsa said that contrary to press reports, Mercedes Benz workers at the company's East London plant were fully committed to the decision

Shop stewards had rejected the offer as they did not consider it a serious attempt to settle the dispute

They had, however, decided to drop their demand and to mandate the Numsa bargaining committee to achieve the remaining 0,5% demanded increase "by any

Employers warn of importing

means necessary"

"Numsa therefore calls upon employers to come back to the negotiating table We anticipate that our revised position will facilitate a speedy resolution to the dispute," the statement added

Earlier yesterday, the Automobile Manufacturers Employers' Organisation (AMEO) deputy chairman Mr Harry Gazendam said a negative response to the offer would have disastrous implications

He said employers would not change their offer and if faced with a prolonged strike would have to "look seriously at importing vehicles"

Asked if employers would request government intervention, Mr Gazendam said they would "not be so presumptuous as to prescribe to government what it should do"

The employers' offer was raised from 10% on Friday after a meeting with Minister of Labour Mr Tito Mboweni

Mercedes-Benz employees on Monday had indicated they would accept the AMEO's 10,5% offer and that the decision would be tabled by their shop stewards at the national meeting

After the national meeting, however, Numsa said Mercedes Benz shop stewards were fully committed to the union's rejection of the offer — Sapa

McCarthy shrugs off strike effects

2150
MUNGO SOGGOT

RETAIL group McCarthy expected an increase in profit for the 1995 financial year, despite the effects of the motor strike and a lack of consumer confidence, CE Terry Rosenberg said in the annual review 4110194

"We are confident that with our manufacturers' aggressive build programmes, we will achieve our budgets for the year"

McCarthy's share of the dealer market had remained at 13%, after sales of 33 813 vehicles during the year. The group was considering expanding further into Africa after its successes in Lesotho, Swaziland and Botswana.

The group's used vehicle, parts and workshop departments now contributed 61% to the profit of its motor holdings division. (19)

Budget Rent-a-Car had secured a 23,5% share of its market.

Both McCarthy's furniture division and its clothing division, Bee Gee, had performed better than had been expected.

Eskom's electrification drive, which could lift the appliance/TV market from R4,1bn to R10bn over the next five years, was likely to boost the group's electrical appliance sales. (192)

Call to slash heavy vehicle tariffs to 50%

BIDay 5/10/94

xx

MICK COLLINS

THE motor industry task group has called for import tariffs on heavy vehicles to be cut to 50% — more than a third below current levels — in a move to open the market up to international players

The government-appointed group, which is charged with formulating proposals to restructure the sector, said the industry was "too cosy" and such cuts were needed to bring down costs

Economists said the proposals could lead to job losses in the R1,75bn-a-year industry, though the Industrial Development Corporation (IDC) said this would be balanced by higher exports and general gains across the economy (192) (245)

The hard-hitting report, which follows the task group's similarly radical proposals for the car industry this year, also calls for the scrapping of all excise duties on commercial vehicles from January

Group chairman Derek Reily said "strong pressure" should be brought to bear to make the sector more competitive

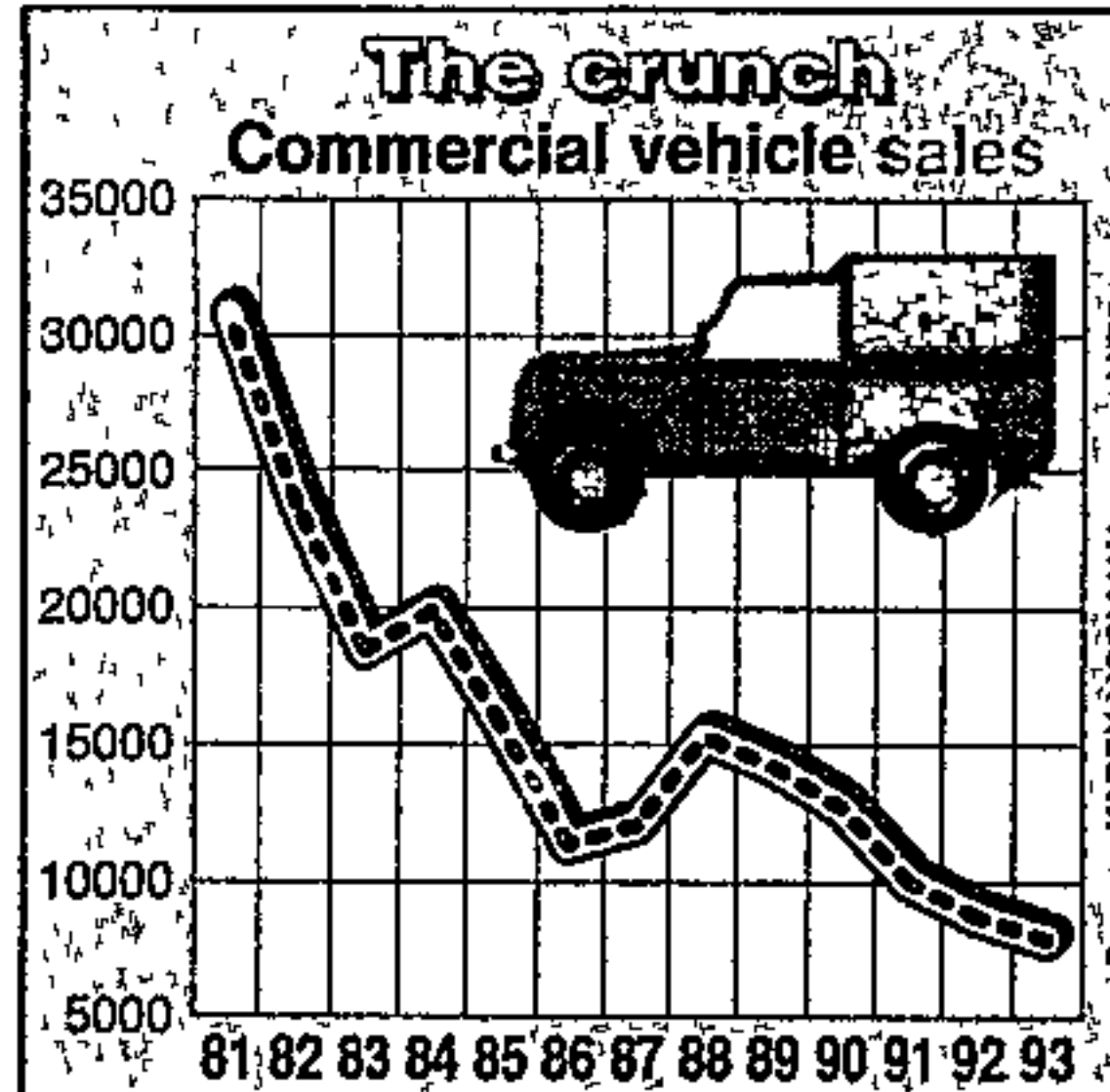

Duties were cut last month from 100% to 80%, and a 5% surcharge was chopped

The group recommends the dropping of minimum local content requirements for vehicles and chassis and the scrapping of surcharges on components used in new vehicle manufacture/assembly

It proposes the progressive reduction of

□ To Page 2

Motor tariffs

BIDay 4/10/94

From Page 1

import tariffs to January 1 2002 on completely built up (CBU) units and engines from 50% to 30% and 25% respectively. Tariffs on transmissions and axles should be reduced from 30% to 15%, on cabs from 20% to duty free, and other parts should become duty free in January.

To encourage exports, vehicle and component manufacturers, as well as non-manufacturers who import and export CBU vehicles and components, should be allowed to work towards complementing imports and exports. All CBU import duties should be rebateable on a rand-for-rand basis against exports. (192) (245)

Reily said the recommended levels for medium and heavy commercial vehicles, while lower than those recommended for cars and LDVs, were "still too cosy" and unlikely to exert sufficient downward pressure on vehicle prices

He said the IDC looked at three scenarios. The first reduced tariff protection on motor vehicles from 100% to 45% and on components from 50% to 30%. The second proposed reducing to 30% the protection on vehicles and components by 2003. The third looked at the removal of all import protection. "All three show that there will be benefits to the total economy", offsetting the net losses to the local and component industries

New commercial vehicle sales have fallen from 30 702 units in 1981 to 7 869 units in 1993. But the replacement needs of the existing commercial vehicle population — about 300 000 strong — provide a basis for future growth

The task group noted with concern the high cost of diesel fuel at 166c/l and recommended that this be investigated by a motor industry authority, which the task group recommended be formed

Motor industry to bare strike scars

THE scars left on the motor industry from the recent five-week strike will be made visible today when the figures for September's car sales are released

The figures, from the National Association of Automobile Manufacturers of SA, are likely to show a sharp fall in sales of cars and light commercial vehicles.

Sources said yesterday new car sales for the month had plummeted 40% to 11 000 units compared with the corresponding month last year

The light commercial vehicle sector is expected to follow a similar pattern with figures expected to come in 30% down at 6 000 units. Sales of heavy trucks will be unaffected by the strike, the sources say.

Meanwhile, several motor manufacturers yesterday announced plans to make up production lost during the 26-day strike

B1 Day 7/11/94

MICK COLLINS

Volkswagen SA (VWSA) and Delta said catch-up plans involved recruiting additional staff, while Nissan said no extra staff had been hired but 6 000 more units would be produced before the year end

Nissan marketing director John Jessup said the company had successfully negotiated an agreement with the unions to work overtime for the balance of the year. The move would increase daily output to 385 units a day from the usual 310 units

"Prior to the strike Nissan was manufacturing at full capacity and the company had already announced a capital expenditure programme of over R100m to increase capacity from 58 000 units a year to 78 000 units by the end of 1995," he said

192

To Page 2

Cars

Delta spokesman Ed Emmert said the catch-up programme was proceeding so well that the company had decided to discontinue its six-hour Saturday shift, which it had implemented immediately after the strike ended. But the company would continue its two hours a day overtime plan to reduce the 45 000 unit backlog. An additional 400 workers would start working a second shift this month

VWSA said 5 000 vehicles had been built

From Page 1

since its Uitenhage plant reopened on September 12 and 262 temporary operators had been employed. A daily production target of 300 vehicles had been set after the strike, which was a 20% increase on the daily average number of cars produced during the first six months

Technical director Hans-Jurgen Wiegand said VWSA aimed to raise production to 350 vehicles a day by the month's end

MOTOR INDUSTRY

Row brews over heavies

192

Don't expect a painless resolution of the South African truck and bus industry's future — not when the chairman of the industry's strategy committee distances himself from his own committee's recommendations

As chairman of the government-appointed Motor Industry Task Group (MITG), Derek Riley has overseen the preparation of strategy proposals for both the light and heavy vehicle sectors. The light-vehicle report was published early this year and is now undergoing surgery by the Board on Tariffs & Trade (BTT).

The heavy vehicle report is released this week. As with its predecessor, Riley declares himself unhappy with key elements. In both instances his complaint is with what he considers the slow rate of reduction in tariff protection.

He says "The recommended duty levels for medium and heavy commercial vehicles, while lower than those recommended for cars (and light commercial vehicles) are, in my view, still too cosy."

By that he means the report reflects too closely the wishes of the main players in the motor industry — vehicle manufacturers, components suppliers and unions. Other groups were represented on the MITG but the report bears the stamp of the majority.

Interestingly, that majority was among the last to know what had been decided. The report was circulated to

journalists late last week. Contacted on Tuesday this week for their comments, vehicle and components manufacturers confessed they hadn't seen the final report and didn't know what it contained.

Chief recommendations of the MITG report relate to reducing the high level of protection currently enjoyed by the local industry. The present import duty on a fully built-up truck or bus stands at 80%, having recently dropped from an effective 115%. The report proposes this be reduced further to 50% on January 1 1995 and, thereafter, in stages to 30% by 2002. By also recommending that partly built vehicles be subject to the same import duty as fully built ones, the MITG is trying to ensure that newcomers can no longer take advantage of

loopholes allowing them to escape duties by performing limited assembly in neighbouring countries.

There are also declining tariff schedules for heavy vehicle engines, transmissions, axles and cabs. For engines, it is recommended that between 1995 and 2002, duties fall from 50% to 25%, for transmissions from 30% to 15%, for axles from 30% to 15% and for truck cabs from 20% to nil. In the first three cases, the proposals are intended to offer continuing limited protection to Atlantis Diesel Engine and AS Transmissions & Axles, both of which have enjoyed virtual sole-supplier status in the past.

According to the report, fitment of local powertrain components adds 11,4% to the overall manufacturing cost of a medium-sized truck, 13,5% to a heavy truck and 17,9% to a bus. Compared with imported components, local powertrains are 25%

costlier on medium trucks, 38,9% on heavies and 54,4% on buses.

The report proposes that all excise duties on commercial vehicles and chassis be discontinued from next January 1. Other proposals include the scrapping of minimum local content requirements, that import duties on built-up vehicles and aftermarket parts be fully rebateable on a rand-for-rand basis against exports of components and built-up vehicles, and that there should be a duty rebate on what the MITG calls sub-

components imported for the manufacture of new vehicle components.

Riley's reservations on the recommended pace of tariff protection reform are not his alone. As the report reveals, there are considerable differences between the various industry parties.

For instance, MITG insiders say it was only at the insistence of the industry's main union, the National Union of Metalworkers (Numsa), that the phasing-down period for tariffs was held at eight years. Vehicle manufacturers, it is understood, were prepared to settle for five. Numsa also wanted higher initial protection in the early years of the programme.

The Road Freight Association (RFA), representing the road haulage industry,

makes it clear it is unhappy with the entire plan. It wants import tariffs down to zero within two years and warns that failure to implement drastic tariff reductions will torpedo the RDP.

"Successful implementation of the RDP in this (transport) industry is almost totally dependent upon the decision of the MITG to reduce entry levels dramatically," says RFA CE Ian Moss. Continued high prices, with accompanying interest costs and insurance premiums, will prevent the entry of entrepreneurs into transport, he says.

The overall aim of the report is to make the local commercial vehicle industry internationally competitive. That's a tall order, given the tiny volumes currently produced locally. Unlike the car and light commercial vehicle market, there must also be doubts about the potential for exports.

The eventual outcome could be cheaper trucks and buses. Mercedes-Benz's recent announcement of a 2,5% price drop on some of its models is evidence of growing market competition. The degree of change, however, will be decided by the final industry plan once it's been through the BTT and government. Based on early impressions, there'll be a lot of blood-letting before a final plan is approved. ■

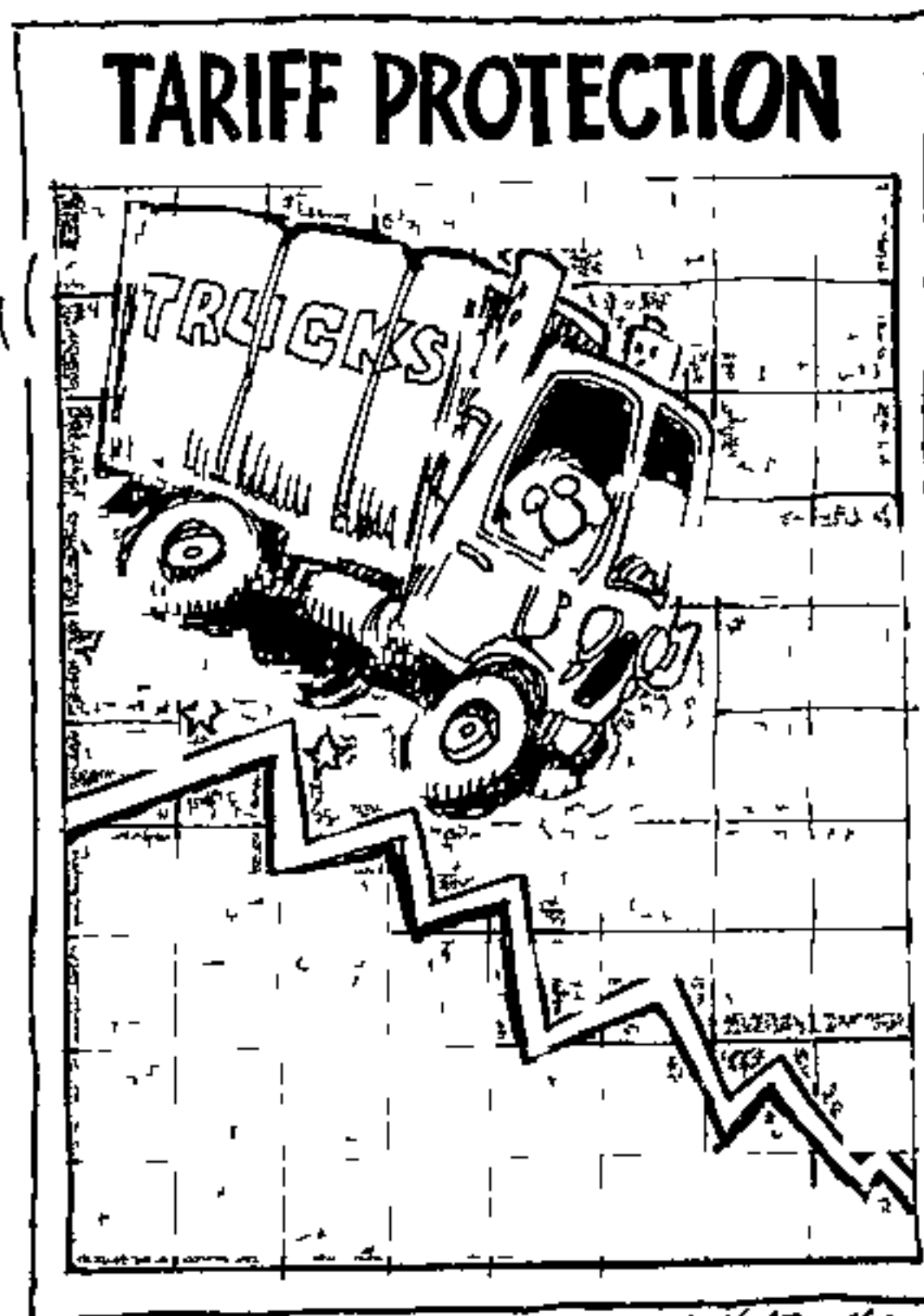

MOTOR INDUSTRY

Industry enters the world

TOS WENTZEL reports on the implications of the reduction of import duties

THE reduction of import duties and the scrapping of an additional surcharge on imported cars have come as a shock to workers in the motor manufacturing industry.

It has also served to remind them and workers in other sectors of industry such as textile manufacturing that the country is no longer living with a siege economy, that it has obligations in terms of the General Agreement on Trade and Tariffs (Gatt)

In terms of this agreement South Africa has to phase in cuts in protective tariffs which now often make imported goods uncompetitive and artificially prop up certain sectors of South African industry.

Although this will cause considerable discomfort and require major adjustment, it

is essential if South African industry is to be viable and internationally competitive, without artificial protection through import duties and surcharges.

In all there is a list of some 12 800 products which will to be drastically reduced over a number of years in a move to expose South Africa to untethered international competition.

The cuts affecting imported cars were the first step in a five-year programme of imports duty reductions as part of South Africa's obligations in terms of Gatt.

Duties on imported motor vehicles have been reduced from 100 percent to 80 percent and an additional surcharge of 15 percent has been abolished.

Further import duty reduc-

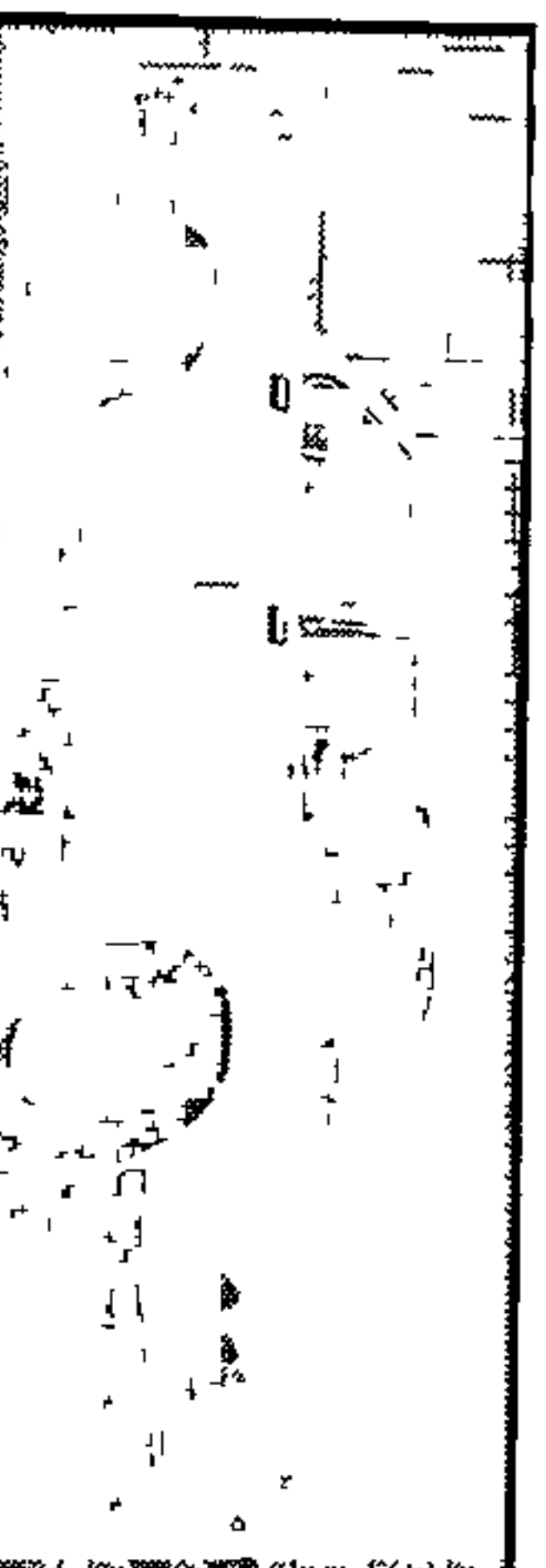
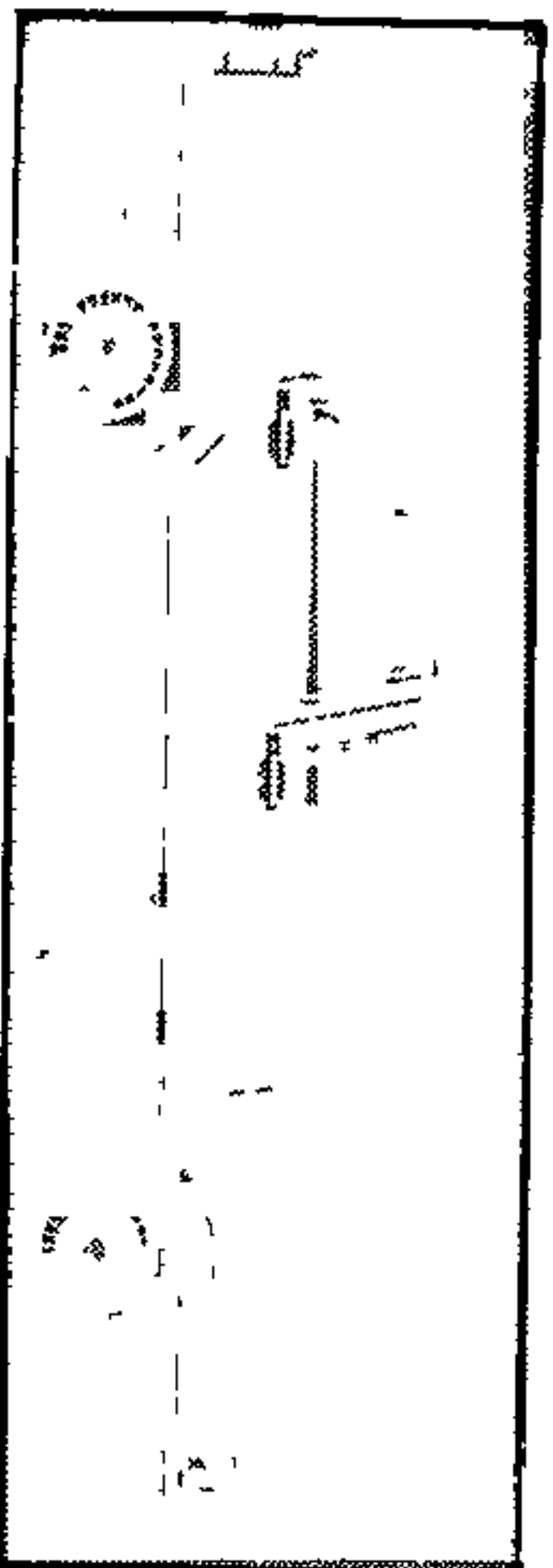

GOING DOWN ... the price of imported cars like these, Lancia, left, and Jaguar, could go down now that the government has reduced import duties.

tions are expected during the next few years, the first being a drop to 70 percent in July next year.

South Africa was one of the founder members of Gatt in 1947.

It has been strengthened and revised several times through extended multilateral negotiations called "rounds" which were named after the cities or countries where negotiations started.

The latest round started in Punta Del Este in 1986 and is called the Uruguay Round.

This round was concluded at the end of last year and implementation is to start by June 1995.

Gatt works according to three principles: reciprocity, non-discrimination and transparency.

Reciprocity means that, if one country lowers its protective tariffs against another country's exports, it can expect the other country to do the same.

Non-discrimination means that all ordinary members of

Gatt must benefit from any country's decision to lower tariffs, though some forms of preferential trade are allowed provided they create trade rather than divert it.

Transparency means that protection, where it exists, must be visible — tariffs rather than quotas on imports.

The Uruguay round also led to the creation of the World Trade Organisation (WTO), a new dispute-settling arrangement which could be used by

the poorer countries to resolve problems.

In the Uruguay Round negotiations South Africa promised it would

● Rationalise the 12 800 industrial tariffs into no more than 1 000 and fix maximum levels for almost all of them by multilateral agreement.

● Cut industrial tariffs by an average of 33 percent by 1999, with maximum levels for consumer goods being set at 30 percent, for capital goods at 15 percent and for

Strike sends car sales to 26-year low

SEPTEMBER'S car sales fell to the lowest monthly level since January 1968 as a result of the motor industry's prolonged strike

With dealers out of stock at the beginning of September, only 11 423 passenger units were sold, most in the last two weeks

September sales were 32% down on the 16 805 sold in August and 35,6% lower than the 17 756 sold in September last year. Sales of bakkies and minibuses suffered similarly. Sales were 6 298 units, 22,6% down on August and 26% off the same month last year

The strike ended on September 6 and since then, all manufacturers have been working overtime to recover at least some of the 43 000 vehicles lost to production

Nico Vermeulen, executive director of the National Association of Automobile Manufacturers of SA (Naamsa), says these "catch-up" programmes have boosted production to annualised levels of about 420 000 compared with expected sales this year of just over 300 000. Not all manufacturers, however, will be able to make up for lost production

With replenished stocks, though, dealers are hoping for increased sales during October of about 20 000 units and between 9 000 and 10 000 light commercials

Latest estimates suggest sales of 195 000 for the year compared with 193 666 last year and 99 000 light commercials compared with 96 534 last year

Despite efforts to boost production, buyers will be faced with growing waiting lists — and higher prices

Most prices are to be increased by an average of 3% in the next few days in

By DON ROBERTSON

what will be the last round of increases for the year

In almost all cases manufacturers have achieved their goal of keeping rises at around 10% as promised at the beginning of the year despite the weakness of the rand and the rising cost of components.

Manufacturers made similar forecasts at the beginning of 1993, but the overall average price rise was a hefty 17%. The increase in the previous year was 11,2% on average

As one marketing director says, "we are just unable to defer price increases any longer"

As it is, price movements expected in June were postponed by a month, setting the latest round a month back

Toyota, however, stole a march on the rest of the industry by deferring its price adjustment for at least a month

"Those customers who have not been able to take delivery of their vehicles (because of the strike) would have been adversely affected by a price increase," says Brand Pretorius, managing director of

Toyota Marketing. Prices will, however, probably move next month

In the price stakes, BMW is perhaps the best performer, having lifted the price of the 3 series by 1% this month and by 2% on average for the full range. The first price rise for the year was 2,5% in July

Volkswagen went up by 2,9% in the middle of the strike on September 19, but was able to hold prices in July, when other manufacturers moved (192)

"Our last increase was in April, when we raised prices by 1,3% on average. Our year-to-date increase before September was 5%, which included major specification changes," says marketing director Graham Hardy

Nissan will move on Tuesday by 3,1%, while the price of Delta vehicles will rise by between 3% and 4%.

Samcor also moved prices on the Ford Laser and Meteor and Mazda 323 during the strike by 3,2% and will lift prices on Tuesday by 4% on the Ford Bantam and Mazda Rustler. Prices of the Ford Telstar and Mazda 626 will increase next month. The average increase for the year will be about 9,5%

Midas gets its old touch back again

MUNGO SOGGOT 13/10/94

MIDAS, the motor parts and accessories subsidiary of McCarthy Retail, reaped the benefits of its restructuring to lift earnings 143% to R5,5m for the six months to August on a 21% increase in turnover to R148m

Earnings a share were 32,7c (22c) and a dividend of 8c was declared

The group said earnings in the second half would continue to improve from last year (192)

CE Sarel de Vos said both the Auto Electrical and Diesel division and the Parts and Accessories division had expanded their franchise base and increased their market share

Earnings had been boosted by R575 000 from its discontinued operations and by R520 000 from the group's associated companies

The company's tax bill nearly tripled to R920 000 from R380 000

Deputy CE Andre Dry said "disciplined" management of working capital cut the group's interest bill to R1,2m (R1,4m), which allowed the group to slash its gearing to 23% from 53%

Shareholders' funds were up at R51,2m from R44m

The company said that as its year end had changed from February 28 to June 30, a second interim report would be issued for the 12 months to February 1995

Buoyant showing from Midas

CT 13/10/94 (192) (1993)

JOHANNESBURG — Motor parts and accessory supplier Midas increased half year earnings to August 31 by 49% and cut its debt by almost half

Midas' interim report, released yesterday, shows attributable profits of R5,5m against R2,2m in the same period last year

Earnings per share for the interim period were 32,7c against 22c previously

Profits for the half year were boosted by the recoupment of R575 000 from discontinued operations, while associated companies chipped in profits of

R520 000 (R366 000)

A four times-covered interim dividend of 8c was declared (5c)

Turnover for the six months was 21% up on 1993 levels, while operating profit came in 50% higher at R6,5m

CE Sarel de Vos said improvements in operating efficiencies gave rise to increased operating margins and continued positive cash flows

"Both the auto electrical and diesel division and the parts and accessories division performed well by expanding their franchise base," De Vos said

October's car sales set for six-year high

MICK COLLINS

NEW car sales for October were expected to reach six-year highs as motor manufacturers worked flat out to make up production lost to strike action, industry sources said yesterday *BIDAY*

National Association of Automobile Manufacturers of SA (Naamsa) director Nico Vermeulen said he expected the month's sales to be between 18 000 and 20 000 units, making it one of the "highest totals seen in years" *20/10/94*

Econometrix economist Tony Twine said, at the current rate of production and given that there were 250 working days in the year, the industry was producing at an annualised rate of 500 000 units. This showed what it was capable of *(1992)*

Most manufacturers had incentive programmes "Labour is co-operating well. Unit sales for October should be at levels last seen in 1989"

He expected total car sales for the year to come in at about 310 000 units "November will be the fat catch-up month"

Toyota SA marketing MD Brand Pretorius said the industry was churning out 2 000 units a day. The industry usually produces 1 300 units a day.

"The year to date sales of 139 693 passenger cars are 7 315 (5%) units down on 1993. The industry was expecting growth of up to 5% for the year"

Pretorius said this placed the industry 14 650 cars behind forecast market demand at the end of the third quarter. But light commercial vehicles were still marginally ahead of 1993 on a year to date basis (596 units or 0,8%). In real terms the industry was running about 3 000 units behind at the end of September.

The only sector significantly ahead was the heavy commercial market, up 7% on last year. But some distortions meant the sector's current performance needed to be viewed with caution.

Catching up after the strike

October new car sales motoring for a record

Star 27/10/94

BY SHIRLEY WOODGATE

October new car sales are expected to reach record highs after the 5½ week long strike in the motor industry sent September sales plummeting to their lowest level since 1968

But despite the successful turnaround achieved after workers put in thousands of hours of overtime, waiting lists for some popular models still extend to January

Predicting sales of more than 18 000 units this month, National Association of Automobile Manufacturers of SA (Naamsa) director Nico Vermeulen said this would boost sales to their highest since 1988

During September new car sales fell by 36 percent to 11 423

SOME models however — like the Golf GTi — still have a backlog stretching into January 1995 (192)

passenger sales, compared with September 1993

The upsurge after the prolonged strike from August 1 to September 6 which cost the industry about 45 000 units was due to contingency measures introduced by manufacturers, resulting in a substantial increase in production

Honda dealers are again able to sell new cars virtually off the floor, said new car sales consultant Jerry Balabanoff

On the other hand, most Volkswagen products remain in short supply, with the waiting list for Golf GTi's extending until January

Dornat Motors sales manager Ernie Phythian said every new car in stock had been sold during the strike and stocks were being replenished

VW spokesman Ernie Smith said contingency measures to catch up the backlog of 45 000 units included working a 60-hour week.

Nissan customer care consultant Kobus de Bruyn said Sentras were freely available after employees started working overtime and staff decided to boost supplies to the public by exchanging their vehicles at 30 000 km instead of 20 000 km

Saficon trebles earnings in spite of motor strike

MICK COLLINS

MOTOR retailer and building products group Saficon more than trebled earnings to R18,2m for the six months to June despite the motor industry strike.

Group turnover increased 18,4% to R1,7bn, mainly on the back of the introduction of the Mercedes-Benz C class model and aggressive selling of all models. A significant contribution was also made by building materials subsidiary Boumat

Operating margins remained constant, but by containing increases in overheads across the group, Saficon more than doubled operating profit to R54,6m. Earnings a share rose to 51c (14c).

After a two-year suspension, the group resumed paying an interim dividend, and a payout of 8c was declared

Pre-tax profit rose 276% to R39,7m and after a tax payout of R16m (R4,2m), after-tax profit nearly quadrupled to R23,6m (R6,4m).

Chairman Sidney Borsook said the results were achieved despite the adverse impact on trading during the elections period and the negative ef-

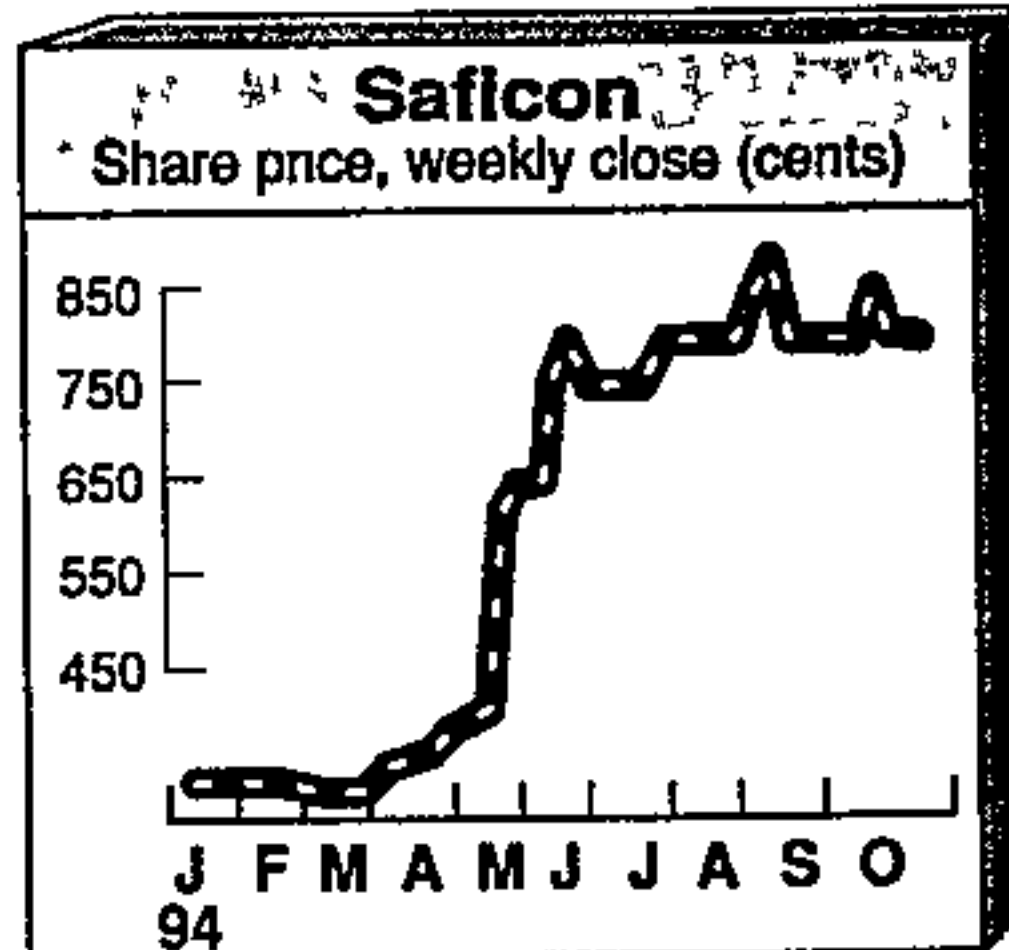

fect of the motor industry strike. He added that tight cost control by management was also responsible for the improved results. "Aggressive selling and strict financial discipline carried over from our reconstruction helped enormously."

Both the motor and building industries had started to show positive growth, and trading conditions had been much better than in the previous interim period (192) (232)

The good results achieved by Boumat relative to the rest of the group resulted in a substantial increase in the share of earnings attributable to outside shareholders, notwithstanding the increase in the number of

Boumat shares held by Saficon during the period.

Borsook expected the supply of new vehicles to improve during the second half of the year.

He said he was confident the group would double first-half results over the full year. "Higher volumes, constant margins and lower costs — that's the answer," Borsook said

CE Kurt Hipper said vehicle sales had improved in real terms and extra volumes were sold to elections personnel. "All of the vehicles were returned and were sold off as second-hand stock which also helped results," he said.

Other areas where the group made inroads included the second-hand car market, which made a bigger contribution to profit.

Hipper said the company had regained some market share and the division had shown a considerable recovery "from where we were"

Sakers Finance and Investment Corporation, which derives its income solely from its 50,4% holding in Saficon, reported earnings a share of 87c (23c) and an interim dividend of 13c (nil) was declared.

Delta buys Ford plant for Corsa

Own Correspondents

192
CT 3/11/94

PORT ELIZABETH — In a hush-hush deal, Delta has bought the old Ford production plant at Struandale and plans to build a cheap new model, the Opel Corsa

It is believed the company paid around R30m for the Struandale plant

The Opel Corsa will compete at the bottom end of the market with the Citi Golf and the Fiat Uno

Delta spokesman Ed Emmett yesterday refused to divulge details

There has been speculation in industry circles about the deal for weeks. Delta and Samcor are also said to have been negotiating the deal for "some time".

Emmet would not confirm or deny that part of the Struandale assembly plant, which has a rust-proofing facility worth millions, had been bought for R30m — or that the Corsa would be built in the city

"Your information is correct in that we have bought at Struandale — we will tell you the rest at a press conference on Friday," Emmet said.

The expansion could see new job opportunities for the East Cape region — both on the direct assembly line and in the component and supply sector

Reports yesterday said that Corsa models had been seen undergoing evaluation in Port Elizabeth — suggesting that the Corsa would complement Delta's current Kadett and Astra line-up

The Struandale assembly plant was commissioned by Ford in November, 1973, and cost R9,5m to build and equip

It was the first car manufacturing plant in the country dedicated to a single carline, at that time the Ford Cortina

It employed 1 000 people — the majority of them hourly-paid assembly line workers — and had production capacity of 100 units a shift

The Struandale assembly plant closed at the end of 1985, with production being transferred to Samcor in Pretoria

VW will close tool, die sector

CT 3/11/94

(192)

Own Correspondent

PORT ELIZABETH — Volkswagen South Africa has announced the closure of the Tool and Die division at its Uitenhage plant in June next year

The closure forms part of an "outsourcing programme" which the company will embark on over the next few years

The motor company said it planned to focus on core production activities. It is understood the recent moves form part of a global restructuring at VW aimed at long-term viability

In an agreements reached with the two unions at Volkswagen, the company said it would try to accommodate the 200 affected employees in other operations at a similar level

A spokesman said the company had first decided to invest in its Tool and Die operation to meet the plant's tooling requirements ahead of the introduction of a new range of vehicles

He said once the tooling requirements were met, numerous smaller jobs were secured as well as a large tool refurbishment contract for China which was now approaching completion

"Strenuous efforts to secure further contracts have been made both locally and internationally over the past 18 months — but have met with little success," the spokesman said

--

'Car wars' hot up in E Cape (192)

Own Correspondent

PORT ELIZABETH —
"Car wars" between two
of the Eastern Cape's
three motor manufactur-
ers heated up yesterday
with the announcement
that Uitenhage-based
Volkswagen had long-
term plans to increase
its small car range

VWSA said its tradi-
tional strength had
always been in this sec-
tor

ET 4/11/94
The latest VW small
car, the Polo, was just
one of the models under
review

This follows a day
after the news that Delta
Motor Corporation had
bought the old Ford
Struandale plant and
planned to manufacture
the Opel Corsa

Delta's plans are still
secret, with a formal an-
nouncement on the com-
pany's role expected to-
day

X X

Beat foreign competitors or die, says Volkswagen chief

Motor industry in crisis

Star 17/11/94

BY THABO LESHILLO
If SA fails to meet the challenge of stiffer international competition, its vehicle making industry will disappear within five years.
That's the sobering message from Volkswagen MD Peter Searle, who stresses that as the price for the return to the world of foreign trade becomes apparent, motor manufacturers must adapt or die.

SA simply hasn't thought through the effects of its return to the highly competitive world outside, which seems more interested in selling its goods here — but not buying from us.
"This is a tough world we're going into from which South Africans — particularly those of us in the motor industry —



Peter Searle ... production costs highest in world

have been sheltered," says Searle.
He warns that the future of the industry is at stake, as import tariffs fall and a potential oversupply of 10 million cars by global producers could find its way here, threatening jobs.
Searle urges the establishment of an accord by all stakeholders, especially business, labour and government, to improve productivity and secure the future of manufacturing.
The government, he says, must ensure conditions that are conducive to foreign investment and encourage foreign investors to place orders with local suppliers.
Labour stability and better labour relations must be achieved as a matter of urgency.
Companies must ensure that all employees are committed to

doing a full day's work.
Managers should also be retrained to equip them to handle the challenges of the ever-changing workplace.
"They need to be more accountable and be ready to work together with the unions to improve all aspects of the way we operate," says Searle.
No effort should be spared in the battle to keep production costs down, including the cost of labour and building affordable cars.
"Our production costs are the highest in the world."
"While we have maintained material cost increases at 5 percent a year, we have had to contend with wage demands well above the rate of inflation," says Searle.
It is possible, though, to grant wage increases above the inflation rate if productivity can improve, while maintaining quality standards.
Major changes planned to boost productivity at Volkswagen include removing one level of supervision, organising work groups on production lines, raising the level of education of all workers and

mult-skilling.
On exports, Searle says manufacturers should grasp the opportunity which comes with the lifting of trade barriers.
Export orders will boost production volumes and enhance economies of scale, he says.
Volkswagen announced yesterday it would close its tool and die division next June because it could not secure orders. About 200 workers would be affected.
"The worldwide over-capacity in the toolmaking industry makes it unlikely that new orders will be received."
"Strenuous efforts to secure further contracts have been made, both locally and internationally over the past 18 months, but have met with little success," spokesman Raymond Hartle said

Delta launches R520m capex plan

PORT ELIZABETH — In a bid to contest world markets and become a major local player, Delta Motor Corporation has announced a plan to spend R520m on capital projects

MD Willie van Wyk said the move would increase Delta's output from 51 000 new vehicles a year to 91 000 units

"Exports to both North and South America hold excellent promise and will soon add to the success already being achieved in Europe and the rest of Africa"

He said exports by 2000 would

exceed 20% of Delta's total turnover. The company had a current turnover of just less than R2bn. In 1994 exports would account for 9% or R190m of gross income

The company's capex programme, which would run over four years, included the purchase and refurbishment of the old Ford plant at Struandale at a cost of R80m

ET 7/11/94
"Already we have received extensive assistance from Opel in Germany and all indications are that we will achieve high levels of efficiency at this plant"

A further R280m would be spent on new product or updates of existing products and R150m would be spent on new facilities. The move would add 650 people to the 4 000-strong workforce, while another 650 new jobs would be created in the supplier and retail industries

29 (192)
An announcement would be made soon on the import of a fully built-up unit for niche markets. He said the company had applied for distribution rights for the Swedish-built Saab

Union agrees to increase production

ARG. 17/11/94
JOHANNESBURG Volks-
wagen South Africa and the
National Union of Metalwork-
ers of South Africa (NUMSA)
had reached a "multi-faceted"
agreement on workplace
changes after months of negoti-
ations, NUMSA said

They had agreed to increase
annual production to 100 000
units a year, depending on de-
mand, reduce costs and im-
prove quality, protect employ-
ment, and promote "employee
participation through co-deter-
mination practices"

There would be no compul-
sory retrenchment in the 18
months to end-1995, NUMSA
said, and new forms of work
organisation were in the pro-
cess of being implemented

The company would also in-
vest in basic worker education
and leadership programmes

COMPANIES

Cementco hit by hard times

CEMENTATION Company (Cementco) reported a 66,7% decline in net attributable income to R501 000 in the year to September as a result of an unstable sociopolitical environment and the sale of loss-making subsidiary Barracuda Granite Tile.

Earnings a share dropped to 5,6c (16,8c) and no dividend was declared.

Turnover increased 11,4% to R300,3m but net income before interest paid and tax slumped more than 47% to R4,2m.

Interest of R2,6m (R3,2m) left pre-tax income 67,2% down at R1,5m, while after-tax income decreased 57,7% to R1,3m.

Net attributable income of R501 000 (R1,5m) was further reduced by an extraordinary item of R3,1m which left a net loss for the year of R2,6m.

The group's activities were affected negatively by the unstable sociopolitical climate prior to the elections and the sale of its share of Barracuda

But the board said the second half of the year had seen a turnaround, reflected in the year-on-year turnover increase of 11%.

AMANDA VERMEULEN

As a result the attributable loss recorded at the interim period was converted to a profit for the full year. This was in spite of bringing to account a number of problematic accounts which were completed towards the end of the year. *Biday*

The group bought 70% of specialised engineering design and marketing company Techno Arms in January, and in February registered wholly owned subsidiary GFC Mining and Construction in Ghana.

Its share of the trading loss suffered by Barracuda during the first half was more than R1m. The group disposed of its share in March, resulting in the extraordinary loss of R3,3m. *7/11/94*

The 17% increase in the orderbook over the year, albeit with tight margins, the rationalisation and consolidation of business units, and the increasingly stable socioeconomic situation led the board to believe that there would be satisfactory growth in profits in the year ahead. *(193)*

PPC has plans to expand

Biday
THE substantial increase in cement demand since the April elections had forced cement cartel member Pretoria Portland Cement (PPC) to focus on future capacity expansion plans, PPC group MD John Gomersall said in the latest annual report.

He said estimates of cement demand growth could see the re-opening of PPC's Dwaalboom plant in

SAMANTHA SHARPE

Northern Transvaal within two to three years. *25/11/94*

The recent acquisition of a limestone deposit in the Beestekraal area would provide a deposit close to the PWV and surrounding markets. *(193)*

He said projects aimed at increasing the production capacities of two factories in the Western Cape were under way

Car sales resurgent

Star 9/11/94

■ BY CLAIRE GEBHARDT

Car sales in October surged by 56,6 percent to 17 884 units after widespread strike action had sent September sales to record lows

September's sales of 11 418 units — the lowest since 1968 — were largely the result of a lack of stock.

(192)

National Association of Automobile Manufacturers (Naamsa) figures released yesterday showed October sales were 834 units, or 4,9 percent, up on October last year.

It said the figures confirmed the ongoing recovery.

Increased sales of light, medium and heavy commercial vehicles were a reflection of

the recovery in fixed investment which had accelerated sharply in recent months and which would receive further support from the implementation of the RDP.

Demand for light commercial vehicles, bakkies and minibuses was exceptionally strong and reached 10 685 units — 28 percent up on the 8 346 units sold in October last year.

Sales of vehicles in the low-volume medium and heavy commercial truck segments also recorded strong gains, rising by 32 percent, or 7 units, in the case of medium commercial vehicles, and increasing by 122 units, or 28,1 percent, in the case of heavy trucks, compared with sales levels in the same month last year.

Motor manufacturers smash all production records after strike

The Argus Bureau

PORT ELIZABETH — Motor manufacturers in the Eastern Cape, hit hard by the strike in August, are smashing all records in efforts to catch up on the backlog

Volkswagen in Uitenhage announced yesterday its production run for last month had reached 6 418 — the most cars produced in a month for five years

Delta also announced a five-year production high of 4 500 units, topping the November 1989 figure of 4 244, Delta corporate communications manager Ed Emmett said.

The high figures continued to reflect the demand for stock replacement after the strike

"We have been working two hours a day overtime to catch up and will continue to do so in an attempt to regain lost production, though we will not be able to make up the entire shortfall," he said.

Volkswagen managing director Peter Searle said their figure represented a 35 percent increase over the average monthly production figure for last year and the first seven months of the year

He said the company had also posted a five-year record for wholesale shipments — including its export programme to China — of 6 045 vehicles

"After the disastrous hiccup in production during the strike our employees have pulled out all the stops in maintaining a high volume of vehicles to our customers," Mr Searle said

192

ARG 9/11/94

VWSA plans on 'major local growth' after export project

VOLKSWAGEN SA had huge expansion plans for the local market once its R1bn export programme to China came to an end, MD Peter Searle said yesterday.

The Chinese contract, under which VWSA will have exported 30 000 Jetta model vehicles, winds down in February.

The FAW VW factory in China would come on line early next year and start producing its own vehicles

The "aggressive" plans — in the final stages of being signed off by VW's German parent company — would see the spare export capacity devoted to the local market.

"We think we can get 25% of the SA car market within the next couple of years. Once the China contract runs out we have the immediate capacity to make a start."

The company holds 18.4% of the market, according to the National Association of Automobile Manufacturers of SA.

VWSA would also aim for component export markets in Europe — body parts and catalytic converters — and hoped to reach a target of R400m a year.

While the loss of the Chinese contract would dent the bottom line, Searle said growth in the local market would take up the slack.

B Dey 10/11/94
MICK COLLINS

"The areas in which we will compete will be the Golf, Jetta and Citi Golf lines. We haven't got near to satisfying demand yet since the introduction of the Jetta

"We are in a strong position against Toyota now. Our product is better positioned in the market and our quality standards are on a par or better," Searle said (192)

Toyota still had the edge as far as productivity levels went, "but we are not far behind".

VWSA had the right product for the SA market on a much broader spectrum — cars and minibuses

The next five years would be critical for the industry, with all manufacturers looking to establish a strong customer base which would give them economies of scale.

Motor manufacturers were still waiting for the Board on Tariffs and Trade report on the industry which had been promised before the end of the year

"GATT comes into force in January so we need to have our own rules in place before then."

Strong growth in the business sector, coupled with the emergent black

market, could see total sales by the industry go to 250 000 cars a year and 130 000 light commercial vehicles a year "This is 25% higher than where we are now."

Employment levels would see little growth in the industry but the component sector would grow with a concomitant rise in the number of people employed.

"The supplier industry will grow, which is good for small and medium businesses. We used to manufacture a lot of our own components but will now leave this to suppliers. We already have a well-developed component industry and will help that infrastructure to develop further

"Our job is to be world competitive. Body shops and press plants must compete against all comers including imports if necessary"

Searle said the dropping of protection was a challenge and the local business had to be constructed on a world class basis.

"In being exposed to competition it's amazing what happens. We have cut down drastically on indirect manpower (management) and from 200 managers two years ago we now have 120"

The company had trimmed a total of 1 000 people from its payroll over the past two years

xx

11/11/94

MOTOR INDUSTRY
11/11/94
Business as usual

Uncertainty there may be about the final outcome of recommendations on the future of the SA motor industry. But vehicle manufacturers aren't hanging around to find out what they will be.

Delta Motor Corp's recently announced R520m four-year capital expenditure programme — as well as new products to be launched by Toyota and Audi, among others — are a signal that the industry is carrying on business as usual as government officials struggle to make up their minds.

The Board on Tariffs & Trade (BTT) is due to announce its final policy recommendations on the car and light commercial vehicle sectors. It is also studying a recently completed report by the government-appointed Motor Industry Task Group on the future of the medium and heavy commercial vehicle industry.

In both cases the eventual outcome is certain to be heavy cuts in protection against imports in an attempt to make the industry internationally competitive. Changes are likely to be imposed from the middle of 1995. Question marks hang over the eventual level of protection and the rate at which it will be attained — and how long government will take to decide. Local companies' foreign principals, in particular, have expressed frustration at the perceived lack of action in setting protection and investment ground rules, warning that potential investments could go elsewhere.

Meanwhile local companies must soldier on. Delta's R520m capex programme will cover new vehicle ranges and improvements to assembly facilities. Having just spent R30m buying Samcor's disused Struandale plant in Port Elizabeth, Delta expects to spend another R50m refurbishing it. Once that is done, existing annual production capacity of 51 000 vehicles will be lifted to over 90 000.

Toyota's announcement that it is close to agreement on assembling ultra-heavy Peterbilt trucks from the US, is another sign of optimism over the future of the SA market. Similarly, this week's launch of the locally built Audi A6, suggests local man-

ufacturers are hoping for the best, whatever the final shape of industry legislation.

October vehicle sales figures, though not quite as sparkling as some had predicted, nevertheless indicate that demand is generally healthy — particularly after the earlier five-week strike.

192

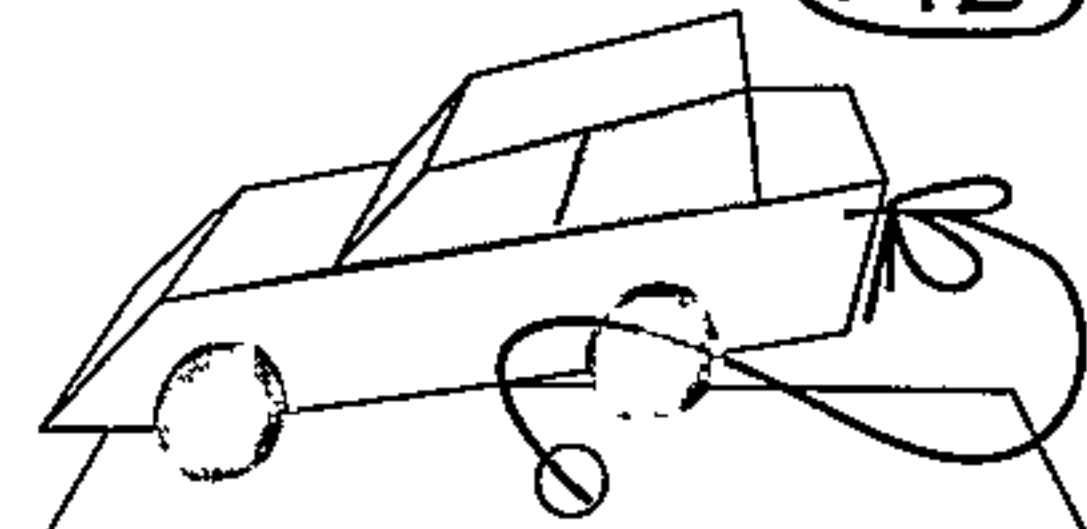

October vehicle sales

Cars	Total	%*
Corolla /Conquest 3 282, Camry 975, other 9		23,9
Golf /Jetta (new) 1 684, Citi/Fox 1 618, Golf/ Jetta (old) 84, Audi 95		19,5
Sentra 1 796, Maxima 71, 200SX/300ZX 5, Fiat Uno 1 087		16,5
Honda Ballade 1 043, M-Benz C-Class 935, E-Class 146, S-Class 23, other 1		12,0
Laser/ Meteor/ 323 1 403, Telstar/ 626 502, other 94		11,2
Astra/Kadett 1 633, Monza/ Kadett 24, Rekord 12, Calibra 2		9,3
3-Series 1 209, 5-Series 138, 7-Series 11		7,6
Subaru		0,0

*% of the total car market

	1993	% Change
October	17 884	17 050 +4,9
Jan - Oct	157 572	164 058 -4,0
Sept (11 418) - Oct		+56,6

Light commercials
 Toyota 3 878 (36,3% of the market), Samcor 2 267 (21,2), Nissan 2 238 (20,9), Delta 1 738 (16,3), VW 445 (4,2), AAD 119 (1,1)

October	10 685	8 346	+28,0
Jan - Oct	84 301	81 361	+3,6
Sept (6 303) - Oct			+69,5

Medium commercials
 Toyota 122 (40%), Samcor 85 (27,9), Delta 48 (15,7), Nissan 33 (10,8), M-Benz 8 (2,6), Iveco 7 (2,3), AAD 2 (0,7)

October	305	231	+32,0
Jan - Oct	2 764	2 530	+9,2
Sept (244) - Oct			+25,0

Heavy commercials
 M-Benz 220 (39,6%), Nissan 96 (17,3), Toyota 91 (16,4), Delta 46 (8,3), MAN 44 (7,9), Tyco 32 (5,7), ERF 19 (3,4), Iveco 8 (1,4)

October	556	434	+28,1
Jan - Oct	4 635	4 083	+13,5
Sept (514) - Oct			+8,2

Total vehicle sales
 Toyota 8 357 (28,4%), Nissan 5 326 (18,1), Samcor 4 351 (14,8), VW 3 926 (13,3), Delta 3 503 (11,9), M-Benz 2 376 (8,1), BMW 1 358 (4,6), other 233 (0,8)

October	26 430	26 061	+12,9
Jan - Oct	249 272	252 032	-1,1
Sept (18 479) - Oct			+59,3

Source: NATIONAL ASSOCIATION OF AUTOMOBILE MANUFACTURERS OF SA

Martin Jonker hikes income

MOTOR retailer Martin Jonker Holdings increased attributable income 30% to R2,1m despite a drop in turnover for the half-year to August

Turnover fell 8,5% to R115,3m, but improved margins saw net trading income increase 22% to R5,1m Tax was up 29% at R1,6m, but net income came in 30% higher at R2,3m Earnings a share were 5,4c (4,2c)

The company does not pay an interim dividend

B1 Day 16/11/94

MICK COLLINS

It announced on Monday that it had sold its vehicle retailing business to unlisted company Newholdco for R22,4m The remaining listed cash shell had been sold to Malaysia-registered Landmarks Berhad for a cash payment of 57c a share (192)

Chairman Martin Jonker said Newholdco would be jointly held by Martin Jonker Trust and Automaker

Metal union takes hand in VW's bid to stay up front

Port Elizabeth — Metal industry union Numsa and Volkswagen SA have reached a groundbreaking agreement which will change management structures and establish a new relationship between management and workers

Globally, the agreement aims to develop Volkswagen SA to become a world class performer as looming tariff protection cuts threaten to take a huge bite out of motor manufacturers' market share in the country

The agreement is crafted to ensure that the company does succeed in the face of looming international competition," says Judy Parfitt, VWSA human resources spokeswoman.

For Numsa chief negotiator Gavin Hartford the agreement set a "new benchmark" for the union nationally and he is hopeful other manufacturers may follow suit

The Iron and Steel Workers' Union is also party to the agreement

The agreement, concluded after several months of in-plant negotiations, broadly means that both union and management will work jointly to ensure the continued viability and growth of VWSA. 17/11/94

Other key features of the agreement include increased production to 100 000 units a year, employment protection, and the promotion of education, training and development of employees

In a joint statement yesterday, the parties have agreed that there will be no compulsory retrenchments for an 18-month period provided that there are no unprocedural actions during this period or that VWSA's market share does not fall below 10 percent

VWSA has agreed to pump R10 million into basic education in 1995 which will benefit up to 1 000 employees, accelerating employees up the industry career path ladder

Key to the agreement is the

flattening of management structures and the piloting of teamwork on new product lines as new forms of work organisation are phased in.

Another priority is the implementation of affirmative action principles which will compel the company to prioritise gender and racial appointments

"An affirmative action office and an affirmative action forum will be established within the company to police the implementation of this principle and also set affirmative action targets for each division," the statement said.

The agreement requires flexibility in the manufacturing process both between and within business and production units as well as "flexibility with regard to the determination of VWSA's core business activity through strategic sourcing initiatives"

The agreement sets standards to develop the rights and responsibilities of the company and union. — Eena.

New work methods at Mercedes plant

3/Day
18/11/94

ERICA JANKOWITZ

THE National Union of Metalworkers of SA and Mercedes-Benz were developing new work organisation methods at the company's East London plant in terms of an agreement signed in July this year, Mercedes-Benz SA human resources and manufacturing Ian Russel said

The company had committed itself to raise the skill levels of the "majority of existing operators" to assembly operator level in order to gear up for world class manufacturing.

Operators would be selected for upgrading and an additional 100 temporary workers hired to relieve production pressure while workers were trained on a rotational basis

Training in the theory aspects of work would be conducted after hours

"New work organisation will only be implemented by area when sufficient employees in the area have acquired the necessary skills to support the new work organisation methods"

Russel said initially team work would be applied to a new model run for which workers had been recruited. These new recruits had a minimum entrance requirement of a matric certificate, obviating the

company's responsibility for providing basic education

Shop stewards said although they had been disappointed in the company's decision to impose this minimum educational requirement, they had not opposed it as job creation was an integral part of reconstruction and development

Individual incentives for reaching targets were increased to a maximum potential earning of six weeks' bonus pay a year, a 50% improvement on previous years

Targets were also set for contributions to the company's housing, education and social responsibility fund which was currently investigating providing about 1 000 subsidised houses to workers on earmarked land close to the plant. (192)

The agreement said the cost to the company of additional benefits would be almost R18m a year including R5m for human resource development, a R6,8m wage adjustment in terms of this year's agreement and R3m for housing

● Comment: Page 10

Numsa and VW drive a good bargain

Shadley Nash

THE National Union of Metalworkers (Numsa) and Volkswagen SA have reached a multi-faceted, groundbreaking agreement which will change management structures and establish a new relationship between management and worker

Globally, the agreement aims to develop Volkswagen SA to become a world class performer as looming tariff protection cuts threaten to take a huge bite out of motor manufacturers' market share in the country

"The agreement is crafted to ensure that the company does succeed in the face of looming international competition," says Judy Parfitt, VWSA human resources spokesman

For Numsa chief negotiator Gavin Hartford the agreement set a "new benchmark" for the union nationally and he is hopeful other manufacturers may follow suit.

The Iron and Steel Workers' Union is also party to the agreement.

The agreement, concluded after several months of in-plant negotiations, broadly means that both union and management will work jointly to ensure the continued viability and growth of VWSA.

Other key features of the agreement include the increased production to 100 000 units per year, employment protection and the promotion of education, training and development of employees.

In a joint statement on Wednesday the parties agreed that there will be no compulsory retrenchments for an 18-month period provided there are no unprocedural actions during this period or that VWSA's market share does not fall below 10 percent.

Furthermore, VWSA has agreed to pump R10-million into basic education in 1995 which will benefit up to 1000 employees, accelerating employees up the industry career path ladder.

Key to the agreement is the flattening of management structures and the piloting of teamwork on new product lines as new forms of work organisations are phased in.

Another priority is the implementation of affirmative action principles which will compel the company to prioritise gender and racial appointments both internally and externally.

— Echna

MCCARTHY RETAIL

Feb 18/11/94

Refining the package

Unexpected synergies make the group more than the sum of its parts

Two years after the merger of SA's largest motor vehicle dealer with the collection of retailing interests held under the Prefsold banner, the logic of the deal is becoming apparent

Results for financial 1994 show a strong performance from McCarthy Retail, the operating company holding the motor and mainly furniture interests, and which is in turn 85% held by McCarthy Group. A 68% increase in operating profit, to R281m, on a 17% increase in turnover, is notable, particularly as it was achieved during a year when private consumption expenditure grew by only 1%

Despite a 73% rise in tax payments, to R97,2m, influenced by about R14,6m in non-recurring charges, EPS grew a solid 24%. For CE Terry Rosenberg, EPS growth is the beginning of the underlying, two-pronged strategy. He will need a few more years before he can show a trend of steady growth in EPS, his second objective, though, of lowering what he calls McRetail's "perceived risk," comes through clearly on the balance sheet, where borrowings are down R62,4m to R137,5m.

Bolstered by cash holdings of R105m, more than three times that of a year ago, the debt equity ratio is negligible. Interest payments were reduced by nearly a fifth to R42m and interest and leasing cover have firmed (see table).

Steady growth in earnings and the lower debt, Rosenberg believes, are what McCarthy needs to achieve the rating it deserves. The shares have been significantly re-rated this year. McRetail's price gained 208% and McCarthy Group's 145%. Prospects for the current year, though, which include developing new insurance products and the possibility of counter-trade within the Anglo American Industrial Corp stable (a 31% shareholder) to offset currency risks, suggest even better ratings.

Should consumer demand for McCarthy's vehicles, semi-durable goods and clothing increase, as early signs of economic recovery seem to indicate, the shares could be among the top performers in the retail sector.

McCarthy's diverse and apparently eclectic business — it sells vehicles, spare parts, appliances and furniture, nonfood household items, clothing, marine, sport and music products, building supplies, and also has short-term insurance and finance interests — was certainly a factor which made the market turn a cold shoulder to the merger.

Synergies were not obvious. About all the two groups seemed to have in common was that they both had head offices in

Durban. For the first year at least, investors were confused by the merger and the shares lagged (192) ~~193~~

Chairman Brian McCarthy believes the past financial year's results begin to indicate success. A merger was not what he had in mind early in 1992 when he was looking for a non-executive director for McCarthy's board to replace Colin Hall, who was relieving himself of responsibilities to head Wooltru.

"I had met Terry Rosenberg on a number of occasions," says McCarthy, "and thought he would be right for our board. He was introduced to the other directors and they agreed, but I had to do a bit of arm-twisting to get Terry to accept the position. At that time, he did not want to accept non-executive positions."

Rosenberg relented and after joining the McCarthy board was introduced and updated on the motor vehicle retailer's accounts. "We were discussing the possibility of a relationship between McCarthy and Prefsold, though the sort of link envisaged was something like a cross-shareholding," McCarthy says.

Six weeks later, however, Rosenberg made an appointment to see McCarthy and outlined the rationale for a merger between the groups. "Until then, a merger had not been considered but it began to make sense. At McCarthy, we had a strong but mature business. We needed to diversify, we were keen to get closer to the emerging black market, and we saw growth opportunities in that market through the three Prefsold



Rosenberg

businesses"

Apart from combining a large, mature business and operations with potential for growth, there were less obvious synergies. One was in financing. Prefsold had already established Firstpref, a financing venture with First National Bank mainly to manage HP sales on the furniture book. The additional turnover and assets McCarthy brought to the party increased the potential for financing.

Short-term insurance is also due to be extended to the motor business this year now that Prefsure, the in-

house insurer, has a full licence. Focus will initially be on mechanical breakdowns.

Other benefits being seen are increased efficiencies and cost savings by combining head office structures and information technology. With a joint administration base and large branch network, businesses such as insurance bring in additional income at little cost to overheads.

For the chairman, though, the most tangible benefit is in the profit growth in financial 1994. Turnover growth in the two central pillars, Motor Holdings and Prefsold, was more than acceptable at 15% and 18% respectively.

Market conditions in the motor industry seem to be improving, but, before the merger, turnover growth was a stodgy 7%. In its last interim report before the merger, McCarthy Motors did well to limit its decline in sales to 8% against the industry's 11%. But that still reduced earnings by 11% to R20,9m.

Sound management and a wide spread of types of vehicles sold, as well as diversification into related services, have historically kept what is now called Motor Holdings a steady performer. MD Theo Swart points out that, even during recession, McCarthy picks up the benefit of customers buying down, where margins are not necessarily lower.

But the converging trends between Motor Holdings' and Beares' contributions to operating profit (see graph) underscore the point of combining a mature business with a growing one. Operating margins are moving in opposite directions.

Rosenberg sees growth opportunities for Motor Holdings in the year ahead. This will come partly through diversification — Budget Rent-A-Car, acquired two years ago

BETTER RATING

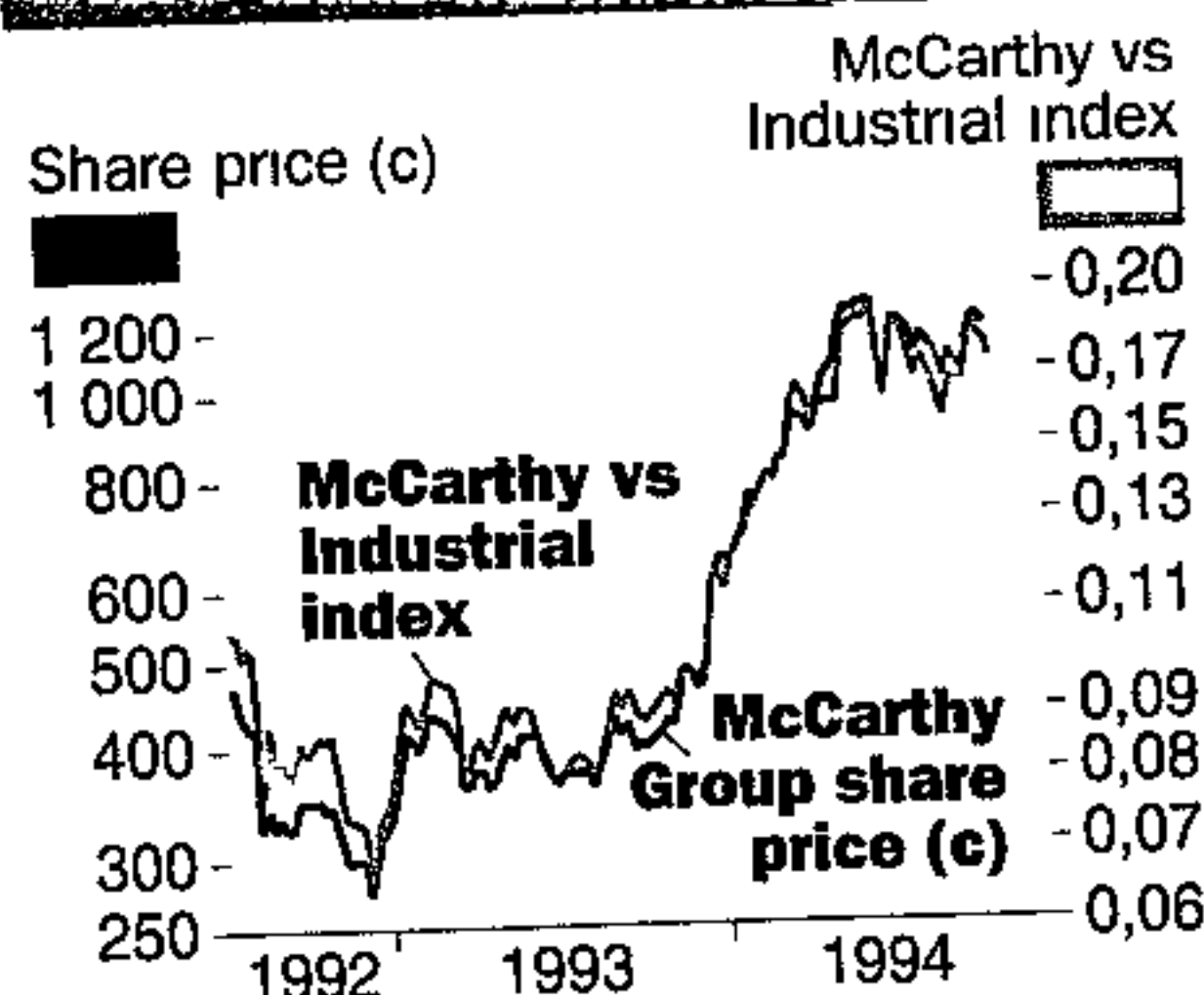

Source: I NET

Continued on Page 34

Continued from Page 24

inflationary effect should be minimal. "When the rand more than halved in value in 1984-1985 at the time of the debt standstill, the inflationary impact was only about eight percentage points, even though fiscal and monetary policy at the time was conducive to high inflation. Set against a backdrop of liberalised world trade, and stronger monetary and fiscal controls today the impact should be small and brief."

Indeed, says Barnardt, abolition could minimise the trade deficit. "A moderately weaker rand will give exporters a small boost."

Apart from the question of timing, the authorities will have to decide how and how much to liberalise.

Most economists canvassed by the *FM* favour a slow phasing out the gradualist approach, also favoured by Stals. They believe reserves should be allowed to consolidate. In particular, the net reserves need to move back into surplus (since the Bank only publishes changes in net reserves, available figures are estimates by economists. All agree that the net position is still negative).

Proponents of this view say changes in the exchange rate regime should come only once the government has established a fiscal track record — and after the 1995-1996 Budget in March when, hopefully, government will have further reduced the deficit before borrowing. Tariff reduction and privatisation of State assets could be under way by then, underpinning the liberalisation process. At that point, the abolition of the financial rand and restrictions on nonresidents could be considered, with full abolition of controls thereafter.

UCT's Brian Kahn sums up the gradualist view. "If exchange controls are the only deterrent to foreign investment, then they should all go immediately. Because they are but one of many, a gradual approach which addresses the other problems investors have must be considered."

However, says Board of Executors' Rob Lee, the gradual approach can be detrimental. "It will encourage foreigners to take a profit on the finrand differential, and then sit and wait to see whether further liberalisation occurs or not."

"Partial abolition permits outflows without making allowance for compensating inflows." Furthermore, says Lee, the emphasis on improving fundamentals such as net reserves only increases speculation of the finrand's abolition and pushes bond rates higher than they ought to be while market participants worry about what their yields should be under a unified currency. "This in turn forces the State to fund at the short end of the market and increase money supply, forcing tighter monetary policy even before changes have been made."

The process, says Lee, could spill over into the forex market, creating greater losses for the Bank on its forward cover book, undermining net reserves.

There is another argument and it requires not just abolition of the dual currency but lifting of constraints on residents. The distortions exchange controls create have a cost — and one that is rising.

Flaws in the economy criticised by potential foreign investors and the ANC are largely due to exchange control. At the *FM* Investment Conference, Genbel's Peter Cronshaw said "Illiquidity of the JSE is a result of the long-term imposition of exchange controls which has led to a shortage of scrip and concentrated share ownership." This has reinforced the network of cross holdings in SA's main corporates and the concentration of control in a few powerful hands.

If the constraints were to be lifted, the big investors would unwind some of their domestic positions to take advantage of broader opportunities. And foreigners will take the opportunity, now denied them by tight holdings, to buy large lines of SA's



Cronshaw

blue-chip shares. These new owners will reduce the role of the present major players in the economy.

Says Lee "The downside potential for outflows is overstated. Local institutions will be limited in the amount of capital they can take abroad by the need to match their rand liabilities with rand assets. Much of the flight capital has gone anyway, so the impact of outflows will be small."

He expects a small outflow, which will depreciate asset prices slightly, but only insofar as they will make prices more attractive to foreigners. "The potential institutional inflows are enormous and would grow as the liquidity of local financial markets increases."

The flows will go both ways. South Africans need to diversify portfolios. And, fortunately, emerging markets are seen as a useful means of diversifying portfolios held abroad. The *London Financial Times* recently reported research from merchant bank Barings that "not only will a holding of 10%-30% added to a portfolio (of stocks in industrialised countries) increase the return to the investor — it will actually reduce risk as well."

This is because emerging markets tend not to move in tandem as do those in the major economies, providing a built-in hedging facility to investment funds. Barings is confident enough of SA's ability to attract these funds to open an office here to promote portfolio investment.

What is needed for SA to gain a share of these funds is for it to create the conditions that will attract them. And one of the major requirements is the free movement of funds.

There is a case for waiting until next year's Budget. A deficit before borrowing of lower than 5% of GDP, together with a full privatisation programme, which could raise R27bn for the State, would make the case for abolition strong indeed.

But SA needs to take advantage of the positive leads and lags which are allowing the rand to remain reasonably comfortable. Delays will encourage speculation, as doubts over the sagacity and sincerity of the authorities rise, and raise the costs of distortions that controls have fostered, as well as the risks inherent in an eventual forced liberalisation.

A complete abolition of controls now, backed by IMF support, can have only a salutary effect on intransigent labour markets. Says Lee "Full exposure to the cold winds of international competition will exert powerful disciplines on the domestic labour market and be more effective than any other measure in eroding uncompetitive wage structures."



Osborn

CREATING CONDITIONS FOR FINRAND'S END

FINRAND DISCOUNT

Difference between the commercial and financial rands as % of the commercial rand

1973 to 1993

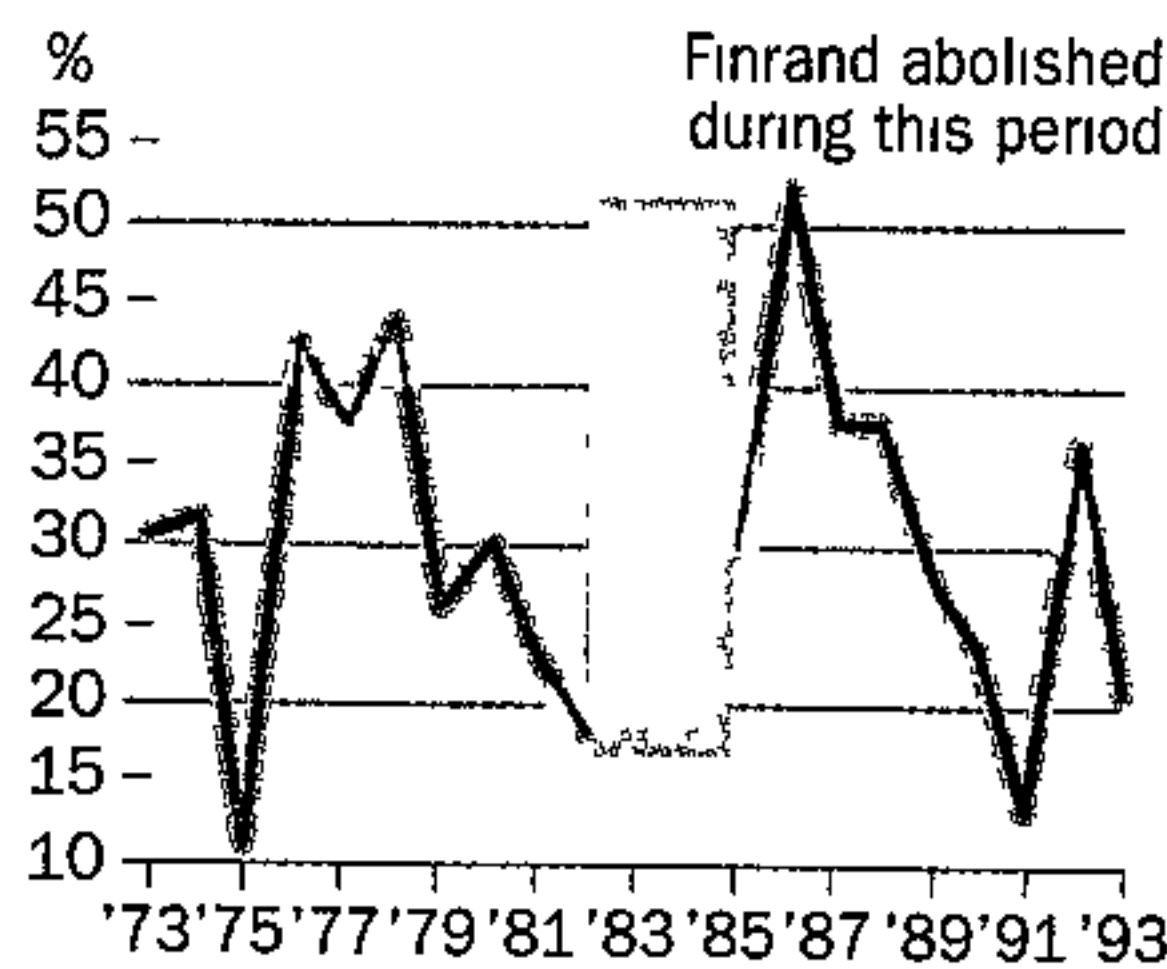

1994

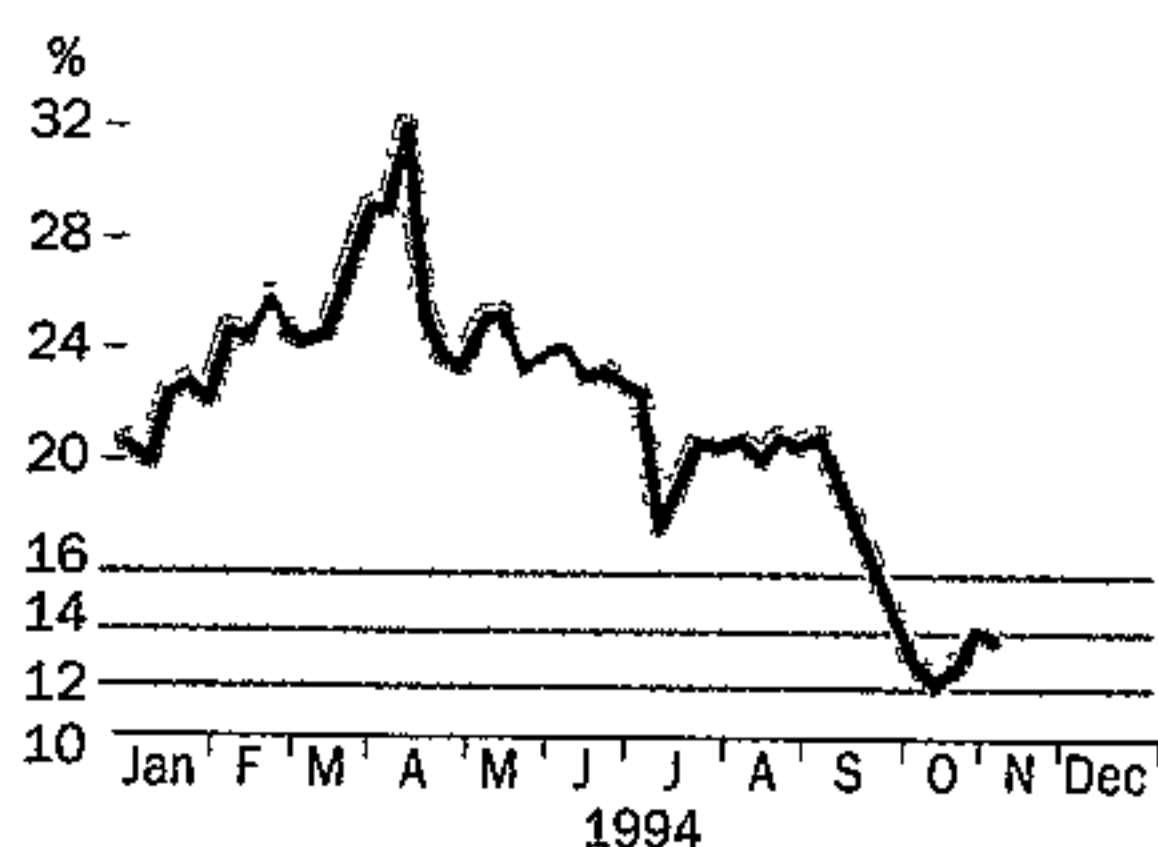

Sources: I-NET, ABSA

Continued from Page 30

when it was losing more than R1m a month, is now contributing about R2m a year in rental income alone — and new developments

“With duties on imported cars down to 80% and further cuts anticipated from the Gatt discussions, importing cars becomes more feasible. We are speaking to two major manufacturers overseas and hope to have a deal in place before year-end”

Swart says the UK dealerships had a disappointing year, largely through the weakening of the yen exchange rate, reducing Toyota's market share from 3% to 2,7%. He says, however, that the focus is on the positioning and improvement of the UK dealerships, which, with two new franchises for upmarket models (Lexus and Supra), should improve the UK business. Overall, Swart expects profit from Motor Holdings to beat inflation this year.

Beares, the core of Prefhold, had a good year but prospects are linked to its position in the black market (65% of the customers are black) and possible benefits from the RDP point to sustained growth. Rosenberg says that if Beares can just maintain market share, growth will be strong — the appliances market, worth about R4bn at year-end, is expected to increase to about R10bn as Eskom endeavours to provide electricity to 800 000 homes over the next three years. Once the RDP housing programme gets under way, Beares will benefit directly.

The basis of Beares' success in the mass market is the finance packages it offers. Yet analysts mention control of the debtors book as one of the potential weak points.

Prefhold MD Hymie Sibul says that, despite problems in many townships which made collections difficult, bad debts and arrears trends are satisfactory and in line with expectations. Gross bad debts as a percentage of debtors increased from 2,63% in financial 1992 to 3,66% in 1993 but last year declined to 3,32%.

Though its contribution is relatively small, profits from clothing arm Clobea more than doubled to R7m. Rosenberg says there are several opportunities for organic growth in clothing, particularly in regions like the Cape. But McCarthy has also expanded its clothing interests through the acquisition of Guys & Girls, a chain of 53 cash retail clothing stores, mainly in neighbouring states. Rosenberg says the acquisition fits in with the long-term strategy of expanding into Africa.

Game was disappointing, though reorganisation made it profitable last year. It has recently shown the strongest turnaround in the group. Rosenberg says it has increased its number of stores from 10 to 17, which resulted in opening costs being written off upfront. “Profitability has been up in the last six months, with new management and a dedicated focus on stock management”

Outside the core businesses, McCarthy

has been doing some interesting diversification. Like Budget, Midas (involved in automotive products) was ready for turnaround. Initially, when Midas saw EPS plunge into the red, McCarthy held 37%. That was increased to 80% last year as the company came through with strong results after an extensive cost-cutting and restructuring programme back to the core business. Latest interim results from Midas to end-August showed EPS up by 49% and gearing down from 53% to 23%.

McCarthy also holds the franchise for many Yamaha products. Though the motorcycle market has been dead for some time and the sale of marine equipment, mainly outboard motors, suffered from the drought, Rosenberg is excited about the future of the franchise.

“Apart from the drought being over, we recently acquired the franchise for Yamaha musical instruments. We expect to get between R6m-R7m from the franchise this year,” Rosenberg says. (192) (233)

He has some interesting ideas to finance the imported products. One of the problems last year was the strong yen and weak rand, which often meant the price of Yamaha products had increased before the shipment arrived. “I've had discussions with Amic about the possibility of establishing a system of counter-trade. We could remove the

applied for a life assurance licence.

“The beauty of in-house insurance is that we get extra business at no infrastructural cost. We have vast distribution channels and administration and information technology to support Prefsure. They bring in additional revenue without adding to overhead costs”

Now that insurance will straddle both main pillars of the McCarthy business, it illustrates an important theme running through most of the group. At first glance, McCarthy still seems to be a disparate collection of businesses. But, apart from the benefits of a merged administration and computer system already mentioned, increasing commercial and financial synergies are being developed among businesses at the operating level.

An example is Budget. Since being acquired by McCarthy, the car rental business has been integrated with other activities in Motor Holdings. Apart from the rental income it contributes, the fleet of cars is replaced every nine months from the group's franchise dealers. The used cars are returned to McCarthy dealers and sold. Spare parts and servicing are provided in-house.

Similarly, Prefhold has a hardware and basic building materials company called Bonus Building Supplies, which offers credit to home builders, largely in the rural areas.

With the RDP housing initiative, the stores are being expanded from 20 to 40, allowing customers 24 months to pay for the basic materials needed to build a house.

More houses mean more furniture sales. Electrification of those houses will boost the sale of appliances. McCarthy could soon offer a financial and insurance package to cover home-owners right from the building of a house through to the furniture and appliances that go into it.

This type of vertical integration is what is making the merger work. McCarthy's position in the market — aimed largely at the emerging black market — is almost certainly where the greatest growth is going to be.

So far, McCarthy's emergence in that market has not shown its full potential. The merger took place when both main businesses, which tend to be cyclical, were at the bottom of the downturn. Both markets are rising now and increased private consumption expenditure will add cream on the top.

That suggests the shares, on nearly identical ratings, remain undervalued despite sharp appreciation over the past year, especially the past six months. With McCarthy's main businesses cyclical, the shares will probably remain at a discount to the sector. On present ratings, though, with a p/e ratio of 12,6 compared with the sector average of 27, they must offer value, possibly better than most retail shares now.

Shaun Harris

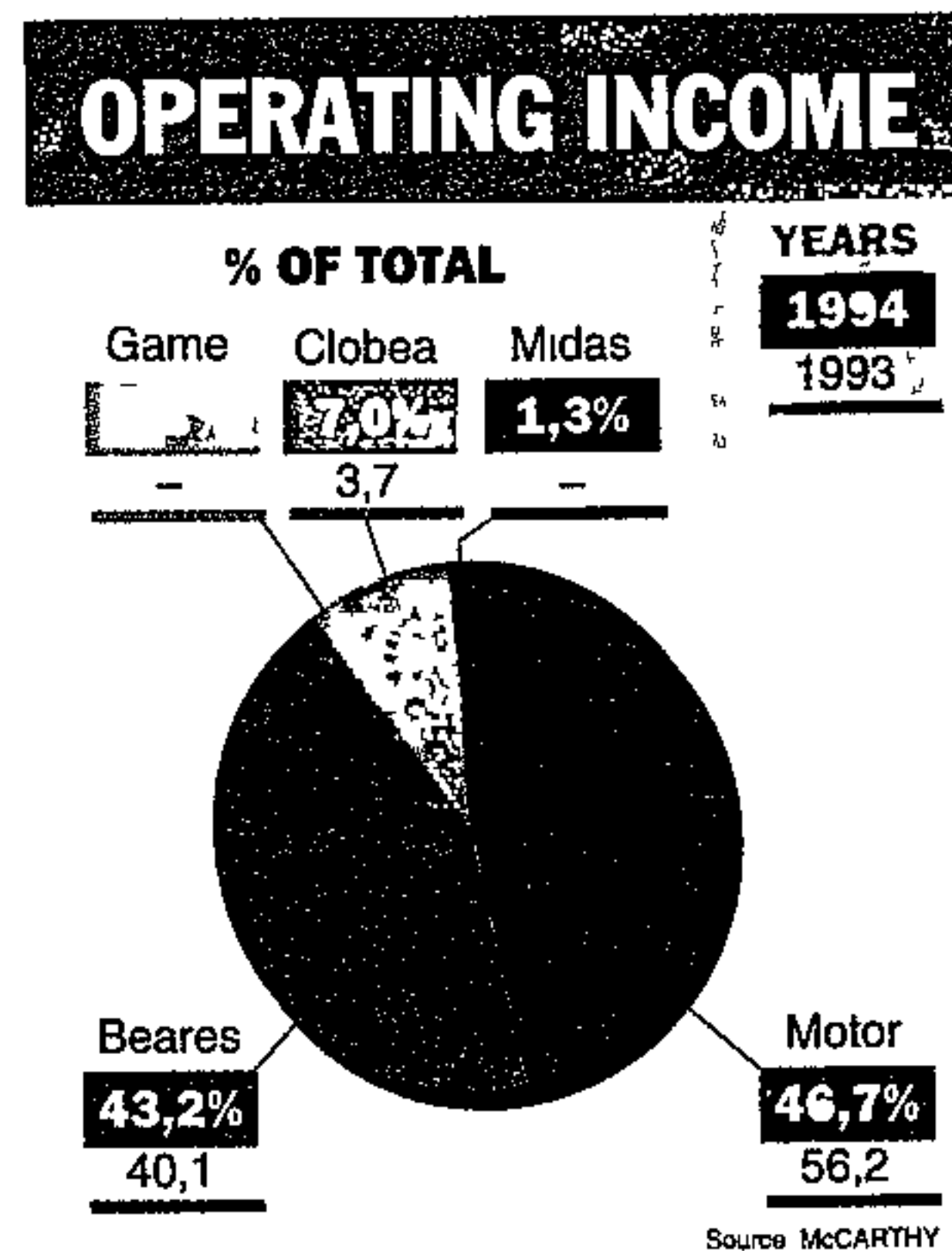

currency risk by sending Yamaha International products manufactured by Amic, for example aluminum castings” Discussions have also taken place with Yamaha, though Rosenberg emphasises that nothing has yet been signed.

Insurance will be of increasing importance this year, with the granting of a full short-term licence to Prefsure in April. McCarthy has a large captive client base — about 60 000 customers on the motor side, 630 000 active clients at Beares — which offers strong growth potential for insurance products. In addition, Rosenberg wants to start offering credit life products and has

import duties on textiles could generate 62 000 additional jobs

Hunger strikers

THE ANC management committee would meet secretary-general Cyril Ramaphosa today to discuss the plight of 16 political prisoners who were on their 16th day of a hunger strike at Leeuwkop prison, the Correctional Services Department said yesterday

ANC spokesman Jackson Mthembu said his organisation was concerned about the plight of the hunger strikers and that their release was long overdue

REPORTS Business Day Reporters Political Staff Sapa

Rainbow dismisses illegal strikers

DURBAN — Rainbow Chicken yesterday dismissed an undisclosed number of employees at its Hammarsdale plant in KwaZulu/Natal after a week of sporadic illegal strikes

On Friday the company gave strikers an ultimatum to return to work by yesterday

Rainbow said the Food and Allied Workers' Union had accepted a 10% across-the-board pay rise offer and the setting of a minimum wage reached through arbitration, but employees at various plants and farms

had then embarked on illegal strikes Rainbow spokesman Steve Pattinson said strikers had intimidated employees who wanted to work and stoned vehicles entering and leaving the plant Water pipelines had also been sabotaged

The situation had become almost uncontrollable at Hammarsdale and Rainbow was urgently seeking relief in the Supreme Court A court ruling on the matter was expected today

A meeting between Rainbow and the union was scheduled for last night — Sapa

Call to speed up tractor tariffs probe

TRACTOR dealers have called on the Board on Tariffs and Trade to speed up its probe into the feasibility of lifting import tariffs on tractors

Scrapping the tariff would have the effect of creating jobs in the agricultural machinery industry and boosting sales, SA Agricultural Machinery Association manager Jim Rankin said yesterday

However, Atlantis Diesel Engines (ADE), which manufactures the power units for locally assembled tractors, has cautioned removal of all protection barriers would lead to a proliferation in models, resulting in an escalation in parts prices and a drop in service standards

Rankin accused the board of not making any progress in its investiga-

LOUISE COOK

tion in the past five months

He said the board announced the investigation into protection levels for locally made engines in a Government Gazette. Since then, the SA Agricultural Machinery Association had made detailed representations on its opposition to protection for ADE three- and four-cylinder engines

Rankin said the import tariff of 40% on six-cylinder engines was lifted earlier this year and sales immediately "went through the roof".

John Deere engineering chief Leon Pretorius said farmers were currently paying between 8% and 15% more than necessary for tractors.

ADE spokesman Johan Kellerman said no effective protection remained

in respect of three- and six-cylinder engines "There is only partial protection on four-cylinder tractor engines and the way the protection formula works, it is on a decreasing scale as tractor prices increase"

Kellerman expected all protection to cease between 1996 and 1997

He denied that tractor prices dropped 10% as a result of the lifting of tariffs "This may be due to an introductory pricing strategy by tractor manufacturers to overcome resistance to the new engines"

Sales increases were due more to labour problems and farmers wanting to buy more productive tractors

Currently, tractors are imported from China, Poland, Hungary and Rumania

Why affirmative action programmes fail

MISTRUST and suspicion between the races had to be eliminated if the new generation of leadership which SA needed was to become a reality, Telkom chairman Dikgang Moseneke said in Pretoria yesterday

Moseneke spoke at the launch of Unisa's African Management Programme, designed to complement affirmative action programmes and curtail SA's critical shortage of managers It has an initial R525 000 backing by Oude Meester brandy

He said it had become imperative to empower the

THEO RAWANA

black community economically It was time for a new generation of leadership.

Moseneke said the problems were severe but not insurmountable. "The biggest problems confronting us today are connected with affirmative action programmes"

Three reasons why such programmes had met with limited success were window dressing, a lack of commitment and a lack of training and mentoring, he said

"No affirmative action programme will ever succeed if support structures, networks and mentors are not provided, and if those previously disadvantaged do not undergo the necessary training programmes"

Moseneke, who is head of the new Unisa African Management Programme's programme advisory board, said the scheme had been designed as a one-year certificate course, but it was the mentorship component that gave it great value.

"This will ensure that not only formal education, but an understanding of practical economic and business processes, will equip the students to contribute constructively in the economic process"

TODAY'S WEATHER

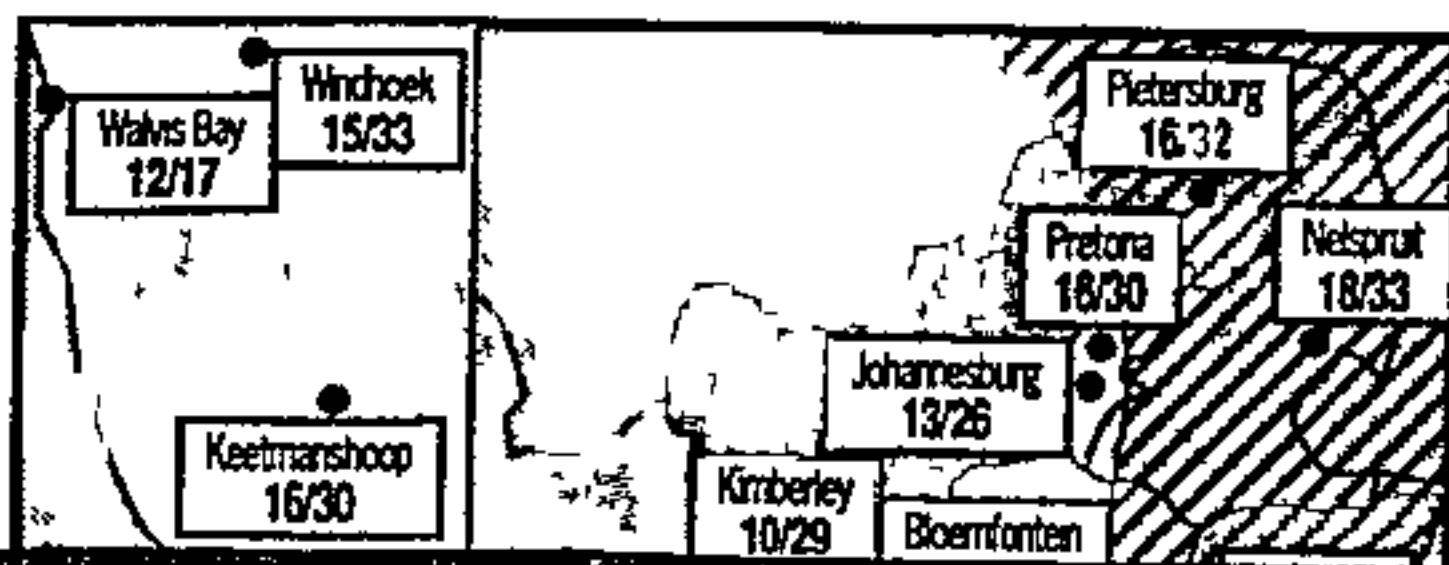

Midas buys out Cape group for R13m

MOTOR parts and accessories group Midas announced yesterday it had bought 57% of Cape-based Quay Buffalo for R13m

The McCarthy Retail subsidiary said this would raise its stake in Quay Buffalo from 43% to 100% and would be settled by a Midas share issue and cash in equal proportions. The Cape company is a major regional wholesaler and retailer of motor spares and accessories.

The deal is effective from September 1. Had the acquisition been in place for the year to August, Midas's earnings a share

MICK COLLINS

would have been 87,4c instead of 74,9c

Midas CE Sarel de Vos said Quay Buffalo had an annual turnover of R80m and was staffed by 280 people who would retain their jobs. The company had customers throughout the Western Cape, Eastern Cape and Border regions and operated nine Midas franchises.

He said Midas was the second biggest franchise company in SA with more than 300 outlets.

Women geared for world-class work

The Argus Correspondent

EAST LONDON. — Under pressure to meet world standards for its new Colt 4x4, Mercedes-Benz has made a bold move — it has hired women for the assembly line for the first time.

Of 130 new workers, who are turning out 20 Colts a day, 30 percent are women.

"We do better than the men," said Nosipho Mofu, who assembles electrical parts.

"And we check in on time," said another woman.

Plant manager Ian Dillin agrees. The women have been more flexible and open-minded about their assignments. We're heading into world-class manufacturing, and this requires a lot more teamwork and quality," he said.

~~358~~ (192) ARCT 30/11/94

Strikes and holidays disrupt Femco trading

AMANDA VERMEULEN

MOTOR industry strikes and an uncertain political environment over the elections contributed to motor parts supplier Femco's 88% slump in net attributable profit to R905 000 in the six months to October

Earnings a share declined to 3,2c (6,5c). An interim dividend was not declared

Turnover dropped 17,3% to R64,2m, while operating profit decreased 44,2% to R2,9m. The board said the operating profit of both Femco and Autocable had been adversely affected by the uncertainty, disruption and public holidays surrounding the elections

Labour disruptions experienced by Autocable Industries' main customers and the subsequent strike in the motor industry had had a major effect on earnings.

The group remained highly geared at 69%, mainly as a result of abnormal trading conditions and the resultant excessive stocks. But the remainder of the year should see an improvement of stock and gearing levels.

The board also said its intention to acquire rights in a property development could not be finalised, and the planned rights issue would not proceed. But it was management's intention to pursue investment opportunities of this nature in the future.

The group was confident that it would at least achieve the same earnings a share as last year.

Demand for new vehicles

PENT-UP demand for new vehicles was expected to push turnover levels in the motor industry to a record R25,4bn next year, the National Association of Automobile Manufacturers (Naamsa) said at the weekend

This would be 18% up on the 1994 forecast figure of R20,8bn, with new car sales hitting 217 000 units (1994 195 000).

Light commercial and medium vehicles sales were expected to top 111 500 units (101 000), while heavy commercials were expected to jump to 9 600 units from 1994's expected 8 670 level

Total motor industry retail trading revenue, excluding fuel sales, would hit the R63,8bn mark from 1994's expected R52,5bn. This included new vehicle sales of R25,4bn, used vehicle sales (R12bn), workshop revenue (R5,4bn), spares and accesso-

MICK COLLINS

ries (R12,1bn) and other services (R8,7bn)

Naamsa said economic factors underpinning the market included higher levels of foreign investment and the implementation of the reconstruction and development programme

Other factors included government's commitment to monetary and fiscal discipline as well as a pledge by government to reduce progressively its share in the economy

"As the economic recovery gains momentum, pent-up replacement demand for new cars and commercial vehicles will translate into higher aggregate sales"

Demand for and sales of new motor vehicles should also receive a boost from

To Page 2

Vehicles

various planned high-technology, fuel-efficient, new model introductions.

The motor industry was well positioned to take advantage of the expected economic upturn in the years ahead.

New vehicle price movements in recent years were at the mercy of exchange rate movements, Phase VI local content-related costs, excise duty escalations, an increase in VAT from 10% to 14% and domestic cost pressures.

The combined effect resulted in average price increases during 1992 of about 12% in the case of Japanese-sourced product and 11,2% in the case of German-sourced product. For 1993, the average price rises amounted to about 16,5% for Japanese product and 12% for German product.

In 1994 increases should average between 9% and 11%. Next year, assuming reasonable exchange rate stability, prices were expected to rise about 10% in line with the expected increase in the CPI

From Page 1

SA cars

'to get ¹⁹²

ET 8/12/94

smaller, cheaper'

NEW cars in SA are likely to become smaller and more affordable, industry spokesmen said yesterday

Recommendations that import duties on built-up light vehicles should be reduced from 80% to 65% in July next year, with further annual reductions to 40% by 2002, are due to be gazetted tomorrow (Friday)

A spokesman for Toyota said he did not expect this to result in a big increase in the importation of luxury cars, to be sold at lower prices "The margins on imported cars are already very low"

However Stephanus Loubser, MD of Nissan (SA) Marketing, warned that manufacturers would face serious challenges next year "as imported vehicles start becoming a bigger factor in all sectors of the market.

"The local industry will have to reduce the cost of manufacturing drastically and make vehicles more affordable if it wants to remain competitive"

Toyota signs up black firms

LUCKY MADIKIZA

BD 14/12/94

TOYOTA SA has appointed two black companies to handle part of its legal and auditing business as part of its programme to empower more black professionals.

One of the companies, Sizwe and Co, has started work on the annual audit of tool and die manufacturing for Toyota SA Manufacturing (TSM)

"This is their first breakthrough into a major corporation," said TSM finance director Henry Pretorius. "From Toyota's viewpoint it is a good move as the costs are no higher than they formerly were and we will now have a full-time partner looking after the audit."

Sizwe and Co have also been appointed auditors for the Toyota SA Provident Fund.

Durban attorneys Linda Zama and Co have been appointed to handle the legal work involving Toyota SA company vehicles. The company will work with a major insurance firm which is involved with Toyota's vehicle accident insurance.

making the prediction Opinions differ markedly Forecasts range from a little over 210 000 to nearly 230 000

Economic recovery, a rise in business confidence and RDP-generated projects are all contributing to stronger sales of commercial vehicles

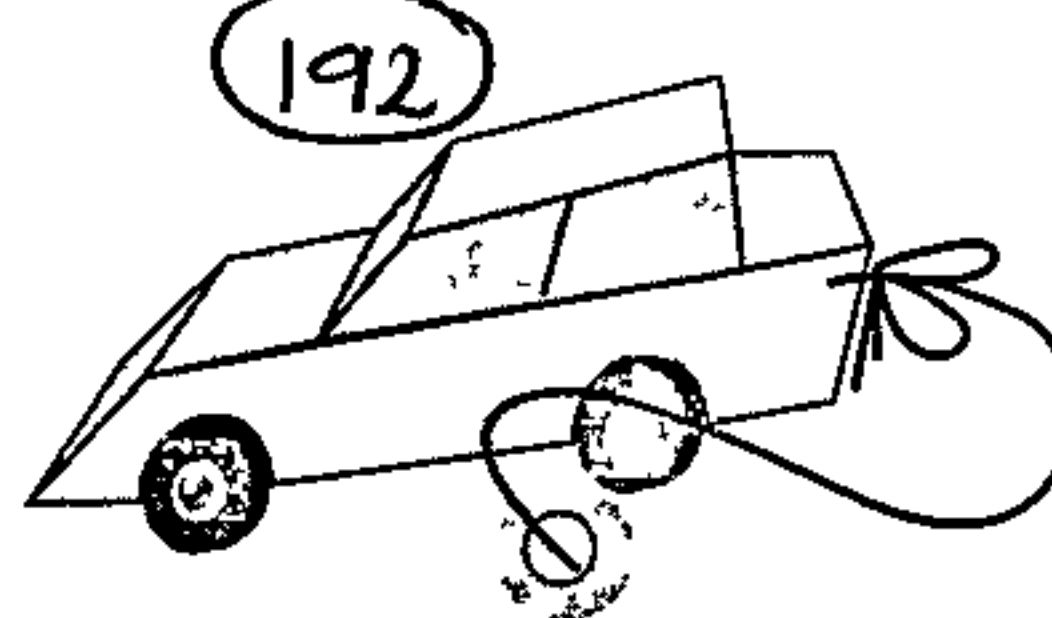

November vehicle sales

Cars	Total	%*
Corolla /Conquest 3 323, Camry 901, other 6		22,9
Golf /Jetta (new) 1 738, Cit/Fox 1 480, Golf/ Jetta (old) 53, Audi 89, other 2		18,2
Sentra 1 376, Sabre 214, Maxima 105, 200SX/ 300ZX 1, Fiat Uno 1 137		15,3
Laser/ Meteor/ 323 1 845, Telstar/ 626 543, other 105		13,5
Honda Ballade 1 189, M-Benz C-Class 904, E-Class 172, S-Class 4		12,3
Astra/Kadett 1 787, Monza/ Kadett 35, Rekord 21, Calbra 2		10,0
3-Series 1 336, 5-Series 121, 7-Series 3		7,9
Subaru		0,0

*% of the total car market

	1994	1993	% Change
November	18 497	16 189	+14,3
Jan - Nov	176 067	180 247	-2,3
Oct (17 882) - Nov			+3,4

Light commercials

Toyota 3 990 (35,8 % of the market), Samcor 2 320 (20,8), Nissan 2 293 (20,6), Delta 1 875 (16,8), VW 545 (4,9), AAD 121 (1,1)

November	11 144	8 238	+35,3
Jan - Nov	95 445	89 599	+6,5
Oct (10 685) - Nov			+4,3

Medium commercials

Toyota 172 (43,8%), Delta 78 (19,8), Nissan 66 (16,8) Samcor 64 (16,3), M-Benz 9 (2,3), Iveco 3 (0,8), AAD 1 (0,3)

November	393	229	+71,6
Jan - Nov	3 157	2 759	+14,4
Oct (305) - Nov			+28,9

Heavy commercials

M-Benz 216 (34,4%), Nissan 113 (18,0), Toyota 104 (16,6), Delta 65 (10,4), MAN 49 (7,8), Tyco 39 (6,2), ERF 21 (3,3), Iveco 18 (2,9), AAD 3 (0,5)

November	628	482	+30,3
Jan - Nov	5 264	4 565	+15,3
Oct (557) - Nov			+12,7

Total vehicle sales

Toyota 8 496 (27,7%), Nissan 5 306 (17,3), Samcor 4 878 (15,9), VW 3 907 (12,7), Delta 3 863 (12,6), M-Benz 2 494 (8,1), BMW 1 460 (4,8), other 258 (0,8)

November	30 662	25 138	+12,9
Jan - Nov	279 933	277 170	+1,0
Oct (29 429) - Nov			+4,2

Source: NATIONAL ASSOCIATION OF AUTOMOBILE MANUFACTURERS OF SA

CAR SALES Like a mirage

Why the lower-than-expected car sales in November? Motor industry marketers, while grateful for a relatively strong sales month, had expected more (see *Leaders*) Monthly sales of 18 497 were well up on October's 17 882 and the previous November's 16 189 — but short of the 20 000 some had predicted

Suggested reasons for the shortfall abound pent-up demand after the five-week industry strike is not as strong as previously thought and has already been satisfied; customers are waiting for 1995 models, the fear of year-end price increases is no longer as acute as it was, fleet buyers are waiting for their new financial years

The consensus view is that next year will offer better prospects than 1994 when total car sales should reach 192 000 Just how much better it will be depends just who is

BRIAN PORTER HOLDINGS

Pointless optimism

FM 16/12/94

Activities: Sales and service of new and used motor vehicles

Control: Porter family

Chairman: B B Robinson MD A M Porter

Capital structure: 2,8m ords Market capitalisation R11,9m

Share market: Price 420c Yields 1,2% on dividend, 3,1% on earnings, p/e ratio, 32,6, cover, 2,6 12-month high, 425c, low, 300c Trading volume last quarter, 10 000 shares

Year to June 30	'91	'92	'93	'94
ST debt (Rm)	9,0	13,8	15,5	11,3
LT debt (Rm)	3,9	3,8	2,4	2,0
Debt:equity ratio	0,55	0,71	0,58	0,47
Shareholders' interest	0,36	0,33	0,30	0,38
Int & leasing cover	2,5	2,0	1,9	1,4
Return on cap (%)	11,4	10,1	8,6	7,5
Turnover (Rm)	307	341	421	429
Pre-int profit (Rm)	7,4	7,6	7,6	5,5
Pre-int margin (%)	2,4	2,2	1,8	1,3
Earnings (c)	78,2	63,4	32,9	12,9
Dividends (c)	21	18	13	5
Tangible NAV (c)	809	855	924	964

Each year when I review Brian Porter's (BPH) results I marvel at what I can only refer to as the unbridled optimism of its shareholders. For unless they are family, or they hold shares for sentimental reasons, there seems every justification for baling out of this counter now — and that has been the case each year for 15 years.

Take for example, the five-year review of performance. The best thing in it is the 10,6% rise in turnover. From this high point, the statistics deteriorate. Operating income has declined by a compound 8,8% a year, pre-tax income by 24,7%, net income after tax by 36,4% and attributable income by 38,1%. Then look at the flagging returns in the accompanying table. Apart from an improved debt:equity ratio there is little to encourage.

Yet — and this is the irony — the share price has risen from a low of 275c in 1990

to 420c now, having peaked at 500c in 1991 and 1992 before falling to 275c in September last year. Neither the statistics nor the indications in the 1994 annual report suggest that 1995 will show a significant improvement. Why then has the share price appreciated again? Is it optimism that things will improve? Or does someone know something the rest of the market doesn't?

In pointing out the contrast between the fundamentals and the share price movement, I do not wish to disparage management. It has been difficult to produce satisfactory returns in the motor industry, whether in the manufacturing or at the retailing and service end.

There is evidence that BPH management is doing its best to improve the performance. That is clear partly from the reductions in debt and stock.

A rigorous cost reduction enabled the Cape division to improve its contribution by 12% but, chiefly because of theft and fraud, the Transvaal division lost money and five loss-making operations have been terminated. These incurred large closure costs.

Chairman Brian Robinson explains that the high effective tax rate (71%) was

because of an uneven distribution of income within the group. The group tax rate, he says, was applicable to the Cape operations whereas no relief was granted for the Transvaal losses.

Once these problems are out of the way there may be more grounds for optimism. Perhaps this is why the share price has risen. True, there is heightened expectation that the motor industry is facing a better future than for some time, but until there is hard evidence that BPH will sustain respectable EPS growth, it remains pointless to try to justify its inclusion in a portfolio when so many other opportunities abound.

Gerald Hirshon

AUTOQUIP *FM 16/12/94*
Concerns about debt

192

Activities: Wholesale distribution of automotive accessories, tyres and select replacement parts

Control: Directors 38,2%, Merhold 35,2%

Chairman & MD: B D'A Coquelle

Capital structure: 10,9m ords. Market capitalisation R7,6m

Share market: Price 70c Yields 21,9% on earnings, p e ratio, 4,6, 12-month high, 80c, low, 27c Trading volume last quarter, 141 000 shares

Year to June 30	'91	'92	'93	'94
ST debt (Rm)	4,1	4,8	2,8	6,8
LT debt (Rm)	0,3	3,5	3,0	1,9
Debt.equity ratio	0,45	1,3	0,99	1,1
Shareholders' Interest	0,38	0,25	0,26	0,29
Int & leasing cover	3,1	2,0	1,8	2,4
Return on cap (%)	19,6	12,1	9,5	13,5
Turnover (Rm)	50	53	60	66
Pre-int profit (Rm)	5,0	3,8	2,8	4,4
Pre-int margin (%)	10,1	7,2	4,7	6,8
Earnings (c)	11,1	6,8	7,2	15,3
Dividends (c)	5,0	2,5	nil	nil
Tangible NAV (c)	60	71	71	87

Motor parts distributor and retailer Autoquip's operating margins are widening; turnover grew only 9% in 1994, earnings more than doubled. However, high interest payments on mounting debt is depressing investor perceptions. This is evident in the p e of only 4,6.

Last year, retentions could not fully finance operating and investment activities. Operations generated R4,5m, but another R1m was needed and this pushed borrowings to R8,7m. As happened two years ago, gearing exceeded 100% and interest payments swallowed two-fifths of operating income. This is a big drawback with climbing interest rates.

Executive chairman Bruce Coquelle expects further substantial earnings growth this year. If this happens, debt repayment must be a priority. A high debt.equity ratio is not ideal for automotive parts dealers, the motor parts industry is competitive and cyclical.

Corporate buyers of new vehicles continue to dominate the motor market. These vehicles are usually serviced by the vehicle franchise dealer under some form of maintenance programme, which precludes the independent parts dealer from being able to supply parts for the programme, the franchise dealer sources the parts from the vehicle manufacturer.

Coquelle says last year's widening of margins was achieved through the re-focusing of the Autoquip division and by remaining price competitive in the parts division. "Expenses were well controlled

Autoquip

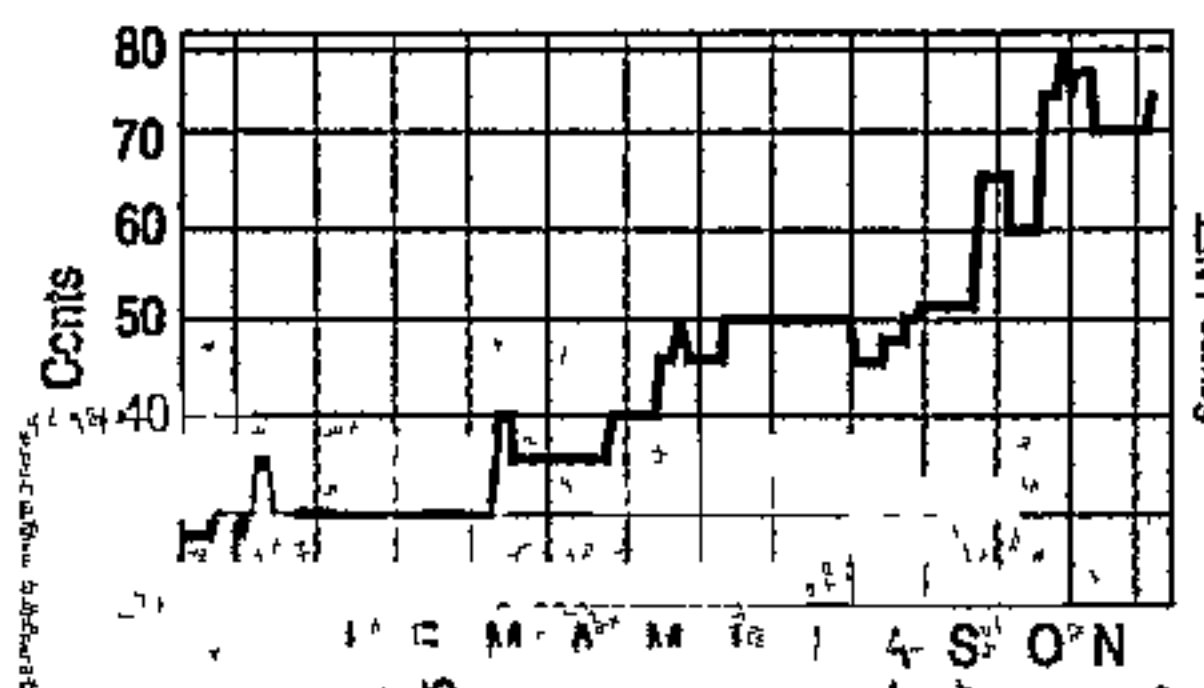

FM 16/12/94

and careful attention was paid to stock and stockturn," he says

Also, Partco, a specialised distributor of quality automotive parts, overcame stock shortage problems, grew turnover by 50% and earnings seven-fold. At 70c, the share is almost triple its annual low **192**

The low p e is probably a fair valuation given the high gearing

Kate Rushton

BD 20/12/94 (192)
White VW workers vote to move into Numsa fold

ERICA JANKOWITZ

WHITE workers at Volkswagen SA voted overwhelmingly to join the National Union of Metalworkers of SA (Numsa) and leave the whites-only SA Iron, Steel and Allied Industries Union, Ashwin Desai says in the latest issue of the SA Labour Bulletin.

According to Numsa negotiations co-ordinator Ga-

vin Hartford, this would leave the way clear for the union to open career paths for members beyond the category of technician, which had traditionally been the cap, Desai said.

In the past, jobs were defined in racial terms with white workers automatically joining the ranks of salaried staff and blacks confined to manual labour.

Numsa believes that recruiting all levels of workers will erode this artificial barrier to advancement by blacks beyond artisan.

Desai warned that as many white workers would be affected by this move, and had joined the union to protect their jobs, Numsa would have a tough time defending "the interests of this crust of white privilege" while at the same time ensuring its own members' upward mobility from the ranks.

Numsa's aim was to win a 50% plus one majority membership within the almost 2 000 salaried staff of VWSA and then bargain on their behalf at plant level.

But its ultimate aim was to create a single bargaining forum for salaried and non-salaried staff, explained Desai.

"Burly Afrikaner foremen and superintendents, until yesterday, the foot soldiers of the AWB in Uitenhage, will now march under the banner of the most militant union in Cosatu."

X X

Motor industry urged to gear up for competition

(192) BD 23/12/94
SA's motor industry needs to move up a gear or so if it wishes to hold its own against chill winds of competition fanned by the country's return to the global fold, analysts say

Proposed cuts in import duties are aimed at boosting competition in the industry, but there is little consensus on how it will weather the expected post-sanctions onslaught of efficient foreign production

"Without rationalisation the motor manufacturing industry is likely to shrivel and die," Motor Industries Task Group (MITG) chairman Derek Riley said

Few people associated with the local industry dispute this. They say it is inefficient, overprotected and plagued by industrial discontent. Strikes earlier this year cost it R2bn in lost turnover.

Work began more than a year ago on a restructuring plan, with critics predicting tough times for the industry as SA comes to terms with the requirements of GATT

The Board on Tariffs and Trade has recommended cuts in import duties on completely built-up (CBU) units from 80% to 65% in July, with further annual reductions to 40% in 2002

Duties on components and completely knocked-down (CKD) units — currently subject to a complicated structure of excise duties, rebates and import duties — would be dropped to 49% next July and gradually reduced to 30% by 2002 if the board's proposals were implemented

It said further import duty reductions could be achieved in terms of a duty rebate

and export promotion scheme which would allow manufacturers to offset duty payable on imports in proportion to the extent to which they exported components, accessories or finished vehicles

Riley said a major shortfall in the board's proposals was the omission of strong measures to encourage production of greater volumes of fewer models

If the industry became "a massive assembly architecture" at the expense of the component manufacturing sector, jobs would be lost as assemblers imported more components, he said

Motor manufacturers shared Riley's logic but not his dire predictions. "The difference is the board wants to rely on market forces to cause rationalisation. Their's is a free-market view," said Toyota SA financial director Peter Robinson

Robinson and others, including Mercedes-Benz SA CE Christoph Kopke and BMW SA spokesmen, say they intend to eventually concentrate on the production of only one or two models. The majority of their local production would be exported and all other domestic model requirements would be imported, made more viable by the proposed duty rebate system

What was also critical, said Kopke, was the duty differential between components and CBUs. National Association of Automobile Manufacturers of SA (Naamsa) president and Nissan SA chairman John Newbury said "The differential between CKD and CBU should be 30% to still stimulate local manufacturing" — Reuter

MANUFACTURING

MOTOR

INDUSTRY

1995

Toyota increases its earnings 14,3%

BD 2/3/95
MARCIA KLEIN

TOYOTA SA managed to increase earnings 14,3% to 275,1c (240,6c) a share in the year to December despite depressed sales and a loss of market share

Executive chairman Bert Wessels said the industry was subject to "serious disruptions" last year with the April elections and a five-week strike in the third quarter

Despite these disruptions, new vehicle sales across the industry rose 1,7% compared with the previous year

Toyota's sales, however, were 7,3% lower at 81 133 units, and its market share declined to 26,8% (29,4%) This was largely due to "political turmoil in Kwazulu/Natal" which affected production

Turnover rose 6,5% to R4,9bn (R4,6bn), and operating income was 11,3% higher at R183m (R164,4m) Although the margin improved, Wessels said it remained "at an unacceptable level of 3,7%"

Wessels said the deterioration of the rand against the yen caused an increase in the cost of imported components and a concomitant increase in the net excise account of about 17%. Competition did not allow this to be offset by price increases
Attributable income was 14,3% up at

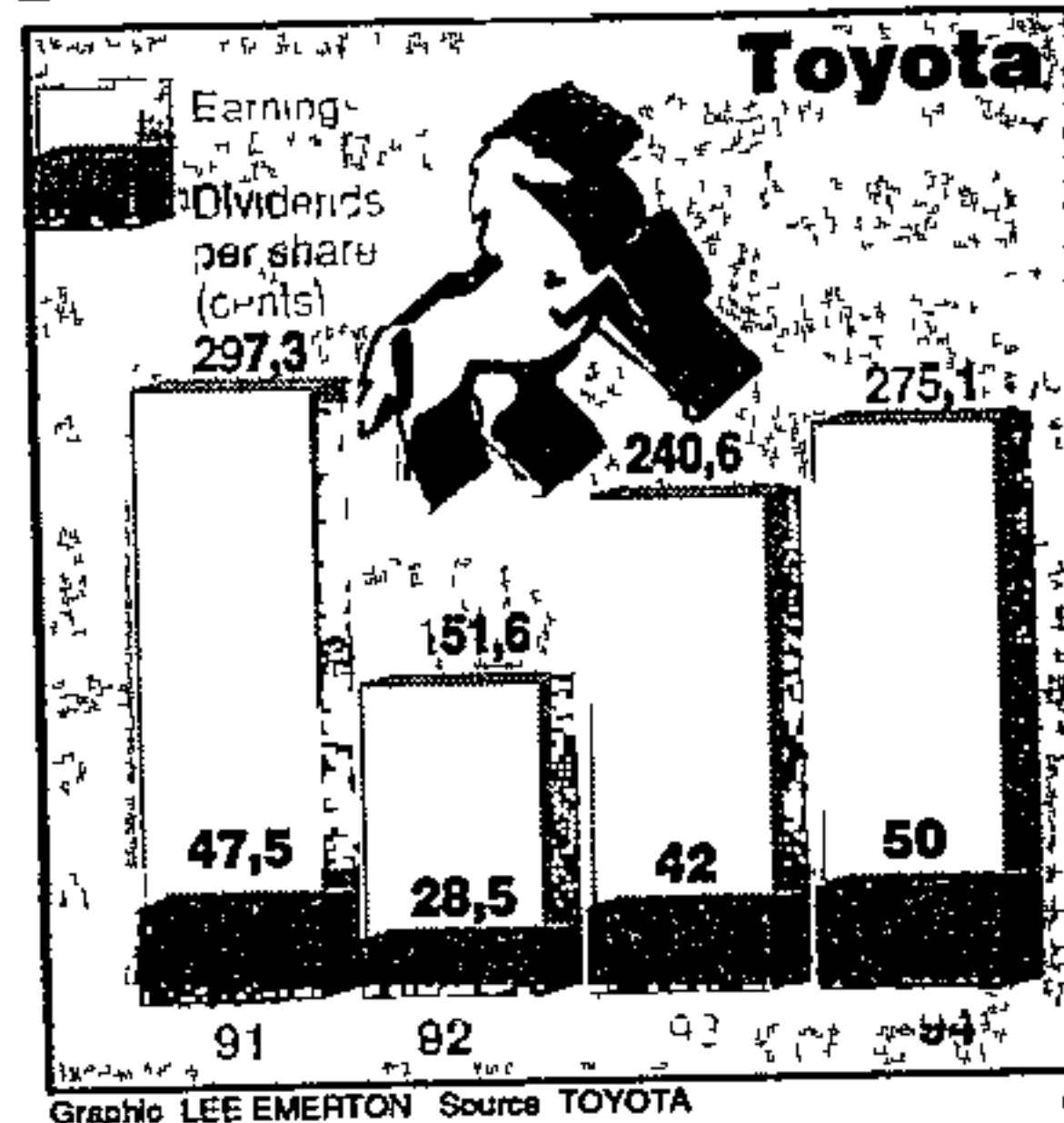

Graphic LEE EMERTON Source TOYOTA

R111,9m (R97,8m) A final dividend of 30c a share was declared, lifting the full year dividend 19% to 50c (42c) a share

Wessels said new vehicle sales were expected to increase 13% this year on the back of an improved economy Toyota planned to sell more than 100 000 new vehicles in the retail market "and achieve a 28,5% retail market share" But a further deterioration of the rand against the yen could not be excluded

Toyota running well

BY CHARLOTTE MATHEWS

Car manufacturer Toyota SA improved earnings a share by 14,3% to 275,1c in the year to December 1994 compared with 1993 despite the industry strike, higher component prices and a decline in market share.

Turnover grew to R4,9 billion from R4,6 billion and operating income was 11,3% better at R183,0 million, showing operating margins improving to 3,7% from 3,5% previously.

Toyota's directors said this was still unacceptable. It stemmed from another depreciation of the rand against the yen, making the average cost of imported components steeper and increasing

(192)
the net excise account as well *SAAR 2/3/95*

Because of competition in the market place, this could not be offset by price increases. Toyota's market share in 1994 was 26,8% from 29,4% in 1993, mainly because of the political turmoil in KwaZulu-Natal which disrupted production.

Attributable income grew to R111,8 million from R97,8 million and a more generous 50c (42c) dividend was announced on a reduced dividend cover.

The total new vehicle retail market should grow by about 13% in 1995 against 1994 as the economy improves. Toyota plans to sell over 100 000 new vehicles and to achieve a 28,5% retail market share.

JIM MILLER, HEINRICH HOLTMANN

Driving for change

(192) FM3/2/95

The days when the SA motor industry was an island apart from the rest of the world are gone forever. The arrival of foreign MDs to head two of the biggest vehicle manufacturers, Volkswagen and the SA Motor Corp (Samcor), is further evidence that SA companies are becoming fully integrated into the global motor industry.

Jim Miller, a Ford Motor Corp man for more than 20 years — and until recently director of export operations at Ford of Europe — has been appointed to head Samcor. He replaces Robert Herbertson.

At VW, Heinrich Holtmann has taken over from long-time MD Peter Searle. This is Holtmann's first direct involvement in vehicle assembly and marketing.

In both cases, the changes herald greater control over the companies by overseas principals as part of a deliberate strategy to draw them into international production networks.

Ford is only one of three shareholders in Samcor — the others are Anglo American Industrial Corp (Amic) and the minority Employees Trust — but when it decided last year to reinvest, the US company made it clear it wanted its own man in charge. Amic, which has never seemed entirely comfortable running a motor company, was happy to oblige.

Miller insists he is answerable to all the shareholders, but there can be little doubt that Samcor, which produces Ford, Mazda and Mitsubishi vehicles, is in for a solid dose of Ford management principles.

Before his European stint, Miller was MD of Ford in New Zealand, where he oversaw significant improvements in the company's market share and profitability.

Samcor will hope he can administer the same medicine locally. Market share and image have drifted in recent years, and profits have been under strain. Miller thinks lack of Ford management input during its absence probably contributed to the problems.

Ford, Mazda and Mitsubishi all continued to support and provide technical expertise to SA firms during the years of sanctions and isolation but they conducted arm's-length relationships. Now that it has a financial interest in the SA company, Ford, which owns 25% of Mazda internationally,

is anxious to rectify matters.

Predictably, there is an air of nervousness among some Samcor managers as to what Miller's new broom will sweep in. One thing they shouldn't necessarily expect is a wholesale invasion of American executives. Says Miller: "There is already a good management team in place. I would only bring in people who could augment them — and after full consultation."

Of the company's past performance, he notes diplomatically: "I have not been here long enough personally to comment on what happened before but I'm confident that every decision was taken with the company's best interests at heart."

Miller (48) who has a degree in business administration and MBA in marketing from Michigan State University, expects to spend "four or five years" at Samcor before his next Ford posting. Having volunteered for the Samcor job after learning Ford was reinvesting, he arrived in SA with his wife Pat, having left two daughters at university in the US.

Holtmann, on the other hand, is here with the whole family — wife Beata, son David

its SA operation.

Though he has no specific experience of the industry, he is quietly confident he can meet the new challenges. And one of the most important is to prepare the company for increased international exposure.

"The SA market is opening up and exports will become more important," says Holtmann. "We have to incorporate the SA plant into the production process of the whole group."

VW's Uitenhage plant last year earned about R350m exporting vehicles and components to other VW operations around the world. One important contract, supplying Jettas to mainland China, is due to end shortly and the company is anxious to find new outlets for its production.

Holtmann expresses confidence that it will succeed but notes that quality will have to be maintained at international levels. "It's a policy to have the same standards worldwide. This means customers shouldn't be able to tell where a car is produced because of differences in quality."

He is also anxious to reduce VW's lengthy delivery lead times — a common

problem in an industry still recovering from last year's drawn-out strike. VW has suffered more than most from labour disputes in recent years but Holtmann expects the company's ground-breaking agreement, giving labour a say in company decisions to reduce friction and the potential for stoppages.

Miller and Holtmann say they will not have to constantly look over their shoulders at head office. There is clear agreement on what needs to be achieved at Samcor and VW but the new men in charge have a lot of independence in determining how to get there.

As Holtmann puts it:

"There is an understanding of what Germany wants me to achieve. How I achieve it, within broad terms, depends on me."

He and Miller expect to find different ways to unwind away from their new responsibilities.

The American says he has no hobbies "but I like to read anything and everything and spend time with my wife."

Holtmann, on the other hand, plans to be more energetic and lists playing tennis "and learning to play golf properly" as his leisure ambitions. ■



VW's Holtmann and Samcor's Miller signalling motoring's global return

(17) and daughter Daniela (15)

They are no strangers to SA. The globe-trotting Holtmann spent nearly seven years as financial director of the Johannesburg subsidiary of the German industrial group Klockner-Humboldt-Deutz (KHD).

From there, he was posted to a KHD subsidiary in Spain for five years, then returned to Germany for two years. Thereafter, he joined Swiss-based Alu-Suisse, which manufactures aluminium body panels for Audi cars. While he was at Alu-Suisse, VW in Germany picked him to run

revived to \$4,58, a 10c surge

CT(BR) 8/3/95 18(192)

New appointment for ADE's Korte: Atlantis Diesel Engines (ADE) managing director Fritz Korte has been appointed CEO of Mercedes-Benz operations in Mexico. He will leave in June to take up his new post. ADE, in which Mercedes-Benz AG is a shareholder, was in difficulties during the recession when Korte was seconded there from Mercedes-Benz in Argentina in 1990. He found markets for new products in this country and overseas. ADE currently supplies between R5 million and R6 million worth of components a year to Mercedes-Benz in Argentina and Brazil. It manufactures engines under licence from Mercedes-Benz and from Perkins Engines of the UK. ADE chairman Carel van der Merwe said yesterday: "Fritz and his team have succeeded in turning ADE into a market-driven organisation able to compete internationally. This transition has been achieved in the face of rapid changes in the South African automotive industry as it emerges from a protected environment."

Rugby World Cup boosts new car sales

192 Star 8/3/95

■ BY ROY COKAYNE

New car sales surged to their highest February sales level in 11 years last month on the back of above-average demand from car rental companies and government departments

Car rental companies are buying vehicles ahead of anticipated increased business because of the Rugby World Cup in May

The National Association of Automobile Manufacturers of South Africa (Naamsa) said the demand for new cars and all types of new commercial vehicles remained strong

Recovery in sales

Of the motor manufacturers, Delta Motor Corporation was the most bullish about the implications of the figures

"We are witnessing a significant and far-reaching recovery in new vehicle sales

"We believe it is indicative of the increasing consumer and business confidence and the momentum developing from RDP focused investment activities," said Delta sales and marketing director John Cuming

Figures released by Naamsa showed that sales of new cars in February rose by almost 29 percent to 20 374 units compared to the same month last year — and were 22,3 percent higher than sales in January this year

Impressive growth was also achieved in all other sectors

The low-volume heavy commercial vehicle sector led the pack with sales rocketing by 64 percent to 573 units last month compared to the 349 units sold February last year. Sales in this

sector last month were also 19,4 percent higher than in January this year

New light commercial vehicles, bakkies and minibus sales remained in a strong upward phase last month, reaching 11 075 units. This sales level represents an improvement of 2 935 units or 36 percent compared to February last year — and 15,8 percent up on January this year

Truck sector gains

The medium truck segment also recorded sharp gains last month. Sales rose by 42 units or 16,5 percent compared to February last year and were 16 percent higher than sales achieved in January this year

Transport consultant to the motor industry Max Braun said the truck rental industry had

been a big factor in driving the medium commercial vehicle sector for some time

Motor industry analyst and Econometrix director and economist Tony Twine said demand for passenger vehicles had escalated in the first months of the year during the past few years

This was largely attributable to the large proportion of finance deals that were now based on the residual value of vehicles, he said

Although Toyota South Africa group marketing director Johan van Zyl admitted the sales figures were impressive, he warned against overstating the situation

He said the market in February was driven by seasonal buying and a degree of pent-up demand for vehicles held over from last year

February car sales at 10-year high

NEW car sales in February were the best in a decade, rising 29% year on year to 20 374 units, according to National Association of Automobile Manufacturers of SA (Naamsa) figures released yesterday

Sales were 22% up on the previous month's 16 665 units. Naamsa said the growth trend evident in January — when sales were 17,2% higher than the previous year — had continued in February with solid gains in all sectors

Toyota topped February's car sales with 4 888 units, followed by Volkswagen, Nissan, Samcor and Delta. Toyota's Corolla was the top-selling passenger model, with

MARCIA KLEIN

sales of 3 872 units. It was followed by Nissan's Sentra, Opel's Kadett and Astra and Volkswagen's Fox and Citi models.

Sales of new light commercial vehicles, bakkies and minibuses reached 11 075 units, the highest February sales figure since 1982, 36% higher than last year and 15,8% above January's sales. Toyota's Hilux topped the best-seller list

Sales in the low-volume medium and heavy truck sectors were buoyant. Sales of medium commercial vehicles were up

□ To Page 2

Car sales

16,5% (42 units) on year-earlier figures, while heavy truck and bus sales leapt 64% (224 units)

Naamsa said the strength in heavy commercial vehicle sales "was an indication of the recovery and upward trend in fixed investment in the SA economy". This year was expected to be "one of the best years for the new vehicle manufacturing associated industries" in a decade. Underlying demand remained strong. Demand from the car rental business and government departments was also above average

Toyota SA group marketing director Johan van Zyl said February's sales were driven "by seasonal buying and a degree of pent-up demand carried forward from 1994". The market reflected higher levels

of business confidence and fixed investment. Tourism was playing a substantial role in the market, with high demand for hire cars.

Delta Motor Corporation sales and marketing director John Cuming said the significant growth in light commercial vehicle sales reflected a revival in the informal and small business sectors.

Samcor said customers were bringing forward their vehicle purchasing decisions to minimise the effect of the increase in interest rates. Rental companies were gearing up in anticipation of increased demand for the rugby World Cup

McCarthy Retail CE Terry Rosenberg said car sales would reach 220 000 units this year, worth R16,2bn at retail level

□ From Page 1

- Final Press Return

Tiger Wheels poised for huge export drive

(192) CT(BA) 10/3/95

In bid to increase its exports by 75 or 80 percent, the company plans a radical expansion of its production capacity

BY CHARLOTTE MATHEWS
INVESTMENT EDITOR

Tiger Wheels is about to lift production by one-third to increase its export capacity through introducing a new shift system at its factories in Babelegi and Elandsfontein.

At a presentation to analysts and the media yesterday, organised by stockbrokers Frankel Kruger Vinderine, joint chairman and chief executive Eddie Keizan said as part of the group's ongoing programme to increase its global competitiveness it had to lift its productivity to international standards and make the maximum return from its capital investment.

Tiger Wheels at present exports about 60 percent of its wheel pro-

duction and it expects this will increase to 75 or 80 percent when the new shifts get under way.

After extensive research, the company will change its present shift rostering system to continuous production which will result in a huge increase in output.

The new shift will mean that Tiger Wheels will be able to increase the number of days worked by about 40 percent.

Workers will earn about 30 percent more a month than the current monthly wage, excluding overtime, although those workers who put in excess overtime under the old shift system will be worse off.

Keizan said the system had been presented to a meeting of the

company's 520 workers in Babelegi two weeks ago and 95 percent of them were in favour of it.

The company's core business is making TSW-branded aluminum wheels, which are sold through its own Tiger Wheel 'n Tyre retail stores and four franchise outlets in South Africa as well as in the US, UK and around 20 other countries.

In addition to its own products, the company is the local distributor of Yokohama tyres. In 1988 it successfully tendered to take over Yokohama's distribution business in the United Kingdom, giving it entry to the international market.

"Our future is really linked to the international market," joint

chairman Martin Glatt said. "The increased production we have invested in, which has not yet come through in volume, is targeted at the world market."

"Our distributors have been pushing us for more product and so far we have been unable to deliver it. Our name and image worldwide has to do with the prod-

uct in the marketplace." Besides the R13 million acquisition of Dorbyl's Elandsfontein plant last year, Tiger Wheels has in the past reinvested about half of wheels sales every year on capital expenditure.

Tiger Wheels shares are currently trading at an all-time high of 685c, having surged steadily from 170c in January to March 1994.

Eddie Keizan
says his
company has
plans for
worldwide
expansion

Tiger Wheels to increase output

(192) Star 10/3/95 (18)

■ BY CHARLOTTE MATHEWS

Tiger Wheels is about to lift production by one third to increase its export capacity by introducing a new shift system at its factories in Babelegi and Elandsfontein

At a presentation to analysts and the media yesterday, joint chairman and chief executive Eddie Keizan said the group will be changing its present shift rostering system to continuous production

This means it will be able to increase the

number of days worked by about 40 percent

Tiger Wheels at present exports about 60 percent of its aluminium wheel production and expects this to increase to 75 or 80 percent once the new shifts get under way

Workers will earn about 30 percent more than the current monthly wage excluding overtime, he said

Keizan said the system had been presented to a meeting of the company's 520 workers in Babelegi two weeks ago and 95 percent were in favour of it

COMPANIES

Tiger Wheels gears up for exports

WHEEL and tyre company Tiger Wheels is in the throes of significantly expanding its manufacturing operation, with most of the additional capacity earmarked for the export market.

Joint chairman and CE Eddie Keizan said the company was expanding capacity partly because of higher demand for its brands, and partly because it needed a certain economy of scale to ensure it was world competitive. (192) (192)

Last month Tiger Wheels reported a 71% increase in attributable income to R5,8m on 65% higher turnover of R111,6m for the six months to December.

Its products are sold to new car manufacturers, its own wholesale division (which on-sells to retailers) and its international division.

Joint chairman Martin Glatt said when Tiger Wheels started to export some years ago, it did not have a product with a world name. Now it had importers in 21 different countries across the UK, Europe, the US and Japan. Its brand TSW had become accepted and acknowledged worldwide

MARCIA KLEIN

Since it listed in 1987, it had always offered shareholders a scrip dividend and had had an acceptance rate of around 80%. This had provided capital to help it expand.

Commenting on the possible loss of export incentives, Keizan said the company had been on a drive to be globally competitive without the help of incentives.

SA's re-entry into world markets meant that now the prices of raw materials like aluminium were world competitive, so it faced the same cost inputs as its competitors. Tiger Wheels' economies of scale were nearly large enough to ensure it could be a competitive global player.

He said details of the imminent restructuring of the motor industry were unknown. But what was known was that the industry would have an export focus, and as long as cars were sold, they would use tyres and wheels. BD 10/3/95

The company was currently having its products manufactured in other countries under licence.

Motor industry, unions in agreement

(192)
JOHANNESBURG — The South African Motor Industry Employers' Association (SAMIEA) today announced agreement had been reached with three trade unions in the motor industry after three years of negotiations

ARG 13/3/95

The agreement had re-

stored the relationship between SAMIEA and the National Union of Metalworkers of South Africa, the Motor Industry Employees' Union and the Motor Industry Staff Association.

The new agreement provided for increases in minimum wages, improved social secu-

ity and the creation of a new provident fund

"One of the major achievements is extended trading hours which will allow workshops to remain open for business until 11pm from Mondays to Fridays and until 1pm on Saturdays," the statement said. — Sapa

Motor industry deal signed

(192) (2/23)
BD 14/3/95
A WIDE-RANGING agreement covering about 170 000 workers and 17 000 employers has been reached in the retail motor industry, where the lowest-paid workers will receive a 13% wage increase.

The agreement, which took three years to negotiate, covers garages, workshops and panelbeaters. It provides for extended working hours and phasing out discriminatory pension funds and medical aid for National Union of Metalworkers' of SA (Numsa) members.

It was negotiated between the SA Motor Industry Employers' Association, Numsa, the Motor Industry Employees' Union and the Motor Industry Staff Association

RENEE GRAWITZKY

The agreement provides for a 13% increase for about 43 000 petrol attendants, raising the minimum monthly wage in the industrial council agreement to R598.

Numsa motor sector co-ordinator Tony Ehrenreich said it was unusual that the lowest paid workers received the lowest percentage increases. Petrol attendants' wages would be renegotiated in six months after the fuel forum had deliberated on deregulation of the fuel industry. If the industry was deregulated, thousands of jobs could be jeopardised.

To Page 2

Motor industry

(192) (2/23)
BD 14/3/95
 From Page 1
Artisan rates would increase 14,5% to a minimum R2 404 a month, while workers between the bottom and top grades would receive a 19% increase. Workshop hours would be extended from 6pm to 11pm during the week and to 1pm on Saturdays.

Employers' association executive director V.C. Fourie said the agreement to extend working hours reflected Numsa's "realisation" of market requirements. Ehrenreich said the possibility of job creation was a reason why Numsa agreed to this.

Employers agreed to establish a provident fund with a 3% contribution from employers and workers which, over two years, would be raised to 6%, bringing Numsa members in line with white workers who were on a different fund.

A medical aid for Numsa members would also be established with the aim of creating one fund for all workers in the industry. The agreement is expected to be effective from April.

Motor industry deal signed

(192) (35) BD 14/3/95
A WIDE-RANGING agreement covering about 170 000 workers and 17 000 employers has been reached in the retail motor industry, where the lowest-paid workers will receive a 13% wage increase

The agreement, which took three years to negotiate, covers garages, workshops and panelbeaters. It provides for extended working hours and phasing out discriminatory pension funds and medical aid for National Union of Metalworkers' of SA (Numsa) members

It was negotiated between the SA Motor Industry Employers' Association, Numsa, the Motor Industry Employees' Union and the Motor Industry Staff Association.

RENEE GRAWITZKY

The agreement provides for a 13% increase for about 43 000 petrol attendants, raising the minimum monthly wage in the industrial council agreement to R598

Numsa motor sector co-ordinator Tony Ehrenreich said it was unusual that the lowest paid workers received the lowest percentage increases. Petrol attendants' wages would be renegotiated in six months after the fuel forum had deliberated on deregulation of the fuel industry. If the industry was deregulated, thousands of jobs could be jeopardised

To Page 2

Motor industry

(192) (35) From Page 1
Artisan rates would increase 14,5% to a minimum R2 404 a month, while workers between the bottom and top grades would receive a 19% increase. Workshop hours would be extended from 6pm to 11pm during the week and to 1pm on Saturdays

Employers' association executive director Fourie said the agreement to extend working hours reflected Numsa's "realisation" of market requirements. Ehrenreich said the possibility of job creation was a reason why Numsa agreed to this.

Employers agreed to establish a provident fund with a 3% contribution from employers and workers which, over two years, would be raised to 6%, bringing Numsa members in line with white workers who were on a different fund.

BD 14/3/95
A medical aid for Numsa members would also be established with the aim of creating one fund for all workers in the industry. The agreement is expected to be effective from April.

Agreement in motor industry

SPECIAL CORRESPONDENT

workshops (192)
The SA Motor Industry Employers' Association said it had made an agreement with the three bodies, who represent about 60 000 of the 190 000 workers in the industry

JOHANNESBURG· Representatives of three worker organisations in the retail motor industry yesterday agreed to better wages and extended trading hours for

CT 14/3/95

Motor industry pleased

THE overall impact of the Budget on the motor industry should prove to be mildly positive, says National Association of Automobile Manufacturers of South Africa president John Newbury

As expected, he said, there had not been an in-

crease in the rate of Value Added Tax (VAT).

The increases in excise duties on a variety of products as well as the 2c a litre increase in the fuel levy should not have any negative effect on overall demand patterns, he said.

Star 16/3/95

(192)

Higher marginal tax expected to slow car sales

PAT CANDIDO
The Argus Bureau

PORT ELIZABETH — The new top marginal tax rate of 45 percent on incomes of more than R80 000 a year will have a restraining affect on the sales of new vehicles, says Willie van Wyk, chairman of Port Elizabeth's Regional Chamber of Commerce and Industry

Mr Van Wyk, who is also managing director of Delta

Motor Corporation, said today the closing of the tax loophole for more than one company car would also affect sales

"Top earners — who are likely to run second and third company cars — will now pay significantly more tax on this particular perk

"While the affect on sales cannot be quantified at this stage any additional tax must have a depressing effect, spe-

cially on sales of smaller cars

"However the massive infusion of capital into the Reconstruction and Development Programme will stimulate the building and small business sectors, both of which are more likely to rely on the fast-growing commercial vehicle sector for transportation needs"

He said the increase of two cents in the price of fuel — although implemented to mini-

mise inflationary effects — still resulted in an absolute increase in costs with all attendant adverse implications

It was encouraging that the government had allocated R11,5 billion to the Eastern Cape region (192) (220)

"Overall we believe it is a positive budget in line with requirements of the times that we live in and the issues which need to be urgently addressed"

MOTOR INDUSTRY

Plates de jure?

(192)
FM 17/3/95

With the motor industry expecting at least 35% of total vehicle sales to be imports by 2000, the SABS is already in a flap as to what position to take on fancy number plates carried on the foreign vehicles

The bureau has invited comment on proposed amendments to plate specifications and says it plans to introduce a further four number plates which will cater for German, US and Japanese specifications. But what about Taiwanese or heaven forbid, Korean vehicles? Also to be taken into account are Swedish imports and possibly even Indian

Now, says the bureau, imports represent only 1% to 2% of total sales

But Econometrix economist Tony Twine says imports last year accounted for 4% (12 000 vehicles) of the total market with the trend continuing to accelerate over the next five to six years as tariff barriers fall. "As we get to the end of the current life of present models, introduced in 1992-1993, we could see big changes as local manufacturers opt for imports, especially for low volume models"

The bureau says already there are "severe" problems in that the two plate sizes in SA cannot fit the space provided on the imports. In some cases, it says, it is impractical to change the vehicle to accommodate the plate size and in other cases the tooling costs involved increase the vehicle cost substantially

That's well and good, but are the drivers of the imported models going to be allowed to display plates with the characters woven into flashy, pint-sized, hard-to-read script, which some of them appear to be getting away with already?

Whatever the outcome, the advent of imports has not held back the local motor manufacturing industry which is making hay while the sun shines. February sales smashed through 10-year highs indicating demand has not slackened. Government departments are credited with bolstering the pick-up despite calls to halt the gravy train. Rugby World Cup fever has also pushed car rental companies into increasing fleet sizes to meet the expected flood of visitors

Commercial vehicle sales continue to improve, a sign that business is making commitments on fixed investment. It is also a firm indication that the economy is getting back to work

FEBRUARY VEHICLE SALES

Manufacturer	Cars	Number of sales	Total sales	% of total car market
Toyota	Corolla/Conquest	3 872	4 888	24,0
	Camry	982		
	other	34		
VW	Citi/Fox	1 952	4 312	21,2
	Golf/Jetta (new)	2 142		
	Golf/Jetta (old)	109		
	Audi	105		
	other	4		
Nissan	Sentra	1 884	3 517	17,3
	Sabre	354		
	Maxima	152		
	200SX/300ZX	3		
	Fiat Uno	1 124		
Samcor	Laser/Meteor/323	1 424	2 078	10,2
	Telstar/626	610		
	other	44		
Delta	Astra/Kadett	2 003	2 027	9,9
	Rekord	5		
	Monza/Kadett	16		
	Calibra	3		
M-Benz	Honda Ballade	827	1 940	9,5
	M-Benz C-Class	913		
	E-Class	132		
	S-Class	34		
	other	34		
BMW	3-Series	1 375	1 610	7,9
	5-Series	163		
	7-Series	72		
Subaru		2	2	0

	1995	1994	% change
February	20 374	15 818	+28,8
January (16 655) to Feb			+22,3

MEDIUM COMMERCIALS				LIGHT COMMERCIALS			
	Number of sales	% of market	% change		Number of sales	% of market	% change
February	297	25,5	+16,5	February	11 075	8 140	+36,1
January (256) to Feb			+16,5	January (9 560) to Feb			+15,8

HEAVY COMMERCIALS				TOTAL VEHICLE SALES			
	Number of sales	% of market	% change		Number of sales	% of market	% change
February	573	34,9	+64,2	February	32 319	24 562	+31,6
January (480) to Feb			+19,4	January (26 961) to Feb			+19,9

Source: NATIONAL ASSOCIATION OF AUTOMOBILE MANUFACTURERS OF SA

SA cars ⁽¹⁹²⁾ exported ^(7/11/95) to Uganda

The Argus Foreign Service

NAIROBI — South Africa is edging into the car market in Uganda, having provided a third of all new cars in January, an East African newspaper has reported

Quoting an official of the motor vehicle unit of the Uganda revenue authority, the report said of 150 cars imported that month, 54 were new models bought from South Africa

"While reconditioned cars still dominate imports, there has been a remarkable increase in the arrival of new cars, especially BMWs, Hondas and Mazdas, from South Africa," it said

The official predicted with the lifting of sanctions, Uganda was likely to import from South Africa goods normally bought in Asia or Europe.

"We pay less for freight, less insurance and it takes just a week by land," said a Kampala motor dealer

In April Uganda's ministers of finance and economic planning, trade and industry, tourism and wildlife will address the South African business community on opportunities in Uganda ARG 20/3/95

Fire damage keeps VW plant shut

MARCIA KLEIN

VOLKSWAGEN SA (VWSA) is unlikely to reopen its Uitenhage plant — damaged by a fire in the paint shop last week — before Wednesday (192) BD 20/3/95

VWSA technical director Hans-Jurgen Wiegand said at the weekend that the loss of turnover amounted to R13m a day.

Contingency plans were being made to keep losses to a minimum and reduce the effect on employees and customers, he said.

Analysts estimated that the fire would cost the company at least R30m in sales, plus thousands of rands in repairs. However, it was possible that the lost production could be made up.

Wiegand said two spraying booths were severely damaged. It had not yet been possible to fully assess the damage. There was no explosion before the fire. Sabotage was not suspected.

All production and production-related areas were closed on Friday, and would remain closed today and tomorrow, Wiegand said.

On Thursday night management and shop stewards met "to assess the situation and to consider various options to minimise the effects of the closure of a section of the paint shop on our employees and customers".

Wiegand said VWSA should have a clearer picture by Wednesday to enable it to forecast when production could resume on a staggered basis.

NEWS IN BRIEF

(192) (5) 24/3/95

VW back on stream

PRODUCTION has resumed at the Uitenhage plant of Volkswagen SA following a fire in its paint shop on Thursday last week. The company laid off 1 000 workers for the week. The company lost R39m in lost production.

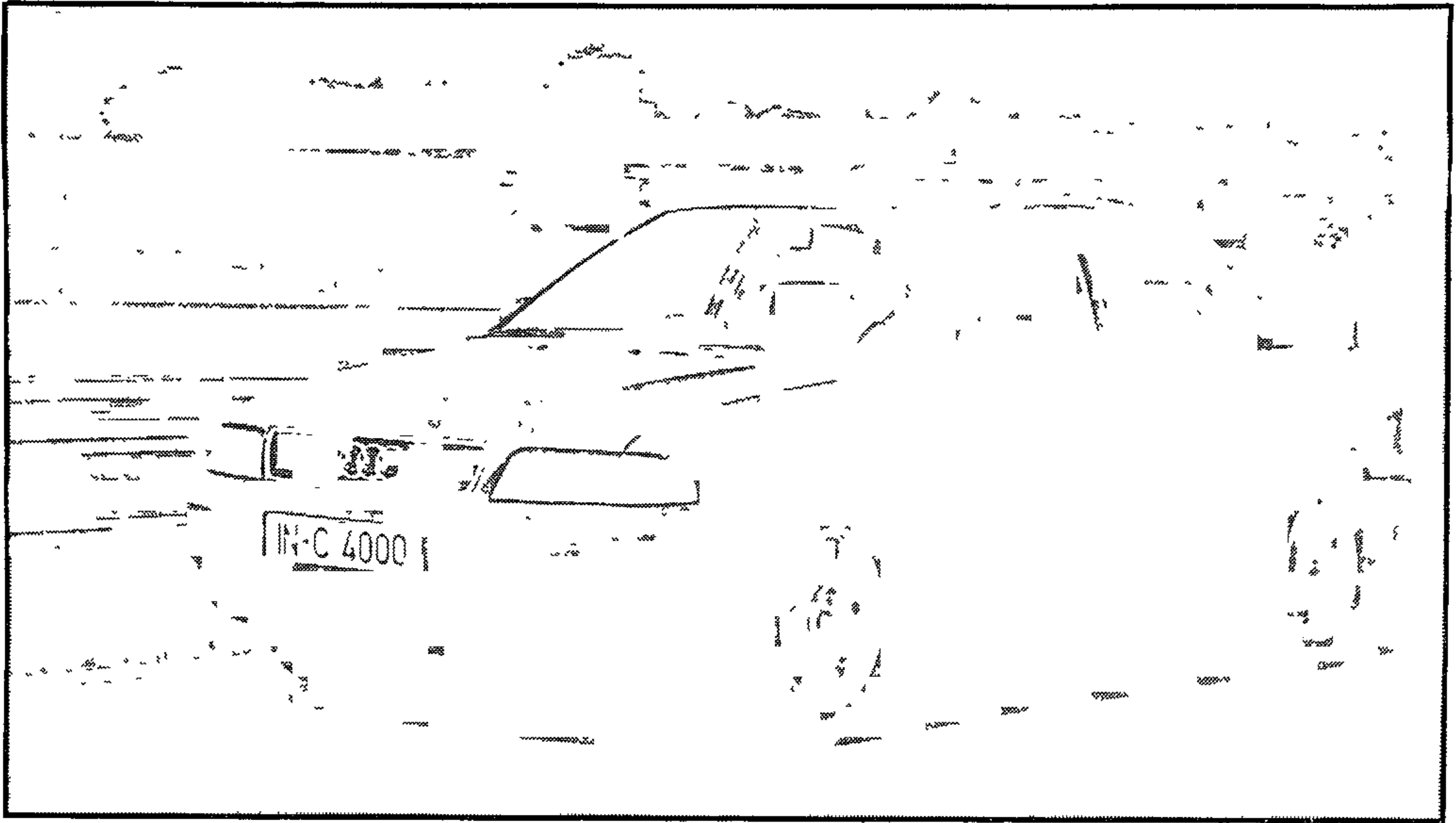

SIDELINED FOR SOUTH AFRICA Audi's new A4, whose right-hand drive version may be assembled for export in Uitenhage

SA just right for Audi exports

ST (BT) 26/3/95

(192)

By DON ROBERTSON

THE introduction of the new Audi A4 range in South Africa in August could pave the way for the company's Uitenhage plant to become the world supplier of right-hand drive Audis

A team of engineers and management staff from Audi's Ingolstadt headquarters in Germany is currently conducting a feasibility study at the plant

The SA A4 launch will also herald a "separation" of the marketing activities of Volkswagen and Audi, which will see dedicated Audi dealer networks established

This split is being developed in all of Audi's international markets and was initiated last Friday with the adoption of a new Audi logo at the German headquarters

Speaking in Ingolstadt this month, assistant to the technical director Peter Tropschuh said that of the 420 000 Audi cars expected to be produced by the Ingolstadt and Neckarsulm plants in Germany this year, between 15% and 20% will be right-hand drive vehicles

"It would make good sense to have all the tools and equipment in one place where we could install engines, gearboxes, chassis and even cigarette lighters, rather than have production from two plants in Germany," Dr Tropschuh said

"If the decision is taken to go ahead with global production in Uitenhage, it might be necessary to increase production to as many as

800 a day, especially with India offering huge potential for sales and Britain now becoming a major market"

Local Audi marketing manager, Johan de Nysschen confirmed that the A4 project would rely heavily on exports

The local A4 launch will be eagerly awaited by motorists and prices are expected to be more than competitive

"For instance, if the equivalent BMW is priced at a factor of 109, we will sell at 100," says Dr Tropschuh

In South Africa, 10 dedicated dealers will be set up by the end of the year to tie in with the A4 launch. An additional 60 joint dealerships will also be established each of which will have a separate en-

trance, showroom, service, sales and workshops facilities, requiring considerable investment

The marketing team at Midrand will be strengthened and a new dealer organisation will be formed

Two variants of the A4 will be introduced. The mid-range 1.8 litre four-cylinder, with the highly advanced and fuel efficient five-valve engine producing 92kW and the 2.8 litre, V6 producing 128kW

Both have a wealth of luxury features, including anti-lock braking systems with an electronic brake pressure distributor, airbags for driver and passenger, central locking, electric exterior mirrors, adjustable steering column, four head restraints, an electric immobiliser and a fully galvanized body

MOTORING

By DON ROBERTSON

AS the rising prices of new cars puts them beyond the reach of most motorists, sales of used vehicles increased to well over 800 000 last year, up from 560 000 only 12 years ago

But customers buying cars with a good mileage on the clock should be aware of the high cost of replacement parts which have risen at much the same rate as new car prices

The cost of maintaining a car in good working order during its life is not generally understood by most motorists

A parts survey conducted by Durban-based vehicle consultant Malcolm Kinsey, who provided the figures for the accompanying table, shows that although the price of parts, components and "crash items" are less expensive for cheaper cars, they do not necessarily bear a direct reflection on the original price of the vehicle

For instance, the price of a basket of parts for a BMW 320i costing R131 145 at the time of the survey, represents only 31.2% of the original price of the vehicle, while that of a Mazda 323 130 Sting priced at R40 436 is 87% and an Uno 1400 costing R46 880, 85.5%

The survey was conducted by using dealer prices of various parts including those which will have to be replaced because of wear or during service. Crash parts are also included as they could be expected to be replaced during the life of the vehicle. The price list was confirmed by individual manufacturers

Using this sample of spare parts, not all of which are listed, the City Golf Shuttle will be the cheapest to operate, with the basket costing R27 946, followed by the Toyota Venture at R29 021. These two vehicles may not have the most stylish looks, but the merit of uncomplicated body mouldings and plain functional head and tail light assemblies is evident when it

REPLACEMENT VALUES

CAR LIST PRICE	131 145	77 045	83 500	100 925	109 013	69 516	81 080	136 784	89 557	84 155	124 841	70 461	37723	46 880	40 436	81 963
All prices in VAT																
BMW 320i		Toyota Venture 2200	Hyundai Elantra 180 GLi	Toyota Camry 220 Si	Ford Telstar 2.0i GLi	Toyota Corolla 160 GLE	Nissan GXI 160	Merc C220	Honda 180i	Mazda 4 cyl	VW Jetta VR6	Opel Astra 160iS	VW Golf Shuttle	Flat Uno	Mazda Sting	Average Rating
PARTS BASKET	40 973	28 021	32 506	44 411	52 377	37 388	46 156	78 789	52 201	50 558	75 705	45 786	27 946	40 076	35 195	44 673
Fan belt	172	115	40	170	62	83	103	N/A	143	66	N/A	10	13	131	23	74
Brake pads - front	333	391	190	226	523	190	141	262	163	539	419	148	142	182	201	258
Brake shoes/pads - rear	331	182	207	174	412	288	258	116	158	412	414	449	97	322	100	260
Cylinder head complete	4 726	1 678	1 819	4 566	3 396	3 663	3 661	9 528	7 444	4 088	8 747	4 015	4 170	2 413	1 919	4 341
Sub-assembly	7 287	2 815	5 972	7 993	13 529	5 185	13 402	24 099	11 961	9 242	26 089	9 770	3 517	13 575	6 926	10 270
Manual gearbox	10 241	8 472	9 350	10 793	9 617	12 108	11 220	16 543	9 813	11 157	12 675	13 985	10 533	9 439	10 554	10 832
Clutch plate	515	542	314	387	371	388	220	451	564	353	1 049	628	187	937	722	500
Pressure plate	503	490	224	477	276	405	395	1 002	744	276	780	N/A	213	N/A	N/A	364
R/R shock absorber	128	162	305	490	392	486	292	778	756	392	176	192	142	172	150	336
R/R shock absorber	411	177	376	523	292	387	313	778	756	292	239	265	222	247	292	372
Rear silencer	841	365	195	523	816	233	670	1 002	599	457	1 719	167	438	224	312	622
Water pump	294	291	254	542	463	425	298	1 187	536	468	671	354	291	547	200	452
Starter motor	916	1 235	1 003	1 315	792	1 319	720	1 054	746	1 603	894	2 831	654	1 581	936	1 254
Alternator	772	1 146	1 382	1 335	1 555	1 399	1 036	4 014	4 845	2 596	4 696	2 619	654	933	1 276	1 899
Ignition coil	339	392	478	350	455	428	1 062	408	425	455	1 250	1 036	216	227	231	487
Windscreen	872	1 361	1 250	1 989	2 361	1 085	1 208	1 229	830	1 134	1 443	996	538	871	882	1 239
Front bumper	1 366	362	1 563	822	1 510	456	929	1 023	431	1 510	1 336	491	376	733	678	869
Rear bumper	1 295	860	755	1 217	1 485	1 002	726	1 810	1 313	1 485	1 284	545	711	737	1 067	1 056
Bonnet	450	457	428	614	1 103	265	887	925	1 051	1 103	789	370	416	298	692	640
R/F fender	651	346	283	497	811	593	561	447	1 115	812	683	388	157	275	1 066	583
R/R tail light assembly	830	140	416	717	2 173	675	265	1 509	944	2 173	576	497	108	428	824	797
R/F headlight assembly	2 054	505	1 750	689	2 047	464	1 094	1 265	472	2 047	1 303	1 366	430	724	1 252	1 125
Rear bumper	1 471	262	725	1 344	1 252	993	1 770	1 207	1 656	1 252	2 881	1 709	1 030	740	1 549	1 291
R/R fender	1 062	1 324	692	1 875	1 584	1 338	1 830	1 267	1 156	1 584	1 050	565	1 031	1 990	482	1 214
Boot lid	32	25	22	30	40	30	59	57	25	40	107	15	26	26	29	35
Oil filter	55	58	84	83	172	70	42	124	146	89	117	41	28	29	45	77
Air filter	140	14	62	115	148	141	71	149	229	145	70	112	7	9	13	93
Fuel filter	29	24	21	31	52	31	26	57	33	35	202	21	28	20	19	36
Set spark plugs	Chain 246	67	336	314	408	239	85	240	213	265	160	91	45	178	257	78
Gain belt	170	63	45	171	67	28	47	48	45	67	165	21	13	21	35	69
Pair wiper blades	31.2	36.2	38.9	44.0	48.0	53.7	56.9	57.6	58.2	60.0	60.6	64.9	74.0	85.5	87.0	54.5

Graphic: FIONA KRISCH

(192) ST(BT)26/3/95

Cars gaining on the sum of their parts

Front bumpers ranged from R362 for a Venture to R1 563 for the Hyundai Elantra, while the cheapest bonnet was on the Opel Astra 160iS costing only R345. The highest was again the Telstar, at R1 485.

A sub-assembly for a Venture will cost only R2 815, while that for a Volkswagen VR6 is R26 089. The price of the car appears to have no bearing on the cost of replacement parts. For instance, a manual gearbox for a BMW 320i costs R10 241, while that for a Mazda Sting is R10 554.

While the cost of the parts basket for the BMW is the cheapest in relation to its price, the company has also initiated a five-year maintenance plan, built into the price of the car. This will cover all maintenance until the end of the century and is transferred to the new owner when the car is sold.

Rear silencers now appear to be less durable than in years gone by, perhaps because of chemicals added to petrol. The cheapest is for the Astra at R167, while the most expensive — a stainless steel unit — is for the Toyota Camry at R1 256.

"It took well over two weeks to collect this data and another to make corrections," says Mr Kinsey. "A few dealerships were tardy in supplying prices and had I been a car owner in trouble, I would have been extremely annoyed in some instances. The combined Ford-Mazda dealerships certainly talked vastly different prices — written quotes varying between dealers by as much as R11 734 for a sub-assembly and by R1 227 for a Telstar-

Mazda windscreen "It certainly would be advisable to get a second opinion before buying parts if this is the norm," says Mr Kinsey.

Nissan dealers are not yet all linked to their central computer network, which meant that some prices were not always the latest ones available. Examples were wiper blades and rear discs which are now sourced locally and which are substantially lower in price, says Mr Kinsey.

Nissan is introducing a national computer pricing system which will alleviate this problem. "The attitude of manufacturers and dealers was one of co-operation and this survey is not intended to deliver any criticism, but rather to make motorists aware of the costs involved," says Mr Kinsey.

Bosal's orders up

(192) CT(BR) 29/3/95

By ROY COKAYNE

PRETORIA BUSINESS EDITOR

Bosal Africa's tube division is expanding to meet the increased demand for cold-rolled steel tube and related products — particularly from original equipment manufacturers (OEMs) in the automotive industry.

Bosal Afrika's managing director, Harry Coetzee, said yesterday that demand from OEMs at the end of last year and early this year was 25 percent higher than expected.

"On the commercial side, demand is more than 10 percent higher. It is still early days, but the signs are extremely encouraging," he said.

Bosal Tube Division's plant director, Rob Sweetnam, said demand for the company's products had increased by about 12 per-

cent during the past year. The company had installed an additional perforation press to cope with increased demand for perforated tubing from the automotive industry.

Demand had increased for tubing for automotive components, and for use in school furniture.

"We are also investing in another mill which will extend our capabilities into the thin-wall tubing sector. This will cater for the local irrigation market," he said.

Sweetnam confirmed that the tube division would expand into the hot-rolled tube market, a major diversification for the company.

Besides local growth, Sweetnam said Bosal continued to export cold-rolled tube to the furniture industries in several countries. Coetzee said Bosal had recently clinched solid orders from the Far East.



A prototype of an electrically powered vehicle on show at a conference in Midrand this week.

Picture: NICKY DE BLOIS

Kruger grave vandals hunted

KATHRYN STRACHAN

POLICE are looking for three white men who may have been involved in the beheading of Paul Kruger's graveside effigy in Pretoria.

The head of the bust was found in pieces around the cracked tombstone on Tuesday morning.

Lt-Col Andrew Lesch said a witness had seen three men, thought to be in their 20s, playing in the graveyard on Monday afternoon. "The one had a list and was calling out names, while the other two ran to the graves shouting they had found it," he said.

However, it was not known if they were connected to the vandalism.

The damage, estimated at R60 000, is believed to be repairable.

Sapa reports right-wing political parties reacted angrily to the incident. CP leader Ferdi Hartzenberg said the vandals responsible had followed the example of the government's "intensive and sustained campaign" against Afrikaners.

Afrikaner Volksfront general secretary Harry Mocke linked the event to the removal of former prime minister Hendrik Verwoerd's statue in Bloemfontein earlier this year.

Eskom's concept of electric vehicle sparks wide interest

(192) 6030/195
THEO RAWANA

THE introduction of an electrically powered vehicle was enthusiastically received by SA company representatives when Eskom laid out the concept it had initiated at a two-day conference in Midrand this week.

The conference was held to interest car manufacturers, the transport and trucking industry, fleet owners, environmentalists and members of the health industry in the environmentally friendly, cost-effective electric vehicle.

Carel Snyman, head of Eskom's electric vehicle programme to facilitate the introduction of emission-free vehicles in SA, told the delegates that countries such as France, the UK, Germany, Italy, Japan, Korea and Scandinavia had already introduced electric vehicles.

Snyman said Eskom was looking for support, and carmakers such as Nissan, BMW and Mercedes-Benz SA had shown interest.

"They have the experience and we would like to work with them, but they have parent companies overseas and have to get word from there."

Snyman said: "Electric vehicles promise to effect all sectors and people in all walks of life, and it is critically important that we enter this immensely challenging field well armed with information and able to address people's concerns."

Among the benefits listed by Snyman were high energy efficiency, a long reliable service, a car that required little or no maintenance, reduced costs, no emissions, a quieter operation, a car which was not vulnerable to world oil price irregularities and, best of all, no cold morning starting problems.

Fuel cost savings were put at R25 000 over 150 000km.

Snyman said many cities regarded exhaust gases produced by engines as the greatest single contributor to atmospheric pollution.

The system would work on batteries that could be charged at central points. In the case of taxis ranks would be supplied with recharging plants, Snyman said.

Delayed delivery criticised
two years of consultation
with contributed 15% of

Govt closes vehicle imports loophole

STAV 31/3/95

■ PRETORIA
CORRESPONDENT

~~(SHE)~~ (192)
The Government has closed the loophole that allowed motor vehicles to be imported into the Southern African Customs Union under full rebate without any major investment being made in plant or employment

It is likely to severely affect many motor vehicle importers, including the Botswana-based Hyundai company, which introduced the vehicles of Hyundai Motor Company of Korea into the local market last year

Spokesmen for Hyundai in SA were unavailable for comment.

The amendments

might prompt importers of semi-knocked-down vehicles to import fully built-up vehicles instead, particularly as import duties were reduced from 100% to 80% and the 15% surcharge applicable to motor cars was abolished in September last year

This meant the duty on imported passenger cars was reduced from 115% to an 80% customs duty

The amendments will be implemented from tomorrow

■ Interested parties wishing to obtain details about applying for further exemption from the revised rebate provision should contact N Lambrecht at Pretoria 310-9766 or G B Fourie at Pretoria 310-9768

Fast-vanishing differences between competing makes of car mean style and performance will play a diminishing role in buyers' future decisions, suggests Opel MD David Herman

Automotive and manufacturing technology have advanced to the point where "there are no badly built cars," says Herman — a claim certain to provoke reaction from disgruntled motorists worldwide

Nevertheless, he says standards generally have risen to a degree where traditional competitive advantages have been eroded, and manufacturers and dealers must find

new ways to differentiate their products from those of rivals

"Cost, quality and responsiveness are now the basic price of admission for a manufacturer," Herman told the SA National Automobile Dealers Association (Nada) convention at Sun City "Customers are beginning to take these things for granted, and expect to get them as 'givens' for the money they pay"

Companies and dealers that try to shift stock by offering ludicrous price cuts and finance deals are missing the

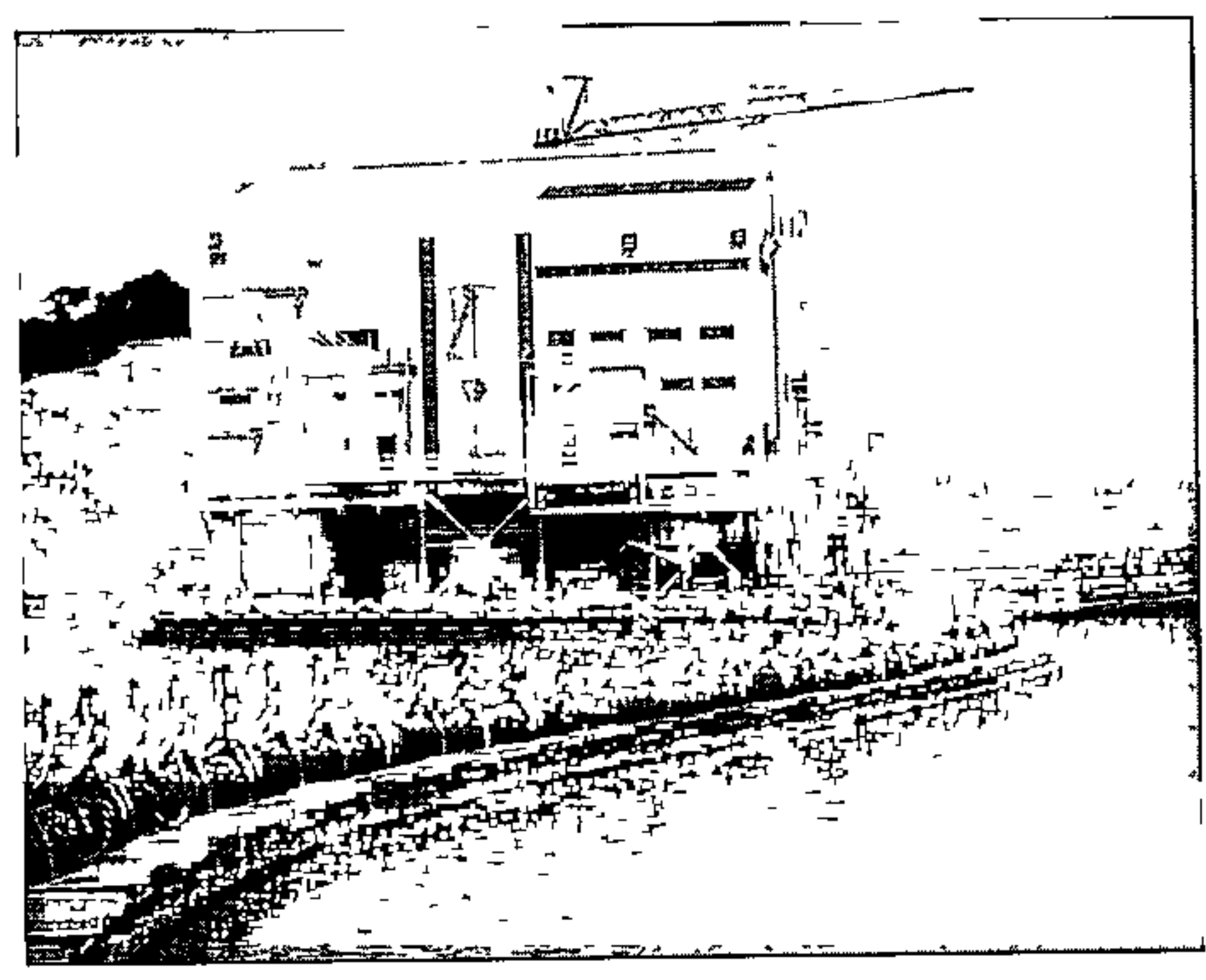

Richards Bay Minerals *fostering small business*

BUSINESS

point, he says All they are doing is damaging their own profitability "We're throwing money at the problem and there's no future in it"

The answer, says Herman, is to differentiate and build brand image on outstanding ownership experience and service Retaining custom, and increasing it through word of mouth, is the most effective way of doing business

"What we've forgotten in our urgency to make (new deals) is that it costs at least five times as much to win a new customer as it does to keep an existing one" ■

Midas reports increase

(192) STW 5/4/95
Motor parts and accessories group Midas yesterday reported a 30% increase in earnings per share to 83,7c for the year to February 28.

Operating profit for the year increased by 52% to R17,7-million on the back of a 37% increase in turnover to R345,7-million and improved operating efficiencies.

Chief executive Sarel de Vos said the acquisi-

tion of 100% of motor spares wholesaler and retailer, Quay Buffalo, contributed positively to the group's results and raised their national market share

Attributable profits before extraordinary items improved by 35% to R9,6-million and a final dividend of 13c per share was declared, bringing the total for the year to 21c per share — Sapa.

SA car prices shock

(192) ARU 5/4/95
BUYERS are paying up to R5 billion a year more for their cars than they should be, a study of the competitiveness of South African firms has found.

The major study by independent consulting group Monitor, commissioned by the National Economic Forum, found that the cost of assembling a vehicle in South Africa — not including components — was 72 percent higher than in Germany or the United States.

"The price premium for vehicles currently costs consumers R4 billion to R5 billion each year, approximately equal to the RDP or national housing budget"

VW in aggressive new pricing policy

(192) Star 6/4/95

■ OWN CORRESPONDENT

Volkswagen South Africa has announced a new range and aggressive new pricing strategy for its Citi Golf, enabling it to offer consumers the most affordable passenger vehicle on the market

It has introduced a 1,3 litre 5-door Citi Chico at a price of R33 950

VWSA managing director Dr Heinrich Holtmann said the introduction of the Chico and the restructuring of the Citi Golf range were the first steps in VWSA's efforts to once again make motoring affordable for the average South African while countering the effects of lower import tariffs on motor vehicles.

VWSA general manager marketing communications Bill Stephens said the price of the Citi Chico was 10% below the price of the previous bottom-of-the-range model 1,3 Shuttle and 9,8% lower than the current most affordable car on the market.

He also announced the

■ Introduction of a 1,6

Shuttle 5-speed model at an extremely competitive price of R41 300 without doubt the most affordable 1600 five-door 5-speed on the market in SA.

■ Introduction of a 1,6 litre edition with many features at a price of R48 162

■ Discontinuation of the 1,8 litre Sport and retention of the 1800 fuel-injected CTi at its existing price of R42 600, about R5 000 less than the current price.

■ Marketing of the half-ton pick-up, the Caddy, at R42 600 — R5 000 less than the current price

The pricing initiative is aimed at maintaining Citi Golf's popularity at the bottom end of the market, where the battle for more affordable motoring is expected to take place.

Stephens said VWSA anticipated its volumes would continue to escalate through April and May and settle at a level enabling VWSA to achieve in excess of 11 percent of the South African passenger car market with the Citi Golf brand alone.

NEWS IN BRIEF

B06/4/95 (192)
VW cuts car price

VOLKSWAGEN of SA (VWSA) has dropped the price of its bottom of the range Citi Golf model by more than 10% to make it the cheapest passenger car on the market

VWSA marketing communications GM Bill Stevens said yesterday the new 1,3 Chico Citi Golf model would cost R33 950, 11% below the price of the previous bottom of the range 1,3 Shuttle, which cost R37 723

Surge in new vehicle sales continues

29 1992
CNR 6/4/95

■ OWN CORRESPONDENT

The strong upward spiral in new vehicle sales continued last month, providing further evidence the economy is on a strong growth path.

The star performer, according to figures released by the National Association of Automobile Manufacturers of South Africa (Naamsa), was the new light commercial vehicles, bakkies and minibuses sector, where sales rose 29,9% to 12 526 units last month, the highest light commercial vehicle sales on record for the month of March.

It represented an improvement of 2 886 units on the 9 640 new light commercial vehicle sales recorded in March 1994.

But Naamsa figures also showed that new car sales which surged to their highest February sales level in 11 years were 743 units or 3,7% higher at 21 116 unit sales last month.

However, the year-on-year growth figures were far more impressive with

sales last month 20% or 3 525 units higher than March last year.

Motor industry analyst, economist and Econometrix (Pty) Ltd director Tony Twine said overall sales of commercial vehicles were a reflection of the increase in gross domestic fixed investment especially since May and that the economy was getting back to work after several years of recession and periods of low confidence.

Twine said the commercial vehicle sales figures were extremely encouraging because they were indicative of a renewal of part of the capital stock in the economy and confidence in the long-term growth prospects of the economy.

But Twine said the good performance of the commercial vehicle market did not mean the passenger vehicle market had performed poorly.

The passenger vehicle sector had merely been totally overshadowed by the commercial vehicle sector, he said.

Twine said the season-

ally adjusted 60 000 passenger vehicle units sales in the first quarter of this year were a reflection of a bit of pent-up demand from last year's motor industry strike which had been amplified by high demand for vehicles for the car rental industry.

Imperial Car Rental managing director Carol Scott, who is also president of SA Vehicle Renting & Leasing Association confirmed car rental companies were accounting for the major portion of the increase in car sales.

She confirmed passenger vehicle sales to the car rental industry in February this year were 20% higher than the same month a year ago.

Scott said acquisitions by Imperial had accounted for 9% — about 1 500 to 1 600 units of total passenger vehicle sales in February and it had acquired another 1 039 cars last month. She said Imperial intended to buy about 7 000 passenger vehicles, involving about R487-million in capital expenditure.

Nissan in R550m expansion

CT(BR)7/4/95 (192)

Aim is to speed up production, improve productivity and meet world quality standards at Rosslyn plant

By Roy Cokayne

PRETORIA BUSINESS EDITOR

Nissan South Africa is to spend R550 million on its manufacturing complex at Rosslyn, outside Pretoria

This includes current capital expenditure of R170 million and is aimed at pushing up production and improving productivity and product quality

Nissan's director of manufacturing engineering, Tony Godycka, said R170 million would be spent during the next 18 months, and nearly R400 million more over the following three financial years

The programme involved

- A new phosphate and E-Coat anti-corrosion facility costing R81 million. Its first phase had already been installed at a cost of some R28,2 million,

- A R26 million autospray facility in Nissan's paint shop, together with extensions to the ultra-clean area in the paint shop at a cost of R10 million more,

- Two 50-ton door presses for the Nissan Sentra and Sabre, costing about R8 million, which were currently being installed,

- A new R7 million automated welding jig, and

- A R995 000 wetland and dam project aimed at preventing pollution and beautifying the area around the Rosslyn plant.

The remaining R400 million

would be spent on new models and facilities

The director of the Nissan Truck Plant, Errol Todd, said the new anti-corrosion dip facility would ensure that the cabs of all medium and heavy commercial vehicles were protected to world standards against rust and corrosion

Nissan SA Manufacturing's managing director, Charles Wiggill, said the new autospray facility not only saved money but also greatly improved paint quality

This was only the beginning of the process of working towards

getting a licence for world-class manufacturing "Using this new technology locally puts us firmly on track", he said

The new door presses would begin working early next year, and were expected to cut costs by about 50 percent

The new welding jig would result in high-quality Nissan hard-body chassis leaving the assembly line "We now complete a chassis every six minutes, a vast improvement in productivity over the previous manual system", he said

Nissan to spend R550-m at Rosslyn

(192)

■ BY ROY COKAYNE

Nissan South Africa has embarked on a R550-million capital expenditure programme at its manufacturing complex in Rosslyn near Pretoria.

It is already in the midst of an overall capital expenditure programme totalling more than R170-million which is designed to increase production and further improve the quality of its vehicles and assembly line productivity.

Nissan director Manufacturing engineering Tony Godycki said this R170-million would be spent during current financial year to 18 months with another about R400-million spent over the next three financial years.

STAN 7/4/95
The capital expenditure programme involved the commissioning of a new phosphate and E-Coat anti-corrosion facility; a R26-million Autospray facility, two 50-ton door presses for the Nissan Sentra and Sabre; a new R7-million highly automated welding jig and a R995 000 wetland and dam project aimed at the prevention of pollution and beautification of the environment surrounding Nissan's assembly plant at Rosslyn.

Car prices may not soar after closure of customs loophole

CT (BR) 6/4/95 (192)

By ROY COKAYNE

PRETORIA BUSINESS EDITOR

The effect on vehicle prices in South Africa of the new regulations governing motor vehicle assembly in the Customs Union is an open question, according to the Board on Tariffs and Trade.

The new regulations, which were effective from April 1, closed the loophole that allowed motor vehicles to be imported into the Southern African Customs Union under full rebate of customs without any major investment being made in plant or employment.

The change in the regulations is expected to affect the pricing of semi-knocked-down (SKD) vehicles drastically.

But the board's chief director of investigations, Alwyn Kraamwinkel, said the possible cost-raising effect of the regulations on, for example, a vehicle selling in South Africa for R60 000 before the regulations changed, was an open question.

He said the cost-raising effects of the new regulations should be judged in the light that even though the 75 percent import duty was circumvented, the retail price did not seem to reflect this saving.

In theory, the cost raising effect would be 75 percent of the free-on-board value of these vehicles, he said.

Kraamwinkel said if importers now

decided to import vehicles in fully built-up form, the duty payable would be 75 percent of the free-on-board value in the country of origin (before shipping and other charges) which, of course, was significantly lower than the local retail price.

A major vehicle importer affected by the new regulations is Hyundai Motor Distributors, which has obtained a two-year exemption to allow it to adapt its Botswana facilities to comply with the new regulations. It says the dispensation means the regulations will not affect the pricing of Hyundai products.

The new regulations were introduced because the importation of motor vehicles into the Southern African Custom Union in a form that required only simple, relatively low value-added assembly — but with full rebate of customs duty — had reached alarming proportions.

Kraamwinkel said the number of motor vehicle assemblers registered at the Commissioner of Customs and Excise under Phase VI of the local content programme had jumped in recent times to more than 50.

He added that because registration under Phase VI allowed assemblers to use a rebate provision in the regulations, virtually all the recent arrivals in this field had followed the SKD route of manufacture.

SA set on road to growth as car sales surge

(192)
CT(BR) 6/4/95

Naamsa reports an increase of more than 27 percent in purchases of new vehicles, with light commercials showing best growth

By Roy Cokayne
PRETORIA BUSINESS EDITOR

New car sales soared by 22 percent in the first quarter of this year, while total new vehicle sales were up by 27,2 percent, according to the National Association of Automobile Manufacturers of South Africa (Naamsa)

This booming recovery in the motor industry is further evidence of the general economic upturn in South Africa

Naamsa said new car sales for January to March were 58 154 against 47 629 in the first quarter of 1994. Sales of light commercial vehicles (LCVs) surged over the same period by 36,3 percent from 24 322 to 33 161.

Some consolidation in the industry's sales performance could be expected, but generally South Africa's new vehicle manufacturing and associated industries should expect an excellent year.

Motor industry analyst, economist and Econometrix director Tony Twine said overall sales of commercial vehicles were a reflection of the increase in gross domestic fixed investment — especially since May last year — and that the economy was getting back to work after several years of recession.

Twine said the commercial vehicle sales figures were extremely encouraging because they reflected

a renewal of part of the capital stock in the economy and confidence in its long-term growth prospects.

The passenger vehicle market had shown a corresponding boom, also an encouraging sign for the economy.

He said sales of passenger vehicles were a good indicator of economic activity. When the economy was good, sales were extremely good, but when the economy was bad, sales were extremely bad.

The managing director of Imperial Car Rental, Carol Scott, said car rental companies accounted for most of the increase in passenger vehicle sales.

She said passenger vehicle sales to the car rental industry this February were 20 percent higher than in the same month a year ago.

Scott said acquisitions by Imperial had accounted for 9 percent — about 1 500 to 1 600 units — of total passenger vehicle sales in February, and it had bought another 1 030 passenger vehicles in March.

Imperial intended buying about 7 000 passenger vehicles this year, involving capital expenditure of R487 million.

She said the car rental industry was one of the first to feel the upswing in the economy, largely because of a considerable increase in international tourism.



AFFORDABLE Bill Stevens, Volkswagen's general manager of marketing communications, rolls out the red carpet for the new Golf range, which starts at R33 950.

PHOTO: JOHN WOODROOF

VW launches the 'cheapest car'

(192)

By Roy Cokayne

Volkswagen South Africa has announced a new range and pricing strategy for its Citi Golf.

The introduction of a new 1,3-litre 5-door Citi Chico at R33 950 was the first step in VW's efforts to make motoring affordable again.

for the average South African, said Heinrich Holtmann, the company's managing director.

The new pricing strategy would also counter the effects of lower import tariffs on motor vehicles, Holtmann said.

Bill Stephens, general manager of marketing communications, said

the price of the Citi Chico was 10 percent below that of the previous bottom of the range model, the 1,3 Shuttle — and 9,8 percent lower than the most affordable car on the market.

He said the new prices were part of a long-term price strategy for the Citi Golf range.

CT(BR) 6/4/95

NEW VEHICLE SALES

	March 95	February 95	March 94
New passenger cars	21 116	20 373	17 591
Light commercial vehicles	12 526	11 075	9 640
Medium commercial vehicles	351	297	326
Heavy commercial vehicles	691	573	513
TOTAL	34 684	32 318	28 070

Nissan to spend R550-m at Rosslyn

(192)
■ BY ROY COKAYNE

Nissan South Africa has embarked on a R550-million capital expenditure programme at its manufacturing complex in Rosslyn near Pretoria.

It is already in the midst of an overall capital expenditure programme totalling more than R170-million which is designed to increase production and further improve the quality of its vehicles and assembly line productivity.

Nissan director Manufacturing engineering Tony Godycki said this R170-million would be spent during current financial year to 18 months with another about R400-million spent over the next three financial years.

SKW 7/4/95
The capital expenditure programme involved the commissioning of a new phosphate and E-Coat anti-corrosion facility; a R26-million Autospray facility; two 50-ton door presses for the Nissan Sentra and Sabre, a new R7-million highly automated welding jig and a R995 000 wetland and dam project aimed at the prevention of pollution and beautification of the environment surrounding Nissan's assembly plant at Rosslyn.

CHEAPO CHICO

(192)

FM 7/4/95

Volkswagen has thrown down the price gauntlet to competitors with the announcement of a new CitiGolf nearly R3 000 cheaper than anything else on the SA new-car market

At a fraction under R34 000, the new Citi Chico will be priced well below the current budget leader, the baseline Fiat Uno Fire, which sells for R36 690 — and nearly R4 000 less than VW's bottom-of-the-range CitiGolf Shuttle

VW hopes that, at a time when manufacturers and motorists alike are lamenting the lack of affordable new cars at the bottom entry-level end of the

market, the 1300cc, four-door Chico will attract cash-strapped, budget-conscious customers — both first-time buyers and those seeking a second family car

Meanwhile, at the opposite end of the market, Land-Rover is already planning increased capacity at its new Rosslyn, Pretoria, assembly plant

MD Piet Rademeyer says the plant — officially opened by Queen Elizabeth II last month — was built to assemble up to 2 500 Land-Rover Defenders a year

“However, strength of demand is such that we are already looking to increase assembly capacity,” he says

MOTOR INDUSTRY

Unwilling convert

EM 7/4/95

Korean car-maker Hyundai has until the end of June to provide SA's Board on Tariffs & Trade (BTT) with a detailed business plan explaining how it intends to convert its existing limited-assembly operation in Botswana, into a full-scale car manufacturing plant. If not, it risks losing its temporary right to benefit from preferential import duties.

But local Hyundai MD Nissim Franco insists SA authorities have no jurisdiction over his company, which is answerable only to the Botswana government.

Hyundai is the main target of a BTT decision to close a legislative loophole allowing imports of partially assembled cars to escape punitive import tariffs. Fully built imports attract a 75% penalty.

Hyundai imports cars in partially-assembled form to Botswana, where it completes assembly before releasing them on to the SA market.

Under rules in force until last week, lack of clarity on what constitutes local assembly meant Hyundai qualified to avoid the 75% duty burden.

The small-scale operation also meant Hyundai's overheads were much lower than those of its competitors — a fact reflected in the highly competitive retail prices of Hyundai cars.

Long-standing SA manufacturers argued this was unfair. They had been forced to spend billions of rand on full-scale assembly operations.

Why should a newcomer be allowed to circumvent the rules? If one did, others would follow, and thousands of jobs could be lost in the vehicle assembly and components industries.

Hyundai argued that the consumer was more important than maintaining profit margins of inefficient companies. Everyone agreed industry programmes had contributed to high prices, so why should Hyundai be forced to make the same mistake?

The BTT, however, has come down on the side of the majority. From April 1, vehicles imported into the region in semi-

BUSINESS

assembled form attract the same duties as fully built imports.

Companies with existing semi-assembly commitments may apply for temporary permits allowing them to continue enjoying existing benefits until June 30. The following day, July 1, a new Motor Industry Development Plan (MIDP) is scheduled to come into force. From that date, only Hyundai and small-scale importers the BTT deems not to be "established" manufacturers, may apply for a further two-year exemption.

But there are strings attached. To qualify, Hyundai and the others must explain to the BTT

- How, within two years, they will conform to the new full-assembly requirements and the new motor industry plan,
- Capital investment details and the company's capital expenditure plan, in six-monthly stages,
- A two-year record of monthly vehicle sales and turnover,
- Detailed specifications of vehicles imported and sold previously, and of those to be manufactured in future, and
- Terms of licensing agreements under which vehicles will be manufactured.

If the application is approved, the BTT will determine a production quota for Hyundai for the period of the exemption, based on past performance. The BTT will also check every six months that the company is keeping to its timetable for changeover to full manufacture.

If Hyundai's plan isn't ready by June 30, it "will immediately have to conform to all existing customs and excise rules."

So what are Hyundai's options? There are suggestions the company will appeal against the BTT decision. MD Franco says the SA regulations are not enforceable against Hyundai until promulgated in Botswana. "Only Botswana has jurisdiction over industry in that country."

He adds that Hyundai has consistently operated within the rules and that by making it liable to higher duties, SA's

stance is contrary to Gatt.

If appeals fail the obvious solution, if Hyundai wants to build on its success so far, is to convert its existing plant to a full-assembly operation. That, however, could cost hundreds of millions of rand. Even if the Botswana government offers financial inducements, Hyundai's Korean parent will think carefully before embarking on such large-scale expenditure.

The same financial obstacle exists if Hyundai decides to shift its production base to SA. Another alternative is to persuade an existing SA manufacturer with spare capacity, to build Hyundais under licence. That, too, would avoid import duties and remove the requirement for major expenditure.

Hyundai doesn't publish detailed figures, but it is estimated it sells over 500 cars a month — and rising. In all, including other companies, about 5 500 cars were imported in semi-built form and sold in SA last year. Had the BTT not intervened, it has been estimated the 1995 figure would have been about 12 000.

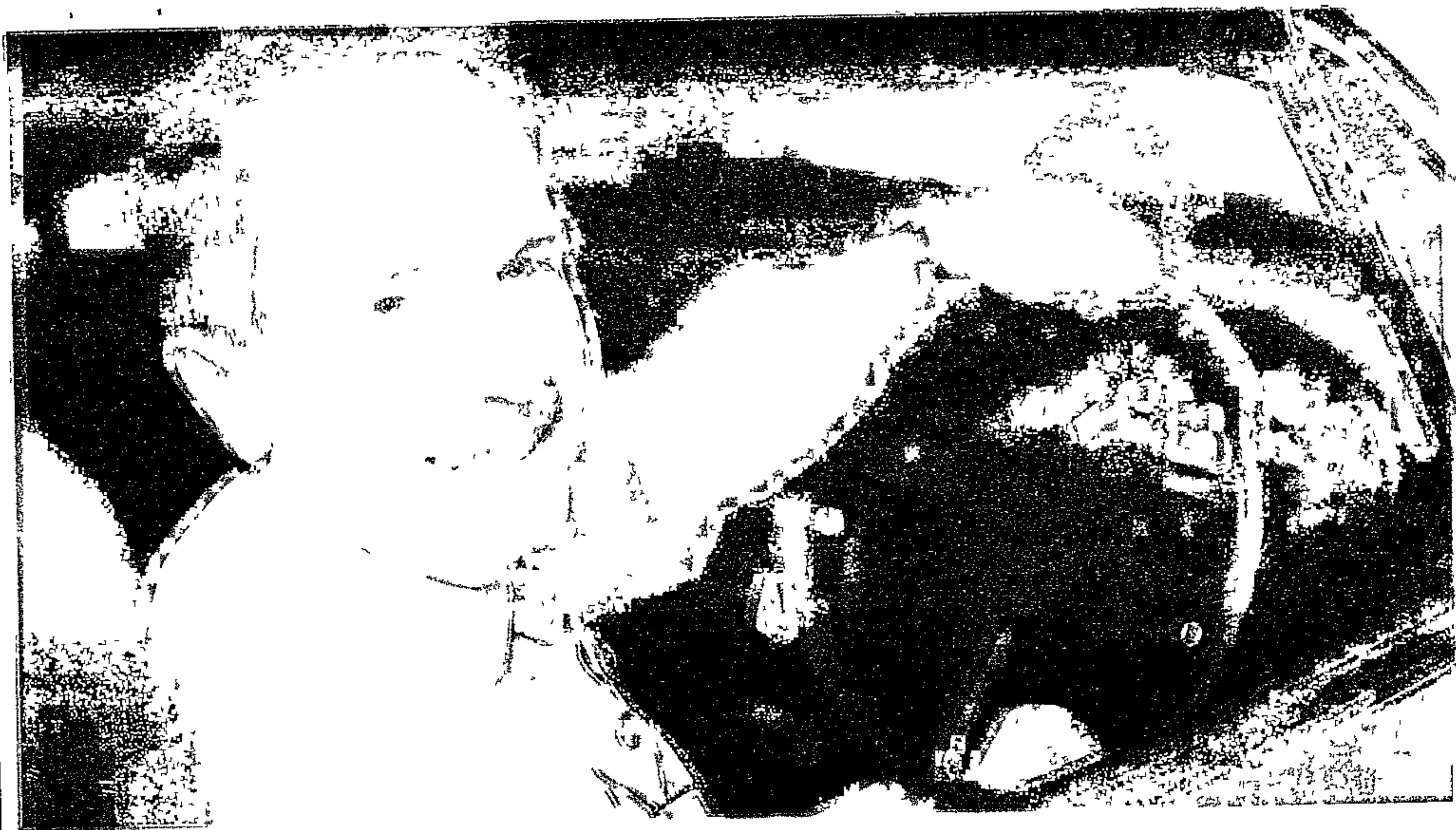

IN THE DRIVER'S SEAT . . Ron Shires, the new managing director of ADE, behind the wheel of the Austin Healey sports car he is building at home
 Picture **AMBROSE PETERS**

ADE export boom in the pipeline

192
 ST9/4/95

ADE, the engineering and manufacturing group pivotal to the future of the Atlantis community, is set to become a worldwide exporter as overseas sales rocket, says its new managing director, Ron Shires.

"Our exports are set to grow dramatically over the next three years, and our vision is to become a major Western Cape exporter on a worldwide basis," Mr Shires said this week.

The Atlantis group was already exporting R90-million worth of manufactured products and this was set to grow rapidly

"Our plan is to grow the business rapidly from exports. Exports account for about 20 percent of our total revenue now, but over the next three years we would

like to see that move above 40 percent

"Long term, we would like to see the bulk of ADE's earnings coming from selling our goods around the world"

Those goods are major engine components and automotive castings, like crank shafts, cylinder blocks, cylinder heads, camshafts and connecting rods

The key to ADE's exports is its licence to assemble and manufacture Mercedes' and Perkins' components and engines in this country

"People tend to knock licence agreements but the other side of a licence agreement can be very beneficial. When we went overseas knock-

ing on doors we had already established credentials as far as quality and logistics are concerned with two very big international names," says Mr Shires

Original exports were to Mercedes and Perkins plants, but from there the business ballooned

The company also benefited from being awarded the ISO 9001 international standard on quality

The company already exports to Britain, Germany, South America and South Korea

"The potential to increase these exports, particularly to South Korea, is a very exciting and challenging prospect," Mr Shires said

"South African manufacturers need to export, but they also need a sound domestic base"

ADE's bright future prospects will be well received by the Atlantis community as it is the major employer in the area

The company was formed during the apartheid era to manufacture diesel engines for trucks and has had to fight for survival in the post-apartheid period

"The significance of ADE is that it exists at all, let alone the fact that it generates good earnings and profits to its major shareholder, IDC, and employs a great many people in Atlantis," Mr Shires said

UK car maker plans SA plant

Business Day Reporter

OFFERS of joint ventures with SA partners this week include one from Australia for the production of light aircraft, and a proposal from the UK for the establishment of a motor plant.

The offers are made through the Trade Department's Industrial Development and Investment Centre. They are.

AUSTRALIA: An Australian company is offering its technology for the production of light aircraft which can be used for training and recreational flying

The training of staff, quality control systems and initial production supervision will be provided. *BD 10/4/95*

BRITAIN: A company wishes to transfer its technology for the setting up of a turn-key operation in SA to manufacture "unique, low-cost, completely knocked down motor vehicles"

The company is confident that a 100% local content of materials used for the production of this vehicle is possible. It says the plant could be set up and oper-

(192) ~~192~~
JOINT VENTURES

ational within six months

GERMANY: A German company wishes to enter into a joint venture for the production of dust extraction tables or special furniture machinery. The SA partner should preferably be involved in furniture or furniture equipment production

UNITED STATES: A US-based company is seeking a joint venture partner to set up wind and solar energy power plants

Different options on the installation, finance, training, and other matters of concern to the SA partner can be negotiated, the company says

Further information on the inquiries can be obtained from Pheko Weeto (012) 310-9800 or Helen Dawson (012) 310-9789 at the Industrial Development and Investment Centre. The fax number is (012) 322-4523

Foreign trucks make inroads into SA market

(192) CT (BR) 10/4/95

BY AUDREY D'ANGELO

TRANSPORT EDITOR

South African truck manufacturers will have to fight harder to stay in business in the face of aggressive foreign competition, warns Richard Proctor-Sims, editor of SA Transport magazine and organiser of its Truck of the Year competition.

He said American trucks were becoming increasingly popular, largely because they had electronically controlled engines guaranteed to need no attention for the first 1,6 million km.

Other competitors doing well in the South African market included European truck makers Iveco, Renault and Scania. Toyota (SA) would be importing American Peterbilt trucks this year.

Warning South African truck makers against complacency Proctor-Sims said it was not too late for them to retain their share of the market.

"The international trend is towards smaller, more cost-efficient electronically controlled engines.

"With the end of sanctions these are now available to most local manufacturers. Knowing the market and the operating conditions as well as they do, they must still have an edge over the imports.

"But this advantage will soon be lost and some

of our well known names could go the same way as Leyland, which once had a virtual monopoly of the South African bus and truck market but has now disappeared."

Proctor-Sims said six entries for the Truck of the Year competition from "non-traditional South African manufacturers are graphic proof of the penetration of the South African market by the more modern and competitive imports.

"In order to qualify, the manufacturer has to have sold a minimum number of trucks in any series.

"We are therefore not looking at one-off exotics but at vehicles already working on South Africa's roads."

□ The future of the trucking industry comes under the spotlight on April 20 and 21 when the Road Freight Association hosts the Annual Outlook for Trucking conference in Midrand.

The agenda includes the growing uncertainty about future regulations to govern road usage at national and provincial levels and the lack of uniformity in the various provinces' approach to regulation.

Speakers include the minister of transport, Mac Maharaj, and the trade and industries minister, Trevor Manuel.

Inquiries Corrie Gouws, (011) 789-1367

Factory college builds skills

(192) CT(BR)11/4/95

By ROY COKAYNE

PRETORIA BUSINESS EDITOR

Silverton Engineering, the Pretoria-based automotive component manufacturer, has established a bridging school for disadvantaged pupils to meet part of its future staff needs and as a contribution to the reconstruction and development programme

The mineral and metallurgical research organisation Mintek addressed the problem of the lack of technically trained people with the launch in 1992 of its Aurora programme, which provided post-matriculation courses on its premises. Now Mintek has helped Silverton to set up the bridging school.

Aurora has also been implemented at five colleges established through the Barlow Rand Group, Mossgas, Sentrachem, Denel and Kentron.

In essence, a company that

joins Mintek's Aurora programme selects a small group of disadvantaged matriculated students from its local community and gives them a second chance to perform well in the technological subjects of mathematics and science. Classes are held on company premises.

Silverton Engineering managing director Chris Cronje said the company had committed about R500 000 to its development and training programme, which included paying the teachers for the college.

"We believe this facility will make a meaningful difference to young disadvantaged pupils to achieve the required standard for career development or tertiary education," he said.

The Silverton bridging school will lecture in mathematics, science, English communication and life skills, presented by external teachers. The programme will start

with 10 students drawn from the local community, some of whom will advance into the Silverton development and training programme.

Apart from meeting part of the company's future staff needs, the concept is intended to contribute to the RDP.

Greater Pretoria RDP co-ordinator Joshua Ngonyama said the college was a bold move by Silverton Engineering and should serve as a challenge to other companies.

He said many companies hired black people in senior positions but this was just window-dressing.

"What Silverton Engineering has done is commit itself to the RDP and to improving the quality of life of our people," he said.

Cronje said the local vehicle market was static and therefore, in line with the company's motto of growth through commitment, it had set its sights on world mar-

kets. Today 30 percent of turnover is derived from exports to the United States, Europe and other parts of the world.

Despite the improvement of the domestic economy, exports are expected to grow to 45 percent of total sales within the next two years. This growth would afford many people opportunities for fruitful employment that would not be possible without global trade, he said.

Cronje said his answer to people asking what exports had to do with the training facility at Silverton was that for a company to grow, the people in the company had to grow and tomorrow's managers had to be developed today.

"It is all part of nation-building. The greatest asset of any country is its people — and the noblest investment is the investment in the training and skills development of those people," he said.

Staff held hostage, escape through gate

ROGER FRIEDMAN
Labour Reporter

THE management of a Somerset West company, who were being held hostage overnight by striking workers, managed to escape by slipping through an unguarded side gate

Vynide's labour force — which embarked on a legal strike on Monday — yesterday threatened not to allow anyone through the gates until their wage demand had been met

Management feared they would have to spend the night there — but then spotted a way out and made good their escape.

Vynide, which previously manufactured dynamite as part of the AECI group, now makes motor car trim and accessories

Negotiations between the company and unions representing the workers resumed at 9am today

The action by Vynide's workers is the first joint action by members of the South African Chemical Workers' Union (affiliated to Nactu) and the rival Chemical Workers' Industrial

Union (affiliated to Cosatu)

According to a spokesman for the unions the issue is that Vynide used to be part of a national bargaining unit but had moved to decentralised bargaining

He said that whereas all other companies in the former national bargaining unit had increased wages by 12 percent, Vynide was not prepared to increase its offer above 10.95 percent

“Our other demand is that they recommit themselves to centralised bargaining,” the spokesman said

By moving from centralised bargaining, Vynide was attempting to exploit labour, he said

At 5.30pm yesterday, Vynide national administration manager Jansen Rheeder said wage negotiations had begun in November

Both parties had used all the procedures in the Labour Relations Act and had reached deadlock.

He preferred not to comment further as negotiations were at a “sensitive stage”

ARG 12/4/95

'Kaizen' has dramatic effect on Nissan suppliers

(192)
CT(BR)12/4/95

BY ROY COKAYNE

PRETORIA BUSINESS EDITOR

A training partnership between Nissan South Africa and its suppliers is achieving dramatic results. The programme is intended to improve the productivity of suppliers, reduce Nissan's manufacturing costs, and improve product quality.

Called the Nissan South Africa Supplier Development Programme, the scheme is based on a Japanese model and Nissan's worldwide "Kaizen" philosophy of small, continuous improvement.

Charles Wiggill, managing director of Nissan South Africa Manufacturing, said yesterday many suppliers had achieved dramatic improvements in the programme's first 12 months. Among other things, it had helped them to improve quality and lower costs.

Under the programme, suppliers are initially assessed by Japanese-trained Nissan technicians and graded in 10 areas.

These are quality, delivery control mechanisms, productivity, equipment maintenance, stock control, production process control, housekeeping, management, safety and morale.

Once they have been assessed and graded, their weaknesses are highlighted and training and educational programmes are put in place to achieve predetermined levels of improvement over six months.

The training programmes are developed and run by Nissan at no cost to the supplier.

All existing suppliers are part of the programme, and it is a condition of future suppliers' contracts that they become part of the assessment and improvement process.

Auto parts mogul aims for large slice of the pie

(192)

CT(BR)-12/4/95

Federal-Mogul reinvested in South Africa last year. Now it is building a R30 million head office and warehouse

By ROY COKAYNE

PRETORIA BUSINESS EDITOR

Detroit-based Federal-Mogul, one of the world's largest automotive parts distributors, took its R248 million re-investment in South Africa a step further yesterday by breaking ground for a R30 million head office and warehouse facility at Denver, east of Johannesburg

The facility will be a focal point for Federal-Mogul's thrust into the South African automotive parts and accessories aftermarket

The parent firm last year achieved worldwide turnover of \$1,9 billion

Federal-Mogul acquired Varex Corporation, which is listed on the JSE, and the assets of unlisted car parts distributor Southspare last October

Varex, the largest independent auto parts distributor to the South African aftermarket, was controlled by W&A Investment Corporation while Southspare was part of Edspare Investment Holdings

The investment was one of the largest in South Africa by a foreign company since sanctions were lifted. It reversed Federal-Mogul's disinvestment from South Africa in 1988, when it disposed of its wholesale distribution operation, which

became a subsidiary of Varex, trading as Femo

Rob Crockett, chief executive of Federal-Mogul South Africa (FMSA), said the group had an annual turnover of about R500 million — but aimed to double that within a year

In addition to supplying parts to the aftermarket, the firm is also plunging headlong into retailing on the strength of its wholesale network. Operating units in FMSA's fold include Spareco, V&R, Eddies and Femo

Crockett said the entire South African group would trade as Federal-Mogul at retail and wholesale level — with the exception of the Pretoria-based Eddies Motor Spares. He said Eddies Motor Spares had an extremely successful formula and would be expanded

throughout the country from three to 10 or 12 branches

The head office and warehouse facility is being developed for FMSA by Old Mutual Properties and will comprise 15 000 sq m of warehousing and 2 500 sq m of offices — making it one of the largest warehouse facilities serving the automotive parts and accessories aftermarket in the country. The site is near Jan Smuts airport and the Transnet cargo depot

Crockett said the group's existing warehouse distribution business, including engine wholesaler V&R and general spares wholesaler Femo, was being consolidated into about a dozen operations, while at retail level the branch network had grown from four to about 50 nationwide. He said further expansion was planned

Housing plan for Mercedes workers

ROBYN CHALMERS

DAIMLER Benz, the parent company of Mercedes Benz SA, will provide R27m to leverage credit for the construction of 1 000 low-cost homes for its employees which will be situated within walking distance of their work.

Mercedes Benz communications manager Shane Hegarty said yesterday a section 21 company called Siyakha had been set up after consultation with workers and the National Union of Metalworkers of SA.

Siyakha would facilitate the construction of 1 000 homes at about R54 000 each in four locations — Johannesburg, Pinetown, Pretoria and East London.

"The houses will be concentrated mainly in East London where our manufacturing concern is located and we expect about 900 of the employee homes will be built in this area," he said.

Daimler Benz would place the R27m with a financial institution and government's project-linked and individual subsidy would also be utilised where possible.

The remainder of the funding would come from financial institutions, so should workers leave their employment at Mercedes Benz, their obligation would be with a bank as opposed to the company.

Mercedes Benz had been looking at methods of ensuring workers did not have to travel long distances to get to work, which inevitably cost them a

significant percentage of their monthly income.

"The purpose of the venture is to accommodate our workers in housing they can afford with pleasant surroundings, which will cut down on the high cost of transportation."

Construction on the houses was expected to begin in June this year, and Hegarty estimated the first houses would be ready by August or September. Several building companies would be used to construct the homes, and a housing consultant had been appointed to oversee the process.

This is the second such scheme instituted by a major organisation in SA. During 1993, Murray & Roberts embarked on a similar development called Graceland.

M&R engineering CE Ian Colepeper said workers could spend up to 20% of their salaries getting to and from work. In spite of SA's sophistication in terms of technology and infrastructure, the country still had very immature transport systems.

Graceland provided accommodation for workers close to work in the form of 800 homes ranging from R35 000 to R85 000.

Hegarty said Mercedes Benz had been looking into this sort of accommodation for a number of years, beginning when the company set up a housing, education and social responsibility fund.

Exports of cars may pass R1,1bn mark

(192)

BD 13/4/95

MARCIA KLEIN

EXPORTS of built-up cars were expected to increase as much as 40% to more than R1,1bn this year, industry sources said yesterday.

Most manufacturers were focusing on exports in anticipation of the new motor industry development programme, which would force them to improve economies of scale and would offer import credits for achieving set export levels.

National Association of Automobile Manufacturers of SA (Naamsa) director Nico Vermeulen said the value of exports was "substantial and growing". Exports of built-up vehicles brought in about R782m a year. However, they were expected to reach R267m in the quarter to end-June — almost double first-quarter sales. Similar levels would be achieved in the September quarter. Exports were particularly strong in the commercial vehicle sector, he said.

Combined exports of vehicles and components were running at about R2,5bn a year. Forecasts indicated sales would reach R673m in the quarter to end-June and R711m in the quarter to September. Although the new motor industry dis-

pensation had not been finalised, it was certain it would include an import/export facility. Vermeulen said "Exports would continue to be a cornerstone of the motor industry development programme, as this was an area where economies of scale could be achieved."

Volkswagen SA marketing communications GM Bill Stephens said his company's export programme had largely included the extensive contract to export second-generation Jettas to China. Under the two-year contract, which would end in May, it would have exported 28 000 vehicles.

"We are looking at many opportunities in conjunction with our parent company in Germany. VWSA still exports a small number of vehicles into Africa, but it would want to replace the volumes exported to China. We are looking aggressively at all exports into right-hand drive countries."

Audi recently stopped production of the A6, importing it instead, and would start manufacturing the higher volume A4.

□ To Page 2

Car exports ~~(192)~~ (192)

□ From Page 1

Toyota SA group marketing director Johann van Zyl said Toyota had planned for a 40% increase in export sales to more than 3 500 units in 1995. It recently opened an export distribution centre, exporting 2 257 vehicles to Zimbabwe, Zambia, Malawi and Mozambique last year, and would export to Kenya from May.

Delta MD Willie van Wyk said it was proposed that each rand earned from exports be used as credit against a wide

range of imported components and vehicles. Delta believed SA would become the source for low-volume niche markets abroad. It was also exporting converters, jacks, tooling and other components to manufacturers in Europe, the US and the Far East.

BD 13/4/95
Details of the motor industry restructuring, originally scheduled for implementation on June 1, are expected in May.

SA swings to smaller cars

(192)

BY AUDREY D'ANGELO

CAPE BUSINESS EDITOR
CT (BR) 13/4/95
The taxation of fringe benefits had resulted in a pronounced swing to smaller cars in South Africa, said Stephanus Loubser, managing director of Nissan Marketing

At a presentation in Cape Town yesterday, Loubser said small cars now accounted for 74 percent of total sales compared with 51 percent in 1994

"Executives who used to insist on a German luxury car as essential to their status are now taking the car allowance instead and driving smaller cars," he said

The swing had been helped by improvements in the styling and sophistication of smaller cars which made it easier to buy down, he said

Loubser also forecast that South Africans would have a wider choice of makes within the next few years, as more manufacturers entered the market with the easing of protective tariffs

OLD FRIENDS .

Lee Iacocca and Robert Eaton, pictured in the days before Mr Eaton took over from Mr Iacocca

Picture AP

CHRYSLER chairman Robert Eaton remained tight-lipped about the US car-maker's struggle to stave off a hostile takeover bid as he unveiled first-quarter results at the company's headquarters in Highland Park, Michigan, this week.

Mr Eaton refused to answer questions about the bid by tycoon Kirk Kerkorian — Chrysler's largest shareholder — and Lee Iacocca, Chrysler's former chairman.

He stated only that "the board did and will consider any offer out there".

Chrysler bluntly responded earlier to the \$22.8-billion buyout offer, which could become the second largest US corporate acquisition in history, saying in a statement "the company is not for sale".

Mr Kerkorian stunned the US business and finan-

cial establishment with the bold move, unleashing speculation on whether the offer is a money-making ploy that could jeopardise Chrysler.

Chrysler announced on Thursday a 37% drop in first-quarter net earnings at \$592-million from \$938-million during the same period in 1994.

Business watchers said the drop would probably add to the market confusion

Quarterly revenues totalled \$13.6-billion compared with \$13.2-billion the previous year.

Mr Eaton attributed the losses registered in first-quarter results to the overall state of the US economy and to the financial crisis in Mexico.

"Our first-quarter results reflected an overall slowing in domestic economic activity which has resulted in increasing retail incentives"

Chrysler made 714 765 vehicles in the first three months of 1995 compared with 740 598 vehicles for the same period in 1994. Its international retail sales were up 22% at 34 572 vehicles for the first quarter of 1995 compared to the same period last year.

On Wall Street, Chrysler stock was down 125c in late morning trading on Thursday at \$47.75 from Wednesday's closing stock of \$49.

News of Mr Kerkorian's

We're not for sale, Chrysler informs its former chairman

offer sent Chrysler stock soaring \$12.15 a share at Wednesday's opening on Wall Street to \$51.50.

Mr Kerkorian, a reclusive tycoon who already controls about 10% of Chrysler's shares, said through his flagship company, Tracinda Corporation, that he was launching the bid on Chrysler because he believed the car-maker's shares were undervalued.

Chrysler, the third largest US car-maker, has climbed from near-bankruptcy in the 1980s to become the industry's leanest and most profitable car-maker in part due to the efforts of Mr Iacocca, one of Mr Kerkorian's backers.

In rejecting the offer, Mr Eaton stressed he opposed Mr Kerkorian's plan to tap into Chrysler's cash reserve to help finance the deal — Sapa-AFP

Tractor sales rise a 'surprise' 27%

By ROY COKAYNE

PRETORIA BUSINESS EDITOR

The latest agricultural vehicle sales figures released by the SA Agricultural Machinery Association show tractor sales in March this year totalled 363 units — almost 27 percent higher than the 287 units sold in March last year. Sales of tractors in the first quarter

of this year are almost 23 percent higher than the same period last year.

Saama chairman Gerrie de Jong said the figures were rather surprising given the relatively poor summer crop prospects this year.

Combine harvester and baler sales were lower than last year. De Jong said this was probably a closer reflection of crop prospects.

CT(BR)18/4/95 (192)

3) **Samcor in R46 million upgrade:** Motor manufacturer Samcor has invested R46 million in plant and equipment at its high-tech plant in Silverton, Pretoria, for its new Mazda passenger vehicle range. It has also invested R6 million in robotics to improve the overall quality of vehicles, said executive director of manufacturing, Larry Bird. See next page

(192) CT(BR) 25/4/95

Samcor invests R46m in new range

(192)

Improvements at the high-tech factory in Silverton for the launch of the new Mazdas are aimed at producing world-class vehicles

ROY COKAYNE

PRETORIA BUSINESS EDITOR

Motor manufacturer Samcor has invested R46 million in plant and equipment at its high-tech plant in Silverton, Pretoria, for its new Mazda passenger vehicle range

It has also invested R6 million in robotics to improve the overall quality of vehicles

The new Mazda Etude has just been launched and the Mazda Astina is scheduled to be launched by mid-year

The executive director of manufacturing, Larry Bird, said R38 million had been invested in bodyshop facilities for the Etude and Astina

Changes to the trim line added another R8 million in investment, he said. The investment in computer-controlled equipment on the trim line was aimed at ensuring the quality of the functional items in the vehicle

Items such as headlamp focus, wheel alignment, brake testing and all the electrical and electronic items

were also fully tested and approved before the vehicle was signed off, Bird said

"Additional investment has been made in the paint shop to further improve the corrosion resistance of our vehicles

"A full-dip degreasing facility has been installed and a phosphate application upgraded to include full-dip electro-coat has been improved by uprating the materials used to the latest American technology levels," he said

"Our investment in robotics of a further R6-million is in line with our strategy to build the cars to the highest level of quality, in line with world standards

"Vehicles of today are designed to be built by robots, and that is what we intend to do if we are to be world class

"With this new production facility, efficiencies have been planned to meet the requirements of the latest Board of Tariffs and Trade proposals for the motor industry in terms of reducing costs and produc-

ing vehicles to world-class quality levels," Bird said

The Mazda Etude and Mazda Astina are being built on Samcor's newest and most modern production line on a 5 000 sq m site formerly used to produce the Ford Sierra/Sapphire ranges and Mazda 626 cars

Using a flexible system, the line will initially be used to produce different body styles — Etude and Astina — and makes extensive use of robotics in the underbody and framing area

Initially geared to produce 12 units an hour, the line will eventually have a gross capacity of 30 units an hour — or 21 000 vehicles a year increasing to more than 52 000

The line will be synchronised by computer to feed into the facilities in the paint shop and will include such advanced features as a robotic glazing facility

Bird said flexibility was vital

"Under the old system it was always a problem to add in a new body shape, but under this system that constraint falls away and it is economical to build even small volumes from virtually any source plant," he said

CT 25/4/95

Numsa kicks off wage talks

~~124~~ RENE GRAWITZKY

192

WAGE negotiations covering 25 000 motor assembly workers started this week with the National Union of Metalworkers of SA's core demands homing in on implementation of education and training, a long-term wage policy and wage model and productivity issues.

The first plenary session of the National Bargaining Forum took place this week. Two task groups, established to investigate a wage model and education and training programmes, reported back to constituencies.

Industry sources said the two task groups contributed to more focused and less conflictual negotiations.

Numsa also motivated its other demands relating to worker rights, job security and employer contributions to the reconstruction and development programme.

On the employer side key issues were industrial peace and stability, longer term agreements, the decentralisation of issues relating to plant flexibility and productivity and competitiveness.

BD 26/4/95

T&N seeks joint ventures abroad

192

By Shirley Jones

STAFF WRITER

CT(BR) 27/4/95
The Durban-based automotive holding group T&N Holdings is investigating offshore joint ventures, starting in India

Speaking after the group's AGM yesterday, managing director Ted Waldburger said the company's decision to increase authorised share capital from R5 million to R8 million through the creation of 15 million new shares would gear up the company to take full advantage of emerging business

India, with its developing economy, was recognised internationally as a potential growth area, he said

Over and above growing overall export turnover, T&N is looking to develop its innovative technology which allows for simpler manufacturing of heat transfer products using cheaper raw materials.

Waldburger confirmed that development of manufacturing capacity was firmly on track and some products were already being

T & N Holdings share price

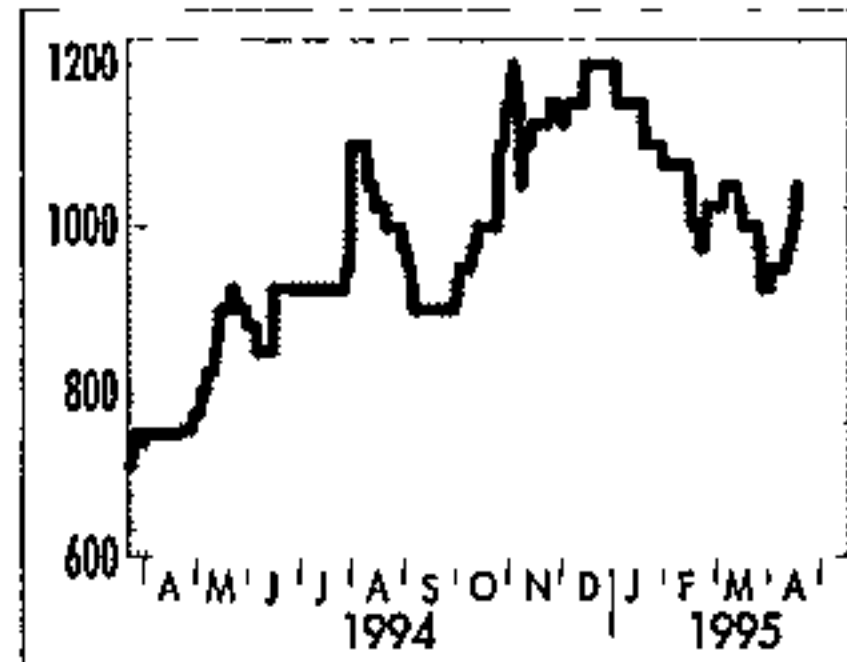

marketed. Volume plant was on order and expected to be installed by the end of the year at FHE Automotive in Pinetown, he said

T&N Holdings' chairman, Colin Hope, said the outlook for T&N during 1995 was encouraging, provided that the momentum of the economic upturn was sustained and labour disruption contained

He said that in comparison with the first quarter of 1994, overall performance between January and April 1995 was impressive, with a 47 percent increase in export turnover.

New R20m assembly line for Uno

(192)
BY STAFF WRITERS

ET (BR) 28/4/95
Nissan South Africa will spend R20 million on expanding the production capacity of its Uno assembly line at Rosslyn, Pretoria, to produce 90 units a day from its present level of 75, it said in a statement yesterday.

The statement follows an announcement at the beginning of April that R550 million would be spent at Rosslyn over three years to upgrade productivity and product quality.

Nissan said yesterday continuing strong demand for the Uno range had resulted in consistent shortages of the vehicle for the past two years.

Pushed

The existing assembly line was intended to produce 30 units a day when the Uno was launched in 1990, but production has now been pushed to the maximum possible and no further increases in output can be made without further investment.

The new assembly line will be commissioned in May. Uno holds about 6 percent of the total car market and its panel van derivative has about 1 percent of the light delivery vehicle sector.

Nissan Japan recently announced an excellent year to March, with many of its models selling record numbers in the final month.

BD28/4/95

Saficon could be split up or sold off, analysts say

~~18 (192)~~
MOTOR and building materials group Saficon, which had cautioned shareholders that it was involved in negotiations, could be sold, market sources said this week.

Analysts said it had been speculated for some time that chairman Sidney Borsook wanted to sell his stake, or that the motor and building supplies interests could be separated, with either one or both being sold.

Saficon's major interests are Cargo Motors, Lindsay Saker and other motor companies and listed building supplies company Boumat. Malbak Motor Holdings and Barlow Motor Investments have been suggested as possible buyers for the motor interests, and McCarthy has been mentioned as a more remote possibility.

It was not clear if Boumat would be sold.

Results for the year to

MARCIA KLEIN

March will be released shortly, and analysts expect them to be good, off a high base. They said the company had been doing well, and market sentiment was reflected in the share price.

Saficon gained 50c or 3.2% on Wednesday to close at a R16 high — up more than fourfold since this time last year. The share has gained nearly 24% in the past month.

Holding company Sakers' share closed unchanged on Wednesday at its R24 high. The share, which was trading at 525c a year ago, has gained 28% in the last month.

At the September interim stage, Saficon more than trebled earnings to R18.2m off an 18% turnover rise to R1.7bn. Interim results indicated it was continuing the recovery evident at the March 1994 year-end.

Delta wins Saab distribution rights

MARCIA KLEIN

(92)

DELTA Motor Corporation had been granted the distribution rights by Swedish car-maker Saab Automobile AB for its vehicles in SA, Delta announced this week **BD 28/4/95**

Sales and marketing director John Cuming said details still had to be finalised, but Delta would be distributing a selection of Saab 900 and 9000 models including the Saab 900 Cabriolet.

The importation of Saab vehicles would start during the last quarter of this year.

Cuming said Saab was known worldwide "for its unconventional approach to prestige car motoring, and is a trendsetter in automotive design and technology".

"The new Saab vehicles will offer an additional luxury vehicle choice to the SA consumer"

Car price rice hike looms

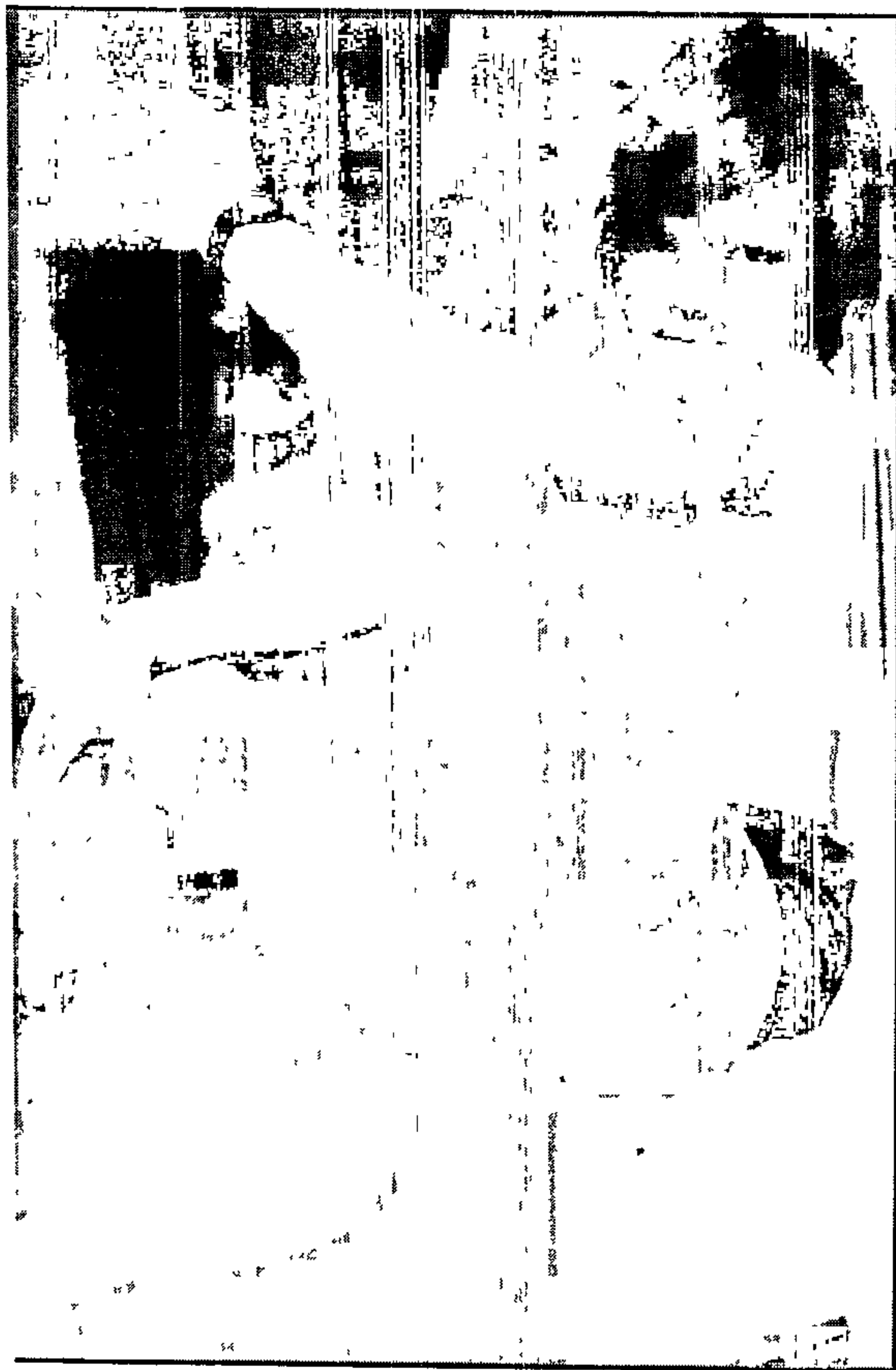

E VICTIM: Schoolboy Richard Norval has 200 stitches in his body after being attacked by a pack of five dogs

Falling rand puts (192) pressure on industry

ARG 6/5/95

■ The rand's depreciation against the Japanese yen and German mark have raised the cost of the industry's imports by about 20 percent already this year

Weekend Argus Correspondent

PRETORIA — The falling rand could force up car prices in the near future, warns the National Association of Automobile Manufacturers Association (Naamsa)

The rand's depreciation against the Japanese yen and German mark had raised the cost of the industry's imports by about 20 percent in the short space of four months this year, it said

Naamsa said the high number of public holidays and extended long weekends had had a negative impact on new motor vehicle sales in April

While sales in all sectors in April remained well up on the corresponding month last year, the new vehicle sales figures — particularly in the car and light commercial vehicle sectors — had shown fairly sharp declines compared with the exceptional sales levels achieved in March, said Naamsa

However, the underlying trend remained positive and, overall, the South African new-vehicle manufacturing and associated industries remained on target for an above-average year

The continued solid performance of the medium and heavy commercial vehicle sectors was indicative of the recovery in fixed investment in the South African economy

Figures released by Naamsa revealed that new car sales rose 12,2 percent or 1 707 units

in April to 15 740 compared with the corresponding month last year — but were 25,5 percent or 5 375 units lower than March this year when 21 115 units were sold

Sales of new light commercial vehicles, bakkies and minibuses were 27,4 percent or 1 929 units higher at 8 981 than in April last year. But, sales in April were 28,3 percent or 3 539 units lower than the 12 520 units sales achieved in March this year

The low volume medium- and heavy-truck sectors also recorded sharp gains in April compared with the same month last year

Sales of medium commercial vehicles in April this year rose 85,7 percent or 150 units to 325 units compared with April last year, but were 7,4 percent or 26 units lower than March this year

The heavy commercial vehicle sector followed a similar pattern with sales at 596 units, 68,4 percent or 242 units higher than April last year, but 13,7 percent or 95 units down on March this year

Adolf Moosbauer, Mercedes-Benz SA board member for commercial vehicles, said the South African commercial vehicle market in the over 7,5-ton category continued to reflect the air of confidence blowing through the corridors of South African industry, with a 58,3 percent or 862 units increase in sales being registered in the first four months of this year compared to the corresponding period last year

Toyota SA group marketing director Dr Johan van Zyl said the first four months of this year had been marked by a strong growth pattern that exceeded annualised forecasts and, on a year-to-date basis, the market was up by 19,8 percent

This was attributable to pent-up demand carried over from a market that was under-supplied in 1994, he said

But, adverse economic trends were expected to reduce demand

Delta Motor Corporation sales and marketing director John Cuning said "We continued to view the South African economy as being on track to real recovery, with increased growth in manufacturing and RDP-linked expenditure leading the way"

Doris, 82, killed by pitbull

Argus Correspondent

Bitterness hangs over the tiny community of Merrievale where a fight between two families shattered

Some of the village gath-erings were memorial services to respect to 82-year-old Doris Bartholomew, who was being savaged by a pitbull belonging to her

Survivor of the attack, Doris, 67, attended the funeral of her friend, after being urged from Grey's

Hospital, where she had extensive skin grafts and surgery

An ear was lacerated and she was bitten on the arm, which she now is unable to use

Although the owner of the dog, Ray van Zuydam, attended the service, he has not yet contacted the family of the dead woman

Mr Van Zuydam said the women should not have entered his property

Mrs Gordon denied she or her friend had entered the property, saying they stood outside the gate as they waited for Mr Van Zuydam's mother,

Sue Stiega, to accompany them to church

"We had been to the house many times and were well aware they kept a vicious dog," Mrs Gordon said

"Doris was terrified of dogs and would never have dreamed of opening the gate and entering the property

"Suddenly the dog appeared from nowhere and jumped up at the unlocked gates, which opened"

The next 10 minutes were horrifying, she said

"I screamed and tried to

fight off the animal. For some reason it left me and went for Doris. I called to the children on the property to help but they said they couldn't do anything because only their father could control the dog and he wasn't there"

Although a passer-by hit the dog with a steel pole, it refused to let go of its victim

Three gunshots fired by a neighbour, Andrew Hall, eventually forced the animal to let go of the woman

Both women were admitted to hospital, where Mrs Bartholomew died of her injuries

NEWS IN BRIEF

Rector 'not suspended'

VAAL Triangle Technikon rector Prof Pieter du Plessis had not been suspended, but had taken a break from his duties "of his own accord", Technikon spokesman Sugen Nair said on Friday.

This was contrary to reports on Friday that Prof du Plessis had been suspended pending the outcome of an investigation into his involvement in claimed financial mismanagement at the technikon.

No phase-down date

TRADE and Industry Department spokesman Chari Nel has denied stating that Minister Trevor Manuel was expected to announce the duty phase-down for clothing and textiles on May 16.

Thousands see show

THOUSANDS of people turned out to view computers and accessories at TML Reed Exhibitions' fifth Computer Faire & Bexa show which ended on Saturday.

Organisers said about 31 000 people had passed through the gates by Friday.

About 450 foreign computer companies took exhibition stands.

Avia Airlines takes off

THE monopoly by SAA and British Airways on the Johannesburg-London route will be broken today when SA's newest international carrier, Avia Airlines, starts its scheduled service between Johannesburg International Airport and London's Gatwick.

Avia will operate three weekly return flights on the route.

Avia's fares are 15% lower than those of SAA and BA.

REPORTS. Sape, Business Day Reporters.

VW takes over as the No 1 seller

60 8/5/95 (192)

MARCIA KLEIN

THE buoyant growth in car sales in the first three months went into reverse in April, with a 25,5% decline from March's sales reflecting the numerous public holidays and the fact that sales were historically lower in April.

Nevertheless, industry sources said sales were still 20% up in the first four months compared with the previous year, and this trend was expected to continue, although not necessarily at the same rate.

Figures released by the National Association of Automobile Manufacturers of SA (Naamsa) on Friday showed the 15 740 new cars sold in April to be 25,5% lower than March, but 12,2% up on April last year.

Naamsa said seasonal factors, particularly the number of public holidays and extended long weekends, affected the new vehicle market. New vehicle sales, particularly cars and light commercial vehicles, showed "fairly sharp declines compared to the exceptional sales levels achieved during the previous month".

Volkswagen SA (VWSA) ended Toyota's winning streak, as it sold 3 706 new passenger cars compared with Toyota's 3 004 Nissan sold 2 636 units, Mercedes-Benz 1 908, Delta 1 545, Samcor 1 426 and BMW 1 422. Sales of Hyundai are not reflected.

Sales of light commercial vehicles, bakkies and minibuses rose 27,4% to 8 981 units year on year, but were 28,3% down on the previous month.

There were sharp gains in the low-volume medium and heavy truck segments compared with the previous year and marginal declines com-

pared with March, Naamsa said.

"The SA new vehicle manufacturing and associated industries remained on target for an above average year during 1995." But the rand's depreciation against the yen and the mark "had raised the cost of the industry's imports by about 20% in the short space of four months and this would inevitably translate into further pressures on new vehicle prices in the months ahead".

Naamsa added the continued growth in the medium and heavy commercial vehicle sectors was "indicative of the ongoing recovery in fixed investment in the SA economy". VWSA said its Citi Golf range recorded its highest sales volume for a single month "to boost the company into top spot in the passenger car market in April, with a total share of 24,1% of the market".

Nissan SA Marketing MD Stephanus Loubser said the downward trend of the rand and the dollar against European and Japanese currencies, which affected pricing and put upward pressure on interest rates, were cause for concern.

"Since the start of 1995 the yen has appreciated by 18,2% against the dollar, and has risen about 10% against the rand since the finrand was abolished." He added the rand's fall against the mark was not as dramatic, but still significant. But growth in gross domestic fixed investment should have a positive effect on vehicle sales, particularly commercial vehicles.

Department will favour black business

NICOLA JENVEY

mented, and included a six-month pilot scheme effective immediately. It would promote black consultants and firms, developing their human resources by ensuring these consultancies headed the department's roster for work projects.

Black majority-owned firms would be given preference.

"We want to initiate... which benefits the disadvantaged consultant within a very short time, demonstrating our commitment to the reconstruction and development

programme," Radebe said.

He defined "a disadvantaged firm" as one in which the equity majority was held by black partners, or any firm previously prejudiced by the appointment procedure.

Phase two included establishing a dual roster system. Established firms would be on one roster and attract projects with consultancy fees greater than R75 000, while disadvantaged firms would be on a second roster.

Disadvantaged firms would be awarded jobs either from their own roster or as joint venture partners with established firms on larger jobs.

DURBAN — The Public Works Department would implement a consultancy appointment scheme for state projects which promoted black entrepreneurs in preference to established business, Public Works Minister Jeff Radebe said at the weekend.

He said at the launch of the SA Black Technical and Allied Careers Organisation's KwaZulu/Natal branch that the current appointment system favoured large, established firms.

The new system could be duplicated throughout government.

A new system would be imple-

Five-year-old Uno has the last laugh

(192) LT(BR) 8/5/95

By ROY COKAYNE

PRETORIA BUSINESS EDITOR

The Uno, the butt of many jokes since it was introduced to the South African market by Nissan, celebrated its fifth birthday with sales of more than 50 000 since its introduction in May 1990

The Uno has consistently grown its share of both the A/B segment of the passenger vehicle and the total car market since its introduction.

Its share of the A/B segment rose from 11,9 percent in 1990 to 20,1 percent by the end of February this year

Over this same period, its total

market share has increased from 3,2 percent to 6,2 percent

The sustained demand for the Italian car has prompted Nissan to invest R18,9 million to expand the production capacity of its Uno assembly line from 75 to 90 units a day. The new line will be commissioned this month

Delay likely in motor industry regulations

(192)

MARCIA KLEIN

BD 9/5/95

LONG-awaited changes to motor industry regulation, under discussion for more than a year, seem likely to be delayed by at least another three months after the July 1 deadline.

Industry sources said certain issues, notably the clash about duties between vehicle and component manufacturers, had not been resolved by the Board on Tariffs and Trade.

They said the board had been expected to make an announcement this month so that the industry could prepare for a July 1 implementation of the new "phase 7" regulations.

Board spokesman Daan Bosman said no decision had been taken on a postponement, but further developments would be announced as soon as possible. Industry sources said the board had "no sense of urgency".

Bosman said the motor industry development programme was "very complex and required protracted discussions between industry and government".

"The board considers this programme of great importance and is now finalising its report to the Minister."

A National Association of Automobile Manufacturers of SA spokesman said its members would obviously like to see the programme implemented as soon as possible.

The new dispensation would see the industry move from an excise-based system to a customs-based system.

Investment drive for car industry

BO 11/5/95

ADRIAN HADLAND

CAPE TOWN — Trade and Industry Minister Trevor Manuel will lead a high level investment recruitment drive when he visits Germany next month in a move to boost manufacturing in the Eastern Cape.

Regional Industrial Development chief director Johan Reinhardt told Parliamentary trade and industry committee members the drive would focus particularly on attracting investment for the production of motor vehicle components.

To remain competitive in the world arena, SA had to vigorously court foreign investment, the same as other developing countries, Reinhardt said.

SA's trade and industrial policy should be geared towards the promotion of "labour-demanding, outward

orientated expansion", especially in the manufacturing sector, he argued. SA's share of world trade, which had declined from 1,7% in the 1960s to 0,7%, needed to be boosted to at least 1,1% within the next three years.

Since the inception of the Regional Industrial Development Programme (RIDP) in 1991, more than 50 000 direct and 133 000 indirect jobs had been created, while investment in new plant and equipment of about R13,9bn had been attracted, Reinhardt said.

Following intensive investment recruitment, 135 foreign companies had relocated to SA in the period involving total investment of R1,2bn and a further 13 215 jobs.

Other benefits included the trans-

fer of technology, upgrading of skills and the securing of export markets.

The Simplified RIDP (SRIDP), which was introduced in November 1993 and targeted small business, had seen the approval of 229 projects attracting R270m in investment and the creation of 6 144 jobs.

Reinhardt said R410m of the RIDP's R850m 1995/96 budget would be spent on profit/output incentives, R62m on relocation grants and R55m on the SRIDP.

Rebates, subsidies and incentives, which were being phased out over a five year period, accounted for the balance of the budget.

"The need for well-directed, cost effective incentive programmes, such as the RIDP, is self-evident," he told parliamentarians.

LARY — was granted a com-

Investment drive for car industry

BO 11/5/95

(192)

ADRIAN HADLAND

CAPE TOWN — Trade and Industry Minister Trevor Manuel will lead a high level investment recruitment drive when he visits Germany next month in a move to boost manufacturing in the Eastern Cape.

Regional Industrial Development chief director Johan Reinhardt told Parliamentary trade and industry committee members the drive would focus particularly on attracting investment for the production of motor vehicle components.

To remain competitive in the world arena, SA had to vigorously court foreign investment, the same as other developing countries, Reinhardt said.

SA's trade and industrial policy should be geared towards the promotion of "labour-demanding, outward

orientated expansion", especially in the manufacturing sector, he argued

SA's share of world trade, which had declined from 1,7% in the 1960s to 0,7%, needed to be boosted to at least 1,1% within the next three years

Since the inception of the Regional Industrial Development Programme (RIDP) in 1991, more than 50 000 direct and 133 000 indirect jobs had been created, while investment in new plant and equipment of about R13,9bn had been attracted, Reinhardt said.

Following intensive investment recruitment, 135 foreign companies had relocated to SA in the period involving total investment of R1,2bn and a further 13 215 jobs

Other benefits included the trans-

fer of technology, upgrading of skills and the securing of export markets

The Simplified RIDP (SRIDP), which was introduced in November 1993 and targeted small business, had seen the approval of 229 projects attracting R270m in investment and the creation of 6 144 jobs

Reinhardt said R410m of the RIDP's R850m 1995/96 budget would be spent on profit/output incentives, R62m on relocation grants and R55m on the SRIDP.

Rebates, subsidies and incentives, which were being phased out over a five year period, accounted for the balance of the budget.

"The need for well-directed, cost effective incentive programmes, such as the RIDP, is self-evident," he told parliamentarians.

COMPANIES

DAF appoints SA assembler

DUTCH truck manufacturer DAF had appointed Associated Automotive Distributors to assemble and distribute its trucks in this country, visiting Dutch Foreign Trade Minister Anneke van Dok said yesterday

The first trucks were expected to roll off the assembly line in August.

Addressing a luncheon outside Johannesburg, Van Dok, who is on a week's visit to the country, said the existing historical links between SA and the Netherlands should be used to benefit both nations

"One of the similarities is that both nations occupy a position as a gateway to a large region," she said in reference to SA's position in southern Africa and that of the Netherlands in Europe.

Tourism and trade between the two

192
JOHN DLUDLU

countries were booming and KLM airline was having difficulty in coping with the number of passengers travelling between the two countries

Imports and exports had put pressure on cargo capacity and the airline had to increase its weekly freighter service

She said the challenge was to sustain the gains of expanding trade and tourism over the long term. BD 11/5/98

Earlier in the week Van Dok signed an investment guarantee agreement with Trade and Industry Minister Trevor Manuel and held discussions with leaders, including Gauteng finance and economic affairs minister Jabu Moleketi

MOTC INDUSTRY (192)
 The best laid plans ... FM 12/5/95

Prospects of a new motor industry development plan being implemented on schedule in July, are looking slim. The Board on Tariffs & Trade (BTT), which is drafting the plan, isn't expected to present final recommendations to Industry Minister Trevor Manuel until later this month. Motor industry officials doubt it will be studied and accepted in time for July. At best, they think it could be ready by September, at worst, next year.

The biggest fear in the industry is what will happen to the intended July 1 reduction in import duties on built-up cars. Now at 75%, duties are due to fall to 65% then, and manufacturers have already based planning decisions on that assumption. Though it is hoped the 65% figure will come in, industry executives say the BTT pointedly refused to confirm this at their most recent meeting.

John Newbury, chairman of Nissan and president of the National Association of Automobile Manufacturers (Naamsa), says if duties don't change, "manufacturers will lose money. Our imports of built-up

BUSINESS

APRIL VEHICLE SALES

Manufacturer	Cars	Number of sales	Total sales	% of total car market
VW	Citi/Fox	2 257	3 796	24,1
	Golf/Jetta (A3)	1 382		
	Audi	89		
	other	68		
Toyota	Corolla/Conquest	2 412	3 004	19,1
	Camry	560		
	other	33		
Nissan	Sentra/Sabre	1 405	2 636	16,7
	Maxima	69		
	Fiat Uno	1 158		
	other	4		
M-Benz	Honda Ballade	921	1 908	12,1
	M-Benz C-Class	745		
	E-Class	172		
	S-Class	37		
	other	33		
Delta	Astra/Kadett	1 539	1 545	9,8
	Record	2		
	Monza/Kadett	7		
	Calibra	1		
Samcor	Laser/Meteor/323	997	1 426	9,2
	Telstar/626	239		
	Etude	157		
	other	33		
BMW	3-Series	1 220	1 422	9,0
	5-Series	113		
	7-Series	89		
Subaru		3		

	1995	1994	% change
April	15 740	14 033	+12,2
January to April	73 893	61 662	+19,8
March (21 115) to April			-25,5

MEDIUM COMMERCIALS			LIGHT COMMERCIALS		
	Number of sales	% of market		Number of sales	% of market
Toyota	145	44,6	Toyota	3 169	35,3
Delta	76	23,4	Nissan	1 825	20,3
Nissan	52	16,0	Samcor	1 679	18,9
Samcor	32	9,8	Delta	1 391	15,5
M-Benz	6	1,8	M-Benz	435	4,8
Iveco	2		VW	349	3,9
			Land Rover	114	1,3
			Iveco	1	

	1995	1994	% change		1995	1994	% chg
April	325	175	+85,7	April	8 981	7 052	+27,4
Jan to April	1 229	963	+27,6	Jan to April	42 136	31 374	+34,3
March (151) to April			-7,4	March (12 520) to April			-28,3

HEAVY COMMERCIALS			TOTAL VEHICLE SALES		
	Number of sales	% of market		Number of sales	% of market
M-Benz	247	41,4	Toyota	6 418	25,0
Nissan	113	19,0	Nissan	4 426	18,0
Toyota	100	16,8	VW	4 145	16,2
MAN	43	7,2	Samcor	3 155	12,4
Delta	35	5,9	Delta	3 047	11,9
Erf	26	4,2	M-Benz	2 596	10,1
Tyco	23	3,9	BMW	1 422	5,5
Iveco	7	1,2	Other	233	0,9

	1995	1994	% change		1995	1994	% change
April	596	354	+68,4	April	25 642	21 614	+18,6
Jan to April	2 310	1 475	+58,3	Jan to April	119 593	95 477	+25,3
March (691) to April			13,7	March (34 677) to April			23,5

Source: NATIONAL ASSOCIATION OF AUTOMOBILE MANUFACTURERS OF SA

vehicles are based on the 65%."

It is the administrative side of the new industry programme rather than its chief elements, which is holding up work. Outstanding issues include the handling of nonrebateable duties and payment of incentives. As Newbury puts it: "The architecture has been defined, now we're waiting for the engineering."

The shape of that architecture remains crucial. Having tossed overboard many central recommendations of a government-appointed task group, and then changed its mind on important issues, the BTT's final thinking remains unclear. A general concern is that, in seeking to please all industry parties, the plan will please none.

The soon-to-disappear Phase Six local content programme was plagued by well meant compromise, which resulted in endless adjustments to suit individual industry sectors. John Brandtner, head of the National Association of Automotive Components & Allied Manufacturers (Naacam), fears that same lack of policy commitment may undermine the new plan.

He points out that, having already chopped and changed in the face of competing lobby groups, the BTT may have lost sight of what it set out to do. The industry has been hamstrung for years, says Brandtner, through allowing short-term sectoral interests to get in the way of long-term strategic ones.

The BTT, if it is firm, has the chance to transform the motor industry. However, "if you lobby someone lacking understanding of long-term implications, they are easily swayed," says Brandtner. "The danger is that, over months, you can water it down to something that is meaningless. I hope that's not the case this time."

Chinese in joint venture to build cheaper bakkies

BLOEMFONTEIN — Bakkies are to be assembled in Harrismith, Free State Economic Affairs and Tourism chief director "Ossie" Osman, said yesterday (192) B017/5/95

The R10m plant, Free State Motor Assembly (FSMA), would be a joint venture by Beijing conglomerate MinMetals, Johannesburg-based company Morstal, Development Corporation of the Free State and a trust that would involve black investors

Economic opportunity minister Ace Magashule said the trust was

aimed at black economic empowerment. The chairman, and chairman of FSMA, would be Joe Hlongwane

The development corporation has a 10% share in the operation. Up to 30% of the shares are to be reserved for blacks. Employees would hold 10% of the company.

FSMA CE Brian Stalbaum said the company would provide 200 to 300 jobs this year.

The assembly line, to be imported from China, would arrive in January next year, he said. The capacity of the

plant would be 500 units a month from a single shift daily. The vehicles would bear the trade name BAM.

Stalbaum said 700 to 800 jobs would be created eventually. Many local people would be sent to China for training.

All components would be imported this year, but next year attention would be given to making some locally. Some of the assembled vehicles would be exported.

Stalbaum said the bakkies would be the lowest priced in SA. A tractor would be available later — Sapa

Volkswagen acts against union

Renee Grawitzky

~~192~~ 192
VOLKSWAGEN has derecognised the SA Iron, Steel and Allied Workers' Union (Yster en Staal) on the basis that it has refused to open up its membership to all races

It would now grant full bargaining rights only to the National Union of Metalworkers of SA (Numsa), the majority union.

Volkswagen's Human Resource Director Brian Smith said. "The decision was taken in the light of the principle — recognised by the Industrial Court — that a union is entitled to recognition only if it signs up a majority of employees in a particular bargaining unit."

Iron and Steel represented 11% of hourly paid workers against Numsa's 84%, he said. "Racially based organisations have no place in the new SA, where nation-building is a priority."

As a consequence of this, a number of members of SA Iron and Steel have resigned and joined Numsa.

More recently, Numsa appointed two ex-SA Iron and Steel shop stewards as full time Numsa shop stewards at Volkswagen.

Edwin Ntsuntsu, chairman of Numsa's

BD 17/5/95
shop stewards council at Volkswagen said this occurred after the company decided to derecognise the union on the basis that it would recognise only nonracial and majority unions in the plant.

He said Numsa had made it clear to Iron and Steel members that they would be accepted into the union "for the sake of unity as well as to strengthen our position"

Numsa has claimed that Iron and Steel has close to 500 members at Volkswagen.

Iron and Steel general secretary Lenn van Niekerk-Venter said the company had alleged that an agreement had been reached with its full-time shop stewards on the question of minority/majority union status

The union had no knowledge of this and no mandate had been given to the shop stewards to agree to any such development in terms of which the union was derecognised, he said.

Van Niekerk-Venter has requested the company to produce such a document.

He claimed Volkswagen had "manipulated the shop stewards in order to recognise only Numsa".

Nissan plays its trump card

(M) Wm 19-25/5/95 (192)

Reg Rumney looks into the new plastic money that promises to help you buy a car

THE advantage to South African motor car company Nissan in launching its "Nissan card" seems obvious: card users are locked into buying a Nissan vehicle as their next new car.

Would-be Nissan owners get a form of added value from the motor company because the card provides a point of differentiation from other motor manufacturers.

The bank that finances the card, niche bank Unibank, has its existing credit and charge-card base expanded by Nissan's marketing campaign and gets a new source of income from interest on the outstanding balances of a whole lot of new cards.

The card is part of — but not the same as — a whole new wave of plastic money, such as the Woolworths and Pick 'n Pay cards, aiming to create customer loyalty.

The way the Nissan card works is that five percent of every purchase made with a Nissan Card — except for fuel and airfares — is put towards the purchase of a new Nissan or Uno in "Nissan Rands".

Five percent of all cash advances are earned as Nissan Rands, and five percent of debit balances transferred from other credit cards too.

As with private label credit cards, like the Woolworths Card, the financing will be handled by a bank, in this case Unibank.

Unlike the private cards, the Nissan Card is a "real" credit card, albeit one not backed by the world's two giants, Mastercard and Visa. So Nissan card users have access only to South African merchants who have signed up with Unibank. In all other ways it appears to operate as any other credit card would.

The Nissan card is similar to Unibank's Bonus Card, where card holders get five percent of the value of their yearly purchases back as a cash bonus at the end of the year. Unibank, with First National and Fedlife as major shareholders (25 percent each), says it has 300 000 existing credit cards in issue, and branches nationwide.

Nissan Marketing managing director Stefanus Loubser says that close to 6 000 have signed up and an aggressive campaign is on the go to sign up more.

The interest rate on outstanding balances is comparable to other credit cards, but the annual cost at R36 is lower. Loubser says General Motors (GM) does the same in the United States, also putting five percent aside for the customer to buy a new GM vehicle.

The five percent of the purchase price that becomes "Nissan rands" and goes towards the purchase of a new Nissan by the customer normally goes to the bank, says Loubser. With most other credit cards the percentage can vary from a couple of percent to more than five percent.

How Nissan does this Loubser doesn't want to say "That's our secret." Probably, the five percent is financed partly by the merchant, partly by Nissan and partly by Unibank.

What's in it for the consumer?

The amount a cardholder can save towards his new car may seem limited. By Nissan's own calculations, monthly card spending of R1 000 earns R50 a month, or R3 000 over five years. This means the cardholder will have saved the full deposit on an Uno, or R3 600, after six years. This is as long as the price of the Uno stays the same, and doesn't follow the seemingly endless upward spiral of car prices that South Africa has seen over the last decade.

Nissan points out Nissan rands can be pooled by multiple card holders, for example, from various family members each with Nissan cards. The cost of the main card is R36, but supplementary cards cost R18.

There is no expiry or limit on the accumulation of the Nissan rands, and non-family members can also pool Nissan rands, as long as they are more than 42 months old. This allows people to sell, swap, donate or bequeath their Nissan rands. The arrangement allows for *stokvels* or *stokvel*-type arrangements to buy Nissan vehicles.

It is early days yet, but response to the "co-branded" card indicates a fair number of consumers think the card a good deal — or they are desperate for a Nissan vehicle or credit or both. Loubser says that after the first ad was flighted on television last Saturday night, 650 enquiries were received, 700 were received after the second flighting on Sunday, and there have been around 1 000 calls every time the ad has been flighted since. It is understood Unibank has received more than 15 000 applications.

Toyota to spend extra (192) R70m in Eastern Cape

CT (BR) 22/5/95

Toyota has released plans to expand and spend an additional R70 million in the Eastern Cape and more than R350 million with component suppliers this year. These announcements follow in the wake of Toyota SA's entry into the Kenyan market and the opening this month of a new assembly plant outside Melbourne, Australia.

Ralph Bradley, managing director of Toyota SA Manufacturing, said the project had created more jobs in the Eastern Cape. "We are making the investment in spite of the uncertainty in the industry with regard to the long-term effects on the local component suppliers of the Motor Industry Development Programme," he added.

Motor exports fetched R2,6m last year

Marcia Klein

BD 22/5/95

VEHICLE and motor component exports grew 37% to R2,6bn in last year, with components representing R1,9bn of the total and fully built up vehicles the rest. National Association of Automotive and Allied Manufacturers (Naacam) president John Brandtner said this growth indicated "the successful restructuring and productivity programmes" implemented by the component industry, which had concluded contracts all over the world.

Brandtner said component price increases were held below producer inflation, while vehicle price increases continued to exceed consumer inflation, largely

(192) because of the exchange rate exposure of the imported content of vehicles.

He called for the urgent replacement of phase six of the local content programme. The new programme should aim at making vehicles more affordable and improve economies of scale "to make SA's cars and components internationally competitive".

The new programme should also facilitate "significant exports of fully built up vehicles and components in the interests of earning foreign exchange and of preserving and creating employment".

Brandtner said the new programme should give the industry time to progress to a situation where the industry could stand up to global competition.

Customer service is the key

By JOHN SPIRA

GAUTENG BUSINESS EDITOR

New York — In order to survive, the South African motor industry will not only need to concentrate more on customer service, it will need to be obsessed by it

Thus concludes Chris Moerdyk, BMW SA's public affairs chief, after in-depth meetings with a range of American motor industry analysts and manufacturers

Following a presentation by the Pasadena-based JD Power customer research organisation, it was clear that those companies which went the extra mile in customer service were the most successful

According to Moerdyk "one does not have to spend more than an hour or two watching American television to see just how far motor companies and dealers go to make car purchasing a pleasurable rather than a traumatic experience"

Moerdyk notes that in America today, most car dealers will go to

the customer rather than languishing with their feet on the desk, waiting for the customers to approach to them

Cars are collected and delivered for servicing, salesmen keep in regular contact with their customers, and when problems do occur, service departments are obsessed with fixing them the first time

"Maintenance is also seen as an integral part of customer service," he said

"For example, when a customer buys one of America's current hot sellers, the Saturn, they receive a certificate guaranteeing service costs up to 50 000km

"BMW SA's recently-introduced five-year no-charge maintenance programme is a step in this direction

"With the South African motor industry becoming deregulated and with more and more foreign imports coming into the country and increasing foreign competition, any local motor company that

doesn't undergo a complete mindset change will simply not survive in what is bound to become a cut-throat car market"

Moerdyk says one of the reasons the American car buyer is so carefully nurtured is the existence of watchdog organisations such as JD Power, which carefully monitor industry service levels from every conceivable angle and then rate levels of customer satisfaction accordingly

He believes a similar watchdog body in South Africa would be of considerable benefit to the consumer here

It is also clear, says Moerdyk, is that South Africa's motor companies do not concentrate ardently enough on export orientation

"Those that fail to do so will go to the wall. There is no other option

"It is apparent from the structure of the American automobile environment that the motor industry is a global entity

"Any company that is not part of the world series isn't going to be in the game"

Moerdyk says the global nature of the car industry was emphasised by reaction to the United States' proposed punitive measures against Japanese car imports

"American motor industry analysts seemed unanimous in their condemnation of these measures, claiming that they were 'messing with free market forces'

"They felt US auto manufacturers were 'not playing the game' and expected the Japanese to accept US products that were not suited to their market

"For example, US cars exported to Japan were all left hand drive, while Japan was a right hand drive country"

Moerdyk adds that US analysts did not expect the punitive import duties to be implemented on due date (the end of June)

He said he believed compromises will be reached before then

ET(BR) 29/5/95 (192)

'Miracle' solution offered to ARG 1/9/94 car-makers 192

THE National Union of Metalworkers says it is offering employers a "miracle" proposal to end the motor workers' strike.

But Volkswagen managing director Peter Searle said today car workers were "playing a dangerous game" by changing their pay demand, while their attempts to claim the "moral high ground" in negotiations were "spurious".

Numsa said its negotiators had come up with a way in which employers could meet the union's 11 percent increase demand without spending more than the 10,5 percent they were offering.

The union proposed that employers suspend for a year their contributions to a fund — intended to provide training for retrenched workers — which now stood at R18 million and had never been drawn from.

The contributions worked out at almost 0,5 percent on the wage bill, Numsa said.

Mr Searle said "You don't negotiate on the basis that when the other party meets your demand, you are entitled to shift the goalposts

"As it is, the employers' offer is way above the inflation rate of 7,5 percent."

He said striking Volkswagen workers had lost R15 million in wages at the end of a full month's strike.

"In addition, 68 component supply companies in the Port Elizabeth-Uitenhage area have lost about R40 million because we did not place any orders for components in August."

Mr Searle said the prospects of recovery for these companies were dimming as the vast majority had no other business apart from their work for Volkswagen

In Port Elizabeth, talks aimed at breaking the five-week motor industry strike are continuing today

Numsa chief negotiator Gavin Hartford was optimistic that a settlement could be reached before the weekend.

There is general optimism that work at Delta and Volkswagen could be resumed on Monday

Mercedes Benz, whose workers were the only Numsa members to vote to end the strike, is to resume production on Monday.

Replying to Numsa's "miracle" offer, deputy-chairman of the Automobile Manufacturers' Employers' Organisation Harry Gazendam said the employers were not eager to stop their contributions to the Worker Security Fund.

Meanwhile, National Automobile Dealers Association chairman Ray Nethercott said today new and used motor dealers around the country stood to lose R2 billion in sales this month.

He also said dealers would start laying off employees on an increasing scale — Reuter-The Argus Correspondent.

Employers reject Numsa proposal

Talks resume in bid to end motor strike

BiDay 11/9/94

ATTEMPTS to resolve the five-week strike by 25 000 motor industry workers will resume today in talks between the National Union of Metalworkers of SA and manufacturers

Numsa welcomed yesterday's decision by the Automobile Manufacturers Employers' Organisation (Ameo) to reopen negotiations, as employers had previously indicated that they would return to the negotiations table only if workers accepted the 10,5% wage offer

However, Ameo vice-president Harry Gazendam did not hold out much hope last night for a quick settlement.

Numsa reduced its demand to 11% after an auto shop stewards' council meeting on Tuesday, but said the half-percentage point difference between its demand and the employers' offer could be "on the basic wage or in any other form which may result from negotiations"

The union said it had suggested an innovative way of closing the gap between the parties which would not add to employer costs while meeting the workers' bottom-line position

In terms of the latest proposal, employers would redirect their contributions from an industry work security fund into workers' pay packets for the contractual period. This fund contained about R18m for retraining retrenched workers. However, as the industry was in an expansionary phase, and had not spent any of these monies, suspending contributions for this year would be acceptable

Numsa said employers were committed to contributing 5c an hour per worker to

ERICA JANKOWITZ

the fund This had already been budgeted for as agreed to two years ago and did not come up for negotiation this year

Gazendam said employers would not entertain redirecting funds away from the work security fund as the introduction of Phase 7 would inevitably lead to job losses in the near future. (192)

"We are adamant we will not pay money to current employees at the expense of future retrenchees who will need some form of income and retraining when they lose their jobs," he said

The only concession Ameo would make would be to continue its contributions despite the fact that they were no longer contractually obliged to do so

The total estimated contribution to the fund was almost exactly the difference between the demand and the offer, Numsa said "In other words, we are offering to the employers a method of paying an acceptable increase without in fact spending any more money. Surely this is the kind of 'miracle' of which settlements are made."

Numsa said if agreement was reached within two days, it would discuss the basis of a settlement with shop stewards on Saturday and hold report-back meetings at plants on Monday. Production would be expected to resume after the meetings

Meanwhile, Mercedes-Benz SA said production at its East London plant would resume on Monday Talks with workers yesterday had decided that workers would hold discussions with union structures to

□ To Page 2

Motor strike

BiDay 11/9/94

□ From Page 1

clarify the issues, before meeting management again (192)

"The immediate priority will be to expedite the plans which were agreed to, to support MBSA becoming the most efficient motor manufacturer in SA by 1996 as required by Mercedes-Benz AG, Germany, and to satisfy our customers who have been so inconvenienced by the strike."

Numsa disputed this move, saying workers would report for work only once settlement was reached in the national dispute.

Meanwhile, MUNGO SOGGOT reports that the National Automobile Dealers' Association said the strike would wipe out R2bn in car dealer sales this month

Chairman Ray Nethercott said new and

second-hand car dealers were already laying off staff, while others could go out of business Nada's 1 700 members employed more than 60 000 people

He said this month's new vehicle sales would not amount to more than R500m, less than one third of average monthly sales of R1,6bn

While dealers had survived August because they had built up stock in July, turnover in used cars would fall to about R1bn from an average R1,5bn Spare parts volumes would drop to R300m for the month from an average of R500m. "The outlook for October could also be as bleak — and the cascade effects on bottom lines will assume disaster proportions"

Motor strike talks break down

BIDAY

ERICA JANKOWITZ

TALKS to end the five-week strike in the motor manufacturing industry broke down last night when employers refused to meet the National Union of Metalworkers of SA's (Numsa) final wage demand of 11%.

The Automobile Manufacturers Employers' Organisation (Ameo) rejected Numsa's proposal to redirect contributions from a work security fund and stuck to its 10,5% final wage offer, saying the current package was excellent and should have provided the basis for settlement.

Numsa accused employers of using the strike to rationalise the overtraded market saying "larger employers are bidding to be rid of their smaller competitors".

The union believed that some of the country's seven manufacturers were prepared to ride out the strike, using it as a method to send weaker employers to the

wall Those that survived would inherit a bigger share of the market

Commentators said the main mover of this strategy was Toyota, which had the biggest market share and sufficient financial resources to ride out the dispute

Mercedes-Benz, the highest payer in the sector, was also adamant that employers should not move from their 10,5% offer. Mercedes workers had reportedly accepted the offer and were preparing to return to work on Monday. (192) (192)

Numsa also accused employers of wanting to destroy the central bargaining-forum and "establish a ceiling on wage increases this year of not more than 10,5%"

Industrial relations consultant Gavin

□ To Page 2

Motor strike

BIDAY 2/9/94

□ From Page 1

Brown described the apparent split in employer ranks as an inevitable consequence of centralised bargaining, with employers naturally having differences in approach, strategic vision and affordability.

However, it was time for "decisive third party intervention" as the parties were clearly unable to resolve their differences using conventional strategies. (192) (192)

Numsa said its shop stewards' council would reassess the situation tomorrow.

Volkswagen MD Peter Searle entered the fray yesterday saying tariff protection for motor manufacturers would start being phased out from next year, and SA needed to look seriously at its global competitiveness as cheap imports would no longer be kept out artificially.

"We are already seeing signs of companies selling vehicles in SA which were

built by workers in other countries."

The industry's future was being threatened by imported models which were competitively priced, and the local industry had to gear up for new challenges.

"For that, we need a highly skilled, stable workforce driven not by short-term demands but by a longer-term vision of how this industry can prosper."

Searle said more than 100 000 people in the Eastern Cape were dependent on Volkswagen, directly or as workers and dependants of suppliers and dealers. Many companies faced run as the strike forced shut-downs and shorter working weeks.

"In Uitenhage, about 60% of our suppliers are already working short-time or with reduced workforces, and the figure for Port Elizabeth is even higher."

Auto employers reject plan

JOHANNESBURG — Negotiations to end the month-long auto industry strike failed again yesterday (192)

The Automobile Manufacturers Employers' Organisation (AMEO) rejected a National Union of Metalworkers of SA proposal that employers discontinue contributing to the National Work Security Fund and use the money to meet

CT 2/9/94
the union's 11% pay rise demand. The proposal was tabled at a meeting with employers in Port Elizabeth.

Numsa has indicated it will reassess the situation at a shop stewards' meeting on Saturday.

AMEO said in a statement it could contractually discontinue contributions to the fund — which now stands at R8 million —

but that this would be "irresponsible".

"While it is tempting to accept short-term initiatives in order to end this disastrous strike, AMEO cannot be party to this,"

Numsa said, however, its latest proposal would have enabled employers to meet the union's revised demand of 11% without extra cost — Sapa

Stalemate in auto industry

■ BY JOVIAL RANTAO
LABOUR CORRESPONDENT

Employers yesterday officially rejected the National Union of Metalworkers of South Africa's scheme to settle the five-week-old strike by 25 000 workers in the motor manufacturing industry

In its offer, Numsa suggested that manufacturers suspend their contributions to the worker security fund (WSF), with reserves of R18 million, for 10 months, to make up the 0,5 percent which is the current difference between the employers' offer (10,5 percent) and Numsa's demand (11 percent)

Harry Gazendam, vice-

Star 219/94
chairman of the Automobile Manufacturers Employers' Organisation (Ameo), said at yesterday's meeting that his delegation had reiterated it would not convert contributions to the WSF into a wage increase. The WSF was designed to assist workers who lost their jobs.

Gazendam said Ameo had also made a proposal to Numsa for a joint restructuring of the National Bargaining Forum to "avoid the crisis we have now, in future"

He said Numsa had undertaken to come back to employers with an answer to the proposal

In a statement, Numsa said Ameo's position had become one of principle and not cost

"They're clearly not primarily interested in resolving this dispute," the union said

Numsa said it believed that employers were now fighting for the following

■ The rationalisation of the market — the larger employers were trying to get rid of their smaller competitors

■ Smashing the centralised bargaining forum (192)

■ To establish a ceiling on wage increases this year of not more than 10,5 percent

The trade union said it would now reassess the situation at a shop stewards' council meeting to be held tomorrow. No further meetings were scheduled to resolve the wage dispute

Dispute may go into sixth week

Deadlock in strike talks

■ **HOPE FADES** Employers and the union no closer to an agreement:

HOPES of ending the motor industry strike before it drags into its sixth week faded yesterday with employers and the union emerging from talks no closer to an agreement.

Only half a percent on the annual increase is what separates the Automobile Manufacturers Employers' Organisation and the National Union of Metalworkers of SA, and with no talks scheduled hopes of resuming production early next week are slim. (1912) (1992)

Shop stewards are due to discuss the situation this weekend before report-back meetings with workers are held at nine car and truck plants around the country on Monday. The decision by workers at Mercedes-Benz to accept Ameo's 10,5 percent offer and to continue negotiations on the remaining half a percent once production has resumed is an indication of the feelings of some workers and will almost certainly feature at this weekend's talks.

In what has become a matter of principle, the half a percent the two parties are grappling over amounts to about R10 on individual workers' average monthly income.

Ameo vice-chairman Mr Harry Gazendam agreed after the talks that both parties were grappling over a negligible amount of money but said "It would be grossly unreasonable of employers after five weeks to now throw money at the problem."

"If we were going to do that we would have done it four weeks ago. It is not the solution to the problem."

He said the industry had already bumped its offer through the 10 percent ceiling.

Gazendam said Ameo rejected a Numsa proposal, to cut into contributions to an as yet unused job-security fund to fund the half a percent, as "shortsighted."

Numsa said in a statement the workers were the sole potential beneficiaries of the fund and it was their proposal to channel this year's contributions into the wage increase.

— Ecna.

VENTER LEISURE

A troubled year

fm 2/19/94

Activities: Makes and markets leisure and commercial trailers, components and spare parts

Control: Michael Katcs 46%

Chairman: Michael Katcs

Capital structure: 50,5m ards Market capitalisation R17,7m (192)

Share market: Price 35c Yields 18,3% on earnings, p e ratio, 5,5 12-month high, 80c, low, 15c Trading volume last quarter, 4m shares

Year to December 31	*'92	'93
ST debt (Rm)	nil	0,01
LT debt (Rm)	4,8	4,8
Debt equity ratio	0,01	0,16
Shareholders' interest	0,52	0,65
Int & leasing cover	n/a	47,4
Return on cap (%)	38,4	9,6
Pre-int profit (Rm)	+11,1	3,0
Earnings (c)	+18,5	6,4
Dividends (c)	+7,4	nil
Tangible NAV (c)	37,3	39,8

* 15-month trading period † Annualised.

It's not often that annual reports are reprinted for what turn out to be issues which have no material effect on the accuracy of the financial statements

In Venter Leisure (Ventel)'s case, events before — and after — the reprint of the 1993 report are just as unusual. Ventel shares were suspended on May 2 after the JSE's deadline for results was not met. Management argued that certain claims — including breach of the purchase against the original vendor of the company, Jasper Venter, were being prepared and this could affect results. Two days later, then chairman Pienkes du Plessis gave the press his own version of the events, which CE Michael Katcs promptly described as "highly selective, misleading and inaccurate". The company and Katcs subsequently sued Du Plessis for R1m for defamation.

On May 16, after a vote at a board meeting, Katcs took over as chairman. Du Plessis and Venter remained on the board. By month-end, the report was published and the share suspension lifted.

Venter and Du Plessis then contended that the report contained inaccuracies, that a paragraph on share capital should be added, in the executive review, the 1992 annualised income figure was incorrect (this has no effect on the comparative figures in the income statement), and a paragraph should be added indicating that Du Plessis and Venter have been selected by drawing lots to retire and are eligible for re-election. The report was reprinted at a cost of about R60 000.

Because of the increasing correspondence between attorneys acting for Katcs, Du Plessis and Venter, it soon became clear that Katcs would use his roughly 69%

COMPANIES

(192)

appointed the fourth director

Also on the meeting's agenda were the financial accounts. Turnover is not disclosed (though the Companies Act now requires its disclosure). However, the index provided indicates sales fell by a third. Attributable earnings plummeted almost 65%. Katcs contends the trailer market has been shrinking, competition has been increasing and the group has therefore increased advertising and new product development. He adds that "directors' salaries have hardly increased for three years" and a dividend was not declared last year even though he would be the largest benefactor of such a payout.

Either way, minorities cannot be too pleased. Katcs won't disclose the exact nature of the claims against Venter "until they are quantified," the disputes at board level could not have been conducive to effective management and, even more disappointing, is the slide in share price from 75c to 35c over the past year. *Kate Rushton*

fm 2/19/94
votes, this wasn't possible) in a board meeting after the AGM, Du Plessis and Venter resigned. Michael Levinsohn was

Venter Leisure

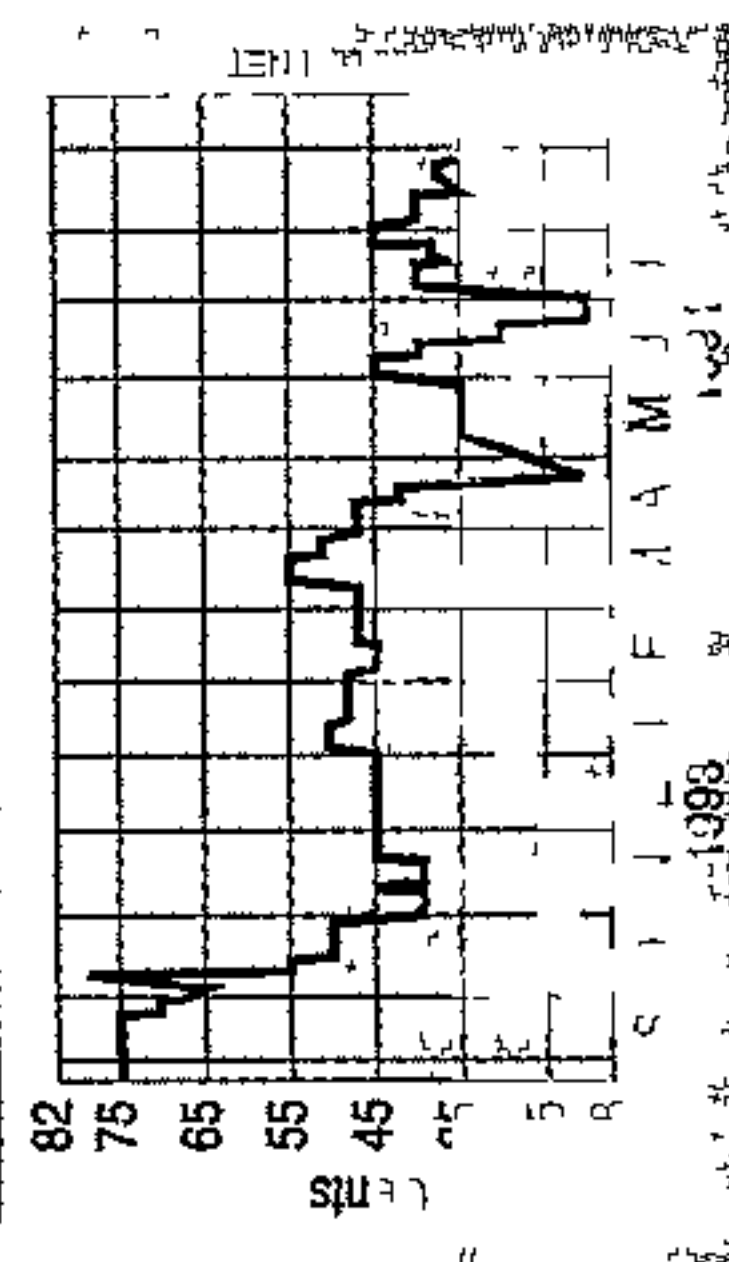

voting rights to ensure they were not re-elected. Venter and Du Plessis did not allow him this pleasure. Moments before a vote was taken at the AGM on August 19, they announced they would not stand for re-election.

However, a legal technicality made them withdraw this announcement. Katcs had to vote them back on the board at the AGM. (For a new director to be elected to form a quorum, four or more directors must vote. Without Venter's and Du Plessis'

D-Day today in car strike

Own Correspondent

PORT ELIZABETH. — A National Union of Metalworkers (Numsa) shop stewards meeting will decide today whether motor industry workers should accept the latest employer offer of 10,5% or prolong the five-week strike

Unions and employers failed to agree here this week when the Automobile Manufacturers Employers' Organisation (Ameo) turned down what Numsa termed a "miracle proposal"

The union proposed the manufacturers suspend for 10 months their contributions to the Work Security Fund to make up the difference between Ameo's 10,5% offer and Numsa's 11% demand

Ameo said it could not resort to short-term initiatives to end the strike

Yesterday Numsa chief negotiator Mr Gavin Hartford said it

Numsa to decide on offer by employers

was impossible to predict what would be decided

He said members could choose to sit out the strike or call it a day

Mr Hartford said indications that workers countrywide, particularly at Mercedes Benz in East London, wanted to return to work could not be seen as dissension in the union ranks

Meanwhile, ex-Ford workers yesterday appealed to the parties to reach a settlement.

In an urgent appeal, the Ex-Ford Workers Committee said

the strike should be resolved as a matter of "extreme urgency".

"This extended strike is crippling the Eastern Cape economy and causing vast unemployment and loss of income — the ex-Ford workers of Port Elizabeth wish to remind the East Cape of the large-scale suffering and unemployment caused by the Ford closure in 1980"

In a separate move, it was confirmed that National Association of Automotive and Component and Allied Manufacturers (Naacam) president Mr John Brandtner met Labour Minister Mr Tito Mboweni this week in a bid to end the strike

He said some smaller factories were facing closure

After the meeting, Mr Mboweni and Mr Brandtner called on the parties to negotiate a speedy solution

They said it was not the role of the government to dictate to the parties how the dispute should be settled nor should it be expected of the government to be the adjudicator

CT3/9/94

192 152

Car strike bites deep for many

**HENRI du PLESSIS
and PAT CANDIDO**
Weekend Argus Reporters

IT COULD take the South African motor industry up to a year to recover from the damage done by the nationwide strike by the National Union of Metalworkers

But, sources said, the real damage was the repercussions the strike had on lesser-known aspects of the industry.

Toyota's Brand Pretorius said "Obviously, it depends entirely on when the strike is going to end, but, at the moment, I would say an optimistic estimate of the time of recovery would be between six and eight months. Realistically, I would give it a year

"It depends on the union, whether they will be able to convince their members to work on a structured overtime basis to catch up, but it does not seem that there is a willingness to do that.

"So far, we have lost about 40 000 units at a rate of 1 600 a day over 25 days. The industry does not have an unlimited capacity either and if we have to

192 ~~132~~
■ Stoppages in the motor trade are into their fourth week and workers in vehicle production-related industries are feeling the pinch as many are forced to take unpaid leave. *ARG 3/9/94*

constantly wrestle with productivity, it is going to be difficult"

Mr Pretorius said the financial implications of the strike were hard felt in the components supply industry and especially among the smaller retailers

"These people have developed serious cashflow problems and the secondhand vehicle market has also felt the pinch, as trade-ins on new cars have dried up

"Parts are also becoming difficult to get and workshops have lost all the business of preparing traded-in cars for roadworthy and resale

"It will be very difficult to estimate how long it will take to get over that"

It would take a few days to get the industry up and running again after the strike had ended, said BMW's Deon Ebersohn

Any possibility of future exports also could have been harmed, as overseas buyers would not consider this country a reliable supplier

Meanwhile, component companies already have lost R500 million and could go into liquidation if the strike did not end soon.

The industry was losing R20 million a day, said Automobile Component and Allied Manufacturers Association executive director Denzil Vermooten.

He said 23 companies had closed, sending their workers on paid leave if they had any.

Those without any leave due were put on unpaid leave.

A total of 160 component manufacturers were involved and many were working only two days a week

But, Mr Vermooten was optimistic about the possibility of an agreement and said he believed workers could be back at their jobs by Tuesday

Officials of the Iron and Steel Workers' Union have begun to hand out food parcels to their members in Uitenhage. Many people complained they had no food and were unable to meet their commitments

Car import duties cut

THE customs duty on imported motor vehicles has been reduced from 100% to 80% and the 15% import surcharge has been scrapped as of yesterday, the National Association of Automobile Manufacturers of SA (Naamsa) confirmed.

The reduced duty applies to cars, light commercial vehicles, minibuses and other goods vehicles.

On cars, the duty reduction and surcharge removal amount to a re-

duction from 115% to 80% (192)

Toyota South Africa marketing managing director Mr Brand Pretorius said the duty cuts would encourage competition from low-volume imports, stimulating the local industry to become globally competitive.

But other industry sources, while welcoming the move, said it would have little impact on the man in the street or the local manufacturing industry — Staff Reporter, Sapa

Mercedes workers defy union

SITunes (Buss)

By DON ROBERTSON

THE 25-day strike by 25 000 motor assembly workers is showing the first signs of cracking, with employees at Mercedes-Benz prepared to break away from their union and return to work tomorrow.

Shop stewards at Mercedes-Benz met management this week, agreeing to accept the 10.5% wage offer and end the strike, despite claims by the National Union of Metalworkers of SA (Numsa) that all strikers would stick together until the 11% wage demand was met.

The Delta Motor Corporation plant in Port Elizabeth has effectively been open for about two weeks and the number of employees returning to work has been growing daily, says corporate communications manager Ed Emmett.

"With the publicity of the return to work by Mercedes-Benz employees, we hope it will improve the climate and encourage workers to exercise their right to work."

Members of the predominantly white Staal en Ysterunie have also accepted the offer and have agreed to resume working. An end to the crippling strike has now become essential following the announcement on Friday that import duties on cars and light commercial vehicles (LCVs) have been sharply reduced.

Import duties of 100% on cars and LCVs have been cut to 80% and the additional 15% surcharge on cars has been scrapped.

As the industry now faces increased competition from imported vehicles, it must do everything possible to reduce or at least maintain cost. It must also establish a stable labour force if it is to compete successfully in the international market. Further duty cuts are expected in the next few years.

Apart from the disruption to the industry, the enormity of the financial losses being experienced are now impacting directly on the economy. To date, the value of lost production amounts to R2.5-billion. Government has forfeited R500-million in VAT and other taxes and employees have lost R87.5-million in wages.

The level of lost production, heading towards 40 000 units, equates to about 0.5% of the gross domestic product (GDP) and manufacturers are now doubtful that production can be made up through overtime when workers do return to the plants.

As a result, economists are adjusting growth forecasts. Tony Twine of Econometrics says growth could fall to 2% from the projected 2.5%.

The R500-million lost in taxes is equivalent to 0.5%

of projected Inland Revenue of R105-billion for the current fiscal year and represents about 20% of the planned R2.5-billion to be spent on the RDP.

The talks between the Automobile Manufacturers Employers' Organisation (Ameo) and Numsa broke down again on Thursday after the union proposed that the 5c an hour paid by employers for each employee to the Work Security Fund be paid instead directly to workers. This would have made up the difference between the employers' wage offer of 10.5% and Numsa's demand of 11%.

The fund, with R8-million in the bank and as yet unused, was established to provide the retraining of employees who might be retrenched as a result of restructuring in the industry in the years ahead.

Ameo has refused to accept this option.

Numsa now accuses Ameo of standing on principle rather than on a matter of costs to the industry and of trying to break down the National Bargaining Forum (NBF).

Ameo vice-president Harry Gazendam, who has been at the forefront of negotiations with Numsa, concedes that manufacturers are becoming unhappy with the lack of progress being made through the NBF and would rather have wage issues discussed at individual plant level.

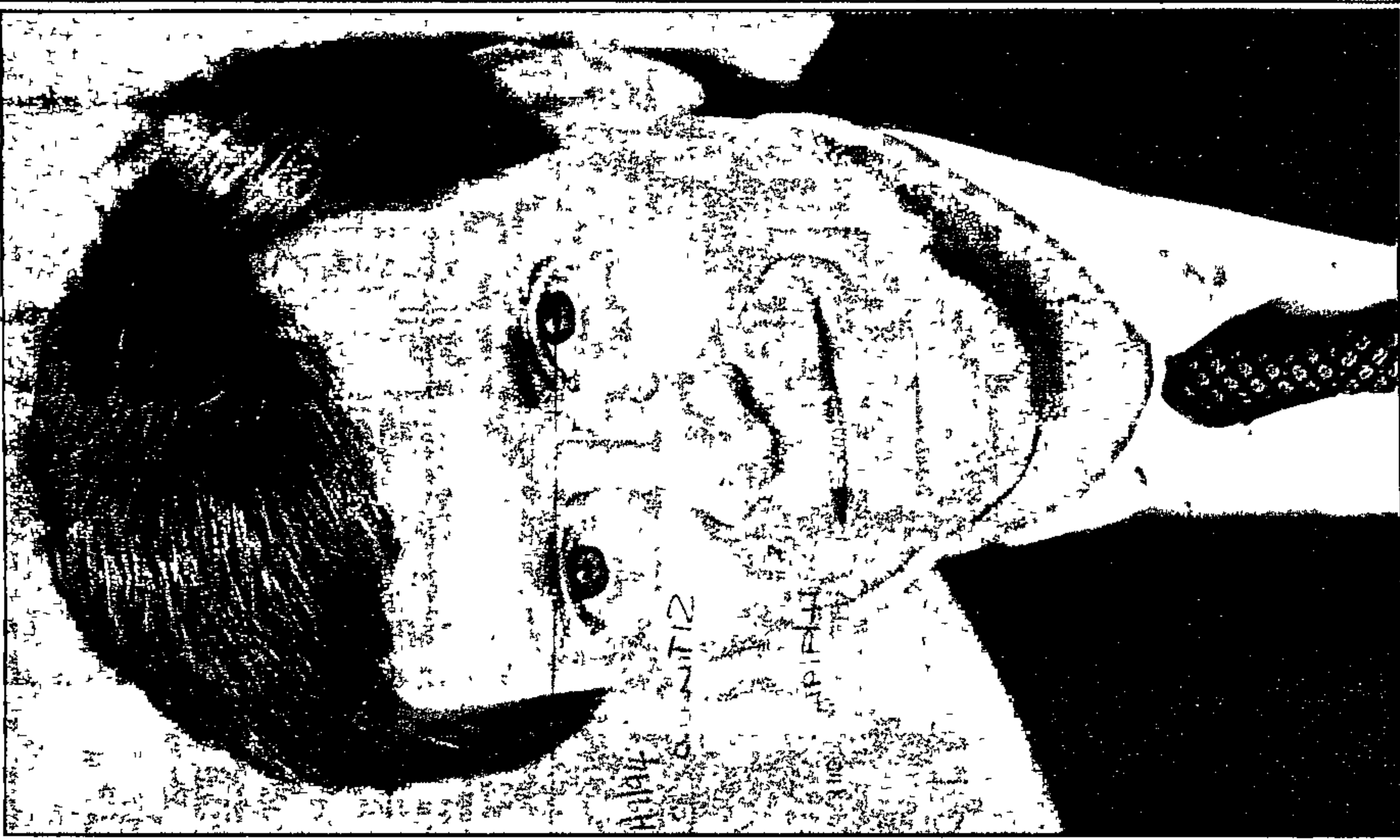

AT THE FRONT Harry Gazendam, one of Ameo's chief negotiators in the car strike

Motor union fumes over Manuel's cuts

SA Times 11/9/94

By RAY HARTLEY, EDYTH BULBRING and CIARAN RYAN

FURIOUS union officials have accused the government of meddling in the motor industry strike by slashing tariffs on imported cars.

In their fiercest attack yet on the new government, they claim the timing of the announcement — as the strike was set to enter its sixth week — was aimed at forcing the union to cave in.

Union officials say the tariff cuts announced on Friday could lead to the dumping of cheap cars from overseas on the local market, putting jobs under threat.

Trade and Industry Minister Trevor Manuel would be called to account at Cosatu's annual congress on Thursday, a senior official of the union federation said yesterday.

And National Union of Metalworkers of SA general secretary Enoch Godongwana said his union would ask Cosatu to back action against the tariff cuts.

The cuts were announced by Finance Minister Derek Keys in Friday's Government Gazette as the strike, which has brought South Africa's motor industry to a halt, ended its fifth week.

By scrapping a 15 percent surcharge and reducing import tariffs by 20 percent, the government has sent its strongest signal yet that labour and business must sort out their problems and make South Africa internationally competitive.

It follows Mr Manuel's refusal to subsidise the ailing textile industry.

The government has shielded the auto and textile industries from international competition by slapping tariffs and surcharges on imported fabrics and vehicles.

But in terms of the international trade agreement, the General Agreement on Tariffs and Trade (GATT), to which South Africa is a signatory, protective measures will have to be phased out. To compete, industries will have to find ways of cutting costs — including wage bills — and improving productivity.

An angry Mr Godongwana said he had met Mr Manuel on Wednesday.

"He never indicated anything about this. If he says he supports it, he is playing double standards," he said.

"Who is actually governing this country? Is it the government or the Board on Trade and Tariffs? This unilateral decision casts doubt about our participation in joint forums with government," Mr Godongwana said.

Mr Manuel has been invited to participate in a "question the leaders" panel at this week's Cosatu congress.

The Cosatu official said: "He will be taken to task on Thursday, if he turns up. He has not been consulting the unions, he has been missing meetings and appears to be pursuing an agenda of his own."

Addressing a business function in Johannesburg earlier this week, Mr Manuel said: "Sadly too many of our industries have become averse to change."

"Hence my simple statement — that protection on

To Page 2

From Page 1

demand is dead for all time — unleashed such a storm in some quarters," he told the Business Day Business Achievers Award banquet.

Mr Keys's private secretary Nicholas Mason-Gordan said yesterday that Mr Keys, who administers the Customs and Excise Act, had implemented the changes on the recommendation of Mr Manuel.

Neither Mr Manuel nor his spokesmen could be reached for comment yesterday.

The gap in wage talks between Numsa and automobile manufacturers remained a scant half a percent this weekend following a week of unsuccessful bargaining.

Employers have increased their offer to 10.5 percent, while Numsa wants 11 percent.

Motor industry expert Tony Twine of Econometrix said the reduction in tariffs on imported vehicles should enable car importers to drop prices by about 18 percent — "provided they pass on the full benefit to the consumer".

However, prices could drop even more dramatically next year if the Board on Tariffs and Trade implemented proposals to drop tariffs to 50 percent, phasing down to 30 percent by 2003, he said.

"The reduction will not have a dramatic impact on prices of imported cars, but begins to put pricing pressure on local car assemblers," said Mr Twine.

Alfa Romeo importers ICC Cars dropped its prices 15-20 percent last month. Managing director Lars Fischer warned that the weakening rand could offset the pricing benefits to a degree.

Most importers anticipated the lower tariffs in announcing price reductions on a range of models several weeks ago.

SA imports Alfa Romeo, Volvo, Hyundai (in a partly knocked-down form), some Mercedes-Benz models and luxury cars such as Rolls Royce and Porsche.

Govt denies tilt at union

CT 5/9/94

(192) (152)

JOHANNESBURG — The Ministry of Trade and Industry yesterday denied suggestions that its decision to reduce tariffs on imported cars was to pressure striking motor industry workers

The ministry was reacting to a report in a Sunday newspaper that confrontation was looming between the government and striking members of the National Union of Metalworkers of South Africa over the reduction of import tariffs

The Sunday Times said union officials were determined to meet Trade and Industry Minister Mr Trevor Manuel to clarify the government's action

Trade unionists were quoted as

Strife over car import tariff cuts

saying the cuts could jeopardise jobs because cheap vehicles from overseas could be dumped on the local market

Outgoing Minister of Finance Mr Derek Keys on Friday announced the scrapping of a 15% surcharge and the cutting of import tariffs by 20%

The Ministry of Trade and Industry said in a statement the

request for tariff reduction was communicated to the minister as a mandated position from the entire automobile industry through the agency of the Motor Industry Task Group (MITG)

"Numsa has been represented in this body and we are informed that the tariff reduction was a consensus view of MITG"

The statement said the matter had been disposed of before the present strike

"Suggestions that the decision was unilateral by the minister, or that it was timed to apply pressure on the union during the strike are therefore not true," the ministry said

The Sunday Times said Cosatu would question Mr Manuel on the matter on Thursday — Sapa

New plan for car ⁽¹⁹²⁾ ~~(192)~~ strikers

CT 5/9/94
JOHANNESBURG

New proposals to end the motor industry strike would be submitted to workers at all relevant plants today, the National Union of Metalworkers of South Africa said in a statement at the weekend.

This was a sequel to Numsa's meeting of auto shop stewards here to review the strike.

The trade union did not release details of its proposals, but it added that the striking workers would have to make the final decision.

The report stated that there were positive indications that the strike could be ended soon. New and used motor dealers around the country fear they could lose R2 billion from the strike — Sapa

ARG 5/9/94

Strikers look ready to settle

The Argus Correspondent
and Argus Bureau

JOHANNESBURG. — Most of the 25 000 striking motor workers at seven plants seemed to be in favour of accepting the 10,5 percent increase they had been offered, industry sources said today.

The National Union of Metalworkers (Numsa) today held report-back meetings to put forward recommendations concluded at a National Auto Shopsteward Council meeting in Johannesburg on Saturday

While Numsa would not disclose the decision taken by the 60-member shop stewards council, The Argus has been told the shop stewards decided to recommend settlement to the Numsa members. The union is expected to announce the workers' decisions at a press conference today.

Workers have been demanding an 11 percent increase.

Meanwhile, the union is furious at a government decision to scrap a 15 percent import surcharge and a cut in import tariffs from 100 percent to 80 percent.

The union has accused Trade and Industry minister Trevor Manuel of trying to pressurise strikers to settle.

Motor sector looks inwards

CT 6/9/94 (192) (10)

Own Correspondent

JOHANNESBURG — The prolonged strike in the motor assembly sector has brought centralised bargaining starkly into the spotlight, with many commentators blaming the system for some elements of the dispute

Currently all seven major manufacturers bargain wages and conditions of employment annually in the national bargaining forum. Two unions — the Cosatu-affiliated National Union of Metalworkers and the SA Confederation of Labour-affiliated SA Iron, Steel and Allied Industries Union — are the other parties to the forum.

The forum was established a few years ago at the insistence of Numsa in line with Cosatu's stated aim of establishing centralised bargaining structures in all major industries.

Numsa wants to take this a step further and include component and tyre manufacturers under the same umbrella, but employers have rejected this move.

Central bargaining under spotlight

Automobile Manufacturers Employers' Organisation vice-president and chief negotiator Mr Harry Gazendam believes the forum has outlived its usefulness in its present form.

Employers want three bargaining levels. Nationally, a tripartite body to negotiate labour policy, industry-level negotiations to establish fair and equitable minimum standards, and at plant level some profit-sharing agreement.

Mr Gazendam said this was not

the same as two-tier bargaining in which unions settle minimum standards at industry level and then negotiate separately at plant level to improve wage rates.

Employers within the forum will not disclose results because they are competitors. Mr Gazendam says the forum bundles seven fierce competitors into a single structure with the inevitable "fudged response".

Numsa national organiser Mr Gavin Hartford rejects the employer response, saying setting minimum standards would mean most members would not be affected by any industry-level agreement as there are vast disparities between the highest- and lowest-paid workers in the sector.

Mr Hartford says the union has pushed employers for a stand on bargaining levels for the past three years and has only received a coherent position since the strike pushed the issue to the forefront.

This, and other issues, will be negotiated in resumed dispute meetings this week.

'Motor industry accord by ¹⁹²~~192~~ ARU 6/19/94 Friday'

JOHANNESBURG. — — The National Union of Metalworkers of South Africa (Numsa) has said workers have decided to return to work this week to avert a total collapse of the motor industry, and expect a settlement by Friday.

The strike has caused losses to the industry of more than R2,5 billion, with workers sacrificing about R95 million.

"Most plants have agreed to return tomorrow on the basis of a recommendation by the national shop stewards council who met on Saturday," Numsa's general secretary Enoch Godongwana said.

He said last week's cut in tariffs on imported cars had been one of the reasons for the decision to return to work.

"This was not the main reason that affected our decision but is one of them.

"We are critical of its timing in the sense that we were in the middle of a dispute in the industry and its implication was therefore, in our view, intended to influence the strike."

The 25 000 union members would return to work while the union and employers continued to discuss their demand for an 11 percent wage increase. Management is offering 10,5 percent.

The union said employers had turned the strike into a power struggle among themselves. "We needed to review our strike and look at whether we are bleeding the industry in the interest of a few employers who wanted to make sure that some of the weaker ones would sink," Mr Godongwana said.

He said it had become clear to the union that the strike was not about employer affordability but a power struggle in industry rationalisation.

For some employers the aim was to destroy the bargaining system and replace it with plant level bargaining.

"This is not likely to succeed," Mr Godongwana said.

The union said a settlement should be reached with the Automobile Manufacturers Employers' Organisation by Friday. — Reuter.

Strike spotlights bargaining system

BIDAY 6/9/94

ERICA JANKOWITZ

THE prolonged strike in the motor assembly sector has brought centralised bargaining starkly into the spotlight, with many commentators blaming the system for some elements of the dispute.

Currently all seven major manufacturers bargain wages and conditions of employment annually in the national bargaining forum. Two unions — the Cosatu-affiliated National Union of Metalworkers of SA and the SA Confederation of Labour-affiliated SA Iron, Steel and Allied Industries' Union — are the other parties to the forum.

The forum was established a few years ago at the insistence of Numsa in line with Cosatu's stated aim of establishing centralised bargaining structures in all major industries.

Numsa wants to take this a step further and include component and tyre manufacturers under the same umbrella, but employers have rejected this move.

Automobile Manufacturers Employers' Organisation vice-president and chief negotiator Harry Gazendam believes the forum has outlived its usefulness in its current form.

Employers want three bargaining levels nationally a tripartite body to negotiate labour policy, industry-

level negotiations to establish fair and equitable minimum standards, and at plant level some profit-sharing agreement.

Gazendam stresses this is not the same as two-tier bargaining in which unions settle minimum standards at industry level and then negotiate separately at plant level to improve wage rates.

Employers within the forum will not disclose results because they are competitors. Gazendam says the forum bundles seven fierce competitors into a single structure with the inevitable "fudged response".

Numsa national organiser Gavin Hartford rejects the employer response, saying setting minimum standards would mean most members would not be affected by any industry-level agreement as there are vast disparities between the highest- and lowest-paid workers in the sector.

Hartford says the union has pushed employers for a stand on bargaining levels for the past three years and has only received a coherent position since the strike pushed the issue to the forefront.

This, and all other issues, will be negotiated with the resumption of dispute meetings this week.



Numsa sticks to 11% demand

Strike in motor sector is suspended

B/Day 6/9/94

THE National Union of Metalworkers of SA (Numsa) yesterday suspended the strike by about 25 000 motor assembly workers and said production would resume tomorrow. However the union has not accepted manufacturers' offer of a 10,5% wage increase and negotiations will continue.

Numsa general secretary Enoch Godongwana said workers had accepted a recommendation by the auto shop stewards' council to resume production pending the outcome of further negotiations aimed at getting employers to agree to workers' 11% demand.

Automobile Manufacturers Employers' Organisation (Ameo) vice-president Harry Gazendam welcomed workers' decision to return to work, although Ameo had not received formal notification by late yesterday. However, he said employers were not prepared to negotiate further and their "position is well known".

Negotiations broke down last week with the parties separated by half a percentage point as Ameo refused to budge from its final offer.

Godongwana said the union had been mandated to conclude an agreement by Friday and its trade-off proposal was still on the table. In terms of this proposal, Numsa suggested employers divert contri-

ERICA JANKOWITZ

butions from a work security fund to pay packets for the contract period to make up the difference between the two positions.

Ameo rejected Numsa's proposal, saying the fund would be used to retrain those workers who would be displaced by the introduction of Phase 7 of the motor industry task group's proposals and tariff reductions announced last week.

Cosatu general secretary Sam Shilowa yesterday condemned Trade and Industry Minister Trevor Manuel's move to slash tariffs on imported vehicles, calling it ill-timed and unilateral. Although Cosatu was committed to SA's position on the GATT proposals, Shilowa said proper consultation with all parties was required.

Godongwana said workers had made significant gains from the strike, including winning a 10,5% increase on actual wages when employers' pre-strike position had been 9% on average wages. A comprehensive adult basic education agreement had also been conceded by employers, the first such industry-wide agreement.

Yesterday's planned opening of the Mercedes-Benz plant in East London was thwarted after workers attended a report-back meeting at which the shop stewards'

□ To Page 2

Motor strike

decision was discussed, a company spokesman said. Although "an overwhelming majority of workers was ready to start production", the decision to continue the strike until tomorrow was adhered to.

Delta Motor Corporation was "encouraged" by Numsa's decision, as normal production would be scheduled from tomorrow. "The challenge now is to schedule maximum production in an effort to offset units lost over the past weeks."

However, Gazendam said it would probably take about 12 months to make up for all production losses during the 27-day strike. Some sales had been permanently lost to second-hand or imported vehicles.

Godongwana described the strike as "the longest and costliest industry-wide strike in the history of the motor manufacturing industry worldwide".

By the end of last week, employers said more than R3bn in turnover had been lost.

● See Page 5

B/Day 6/9/94 □ From Page 1

Motor strike comes to an end

Sowetan 6/9/94

By Lulama Luti
Political Staff

THE five-week-old strike by 25 000 members of the National Union of Metalworkers of South Africa has ended

Numsa members resolved to resume work tomorrow after accepting a recommendation by the union's national shopstewards council which met in Johannesburg at the weekend

Addressing a Press conference in Johannesburg yesterday Numsa general secretary Mr Enoch Godongwana said the union was suspending the strike pending the satisfactory conclusion of talks on the union's demands by Friday.

While Numsa demanded an 11 percent increase, management's final offer stood at 10,5 percent. The strike, which brought the motor industry to a standstill, cost the manufacturers R3 billion

while workers lost about R70 million in wages

Godongwana said the workers would return to work in victory after achieving — among other things — a five-year education and training programme which would improve the numeracy and literacy of members in the industry

However, he declined to divulge how much workers had lost in wages, saying that "normally, when we go on strike we calculate what we want and not our monetary losses. The bosses will do that for us" (192) (3)

Another factors which led to Numsa's decision to call off the strike included the imminent closure of smaller car manufacturers — which would have resulted in loss of jobs, said Godongwana

The Numsa concession also came in the light of a Government decision to reduce tariffs on imported cars

Auto industry gets back in gear today

PAT CANDIDO
The Argus Bureau

192
PORT ELIZABETH — People massed outside the Eastern Cape's motor manufacturing plants early today as strikers began returning to work after a crippling six-week strike, and others queued for new jobs

Production was resumed today at all motor manufacturers except Volkswagen in Uitenhage, where work will begin tomorrow. The National Union of Metalworkers of South Africa (Numsa) asked for an extra day to brief members who were unable to attend briefings on Monday

But not all strikers are happy about returning to work today. Tensions within the industry are expected to remain high because some members believed the union had given in to "pressure from the government"

They felt that the decision to reduce tariffs and duties on imported vehicles had influenced the decision to end the strike.

In fact, Numsa was on the Motor Industry Task Group that recommended the tariff cut.

ARLT 7/9/94

Car production lines rolling

Own Correspondent

PORT ELIZABETH — Most workers in the motor industry returned to work today — bringing to an end the longest national motor industry strike in the country's history

Against this background Delta Motor corporation has announced that it will employ an extra 400 people to man a second shift producing car bodies

Human resources director Mr

George Stegmann said the recruitment drive was based on a strategic decision taken before the five-week motor industry strike

However, at Volkswagen in Uitenhage, workers will hold report back meetings today — and are only expected to report for normal duties tomorrow

Meanwhile, the National Union of Metalworkers and the Automobile Manufacturers Employ-

ers Organisation have yet to settle the current wage dispute

Announcing the end of the strike, the union said its members' demand for an 11% increase still stood, despite the employers' 10,5% final offer

However, sources within the motor industry have indicated that an agreement could be signed tomorrow with the union accepting management's lower offer

CT 7/9/74

(195) (15)

Auto industry gets back in gear today

ARG 7/9/94

(192) ~~192~~

PAT CANDIDO
The Argus Bureau

PORT ELIZABETH — People massed outside the Eastern Cape's motor manufacturing plants early today as strikers began returning to work after a crippling six-week strike, and others queued for new jobs

Production was resumed today at all motor manufacturers except Volkswagen in Uitenhage, where work will begin tomorrow. The National Union of Metalworkers of South Africa (Numsa) asked for an extra day to brief members who were unable to attend briefings on Monday.

While Delta began its bid to offset the millions of rands lost in turnover during the strike, management estimated it would take at least 18 months to recover.

But not all strikers are happy about returning to work today. Tensions within the industry are expected to remain high because some members believed the union had given in to "pressure from the government."

They felt that the decision to reduce tariffs and duties on imported vehicles had influenced the decision to end the strike.

In fact, Numsa was on the Motor Industry Task Group that recommended the tariff cut.

Volkswagen workers delay return

JOHANNESBURG. — Strikers at the Volkswagen plant in Uitenhage will only return to work on Monday. (192)

This was despite National Union of Metalworkers of South Africa members returning to work at six vehicle manufacturing plants nationwide yesterday.

ET 81 9/94
Volkswagen human resources director Mr Brian Smith said some workers

seemed unhappy about the union's decision to return to work.

He criticised what he called the undisciplined behaviour of a small group of union members, describing it as a worrying trend.

VW would lose another 750 vehicles because of the late return to work.

Earlier, a VW spokesman said the company had lost R350 million. — Sapa

Strike action scarcely dents August car sales

Start 8/19/94

BY CLAIRE GEBHARDT

August car sales dipped only marginally, despite widespread industrial action, figures released by the National Association of Automobile Manufacturers (Naamsa) show

Manufacturers and economists yesterday attributed the better-than-expected sales — 0,8 percent down on July — to the underlying strength of demand and high levels of build-up inventories

September sales, however, could show the full effect of the strike, they warned.

Toyota MD Brand Pretorius predicted figures could be as much as 40 percent down in September

Car sales in August of 16 805 units were 132 units down on July's figure

Compared with August 1993, sales were 4 percent, or 704 units, down

Econometrix's Tony Twine said buyers appeared to have been less selective when it came to colour and, in marginal instances, even makes when faced with long waiting lists.

He cautioned that the real effects of the strike would show up in September

"As much as four weeks' stock must have been in the pipeline between factory and retail outlet to have provided for so many sales"

Inventories had now been reduced to very low levels and sales would depend on how soon supplies could be replenished

Twine said that by the end

of last week, the fifth week of the strike, just over 0,5 percent of gross domestic product (GDP) and 0,5 percent of fiscal revenue had been lost

Naamsa said there had been practically no production since August 1 and that sales in September would reflect the adverse impact of the strike

Negative effects would be felt for months to come, though manufacturers would implement contingency plans to boost output to make up for losses

"This will, however, depend on the achievement of stability and a commitment by employees to work additional time"

(1992)

Sales of light commercial vehicles (LCVs), bakkies and minibuses at 8 144 units showed a decline of 320 units, or 3,8 percent, compared with the same month a year ago

Compared with July 1994, LCV sales of 9 711 units showed a more marked decline of 1 567 units (16,2 percent)

Sales of medium and heavy trucks reflected a mixed performance, falling by a marginal 0,9 percent (3 units) in the case of medium commercial vehicles and rising by 81 units, or 18,9 percent, in the case of heavy trucks, compared with August last year

Naamsa said original forecasts of a new car market of 200 000 units for 1994 as a whole, and a market of 102 500 light commercial vehicles were unlikely to be achieved

Sales would at best only slightly exceed 193 666 cars and 96 534 LCVs

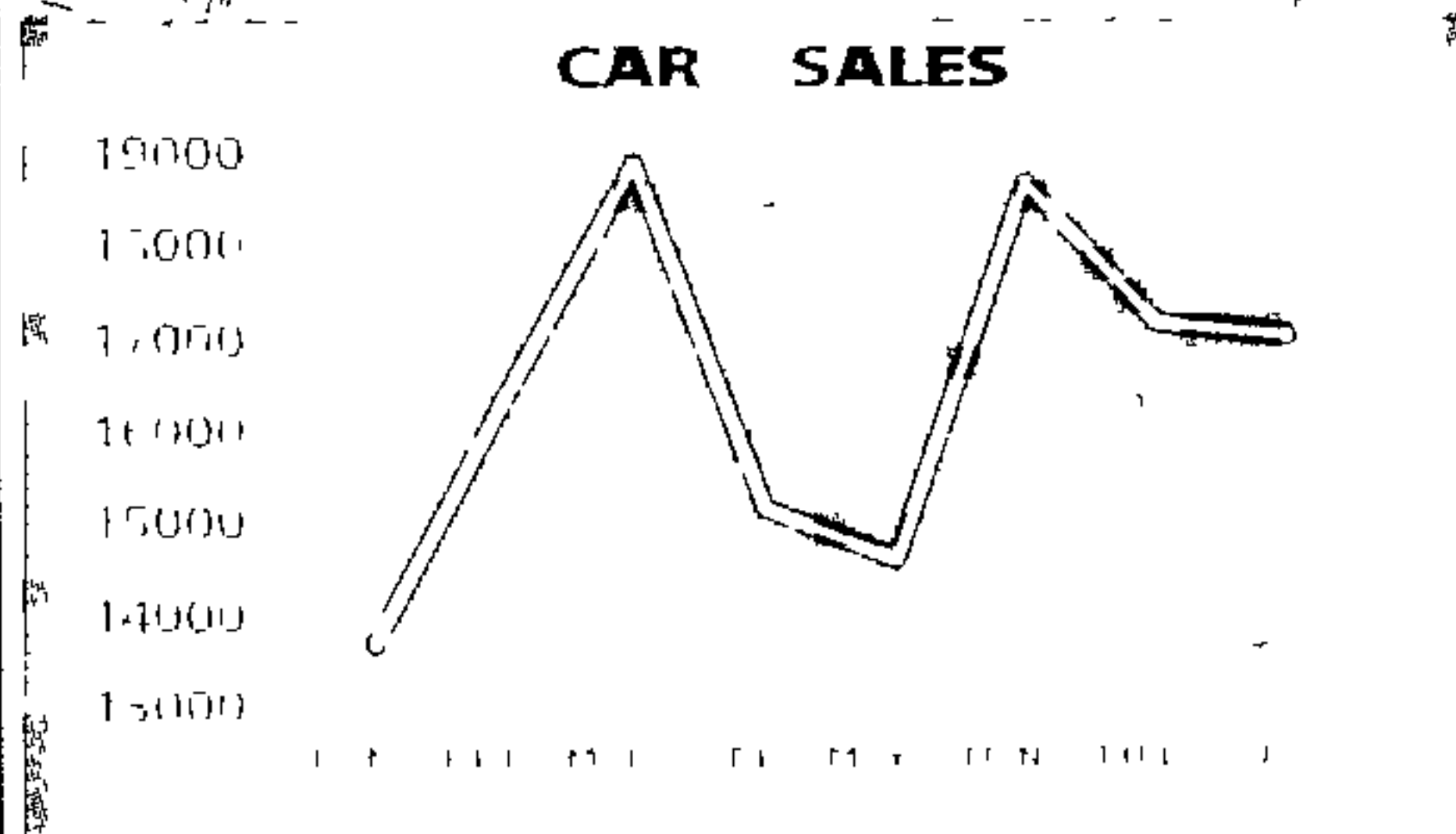

Car sales: The calm before the storm

192 ~~192~~

CT 8/9/94

By AUDREY D'ANGELO
Business Editor

NEW car sales in August slipped by only 0,8% to 16 805 compared with 16 937 in July, despite the weeks long strike by Numsa members. But sales of light commercial vehicles were down by 16,2% to 8 144 (9 711).

The National Association of Automobile Manufacturers of SA (Naamsa) explained yesterday that sales had been from manufacturers and retailers' stocks and the effect of the strike would be shown in September sales figures.

Manufacturers are hoping to catch up with some of the lost production. But Naamsa director Nico Vermeulen warned yesterday that the impact of the strike was likely to be felt "for months to come".

Meanwhile the extent to which Korean manufacturer Hyundai has penetrated the SA market is unknown. It does not belong to Naamsa, or divulge sales volumes.

Its vehicles sell in SA for between R60 000 and R120 000.

Meanwhile, Japanese motor manufacturer Nissan was considering setting up a joint venture manufacturing base in SA, its SA franchisor said yesterday.

The company — Japan's second largest car maker — had held talks with Nissan

SA about a possible joint venture entry, marketing MD Stephanus Loubser said.

Samcor, which is negotiating Ford's re-entry into SA, said its talks stemmed from similar considerations.

One executive who asked not to be named said "Everyone expected a period of labour turbulence in SA following the election. Foreign manufacturers who get in now will be on the ground floor for future growth."

"SA manufacturing facilities are sophisticated and capable of supplying export markets."

The figures released by Naamsa yesterday showed new car sales in August were 4% below the 17 509 sold in August last year.

Sales of light commercial vehicles were 3,8% below the 8 464 sold last August.

Car sales between January and August this year totalled 128 270 compared with 129 525 in the same period in 1993.

Sales of light commercial vehicles between January and August stood at 67 313 (64 495).

Toyota remained the market leader in August with sales of 3 423 new cars and 2 620 light commercial vehicles.

But Mercedes Benz moved up to second place with sales of 3 105 cars of which

1 273 were Honda Ballade and 1 586 Mercedes W 202 series following its launch.

Volkswagen was in third place with sales of 2 866 cars. Samcor sold 2 759, Nissan 1 851, Delta 1 751 and BMW 1 049.

Toyota Marketing (SA) MD Brand Pretorius forecast that September car sales could be 40% lower than August.

He said shortages of stock in August had distorted the market. "Perhaps the biggest single distortion came with a high availability of the new C Class Mercedes Benz which was launched with a high dealer stock level at the outset of the strike."

He said the supply situation should improve around September 20. "The industry will be hard pressed to deliver more than 190 000 passenger vehicles during 1994 — although this could be exceeded if there is a strong commitment by workers."

Admitting that the lowering of import duties and tariffs could have an effect on sales, Pretorius said this was not likely to have any impact on the high volume sector.

John Cuming, director of sales and marketing at Delta Motor Corporation, said full year results would be determined by supply and not demand. He believed passenger vehicle sales would be down marginally on 1993. Commercial vehicle sales were likely to be ahead.

August car sales beat expectations

BiDay 8/19/94

MICK COLLINS

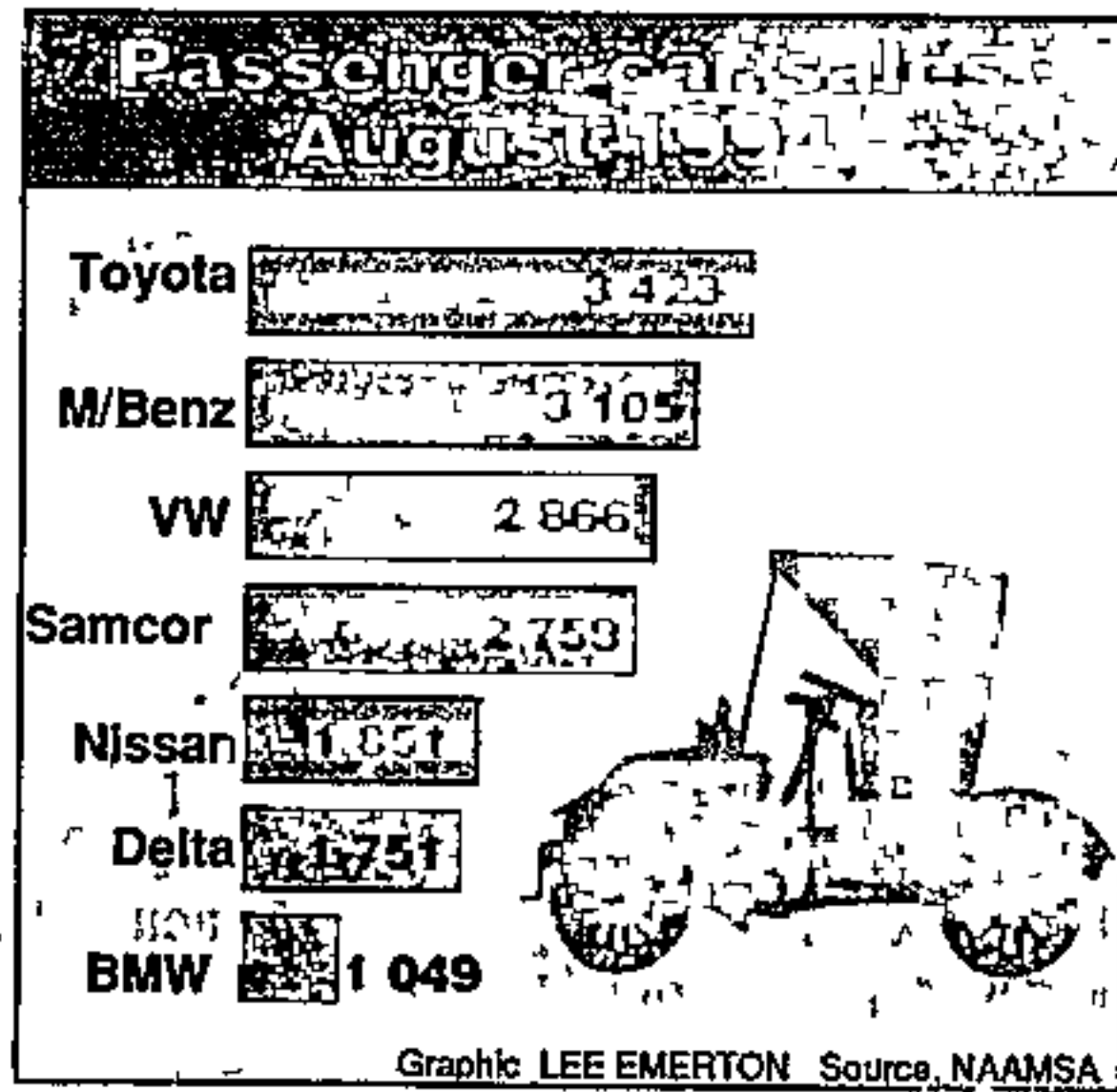

NEW car sales for August were better than expected despite the effects of the prolonged motor industry strike, the National Association of Automobile Manufacturers of SA (Naamsa) said yesterday

Sales for the month came in at 16 805 units, 4% down on the corresponding period last year when 17 509 units were sold Compared with July's 16 937 units, August sales were marginally down (192)

But Naamsa warned that with no production since August 1, September sales figures would show the effect of the five-and-a-half week strike.

To Page 2

Car sales

BiDay 8/19/94

From Page 1

Industry sources said dealer stocks were "virtually exhausted" and September sales could be down by as much as 40% (192)

The biggest single distortion came with a high availability of the new C Class Mercedes-Benz which was launched with large dealer stock levels at the outset of the strike A Mercedes-Benz SA spokesman said the company had achieved record sales of 3 105 units, placing it second on the industry log behind Toyota which had sales of 3 423 units. But September sales were expected to fall below 10 000 units for the entire industry

One source said there were anomalies that suggested buyers took what they could get, rather than risk missing out on a new vehicle This was particularly evident in the emergency replacement (accident and theft) markets

Naamsa said sales levels had been supported by the inventory pipeline of units at manufacturers' stock yards and at retail level The total inventory pipeline accounted for three to six weeks of retail sales and this had supported the generally better than expected new vehicle sales

Sales of new light commercial vehicles fell by 1 567 units or 16,2% compared with July's 9 711 units

Naamsa said that despite most assembly plants resuming production yesterday, the strike's effects would be felt for months Original forecasts of a new car market of 200 000 units this year and a market of 102 500 light commercial vehicles were unlikely to be achieved

Provided the industry succeeded in making up a portion of the lost production over the remainder of the year, Naamsa predicted that at best annual sales would only slightly exceed 1993 levels

Sapa reports that while National Union of Metalworkers of SA members returned to work at six vehicle manufacturing plants countrywide yesterday, Volkswagen strikers in Uitenhage would go back only on Monday.

Volkswagen human resources director Brian Smith said some workers seemed unhappy about Numsa's decision to return to work Another 750 vehicles would be lost because of the late return

All six manufacturers said talks with the union on how to make up production losses had started or would begin soon Automobile Manufacturers Employers' Organisation deputy director Harry Gazendam said technically the strike had not been settled as no agreement had been signed

August car sales dip slightly

Business Staff

(192) ART 8/9/94
AUGUST car sales dipped only marginally, in spite of widespread industrial unrest — but next month's sales figures should show the full impact of the prolonged strike in the industry

Figures released by the National Association of Automobile Manufacturers (Naamsa) show car sales in August of 16 805 units, down about one percent or 132 units on July's figure

A year-on-year comparison with August, 1993, shows sales four percent or 704 units down

Manufacturers and economists yesterday attributed the better-than-expected sales to the underlying strength of demand

September sales, however, could show the full effect of the strike, they warned, with Toyota predicting that sales figures could be as much as 40 percent down

Econometrix's Tony Twine said buyers appeared to have been less selective when it came to colour and, in marginal instances, even makes when faced with long waiting lists

Negotiations end auto strike

Own Correspondent

JOHANNESBURG — Weeks of tedious negotiations and deadlocks came to an end last night when the National Bargaining Forum agreed to a 10,5% across-the-board increase for motor industry workers

And Volkswagen South Africa said yesterday it had

successfully negotiated with Mainland China to reschedule the rest of its multi-million rand export order which was badly affected by the five-week strike

Despite last minute wranglings over details of the agreement, relieved delegates emerged at 7pm last night at Midland Chamber of Industries' premises, triumphantly

producing a signed settlement

The dispute has centred on the discrepancy between the employers' offer of 10,5% and the union's demand for 11%

Initially employers offered 10% and the unions lowered their demand to 10,5% which was refused at the time

Delegates from the National Union of Metalworkers, Automobile Manufacturers Em-

ployer's Organisation and Iron and Steel Worker's Union signed the document.

Most striking workers went back to work on Wednesday. Volkswagen workers will return on Monday

The increase will be backdated to July

Some low-paid employees will get a 12,5% raise

CT 9/9/94

(192)

More cuts for car import tariffs

S/Times (Buss)

11/9/94

A GOVERNMENT plan for the motor industry proposes slashing import tariffs to 65% next year from 80% at present and phasing them down to 30% over eight years.

This could mean dramatic reductions in car prices next year. Although duties would fall to 65%, luxury cars could be imported duty-free by companies with strong exports — every R1 of exports generates an equivalent duty-free allowance.

This could mean price reductions of up to 30% in top-of-the-range vehicles. On average, car prices should drop by 7% immediately, although lower priced vehicles will not be affected in the first year.

Last week the government

By CIARAN RYAN

dropped import tariffs on vehicles to 80% from 100% and abolished the 15% import surcharge. Most motor assemblers announced price reductions this week in response to the lower tariffs. (92) (11)

The Board on Tariffs and Trade proposal throws out many of the recommendations of the Motor Industry Task Group which called for punitive duties on low-volume production vehicles in order to reduce the range of models manufactured.

The plan scraps controversial aspects of Phase VI of the local content programme which saw manu-

facturers pushing up the price to satisfy local-content regulations.

The new plan offers an additional duty rebate incentive of 25%, phasing to 16% over eight years, for assemblers. Manufacturers who achieve 50% local content will not pay duty on component imports.

The board's plan will result in fewer models being produced locally as it becomes cheaper to import them. The models most likely to go are the BMW 5 and 7 series, Nissan Maxima, Opel Rekord, Mitsubishi Pajero, Audi, Mercedes Benz E and S classes, the Toyota Landcruiser and other models with sales of less than 2 000 a year.

The plan is designed to have a neutral impact on the balance of

payments by exempting component and vehicle imports from duties for companies able to show an equivalent export value.

South Africa produces 42 models, a market of some 300 000 units a year. This means the average size of production runs is 7 000 a year — one of the world's lowest.

Studies show most motor manufacturers did not use the full 115% import protection provided by government because of strong price resistance in South Africa.

Prices of locally produced vehicles were about 40% higher than the overseas equivalents as assemblers cut margins in order to increase sales.

The SA motor industry is having to gear itself to the lower end of the market where the economy car is making a spirited comeback, writes Business Editor John Spira

Small equals affordable on SA roads

Star 15/9/94

(192)

Market segmentation of passenger cars 84/94

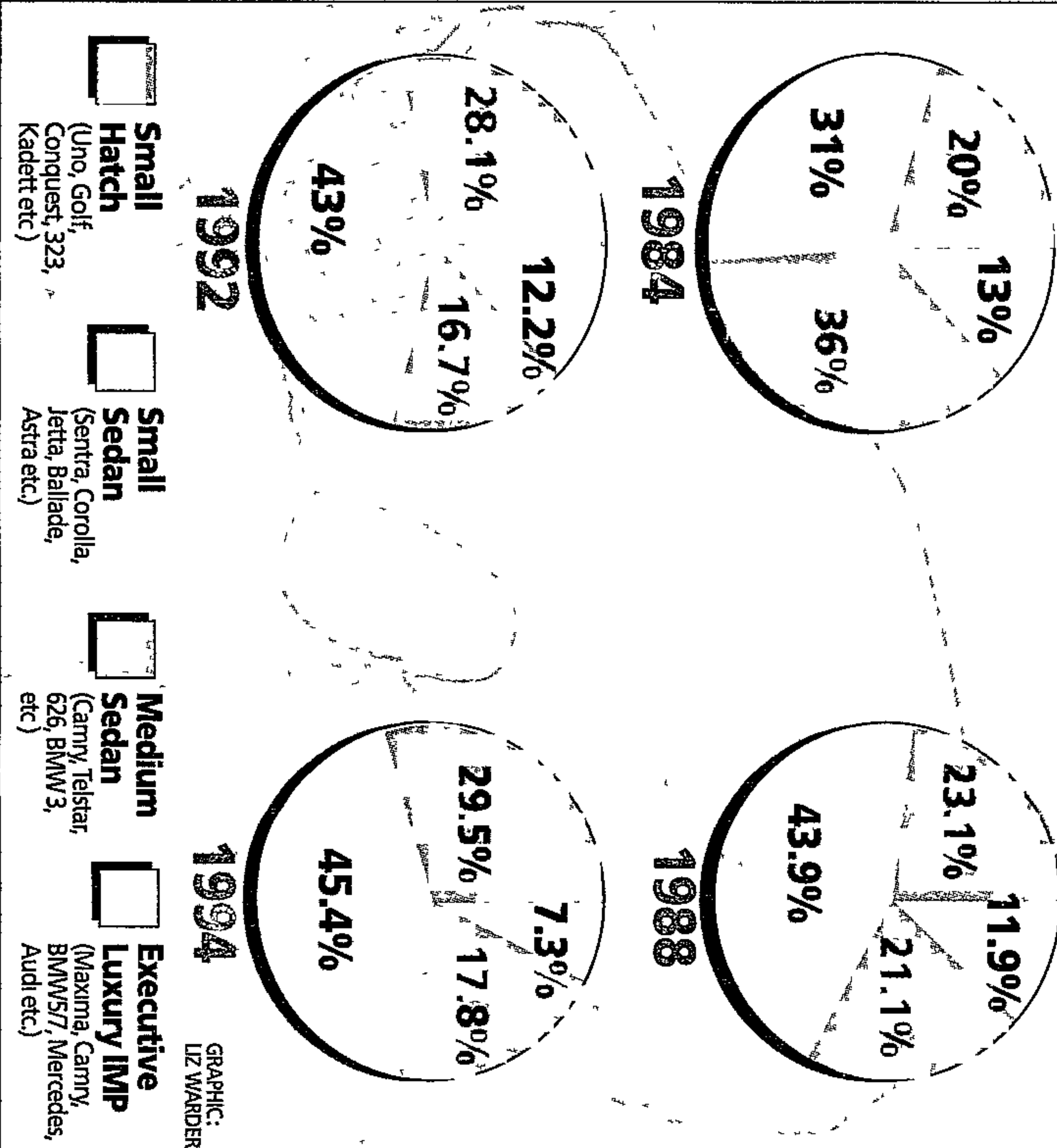

Affordability

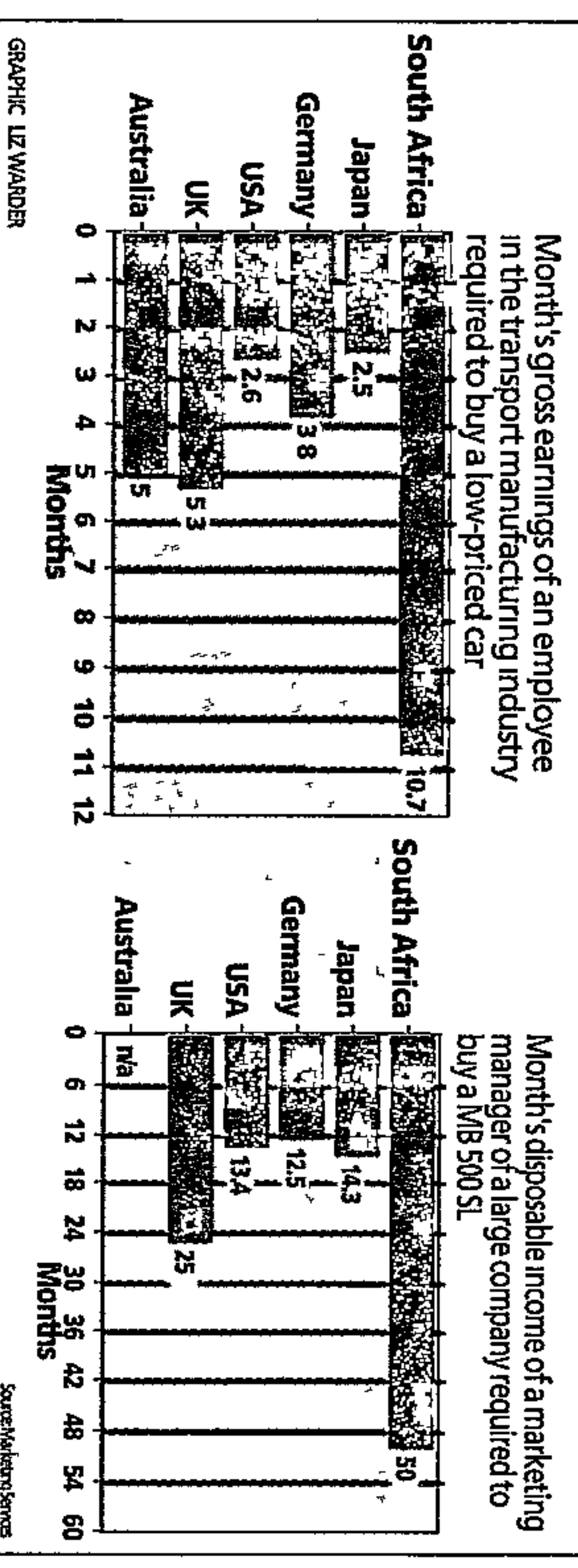

South Africa's motor industry has attracted intense scrutiny in recent weeks, in the process of which many myths have surfaced.

The recent strike and the reduction of tariffs on imported cars have placed the spotlight fairly and squarely on an industry which generates annual revenues in excess of R32 billion.

It's a sector of the economy which cannot be lightly brushed off, since

- It has invested capital — directly and indirectly (motor manufacturers, component manufacturers and the trade) — of close to R19 billion in the economy.
- It employs, directly and indirectly, more than 270 000 people.
- There are 6 million vehicles on South Africa's roads, 57 percent of which are cars.

Stagnated

It is among the most competitive sectors of the economy, with around 10 manufacturers competing for a market which has stagnated over the past 10 years.

Affordability (or, rather, the lack thereof) has intensified the hype surrounding the industry, with fingers being pointed at what are perceived as unacceptably high new motor vehicle prices.

The outrage is perhaps understandable in the light of the statistic that an average employee in the transport manufacturing

industry requires 10,7 months of gross earnings in order to buy a low-priced car.

The comparable figure in Japan is 2,5 months, in the United States 2,6 months, in Germany 3,8 months and in the UK, 5,3 months. Even in Australia, the statistic is relatively low at five months.

When it comes to higher-priced cars, a South African marketing manager requires 50 months of disposable income in order to pay for a Mercedes Benz 500SL.

His German counterpart could buy the same vehicle for only 12,5 months of disposable income. In Japan the figure reckons out at 14,3 months, in the US at 13,4 months and in the UK at five months.

South Africans are therefore obliged to work long and hard before they are able to set foot on the showroom floor.

But (and here is where one of the widely circulating myths is exposed) it is not protection that lies behind the poor affordability situation in South Africa. Rather it is simply that South Africans earn relatively less than their peers in the world's industrialised nations.

As Nissan SA Marketing's managing director Stephanus Louber points out, domestically manufactured cars actually cost less on average (on a straight currency conversion basis) than similar cars manufactured in many other countries.

A Uno 1100, for example, was priced at R29 708 in South Africa in 1993 (when the study was undertaken) versus R37 755 in the UK and R36 214 in Germany.

Higher up on the price spectrum, the picture is unchanged, with a VW Jetta 1,8 priced at R39 429 here, at R72 975 in the UK and R61 480 in Germany.

With the rand having weakened since 1993, the latest comparison would indicate even higher relative pricing for the overseas models.

It is only when you get to the luxury models — the Merces and BMWs — that South African prices exceed those of the UK and Germany.

The upshot of this comparative pricing phenomenon, juxtaposed on the affordability disadvantage, is, Louber observes, a massive swing in South Africans' buying preferences from luxury cars to lower-priced, more affordable vehicles.

"The South African motorist (and this includes fleet owners) has been buying steadily down — with dramatic resultant shifts in market patterns, not only in the new market but also in the used car market."

Thus, whereas in the past we saw the values of some luxury models actually increasing on resale, this is no longer the case. In fact, it is the low-priced cars that have been retaining their value on resale, while luxury cars have not.

A research exercise, the results of which were recently contained in the Mead & McGrouther Auto Dealers' Digest, took a look at a range of 1990 models and compared the prices paid then with their current (July 1994) resale prices.

Using a base of 100 (the new model price in 1990), an 1100 Uno Fire currently sells at 105,1 and a 1400 Uno Pacer at 99,6.

In sharp contrast, the present index value for a Mercedes Benz 300SE is 84,9 and for a BMW 735i, 69,7.

The new car market demonstrates the same groundswell (forced affordability) preference change from high-priced to low-priced vehicles.

The accompanying diagram clearly illustrates how the popularity of the market's A, B and C segments (the "small hatch" and "small sedan") categories have grown at the expense of the D ("medium sedan") and E ("executive luxury") segments.

"The huge change in market emphasis explains why Nissan, which produces cars slotting mainly into the A, B and C segments, has been gaining market share in the past decade," Louber notes.

"In 1985, we achieved only 6,8 percent of the passenger car market. Our share has been steadily increasing since then, with the current year's figure standing at around 16 percent."

"We anticipated the trend well in advance and are now reaping the benefits. It's a trend which we expect to be extended into the foreseeable future."

A BMW spokesman comments: "Our BMW M3 was launched here a year ago at a price of R209 000. Today they're changing hands at R235 000, so we believe there continues to be a high level of interest in luxury cars."

"The M3 is perhaps an exception, since the market is now returning to normal. A few years back we had the abnormal situation of rising values in the second-hand market, because inflation was high. This is no longer the case."

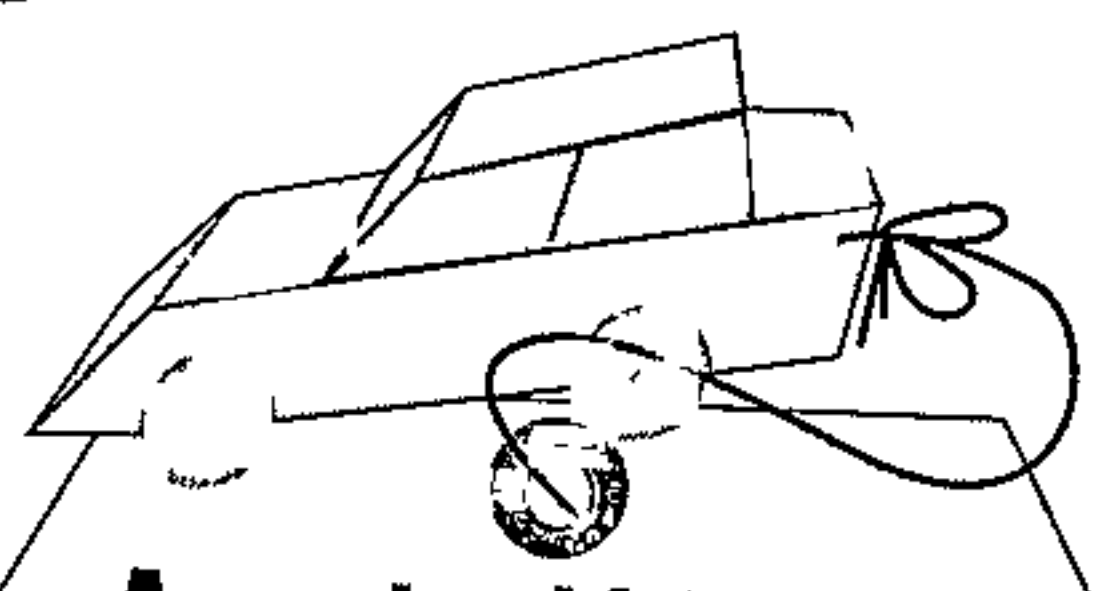

August vehicle sales

Cars	Total	%*
Corolla /Conquest 2 361, Camry 1 051, other 11		20,4
Honda Ballade 1 273, M-Benz C-Class 1 586, E-Class 185, S-Class 41, other 20		18,5
Citi/Fox 1 587, Golf /Jetta (new) 1 067, Golf /Jetta (old) 100, Audi 112		17,1
Laser/ Meteor/ 323 1 925, Telstar/ 626 770, other 64		16,4
Sentra 1 292, Maxima 88, 200SX/300ZX 4, Fiat Uno 467		11,0
Astra/Kadett 1 608, Monza/ Kadett 100, Rekord 40, Talbra 3		10,4
BMW 3-Series 836, 5-Series 176, 7-Series 37		6,2
Subaru Legacy 1		0,0

*% of the total car market

	1994	1993	% Change
August	16 805	17 509	-4,0
Jan - August	128 270	129 252	0,3
July (16 957) - August			-0,8

Light commercial	1994	1993	% Change
August	1 444	1 500	-3,8
Jan - August	11 111	11 111	0,0
July (9 711) - August			13,4

Medium commercial	1994	1993	% Change
August	1 150	1 150	0,0
Jan - August	10 101	10 101	0,0
July (9 711) - August			4,0

Heavy commercial	1994	1993	% Change
August	1 150	1 150	0,0
Jan - August	10 101	10 101	0,0
July (9 711) - August			4,0

Total vehicle	1994	1993	% Change
August	16 805	17 509	-4,0
Jan - August	128 270	129 252	0,3
July (16 957) - August			-0,8

Total vehicle	1994	1993	% Change
August	16 805	17 509	-4,0
Jan - August	128 270	129 252	0,3
July (16 957) - August			-0,8

Total vehicle	1994	1993	% Change
August	16 805	17 509	-4,0
Jan - August	128 270	129 252	0,3
July (16 957) - August			-0,8

Source: NATIONAL ASSOCIATION OF AUTOMOBILE MANUFACTURERS OF SA

MOTOR SALES

A no-win situation

For 16/9/94

It may have cost hundreds of millions of rands in profits, and wrecked production and sales forecasts, but the five-week motor industry strike hasn't quite extinguished assemblers' optimism

By the end of August new vehicle sales for the year were already down on the first eight months of 1993 September sales, which will reflect last month's strike, are likely to be a disaster Nevertheless, some believe pent-up demand for the remainder of this year could still drag annual sales past 1993 levels

It will take uninterrupted production and plenty of overtime to begin catching up with the backlog Employers suggested last week it could take as long as 18 months for vehicle supplies to match demand — though that appears to be as much a factor of pre-strike shortages as of production lost during the five-week shutdown

The National Association of Automobile Manufacturers of SA confirms that effects of the strike will be felt for several months It says 1994 sales forecasts of 200 000 for cars and 102 500 for light commercials are probably now unattainable

"Provided the industry succeeds in making up a portion of the lost production suffered during the strike, we anticipate that new car and light commercial vehicle sales will at best only slightly exceed 1993 levels, reaching 195 000 for cars (1993 193 666) and 100 000 for light commercials (96 534)"

Car makers scramble to recover strike's loss

SI Times (Buss)

18/9/94

192

THE 43 000 vehicles lost to production during the 27-day motor industry strike will not be fully recovered by year-end and waiting lists for virtually all models will lengthen

Frantic steps are being taken by manufacturers in co-operation with unions to increase daily build schedules and many will work on Saturdays in an effort to replenish dealer stock levels

Car sales in September, the first month to reflect the strike, are forecast at well below 10 000 and October is not expected to be much better

The National Association of Automobile Manufacturers of South Africa (Naamsa) says that earlier forecasts of 200 000 passenger car sales for the year are unlikely to be met and might only reach 195 000. This compares with 193 666 in 1993. Light commercial vehicle sales should be about 100 000 this year compared with 96 534 in 1993.

Stephanus Loubser, managing director of Nissan Marketing, says it now appears unlikely that total sales this year will be much better than last year. Because Nissan had a particularly tight stock position before the stayaway, a return to a normal stock position within the next 12 months is unlikely even if overtime is worked

By DON ROBERTSON

The strike came at a most inopportune time for Mercedes-Benz which launched its new C-Class compact vehicle during August

Sufficient stocks had been built up for the launch before the strike began on August 1 and sales of the C-Class during the month reached a record 1 586, the fifth largest individual model seller for the period

The strike meant a halt to production and good sales performance in September has been stymied. The company is still negotiating with the union for ways of recovering lost production of about 3 370 vehicles

Toyota went into the strike with a backlog of 5 000 vehicles and suffered a loss of a further 11 300 during the stayaway. The company plans to employ an additional 150 people and will, subject to union agreement, work overtime as well as some Saturdays. It does not, however, expect to make up more than about a week of the backlog before the end of the year

Delta Motor Corporation, manufacturers of Opel and Isuzu, has been working an additional two hours a day since the strike ended and will work on a number of Saturdays. This should result in an extra 2 500 vehicles being built by year-

end and reduce the 4 800 lost during the stayaway

Waiting lists for Opel sedans and Isuzu bakkies, which were between three and four months before August, will now lengthen. Following a decision taken before the strike, the company will also take on 400 new employees to add a shift to the body shop

Mazda and Ford builders, Samcor, plans to increase production by 100 units a day to 376 from October in an effort to recover lost production of 6 900 vehicles. By year-end, however, only about 80% of the lost production will have been made up. Additional workers will be needed to bolster the assembly line

BMW's production rate of 85 vehicles a day has not yet been reached since workers resumed, but there is no intention to exceed this build level once it has been reached. Some additional production could be achieved with overtime. Waiting lists for the Three Series, which are built to order, are expected to extend to about four-and-a-half months

Volkswagen lost 9 000 vehicles, but will employ temporary workers and will work overtime in an effort to increase daily production to 300 units and eventually 350. Waiting lists were previously between four weeks and three months, depending on model

Mercedes cuts truck prices

MERCEDES-Benz is to reduce the price of its large trucks by 2,5% from September 12, in effect cutting the price of trucks weighing more than 17 tons by R12 000

Mercedes-Benz dominates the heavy truck sector with a 50% market share, but is not that big a player in the medium commercial sector

However, its average market share of the two sectors is 38%, well up on the 32% it held in 1990

The company is seeking to maintain its dominant position in the market and to

By DON ROBERTSON

counter claims that the range is pricing itself out of contention

Adolf Moosbauer, management board member for commercial vehicles, says the price gap between Mercedes-Benz trucks and Japanese vehicles is shrinking

For example, a Mercedes 26-tonner, which was 22% more expensive than its Japanese competitor in 1989, now costs only 2% more

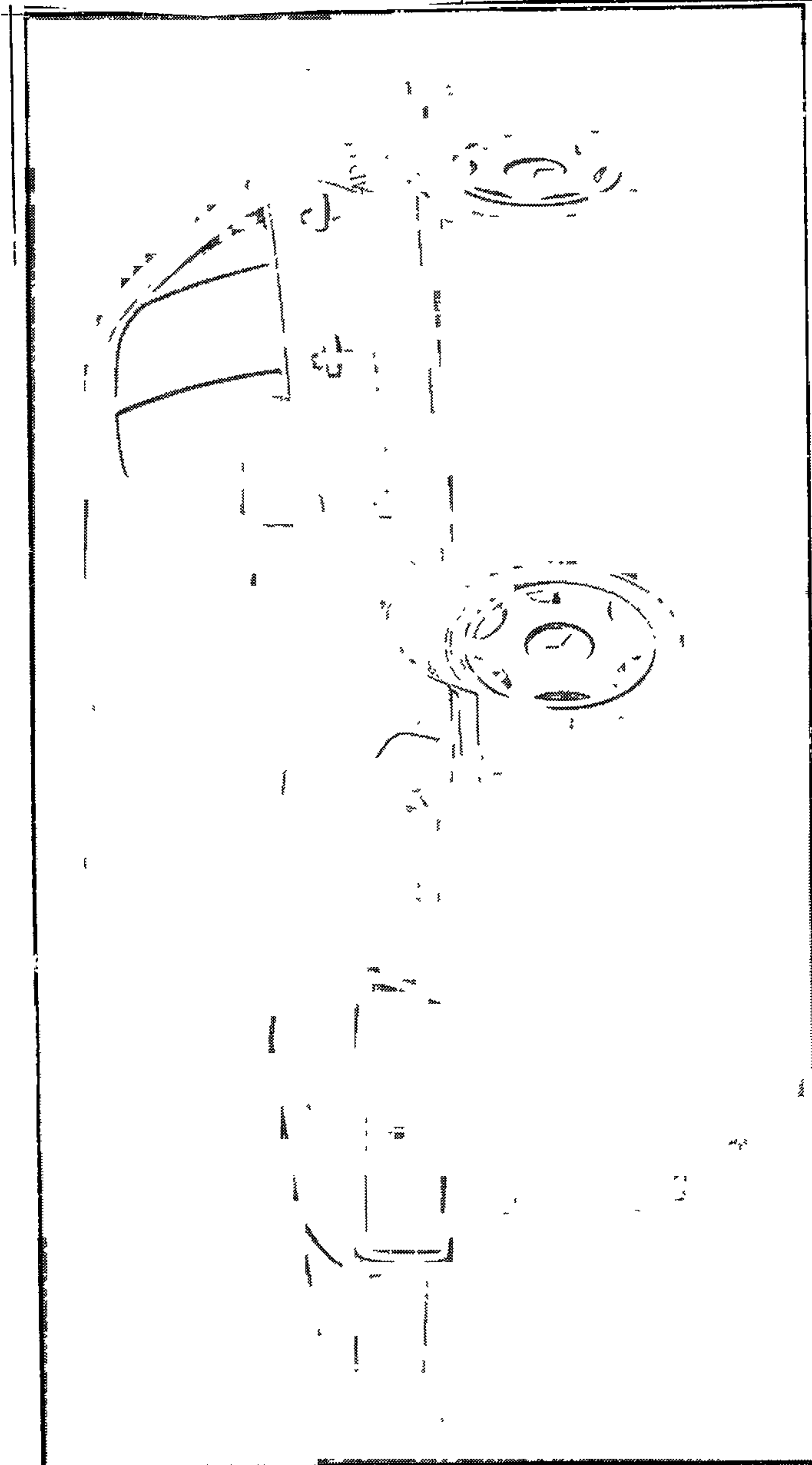

DENTED Mercedes-Benz's new C-Class, whose promising launch was affected by lost production during the 27-day strike

S (Times) (Bus) 15/19/19/19/19

Metair sees

8% slump

Biday 7/19/94
MICK COLLINS

MOTOR component manufacturer and distributor Metair Investments reported an 8% drop in attributable income to R8,9m for the six months to June following labour disruptions.

Metair, whose major shareholder is Toyota holding company Wesco, saw income before tax drop 19% to R15,1m as production losses hit home

Tax at R5,8m was 27% lower and the company reverted to normal rates having used up all accumulated losses. After tax income was 12% down at R9,2m. Earnings a share fell 7,6% to 158c (192)

Chairman Elisabeth Bradley said "Practically everyone in the motor industry had industrial action. Stocks in the first six months were lower and poor production soon saw these stocks used up"

While sales of new vehicles were marginally higher than in the first six months of 1993, vehicle production volumes declined due to disruptions experienced prior to and during the election period

The resultant loss in production days created abnormal manufacturing peaks and troughs which affected efficiencies

Car plants gear up production

Star 23/9/94

■ BY JOVIAL RANTAO
LABOUR CORRESPONDENT

Catch-up operations at most car manufacturing plants where employers have made plans to recover production and employees wages which were lost during the six-week-old strike have gained momentum

However, the companies in the component manufacturing industry which had to close be-

cause of the strike, have not yet resumed operations

In the car manufacturing plants, pacts between individual companies and the National Union of Metalworkers of South Africa (Numsa) have made it possible for agreements on overtime, with workers earning premium rates, working on Saturdays and the employment of temporary staff to help push production

Some manufacturers have suggested that the workers' end of the year holiday be reduced to make up lost working days and production Negotiations on the issue are continuing

Volkswagen South Africa, which lost production of 9 000 vehicles during the strike, representing R450 million in turnover, has employed 262 people on a temporary

basis to make up production

"The temporary employment plan, which will also help alleviate unemployment in the area, is part of an all-out initiative to recover lost production," VW spokesman Ray Hartle said

The recovery plan includes scheduling overtime, extra shifts, and investing in facilities to remove production bottlenecks

192

Auto strike bites deep

Sometimes called the Detroit of South Africa, the Port Elizabeth-Uitenhage economy is reeling from the effects of the automobile strike, writes **Stuart Wright**

IN Tambo Village, a shack settlement outside Uitenhage, Prudence Ndika (35) doesn't know how she is going to feed her family of four

A month ago her husband, Fezile Ndika (39), a worker with 15 years' service on Volkswagen's assembly line, downed tools along with 25 000 motor workers throughout the country in support of wage demands

Now the family has no income.

"There are school fees, we struggle with no food I just went next door to ask for sugar I don't work and we can't pay the account for the furniture," she said, stroking the plastic-covered couch in her cramped lounge

"My husband also has two brothers and his mother in Paterson and he is the only breadwinner My children can't afford to sleep without food, they are begging to make ends meet."

Yet Prudence Ndika stands by her husband's decision to strike

"I know it is for a good cause If Numsa (the National Union of Metalworkers of South Africa) achieves what it is fighting for, then we will be able to buy things like new school clothes We are suffering but after the suffering there will be something better," she said.

Carol Plaatjies (45) works as a tea lady at Auto Industrial Centre. She's part of the skeleton staff still on duty but her husband, Dial Plaatjies (45), employed by AIC as a spraypainter, only worked one day this month.

Carol Plaatjies is at a loss as to how her family of six will survive on the R185 she earns a week without her husband's R400 weekly wage

"There is no food, my baby is lying in hospital, we don't have medical aid and I just got the bill for R220 and I am still waiting for all the accounts. It's impossible to pay all the debts with



Carol Plaatjies ... 'It's impossible to pay all the debts'

my small amount of money," she said.

"I don't think it is something good. They must go back to work .. If they don't work then I can't work, my husband can't work. They must think about the children and their future."

There is a R15-an-hour difference in wages between the highest and lowest paid worker on Fezile Ndika's grade-three skill level, an anomaly which workers and employers hoped to address when wage talks began more than a month ago

But those hopes were dashed when Numsa and the Automobile Manufacturers Employers' Organisation (Ameo) failed to agree on a deadline for eradicating the wage curve.

Ameo also declined to make a final offer on wage increases until the restructuring issue was off the table because of its implications for budgeting. It was agreed to postpone restructuring until next year's round of negotiations.

That was when the talks, which held the promise of a groundbreaking agreement in South African industrial relations, took a nose dive

Ameo bumped its initial offer of a



Prudence Ndika ... 'We have no food'

PHOTOS STEUART WRIGHT

nine percent wages increase up to 10 percent and was only willing to get around the table to hear Numsa's acceptance After Numsa dropped its demand from 12 percent to 10,5 percent, neither side was prepared to budge the half a percent that would end the strike.

That was almost a fortnight ago To date, the motor industry has lost about R2-billion in turnover, workers have forfeited more than R60-million in wages

The halt in production at car and truck assemblies around the country has had a ripple effect: the auto-component manufacturing industry is losing R20-million a day and the jobs of a further 188 000 workers are at risk.

National Association of Automotive Component and Allied Manufacturers' executive director Denzyl Vermooten says about 20 companies have temporarily shut down.

The Port Elizabeth branch of AIC is one of the 180 or so companies in this support industry Since the strike dried up demand for AIC spray painting and plastic trim, its workers have been put on unpaid leave — Ecna

Car production now matching pre-strike levels

(192) ARCT 29/9/94

□ Motor manufacturers back on track

HENRI DU PLESSIS
Motoring Reporter

SOUTH African car manufacturers are back on track with production levels matching those before the crippling strike which ended earlier this month

Makers surveyed by The Argus say vehicles are again becoming available as employees work overtime to catch up on lost production. There are still waiting lists for many makes and models, however.

Overtime work differs from company to company, with employees either putting in a longer day, or working on weekends to catch up.

Some companies have engaged more staff.

At Toyota's Natal plant, production was back to normal levels and employees were working on Saturdays to catch up, a spokesman said.

"We are building according to orders from our dealers, so we do not have stock standing around," the spokesman said.

"Waiting lists differ from model to model and region to region. Obviously, some models are more difficult to find in the country areas than in the main centres."

A Nissan spokesman said his company should have made up for lost production by December.

"We have negotiated with employees to work extra time and by the end of the month our dealers should be fully stocked.

"For some models there are always waiting lists."

A BMW spokesman said the company expected to reach full production of 85 cars a day by the end of this week. But there are waiting lists of up to six months for BMWs, depending on the model.

At Delta in Port Elizabeth, Isuzu and Opel production lines were operating at full capacity, with employees there also electing to work overtime to catch up.

There would be about a month's delay in orders until lost production was recovered by the end of the year, a spokesman said.

A Samcor spokesman said some of the company's products were in short supply even before the strike and the shortage had been aggravated by the month-long work stoppage.

"We are up to normal volumes and plan to hire more people rather than have the employees work overtime."

A spokesman for Mercedes-Benz said the strike had delayed the delivery of all vehicles by around six weeks. In some cases, such as the new C-class models, there was a waiting list of up to six months.

BMW chief talks tough to SA operation

Business Editor

192
29/9/94

EXPORT customers are not interested in SA's problems and will turn to other suppliers if quality products are not delivered in time, the international chairman of BMW, Bernd Pischetsreider, warned yesterday

He said in Johannesburg that in past years the BMW group had made concessions for the situation its SA subsidiary had to work under

But, he said bluntly, "now that SA has been accepted as a citizen of the world with social, political and economic structures returning to internationally accepted norms, these concessions no longer make business sense

"Now the name of the game is international competitiveness. If BMW South Africa can prove it is able to produce the standard of quality, productivity and delivery efficiency required, it will become a fully-fledged member of BMW's global manufacturing and distribution network.

"If it cannot meet these requirements it will, quite frankly, be out of the game"

Pischetsreider said he was confident BMW (SA) could meet the challenge But this would require not only management commitment but the commitment of every employee in the company and of local component suppliers "The recent prolonged industry-wide strike sent a clear message abroad that total commitment is still a long way off"

"There are also scores of suppliers in other countries that would be delighted to take export business away from SA"

Autoquip in gear as earnings pick up speed

Biday 2019
IMPROVED margins and reduced expenses helped motor parts distributor and retailer Autoquip increase earnings a share 13,4% to 15,3c for the year to June

Turnover notched up 9,3% to R65,7m (R60m), while attributable earnings jumped to R1,7m (R783 000) *(192)*

Autoquip includes three divisions. The Autoquip division is a wholesaler and retailer of wheels and Bridgestone tyres. Partquip and Partco are wholesale distrib-

MUNGO SOGGOT

utors of specialised motor parts

The company said both Partquip and Partco were rapidly increasing their market share, while stock levels had been cut to more favourable levels, improving the group's gearing

Net income before tax rose to R2,6m (R1,2m). The company's tax bill was up at R610 000 (R169 000)

No dividend was declared

Toyota powers ahead with earnings

From MUNGO SOGGOT

JOHANNESBURG — Toyota SA lifted earnings 41.7% to R44,3m (R31,3m) for the six months to June despite lower sales

Earnings a share were pegged at 108,89c (76,87c). An interim dividend of 20c was declared. No dividend was declared for the interim period last year.

Executive chairman Bert Wessels said the group's market share had slipped to 27,1%, compared with 30,6% for the first six months of last year. The company had been hit by production losses

during the election and by industrial action and stoppages.

Toyota had lost 10 production days during the period, which translated into a loss of 4 250 vehicles at a potential production rate of 425 vehicles a day, he said.

Imported component costs had jumped 23,6%, after a strengthening of the yen against the rand. Turnover was up 2,6% at R2,3bn (R2,2bn), while operating income before interest and tax rose 3,6% to R95,5m "due to generally improved operating efficiency and judicious exposure to exchange rate fluctuations".

(1992) CT 30/9/94

The company's tax bill dropped 31,6% to R19,8m, and interest was up 6,2% to R30,9m.

Wessels said the retail market forecast for 1994 was 304 700 units, which was 2,23% more than last year's 298 048 units.

Demand for vehicles had lifted in line with the general improvement in confidence. Toyota expected this recovery would continue into next year.

Yesterday the share dropped 50c from its previous close to R19,50. It reached an annual high of R31 on March 16, from a low of R15,50 on October 20 last year.

● Wesco Investments, which has a 50% stake in Toyota and a 42% stake in motor component manufacturer Metair as its main investments, posted earnings up 49% to 213,1c a share (148c) for the six months to June.

Attributable income rose to R17,9m (R12m) on a turnover of R2,3bn (R2,2bn). No dividend was declared.

Group operating income was up at R92,7m (R87,8m), with interest and finance charges R33,96m (R32,9m).

Yesterday the share was unchanged at a previous close of R50.

UP 41,7%

Volkswagen head meets Mandela

Business Staff

(192) ARCT 1/8/74
THE head of the Volkswagen empire, Ferdinand Piëch, is in Cape Town for talks today with President Nelson Mandela and Deputy President Thabo Mbeki

The courtesy call by Dr Piëch's, chairman of Volkswagen AG, coincides with the overwhelming vote by car workers in favour of an industry-wide strike

But Volkswagen public affairs executive director Otto Wachs said Dr Piëch's discussions with the two leaders would not focus exclusively on the industrial action but on "broader issues"

Reacting to rumours of possible disinvestment from South Africa because of increasing labour unrest, Mr Wachs said the chairman's visit was to reaffirm Volkswagen AG's commitment to South Africa

He said the meeting with Mr Mandela

and Mr Mbeki was a follow-up to Dr Piëch's meeting with Deputy President F W de Klerk in Germany six weeks ago

VWSA's public affairs director, Percy Smith, also scotched rumours that Dr Piëch's visit was related to rationalisation at the group's assembly plant in Uitenhage

He said discussions relating to rationalisation between VWSA and Volkswagen AG could only take place once there was more clarity on the Phase 7 local content proposals

These proposals are currently under investigation by the Motor Industry Task Force

Dr Piëch declined to be interviewed

● There was no clarity on the situation at Volkswagen's Uitenhage plant today, although it seemed some workers had not reported for duty

Workers support motor industry strike

CAR workers had voted overwhelmingly in favour of a strike in a national motor industry strike ballot, Numsa general secretary Enoch Godongwana said yesterday

About 78% voted for strike action, but the decision on whether to go ahead with the strike would be known only tomorrow

Shop stewards would report back to workers in all plants today and a national shops stewards' council meeting tomorrow would consolidate the positions of the plants and decide on the strike (192) Godongwana said negotiations with

Monday 11/3/94
KATHRYN STRACHAN

management were continuing with a meeting scheduled for Wednesday

The union wanted a 12% increase against management's 9% offer. He said the two parties disagreed about the period over which the overall wage level should be corrected

Motor plants nationwide will be faced with a strike by about 19 000 Numsa members if no agreement is reached



Motor workers back stayaway

(192) ~~192~~
CT 11/8/94
A NATIONAL strike ballot in the motor industry has indicated overwhelming support for industrial action, Numsa general secretary Mr Enoch Gdongwana said yesterday.

About 78% voted for strike action, but the decision on whether to go ahead with the strike would be known only tomorrow afternoon.

A national shop stewards' council meeting tomorrow would consolidate the positions of the plants and make a decision on the strike.

● Building industry workers in the Western Cape were expected to return to work today, a union spokesman said.

General secretary of the SA Woodworkers Union, Mr Eddy Kapp, said a meeting had been held on Friday with the Building Council Committee — the committee established to try to resolve the strike. Employers had been given until September 10 to respond to workers' demands.

● Mediation in the Pick 'n Pay wage dispute was adjourned on Saturday after the company and the SA Commercial, Catering and Allied Workers' Union both made improved offers. Mediation will be reconvened tomorrow — Own Correspondent, Staff Reporter, Sapa

ARGUS 2/8/94 (152)

PAT CANDIDO and ROGER FRIEDMAN
Staff Reporters

THOUSANDS of motor industry workers failed to turn up for work in the Eastern Cape today but there is some hope of a breakthrough in the dispute between Pick 'n Pay workers and management.

The motor industry workers joined colleagues in the catering, metal, paper and oil industries, as well as municipal and judicial sectors, who have been involved in more than 50 separate protests in the past three weeks.

Pick 'n Pay joint managing director Gareth Ackerman is hopeful his company's dispute with the South African Commercial, Catering and Allied Workers' Union (Saccawu) will be settled by mediation today.

National Union of Metalworkers of South Africa (Numsa) officials seemed to be caught off guard by the mass action. A decision on strike action was only meant to be taken at a meeting in Johannesburg today.

It is not clear how many of Numsa's 19 000 members had joined the strike by today.

A union spokesman said workers at Volkswagen, Delta, Mercedes Benz, BMW and Nissan at Uitenhage, Port Elizabeth and East London downed tools a day before the union was to have officially launched the strike today.

Volkswagen in Uitenhage, Delta in Port Elizabeth and Mercedes Benz in East London were closed for a second day.

At all three plants workers were expected to hold meetings tomorrow. None of the motor manufacturers held out much hope that the workers would return.

Delta public affairs head Ed Emmett said the plant would be closed today.

A top management Isuzu Motor Corporation team from Japan, investigating multi-million rand export opportunities, had to be taken through a deserted Delta plant yesterday.

Mr Emmett said the shop steward council had told Delta that workers would remain out until tomorrow at a cost to the company of R9 million a day.

Industry sources speculate that the loss by the seven motor manufacturers in the event of a general strike would be about 1 500 units (or R110 million) a day.

Industrial action and unscheduled holidays cost the industry about 15 500 units (or R800 million) in the first half of the year.

Pick 'n Pay's Mr Ackerman spoke to The Argus on his way to the airport.

He declined to give details of a "total package" Pick 'n Pay plans to table today.

He said Saccawu had also made "positive, substantial moves" in their position.

"Conditional on them accepting the new package we will settle," Mr Ackerman said.

Auto to strike

CT 2/8/94

Own Correspondent

(192)

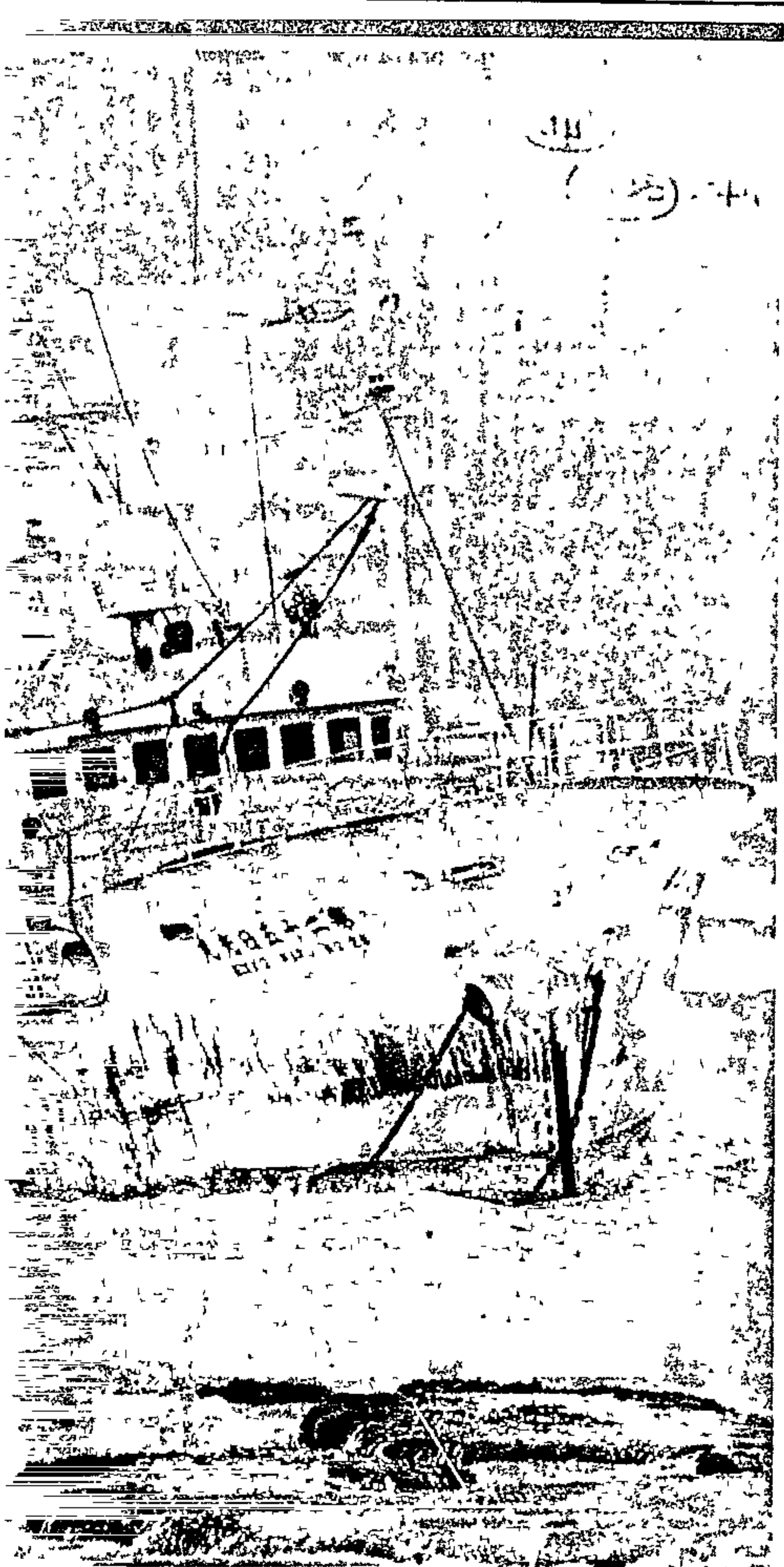

Nikko Maru 25 lies hard aground in the shallows at will be made to pull her off the reef. The crew were safely

Picture CLIVE SMITH

JOHANNESBURG. — All vehicle manufacturers in South Africa were forced to close plants yesterday after 19 000 workers in the industry downed tools following report-back meetings by shop stewards on wage negotiations.

Wage talks are expected to resume tomorrow

Meanwhile, the country has been hit by a wave of new industrial actions

These include a one-day strike by Telkom workers in Jeppe and a strike threat by municipal workers in the southern Transvaal following the dismissal of 600 SA Municipal Workers' Union members by the Midrand town council

And the National Union of Mineworkers declared a second dispute with the Chamber of Mines

United Metal Industries and Allied Workers' Union members marched to call for the negotiating forum of the Steel and Engineering Industries Federation of South Africa to be disbanded

Government clerical workers threatened to strike over wage dissatisfaction

However, a strike at Sun City has been called off, and hopes are high for a settlement today of the Pick 'n Pay strike

Motor industry sources said the loss in production by the seven motor manufacturers would be about 1 500 units a day at a cost of R110 million

Volkswagen's Uitenhage plant, Delta in Port Elizabeth and Samcor and Nissan in the greater Pretoria area were affected by the strike from early yesterday

BMW in Pretoria was closed and Toyota workers in Durban downed tools at midday

The Mercedes-Benz plant in East London was also closed

Volkswagen's international chairman Dr Ferdinand Piech, who is visiting South Africa, met President Nelson Mandela and Deputy President F W de Klerk in Cape Town yesterday

But sources stressed that it was a "courtesy visit" planned

months ago and not directly related to the industrial strife

Mr Mandela also met Anglo American's Mr Harry Oppenheimer and hotel magnate Mr Sol Kerzner

A presidential spokesman said these were "private visits"

Motor industry sources said the latest wave of strikes would cause a downward revision in estimated production figures of 300 000 units for 1994

Industrial action and unscheduled holidays had cost the industry 15 500 units or R800m in the first half-year

Losses

A VWSA spokesman said the plant closure would mean the daily loss of 250 vehicles at a cost of R17,5m. Toyota estimated its losses at 420 units or R21m a day

Volkswagen technical director Mr Hans-Jurgen Wiegand said the strike began yesterday morning despite Numsa's assurances that there would be normal production

"Management had no option but to shut down all production and production-related areas in the plant until further notice"

● The Minister of Justice, Mr Dullah Omar, said during the Budget debate yesterday that he fully supported the right of workers to strike for improved wages

**STRIKER
KILLED**

**NO LOW
WAGES**

See PAGE 2

YOU



Losses of R110m a day feared

Car industry crippled by labour action

B/Day 2189/4

ERICA JANKOWITZ
and MICK COLLINS

ALL vehicle manufacturers in SA were forced to close plants yesterday after 19 000 workers in the industry downed tools following report-back meetings on wage negotiations by shop stewards

The workers are expected to report back to work tomorrow morning, ahead of a shop stewards' council meeting and the resumption of wage talks

Industry sources said the loss in production by the seven motor manufacturers would be about 1 500 units a day at a cost of R110m. It would be virtually impossible to make up lost production if the strike went on for more than a few days unless workers were prepared to work overtime

Wage negotiations deadlocked, with employers offering a 9% increase and the National Union of Metalworkers of SA (Numsa) demanding 12%. Manufacturers also offered a basic education package for all workers which would cost about R10m a year for eight years

Volkswagen's Uitenhage plant, Delta in Port Elizabeth and Samcor and Nissan in the greater Pretoria area were affected by the strike from early yesterday. BMW in Pretoria was closed and Toyota workers in Durban downed tools at midday. The Mercedes-Benz plant in East London was also closed

Industry sources said the latest wave of strikes would cause a downward revision in this year's estimated production figure of 300 000 units

Industrial action and unscheduled public holidays had already cost the industry 15 500 units or R800m in the first half of the

year, they said. (192) (152)

A Volkswagen spokesman said the plant closure would mean a daily loss of 250 vehicles at a cost of R17,5m. Toyota estimated its losses at 420 units or R21m a day

A Samcor spokesman said at least 250 vehicles a day at a cost of about R12,5m would be lost through the strike

"We have this huge investment standing idle. The strike will affect our bottom line and will also affect employees' prospects"

A Delta spokesman said 192 vehicles would be lost at a cost of R9m a day

Sources put the respective daily losses for Nissan at 280 units, BMW 105 units and Mercedes-Benz 100 vehicles

Volkswagen technical director Hans-Jurgen Wiegand said the strike began yesterday morning despite Numsa's assurances that there would be normal production. "Management had no option but to shut down all production and production-related areas in the plant until further notice"

Our Port Elizabeth correspondent reports that Numsa general secretary Enoch Godongwana said the Automobile Manufacturers and Platers Organisation's (Ameo's) latest proposal was that differentials between grades be reduced over three years and plant level negotiations continue after that. Ameo had also demanded a no strike clause for this period, but Numsa was prepared to consider such a clause only when it related to a particular contract, he said

Car prices outstrip purchasers' means

B/Day, 21/8/94

AVERAGE prices for new cars now represented more than 130% of average annual disposable income in SA — far higher than in most Western countries, industry sources said yesterday.

Car price rises continued to outstrip overall consumer inflation, propelled by the devaluating rand and investment requirements, economists said.

The ratio jumped from 98% in 1985 to 126% in 1986, largely attributed to the infamous Rubicon speech. Apart from a few dips, the ratio has risen since then.

Econometrix economist Tony Twine said car price inflation in 1993 and this year had outstripped consumer inflation and any real growth in incomes.

The rand's collapse had underpinned the rise, while the investment requirements imposed by Phase 6 of the local content programme — meant to cut car prices — had lifted prices above overall consumer inflation between 1988 and 1990.

Though the ratio was undoubtedly higher than most Western countries, high volume models were on average slightly cheaper than overseas equivalents, while low volume luxury cars were more expensive, he said.

MUNGO SOGGOT

Despite the high prices whites — who boasted about 48 cars per 100 people — were the world's second largest car-owning group after the US where there were 52 cars for every 100 people.

Phase 7 of the programme — which would be submitted to the industry for consideration in two weeks — was geared to slashing car prices by replacing expensive, low volume models with imported equivalents, but the weakening rand could limit the benefits of the programme.

Toyota financial director Pieter Robinson said there was speculation that Phase 7 would cut the prices of high volume cars, but it was still not clear how the programme would work.

(192)
Twine said a significant barrier to the success of Phase 7 was that SA's size, combined with an annual passenger car market of about 202 000 units, meant it generally would be uneconomical for importers to set up countrywide dealer networks.

"Car price inflation is slowing, but events such as the recent sudden weakening of the rand against the Deutschmark means it can change direction at any moment."

SA car prices outpace income

Own Correspondent

JOHANNESBURG — Average prices for new cars now represented more than 130% of the average annual disposable income in South Africa — far higher than in most Western countries, industry sources said yesterday

Car price rises continued to outstrip overall consumer inflation, propelled by the devaluing rand and investment requirements, economists said

(192)

CT 2/8/94

The ratio jumped from 98% in 1985 to 126% in 1986, largely attributed to the infamous Rubicon speech, and had risen since Economist Mr Tony Twine said car price inflation in the last year had outstripped consumer inflation

The rand's collapse had underpinned the rise, while the investment requirements imposed by Phase 6 of the local content programme — meant to cut car prices — had lifted prices above overall

consumer inflation between 1988 and 1990

Despite the high prices whites — who boasted about 48 cars per 100 people — were the world's second largest car-owning group after the US, where there were 52 cars for every 100 people

Phase 7 was geared to slashing car prices by replacing expensive, low volume models with imported equivalents, but the weakening rand could limit the programme

Strikes: Hopes of a breakthrough

ARL 2/8/94

(192)

PAT CANDIDO and ROGER FRIEDMAN
Staff Reporters

THOUSANDS of motor industry workers failed to turn up for work in the Eastern Cape today but there is some hope of a breakthrough in the dispute between Pick 'n Pay workers and management.

The motor industry workers joined colleagues in the catering, metal, paper and oil industries, as well as municipal and judicial sectors, who have been involved in more than 50 separate protests in the past three weeks.

Pick 'n Pay joint managing director Gareth Ackerman is hopeful his company's dispute with the South African Commercial, Catering and Allied Workers' Union (Saccawu) will be settled by mediation today.

National Union of Metalworkers of South Africa (Numsa) officials seemed to be caught off guard by the mass action. A decision on strike action was only meant to be taken at a meeting in Johannesburg today.

It is not clear how many of Numsa's 19 000 members had joined the strike by today.

A union spokesman said workers at Volkswagen, Delta, Mercedes Benz, BMW and Nissan at Uitenhage, Port Elizabeth and East London downed tools a day before the union was to have officially launched the strike today.

Volkswagen in Uitenhage, Delta in Port Elizabeth and Mercedes Benz in East London were closed for a second day.

At all three plants workers were expected to hold meetings tomorrow. None of the

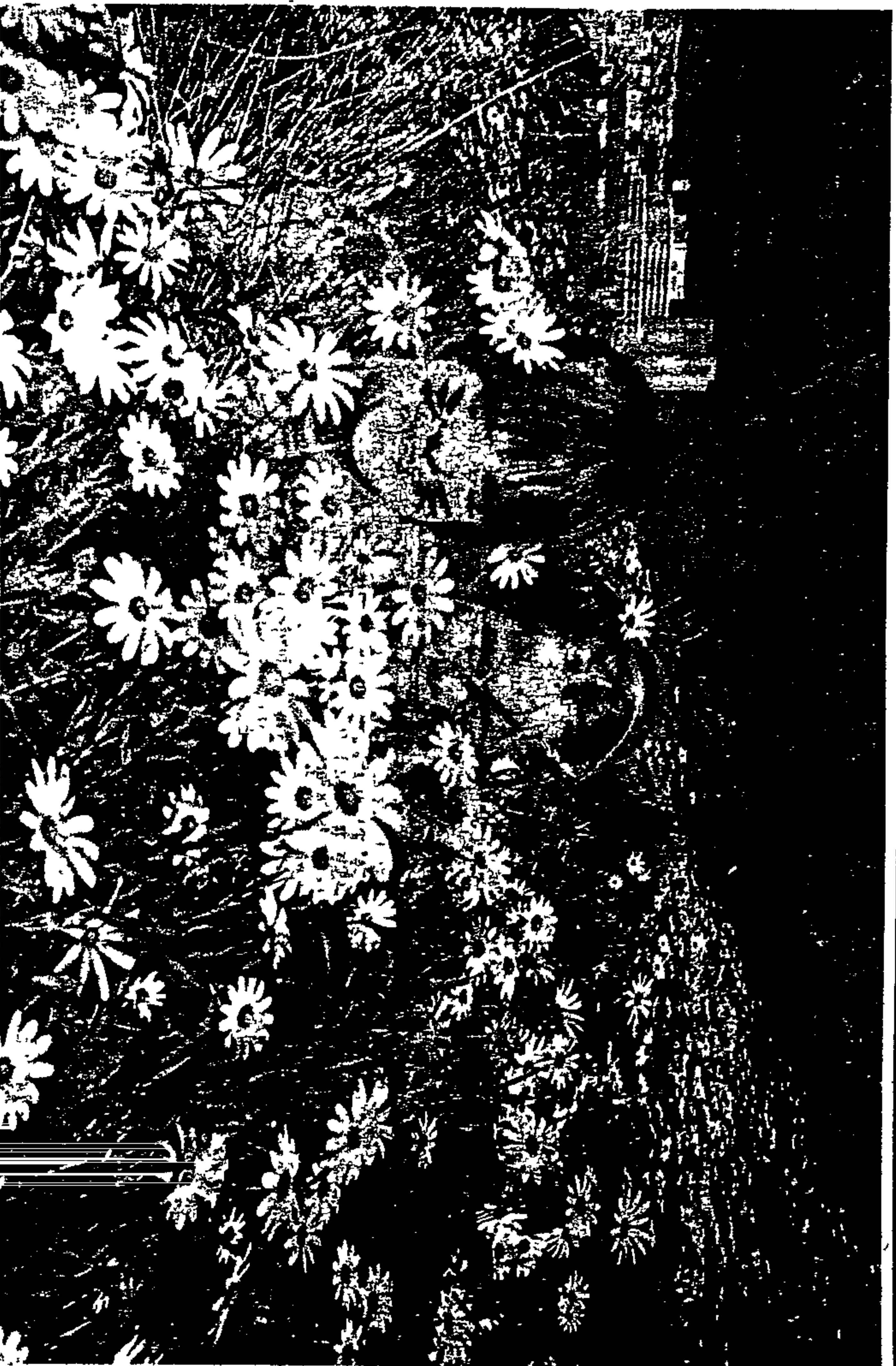

Employers set to lay off workers

Numsa warns motor strike could spread

BIDday 318/94

ERICA JANKOWITZ

THE national motor manufacturing strike, which is affecting about 25 000 workers, will continue until a wage agreement is signed and, if protracted, could affect nearly 200 000 workers in the components and service sectors, union spokesmen say.

National Union of Metalworkers of SA (Numsa) general secretary Enoch Godongwana said the union had received notice of short-time work in the components industry, and employers intended laying off workers. About 80 000 workers are employed by component manufacturers. Another 100 000 workers in the service and dealership industry could also be affected.

Negotiations with the Automobile Manufacturing Employers' Organisation (Ameo) would resume this morning, with the union demanding a 12% wage increase and employers offering 9%. The time frame in which anomalies would be rectified was also in dispute, with the union suggesting a three-year period and employers wanting four years in which to align wage rates.

Godongwana accused employers of bowing to pressure from Anglo American subsidiary Samcor, which paid among the lowest wages in the industry and ran the most capital-intensive operation. "We concluded that Ameo's poor response is as a result of the dictates of Anglo's immense investment in the mining industry — the bottom line is fear that a settlement favourable to workers in the auto industry will have a knock-on effect on the mines."

He said this was especially evident when focusing on Numsa's key demands narrowing the wage gap between top and bot-

tom earners and redressing apartheid's educational imbalances.

"It is Numsa's view that Anglo must now recognise that to end apartheid is a more profound exercise than just a national election — for us it involves, more than anything else, ending in the shortest possible time the twin evils of a racist wage structure and the results of discriminatory education and training practices. (192)

Anglo dismissed these claims, saying Samcor's position was no different from other employers and its mining interests were not pertinent to the motor dispute "Alongside other employers, Anglo is keen to promote the goals of growth in the economy and greater equity." (192)

Godongwana acknowledged that the union's goal of implementing a more equitable wage policy would have financial implications for employers, but said companies would have to make this investment in the interests of a successful reintegration into the global economy. (192)

Ameo acting president Harry Gawendam declined to comment.

Meanwhile, the Iron and Steel Workers' Union applied to the Industrial Court yesterday for a court order compelling Volkswagen's Uitenhage factory to allow about 2 000 of its members to resume work. The application will be heard tomorrow. The union's members were prevented from working when VW suspended production on Monday because of the Numsa strike

● Picture: Page 3

Strike may not hit car prices

Star 3/8/92

■ BY CHARLOTTE MATHEWS

It was too early to say whether the motor industry strike would affect car prices as it was possible lost production could be made up, said car manufacturers and economists yesterday

A Toyota spokesman said the impact of the strike, which was costing the company R25 million a day in lost turnover, would not be immediate and would not be significant if production was made up and customers were

not lost

"It depends on how long the strike lasts and what workers' attitudes will be when they return to work. If there is good productivity and willingness to work overtime, much lost production could be recovered."

This was echoed by BMW head of public affairs Chris Moerdyk, who said he did not expect the strike would have any impact on car prices.

Long waiting lists for new cars had long been a problem

Disruptions in Bophuthatswana earlier in the year had caused a backlog of supplies.

However, BMW had now been able to make up production lost earlier in the year (1992)

Econometrix economist Tony Twine said that if the strike lasted only one or two weeks, it would be impossible to isolate its contribution to price increases prompted by other factors, such as the exchange rate. He estimated the industry was losing R250 million a week.

Auto strike ¹⁹² could spread ^{CT 3/8/94}

THE national strike at all motor manufacturers — affecting about 25 000 workers — will continue until a wage agreement is signed and could affect nearly 200 000 workers in the components and services side of the industry if it became protracted

National Union of Metalworkers of SA (Numsa) general secretary Mr Enoch Godongwana said the union had received notice of short-time work in the components industry and employers' intention to lay off workers during the industrial action. About 80 000 workers are employed by component manufacturers

Another 100 000 workers in the service and dealership industry could also be affected, he warned

Mr Godongwana said negotiations with the Automobile Manu-

Action may affect 225 000

facturing Employers' Organisation (Ameo) would resume this morning, with the union demanding a 12% wage increase and employers offering nine percent

Mr Godongwana accused employers of bowing to pressure from Anglo American subsidiary Samcor which paid among the lowest wages in the industry

Anglo American dismissed these claims

In other strike action around the country

● About 500 workers at two Aberdare Cables plants in Port Elizabeth downed tools following an alleged racist slur by a white worker at the company's Markman Township operation

● Workers protesting management's failure to pay wages held three white miners hostage for several hours at the Rustplaas Collieries at Hlobane, near Vryheid, yesterday

● PWV social workers staged a sit-in in Pretoria yesterday morning, saying they were unhappy about staff benefits and racism

● At Tygerberg Hospital, clerical staff in the public service yesterday threatened to embark on industrial action if their salary structures were not upgraded by 20%

Talks were continuing late yesterday between striking Pick 'n Pay workers and management — Own Correspondents, Sapa

25 000 metal workers already on strike

Crucial talks for car industry today

Star 3/8/94

BY JOVIAL RANTAO
LABOUR CORRESPONDENT

Employers in the car industry and the National Union of Metalworkers of South Africa (Numsa) meet today in a crucial round of negotiations to resolve the strike which could affect more than 200 000 workers in the industry

About 25 000 metal workers at 11 automobile assembly plants embarked on an industry-wide strike on Monday after they had held report-back meetings at which they were told of management's latest offer and the results of their strike ballot.

Numsa general secretary Enoch Godongwana said he had already had notice from 180 employers in the component-supplying industry that if the strike continued, they would have to lay off 80 000 workers "We further anticipate the strike to affect over 100 000 workers in the service and dealership side of the industry," he said.

Harry Gazendam, vice-chairman of the Automobile Manufacturers Employers Organisation (Ameo), said he was disappointed that workers went on strike.

"We believe the strike is inappropriate and will make negotiations a lot more difficult. Ideally, one would not want to negotiate while there's a strike," he said.

Numsa enters today's negotiation with a reduced demand of a 12 percent increase, linked to a wage policy, education and training, job security and multi-skilling. Employers have offered 9 percent. Central in the Numsa dispute with Ameo is the timeframe required to rectify wage anomalies

Employers want the process to be completed in four years, while the union demands that it be completed in two years, but it would consider three years, subject to a satisfactory wage offer

According to Gavin Hartford, Numsa's national organiser in the automobile industry, the dif-

ferentials between workers in the same grade was R20 among the highest-paid workers and R5 among the lowest paid. (192)

Hartford said the average metal worker earned eight to 10 times less than his superiors. In the rest of the world, the differential is "about 2½ percent".

The other area of conflict is the number of modules of training for workers to get from bottom grade to artisan level. The union has proposed 60 modules and management 119.

Numsa said another difference was that employers offered to pay for some and not all the studies which workers would undergo to upgrade their skills.

Regarding the dispute surrounding the period to rectify wage difference, Gazendam said Ameo had been negotiating a wage model with Numsa to institute changes but the process could not be implemented in a short period without bankrupting the industry

BMW offers workers jobs

192 ~~193~~ By DAN SIMON CT 4/8/94

BMW SA yesterday said it would absorb some of the 100 workers who will be affected by the closure of Associated Automotive Distributors (AAD) Landrover division in Blackheath if they are prepared to relocate to Pretoria

BMW SA was this week given the go-ahead to manufacture the Landrover range of vehicles by Rover Group Holdings in the UK and BMW AG in Munich

BMW is to build a R14 million plant in Rosslyn near Pretoria after talks between it and AAD broke down when AAD refused a purchase price of R22 million for its Blackheath plant

AAD, which held the Landrover franchise since 1986, will cease Landrover operations at the end of November

AAD chairman Mr Roman Szymonowicz could not be reached for comment

Cape Chamber of Commerce and Industry executive director Mr Alan Lighton said Landrover's move to Pretoria was "regrettable" as it would affect not only the workers but also the suppliers of components in the production process

Motor talks back on track after setback

THE wave of strikes continued around the country yesterday, some ending with workers agreeing to resume their posts, others appearing set for drawn-out negotiations

Talks aimed at ending the motor strike were back on track last night after a day of tense negotiations during which Numsa officials sang songs and threatened to walk out

The strike involves more than 20 000

workers and is costing the industry R110m a day.

The three-week strike by Pick 'n Pay workers ended yesterday with the announcement of a R180 across-the-board pay rise. Original union demands were for R229 and Pick 'n Pay offered R175.

The settlement raises the monthly average wage to R1 643 a month. The strike is said to have cost Pick 'n Pay R70 million in turnover and work-

ers on average R1 580 each because of a "no work, no pay" rule.

Meanwhile, the predominantly white Iron and Steel Workers' Union will take Volkswagen to court today over loss of income.

About 200 civilian workers at the Simon's Town naval dockyard walked off the job yesterday, in protest against a manager's refusal to recognise the National Education, Health and Allied Workers' Union (Nehawu)

The Mineworkers' Union yesterday rejected a final offer by the Chamber of Mines of increases of between seven and 8,5%.

Striking Telkom employees on the Witwatersrand returned to work yesterday. Services were first interrupted on Monday when 300 employees staged a 8am sit-in at the company's Jeppe Street premises — Own Correspondent, Sapa

Unions walk out of motor industry talks

THE National Union of Metalworkers of SA (Numsa) and the SA Iron, Steel and Allied Industries' Union (Yster en Staal) walked out of motor industry negotiations yesterday, accusing employers of bargaining in bad faith

Numsa national organiser Gavin Hartford said the parties reached a framework agreement on all issues except a wage increase, but employers refused to disclose whether they had tabled a final offer or would be prepared to revise the 9% proposal on the table. The unions staged a walkout in response.

Negotiations resumed on Wednesday in a bid to resolve the wage deadlock which

Biday 512194
ERICA JANKOWITZ

sparked a strike by about 25 000 motor industry workers from Monday. Analysts estimated the strike would cost about R110m a day in production losses for the nine affected manufacturers. *(192)*

In the light of the breakdown of negotiations, Hartford predicted Numsa members would "dig in" and manufacturers would be in for a protracted strike.

He said the parties had agreed to settle non-wage issues to build a broader consensus around which to tackle the across-the-board increase issue.

Consensus was reached on a framework

agreement covering unprocedural industrial action, flexibility, overtime payments, skills modules, employment security, adult basic education, a restructured wage policy closing the existing wage gap, and shop steward rights.

Hartford believed some employers were reluctant to revise the wage offer under threat of industrial action. Automobile Manufacturing Employers' Organisation (Ameo) acting president Harry Gazendam dismissed this, saying employers were united in their position.

The industry was intent on implementing a revised wage model to correct past

To Page 2

Motor strikes

Biday 512194
distortions but this would have to be carefully planned and its timing would have to be perfect because of its massive cost implications. "The date by which the new policy must be in place determines the quantity of money available for wages."

The parties were deadlocked on the timeframe and employers had proposed removing it from these negotiations and tackling it in the next round, or working out the framework agreement before a revised wage offer was made. *(192)*

Gazendam said Ameo would draft the agreement and send it to Numsa and Yster

From Page 1
en Staal today and invite the unions to resume negotiations on Tuesday. Once the model agreement was given the thumbs-up, the wage offer would be revisited.

Meanwhile, Yster en Staal's urgent application that 642 non-striking members be paid during the plant's closure was dismissed by the Port Elizabeth Industrial Court yesterday.

The company argued that it was accepted practice not to pay workers when all production was halted due to strike action and paying non-strikers during this period "would cripple the company".

Motor industry talks break down

Own Correspondent

PORT ELIZABETH — With the strike cost running at R110 million a day, the motor industry wage talks broke down dramatically late yesterday and union officials toyi-toyed out of the negotiations

CT 5/8/94
By late last night, it was not known if the National Union of Metalworkers would return to the bargaining table on Tuesday, the scheduled date for the next meeting with the Automobile Manufacturers Employers' Organisation (Ameo) (192) ~~(192)~~

Led by Cosatu president Mr John Gomomo, a VW shop steward, and Numsa chief negotiator Mr Gavin Hartford, the union team of about 25 people emerged grim-faced from the talks just before 5pm

Breaking into song, they toyi-toyed through the Midland Chamber of Industries building

The breakdown in negotiations is centred on the model to address

"apartheid" wage imbalances in the car manufacturing industry. Employers want a written agreement on the time-frame for these changes before they will negotiate actual wage increase percentages. The union, on the other hand, is insisting on clarity on the wage offer, currently at nine per cent

The predominantly white Iron and Steel Workers' Union has said that it is 100% behind Numsa

Iron and Steel negotiator Mr Johan Prinsloo said "We strongly support Numsa — the employers won't even come forward with a final offer"

The strike is now in its fifth day and has already cost the industry R550 million. There are serious fears that it will soon start affecting the supplier industry. Sources have confirmed that the motor industry can absorb the ripple impact for a week — thereafter a strike is likely to cause permanent damage

Motor strike likely to go on

BIDay 8/8/94

PROSPECTS for an end to the week-old motor industry strike were poor after employers submitted a final wage offer of 9% on average earnings on Friday, National Union of Metalworkers of SA spokesman Enoch Godongwana said yesterday

Numsa would reject any offer of 9%, but was disappointed that there had been no movement from the Automobile Manufacturers Employers' Organisation (Ameo)

Any wage package based on average earnings would result in workers — who had recently secured large raises in some sectors of the industry — being awarded less than 9% Workers at BMW, Mercedes and Nissan would be among those adversely affected by the proposal

The union would decide today whether to resume talks, although the document "did not provide any basis for continuing negotiations", said Godongwana

MARK ASHURST and
ERICA JANKOWITZ

Talks between Numsa and Ameo broke down on Thursday after uncertainty over whether the 9% offer was on actual or average earnings, and whether a revised offer would be tabled (192) (102)

Godongwana accused management of delaying negotiations to secure revised industrial action agreements in plants where there had been unprocedural strikes

"They seem to view movement from the unions as a sign of weakness, and will delay talks until industrial action has been disciplined This is a misreading of the situation," he said

Numsa national organiser Gavin Hartford said the union "had made a string of provisional concessions on Thursday, the

To Page 2

Strike

BIDay 8/8/94

From Page 1

most important of which was to postpone until next year implementation of a strategy to eliminate apartheid wage anomalies in the industry (192) (102)

About 25 000 motor manufacturing workers are on strike around the country, costing the industry about R110m a day in lost turnover

Numsa has demanded a 12% increase and revised wage policy, including education and skills development

Ameo vice-president Harry Gazendam reiterated that the industry knew it needed to eliminate wage anomalies but the time frame in which this would be achieved was in dispute

Gazendam predicted about R20m a day would be lost in government revenue because excise and other taxes would be forfeited This would have a negative effect on government projects such as the reconstruction and development programme, he said

Strikers angry at wage offer

192

CT8/8/94

Own Correspondent

JOHANNESBURG — Prospects for an end to the week-old motor industry strike were poor after employers submitted a final wage offer of 9% on average earnings on Friday

National Union of Metalworkers of SA spokesman Mr Enoch Godongwana said yesterday the union would reject "any offer of 9%", but was disappointed that there had been "no movement from the Automobile Manufacturers Employers' Organisation (Ameo)

Any wage package based on average earnings would result in workers — who had recently secured large rises in some sectors of the industry — being

awarded substantially less than 9%

The union would decide today whether to resume talks although the document "did not provide any basis for continuing negotiations", said Mr Godongwana

Talks between Numsa and the employer body broke down on Thursday after uncertainty over whether the 9% offer was on actual or average earnings, and whether a revised offer would be tabled

Mr Godongwana accused management of delaying negotiations to secure revised industrial action agreements in plants where there had been unprocedural strikes

"They seem to view movement from the unions as a sign of weak-

ness, and will delay talks until industrial action has been disciplined. This is a misreading of the situation," he said

About 25 000 motor manufacturing workers are on strike around the country, costing the industry an estimated R110-million a day in lost turnover. Numsa had demanded a 12% increase and revised wage policy including education and skills development

Ameo vice-president Mr Harry Gazendam predicted government revenue would be adversely affected by the strike to the tune of about R20 million a day in lost excise and other taxes

"This will obviously impact negatively on government projects such as the Reconstruction and Development Programme"

Auto workers will resume talks today

PORT ELIZABETH — The National Union of Metalworkers (Numsa) has agreed to meet auto manufacturers at the negotiating table today

The union said it would continue with talks, but the employers' nine percent offer had been rejected by its members

Industrial action is costing the industry R110 million for every working day lost

Talks between Numsa, the Iron and Steel workers union and the Automobile Manufacturing Employers' Organisation broke down last Thursday, with Numsa accusing employers of bad faith

Auto strikes 'cost R100m each day'

CT 10/8/94 Business Editor

192

STRIKES are costing the car industry R100 million a day in lost sales — and the government about R100m a week in tax revenue — Mr Bert Wessels, president of the National Association of Automobile Manufacturers of SA, said yesterday.

Mr Brand Pretorius, managing director of Toyota Marketing (SA), said continued strikes were hitting SA's export markets as well as domestic sales

● Supply shortages stall new car sales growth —
Page 8

Machinery sales booming

Bidely 10/18/94

THE SA Agricultural Machinery Association yesterday predicted a record R1bn in sales of agricultural machinery this year, following the announcement of an 85% increase in July tractor sales compared with tractor sales figures in the same month last year.

Association chairman Gerrie de Jong said the improved sales were due to

the past season's excellent maize crop

192

Tractor sales for the year to date were 60% up on the same period last year, and combine harvester sales were 87,5% higher than those in July last year. "It seems likely 1994 sales of agricultural machinery will top the R1bn mark for the first time ever," De Jong said. — Sapa

**Petronet in ⁽¹²⁾
dispute talks ⁽¹²⁾**

DURBAN — Urgent talks on salaries were held yesterday to resolve a strike by 10 highly-skilled Petronet staff. The petrol pipeline linking Durban and the Reef was re-opened after experienced senior personnel were drafted in to operate the pipe.

The workers went on strike on Monday, complaining they were grossly underpaid.

Sapa 21 10/8/94

Motor workers on the march

CT 10/8/94

~~15~~

192

Own Correspondent

PORT ELIZABETH — National Union of Metalworkers of SA (Numsa) members in the motor industry will be marching here, in Pretoria and East London today to reinforce their wage demands, a union spokesman said last night

After yet another round of motor industry talks yesterday, unions and employers were not prepared to say if they had moved closer to a settlement

The day was marked by singing from the Numsa ranks and signs that a settlement could be imminent — but late last night none of the three involved parties were prepared to make any press statements

This is the first week that hourly-paid workers, who are paid one week in arrears, will not receive any pay packet — based on the no work, no pay policy — but Numsa officials refused to say if this would have any effect on workers returning to work next week

Talks between Numsa, the Iron and Steel Allied Workers' Union and the Automobile Manufacturing Employers' Organisation (Ameo) resumed yesterday, after a breakdown on Thursday last week

After general meetings at the seven manufacturing plants on Monday, Numsa said it would return to the negotiating table — but the employers' 9% offer on industry wages per grade had been rejected by its members

Numsa said the 9% offer was unacceptable and the four-year time-frame for the correction of wages per grade was rejected

Yesterday, neither party was willing to say if there was a new actual wage increase on the table

Earlier in the day, Iron and Steel negotiator Mr Johan Prinsloo said the union supported Numsa's stance on the wage issue, but the union was distressed at how the whole industry had come to a standstill over wages

Supply shortages stall new car sales growth

CT 10/8/94

(192)

By AUDREY D'ANGELO

SUPPLY shortages caused new car sales to fall by 8,3% in July to 16 940 from 18 472 in June, in spite of continued high demand.

And Bert Wessels, President of the National Association of Automobile Manufacturers of SA (Naamsa) said yesterday that the industry was currently losing 1 600 units a day — equivalent to a daily loss of R100m in revenue — as a result of the strikes that began on August 1.

He warned that manufacturers and unions would have to "move away from the adversarial approach" and co-operate if the industry were to survive foreign competition as protective tariff barriers began to fall soon.

Car manufacturers were hoping for stronger sales in the second half of this year after a 24% rise in June which brought them into line with industry forecasts.

Industrial action and public holidays in the first half of the year had kept supply below demand.

But figures released by Naamsa yesterday show that the fall in July kept sales for the first seven months of this year down to 111 468 — lagging behind the 111 743 in the same period last year.

Car sales last month were 2,8% below

the 17 428 in July last year.

The picture for commercial vehicles is brighter. Although sales of light commercial vehicles, at 9 718 were below the 10 137 in June they were above the 8 462 in July last year.

Sales of medium commercial vehicles rose to 342 compared with 299 in June and 257 in July last year.

Sales of heavy goods vehicles were also up in July at 635 compared with 505 in June and 418 in July last year, showing the effect of the economic upturn.

In a statement issued yesterday Bert Wessels said that in addition to lost profits for motor manufacturers the government was currently losing at least R100m a week in tax revenue as a result of the current strikes, and exports were being affected.

He said SA's over-riding need was for a climate of reasonable stability in industrial relations so that the industry as a whole, and the work force, could make their rightful contribution to the growth and development needs of the economy.

Warning that costs would have to be kept down and productivity improved for the industry to remain viable, Wessels pointed out that SA was being reintegrated into the world economy at a time of extensive trade liberalisation.

The industry was facing increased com-

petition from imports as tariff barriers came down, and would have to become more competitive in its export markets as 'export incentives, over time, are reduced and possibly ultimately phased out'.

The Naamsa figures show that Toyota is still the market leader with sales of 3 912 cars and 3 341 light commercial vehicles in July.

Volkswagen came in second place as a car manufacturer with sales of 2 988 cars but only 514 light commercial vehicles and Samcor third with 2 953 cars and 2 155 light commercial vehicles.

Nissan sold 2 785 cars and 2 093 light commercial vehicles, Delta 1 785 cars and 1 441 light commercial vehicles, BMW 1 289 cars and Mercedes Benz 1 785 cars.

Brand Pretorius, MD of Toyota (SA) Marketing, said yesterday that although the removal of protective barriers on imported cars will be gradual, continued strikes could cause SA manufacturers to lose a growing market in sub-Saharan Africa.

German and Japanese manufacturers who are now supplying this market through SA manufacturers could revert to doing it from their home bases if they perceived local suppliers as unreliable. This would cost jobs in SA as well as foreign currency earnings.

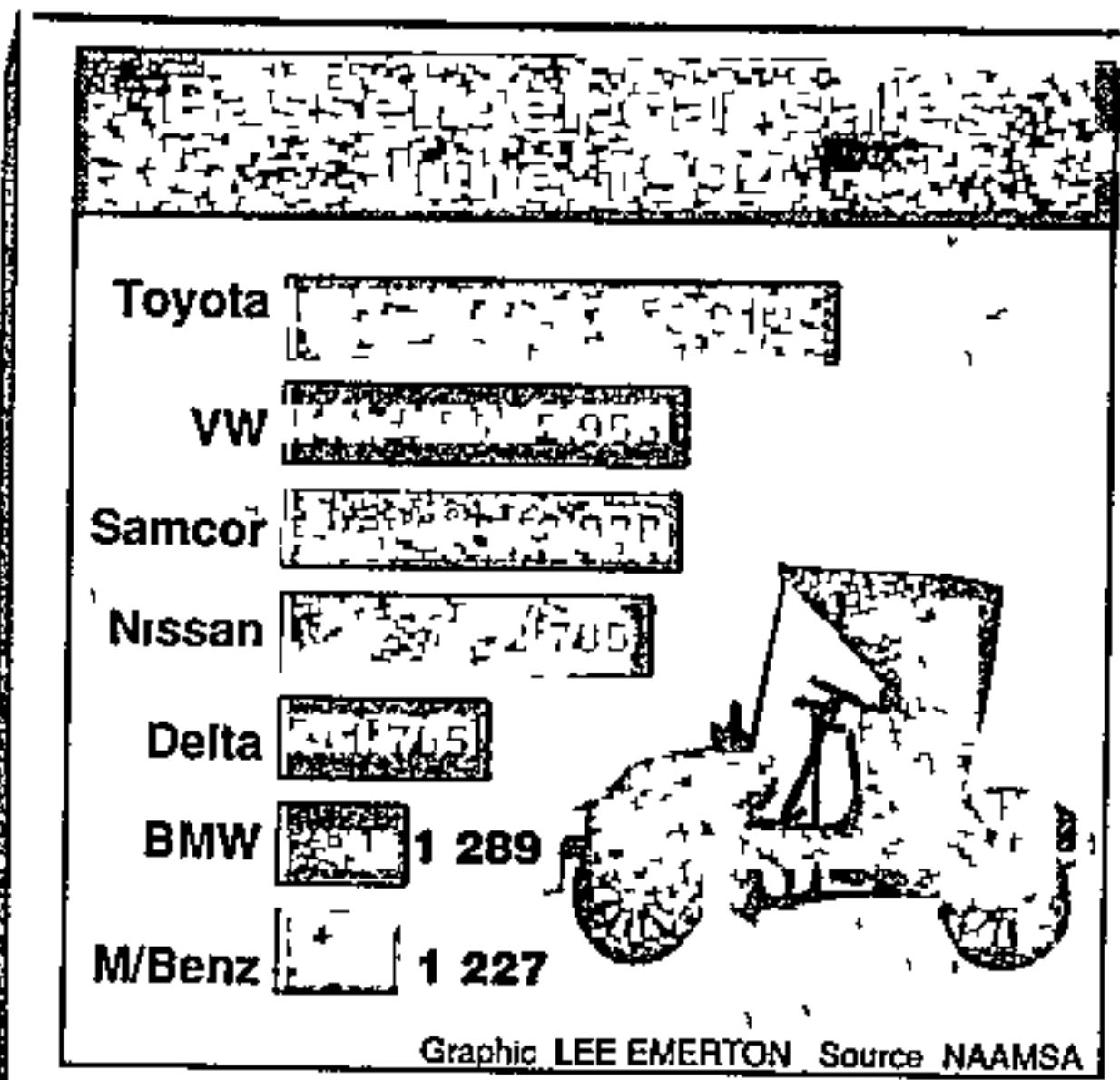

Fewer new cars sold last month

MICK COLLINS

NEW car sales dropped 8,3% last month to 16 940 from June's 18 472 units and were down 2,8% (488 units) on July 1993 figures, the National Association of Automobile Manufacturers of SA (Naamsa) said yesterday. *Biday 10/8/94*

President Bert Wessels said the dip had been caused by stock shortages and many of June's sales being "pre-emptive" because price increases had been expected.

He said the current strike that is crippling the motor industry is costing government about R100m a week in lost tax revenues. Production of about 1 600 units a day is being lost, equivalent to a revenue loss of more than R100m a working day. Seven production days, or 11 200 units, have been lost already. *(192)*

Features of July's car sales included VW slipping from second to third place on the industry log. Nissan dropped to fourth

To Page 2

Cars

Biday 10/8/94

From Page 1

from third slot, while strong sales saw Samcor push from fourth to second place behind log leader Toyota. *(192)*

Sales of new light commercial vehicles and minibuses improved 14,8% (1 256 units) to 9 718 units compared with July 1993 sales. But compared with June sales, light commercial vehicle sales had declined 4,13%. Sales in the low-volume medium and heavy commercial truck segments of the market improved substantially.

Medium vehicle sales rose 33,1% (85 units) against year-earlier figures and heavy truck sales 51,9% (217 units). Sales in both sectors improved 14,4% and 25,7% respectively against June figures.

New car sales were at about the same

level during the first seven months of this year as during the comparable year-earlier period, Wessels said. New light commercial vehicle sales figures were up 5,6% during the period, medium commercial vehicle were up 13,7% and sales of heavy trucks and buses increased 7,7%.

If the new vehicle manufacturing and associated industries were to survive, co-operation between labour and employers would have to improve, Wessels warned.

Numsa members would march in Pretoria, Port Elizabeth and East London today to back their demands, the union said. Negotiations resumed yesterday, but no agreement was reached.

SA car plant to supply Australian market

□ And BMW gears up to make Land-Rover locally

Motoring Correspondent

The BMW car plant in South Africa will in future supply cars for the Australian market and for other markets in the Pacific and Asia

At the same time BMW is gearing up to manufacture Land-Rover products in Transvaal

According to the national daily, The Australian, this change in supply to Australia had been brought about by BMW South Africa gaining the prestigious international quality management certificate, ISO 9002

This was confirmed by a BMW South Africa spokesman

It would enable the company to boost its export levels from its Transvaal plant at Rosslyn and to deliver in Australia in a much shorter time than the present long sea journey from Europe

The newspaper said the South African plant was considering two options — to produce 3-Series sedans for the right-hand drive markets of Australia and

Japan or to build the 316 sedan in right- and left-hand drive forms for the global market

A media visit to South Africa by Australian motoring journalists is scheduled for November

BMW AG in Munich and Rover Group Holdings Ltd in the United Kingdom, have given BMW South Africa the green light to manufacture Land-Rover products in South Africa

Following the recent decision by Rover Holdings to terminate the Land-Rover franchise in South Africa held by Associated Automotive Distributors (AAD), a new company, Land-Rover South Africa (Pty) Ltd, will shortly be formed and will be wholly-owned by Rover Holdings Ltd of Birmingham

This company will import, export and wholesale Land-Rover products in South Africa

AAD will cease Land-Rover operations at the end of November, after which BMW South Africa will manufacture the Land-Rover Defender and Dis-

covery models for the local and African export markets

Last year Land-Rover units were produced in South Africa and 1994 production is expected to top the 1 000 mark BMW expects this figure to increase in the short term as a result of export opportunities and the possibility of certain BMW dealerships in South Africa being granted retail and services franchises on Land-Rover products

An offer by BMW South Africa to acquire the assets of the AAD Land-Rover operations in South Africa was not accepted by AAD shareholders The offer included a substantial premium that would have allowed continued production at the existing Blackheath plant in the Cape

As a result, it is likely that BMW will locate its Land-Rover production facility close to its existing BMW car plant in Rosslyn outside Pretoria BMW and Rover have developed plans to ensure continuity of vehicle supply and after-sales customer support

(192) ARU 10/8/94

130
105
115
823
18.6
6.0
0.2

TV licences up 7%

Political Staff
TV licence fees are to be increased by R13,00 — 7,5% — from October 1, Broadcasting Minister Dr Pallo Jordan announced last night.

With VAT, TV fees will increase from R176 to R189, said Dr Jordan in Parliament during debate on the Broadcasting Services Vote.

Dr Jordan said the effect of the increase would amount to a total fee of 52 cents a day. He also said concessionary licences, mainly for pensioners,

would go up from R50 to R54. These increases had been approved by the cabinet.

Dr Jordan said the 7,5% increase was reasonable and was in line with the inflation rate as well as the SABC's ongoing commitment to improving efficiency.

The SABC was aware of the current economic austerity that placed many households under enormous financial pressure, and this had been taken into account when the new fee was fixed, he added.

Auto strikes 'cost R100m each day'

CT 10/8/94 Business Editor
STRIKES are costing the car industry R100 million a day in lost sales — and the government about R100m a week in tax revenue — Mr Bert Wessels, president of the National Association of Automobile Manufacturers of SA, said yesterday.

Mr Brand Pretorius, managing director of Toyota Marketing (SA), said continued strikes were hitting SA's export markets as well as domestic sales.

● Supply shortages stall new car sales growth —
Page 8

THE government intended placing married women in the same...

By BARRY STREEK

ly joined the Association of African Diplomats, which groups African diplomats...



Linefish
1994 Roolberg Riesling is a wine that will be best enjoyed in its fruitiness.



Unions turn down higher car manufacturers' offer

Star 11/8/94

Port Elizabeth — Car manufacturers, in an attempt to break the crippling motor industry strike, increased their wage increase offer from 9 to 10 percent yesterday afternoon, but said this had been rejected by the unions

Automobile Manufacturers' Employers Organisation (AMEO) acting chairman Harry Gazendam said in a statement that employers had made a 10 percent across-the-board offer based on actual wages and a 12 percent increase for minimum-wage employees

He said that the unions concerned had indicated they could reach agreement at 10,5 percent across the board, but had reverted to their original demand of 12 percent

The AMEO said it believed the latest offer was in the best interests of the industry, the many support industries and tens of

thousands of employees affected by the strike

Employers said earlier yesterday they would not review their original 9 percent offer until the framework for the implementation of a wage policy had been agreed to

The National Union of Metalworkers of SA (Numsa) is demanding that a wage policy framework be implemented within three years, instead of four as suggested by employers

The Iron and Steel Workers Union has proposed that the wage policy framework be referred to a study group

Latest estimates put the cost of the 10-day strike at almost R1 billion. (192) (152)

The employers' latest offer followed a day of tough bargaining between a team of negotiators from employers and Numsa in Port Elizabeth on Tuesday — Sapa (355)



ERICA JANKOWITZ

THE Automobile Manufacturers Employers' Organisation (Ameo) in effect ended wage negotiations yesterday when it failed to meet the unions' compromise demand, leaving no end in sight to the eight-day strike in the motor manufacturing sector

National Union of Metalworkers of SA (Numsa) spokesman Roger Etkind said Ameo had indicated its final offer of a 10% wage increase would not change even if negotiations resumed or the dispute was referred to mediation. Numsa negotiators rejected the offer. The union had dropped its demand from 12% — the point at which a dispute was declared — to 10,5%. No further negotiations have been scheduled. Numsa resolved to continue the strike

Big day No end in sight for car industry strike

until agreement was reached. The union had also agreed to suspend its demand to eliminate wage anomalies and introduce a new wage policy within three years.

After Ameo tabled its 10% offer, Numsa reverted to its 12% demand, and the implementation of a new wage policy 11/8/94

Etkind said the SA Iron, Steel and Allied Industries' Union declared a dispute with Ameo yesterday. Ameo's position would be put to Numsa's vehicle shop stewards' council tomorrow (92) (52)

Numsa strikers marched in Pretoria and East London yesterday, and a march was planned in Port Elizabeth today

XX

Car chief slams report

HENRI du PLESSIS, Motoring Reporter

THE head of Mercedes Benz has lashed out at both the past and present South African governments for lack of a firm policy on local content in the motor industry

The motor industry task group's report on "Phase Seven" of local content was "flawed back to front", chief executive Christoph Köpke said

Speaking at the launch of the new Mercedes Benz C-Class cars in Johannesburg yesterday, he accused the past government of leaving local manufacturers in the lurch and the present one of being unable to formulate a policy

Mr Köpke also attacked the Numsa strike action, saying it had created a lose-lose situation that nobody could afford

"The motor industry is one of the best payers in the country, with a minimum wage of almost R2 000.

"A nurse starts at R1 400 and a policeman at R1 700. If a person who sweeps the floor in a motor car factory is deemed more valuable than them, there is something very wrong here

"The workers, through their strike, have lost far more in wages than they could ever gain with the increase they demand and the government has lost millions in revenue much needed for the reconstruction and development programme"

ARG 11/8/94

Grievances 'not heeded'

PORT ELIZABETH — Social workers in the former Ciskei have gone on strike

Spokesman for the workers in the region, Mr Hlubi Mgidlana, said workers were on strike because their grievances had not been addressed by the Eastern Cape Health and Welfare Ministry

Mr Mgidlana said a list of grievances had been presented to the former government as well as the new administration after the April election

Health Minister in the region, Dr Trudie Thomas, had been told of the deplorable conditions under which social workers worked, he said

The ministry could not be reached for comment

— Sapa

Motor bosses make last offer

Own Correspondent

PORT ELIZABETH. — South African motor manufacturers delivered a final offer ultimatum to striking motor workers yesterday by offering a 10% across-the-board actual wage offer

Automobile Manufacturers Employers Organisation (Ameo) acting chairman Mr Harry Gazendam said the unions had been asking for a final offer for two weeks and this was Ameo's "final, final offer".

No talks are scheduled for today. Manufacturers are waiting for the National Union of Metalworkers (Numsa) to respond.

Ameo delivered a written statement to Numsa that said it was not prepared to negotiate any further and would not enter into mediation

Union officials said yesterday they had dropped their actual increase demand from R12% to 10,5%, but the employers would not go beyond 10%.

The predominantly white Iron and Steel Workers union closed ranks with Numsa yesterday, saying it had declared a dispute with the employers for the first time since the start of negotiations.

Ford in bid for Samcor slice

CT 11/8/94 (192)

From MICK COLLINS

JOHANNESBURG — US motor group Ford is negotiating to buy a major slice of Anglo American-controlled vehicle manufacturer Samcor, marking its return to SA after six years

Ford executive director Martin Inglis told a news conference in Johannesburg that Ford officials had held discussions with Anglo, Anglo American Industrial Corporation (Amic) and the Samcor Employees' Trust to determine the best means for reinvestment

The company aimed to take a share of the 76% Samcor equity held by Anglo and Amic, and/or part of the remaining equity held by the Samcor employees

Inglis said Ford wanted to secure a stake in the R3bn-a-year company equal to that jointly held by Anglo and Amic. Negotiations were continuing and a final decision was expected "within the next few months". He refused to put a figure on the transaction

Amic chairman Leslie Boyd said Ford's return was important to

Samcor's future, but the details still had to be concluded. Samcor assembles Ford, Mazda and Mitsubishi vehicles at its plant in Pretoria. Inglis said Mazda and Mitsubishi had been informed of the negotiations and Ford would like Samcor to maintain these contacts. The Trade and Industry and Finance Departments had also been kept informed.

Ford Canada established Ford SA in 1933. It was merged with Anglo's and Amic's automotive operations to form Samcor in 1984.

Equity interest

Ford divested its equity interest in Samcor in 1988, donating most of that holding to the Employees' Trust, which was established for the benefit of Samcor's workforce. The negotiations also hinged on the future of the motor industry in SA. "One area of concern to us is where SA's automobile policy is going." The industry was not efficient by world standards and increased volumes and better productivity would have to be examined.

Mercedes CE warns government

B/Dey 12/8/96

Own Correspondent

PORT ELIZABETH — A dramatic warning that government must act urgently on new local content rules or SA will be in danger of losing its multibillion-rand motor industry, sparking huge unemployment, has been issued

Mercedes-Benz SA CE Christoph Köpke fired the hardest-hitting attack yet on government dithering and "vested interest" in a key report on the industry, at the launch this week of the new C-Class Mercedes in Johannesburg

His biggest fear, he said afterwards, was that the trickle of completely built up trucks and cars would turn into a flood, negating the huge investments made by local manufacturers

Köpke said at the launch his company was already questioning whether it should have undertaken its recent R35m investment in a truck plant and R130m in a paint

shop It may have been better just to have imported vehicles, he said

The reason was that there were just too many rules governing the industry and allowing new operations to bring in completely built up vehicles.

"Do we have 10 rules or one rule governing the industry?" he asked

Köpke was also highly critical of the specially appointed Motor Industry Task Group set up among vehicle manufacturers, component suppliers and other interested organisations

The report has made recommendations on the proposed Phase 7 of the local content programme

Köpke said the report and recommendations it had given to the Board of Trade and Industries were "flawed" and loaded with

"vested interests", despite it supposedly being representative

One problem with the report, said Köpke, was that it had been drawn up without taking into account the effects of SA having joined the international General Agreement on Trade and Tariffs accord

Another was that it had not taken into account that Phase 6 of the local content programme had not been allowed to run its course

Mercedes SA felt that, instead of a new phase being introduced, Phase 6 should be modified, with deregulation introduced over a period of possibly eight years

The most pressing need, he said, was for a policy making it clear whether the future of the industry lay with completely knocked down vehicles, semi-built up vehicles or completely built up vehicles

Strong sales rise at Saficon

MOTOR and building materials group Saficon had seen a strong rise in sales and earnings in the first four months of its 1995 financial year, chairman Sidney Borsook said yesterday.

Though there had been a fall in working days in April and May, Borsook told the company's annual general meeting that turnover was up 18% on the same period last year. Estimated income was also above last year's level and above budget.

But he warned that the motor strike could still restrain earnings growth this year, unless the dispute was settled soon.

"The impact of strikes at motor plants will no doubt affect our ability to sell and deliver new vehicles," he said. "The extent of this depends on how long the strikes will

Business Day Reporter

last as well as what will be done to make up the lost production over the remainder of the year. *BIDC 12/18/94*

"Assuming these strikes are settled within the next 10 days, and considering the benefit that the group is deriving from the resurgence in home construction, we expect to achieve the budgeted improvement in Saficon's results for the year."

The company secured a fourfold earnings increase in the year to March, posting attributable income of R22.5m on sales 7% ahead at R2.9bn. *(33) 192*

The performance lent heavily on a stronger showing from building materials arm Boumat and motor business.

MERCEDDES-BENZ OF SOUTH AFRICA (PTY) LTD

Star 12/8/94

REPORT ON AUTOMOBILE INDUSTRY STRIKE

INTRODUCTION

Over the last few years the Employers and NUMSA have concluded many complex and far-reaching agreements at the National Bargaining Forum (NBF). This has been in response to the crisis facing the Motor Industry caused by the threat of greater international competition and instability in the industry. There is serious concern that some companies may not survive. The National Bargaining Forum has an important role to play in formulating broad based strategy, ensuring that efficient support structures are in place to support operational needs and that fair conditions of employment are in place. The inability to-date to successfully implement the complex agreements reached is creating serious concerns in the workplace. NUMSA and the employers are going to have to carefully reassess the situation. If these problems are not sorted out at the NBF the future of the motor industry will be seriously threatened as well as the job security of thousands of employees.

EMPLOYER OFFER



- The two key proposals of the employers offer are:
1. A proposal that a long term agreement on a new Wage Model should be referred to a Working Group, rather than creating another complex agreement before the basics are in place and the proper research done.
 2. An offer by the Employers of a 10% increase on actual rates earned.
- An offer by the Employers of a 12% increase on industry minimum rates.

GRADE	MBSA CURRENT MINIMUM	INCREASE	NEW MINIMUM (+10%)	MINIMUM WEEKLY EARNINGS	*MINIMUM MONTHLY EARNINGS
1	R10,59	R1,06	R11,65	R466,00	R2019,00
2	R11,05	R1,11	R12,16	R486,40	R2107,00
3	R11,58	R1,16	R12,74	R509,60	R2208,00
4	R11,87	R1,19	R13,06	R522,40	R2263,00

* Exclusive of year end gratuity - 8 1/3% of annual wage.

* (Based on an average 4.33 week month)

NUMSA made it clear to the employers that it could reach a settlement on a 10,5% increase. However, if no agreement was reached there would be a protracted strike which could result in the closure of some companies. The Employers responded that a 10% increase on actuals and the 12% increase on industry minima, together with the high costs incurred in implementing the current NBF agreement was a very good offer and not subject to further negotiation or mediation. The Employers stressed the importance of NUMSA and the Employers successfully implementing the current plans at Plant level to form a sound basis for future developments.

SUMMARY REPORT OF MBSA - EL PLANT AGREEMENT PRIOR TO THE INDUSTRY STRIKE

"The goal is that MBSA be the most efficient manufacturer of motor vehicles in South Africa by 1996 as a first step towards meeting international competition"

Some Examples

1. Agreement to improve existing Quality, Quantity and Plant Performance standards and plans in line with the drive towards becoming a world class manufacturer. Meeting the standards results in an extra bonus payment of 6 weeks pay a year if standards are met and more than 6 weeks bonus if standards are exceeded (6 weeks bonus equals 11,5% of an employee's annual wage).
2. Plans to dramatically lift the skills of all operators by 1997 and training in specialised fields for Shop Stewards at a combined cost of approximately R5 million per annum, in order to support the goal of becoming a world class manufacturer. This is in addition to existing training plans and costs.
3. Plans to improve the current housing scheme by facilitating the building of 1000 houses closer to the workplace to ensure a better quality of life.
4. A structured process of communication and participation has been agreed to where Management, Union and all employees will be able to better participate in the drive towards becoming a world class manufacturer.

COMMENT

MBSA has tangible plans to improve the company's performance which are in line with the objectives agreed at the NBF. Through broad consultation throughout management and the representative structures, the Manufacturing Strategy was developed to give effect to the objective of becoming the most efficient manufacturer in the South African Motor Industry. The recent in-plant agreement with NUMSA was agreed to in line with the overall Manufacturing Strategy. MBSA needs the NBF, as a matter of urgency, to put in place the supporting resources for delivery of training, skill modules etc.

CONCLUSION

The Automobile Industry National Bargaining Forum, like many other structures in South Africa, is going through a difficult transition. MBSA appeals to all its employees to understand the difficulties and accept that the current offer is the best offer under the circumstances. There are problems which will be resolved but we must not let those problems threaten the future of the Company and all employees.

Management wish to resume normal production as soon as possible and need the support of every employee. We sincerely regret the hardship and inconvenience caused to our employees, customers, dealers, suppliers and the many other people affected by the strike.



Mercedes-Benz

C KÖPKE

CHAIRMAN

MERCEDES-BENZ OF SOUTH AFRICA (PTY) LTD

RI RUSSEL

MBM: MANUFACTURING AND HUMAN RESOURCES
MERCEDES-BENZ OF SOUTH AFRICA (PTY) LTD

MOTOR INDUSTRY
Profits strike-out

Vehicle manufacturers are busy revising sales and profits targets as they assess the full impact of production losses suffered in the motor industry strike

Manufacturers say they have lost a combined R100m a day in revenue during the strike. The good news is that much of that is simply deferred and will arrive later once production and sales revive. In addition, though it's a small percentage of total production costs, the saving on wages during the strike is not insubstantial.

On the other hand, in addition to immediate revenue losses, manufacturers face rising bills for excess inventories. While local and overseas suppliers have done their best to reschedule deliveries, many warehouses are well overstocked and companies face unexpected interest payments.

But these are short-term financial problems. Bert Wessels, CE of Toyota and president of the National Association of Automobile Manufacturers, says the greater threat is to the industry's long-term survival.

"If the new vehicle manufacturing and associated industries are to survive, let alone remain viable in the future" he says, "it is imperative there should be a move away from the adversarial approach to industrial relations to one of closer co-operation between labour and employers" (192).

The local industry has quite enough on its plate, reintegrating into the world market and facing increased domestic competition, without creating further obstacles to its survival.

As latest sales figures show, domestic sales are already under pressure. July car sales were down and though commercial vehicles performed strongly, it was probably a temporary last hurrah before the effects of the strike are seen in the August figures.

Even when full production resumes, it will take time for manufacturers to make up lost ground and marketers are divided on prospects for 1994 as a whole. VW marketing director Graham Hardy and Nissan Marketing's John Jessup are both resigned to a smaller-than-expected market for the year.

FINANCIAL MAIL • AUGUST • 12 • 1994 • 59

BUSINESS

On the other hand, Samcor Marketing MD Arthur Mutlow, buoyed by healthy July sales of his company's products, remains confident this year's market will outdo that of 1993.

Interestingly, Samcor's figures for the first time include combined sales for the Ford Telstar and Mazda 626 and for the

small Fords and Mazdas, too. In the past, each range was listed separately (192).

Given that the biggest difference between local Fords and Mazdas is the badge on the front, the decision is not a surprising one. ■

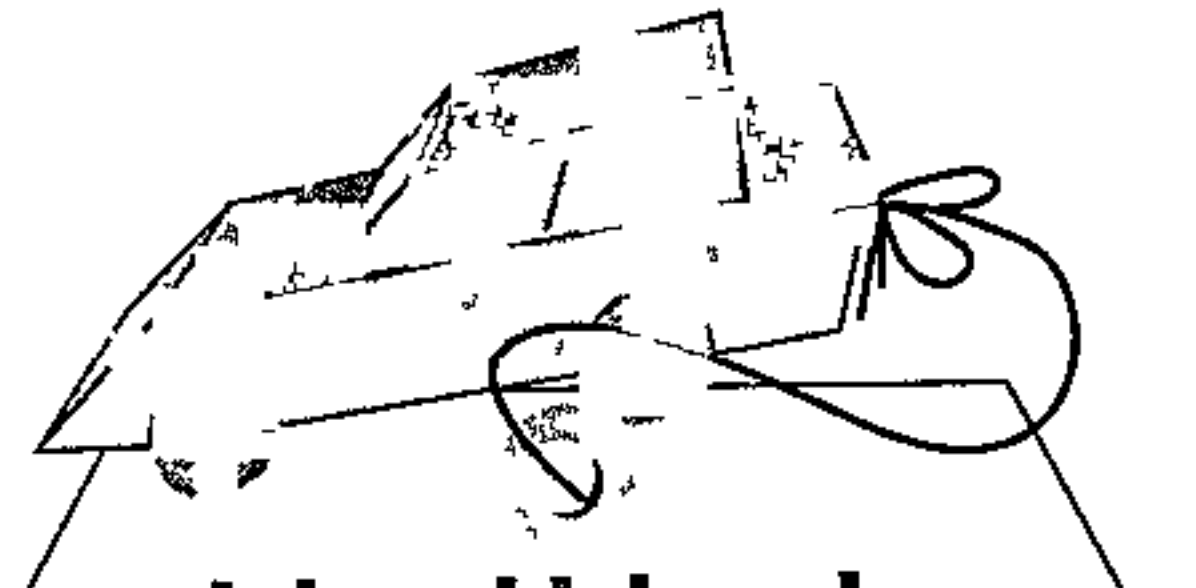

July vehicle sales

Cars	Total	%*
Corolla /Conquest 3 008, Camry 897, other 7		23,1
Golf /Jetta (new) 1 496, City/Fox 1 246, Golf /Jetta (old) 100, Audi 146		17,6
Laser/ Meteor/ 323 1 858, Telstar/ 626 1 006, other 89		17,4
Sentra 1 696, Maxima 119, 200SX/300ZX 3, Fiat Uno 967		16,4
Astra/Kadett 1 655, Monza/ Kadett 100, Rekord 26, Calibra 4		10,5
3-Series 1 054, 5-Series 182, 7-Series 53		7,6
Honda Ballade 946, M-Benz W124 229, W140 48, other 4		7,2
Legacy 1		0,0

*% of the total car market

	1994	1993	% Change
July	16 940	17 428	-2,8
Jan - July	111 468	111 743	-0,2
June (18 472) - July			-8,3

Light commercial
 Toyota 3 431 (35,3% of the market), Samcor 2 155 (22,2), Nissan 2 093 (21,5), Delta 1 441 (14,8), VW 514 (5,3), AAD 84 (0,9)

July	9 718	8 462	+14,8
Jan - July	59 176	56 031	+5,6
June (10 137) - July			-4,1

Medium commercial
 Toyota 138 (40,4%), Delta 83 (24,3), Samcor 54 (15,8), Nissan 45 (13,2), M-Benz 17 (5,0), Iveco 4 (1,2), AAD 1 (0,3)

July	342	257	+33,1
Jan - July	1 898	1 670	+13,7
June (299) - July			+14,4

Heavy commercial
 M-Benz 319 (50,2%), Toyota 98 (15,4), Nissan 75 (11,8), MAN 51 (8,0), Delta 30 (4,7), Tyco 27 (4,3), ERF 18 (2,8), Iveco 17 (2,7)

July	635	415	51,9
Jan - July	3 068	2 848	7,7
June (505) - July			+25,7

Total light and medium commercial
 Toyota 7 579 (77,4%), Samcor 5 162 (18,7), Nissan 4 998 (13,1), VW 3 502 (12,7), Delta 3 339 (12,1), M-Benz 1 560 (5,7), BMW 1 289 (4,7), other 203 (0,7)

July	27 635	26 565	4,0
Jan - July	175 610	172 292	+1,9
June (29 413) - July			5,0

Source: NATIONAL ASSOCIATION OF AUTOMOBILE MANUFACTURERS OF SA

Component industry hit

CT 12/8/94

192

192

Own Correspondent

JOHANNESBURG — The motor component industry will lay off 4 500 to 5 000 workers — 10% of its workforce — from Monday if the motor sector strike was not resolved by the weekend, the National Automotive Component and Allied Manufacturing Association (Naacam) warned yesterday

Naacam president Mr John Brandtner said the R4,3bn-a-year industry was losing R20m a day to the strike which started on August 1. The impact was being felt by more than 44 000 workers in 160 companies.

“By Monday the industry will have built up a surplus inventory and we will see companies closing. Some companies could close for a week while others could go onto a two-day week.”

But for smaller manufacturers,

5 000 set to lose their jobs

who had struggled with recession for the past four years, the strike could be “the final straw”

Sources estimated that motor manufacturers would have to fork out R600 000 a year to meet the difference between the employers' 10% wage offer and the unions' 10,5% compromise demand. But the strike was costing each of the nine manufacturers between R9m and R17,5m a day in lost turnover.

Both the Automobile Manufacturers Employers' Organisation (Ameo) and the National Union

of Metalworkers of SA (Numsa) indicated the strike would continue indefinitely.

Numsa national organiser Mr Gavin Hartford said the 10% offer would be discussed at a shop stewards council meeting today, but he was sure workers would vote against it. Numsa reverted to its 12% demand on Wednesday after employers refused to meet its 10,5% compromise position.

Ameo acting chairman Mr Harry Gazendam said the employers' final wage offer of 10% on actual wages and 12% for those earning minimum rates was excellent.

On the issue of major corporations setting ceilings on settlement levels, Mr Gazendam said he had never been contacted by Anglo American or Samcor to limit the wage increase.

Sapa reports that about 1 000 Numsa members marched in Port Elizabeth yesterday to present a memorandum to employers for a 12% wage increase.

Car sector 'heads for scrap'

SI Times (Buss)

THE motor industry has been warned that its continued existence is at risk if it continues to be hit by strikes

In a hard-hitting statement, Bert Wessels, president of the National Association of Automobile Manufacturers of South Africa (Naamsa) says that if "the propensity to strike continues, motor manufacturers will be reluctant to invest further and some might elect to withdraw from the market

"Strikes are endemic in our industry and we must move away from this adversarial approach to industrial relations if we are to survive."

Labour Minister Tito Mboweni is due to meet unions and management this weekend

More than 25 000 members of the National Union of Metal Workers of SA (Numsa) have been on strike for the past two weeks

The Automobile Manufacturers Employers' Organisation (Ameo) ini-

By DON ROBERTSON

14/8/94

tially offered 9% across the board, but has increased this to 10%, with 12% for the lowest paid workers. Employees began negotiations with a 23% demand, but reduced this over a number of weeks to 10,5%. Talks broke down for the second time on Wednesday and Numsa reverted to its demand for 12% (192)

Other matters on the table have been resolved. Employers have agreed to an adult education programme costing R100-million over the next eight years, while a programme to consider the wage gap between skilled and unskilled workers has been postponed until next year

Ameo is now adamant that it has made a final offer, which is well above the inflation rate and based on the exceptionally high levels of re-

muneration in the industry

If the strike is not resolved within days, component suppliers could be forced to lay off workers

The labour action is costing the manufacturing industry more than R100-million a day in lost production, while assembly workers are losing R3,5-million in wages. The government forfeits R20-million in taxes each day from lost sales, adding to the R200-million lost this year through labour unrest

The average wage in the industry is R1 934 a month. A 10% increase will lift this to R2 127, excluding fringe benefits which average R893 a month. The 10% offer will cost the industry R61-million a year in direct wages and a further R24-million in fringe benefits adding to the current R961-million wage bill, says Ameo

Numsa was unavailable for comment on Friday

SA motor industry moves to halt car theft and hijackings

■ BY MANDLA MTHEMBU

Police and the motor industry plan to join forces in the fight against car hijacking

Gauteng Safety and security MEC Jessie Duarte, provincial Police Commissioner Sharma Maharaj and representatives of the Motor Industries Federation (MIF) will meet tomorrow at the Wanderers Club Ballroom to establish mechanisms to combat hijackings of delivery vehicles and armed robberies at service stations

The SA Insurance and SA Insurance Brokers as-

sociations will also be represented at the meeting

MIF divisional manager Robert Kaiser said the industry has realised that law enforcement resources available to the authorities have been stretched to the limit and "it was time for business to help police in fighting crime"

He said the motor industry would submit recommendations on how business could be involved in combatting crime

Kaiser said escalating crime has resulted in a considerable loss of life and injury

(192) Stan 1/8/95

2 major car makers cut production

(192) ARG 10/8/95

JOHANNESBURG. — Two leading vehicle manufacturers have cut back production after a boom in the first six months of the year saw new car sales rise by 21 percent against the same period last year

Toyota South Africa yesterday said it had closed its Durban Prospecton plant for five production days, from August 4 to August 11, to balance stock.

Nissan has made short-time arrangements and employees are working a four-day week this month

Toyota spokesman Dave Houghton said that in the first half of the year it had raised production to a four-year high to meet increased demand.

Nissan spokesman Johan Kleynhans said the cut in work hours was to allow for maintenance at its Rosslyn, Pretoria, plant and the commissioning of a new Fiat Uno production line.

Volkswagen and Samcor are operating normally and have no immediate plans for short-time arrangements

Car demand expected to fall

Toyota shuts Durban plant for a week

MD 10/8/95 (192)

Renee Grawitzky

TOYOTA, SA's leading motor manufacturer, has announced it closed its Durban plant this week because, after record production levels, it is expecting demand to decline.

The Prospecton plant has been closed from Monday.

The National Union of Metalworkers of SA's negotiator in the motor industry, Tony Kgobe, said Nissan had also embarked on short-time arrangements this week with workers working a four-day week for the next four weeks. However, Nissan could not be reached for comment.

Companies such as Volkswagen and Samcor are operating normally.

After the boom in the first half of the year, with new car sales 21% higher than the same period last year, there have been warnings that higher interest rates would affect second-half sales. Samcor cut prices of Ford, Mazda and Mitsubishi vehicles by 15% last month.

Toyota said that, with the increase in vehicle sales during the first half of the year, it had increased production to "record levels and enjoyed a high level of production stability."

The company realised that the "market was overheated and was likely to pass through a correction phase in the second half of the year." Toyota said the correc-

tion phase had commenced and the closure of the plant for five days was to allow production to be balanced.

Toyota said it believed that it was not alone in temporarily shedding production. "The industry as a whole will be affected by the softening in the market."

Kgobe said "It was the union's perception that companies such as Nissan and Toyota had to embark on short-time arrangements because they over-produced in the first half of the year in anticipation of workers going on strike around this time — as did occur last year."

He said normally companies in the industry budgeted for a strike and increased production in the first half of the year so that by the time the strike occurred "they have stockpiled."

In July, unions and motor manufacturers signed a three-year wage deal expected to bring peace to the industry.

Nico Vermeulen of the National Association of Automobile Manufacturers of SA (Naamsa) said the economic fundamentals facing the industry remained positive.

He said Naamsa had however warned the industry that "some consolidation in the new vehicle market was inevitable given the above average sales experienced in the first half of the year as well as the recent interest rates increase." Year-on-year sales remained well ahead and were higher than last year's sales.

Car industry deal worries Swazis

John Dlodlu

(192) (212)

DN 10/8/95
ey into well-developed SA and Botswana before the long-term plan came into effect, due to better locations and incentive packages offered by those countries

SWAZILAND Commerce Minister Majahinkaba Dlamini said the agreement on the southern African region's auto industry could deprive his country of an opportunity to develop its fledgling car industry

He said in terms of the deal reached with counterparts at the five-nation Southern African Customs Union — which includes SA, Lesotho, Namibia and Botswana — all members had to submit motor industry development plans by the end of this year

The long-term plan stipulated foreign firms, wishing to set up manufacturing plants within any country in the customs union area, would have to apply to the ministers' council, one of the new structures to be set up

Dlamini's concern was that major car-makers would continue to pour their mon-

This might thus create uncertainty about applications of several foreign auto companies considering setting up shop in Swaziland. These firms might change their minds, and start operations in SA

"Once located in one country, it's difficult to relocate," Dlamini said

He called on other partners to "be more considerate" to less developed fellow regional members

Trade and Industry Minister Trevor Manuel's spokesman Ismail Lagardien said, in an apparent bid to allay fears, that SA remained committed to negotiating the agreement with minimum disruptions and SA was determined to assist other partners to develop an industrial base

BUSINESS

VW CHICO'S ARE WINNERS

See below 10/8/95
1992

By Musa Zondi

FOR three months running now, VW has topped the new car sales lists after the launch of its Chico series, one of the cheapest models on the road.

The National Association of Automobile Manufacturers of South Africa says new car sales in July of 18 676 units showed a decline of just over 1,000 vehicles, compared with last month's figure of 19 781 units

VW sold 4 469 units, Toyota 3 217, Sannor (Mazda-Ford) 3 158, Nissan 2 421 units, Mercedes-Benz 2 089 units, Delta 1 881 units and BMW 1 440 units. "The new car market has been sup-

ported by the continued solid performance of recent competitively priced small car introductions," said Naansa. However, a mixed picture is emerging in the new car sector with certain segments experiencing a build up of stock at dealer level

A total of 10 670 light commercial vehicles were sold, an increase of 959 units on June sales.

Naansa says new vehicle sales for the first seven months of this year are up by 22 percent compared with last year

While VW may be consolidating its position at the top, Toyota which usually occupies the slot says it is not getting involved in the bottom end of the market and in a possible price war

Expanded

Mr Bert Wessels, executive chairman of Toyota SA, said recently that while the market has really expanded at the bottom, it is a market in which Toyota cannot compete

"The idea of affordable cars does,

“The idea of affordable cars does, however, go beyond pure base models”

however, go beyond pure base model 'entry level specials' Models that have a high level of added value in terms of specification can also address the issue of affordability," he said

He said Toyota was not worried about losing market share. It intended selling 100 000 units by the end of the year

Nissan SA looks to extend reach to the rest of Africa

Star 11/8/95 (19/2)

■ BY ROY COKAYNE
STAFF WRITER

Nissan South Africa is involved in negotiations with Nissan Motor Company of Japan about expanding its market on the African continent

Johan Kleynhans, the Nissan South Africa general manager for public relations, said this involved right-hand-drive markets in sub-Saharan Africa

It is expected that these negotiations could be concluded before the end of the year, possibly even before Nissan South Africa is listed on the JSE on October 24.

Nissan SA already exports right-hand-drive vehicles to Botswana, Namibia, Zimbabwe, Zambia, Malawi, Lesotho and Swaziland, but it is believed the company is also looking towards eventually exporting left-hand-drive vehicles into other parts of Africa

The export thrust forms part of Nissan Japan's efforts to overcome the adverse effects of the rising yen on overseas markets

Nissan Japan has already stepped up exports from other

manufacturing centres elsewhere in the world. For instance, it has begun shipping UK-produced vehicles to the Middle East

Nissan Motor Company in Japan has also succeeded in slashing the average time required for the development of a new vehicle by almost 30 per cent. It now takes about 26 months from design to production for a new vehicle compared with 37 months previously.

Reduction

Nissan Japan said the cost reduction programme was designed to make its vehicles more price competitive on the Japanese and overseas markets in the face of a depressed local market and the rising value of the yen, which was affecting exports

He said it would obviously result in a cost saving because the cost of developing a new vehicle was time related — and this saving could be passed on to the customer

But, he said, the biggest advantage locally of a reduction in the development time for

new vehicles was that it meant South Africa would in future get new vehicles sooner

New vehicles that were to be manufactured in South Africa first had to go through test procedures related to local road conditions, climate and speed, he said. These determined the cooling system, suspension and tyres fitted to the local versions of the vehicle while the localisation of any components was also examined

Nissan Japan has also introduced a "lean distribution system" as part of its vehicle cost-cutting efforts

Under this system, dealers no longer need to hold vast vehicle stocks

Through a computer system, customers can access vehicles being manufactured and make their choice of vehicle, colour, specification level and expect delivery within three days

Kleynhans said Nissan SA's manufacturing plant probably built more models per plant than any other plant in the world. This ranged from the Fiat Uno to heavy commercial vehicles

Rough road ahead for Daimler-Benz

(192) WM(BSM) 11-17/8/95

Rick Atkinson in Berlin reports on the tough times facing Mercedes' parent company

FOR Daimler-Benz, the industrial giant that likes to project an image as sleek and powerful as the company's Mercedes sedans, the summer of 1995 has begun to resemble a big, ugly car wreck.

After climbing back into the black last year following the disastrous recession of 1993, Germany's biggest corporation once more is swamped with red ink. Daimler announced in late June that the ever-stronger German mark and various restructuring problems are likely to cost the company "well over one billion marks" (\$725-million) this year.

Coming barely a month after a rosy forecast by outgoing chairman Edzard Reuter, the bad news shocked analysts, sent Daimler stock tumbling nine percent, and set stockholders muttering.

The company has cut 72 000 jobs in three years, with at least 13 000 more to go, tension may be highest at Daimler's Stuttgart headquarters, where efficiency experts are trying to whittle a central office staff of 1 200 down to 290.

As if that were not bad enough, backbiting among senior executives has spilled into the open. In a 76-page diatribe leaked to a business magazine, former finance chief Gerhard Liener accused Reuter of being an

arrogant, self-aggrandising fool who was "first of all interested in (his) own image and only secondarily interested in the image of our company."

For his impertinence, Liener was fired from his sundry positions, including chief adviser to the chairman and president of subsidiaries in South Africa and Mexico. Finally, demonstrating a *dolce vita* flair that Daimler probably could live without, new chairman Juergen E. Schrempp (50) in mid-July was detained in Rome during a boister-

ous night on the town involving red wine and a female companion using what the police report calls "unfortunate language."

Company officials explain the Daimler-Benz ailment as a sort of growing pain. A corporation that for years embodied German industrial conservatism in building fine, big cars for fine, wealthy people has diversified into aerospace, electronics, financial services and other areas — with chequered results.

Daimler has also acknowledged competitive market realities by becoming a more aggressive global player.

The best news of this gloomy summer underscores the point. In mid-July Daimler snared one of China's more coveted business deals, a \$1-billion project to build 60 000 minivans and 100 000 engines a year in southern China. In edging out Chrysler and Ford, the company described the contract as "a breakthrough" in tapping the Chinese market and in flexing Daimler's muscles in Asia.

The company also asserts that the doldrums otherwise making life difficult in Stuttgart will fade with the summer, and that "a clear return to profit" in 1996 is "highly probable."

Few doubt that if Daimler is to retain its traditional position as the flagship of German industry, the company paradoxically will have to look "less German", as one official in Stuttgart put it.

reportedly will add about 10 percent to costs in the next two years — the company is rapidly shifting production, purchasing and marketing activities abroad.

Mercedes-Benz, which accounts for two-thirds of Daimler's total business, will soon begin building a new sport-utility vehicle at a plant in Alabama. A new small car for urban driving, dubbed the Swatchmobile because of Mercedes' partnership with the Swiss watchmaker, will be built in France.

Daimler expects to build 10 percent of its vehicles outside Germany by the end of the decade, compared with two percent last year. The company, which now buys 20 percent of its supplies outside Germany, says it will increase that to at least 30 percent.

The new regime, headed by Schrempp, now acknowledges that parts of the company remain quite sick. Daimler spokesman Roland Klein cited "two areas where we're not happy": Daimler-Benz Aerospace, which accounts for 16 percent of Daimler's business, and AEG, which accounts for 10 percent.

For Mercedes, still the heart of the company, the picture is better. Sixty percent of the company's lucrative truck and commercial vehicle production is already outside Germany, with plants in Brazil, Argentina, Turkey, the United States and elsewhere. Slowly but steadily, the slogan "made in Germany" is being supplanted by "made by Mercedes" — *Washington Post*



Jurgen E. Schrempp: Detained by police after a night out in Rome

man and president of subsidiaries in South Africa and Mexico. Finally, demonstrating a *dolce vita* flair that Daimler probably could live without, new chairman Juergen E. Schrempp (50) in mid-July was detained in Rome during a boister-

MOTOR INDUSTRY

(192)
FM 11/8/95
The numbers game

Official new car sales figures may soon give a more exact picture of the market. Despite the current spate of imported models, which is likely to increase as import tariffs decline, industry figures now include only the seven main manufacturers and a tiny handful of others, including Subaru car imports and some commercial vehicles.

The National Association of Automobile Manufacturers (Naamsa), which publishes the figures, has access only to the sales of its members. It is estimated that nonmembers, which include Hyundai and Volvo, could account for another 5%-10%.

To generate "as complete a picture as possible" of the real market, which is a leading economic indicator, Naamsa says it will waive membership as a requirement for other companies which want their results published. Scania Trucks has already agreed to disclose official sales at the end of this month and McCarthy Motor Holdings is expected to follow suit on Peugeot car imports later this year.

The real prize, though, would be Hyundai. Officials of the Botswana-based assembler claim monthly sales of more than 1 000. Like other companies with unaudited and unpublished figures, its reluctance to "come clean" leaves its claims open to doubt. Official figures would lay those doubts to rest.

What isn't in doubt is that though vehicle sales for the year remain well ahead of 1994 levels, the surge of the first six months is not being maintained. Nissan Marketing MD Stephanus Loubser attributes last month's slowdown to rises in interest rates and pre-emptive June buying ahead of traditional July price rises. He remains confident about market prospects for the rest of the year.

Big winner last month was Samcor, which leapt to second place in overall sales on the back of strong demand for its new budget-priced Ford and Mazda cars.

□ Internationally, German carmaker BMW has announced sales worth DM23,3bn in the first half of 1994. That figure includes the BMW and Rover product stables. Combined production was 587 000 units. Despite sales growth being constrained by a drop in foreign currencies' value against the Deutschemark, the after-tax interim profit of DM305m was slightly up on 1994. ■

Lower import duties mean cheaper cars

WILLEM STEENKAMP
STAFF REPORTER

AN increase in the importation of cheap, fully-assembled cars was expected as duties on motor vehicles had fallen, the National Association of Automobile Manufacturers (NAAMSA) said yesterday

As a ship containing 600 Rumanian-built Dacia vehicles — priced at between R35 700 and R45 000 each — wanted to dock in Table Bay yesterday afternoon, NAAMSA spokesman Mr Nico Vermeulen said the SA motoring industry could expect to see more imports of low-priced vehicles

This was stimulated by a 39% drop in real terms, from 100% plus a 15% surcharge to 70%, in the import duty on motor vehicles in the past year, and it was expected that the duty would drop further

"With the reduction of import duties, the industry anticipates an increase in the number of imports

ET 16/8/95

"However, we would like to ensure that these vehicles are not being dumped on the SA market," Mr Vermeulen said

It was essential that such vehicles met SABS safety standards, and buyers should be aware of after-sales service and spares availability

Mr Rasse Erasmus, sales man-

(192) ~~ET~~

ager for Dacia-Africa, said his vehicles' prices included all shipping costs and the 70% import duty

He said the cars had been rigorously tested in Rumania, were "basic" and not filled with electronic gadgetry, and would be sold with a three-year or 100 000km warranty

Rumanian vehicles roll in

(192) )
STAFF REPORTER
CT 17/8/95

THE offloading of 600 Rumanian-built vehicles, which will be substantially cheaper than other available makes when they go on sale on September 1, started in Table Bay Harbour yesterday

Four models of the Dacia — which have Renault engines, gearboxes and differentials — will be priced between R37 500 and R45 000, Dacia Africa general manager Mr Chris Thornton said yesterday

He said indications were that the vehicles would be snapped up almost immediately, and he was placing a second order "straight away"

He was confident the Dacias would cope with local conditions, as eight had been extensively tested in the country for the past year

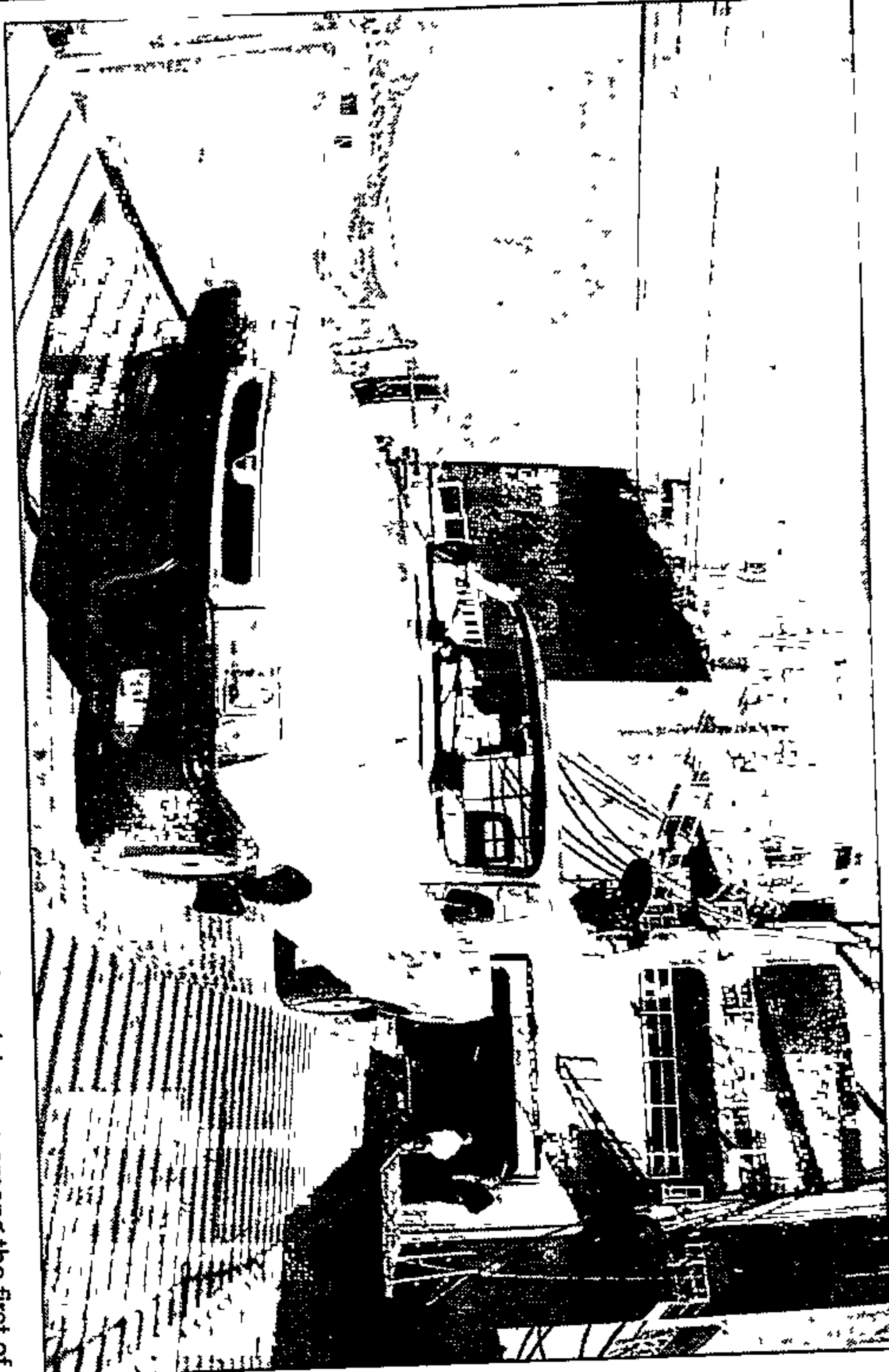

RUMANIAN BAKKIE: This Rumanian-built Dacia bakkie, one of four imported models, was among the first of 600 vehicles to be offloaded in Table Bay Harbour yesterday. The models, three bakkies and a station-wagon, will cost between R37 500 and R45 000, say the importers

PICTURE: NIC BOUTHMA

nd
ve
in
of
re
n-
n-
is-
if-
re
d
ns
re

Mercedes SA heads for

record year (192) CT(MR)18/8/95

BY ROY COKAYNE

PRETORIA BUSINESS EDITOR

Pretoria — Mercedes-Benz SA is having the best year in its history and is on target to sell 40 000 units this year, says Christoph Kopke, the chairman of the company's management board.

Kopke said the company had broken all records this year and profit was at an all-time high.

He said the company achieved a turnover of R504 million in May and R513 million in June.

"Traditionally we sell 22 000 to 23 000 vehicles a year, but this year we will sell 40 000 units," he said.

Kopke, speaking at a function to announce the launch of the Freightliner truck marque on the Southern African market, said Mercedes-Benz's trucks were sold out to the end of the year and the company's passenger vehicles were selling very well in the below R50 000 and above R150 000 categories, but not very well in the R50 000 to R100 000 category.

Productivity had improved considerably and R280 million had been taken out of its overheads since 1982. However, he stressed this did not mean Mercedes-Benz was world class.

Kopke said the company and IBM Consulting were involved in a business re-engineering process, which soon could result in "another productivity push".

NISSAN

(192)

FM 18/8/95

Further into Africa

Japanese motor giant Nissan plans to use Nissan SA as headquarters for its entire sub-Saharan Africa manufacturing and marketing operation. The decision will give Nissan SA access to 35 African countries, including many that operate left-hand-drive vehicles

The only exceptions will be North African Arab countries, which will continue to be sourced out of Dubai by Nissan Middle East.

Most African markets are supplied direct by Japan. Formal agreement on the new plan will be signed once Nissan officials from Japan and SA have finalised discussions with countries affected by the change

Creation of the new regional HQ — Nissan Africa — is part of the company's global decentralisation policy. Nissan SA will build its own vehicles for African markets and adapt and distribute vehicles sourced from other Nissan plants around the world

Nissan SA builds about 2 000 vehicles a year for African markets. With the new agreement, officials estimate that could increase to 8 000, plus another 10 000 for distribution. In time, as its own products become known in new markets, Nissan SA hopes to take a large slice of that extra 10 000 for its own products

These new markets will include Nigeria and Ghana, as well as East Africa and former Belgian and French colonies in central and West Africa. Japan considers that the SA company, with its advanced manufacturing facilities and experience of African conditions, is the logical choice for a continental headquarters

In addition to its new status as the source of built-up vehicles for Africa, Nissan SA will also be used to provide completely-knocked-down vehicle kits for other small Nissan plants in Africa, with Zimbabwe the first target and Kenya and Egypt possibly to follow.

Despite the new deal, there are no immediate plans for Nissan J to take a share in the SA company. Nissan SA — shortly to be listed on the JSE — is currently 100% owned by Sanlam's industrial investment arm, Sankorp. That will be diluted to about 55% by the listing, but Nissan SA officials say Japan is unlikely to buy in at this stage ■

MOTOR INDUSTRY
~~1995~~
FM 18/8/95
Taking stock

192

Toyota is back to full production after closing its Prospecton, Durban, assembly plant for a week, says CE Bert Wessels. The closure was to allow vehicle stocks to run down after a cooling off in industry sales.

Other companies have cut back production, but they have preferred to do so through shorter working weeks rather than total shutdown. According to Wessels, the market was "overheated" in the first half of the year, and companies worked flat out to cope. Given the market's current fall off, production cutbacks were inevitable to counter growing stockpiles of vehicles. For Toyota, the lost week has brought the company back to a comfortable stock situation.

The greatest decline in demand, for most companies, has been among small vehicles. The market for heavy trucks and buses, on the other hand, remains comparatively resilient. The decision by Mercedes-Benz to introduce a new range of Freightliner vehicles to the SA market highlights the motor industry's view that there is scope for continued growth in this sector — particularly for niche products.

Toyota is building about 20 US-sourced Peterbilt trucks a month now, and expects to eventually push this to 30. The arrival of the Freightliner, also US-sourced, will spice up a market already the battleground for several imports.

Further evidence of the heavy vehicle sector's buoyancy: Swedish truck manufacturer Scania this week returned to SA after eight years, Iveco has cut prices by between 6% and 9% to meet increased competition, and the Greater Johannesburg Transitional Metropolitan Council has ordered 100 Volvo buses, reputedly the biggest SA bus order for more than 10 years. The first buses were delivered last week. ■

Retrenched workers sue union

ARG 19/8/95

(192) (336)
Own Correspondent

PORT ELIZABETH — Former Ford Motor Company workers here have issued summonses totalling more than R1 million against the trade union Numsa in the first civil claim against a Cosatu affiliate

The first case will be heard on Monday when an ex-Ford worker from Port Elizabeth will take the National Union of Metalworkers of South Africa (Numsa) to court. The test case will be heard in the magistrate's civil court.

Solomon Mamoojee will claim underpayment for a retrenchment package negotiated when Ford disinvested from South Africa 10 years ago.

Attorney Chris Cornish, who represents the workers, said more than 100 summonses with a total claim of about R1 million have been issued against Numsa.

About 1 400 ex-Ford workers, with similar claims, were retrenched when the company left Port Elizabeth in 1985.

At the time of the retrenchment the workers were represented by the National Automobile and Allied Workers' Union (Naawu), which in 1987 unified with other unions to form Numsa.

Mr Mamoojee will claim that all the rights, obligations and liabilities of Naawu were taken over by Numsa when the unions merged and that Numsa was liable for damages claimed.

He will also claim that:

■ Naawu had no mandate to negotiate the retrenchment package accepted by the union,

■ Naawu had no authority to bind the workers in respect of the package;

■ Naawu failed in its duty in terms of the union's constitution,

■ Naawu acted negligently and/or without due regard to the interests of the members when negotiating the package.

The summons claims that as a direct result of Naawu's failure in its duty, the workers were paid an amount less than that which should have been received had the union not breached the contract with its members.

Numsa legal spokesman Sunil Narian could not be reached for comment.

(192) (1994)
Workers sue Numsa for R1m

Port Elizabeth - Former Ford Motor Company workers in Port Elizabeth have issued summonses totalling more than R1 million against the trade union Numsa in the first civil claim against a Cosatu affiliate. The first case will be heard on Monday when an ex-Ford worker from Port Elizabeth will take the National Union of Metalworkers of South Africa (Numsa) to court. Mr Solomon Mamoojee will claim under-payment of a retrenchment package negotiated when Ford disinvested from South Africa 10 years ago. Numsa's legal spokesman Sunil Narian could not be reached for comment. - Own Correspondent

STW 19/8/95

Panelbeaters' new body on a collision course with corruption

ST 20/8/95

By ZILLA EFRAT

DISGRUNTLED panelbeaters and car assessors have formed new bodies to fight corruption in their businesses. Much of this involves kickbacks which ultimately add to the spiralling cost of insurance premiums.

Henry Tiedemann, chairman of the newly formed Institute of Motor Assessors of South Africa, says "Corruption is running rife in the insurance and motor repair business. I would go so far as to say that certain elements of this industry are among the most corrupt in South Africa."

Keith Nilsson, chairman of the SA Insurance Association, adds, "There is so much smoke that there has to be fire and we would be delighted if the situation could be cleaned up."

Panelbeaters are targeting insurance companies, assessors and towing services but they also hope to clean up their own act by eliminating practices that make them behave like "criminals".

The assessors plan to bring more credibility to their business and root out "pirates" involved in illegal activities which give reputable players a bad name.

Willem-Jan Prinsloo, chairman of the recently established National Association of Panelbeaters (NAP), says "If panelbeaters refuse to pay 'backhanders' to assessors, towing companies and insurance companies, they do not get any work."

"The amount of business they get has nothing to do with the quality of their work but with the amount they are paying out."

Mr Prinsloo, who has researched conditions at over 500 panelbeaters around the country, claims that some assessors demand a cut of around 5% from panelbeaters for ap-

proving their quotes.

In addition, a number of assessors are quick to write off cars that could have been repaired. Some of these vehicles land up in the possession of the assessors' friends or scrapyards willing to pay a fee.

Mr Tiedemann agrees with these allegations and says part of the problem is that there are no barriers to entering the assessing business. There are also no



WILLEM-JAN PRINSLOO

guidelines or standard of qualification.

Some clerks at insurance companies are also known to get kickbacks, an activity for which a large insurance company recently fired five staff members.

These clerks have the ability to refer cars for repairs and recommend panelbeaters, and are in a position to send customers to those firms that pay them a cut, says Mr Tiedemann.

Mr Prinsloo says towing services are also usually paid a "commission" — normally between R500 and R700 — for each car they bring in.

To cover this cost, some panelbeaters inflate their quotations, use second-hand parts or do a shoddy job, says Mr Tiedemann.

He adds that some insurance companies put pressure on assessors, preventing them from doing a fair and ethical job. For example, they will request that the assessor looks for ways to get out of paying a claim or will insist that second hand parts are used in a job that may involve a brand new car.

Mr Prinsloo also claims that some companies prescribe what equipment panelbeaters may use. It is believed that a number get kickbacks from the equipment manufacturers.

He adds that many insurance companies select a panel of workshops to do their repair jobs exclusively. Some panelbeaters are willing to pay back between 5% and 10% of the value of any job they do to be part of the group.

In addition, panelbeaters have to offer between 2,5% and 10% to insurance companies in order to receive payment within seven days to 30 days of a vehicle being repaired, and released. If they do not, it could take up to 60 days before they get paid.

To fight back, the NAP is currently compiling a list of assessors and insurance company personnel known to be taking kickbacks.

It will give this to insurance companies, some of which have already expressed interest in the move.

Another tactic being considered is to report assessors known to be involved in illegal dealings to the Receiver of Revenue, who could compare their standards of living to declared salary packages.

To get its own house in order, NAP will compile and publish a blacklist of panelbeaters involved in shady schemes.

In addition, NAP plans to help panelbeaters form their own association of towing services.

T&N posts impressive results as exports increase

CT(BR)22/8/95 (192)

By SHIRLEY JONES

STAFF WRITER

Durban-based car and industrial group, T&N, has realised two strategic objectives — cost containment and export growth — at the interim stage

Impressive results posted yesterday for the six months to June 30 this year, reflected a 33 percent increase in pre-tax profit to R21,6 million and 24 percent increases in turnover and operating profit to R335,8 million and R27,7 million respectively

Earnings a share increased by 37 percent to 64,3c and T&N declared a dividend of 17c (12c)

Most noteworthy is a 49 percent hike in exports, representing 19 percent of group turnover

Although the overall objective is for a 25 percent slice of group turnover to be dedicated to exports, increasing ratios is an intricate balancing act as local markets are growing simultaneously, says Ted Waldburger, the managing director

Waldburger, who is more than satisfied with the interims, says T&N is drawing to the end of a protracted consolidation phase which has seen the company tighten its belt across the spectrum, not only shedding heads and operations but also reducing raw material input costs and containing operating margins in line with self-imposed pressure on pricing

The acquisitions for which a cautionary announcement was issued last week are due to be announced soon. Connoisseur Auto Air Conditioning from Delta Motor and T&N International's Zimbabwean friction and gasket operations were named in the announcement. The acquisitions are a move towards growth

Waldburger says a joint venture with a partner in India is waiting in the wings and T&N is looking to further deals in Asia and South America

The South African group's expe-



HIGH GROWTH David Gerruthers, left, the incoming chairman of T&N, and Ted Waldburger, the managing director, at Silverton Services, a strategic growth point for the group

PHOTO: JOHN WOODROOF

rience and infrastructure would be used to bring the group's established African interests to a high return. "We are looking to a significant presence in southern Africa, not just South Africa"

He is confident of a good performance for this financial year as a

whole — T&N's sixth year of appreciable earnings growth. But Waldburger's warned that operating margins and cash flow would remain under pressure, requiring cost containment and working capital management to ensure the group maintained its momentum

Toyota expected to post higher profit

ET(BA)22/8/95(192)

By CHARLOTTE MATHEWS

INVESTMENT EDITOR

Interim results due from car manufacturer Toyota later this week are expected to be substantially above those reported for the first half of last year, with analysts predicting 30 to 50 percent higher profit

The first half of last year showed a 42 percent improvement in earnings although sales were hit by pre-election work disruptions

However, profit for the full year was only 14 percent better year-on-year owing to the disruptions, greater competition and a loss of market share

In results for the first half of this year, profit from Toyota is expected to grow on higher car sales across the industry, stimulated by pent-up local demand and the Rugby World Cup. The weakness of the rand against the yen — the group imports a substantial proportion of its components from Japan — is not expected to have any effect because Toyota uses a variety of hedging mechanisms

At the end of December Toyota's market share was 27 percent from 29 percent a year previously

According to one analyst, Toyota was being hit mainly at the lower end of the market by competition from Volkswagen, Samcor and Delta. Although Toyota still

Toyota-share price performance

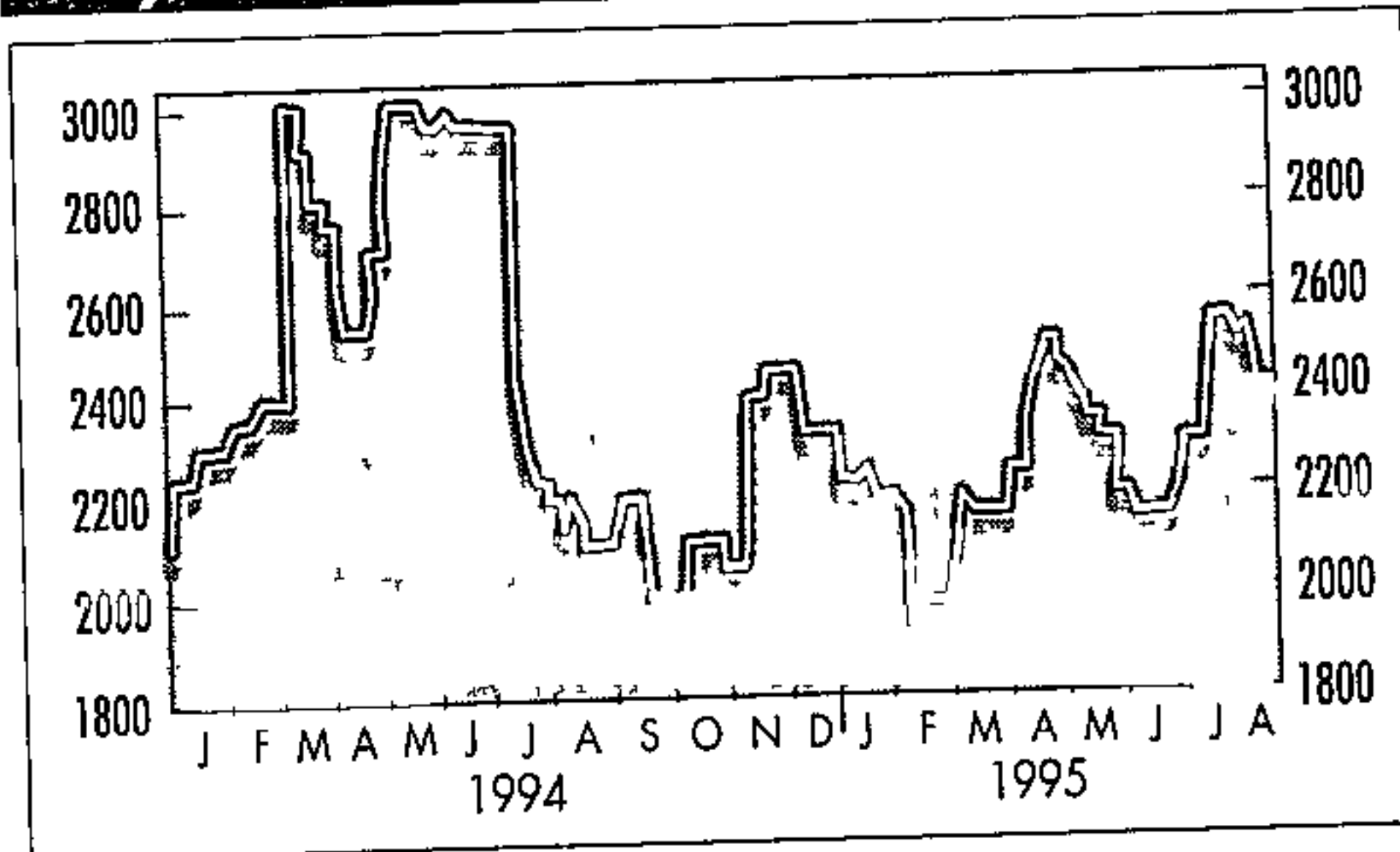

Toyota's shares have recovered some ground but have still not recovered fully from last year's motor industry strike

dominated that market segment, there was a question mark hanging over its affordability

However, a second analyst said margins at the lower end of the market were particularly low and this was not Toyota's mainstay

The group was extremely successful further up the price list with its Camry, minibuses and bakkies. Demand for bakkies was coming from the smaller sub-contractors and commercial ventures that were picking up RDP projects

Analysts said car sales in the second half of the year were weakening, partly because of the

interest rate hike

Toyota's growth in profit for the year as a whole would probably not be at the same pace as in the first six months, particularly since the group had closed its Durban plant for a week earlier this month

Toyota's shares have never recovered to the R31 they reached before the three-week, industry-wide strike last year. At their current price of R24 they are on a price earnings ratio of 8,8, slightly better than the motor sector — although Toyota is the only listed motor manufacturer — but well below the industrial average of about 16

but *exclude*

- Former TBVC states and Self-governing Territories (land and buildings)
- Statutory bodies such as Housing Commissions and Development Boards
- Parastatals
- Buildings owned by Provincial Governments
- Land and buildings of the former Posts and Telecommunications as well as of the former Transport Services

(a) State offices and miscellaneous buildings — 28 210
 Official residential accommodation — 25 888
 54 090

(b) The market value of these properties are not known. The estimated cost to value the properties at the normal tariff for valuers would amount to approximately R108 million

(2) Steps are being taken to expand the Department's inventory to include relevant information. The Department of Land Affairs as well as the provincial governments are involved in the process. The appointment of private sector companies to assist is also considered.

DET: Matriculation results

*23 Rev M M PHENETHI asked the Minister of Education †

(1) Whether the former Department of Education and Training will handle the matriculation results this year, if not, why not, if so, (a) for what reasons and (b) what procedure will be followed in respect of the publication of results,

(2) whether he will make a statement on the matter? N1068E

The MINISTER OF EDUCATION

(1) No, at its meeting of 20 March 1995 HEDCOM recommended that Senior Cer-

tificate results should be released simultaneously, before 31 December 1995, for all candidates in a particular province. Provincial education departments are responsible for the publication/dissemination of these results. This recommendation was approved at the meeting of the CEM of 28 March 1995.

(2) No. *Hansard 23/8/95 (192)*
 Aids sufferers in prisons

*24 Mr G C OOSTHUIZEN asked the Minister of Correctional Services †

(1) How many aids sufferers were there in prisons under the control of his Department as at the latest specified date for which information is available.

(2) whether he or his Department is contemplating any steps with a view to preventing aids in prisons, if not, why not, if so, what steps? N1069E

The MINISTER OF CORRECTIONAL SERVICES

(1) 15 Aids sufferers as at 30 June 1995

(2) It is a fact that persons sentenced to imprisonment are admitted from the community, some who are HIV positive and others who have full blown AIDS. Medical treatment and counselling to prisoners are available within the framework of the Department of Correctional Services' health care plan which has been compiled in conjunction with the Department of Health.

Furthermore, the Department of Correctional Services has an AIDS combating strategy in place but, due to the magnitude of this strategy, the contents thereof cannot be mentioned within the scope of this reply. However, should the hon member be interested in this strategy, a copy thereof could be made available to him on a personal basis.

It could be mentioned that a working group is at present reviewing the Department's health care plan. The present role-players of this working group are as follows, namely the

Department of Correctional Services

- Department of Health (Gauteng)
- South African Nursing Council
- South African Nursing Association
- District Surgeons
- International Red Cross

Invitations have also been extended to the National Department of Health and the Lawyers for Human Rights to join this working group. Other NGOs such as AT-TIC's and the Aids Law Project of the University of the Witwatersrand were also invited to submit written inputs.

As soon as the recommendations of this working group are available, the current health care policy will be reconsidered within the framework of the working group's perspectives.

Doctors employed by military hospitals: resignations

*25 COL N G RAMAREMISA asked the Minister of Defence †

(1) (a) How many doctors in the employ of military hospitals have resigned since 1 January 1995 and (b) what were the reasons given by these doctors for their resignation,

(2) whether these resignations have impaired the operational capacity of military hospitals, if not, what is the position in this regard, if so, in what respects,

(3) whether he or the South African National Defence Force envisages any steps in respect of the resignation of doctors, if not, why not, if so, what steps? N1070E

The MINISTER OF DEFENCE

(1) (a) A total of 65 doctors have resigned from the SA Medical Service since 1 January 1995. The Medical Service has been able to recruit 35 doctors to replace those who have resigned. During the previous financial year 90 doctors resigned.

(b) The following reasons were given for the resignations

Department of Health (Gauteng)

- (i) Low remuneration
- (ii) Better working conditions in the private sector
- (iii) Tough working environment in the SA Medical Service whereby the personnel serve in remote areas under battle exercise and operational conditions

(2) Yes. Those resignations have impaired the operational capacity of the SA Medical Service especially seen in the light of not having the services of National Service doctors anymore. Military Hospitals are barely able to supply Medical Officers on a rotation basis for duties in operational areas as well as the support for specific military operations and exercises.

(3) Yes. The SA National Defence Force has already initiated certain actions to counter the main reasons for the resignation of doctors. Projects are currently investigating the remuneration, working conditions and personal administration of medical officers. Burial schemes for military students are also under review.

*26 Mr Z D MGUNI—Welfare and Population Development † [Withdrawn]

*27 Mr P W COETZER—Minister without Portfolio † [Question standing over]

*28 Adv J H DE LANGE—Posts, Telecommunications and Broadcasting [Withdrawn]

Production/dismantling of nuclear weapons

*29 Mr T S YENGENI asked the Minister of Defence

(1) (a) What was the cost incurred in respect of research on and the production and dismantling of nuclear weapons developed by South Africa and (b) what were the main reasons for dismantling South Africa's nuclear arms capability,

(2) whether any foreign countries were involved in (a) persuading and (b) finally assisting South Africa to dismantle its nuclear arms capability, if not, what is the position in this regard, if so, which countries? N990E

Future of NGOs: funding

290 Mr G Q M DOIDGE asked the Minister without Portfolio

(a) What future is contemplated for non-governmental organisations, with particular reference to the (i) Transkei District Development Forum (DDF) and (ii) Transkei Anti-poverty Trust (TAP Trust), in view of the formation of RDP committees, (b) how are such NGOs funded and (c) what role is the DDF to play in respect of RDP related issues?

N600E

The MINISTER WITHOUT PORTFOLIO

A transitional mechanism is being established between government, the Kagiso Trust and the Independent Development Trust to unblock channels of funding for NGOs as an interim measure, pending the establishment of a National Development Agency to act as an interface between government and civil society, particularly the NGO and CBO communities. The RDP National Office has encouraged the continuation of existing and new development partnerships between NGOs, communities and donors.

INTERPELLATIONS

The sign * indicates a translation. The sign †, used subsequently in the same interpellation, indicates the original language.

National Aids Plan

1 Mr C G NIEHAUS asked the Minister of Correctional Services

- (1) Whether, with reference to his reply to Question No 13 on 31 August 1994, the National Aids plan calling for prisoners who are HIV positive or who have Aids not to be segregated and for making condoms freely available to all prisoners and the position of the World Health Organisation, as supported by the Department of Health, concerning the non-segregation of and supplying of condoms to such prisoners, he or his Department intends implementing the National Health Plan, if not, why not, if so, when.

- (2) whether, pending the report on the investigation being conducted by his Department into the treatment of prisoners who are HIV positive or who have Aids, he or his Department intends taking any interim measures aimed at the prevention of prisoners contracting the above-mentioned diseases, if not, why not, if so, what measures?

NH120E INT

The MINISTER OF CORRECTIONAL SERVICES Madam Speaker, there are certain technical difficulties as far as answering the first part of the question is concerned.

A committee known as Nacosa worked out a strategy some time ago, which included the possibility of making condoms accessible to inmates, etc. The Ministry for Health is supposed to develop a plan of action based on that strategy. As far as I know, that plan of action has not yet been developed. If it has been, it has not been made public, so that I do not have a copy from the Ministry for Health laying down a plan of action which I ought to follow.

As far as the second part of the question is concerned, according to my information the National Health Plan, which I am supposed to implement, is not yet in place. According to my

information up to 18 August the Ministry was still receiving recommendations from all Ministries concerned, and I assume that after all the information from the different Ministries has been submitted, the Ministry for Health will present a final National Health Plan. Until such time, the Department of Correctional Services cannot implement any plan for fear that it might contradict the final outcome of what the Ministry for Health is trying to do.

As far as part two of the question is concerned, the answer is yes, the department is trying to do everything possible to prevent the spread of Aids in prisons. At the moment this is done through education, since we believe that the best form of prevention at this stage is education.

Mr C G NIEHAUS Madam Speaker, the treatment of prisoners who are HIV positive or who have Aids, was raised in a question to the Minister of Correctional Services almost a year ago. Minister Mzimela's reply was particularly unsatisfactory, especially in the light of the seriousness of the disease and the important human rights issues that are involved. A year later the same reasons for serious concern persist.

I may add that I am concerned that the Minister says there is no National Health Plan on Aids, because I am informed by the Minister for Health that there is indeed such a plan and that it was adopted by the Government last year.

As regards the testing and segregation of prisoners with HIV, the Aids Handling Strategy of the Department of Correctional Services formally complies with the guidelines laid down by the World Health Organisation, namely that testing can only take place upon voluntary request by a prisoner and that the results must be treated as confidential. However, prisoners who test HIV positive are mandatorily separated from other prisoners at night, often during the day as well. It furthermore seems to be common practice to remove HIV-positive prisoners from previously assigned jobs and to deny them useful employment.

The department's policy is irrational and ineffective. Faced with blatantly discriminatory practices, tantamount to punishment, prisoners resist being tested for HIV. As a consequence, the majority of HIV-infected prisoners remain un-

aware of their infection, as will the prison authorities

Because of such treatment, 14 prisoners at the Pietermaritzburg prison, who are HIV positive, have started litigation against the Department of Correctional Services

This brings me to the unavailability of condoms from the Minister's response last year and other responses from the Department of Correctional Services, it would seem that disapproval of homosexuality is the basis for refusing to make condoms available

Homophobia, whether in Zimbabwe or in South Africa, can be no substitute for rational and sensible policies. Arguments based on so-called moral disapproval simply misses the point. The call for condom distribution in prisons must be seen in the light of disease control and protecting society from the further spread of HIV

Whether one approves or not, sexual intercourse occurs in prison. In all honesty, the Minister and the Department of Correctional Services will have to admit

The SPEAKER Order! I regret to inform the hon member that his time has expired

Mr C G NIEHAUS I will proceed later

Mr H M NEERAHOO Madam Speaker, I have no problem with the HIV-positive prisoners being separated from the other prisoners who are incarcerated. I believe that the normal health plan should apply in prisons

I am not in agreement with the hon the chairperson of the Portfolio Committee on Correctional Services that we should and abet deviant sexual behaviour in prisons. I am sure that there are better ways of containing this type of behaviour than by making condoms freely available there. I tend to agree with the hon the Minister that, instead of making condoms freely available, we should educate our prisoners to refrain from this type of deviant sexual behaviour [Interjections] One way of doing so is to keep them busy in the workplace instead of keeping them busy at night [Interjections]

The cost constraints on upgrading prisons are enormous. Maybe one day, with the help of the hon member Mr Niehaus and with the persuasion of the ANC, we might distribute condoms. Then, however, it is going to cost us a hell of a lot of money to upgrade prisons, to make separate

programme to combat Aids, and not to practise apartheid against our prisoners, who are already very vulnerable people.

I believe in education. I also believe in preaching, but I am a realist. I know that in spite of my good sermons and my education, people still suffer from many kinds of diseases, including HIV. We need to provide solutions to this problem, such as condoms, to help our prisoners. [Time expired] [Applause]

Mr C G NIEHAUS Madam Speaker, it surprises me that we have to be faced with a situation in which it is termed "scandalous" when one raises in this House one of the most important issues that we can possibly discuss in South Africa at this stage. I am definitely not going to apologise for asking the Minister of Correctional Services and all members of this House, including Mr Neerahoo, to be realistic about the situation which we are faced with. I repeat what I said earlier: Whether one approves or not—the Minister must please accept this—sexual intercourse occurs in prison, whether one likes it or not.

In all honesty, the Minister and the department will have to admit that in spite of the strictest measures, one cannot prevent it from taking place, especially not in our overcrowded prisons. One also has to take our Constitution seriously. It specifies that there should be freedom of sexual choice. [Time expired]

The MINISTER OF CORRECTIONAL SERVICES Madam Speaker, the Department of Correctional Services has set up a task force to look into the whole question of the treatment of people in prisons who either have Aids or are HIV positive. We do this in consultation with experts from other countries, and are waiting for a full report which will be presented to us in November. I have to emphasise once more that, as a country and as a Government, we have as yet no National Health Plan which gives us full direction on how to deal with the question of Aids. If we want to deal with this matter responsibly, we must do so on the basis of fact, not on the basis of fiction and emotion.

Debate concluded

High-technology health services

2 Dr W A ODENDAAL asked the Minister for Health

Whether it is the policy of the Government of National Unity to scale down high-technology health services in South Africa, if not, what is the position in this regard, if so, what are the relevant details.

N1095E INT
The MINISTER FOR HEALTH Madam Speaker, hon members, health care reform in this country and in other countries is focusing on the development of primary health care and the reduction of high-level hospital care services. This is the case mainly because an improvement in the health care status of a population does not result from the availability of high-tech medicine found in academic or tertiary health centres. What improves the health status of a population is access to clean water, the prevention of disease, the promotion of health, and the availability of curative services in the communities in which people live.

Countries that have expensive technological systems that are operated from tertiary hospitals do not necessarily have better health indicators, such as a low infant mortality rate or a high life expectancy. The USA is a very clear example in this regard. However, countries that have good primary health care services have a better health status. I refer here, for example, to the United Kingdom and Cuba [Interjections]

Most of the health care needs of the average South African can be met at a primary or secondary health care level. It is only when those centres cannot handle a health problem that a need for highly specialised care arises. However, in stating that the use of expensive technology in tertiary and academic health centres does not improve the health of the population, I am not implying that these hospitals do not play an important role in health care delivery. They do, in fact, play an important role, but the emphasis should be on primary health care which is supported by a good system in terms of which patients are referred from the primary level to the secondary and tertiary levels.

The issue at stake is what degree of academic health care versus primary health care there should be. We have to get a balance that, in the end, will result in the improvement of the health status of the people of this country. [Time expired]

Dr W A ODENDAAL Madam Speaker, the ANC truly excels in incompetence. It took a commu-

Toyota's performance below expectations

ET (PR) 25/8/95
By CHARLOTTE MATHEWS

(192)

INVESTMENT EDITOR

Higher vehicle sales, improved operating efficiency and lower increases in local component costs took net income from motor manufacturer Toyota up 21 percent to R53,6 million in the six months to June, compared with the same period last year, which was slightly below market expectations

Turnover was raised by 39 percent to R3,1 billion on which operating income was R133,3 million (R95,5 million). However, higher interest and a bigger tax bill bit into the bottom line

On earnings of 131,77c (108,89c) a share, an interim dividend of 24c (20c) a share was declared

Bert Wessels, the executive chairman, said the group sold 46 604 units in the first six months of the year, which was 16,4 percent above the same period last year. However, Toyota's market share declined to 25 percent from 27 percent. Wessels said it was considered inappropriate for Toyota to reduce prices to compete at the lowest end of the market "for sound business reasons"

Analysts maintain that Toyota is doing well in light commercial vehicles and in the segment of the passenger car market just above entry level

Wessels said the cost of imported components, which made up about 40 percent of vehicle costs,



DRIVER'S SEAT Toyota executive chairman Bert Wessels

rose substantially because of the strengthening of the yen. This was offset by smaller increases in the costs of local components, increased vehicle sales and improved operating efficiency.

Despite market predictions of a weaker second half, Wessels said demand for vehicles, in line with the general improvement in business confidence, was likely to be sustained into next year

The motor industry has concluded a three-year wage agreement lasting until 1998, which should provide a platform for labour stability in the short to medium term

A P
o
b
i
c
A
t
h
e
r
e
L

FEMCO (192)
FM 25/8/95
Still disappointing

Activities: Makes electric motors and electric wire harnesses for motor cars, has important property interests

Control: Directors 61%

Chairman: J P Kearney Joint CEs N L van Zyl and G Zammit

Capital structure: 27,98m ords Market capitalisation R15,39m

Share market: Price 55c 12-month high, 120c, low, 50c Trading volume last quarter, 5 362 shares

Year to April 30	'92	'93	'94	'95
ST debt (Rm)	23,5	35,8	14,7	21,8
LT debt (Rm)	4,0	5,2	14,3	7,8
Debt equity ratio	0,72	1,15	0,69	0,76
Shareholders' interest	0,41	0,35	0,57	0,55
Int & leasing cover	0,3	1,0	1,25	0,02
Return on cap (%)	n/a	6,8	8,9	0,1
Turnover (Rm)	160,7	126,2	133,6	129,8
Pre-int profit (Rm)	0,03	6,5	6,9	(4,7)
Pre-int margin (%)	n/a	5,2	5,1	0
Earnings (c)	(27,7)	2,9	5,6	(20,8)
Dividends (c)	nil	nil	nil	nil
Tangible NAV (c)	153	140	179	139

* 16 months to April 30 1992

COMPANIES

This commercial and industrial investment holding company has always held out the promise that it would do well but has somehow managed consistently over the past few years to disappoint

Its most important business is Auto Cable Industries, in which it holds a 50% interest and which is the largest local manufacturer of electric wire harnesses for motor vehicles. Previously, Femco held this business in an equal partnership with Unihold; now General Motors has acquired Unihold's interest, along with 0,1% from Femco. This gives the motor giant control and releases Femco from suretyships of R16,5m.

The move seems eminently sensible, though shareholders will want to see some concrete results from the investment within a reasonable period.

From annual turnover of R130m in financial 1995, Femco has lost R5,7m, or 20,8c a share. This compares with a small profit of R637 000 last year (after transferring R6,7m to a nondistributable reserve).

Joint CEs Nimrod van Zyl and Guy Za-

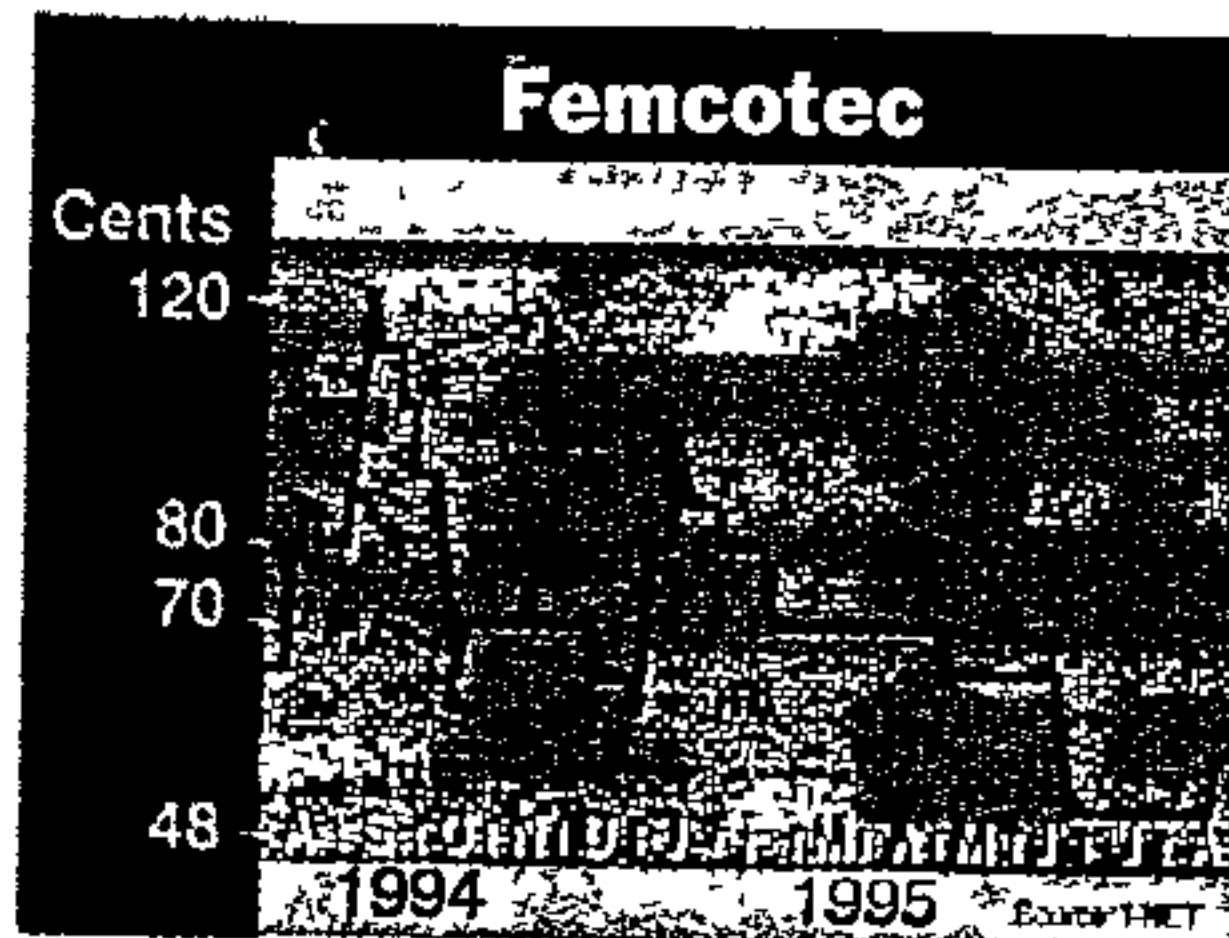

mmut say they are disappointed but don't explain why the loss was made.

They should detail this, especially after the optimism accompanying the interims. It is possible to infer that the biggest problem area lay in the harnessing business.

The CEs plaintively say that the equal partnership with Unihold made it "impossible to implement all the remedial actions thought appropriate" — an oblique statement which probably hides all manner of argument and anguish.

This reverberates through to the balance sheet, which now reveals gearing of 76%, a borrowing level which is to be addressed by a R10m rights issue. This should lower the ratio to about 0,50, still excessive but leaving space for improvement.

Van Zyl and Zammit believe that will be supplied by hefty medium-term increases in equity earnings from the harnessing business once the hand of General Motors takes a firm grasp.

The company also makes small electric motors. Since the market for these is so substantial (for example, it is said an average household uses as many as 20 motors) you would think it a lucrative business. Not so, it seems. "The performance from Femco (meaning the subsidiary) was disappointing, especially in the second half," say the directors.

It is a judgment which can be applied to the group as a whole and one with which shareholders — including Old Mutual, which holds 17% of the stock — may have cause to agree.

David Gleason

Automakers win sole rights to Alfa, Fiat (192)

ET(M) 31/8/98

By ROY COKAYNE

Pretoria — Automakers, the holding company of Nissan SA (scheduled for listing on the JSE on October 24), has negotiated the sole rights for both Fiat and Alfa Romeo products in South Africa

The company will immediately begin importing and marketing three Alfa model ranges — the 164 Super V6, 155 2.0 litre Twin Spark, and 155 2.5 litre V6 — but will expand this range in April next year. The Fiat Turbo and Fiat Ulysse multi-purpose vehicle will also be available in South Africa from about April next year.

All these vehicles will be imported as completely built up units, unlike the Fiat Uno which is manufactured locally by Automakers under license from Fiat.

The company will also be setting up a nationwide network of dealers to provide marketing, servicing and maintenance for the full Alfa range. It is planned to appoint 12 dealers within two years, with others to follow as justified by market demand.

Automakers' proposed listing in October follows the decision by the holding company, Sankorp, to unbundle. Sankorp will initially sell off 45 percent of its shareholding.

John Newbury, the chief execu-

tive of Automakers, said if the demand for the shares was high Sankorp would probably put more shares into the market.

"The listing will be achieved by a mix of public offering and a private share placement. Apart from meeting Sankorp's unbundling objective, the money raised from the listing will allow us to expand our dealer network, introduce new models and give us the capital to expand our export activities and maintain our assembly plants capital expenditure programme."

Automakers was in an ideal position to offer an affordable, wide range of vehicles to its customers. "By sourcing our products from two completely different geographical areas we can, to an extent, hedge against currency fluctuations."

But Newbury believed the importation agreement was just one side of the equation.

"We are actively looking to expand our export markets, particularly by taking advantage of the opportunities which our close ties with the international Fiat and Nissan groups offer us," he said.

John Jessup, a director of Nissan South Africa Marketing, was confident that by the turn of the century "there would be potential sales of 4 000 to 5 000 units a year for Alfa"

Alfa revs up for return to South Africa in a big way

ARC 3/18/95 (192)

HENRI du PLESSIS
Motoring Reporter

ALFA ROMEO fans will rejoice at the announcement by Automakers, the holding company of Nissan South Africa, that their favourite marque is on its way back to this country in a big way.

The announcement was made yesterday by Automakers chief John Newbury.

The company, a subsidiary of San-korp, has secured the sole marketing rights both for Fiat and Alfa Romeo

in South Africa

It will immediately begin importing and selling the Alfa 164 Super, three-litre V6 24-valve, the 155 two-litre 16-valve twin spark and the 155 V6 24-valve.

The range is to be expanded next year with the planned introduction of the Spider, GTV, 145 and 146 models, all fitted with new two-litre, 16-valve, twin-spark engine.

Automakers will also add the two-litre, 16-valve Fiat Turbo and the Fiat Ulysse multi-purpose vehicle

(MPV) to their range from April next year

All these vehicles would be imported as completely built-up units unlike the Fiat Uno, which is made locally under licence from Fiat.

This additional business is Automakers' response to the terms of the Motor Industry Development Programme, which plots a steady reduction of import taxes on vehicles over the next decade.

The company hopes to have 12 Alfa dealers in place within two years,

with others to follow

The Alfa 164 slots into the same market as the BMW 525i, the Audi A6 and the Mercedes 220E, while the 155 will compete against the BMW 320i, the Mercedes 220 and the Audi A4.

"By the turn of the century we expect the market for these vehicles to be between 4 000 and 5 000 a year," said Automakers' John Jessup.

They announced their plans just more than a month before their planned listing on the Johannesburg Stock Exchange.

Nissan to bring Alfa models back to SA

John Dlodlu

BO 31/8/95
AUTOMAKERS, Nissan's holding company, announced last night it had entered into an exclusive deal with Alfa Romeo to market Alfa vehicles in SA

All the vehicles would be imported in a completely built-up form, unlike the Fiat Uno model which is manufactured locally by Automakers under licence from Fiat. The plan follows government's restructuring programme for the motor industry which would make imports cheaper.

Automakers would immediately start importing and marketing three Alfa models, with the range expanding at the

(192)
beginning of next year. It would also set up a nationwide network of dealers.

Nissan SA Marketing spokesman John Jessup said last year the market share of fully imported cars was about 1% with imported vehicles costing on average 30% more than similarly placed local models.

"By 2000 imported models will have an estimated 17,5% market share with the price differential dropping below 15%." These forecasts, and the belief that the products could be competitively priced, were the reasons behind the deals with Fiat and Alfa. "This is a direct result of the terms of the recently announced motor industry development plan," he said.

Motor industry faces structural change

(192)
Star 31/8/85

■ BY JOHN SPIRA

South Africa's motor industry is undergoing structural change which is likely to result in a 30 percent decline in turnover by 2002

Only businesses that are willing to change and succeed in offering a quality product at a competitive and fair price, backed by excellent service, will survive

This is the harsh warning issued by Stephanus Loubser, the managing director of Nissan SA Marketing

He said the requirements of Gatt and the motor industry development programme had set the change process in motion

Loubser predicted that the proposed motor industry development programme, scheduled to take effect at the beginning of next month, would have a significant effect not only on the motor industry but on the economy as a whole

The reasons were, firstly, the scope of the motor industry was considerable in the wider economic context

Secondly, the programme could become a model for the

regulation or deregulation of specific branches of the industry in the future

He said vehicle sales of about R63 billion contributed 4,5 percent to South Africa's GDP. The industry employs 264 000 people and boasts a capital investment of R14 billion

Loubser also discussed the objectives of the motor industry programme which was set in 1992

These were to reduce the number of locally manufactured models, to create job opportunities, to produce more affordable vehicles and parts, to establish a more straightforward local content programme, to reduce the effect of the industry on the balance of payments and to meet Gatt requirements

Priorities

He said that the following priorities would make sense for the motor industry: making the product more affordable, protecting the balance of payments and protecting or creating job opportunities

Loubser identified wide-ranging implications for the

motor industry at all levels arising from the implementation of the motor industry programme

For customers or consumers the programme would have the following implications: a wider selection of models, more affordable vehicles since more and more suppliers would have to focus on price in a small and slow-growing market, a possible decrease in the level of service and the possibility that suppliers could be tempted to make additional profit on parts in order to compensate for the loss of profit on vehicles, Loubser said

Dealers

For dealers he listed the following implications: a decrease in profit margins, the possibility that by 2000 dealers' profit would be derived from parts and service and not from new vehicles and a decrease in the investment in buildings and expensive land, with perhaps a showroom in a high density area and a workshop in an industrial area

Dealers would also be obliged to investigate multi-agencies to optimise investment

For manufacturers the pro-

gramme would have the following implications: the upgrading of manufacturing to attain world standards and the involvement by existing car manufacturers in the manufacture of components

Exports

Exports would become an urgent priority, profit margins would be under pressure and by 2000 up to 25 percent of all vehicles sold in South Africa would be imported

Loubser said that small cars as a percentage of total sales accounted for 76 percent in terms of units and 58 percent in terms of turnover, 51 percent and 32 percent respectively in 1985

He estimated that the respective figures would rise to 82 percent and 66 percent by 2002

"Thus while growth will be generated mainly by the small car segment, turnover (and therefore also the potential for profit) will be smaller. In terms of this estimated restructuring, the value of the total car market decreases from R22,9 billion in 1985 to R16,1 billion in 2002 (at current value)," Loubser said

Atlantis

MAUREEN MARUD
Business Reporter

EXPORTS are a major part of Atlantis Diesel Engines' life. A dramatic increase in export orders for the next financial year was one of the reasons behind the company's decision to introduce a third shift in its machining and foundry operations to allow the plant to run six days a week, 24 hours a day, said Ron Shires, ADE managing director.

"This extra shift has created over 200 new jobs and 80 promotions and these have been filled primarily from the Atlantis community," said Mr Shires.

Export orders would be 55 percent higher in the next fi-

nancial year, he said. "The future of ADE depends on the growth and development of our export business. The additional shifts are a milestone in achieving our vision of becoming a major automotive component exporter."

Recent export deals ADE have signed include:

- A R100 million agreement with German truck manufacturer MAN and MAN's South African subsidiary, MAN Trucks and Bus (SA), for the supply of key components for heavy truck diesel engines.

- A R70 million contract with Daewoo Heavy Engineering of South Korea to supply V8 and V10 cylinder blocks, heads and conrods for three years.

- A R63 million deal with



North American engine manufacturer Detroit Diesel Corporation to supply crankshafts and exhaust manifolds for the next five years.

- A contract to export R30 million of components annually for the next three years to Perkins Engines of England, one of ADE's two international

Diesel logs up the export miles

ARC 1/7/95

(192)

about R140 million for the manufacture of crankshafts and engine blocks for export."

THE gala celebration dinner honouring the finalists, of which ADE is one, in the Weekend Argus/CCCI Western Cape Exporter of the Year competition will take place in the Ballroom, Mount Nelson Hotel, Gardens, Cape Town, on Tuesday, August 15.

The name of the winning company will be announced at the dinner, which will be addressed by Mr Alec Erwin, Deputy Minister of Finance.

Readers wishing to attend the dinner, at a charge of R98 a person, may contact Carol Shroobree at Cape Town 418-4300 to make a booking.

licensors. "ADE's export order book for the current year stands at nearly R120 million. Recently finalised contracts with companies in the Far East, North America and Germany — on top of current contracts in Europe, the UK, the Far East and South America — will take ADE to within reach of its annual export target of R250 million," Mr Shires said.

ADE would invest R96 million in new plant equipment to enable it to meet increasing export and local demand, he added.

The manufacturing of components for export markets has become a primary focus of the company.

"We are currently investing

Car industry fords Rubicon

By JEFFERSON
LENGANE

(192)

A GROUND-BREAKING labour agreement which will revolutionise the car-manufacturing industry and change the face of industrial relations was concluded this week

CP 2/7/95
Parties to the agreement are the Automobile Manufacturers Employers Organisation (AMEO), National Union of Metal Workers of South Africa (Numsa) and SA Yster Staal & Verwante Nywerhede-Unie.

Its core aspects are a three-year agreement to close the apartheid wage gap in the industry; career progression up the skills and pay ladders for all employees; educational opportunities and training across the industry and a framework for rewarding productive workers.

Issues such as new processes to ensure the maintenance and expansion of the National Bargaining Forum (NBF) and the es-

tablishment of an Industry Policy Forum; a work security fund and social investment in the RDP and dispute procedures that secure the unions' rights to strike on key issues have also been included

The three-year wage agreement is aimed at closing apartheid wage gaps

In a joint statement the parties recognised that there was a considerable gap between hourly-paid workers and artisans, a wide spread in wages within job grades and a significant spread in wage rates between companies in the industry. They said during the lifespan of the agreement "all these spreads will be progressively reduced to achieve a 10 percent differential between skills levels 1 to 5 and a 20 percent differential between skills levels 5 to 7.

With effect from July 1, 1995 the majority of employees who fall within grades 1 to 4 will receive an increase of 11 percent for the 1995/96 employ-

ment period. In succeeding years they will receive an increase matching the inflation rate. However, those earning less than the target minimum for a particular grade will receive additional increases to bring them up to par.

Most artisans and technicians will receive a 10 percent increase this year and an amount marginally less than the inflation rate in succeeding years.

During the period covered by the agreement the relevant unions have undertaken not to make any further wage or overtime claims. However, employees may be rewarded if they improve their skills and in accordance with plant-based productivity arrangements.

Welcoming the breakthrough, Labour Minister Tito Mboweni, said: "They have crossed the Rubicon. It is a very important breakthrough which challenges many assumptions such as those which assume there is no benefit in centralised bargaining"

Motor industry's labour deal puts an end to strikes

(192)
ST(VA) 2/7/95

AMID the deadlock in negotiations between Cosatu and business leaders regarding centralised bargaining, the motor industry this week signed a three-year accord with trade unions recognising the mutual benefit of national bargaining.

The carrot for the seven manufacturers represented by the Automobile Manufacturers Employers' Organisation (Ameo) is that the unions — the National Union of Metal Workers and the SA Yster, Staal & Verwante Nywerhede Unie — will not strike for three years or engage in any other form of industrial action. Should any workers go on strike, the unions are obliged to set matters right.

Union members, for their commitment to this historical agreement, will receive wage increases of between 10% and 11% from the beginning of the month, valid for a year, and increases for the following two years based on the annual increase in the consumer price index.

Some employees whose wages are below standard minimums will receive more than the CPI increase. Wage gaps in the various job grades, between hourly paid workers and artisans and between the various companies, will also be reduced.

Should the CPI rise above 14% or below 8,5% negotiations will be reopened.

By DON ROBERTSON

Workers will also be required to make up for lost production, should it be necessary, reduce absenteeism and alter shift patterns and methods of production to allow the industry to compete in the domestic and export markets.

Union members will have to agree to training programmes as a condition of employment.

Also part of the accord and one which is of particular significance to the industry is that unions will make no further claims through the National Bargaining Forum or at company level for pension or provident fund adjustments, bonuses, working hours, medical or sick pay benefits or any "other substantive benefits covered by the agreement".

Motor manufacturers believe they will come in for some criticism from other manufacturing sectors by agreeing to pay an inflation-related wage increase, but insist that by having all other demands on hold, actual wage bills will be below the CPI.

Numsa says that as the dispute meeting between itself and Seifsa approaches, the metal and engineering sector should take "note of these exciting developments in the auto industry".

Negotiations between

Ameo and the unions began in February and were concluded on June 9 with the assistance of facilitators Charles Nupen and Clive Thompson. The agreement was signed on Thursday.

While the agreement flies in the face of other industries which have strongly opposed compulsory centralised bargaining in their dispute with Cosatu, the motor industry accord has adopted this procedure on the wage issue only and has succeeded in keeping all other potential demands — representing 46% of wages — out of the accord.

The signing of the agreement should be an example to industry as to what can be achieved by centralised bargaining. It was negotiated without changes to the Labour Relations Act and was done on a voluntary basis by all parties.

The willing participation by the unions could be ascribed to the firm stance taken by manufacturers during last year's 27-day strike, which was largely resolved in favour of employers.

In a joint statement, the three parties say that motor manufacturing is a small part of the total industry and that other sectors, such as tyre and component manufacturers, should consider creating a joint forum for further discussion on wages.

Tariffs a game for winners and losers

ST/PT/2/7/95

THE textiles and motor industries stand to lose most jobs as a result of Trade and Industry Minister Trevor Manuel's recently announced tariff reform package.

According to a study by the Industrial Development Corporation, the textiles industry will lose about 10% of its 80 000 jobs over the eight-year phase-down in tariffs, along with a 6,5% decline in output and an 11,1% drop in prices. Exports are likely to increase 5,2% but prices will drop 4,7%, says the study.

"The significant decline in output prices and the surge in imports, coupled with export constraints, reduce the potential output growth of this (textiles) sector. However, the lower textile prices contribute to minimise the negative impact of trade reform on the clothing industry."

Lower textile prices yield no job gains for the clothing industry, according to the study. The clothing industry is likely to shed 0,5% of its employment as imports flood the market. The clothing industry employs about 100 000 workers, excluding the informal sector, which is thought to employ a similar amount

By GARRAN RYAN

Clothing imports are expected to rise 57%, compared with just 15% for textiles, causing a 13,8% drop in the volume of exports and an 8,9% drop in the prices obtained on total output.

"In general, trade reform would have a marginally negative impact on the industrial sector of the economy," says the IDC. "The highly protected sectors in the economy bear the brunt of the negative impact."

Overall, the study shows that tariff reform results in a 0,7% growth in gross domestic product, a 4,7% drop in inflation, a 0,7% gain in employment, a 2% growth in exports and 2,4% in imports and a 1,1% improvement in private consumption.

The IDC study simulates the macro-economic, structural and regional implications of South Africa's tariff reduction, the removal of import surcharges and the phasing out of the general export incentive scheme. The simulation assumes tariffs are lowered overnight rather than phased out over several years and can therefore be

viewed as a worst-case scenario. It also assumes no other changes in the economy and no new investment in plant. The IDC says new investment and a depreciating rand are two factors which would mitigate the adverse effects of tariff reform.

The motor vehicle sector will shed 4,7% of its jobs, along with a 2,5% drop in output and a 9% drop in price (assuming tariffs are dropped overnight). There are about 26 000 workers in vehicle assembly and 40 000 in component manufacture. The motor sector's export volumes will increase 12,6% but export prices will drop 7,3%. This will be offset by a 12,3% increase in import prices for motor vehicles.

The transport equipment industry will lose 6,9% of its jobs, along with a 30,7% drop in the volume of exports and a 4,9% decline in overall output. Prices will drop by 5,2%.

"The net result of the joint phasing out of tariffs and rebates is that the price of intermediate inputs into the motor vehicle industry declines by 7% with prices on the output side declining by about 9%. The lowering of tariffs yields a surge in imports of motor

vehicles. Domestic motor vehicle producers benefit on the input side, but are nonetheless squeezed by the higher level of imports."

Machinery export volumes are expected to drop 18,3%, printing 24%, furniture 21%, beverages 11,3%, plastic 11,5% and pottery 11,9%.

Industries likely to show export gains are non-gold mining, tobacco, textiles, chemicals, rubber, glass, iron and steel and non-ferrous metals, water and electricity, construction, trade, financial and other services.

Sectors expected to come under pressure from imports are clothing, footwear, textiles, beverages, food, furniture, motor vehicles and rubber.

Most sectors will suffer employment losses, but there are some notable exceptions. Non-gold mining is expected to increase employment 3,9%, gold mining 1%, non-ferrous metals 5,6%, agriculture 2,3%, iron and steel 2,2% and water and electricity 2,4%. Other sectors likely to record marginal gains in employment are financial services, other services, construction, industrial chemicals, tobacco, mineral products and domestic servants.

The Eastern Cape with its concentration of motor and rubber manufacturers, will be worst affected by tariff reform. KwaZulu-Natal will suffer due to the loss of textile jobs and Gauteng from the loss of motor-related jobs.

Regions which are expected to show economic growth as a result of tariff reform are Northern Cape (1,2%), Eastern Transvaal (1,02%), Northern Province (0,79%), and North-Western Transvaal (0,7%), with marginal growth being recorded in Gauteng, Free State, KwaZulu-Natal and Western Cape. Only the Eastern Cape suffers a drop in GDP, of 0,3%.

Trade reform will benefit the least protected primary goods producers, their immediate downstream industries and the services sectors of the economy, says the IDC. The services sectors will benefit from decreased input costs and increased economic activity.

"The positive impact on the metal and metal product producers indicates that the reduced input costs due to tariff reductions by far outweighs the negative impact of the removal of

Botswana in talks with SA on Hyundai venture

ROY COKAYNE

PRETORIA BUSINESS EDITOR

ET(BR)B/7/95 (192)

Negotiations are under way between Botswana and South Africa on extending the two-year dispensation granted to Hyundai Motor Distributors, to allow it to convert its Botswana facilities to comply with new customs regulations

The new regulations, which were effective from April 1 this year, closed the loophole that allowed motor vehicles to be imported into Southern African Customs Union countries under full rebate without any major investment in plant or employment

Les Watson, the projects manager at Hyundai, said it was difficult for a company to achieve completely knocked down manufacturing when it had to build a facility from inception

He confirmed the company had submitted a business plan to the Botswana authorities in terms of which 100 million pula (R130 million) would be invested to convert its semi-knocked down car assembly operation to supply vehicles from completely knocked down kits.

But Watson stressed Hyundai as a company — and not its semi-knocked down facility — would convert to completely knocked down manufacturing

He said the plan was to build a new completely knocked down plant from inception in Gaborone which, because of the demands of the operation, would be six times larger than the company's current semi knocked down premises

Converting to completely knocked down meant Hyundai would have to introduce several new production pro-

cesses and activities. These included welding jigs, an expensive paint shop and a trim section for finishing the inside of vehicles

In terms of the business plan, the first completely knocked down vehicles should be off the assembly line in 1999

But Watson said the company would do its best to work within the two-year exemption period if an extension to this exemption was not granted

"That is a bridge we will cross when we come to it," he said

Watson said Hyundai now produced about 1 400 passenger vehicles a month with about 90 percent of them destined for the South African market

He said the plan was for production to increase to 2 500 units a month when the completely knocked down facility came on stream in 1999. The new facility would also create more jobs

Watson said Hyundai would employ about 720 people when the completely knocked down facility came on stream, compared to the current workforce of 452. "We are the biggest private industrial employer in Botswana, which obviously has some meaning to the Botswana government," he said

Watson said Hyundai would continue to oppose the new completely knocked down definition

The company said the implementation of this definition was contrary to the requirements of the General Agreement on Tariffs and Trade to which South Africa was a signatory

"We are still pursuing our opposition to this definition with the customs union through the Botswana government. But I can't comment any further on it because we don't know what the future holds," Watson added

VW export success in China

ET(BR)3/7/95 (192)

STAFF WRITER

The experience Volkswagen SA has gained as a result of its export programme to China will help the group obtain orders to supply cars to international markets, says Heinrich Holtmann, managing director

The final shipment of left-hand-drive Jettas has just departed from the company's Uitenhage plant, raising the total to 27 000 vehicles

The programme was meant to provide vehicles to China ahead of the construction of a major motor assembly operation there

The contract initially called for the supply of 17 000 Jettas

Holtmann notes that the China programme's success is being complemented

by Volkswagen SA's supply of body and engine parts, along with catalytic converters, to Spain, Germany, Argentina and Belgium, and a small volume of built-up units to African countries

Volkswagen SA has also sold its tooling facilities for the second-generation Jettas to its Chinese customers for use in the newly commissioned assembly plant

"Largely as a result of the China programme, Volkswagen SA has been South Africa's biggest motor vehicle exporter, boosting this country's foreign exchange earnings by some R750 million over a three-year period," Holtmann says

"More importantly, we have developed valuable expertise in supplying semi-knocked-down units to the international market"

Motor industry sets new pace

(192) 203/7/95

Renee Grawitzky

THURSDAY's three-year wage deal covering 25 000 workers signed between seven vehicle manufacturers and the National Union of Metalworkers of SA and the SA Federated Metalworkers Union, has been hailed as a groundbreaking agreement enabling the parties to meet the challenges of the 21st century

In 1993 the parties signed another groundbreaking agreement — but it soon fell apart at the seams and a year later the industry faced a lengthy and acrimonious strike which hardened attitudes to such an extent that it took weeks to resolve a 0,5 percentage point difference. As employer negotiator George Stegmann says, "both parties missed critical opportunities to achieve settlement earlier"

What is different about this agreement, which will ensure the parties' full support and commitment to contribute to its success?

The motor assembly sector is known for producing innovative and forward thinking agreements which, in the past, have tended not to live up to their potential as the collective will to ensure successful implementation has not existed

It is not so much the agreement itself but the history of the relationship between the parties that brought them to the point where both show some maturity, realism and understanding of the crucial issues facing the industry

The industry is well known for its high level of industrial action and shopfloor conflict, especially around the time Numsa was attempting to get the employers to bargain in a central forum

In 1989, despite employers' reservations that they could not bargain centrally as they were major competitors, they eventually came kicking and screaming into the national bargaining forum. The first few years were very bumpy with a high level of confrontation during negotiations. Employers, who were not united, saw the negotiations as an ordeal and the union reacted by testing its power in the central forum

The strike last year appears to have been the turning point. Both parties acknowledged they could not continue the relationship in the same way. Added to this was the acknowledgement that the parties needed to work together to address the fundamental challenges facing the industry in view of tariff reductions and the opening up of international markets. The motor industry is intensely competitive, which places a further burden on the parties

After the 1994 strike they established two joint working groups to develop a long-term wage-skill model and ensure delivery on education and training

Former Independent Mediation Service of SA director Charles Nupen and UCT labour law specialist Clive Thompson acted as facilitators in the working groups which focused on moving away from the tradition-



HARTFORD

al adversarial mode of bargaining. Within these forums the parties were able to develop complex and innovative proposals on a wide range of issues

Nupen says that, in the light of the issues to be addressed, the parties took a view that the process should not be depicted by collective bargaining in the traditional sense — rather the process of problem solving and consensus seeking

So what gives this agreement a chance of success?

All parties have admitted the problems of past agreements, which lacked tight provisions to ensure implementation and monitoring. They also lacked the will and capacity to ensure smooth implementation at the shopfloor

This year, the union says, the national shop stewards' council was involved in the process and has a good understanding of the agreement

Numsa negotiator Gavin Hartford says last week's agreement fulfills the union's objective of a three-year strategy focusing on closing the wage gap and reducing differentials between grades to 10%, training workers to upgrade skills and wages, and democratising the workplace. These elements, it is hoped, will lead to improved productivity "because workers are motivated if they have better pay and training and can take part in decision making"

What is in it for employers?

The agreement clearly specifies, according to Stegmann, what issues will be bargained at a particular level. It represents "a significant shift of putting into place broad framework agreements with flexibility devolved to the plant"

In addition, the agreement provides a level of certainty around annual wage in-

creases as it stipulates the increases for the next three years, secures a joint commitment to co-operatively address critical issues regarding productivity, and includes a process to contain industrial action, with a peace obligation clause limiting strikes to areas around productivity and education and training. Workers can strike only after having had disputes referred to a form of combined mediation and arbitration

The key focus is the formulation of an industry wage model linked to skills progression and the recognition of prior and acquired learning

The wage model is intended to eliminate wage anomalies by reducing wage spreads in grades and within companies. It also substitutes skills for grades so that instead of moving up grades, workers will move up skills levels

For each skills level, wages will range between a minimum entry level and a maximum level. The differential between levels is 10% at the lower levels and 20% between the top three. The percentage increase for the minimum is 2% higher than inflation, but for this year it is 12,64%. For the majority of employees the average increase on this year's rates is 11%

For new employees coming into the industry, education and training will be a condition of employment. This will be voluntary for existing employees, who can choose between a minimum or a maximum pay stream. The maximum stream is for those employees wishing to acquire new skills and competencies, and the minimum is for those who are competent in their jobs and who have been assessed by the recognition of prior learning process

Karl von Holdt, in a recent SA Labour Bulletin, questioned whether workers would benefit from being highly skilled if the nature of production did not change. He says Numsa's programme could benefit only groups of workers, not the majority

Hartford says the programme is an incentive for employers to reorganise work and use skills, while it is an incentive for employees to become better educated and trained to "realise their own potential"

The agreement bears some resemblance to the spirit and intention of the Labour Bill — and is an example of how centralised bargaining can allow for plant level flexibility. Hartford says the "key architecture of the agreement could be applied to any industry in SA — including metal"

Does the three-year plan have a future in the metal industry?

Since 1993 Numsa's programme has been to grade jobs by skills, not task, and to develop modules for training and education. Employers have committed themselves to reducing the number of grades,

However, employers have not committed themselves to the heart of the wage policy, saying that this should be left to the parties to negotiate at plant level. They also argue that the industry is more diverse in terms of operation and size

NSB's deal with Indian brewery

cost R70m

CT. (PR) 4/7/95

BY SHIRLEY JONES

STAFF WRITER

(192)
A price tag of R70 million has been placed on last week's controversial deal between National Sorghum Breweries (NSB) and United Breweries (UB) of India

The largest Indian investment in South Africa to date, the deal will see UB acquire 30 percent of NSB's equity capital with an option to increase its stake to 50 percent

The joint venture entitles UB to board, executive and management representation. At the same time, UB brands such as Kingfisher Lager will be launched onto the South African market

The question surrounding the deal is why UB — an outright market leader in its home country — would invest such a large sum in a South African company, with dubious profit and rumoured mismanagement by Mohole Mahanyele, the chief executive

The benefits to South Africa's largest sorghum beer producer appear obvious. The lucrative deal puts NSB's market value at about R230 million. It has been well known that the company has been on the lookout for a national or international business partner capable of injecting at least R100 million in an effort to offset the R17 million operating loss of subsidiary Jabula Foods and plump up NSB's clear beer division, Vivo

By allowing UB's products to piggyback on Vivo's already expensive distribution network, NSB may be able to justify some of those costs while at the same time benefit from UB's management expertise in the clear beer market

There is always the possibility that UB, which also has a majority shareholding in Mabula Lodge and is part of a joint venture with Kagiso Trust, could list its South African interests independently

What is evident is the differences between the two companies. UB, market leader in both the Indian beer and spirits markets and active within the petrochemicals, engineering, fertiliser and financial services sectors, recorded R3,8 billion in turnover during its 1993/4 financial year as opposed to NSB's R560 million

Samcor follows VW lead in cutting car prices

ET(MR) 6/7/95 (192)

BY AUDREY D'ANGELO

CAPE BUSINESS EDITOR

Samcor would slash the price of its cars by up to 15 percent, it was announced yesterday

The latest price cuts follow Volkswagen's introduction of a low-cost small car

Arthur Mutlow, the managing director of Samcor, said improved productivity "and extensive value engineering have made these reductions possible"

Mike Glendinning, the advertis-

ing manager of Volkswagen SA, said Volkswagen had initiated the price-cutting by launching its Chico in April as the lowest-priced small car on the market at R33 950

He said it had done so in response to the need for more affordable new cars and, as a result, had become the market leader. Sales of the Chico totalled 3 811 in April, May and June, giving this model a 15 percent market share

Senior executives of other competitors in the small car market, Delta, Toyota and Nissan, said they

would not be cutting prices

John Cuming, sales and marketing director of Delta, said Samcor's action was obviously a direct response to the introduction of Volkswagen's Chico. He said Delta had no plans to cut prices at this stage

A spokesman for Toyota Marketing said "We have put our prices up from July 1 and we shall certainly not be cutting them. By doing this Samcor have damaged the resale value of their cars

"People do not buy a car on

price alone but take other factors into consideration, including the resale value"

John Newbury, chairman of the National Association of Automobile Manufacturers of South Africa, who is also managing director of Nissan, said Naamsa would not comment on pricing

"That is an individual plant matter"

He said Nissan would not cut prices because the market was reasonably strong "and we offer very good value as it is"

Motor trade booms as car sales rise 21%

CT (DR) 6/7/95 (192)

STAFF WRITER

The motor industry boom is continuing, with new car sales almost 21 percent higher in the first half of 1995 than the January to June figures for last year.

Sales for the whole of this year look set to total at least 220 000, with a value of more than R16 billion, against a previous general forecast of 215 000.

Volkswagen yesterday predicted that sales this year could hit 230 000.

In addition, sales of light commercial vehicles, including bakkies and minibuses, were up by over 31 percent during the first six months of this year.

Car sales until June were 114 075 against 94 528 in the equivalent period last year. Sales of light commercial vehicles rose from 49 458 to 64 900.

This suggests that a rise in real gross domestic product of around 3 percent can be achieved in spite of the latest interest rate rise.

Sales of trucks were exceptionally buoyant from January to June, with sales of medium-duty units rising by 28 percent while sales of heavy-duty vehicles soared by more than 50 percent.

Sales of both new cars and light commercial vehicles dipped slightly in June compared with May, according to figures released yesterday by the National Association of Automobile Manufacturers of South Africa (Naamsa). But sales were still well above those of June last year.

Manufacturers report that the market is becoming more competitive — Volkswagen has achieved higher sales than former market

leader Toyota for the third month running — and higher interest rates are expected to affect sales.

But Samcor announced price cuts across the board for both Ford and Mazda models yesterday, and this is almost certain to be followed by other manufacturers.

The underlying trend in the South African new vehicle market remained positive and was on target for above average sales this year, said Nico Vermeulen, the director of Naamsa.

"The strong performance of the light, heavy and medium commercial vehicle segments of the industry was indicative of the ongoing recovery in fixed investment and reflected continued improvement in the economy."

Total new car sales in June were 19 777 compared with 20 398 in May and 18 474 in the same month last year.

Of these, Volkswagen sold 4 579 and Toyota 3 688. Samcor was in third place with sales of 2 731.

Light commercial vehicle sales totalled 11 361 compared with 11 405 in May and 10 137 in June last year.

Medium commercial vehicle sales totalled 368 compared with 402 in May and 299 in June last year.

Heavy commercial vehicle sales totalled 707 compared with 615 in May and 505 in June last year.

Tony Alison, financial director of McCarthy Motor Holdings, said the Naamsa figures for the January to June period were "more bullish than expected earlier".

Car sales of 220 000 for this year were now a realistic target. The industry has previously been talking more in terms of 215 000.



Trade and Industry Minister Trevor Manuel ... introducing tariff cuts in the auto, textile and clothing sectors.

Tariff cuts will help economic growth

Downer on 6/7/95

By Moeletsi Mbeki

Ways must be found to encourage saving and increase skills

~~THE~~ (192) ~~192~~

TRADE AND INDUSTRY Minister Mr Trevor Manuel is, at present, probably the only ANC Minister who is seriously trying to do what the blacks who voted for the ANC want to see done as a priority

In their heart of hearts, most black voters want to see the new Government punish the white man for his past sins. Tariff cuts will do just that. They have the added bonus of bringing down clothing and transport prices.

Whether tariff cuts will punish the right white man and punish him sufficiently, is a matter that should exercise our great legal minds. To the man in the street, however, this is a moot point.

Whatever the virtues of free trade in cars, textiles and clothing as ways of bringing about economic development in South Africa, to most blacks less protection of these industries means first and foremost more pain for their white owners and managers.

Foreign imports will, by taking a share of the local market, hit the owners and their highly paid white managers where it hurts most their pocket books. Imports will, of course, also adversely affect black workers in these industries. However, in the eyes of most black voters, that is a necessary price for the greater satisfaction of seeing whites suffer.

An iron law

Sanctions, after all, taught today's black electorate, the former oppressed masses, that there is an iron law which states that one must sacrifice to achieve the community's higher objectives. This message is beginning to register even with the pro-ANC unions in the motor, clothing and textile sectors.

Unions, important as they are in the country's body politic, are beginning to learn the other iron law about democracy — that when it comes to influencing Government decision-making, it is the wishes of the broad electorate that carry more weight. This means that those who are trying to oppose Manuel's tariff-cutting spree are invariably going to fail because they cannot mobilise a larger

constituency in favour of greater protection than the constituency Manuel has behind him which supports reduced tariff protection.

But what about the economic aspects of Manuelism? Will South Africa achieve economic growth and therefore full employment through free trade? To answer this satisfactorily, we need to look closer into the deep malaise that afflicts South Africa's industrialisation process.

It is because of its flawed industrialisation process that South Africa is today on the one hand unable to create meaningful employment for most of its citizens and, on the other, is a producer of more expensive clothing, shoes and cars than many other countries.

Tackling root causes

If we do not tackle the root causes that have led to half of this country's labour force being unable to find jobs, no amount of cheaper imports will save South Africa from the increasing impoverishment of the majority of its people. For the country to create more jobs that pay better, a higher rate of industrialisation is required than we have at present. However, twin challenges face those, including Manuel, who want to speed up the country's industrialisation. The first is to encourage saving and the second is to develop skills that will create the opportunities for those savings to be invested in broadening and deepening the industrialisation process. Tariff cuts have to be combined with these two measures if they are to lead to the further industrialisation of South Africa. On their own, tariff cuts will merely turn South Africa into a nation of importers.

If we define saving as foregoing consumption and therefore immediate gratification in order to be able to consume more in the future, it is clear that is not a comfortable option. Most people would rather consume now and therefore not save at all. This is why saving by and large is not undertaken voluntarily but is forced either directly, for example through low wages and poor working conditions

or indirectly through the creation of a social and economic environment of uncertainty which compels people to save "for a rainy day". The first challenge then is to decide who should be made to save the most and how to make that person or group of persons, save.

Industrialisation is therefore first and foremost about the exercise of political power because obviously it was the weakest groups, with the least political power, that were compelled to save the most. In South Africa, historically these were the blacks.

Not any more! Today blacks have the vote and are organised into powerful unions that are fighting against the low wages of old.

If we are to raise South Africa's level of industrialisation so that the country's economy employs more people and pays better, who is to be made to save today? This is the question that is not answered by trade liberalisation and tariff reductions.

If in future it is not possible to force blue collar workers to save as in the past and then industrialise the country further, Manuel will have to look at forcing the well-off classes to consume less and save more.

The yawning gap

A policy that will force the well-off to save and invest rather than encouraging them to consume lavishly, will narrow the yawning gap between rich and poor which could tear South Africa apart in the not too distant future.

Manuel deserves praise for having the courage to take on the tycoons in the clothing, textile and motor industries. The tasks facing him are even bigger. He has to face down many sections of the well-off, both black and white, if South Africa is to avoid getting locked into decades of grinding poverty and stagnating economy.

The lesson South Africans who lived in exile learnt is that it is incredibly easy to destroy a country's economy with misdirected, timid and therefore consumptionist economic policies — with catastrophic consequences for everyone's welfare.

● The writer is a partner in a firm of Sandton-based marketing consultants.

Business

The Star

Edited by John Spira

Boom in motor industry holding

STAFF WRITER

The motor industry boom is continuing, with new car sales almost 21% higher in the first half of 1995 than the January to June figures for last year.

Sales for the whole of this year look set to total at least 220 000, with a value of more than R16-billion, against a previous general forecast of 215 000.

Volkswagen yesterday predicted that sales this year could even hit 230 000.

In addition, sales of light commercial vehicles, including bakkies and minibuses, were up by over 31% during the first six months of this year.

Car sales until June were 114 075 against 94 528 in the equivalent period last year. Sales of light commercial vehicles rose from 49 458 to 64 900.

This suggests that a rise in real gross domestic product of

NEW CAR sales are up almost 21%

around 3% can be achieved in spite of the latest interest rate hike.

Sales of trucks were exceptionally buoyant from January to June with sales of medium-duty units rising by 28% while sales of heavy duty vehicles soared by more than 50%.

Sales of both new cars and light commercial vehicles dipped slightly in June compared with May, according to figures released yesterday by the National Association of Automobile Manufacturers of South Africa (Naamsa). But sales were still well above those of June last year.

Manufacturers report that the market is becoming more competitive - Volkswagen has achieved higher sales than for-

mer market leader Toyota for the third month running - and higher interest rates are expected to affect sales.

But Samcor announced price cuts across the board for both Ford and Mazda models yesterday, and this is almost certain to be followed by other manufacturers.

The underlying trend in the South African new vehicle market remained positive, and it was on target for above average sales this year, said Nico Vermeulen, the director of Naamsa.

"The strong performance of the light, heavy and medium commercial vehicle segments of the industry was indicative of the ongoing recovery in fixed investment and reflected continued improvement in the economy."

Total new car sales in June were 19 777 compared with 20 398 in May and 18 474 in the same month last year.

Samcor slashes car prices by 15%

BY AUDREY D'ANGELO
CAPE BUSINESS EDITOR

Samcor is to slash the price of its cars by up to 15% it was announced yesterday.

The latest price cuts follow Volkswagen's introduction of a low-cost small car.

Samcor managing director

Arthur Mutlow said improved productivity "and extensive value engineering have made these reductions possible".

Mike Glendinning, advertising manager of Volkswagen, said Volkswagen had initiated the price-cutting by launching its Chico in April as the lowest-priced small car on the market

at R33 950.

He said it had done so in response to the need for more affordable new cars and, as a result, had become the market leader.

Sales of the Chico totalled 3 811 in April, May and June, giving this model a 15% market share.

(192)

Star 6/7/95

S
B
G
The
Sto
San
pea
res
att
ers
Sto
ma
wit
tee
cul
ne
co
Sa
an
ou
in
po
St
th
be
th
an
be
fi
ce
es
S
S
C
i
t
o
p

Samcor has cut car prices by up to 15%

Star 6/9/95 (192)

■ BY NIALL AITCHESON

Samcor will be cutting its car prices by up to 15% — the second time this year a South African motor vehicle manufacturer has dropped some of its prices

Industry sources said although yesterday's announcement was unlikely to spark an all-out price war, it would probably increase competition for sales of older generation cars. The prices of newer generation models were unlikely

to be affected

Samcor assembles Mazda vehicles in SA, but Ford cars and bakkies account for a substantial part of its sales

Managing director Arthur Mutlow said improved productivity and "extensive value engineering" had made the price reductions possible

Deon Schoeman, editor of Top Car magazine, described the announcement as a tit-for-tat move by Samcor in response to Volkswagen SA's April reduction of the price of

a basic Citi Golf by 13%

"Volkswagen found their volume doubled as a result, but it is important to remember that both the Citi Golf and a Mazda 323 are older generation cars, which have been around for a decade or more

"Manufacturers of new generation models, such as Nissan Sentras and Opel Astras, will find it very difficult to follow suit and reduce their prices"

Officials from other competitors in the market said they would not be cutting prices

A Toyota spokesman said "We have put up our prices from July 1 and we certainly shall not be cutting them. By doing this Samcor have damaged the resale value of their cars"

Nissan managing director John Newbury said the company would not cut prices because the market was reasonably strong, and we offer very good value as it is"

► **Samcor declares war — Motoring**

Industry in new era

someban 6/7/95

THE HISTORIC AGREEMENT signed last week by trade unions and employers in the motor industry is set to change the face of labour relations in the industry.

The three-year agreement — which involves giant car manufacturers BMW, Delta Motor Corporation, Mercedes Benz, Nissan, SA Motor Corporation, Toyota and Volkswagen — is a first for the country's labour industry

It was the first time that SA unions had negotiated a long-term agreement to address structural problems in an industry. It is also the first time in the five-year history of the National Bargaining Forum that agreement has been reached before an earlier agreement expired.

National Union of Metalworkers of South Africa general secretary Mr Enoch Godongwane hailed the agreement as "a great victory" for the union. It was the culmination of the bargaining strategy the union adopted in 1993.

Godongwane said within the next three years, the agreement guaranteed the closing of the wage gap between the highest and lowest paid workers, and will also redress the legacy of the poor education and training of most workers.

Numsa auto sector chief negotiator Mr Gavin Hartford said the agreement laid the basis for the local car manufacturing industry to survive in the global market, while at the same time improving the conditions of workers.

Achieved two ends

The Auto National Bargaining Forum, representing all stakeholders, said the agreement achieved two ends: it settled a series of framework matters within the industry and settled the issue of wages and working conditions.

The ANBF said the agreement would regulate wages, working conditions and other matters of common concern over three years (previous agreements have been limited to a year).

Currently, there is a considerable gap in the wages of hourly-paid workers and artisans. There is also a wide gap between job grades and wages for the same grades which varied from company to company in the same industry.

The ANBF said during the three-year life span of the agreement, all these gaps will be reduced progressively.

The target is to achieve a 10 percent differential between skills levels 1 and 4 (unskilled labourers), and a 20 percent differential between skills levels 5 and 7 (artisans and multi-skilled technicians).

For the lowest-paid worker on skills levels 1 to 4, the minimum earnings will be increased from R10,78 to R12,13 an hour.

This will eventually be increased to R13,66 by July 1997.

The maximum earnings for the lowest-paid workers on the same skills levels will be in-

SA auto unions and employers make history with a long-term agreement to address structural problems in the industry, reports Labour Reporter **Abdul Milazi**



Numsa general secretary Enoch Godongwane ... signed an historic agreement with the motor industry on June 29.

creased from R12,95 to R13,95 an hour, and will eventually stand at R15,02 by July 1997.

The minimum for the highest-paid worker on the same skills levels, which is currently R14,35 an hour, will be increased to R16,15 and eventually to R18,18 by July 1997.

The minimum for artisans and technicians on skills levels 5 to 7, which is currently between R15,78 and R22,78 an hour for the lowest and highest paid, will increase to between R17,76 and R25,57 an hour. It will eventually be between R20 and R28,80 by July 1997.

The maximum, currently at between R22,09 and R31,82 an hour, will be increased to between R23,98 and R34,52, and eventually to between R26 and R37,44 by July 1997.

By mid-1998, all companies in the industry are expected to pay a base wage according to industry-wide grade bands with a specified minimum and maximum.

A clear link between skills and remuneration will be established, while a process has already been started to create new skills levels to cater for career advancement for artisans and technicians.

Most workers in grades 1 to 4 will receive an increase of 11 percent for 1995 and 1996, and will then receive inflation-related increases in 1997.

However, those earnings below the target

(192)
minimum for a particular grade will receive additional increases to bring them up to those minimums.

Artisans and technicians will receive 10 percent this year and less than the inflation rate in the following years. Special provisions have been made to ensure that those with sought-after skills are retained.

The agreement also provides for the proper resourcing of the Automobile Manufacturing Industry Education and Training Board.

A comprehensive peace obligation restrains the parties from engaging in any industrial action in conflict with the provisions of the agreement.

The parties have also built into the agreement an autonomous mediation-arbitration process to interpret disputes and a mediation-option process for other types of disputes.

The ANBF says the agreement was aimed at fostering cooperative relations between employers and workers, and to enhance the skills base of all employees in the industry.

It is also aimed at redressing wage disparities and reducing wage spreads within and between companies in the industry.

Satisfying further preconditions for an internationally competitive industry and promoting stability and industrial peace are some of the other aims of the agreement.

Paving the way

This breakthrough in the motor industry could pave the way for other industries currently facing industrial disputes because of seemingly irreconcilable viewpoints.

Business analyst Mr Ant White said local industries, other than the motor industry, need to overcome the deep mistrust between management and employees if the country wants to improve productivity and compete effectively in the international arena.

"Restructuring business processes and re-engineering organisations will not make South African businesses internationally competitive," said White.

"These initiatives have to be supported by empowering employees and building new bonds of trust between management and workers."

These initiatives have to be supported by empowering employees

Forward-looking motor industry deal can be replicated elsewhere

(192) CT(MR) 7/7/95

It is not often that employers and unions have reason to celebrate together. So what is it that brought smiles to the faces of all participants and prompted them to stage something of a party at the signing of the motor industry agreement last week?

The unprecedented three-year agreement, which covers 25 000 workers in seven companies, is comprehensive, complex, co-operative and forward-looking — more so than any previous agreement in South Africa's industrial relations history.

The most important aspects of the motor agreement are:

- Reducing the differentials between each grade to 10 percent by the end of the three years. Simultaneously, the wage spread within each grade will be reduced to 10 percent.

Those targets will be achieved by differentiated wage increases: the inflation rate plus 2 percent for those below the target rates, inflation minus 1 percent for those above the target rates, and inflation-indexed increases for all others. Those who still fall below their target minimum will get additional increases. Some 8 000 workers will get real wage increases for three years.

- Grades will be based on skills acquired. A certified training programme, with industry-wide as well as plant-specific courses, will be up and running by the beginning of next year.

Thus workers will have access to training as well as a strong motivation to improve their skills and therefore their pay, creating a more skilled and flexible workplace. All workers will have access to at least 80 hours of training by the middle



UNION SMILES Numsa's Gavin Hartford, left, national organiser in the motor sector, and general secretary Enoch Godongwana at the signing ceremony

PHOTO WILLIAM MATALA

SHOP FLOOR



By KARL VON HOLDT

The agreement is more co-operative than any other in SA's industrial relations history

of next year, and further access to training will be negotiated at plant level.

Having established this framework at industry level, Numsa was able to agree to co-operate at plant level in improving productivity, changing work organisation, and establishing pay-for-performance bonus systems.

Co-operation in these areas is subject to very broad guidelines — job security, access to information and training — and there is scope for wide flexibility in arrangements in different companies.

The three-year period provides

time to reach wage targets, and for the parties to focus on workplace change.

The press has made much of a "no strike" clause in the agreement. In fact there is no such thing. Matters regulated under the agreement cannot be subject to industrial action, but this is so with any collective bargaining agreement.

The difference here is that the wage agreement covers three years so there can be no wage-related industrial action for three years. Any other dispute can be taken to industrial action after mediation.

The parties have agreed that all

company "social investment" programmes will be subject to agreement between shop stewards and management, with a view to integrating them into reconstruction and development programmes.

The parties have agreed to pursue "the possible" extension of the national bargaining forum for motor manufacturers to cover allied sectors.

These are the most exciting aspects of the new agreement.

What is their broader significance?

Firstly, it is a tremendous breakthrough for the bargaining strategy Numsa adopted three years ago. It has achieved its core goals

of a more rational industry-wide wage structure based on skills, with narrower differentials between grades.

It has also secured career paths for its members through access to training programmes. Human resources and workplace policies in the industry are effectively now co-determined.

Through these achievements the union has ensured that productivity is increased through an improved quality of worklife, rather than at the expense of workers.

Secondly, through agreeing to take the union's vision of human resources development seriously, employers have won its commitment to co-operate in productivity and quality improvement.

This does not mean there will be no conflict in these areas — there will be.

But there is clearly a new enthusiasm on both sides to go back to the plants and work hard.

□ The writer is consulting editor of the SA Labour Bulletin

Price war may herald new era of cheaper cars

By DEREK TOMMEY

(192) CT (BRK) 7/9/95

New car sales

The latest price war that has erupted in the South African motor trade is centred on Samcor, which makes Ford and Mazda motor vehicles, challenging Volkswagen for dominance of the small car market with the introduction of two new low-cost models.

Samcor said that its new Ford Tracer and Mazda Midge, which supercede the present Ford Lazer/Meteor and Mazda 323 ranges, will sell at R34 357, which is nearly R3 000 less than the next-cheapest five-speed car available on the market.

Samcor added that it would offer not only the lowest-priced 5-speed hatchback and sedan vehicles available on the market, but also the most affordable ranges of small cars.

Volkswagen retorted that the Cit Golf Chico still remained the lowest priced car on the market at R33 950.

Figures show that Volkswagen's pricing policy has been a huge success. Volkswagen captured 23,5 percent of new car sales in June to maintain its

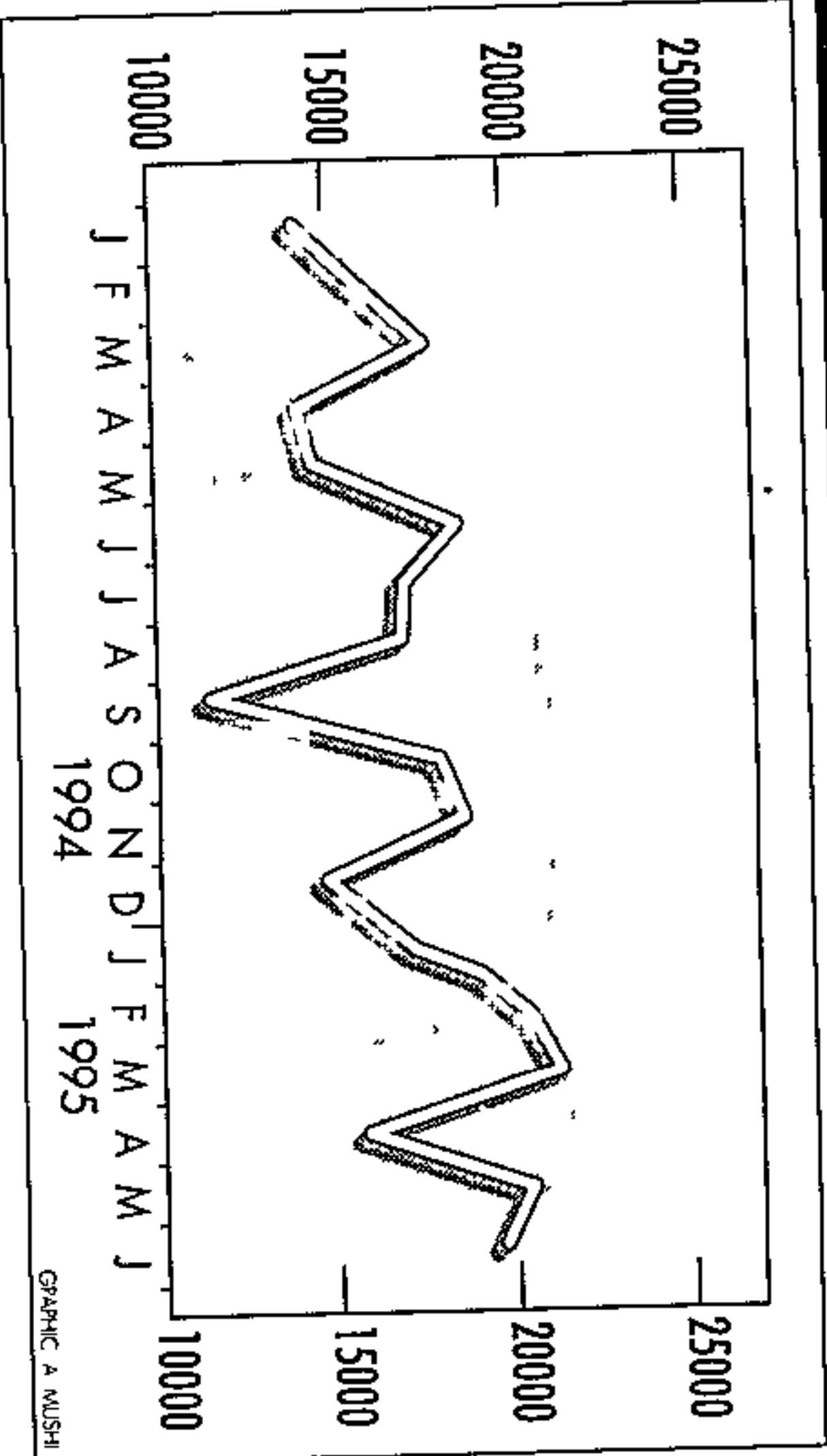

GRAPHIC: A. MUSH

position of market leader.

Volkswagen's marketing director, Graham Hardy, said that recent research had shown that the Chico strategy had attracted private customers to the market which will have the effect of further growing the new car market as a whole.

"This strategy will also increase pressure on our competitors to delay price increases in this sector."

He noted that the ending of its contract to export left-hand drive Jettas to China meant that VW could increase its production for the local market. According to market sources,

Volkswagen was planning to increase production of its Chico model in the next month or so — and could possibly lower the price even further.

Arthur Mutlow, the managing director of Samcor, said the private buyer accounted for only 25 percent of the car market against 50 percent 10 years ago, and that the newly priced small car ranges would make it easier for the private individual, the first-time buyer and the fleet owner to acquire new cars.

Industry sources said the moves by Volkswagen and Samcor were seen as a major bid to overcome the industry's most pressing problem of making cars more affordable to the general public.

One way of doing this was to increase sales and reduce overheads. And these assemblers, said industry sources, had been putting increasing pressure on suppliers to reduce prices, offering in return the carrot of greatly increased orders.

Toyota in particular, and Nissan to a lesser extent, had been hit by the strong appreciation of the yen.

Demand for Dorbyl motor parts augurs well for manufacturing

(192) CT(BR) 7/7/95

By DEREK TOMMEY

The outlook is extremely bright for South African manufacturing — and also for the economy — if what is happening at Dorbyl, the country's biggest engineering group, can be taken as representative of what is happening in other progressive companies

A visit to the company this week showed that growing local and foreign demand for its products — and some of them are world-beaters — is resulting in rising production and, something that has not happened for a long time, — employment

At Dorbyl Automotive Products, the country's leading supplier of components to the motor industry, the labour force is estimated to have increased by around 10 percent in the past few months

At Baldwins Steel, a major steel distributor, a limited second shift has had to be introduced to help the company meet its commitments

And both companies see greatly increased business opportunities in the months ahead

The increasing sales of motor vehicles in South Africa will obviously help Dorbyl Automotive Products. But it has also entered into a number of

joint ventures with overseas manufacturers which will greatly expand its product range

But at the same time it is looking for substantial growth in the export market, where it is already selling large numbers of motor car and commercial vehicle wheels

Exports of car wheels, currently totalling about 340 000 a year, should grow strongly the company believes, while exports of commercial vehicle wheels are expected to rise from around 50 000 a year at present to a rate of around 80 000 a year in 12 months time

Dorbyl's rolling stock division has one of the "world-beating" products up its sleeve. It is the "Chubby" — the only mine-detecting and mine-disposing set of vehicles in the world

It sells for around \$1 million (R3,63 million) and two have just been sold to Uganda. The French army has recently evaluated one of the sets and appears to have been extremely impressed

At the same time, the rolling stock division has developed a replacement for the mini-bus taxi. It is called the Strada and will carry up to 32 passengers and will sell for R250 000. The replacement is said to be far safer,

much more durable and far more economical to operate than the present mini-buses

Dorbyl says its bus will enable the taxi operators to start making profits which few of them are doing today

But this division sees an even bigger business opportunity coming from its link-up earlier this year with General Electric of the United States in a joint venture to manufacture locomotives for the mining industry and other users

The outlook for Dorbyl is quite exciting, says Martin Parry, head of the group's strategic planning. He is expecting the company soon to achieve annual sales of more than R3 billion a year

In the six months ended March, sales totalled R1,47 billion, which was an increase of 27,8 percent on the comparable figure last year

He says the company is making a big drive for exports. These account for about 13 percent to 14 percent of sales at present, but the aim is to raise this figure to 20 percent

Dorbyl reported earnings of 184,5c a share for the six months ended March, more than treble the 184,5c earned in the whole of the 1994 financial year

MOTOR INDUSTRY

Hyundai's assembly challenge

PM 7/7/95 (192)

Hyundai has asked for four years, instead of the recommended two, to set up a full-scale vehicle assembly plant in Botswana. If agreed, the plant will provide hundreds of jobs and initially build 2 500 cars a month — most destined for the SA market.

At precisely the same time as the SA government's new motor industry development plan (MIDP) sets out to create rationalisation in an already overcrowded market, Hyundai has set aside P100m to build a new plant in Gaborone. But it says it is impossible to meet a two-year deadline set by SA's Board on Tariffs and Trade (BTT).

The deadline, imposed earlier this year and incorporated into the recently announced MIDP, is intended to settle a dispute that has allowed Hyundai to escape import duties on semi-built-up vehicles.

The dispute was created by previous legislation governing full local assembly and partial assembly of vehicles. The intention was that vehicles requiring full assembly could avoid import duties that once ranged as high as 110%. They are now at 80%. Under the MIDP, they will soon fall to 65%, then in stages to 40% in 2002.

Under the definitions, however, vehicles arriving partially built also qualified. A number of established SA vehicle assemblers took advantage of the situation to bring in limited numbers of semi-built-up cars on the cheap. But it was the appearance of Hyundai that really sparked debate. Unlike its competitors, all of whom carry out full assembly on most of their products, the South Korean-sourced company has never tried to do so.

Its Botswana plant performs only limited assembly. Cars are imported in semi-knocked-down (SKD) form, and the Botswana plant finishes the job. According to Hyundai spokesman Les Watson, the body shell and trim are imported complete, but more than 250 components have to be added. As Botswana is part of the regional Customs Union, products made there are considered local by SA and other members

Without the full cost overheads of SA companies, Hyundai has been able to sell cars in the local market at highly competitive prices. Though no official sales figures are available, it is estimated that the company sells more than 1 000 cars a month.

Hyundai has argued that to move into full assembly will increase costs and add to the price of its vehicles. Competitors counter that, having been forced into huge over-



heads by previous industry programmes that required them to invest billions, it's unfair to allow a newcomer to cut corners.

It was their argument that swayed the BTT. SA assemblers were told that, from July 1, SKD vehicles would no longer qualify to evade duty. Hyundai was offered a two-year extension, to July 1 1997, on condition it switched to full assembly. To qualify for the extension, however, it had to present a detailed business plan, showing how it intended to make the transition.

The plan was handed last week to the Botswana government, which will now discuss the matter with SA. Watson says that, while the company is willing to undertake full assembly, to do so in two years is unrealistic. Given Botswana's limited infrastructure and facilities, he says consulting engineers have told Hyundai it will take at least 18 months just to put up the buildings. Thereafter, the company will have to build and install assembly lines, paintshops and other plant and equipment, and then undertake production and operational testing before it is ready for business.

Watson says Hyundai needs a 14 ha site

for its new factory, of which 18 000 m²-20 000 m² will be covered. The building alone will cost an estimated P30m, and installations another P70m. Watson says the company aims for a starting production of 2 500 vehicles a month, split between the four existing models sold in SA — the Accent, Sonata, Scoupe and Elantra. Production capacity will allow greater numbers, depending on demand, and there is also the possibility of introducing a new light commercial vehicle range.

The local company is also negotiating with its Korean parent to export into Africa. Hyundai already has an assembly plant in Mutare, Zimbabwe, building the Excel, but Watson says the proposed Botswana factory is no threat to this venture.

Hyundai has another sticking point: the question of quotas. The BTT's recommendations include as-yet-unspecified production quotas for the existing semi-assembly operation in the run-up to full assembly.

This is unfair, says Watson. "SA companies have had decades to achieve full assembly and to amortise their costs. While they were doing so, they had no quotas. On top of that, they were hiding behind protection of up to 110%."

He adds that quotas will also limit profitability and stunt market development. "Where will money come from to build the plant? It should come from profits."

Watson says the Botswana government supports Hyundai's views. He says Hyundai is that country's biggest industrial exporter and a major employer. From the current 452-strong workforce, he expects employment to be about 750. If there's no agreement, all jobs — including existing ones — could be lost. If it has to pay the same duties on imports and local part-assembled vehicles, the former is more cost-effective.

It's unclear how long it will take for a decision on Hyundai's counter-proposal. Given Botswana's economic and employment interest, there's likely to be plenty of government-to-government discussion before a decision is made. A compromise — possibly a three-year start-up period — can't be ruled out. ■

CAR PRICES

Speeding down

Vehicle manufacturer Samcor — owned jointly by Anglo American and Ford — has fired the latest shot in the price war at the

economy end of the SA car market

Its new bottom-of-the-range Fords and Mazdas are more than 13% less expensive than their predecessors, making them the cheapest five-speed cars on the SA market, according to Samcor Marketing MD Arthur Mutlow. At R34 357, the 1.3l Ford Tracer and Mazda Midge are nearly R3 000 less than the opposition.

VW's four-speed CitiGolf Chico, at R33 950, is the only car costing less, and VW announced this week that it was holding that price. Samcor's announcement will up the stakes among SA manufacturers already under pressure to cut costs and provide more affordable motoring. Some companies warned earlier that the rand's continued slide would make it difficult to limit price increases to previous forecasts.

Mutlow says the new products, plus a more competitive pricing strategy for all its other vehicles, are intended to realign them in the market. It won't do any harm if they help to realign Samcor, either. Sales of Fords, Mazdas and Mitsubishis have often been disappointing, and the company needs a long-term change of strategy to reassert itself in the market. One can see the hand of MD Jim Miller, imported from Ford of the US early this year to rejuvenate the SA company, in this latest move.

Intensifying competition at the bottom end of the market is likely to increase this sector's growing share of the overall market. Although, in historical terms, R34 000 and upwards is not cheap, any move to reduce prices and bring cars within reach of the private buyer is to be welcomed. ■

PAPER INDUSTRY

A new chapter

The story of the paper manufacturing industry in the past 18 months has been one of rags to riches. A little under two years ago, prices for international pulp were hovering around the US\$400/t mark. Now they are set to break \$1 000/t.

From the early Nineties shareholders were forced to bite the bullet as the pulp and paper industry went through four years of marginal profitability or, in some cases, losses.

But now the industry is on a roll and the strong trend is likely to continue at least until the end of the year, says Mondi MD Derrick Minnie.

One of the main victims of this surge is newspaper publishing, with US and UK publishers looking at newsprint prices of \$745/t from current levels of \$675/t. Early last year prices hovered at \$411/t.

Unlike their overseas counterparts, local newspaper publishers — Times Media (TML), the Independent Group, Naspers and Perskor — have fixed contracts on

newsprint supplies. But the picture is expected to change at the end of the year as contracts run out and Sappi and Mondi find themselves in the driving seat.

However, TML MD Roy Paulson says the group has renegotiated a good three-year contract with Mondi and will be entering into talks shortly with Sappi. "We are to some extent protected from the cost spiral. Some US publishers are anticipating price rises of about 45%. This cannot be recovered from cover prices or advertising and so comes straight off the bottom line."

Few commentators realise that nominal international paper prices in the first quarter of 1995 were still below the levels at which they traded in 1990, says Sappi chairman Eugene van As.

He adds that while the industry appears set for a period of vastly improved returns "in real terms prices are still well below where they were five years ago."

In the past year, increased demand coupled with the cost-push effects of essential raw materials, including chemicals and pulpwood, have resulted in regular price increases on paper and board products.

"Increases in demand considerably exceeded forecasts by paper and board converters," says Minnie.

Depending on grade, paper has risen by 40%-60% since March last year, says Holdains CE Richard Bruyns. Grades include fine, A4 copying/writing paper, and tissue. Carton board has been affected to a lesser extent. Because of previously negotiated contracts, corrugated board has not been affected yet. But this is about to change.

Nampak CE Trevor Evans says these contracts have just about run out. "To some degree we have been shielded from the full whack of what has happened. But we will now feel the pain as price increases in this sector are imminent."

Bruyns says the industry has been under "severe pressure" following regular quarterly increases in most paper types. Business forms paper prices have risen on average by 71% over the past year, which has affected the price of computer continuous forms and other business stationery. Quarterly price increases for these papers are forecast for the next six to 12 months. ■

HATCHING AN UGLY DUCKLING

Government has hatched a radical plan to pool the resources of the Industrial Development Corp (IDC) and the Development Bank of Southern Africa (DBSA).

The combined holding company will have long-term assets of R13,6bn and shareholders' funds of R12,1bn.

The IDC and the DBSA, transformed according to a further plan, will retain their institutional identities and operating independence. Their borrowing functions will be transferred to the holding company, which could approach the capital market for funds on the strength of the combined balance sheet.

According to the DBSA report, the realignment will "create a powerful vehicle for placing the IDC's historically white-dominated wealth at the service of needy communities." The report claims the process of redistribution will be productive and conducive to economic growth — a claim that might still be the subject of intense debate.

Under the proposed arrangement, the new Infrastructural Development Bank (IDB) — the proposed name for the new look DBSA — will have two lending windows. Soft loans will be dispensed by the "concessionary" window, hard loans by the nonconcessionary window.

In the IDB's governance, "an appropriate balance" is to be maintained be-

tween political responsibility and operational independence. Political influences are to be accommodated in the mission and mandate of the bank.

There is a major caveat: international experience warns that political interference is one of the main reasons for the failure of development finance institutions. They should be governed according to financial criteria, transparency and accountability.

The proposed transformation of the DBSA involves narrowing its focus. But this will be at the cost of diversification. Concentration on a narrow band of activities raises the institution's risk profile and makes it harder to gear lending with private-sector borrowing, especially for projects which do little more than cover costs. Hence the proposed merger.

Shorn of its apartheid-related activities, the IDB can focus on providing infrastructure for deprived communities.

The report envisages a realignment of the Small Business Development Corp, Small Business Development Agency, the Land & Agriculture Bank (formerly the Land Bank) and the proposed National Housing Finance Corp.

The IDC will retain its focus on industrial finance but the SBDC and Small Business Development Agency are meant to finance micro, small and medium businesses. ■

Car sales stall as prices take off

STC (BT) 2/17/95 (192)

By DON ROBERTSON

THE prospect of continually rising prices, higher interest rates and the first signs that the economy's growth is tailing off, are likely to put a brake on new vehicle sales in the second half of the year.

Total sales in the first six months increased in line with industry expectations, rising by 25%, to 184 628 from 147 975, but some manufacturers as well as the National Association of Automobile Manufacturers of South Africa expect consolidation in new car sales in the months ahead.

Eric Scoble, marketing manager at Mercedes-Benz, says sales growth in the second six months will be lower as a result of higher interest rates and rising retail prices caused by monetary policy and the deterioration of the rand. Stephanus Loubser, managing director of Nissan Marketing, cautions that the rand's weakening, particularly against the Japanese

yen, and the rising trend in interest rates could put a damper on second half sales.

Economists predict that the growth in GDP will be between 2,5% and 2,9% this year, compared with earlier forecasts of 3,3%.

But all are confident the year's sales will be well above average, with Volkswagen suggesting new car volumes of 231 000, compared with 193 666 last year.

The release of the half-yearly figures coincides with the latest round of price hikes and as the industry agonises about the problem of affordability, Samcor has reduced prices on all models except the recently launched Etude and Bantam Rustler. The Ford Meteor has been

dropped from the line-up and is replaced by the five-speed Ford Tracer, while the Mazda 323 becomes the Mazda Midge. Both are 13% cheaper than the previous models at R34 360, marginally higher than VW's Citi Chico.

Depending on the model, the Mazda 626 and the Ford Telstar are now between 2% and 3% below competitors' prices, while the full light commercial range is about 3,7% lower.

Quoting the impact of the de-terrorating value of the rand, BMW has announced an average 3% increase on all models except the 5-Series. In the adjustments, all 3-Series models will now include a passenger side airbag, valued at R1 900. The 325i remains unchanged, but will be replaced by the new 328i in August. BMW raised prices by 5% at the beginning of the year. Nissan will lift prices by an

average 1,5% tomorrow, after a 2,5% hike in January and 2,3% rise in April.

The price of the Toyota Conquest, Corolla, bakkie, Hilux and Venture is up 2% this time after the combined 8% move in January and April. The Camry, rises by 1,5% after an earlier 5,5% increase, while medium and heavy trucks remain at prices ruling in December last year.

Delta follows with 2% increases on cars and bakkies, having adjusted levels by 3% each in January and April. The price of the Volkswagen Golf and Jetta has been raised by 2%, but the Citi Golf range, including the low priced Chico, remains unchanged. In January, prices were up 1,3% and 2,1% in April. The Audi cabriolet, A6 and Avant moved up 4,5%, the first increase this year. Mercedes-Benz will review prices at the end of this month.

STEPHANUS LOUBSER

MD of Nissan Marketing

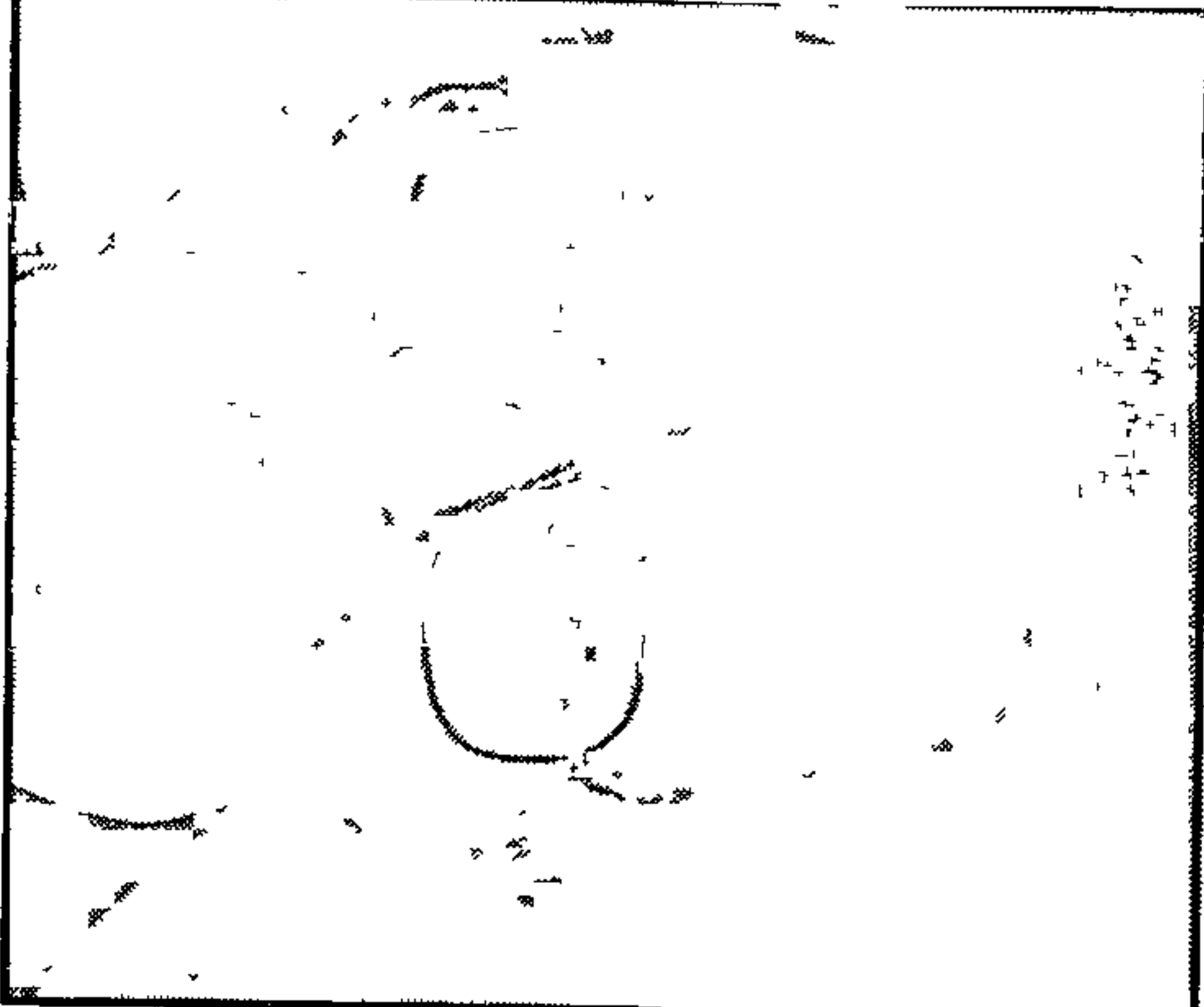

The price is right if the value is real

By ANDY ANDREWS

ST (BT) 9/7/95

(192)

TRADE and Industry Minister Trevor Mameel's proposal to restructure the motor, textile and clothing industries is getting SA business on to the right track and into the right state of mind

The companies in these industries who will prosper will be those who face reality earliest and behave and manage in the most proactive way. They will recognise that the rules have changed and begin "training" and preparations for the new game that will emerge after the transition.

Those companies that will wither and decline will see the restructuring as a problem and a threat and not as an opportunity. They will look back longingly at yesterday, when "value" was determined by protective tariffs and "orderly marketing".

There is no doubt that we are all in the middle of the "value decade". All of us want more value. We want more value for the money we spend, we want more value from our government leaders and we want more value from our local services like the police and local government.

What does "value" mean?
For a start, in many markets and industries it means increasing pressure on price for a start. Customers will call for and eventually demand better prices

They may not want all the bells, whistles and frills that marketers add to their products in a desperate and often futile drive to differentiate their products. Desperate because their market shares are falling and futile because customers are not prepared to pay for features that are really not required. How many of us are frustrated and irritated by the fact that one seems to need a course to operate a video recorder because it has become too complex?

Customers want quality but they relate quality to price — and it is this combination of price and quality that determines value.

All over the world companies in almost every industry have been increasing capacity and globally there is an excess capacity overhang.

In previous decades, global excess capacity was not a threat — but today it is an enormous threat to local companies. The new, more efficient and low-cost distribution systems and the reduction of trade barriers means that almost everybody has access to everything. In South

Africa we have seen fresh meat being imported from Australia and New Zealand and chicken from Europe. Our exports must also deliver "value" as the fishing industry is discovering with the European Economic Concession's Cornumer protection system. We will deliver more "quality" at the same price or face the prospect of losing an export market of R450-million a year.

We can illustrate the relationship between price and quality by using a "value map" as follows.

Research has shown that relative perceived quality (which is defined as your served market's perception of your quality relative to the offerings of your competitors) and profitability are strongly related. Whether you measure return on sales or return on investment, businesses with higher relative perceived quality and better prices beat their competitors hands down.

- The higher value players have
- stronger brand loyalty,
 - higher repeat purchase rates,
 - less vulnerability to price wars,
 - the ability to generate higher margins,
 - lower marketing cost and
 - tend to gain market share.
- The value map above shows that customers tend to align products along a

"comparable quality for price curve" so that each competing product provides the same value. Most products will fall along the diagonal line that stretches from the "commodity/economy" end to the "premium" products. But there are businesses that often, by accident or design, end up providing no price premium for relatively low value products.

The dangers of the "poor value" business should be obvious. They offer "poor value" and can't understand why they begin losing market share.

Their capacity utilisation falls, and profitability declines as fixed costs are spread over fewer units of output. What is the loser's response? Typically they increase advertising and promotional spending instead of addressing their "value" position and get into an accelerating profit decline.

SA companies must understand their "value position" if they are to survive in the global market. Aggressive international players are offering better value and simply increasing advertising spend will not solve the long-term problem of "poor value".

Andy Andrews is director of the Graduate Institute of Management and Technology, which offers the Henley Executive MBA in South Africa and consults on strategy using the PIMS database.

Nissan sets precedent with health care model

Kathryn Strachan

A UNIQUE managed health care plan devised for Nissan workers could become a model for other SA companies

Nissan SA, together with Numsa, insurance brokers Alexander Forbes and medical aid administrators D&E, devised a plan giving the company's hourly-paid workers at its Rosslyn plants a choice of different levels of health care.

In the past, hourly-paid workers have been largely excluded from joining company medical aid schemes because they do not have the same status as permanent salary earners

Private medical aid schemes for such workers have failed because of high claims and costs.

Some have been "fly-by-night" operations which have collapsed

"By developing the plan in partnership with the workers' union we are ensuring the managed health care plan will meet work-

ers' needs and will be accepted by them," said Brian Moor, human resources director of Nissan SA

The first level of the scheme, fully paid for by the company, is intended to cover basic requirements such as medicines and general practitioners

Workers can choose to join module two or three, which will cater for hospitalisation, optometry, specialists and dentistry.

These modules will be subsidised by the company, with the level of subsidy still to be finalised.

To reduce costs and ensure claims are held at reasonable levels, while making medical care accessible, a clinic has been opened.

The staff is employed by the managed health care plan. Nissan's workers and their families must use the clinic for treatment or referral to specialists.

Families who live at a distance will utilise their local medical facilities but will be covered.

Nissan warns on price war

(192) Star 12/7/95

■ BY ROY COKAYNE
PRETORIA BUSINESS EDITOR

Another salvo has been fired in the car price war, with Nissan South Africa warning that buying cheap now may cost you dearly later because of lower second-hand value

This follows Samcor's announcement last week of reductions of up to 15% in the price of its cars

Samcor's price cut followed Volkswagen's lead in introducing a new price structure for its Citi Golf range in early April

Nissan responded to this initiative within a day by announcing a new financial plan to reduce repayments on

its entry-level Uno Fire. Nissan stressed at the time it had not cut the price of the Uno because of the risk of reducing its resale value

Toyota has also said Samcor's price cut will damage the resale value of Samcor cars, adding that people did not buy a car on price alone, but took other factors into account, including the resale value

Stephanus Loubser, Nissan marketing managing director, advised buyers to look carefully at the total cost of ownership rather than only the initial purchase price

"The price cuts taking place now are cosmetic as they merely formalise discounting which has been taking place

on older, low-demand models

"No manufacturer or dealer in South Africa can afford this and at the same time hope to consistently offer excellent service, affordable parts, prices and maintain resale value of over 85% after three or four years," Loubser said

"I advise all prospective purchasers to be extremely cautious about the resale value impact on entire ranges where the entry level model price has been reduced

"The trade has already started discounting used vehicles in these categories. Who will buy the used car if cheaper versions of basically the same vehicle can be bought as a new car?"

Hyundai asks for time

(192) SPAN 13/7/95

BY ROY COCKAYNE
PRETORIA CORRESPONDENT

Bilateral negotiations are currently taking place between Botswana and South Africa about extending the two-year dispensation granted to Hyundai Motor Distributors (HMD) to allow it to convert its Botswanan facilities to comply with new customs regulations.

The new regulations, which were effective from April 1 this year, closed the loophole that allowed motor vehicles to be imported into the Southern African Customs Union under full rebate without any major investment in plant or employment.

Hyundai projects manager Les Watson said it was difficult for a company to achieve CKD manufacturing when it had to build a facility from inception.

He confirmed the company had submitted a business plan to the Botswana

authorities in terms of which 100-million pula (R130-million) would be invested to convert its semi knocked down (SKD) car assembly operation to supply vehicles from completely knocked down (CKD) kits.

But Watson stressed Hyundai as a company — and not its SKD facility — would convert to CKD manufacturing.

Watson said the plan was to build a totally new CKD plant from inception in Gaborone which, because of the demands of CKD, would be six times larger than its current SKD premises.

Converting to CKD means Hyundai will have to introduce several new production processes and activities. These include such things as welding jigs, an expensive paint shop and trim section for finishing the inside of vehicles.

In terms of the business plan, the first CKD vehicles should be off the assembly line in 1999.

R100m IDC investment for Atlantis Diesel

By PETER GALLI

(192)

FEATURES EDITOR

ET(BR) 13/7/95
The Industrial Development Corporation (IDC) is to invest more than R100 million to transform unlisted Atlantis Diesel Engines from a pure engine manufacturer into a diversified component manufacturer, the corporation's managing director, Carel van der Merwe, said yesterday.

The IDC has a majority interest in the company, holding 87 percent of its equity.

Van der Merwe said the IDC had received no cash payment for the sale of part of its stake in South African Micro-Electronic Systems, said to be worth about R300 million, to Austria Mikro Systeme, which was announced yesterday.

While minority shareholders had been paid cash for their interest, the proceeds from the sale of the IDC's interest would be channelled back into the company.

"We are trying to shift our focus to more labour intensive operations," he said.

Major facelift on way for ADE

(192) Star 13/7/95

The Industrial Development Corporation (IDC) is to invest more than R100-million to transform unlisted Atlantis Diesel Engines from a pure engine manufacturer into a diversified component manufacturer, IDC managing director Carel Van der Merwe said yesterday.

The corporation has a majority interest in the company, holding 87% of its equity. "We are considering our options with Atlantic Diesel Engines, but we expect to sell part - or all - of our interest in it at some stage. This could be to a foreign company or to a local corporation, but we are only at the planning stage and will not dispose of our stake in it before its transformation to a diversified component manufacturer is complete - probably in four to five years' time," he said.

Toyota spends R1,4-bn to enter world market

(192)

Star 14/7/95

■ BY ROY COKAYNE
OWN CORRESPONDENT

Toyota South Africa is to invest more than R1,4-billion by the turn of the century in tooling for the manufacture of three new models, upgrading the company's production facilities and training and education for its workforce

The investment is focused on gearing up Toyota SA to become a world class manufacturer with substantial export potential

This export thrust will be into Africa, First World countries and emerging markets in the East

Toyota SA executive chairman Bert Wessels did not specify exactly how the R1,4-billion investment would be funded. However, he said in the past Toyota had managed to fund its investments and working capital out of amortisation and write-offs of facilities and profits

"Toyota SA has also followed a policy of covering its dividend five to six times. We hope to fund this investment ourselves but if the situation arises, there is no reason why we shouldn't embark on a right issue," he said

Wessels said R900-million would be spent in tooling up for the local manufacture of three new models

Another R100-million a year would be spent in ensuring the

R900-MILLION will be spent on tooling up plants to world class manufacturing standards

company's facilities were in line with the requirements of world class manufacturing standards

The company will also increase its current human resources department's annual budget by 20 to 25% in real terms - because of the greater importance being placed on the upliftment of its work force

Wessels said the first of the three new models - a new Corolla - would come off the assembly line towards the end of next year

He added that light commercials were among the three new models it planned to launch

Wessels said certain of Toyota SA's Corolla/Conquest models would be retained as long-life models after the introduction of a new Corolla

He said about R300-million would be spent on tooling and R25-million on component tooling for the new Corolla with another R50-million on the assembly facilities

Wessels said much of the R100-million a year to be spent annually on upgrading its pro-

duction facilities had been spent this year on increasing its plant capacity to 500 units a day (11 5000 units a year)

He said Toyota SA recently concluded a 10-year manufacturing agreement with Toyota Motor Corporation (TMC) in Japan, which included an expansion of its export markets within Africa and the manufacture of certain left hand drive vehicles for export

Wessels said this commitment to the future of Toyota SA and South Africa followed the announcement of the proposed final Motor Industry Development Programme (MIDP), which was expected to be implemented from September 1 this year

Wessels said Toyota SA would commence with the export of left hand drive vehicles into Africa next year. This would involve the Stallion and Venture, including diesel derivatives, he said

"We expect to be in a position to export at least one model to First World markets and emerging markets in the East within the next five years

"We also expect that exports could grow to a point where they account for between 15 and 20% of our local production by the year 2000," he said

But he added it was premature to talk about the particular model it would produce for first world markets

Toyota plans R1,4bn project

Mungo Saggot (192)

TOYOTA SA would embark on a R1,4bn capital expenditure programme over the next five years which could see it hold a rights issue, the company said yesterday

Chairman Bert Wessels said the company would spend about R900m on launching three new vehicles over the five-year period and R100m a year on its manufacturing facilities. The launch of the new Corolla next year would cost about R300m.

As previously, Toyota would try to fund its spending internally, but a rights issue was possible.

He said by 2000 exports could account for 15%-20% of local production and the

80/14/7/95
company could soon export at least one model to a First World country. It also intended to export some left-hand drive vehicles to other African countries.

Wessels said he had "some gripes" with the final proposals of the motor industry development programme, which would see a gradual reduction in import tariffs on cars and car parts from September 1.

He hit out at the continued application of the small-vehicle incentive programme — which went against recommendations from all parties in the Motor Industry Task Group — and said the subsidy should benefit the minibus taxi market.

Continued on Page 2

Toyota

Continued from Page 1

Import tariffs on built-up vehicles were expected to drop to 65% from their current 75% on September 1. The new regime, to be forced by the phasing out of tariffs, could see car prices drop 3% in real terms in the short term and 15% in seven years, Wessels said.

Meanwhile, group marketing director

(192) 80/14/7/95
Johan van Zyl said the company had sold 51 886 vehicles this year and was on track to sell 100 000 for the full year — a feat last achieved in 1984.

He said Toyota, which remained reluctant to enter the under-R38 000 market, would soon launch the Conquest Zip. The car would sell at R51 839 — R800 more than the bottom-of-the-range Conquest 130, but with added features.

Plan to make cars more affordable

Wm (BAM) 14-20/7/95 (192)

Karen Harverson

OCAL car prices have increased above inflation over most of the past 10 years and are unlikely to drop as a result of the implementation of the Motor Industry Development Plan for locally produced cars in September this year.

National Association of Automobile Manufacturers of South Africa (Naamsa) director Nico Vermeulen says the plan is designed to promote greater affordability but each vehicle assembler will react individually.

He anticipates that production of small volume car models will decline by half within the seven-year implementation period of the plan, while the proportion of imported completely built up units (CBUs) — currently less than one percent of the R17-billion a year new car industry — will increase.

New car sales are expected to reach 230 000 this year, compared with last year's 190 716, which was 20 percent lower than the peak of 301 528 reached in 1981.

"We expect car sales to gradually surpass the 1981 peak by the end of the millennium provided the South African economy experiences real growth of four to eight percent in the next five years," says Vermeulen.

Seventy-five percent of cars sold in South Africa are sold into the corporate and fleet markets.

As an industry, the automotive sector exported R1,8-billion CBUs and components last year.

Price of certain car models today compared to 1990

	April 1990	July 1995	Percentage above or below an inflation-related price
Citi Golf (5/1.3/4) now called Chico	R22 284	R33 950	13% below
Corolla 1.3i (4/1.4/4) now called Corolla 130	R26 120	R51 039	11% above
Mazda 323 1.3i (5/1.3/5) now called 130 Hatch	R22 272	R40 480	Kept pace
Ford 1600 Sport (5/1.6/5) now called Ford 16	R28 945	R47 082	7% below

Name changes and structural and value added charges may have been implemented since a model was launched.

Current car market leader Volkswagen has no plans to reduce car prices across the board despite its launch in April this year of the lowest-priced small car in the market.

"In the past we've been premium priced but are now embarking on a realignment in the cost of our cars relative to our competitors. We're holding prices, as opposed to cutting them, for a period of time," says marketing director Graham Hardy.

Toyota SA public relations manager Roger Houghton says that Toyota will not drop prices of existing models, although he believes the MDP will lower car prices in real terms over a period of time.

Samcor managing director Arthur

Mutlow says the company has already lowered the prices of the vast majority of its passenger and commercial vehicles and supplies the two lowest-priced entry-level five-speed, 1.3 hatchbacks and sedans.

He comments that these cuts are not short term, but a change to the company's basic pricing structure.

Nissan South Africa chairman John Newbury says he does not anticipate any immediate reduction.

"However, local assemblers will be under pressure to meet the price challenge of imported vehicles and the entire question of improving productivity now assumes critical importance in containing costs."

Delta Motor Corporation sales and

marketing director John Cumming feels the MDP is unlikely to cause price cuts in the short term although in the longer term, duties will be lowered and a reduction in the real price of new vehicles can be expected.

BMW public affairs GM Chris Moerdyk says the company has reduced prices on a number of models although price lists do not reflect this.

"While the price of a specific model might have increased by three percent, additions to it include driver and passenger airbags, an upgraded engine and the free maintenance content within the purchase price has increased from two years to five years, all of which amounts to added value of about six percent, with the result that the price is three percent lower."

He comments that recent price cuts by Volkswagen and Samcor applied only to models that were more than 10 years old.

"We intend to convert the BMW plant from a production facility catering for all South Africa's BMW requirements to an export-based plant producing one model in far greater volume for world markets, and using part of the foreign earnings to import a relatively smaller volume of other BMW models required by the local consumer," he says. He adds that pricing is dictated by both economy of scale production and the local exchange rate. "In BMW's case, with the rand losing steadily against the Deutschmark, it is difficult to reduce prices significantly."

By concentrating on exports in the future, BMW hopes, in the long term, to double or treble its current volume locally.

Local lad makes it to the top of Motorola

(192) wmm (Bm) 14-20/7/95

Since dropping out of med-school, Sello Matsabu has come a long way to take the reins of Motorola's South African operation **Meshack Mabogoane** reports

THE appointment of Sello Aggrey Matsabu, 40, as an executive chairman of Motorola SA, may have come as a surprise. For a South African to head the local operation of this giant, multinational is a vote of confidence in local management expertise.

Virtually unknown in the corporate world, Matsabu, nonetheless, has had many years of training and experience in information infrastructure.

With only a year to go as a medical student at Natal University in the early 70s, Matsabu, inspired by fellow students and black consciousness leader Steve Bilko, became entangled in student activism. Dropping out was a blow to his "hard driving" father who had pressed him to be a doctor. However, this "disappointment" was soon to lead Matsabu to the information highways and byways.

In 1976, he joined IBM in Johannesburg and received training in software engineering for technical support services. IBM had just initiated an extensive training programme, spurred by its need for technicians, as well as growing pressure, later codified as the (Leon) Sullivan Principles, for United States companies to implement training programmes for black technicians and managers.

After six years during which he gained considerable experience working for major clients like South African Airways and Legal and General, he felt he needed advanced training and development.

On his own initiative, Matsabu went to the US — not, at least initially, for further study, but to exercise his South African-acquired skills in the country with the edge in information technology. In 1982 he joined a New York consultancy, Personnel Sciences, where he was soon made a manager. This was followed by a stint

in the New York City Department of Finance again as a manager.

His big break came when he moved to American Telephone and Telecommunications (AT&T), where he spent three years. He became involved in the design of data communications networks which entailed planning and applied research. He returned to his alma mater, IBM, in New York, and worked there from 1988 to 1994.

Matsabu puts his success, for which he had no theoretical or academic training, down to several factors. There was the legacy of his parents' (both school teachers) drive and insistence that their children should take on challenges and excel. "The role of parents in instilling the right attitudes and values is crucial. Parents should not abdicate this role to schools and other social institutions. These have their role as well, but they should not supplant those of parents in laying the right foundations."

He also cites the contribution of his high school maths and science teacher, the late JA Nakedi. In the depressing black education system he says "I was fortunate in having had a teacher who stressed the need to think analytically rather than learning by rote. He motivated us to acquire skills and explore whatever problems and tasks we had. This spirit has inspired and sustained me up to this point." The role high school teachers should play as mentors is a theme Matsabu keeps coming back to.

He says information technology is largely a hands-on exercise which requires practical sense and self-motivation.

Sensing, perhaps, that he would not spend all his life immersed in calls and wires, he went to Wharton School of Business in Pennsylvania where he obtained — not its prestigious MBA — but a basic, undergraduate business

degree. An avid fan of Alvin Toffler, the apostle of modern technology, Matsabu insists continual education and training should be integral to product and career development. To keep up with technological changes. And naturally, for a communications fundi he cites Marshall McLuhan's dictum that the world has become a global village and that a greater awareness of the implications of this is indispensable as the world gets wired

high school training and would like to extend this to others," says Matsabu. "We should never dilute investments in human resources."

As Motorola's executive chairman, Matsabu will concentrate on corporate-public sector relations, working with all stakeholders in telecommunications ("to realise the objectives of RDP"), in developing the market for Motorola in Southern Africa and maintaining links with the worldwide Motorola operations. There are no plans as yet to set up manufacturing plants in South Africa.

Though he is confident that rapid improvements in technology will reduce costs, he is concerned about the high tariffs which protect Telkom. Once these are removed or reduced, cellular phones, for example, could be mass marketed, he says. And this would benefit poor areas where conventional phones do not exist.

Not surprisingly, Matsabu has strong views on affirmative action and the role of black managers and professionals. "Affirmative action is important. But, most significant is the need to provide real training so that people can do effective work. This must start at the bottom. But, to take a person, give him or her an office and a car, and for the company to merely boast about such moves, is wrong."

Cultural roots are also vital, he says. "That is what makes a person." Referring to his links with Evaton, Gauteng, where he grew up, he maintains "Black achievers must reinvest in their community," as part of their social responsibility.

"If I spent 10 years at Motorola without making a social impact, I would be a failure. There has to be a spiritual and intellectual revolution among the black elite alongside economic and political changes."

Matsabu, a jazz aficionado and soccer enthusiast, is married to Mampiti Sekeke, a civil engineer and Lesotho citizen, whom he met in the US. The couple has two small children.



Sello Matsabu Black achievers must reinvest in their communities
PHOTOGRAPH RUTH MOTAU

More importantly, he believes schools should concentrate on enhancing technical, analytical and innovative skills to prepare students for effective participation in technological developments. Motorola runs its own hands-on university in Chicago. The company also supports a project to improve the maths and science training skills of black teachers. "They need support and direction. I am a product of good

No chance of cut in car prices

(192)
WM (P.M.) 14-20/19/95

Karen Harverson

CONTRARY to widespread expectations, car prices will not be cut drastically this year. However, when the new Motor Industry Development Plan is implemented in September, the price hikes which domestic car buyers have endured over the past five years are likely to be contained.

"Car prices have been increasing above inflation for the past five years, mainly due to the phase 6 local content programme," says National Association of Automotive Component and Allied Manufacturers (Naacam) director Denzyl Vermooten. This programme, based on value, has inherently inflationary elements, he says. For instance, export incentives were built into the price of the locally manufactured vehicles, resulting in domestic buyers subsidising automotive exports.

One of the aims of the new plan is to make cars more affordable for South Africans by improving the competitiveness of the automotive industry and lowering barriers to overseas competition.

Vermooten says that the industry must take steps to reduce the variety of models being built locally to enable component manufacturers to produce higher volumes of a reduced variety of parts. Bigger production runs would bring down component costs. About 30 percent of the components used are locally manufactured.

South Africa has seven assembly plants producing 10 marques (brands) — with more than 40 models in total — for a local market of only 300 000 vehicles. Average production per model is about 7 500 units compared to well over 100 000 in Japan, Europe and the United States. Even low volume producer countries, such

as Brazil and Australia, produce more than 30 000 units per model.

The plan will force local assemblers to choose one of three routes: increase local content of vehicles, concentrate on the export route, or a combination of both.

Rationalisation of certain sectors of the 44 000-employee, R8-billion-turnover component sector is expected to occur depending on the course taken by the vehicle assembly sector.

Some models may be discontinued and, if these models revert to being completely built up (CBU) imports, the component industry will not show much growth and jobs will be lost. "However, if the route taken by manufacturers involves the importation of completely knocked down (CKD) units, then certain components will continue to be purchased locally," says Vermooten.

He adds that it is vital that the plan is constantly monitored to determine the impact it is having on the industry to enable government to take remedial action to counter any adverse effects that materialise.

The plan hinges on three strategies to encourage vehicle assemblers to continue to assemble locally. It offers a 27% duty free allowance (DFA) on the wholesale value of vehicles assembled locally; an import/export trade rebate allows the duty free importation of vehicles and components equal to the local content value of the motor vehicles and components exported, and in accordance with the General Agreement on Tariffs and Trade, duties on motor vehicles will be reduced from 65 percent to 40 percent, and on components from 49 percent to 30 percent over a seven-year period.

More affordable cars, PAGE B2



Denzyl Vermooten The new plan for the motor industry should curb the massive car price hikes of the past few years

PHOTOGRAPH: RUTH MOTAU

The tariff wall crumbles

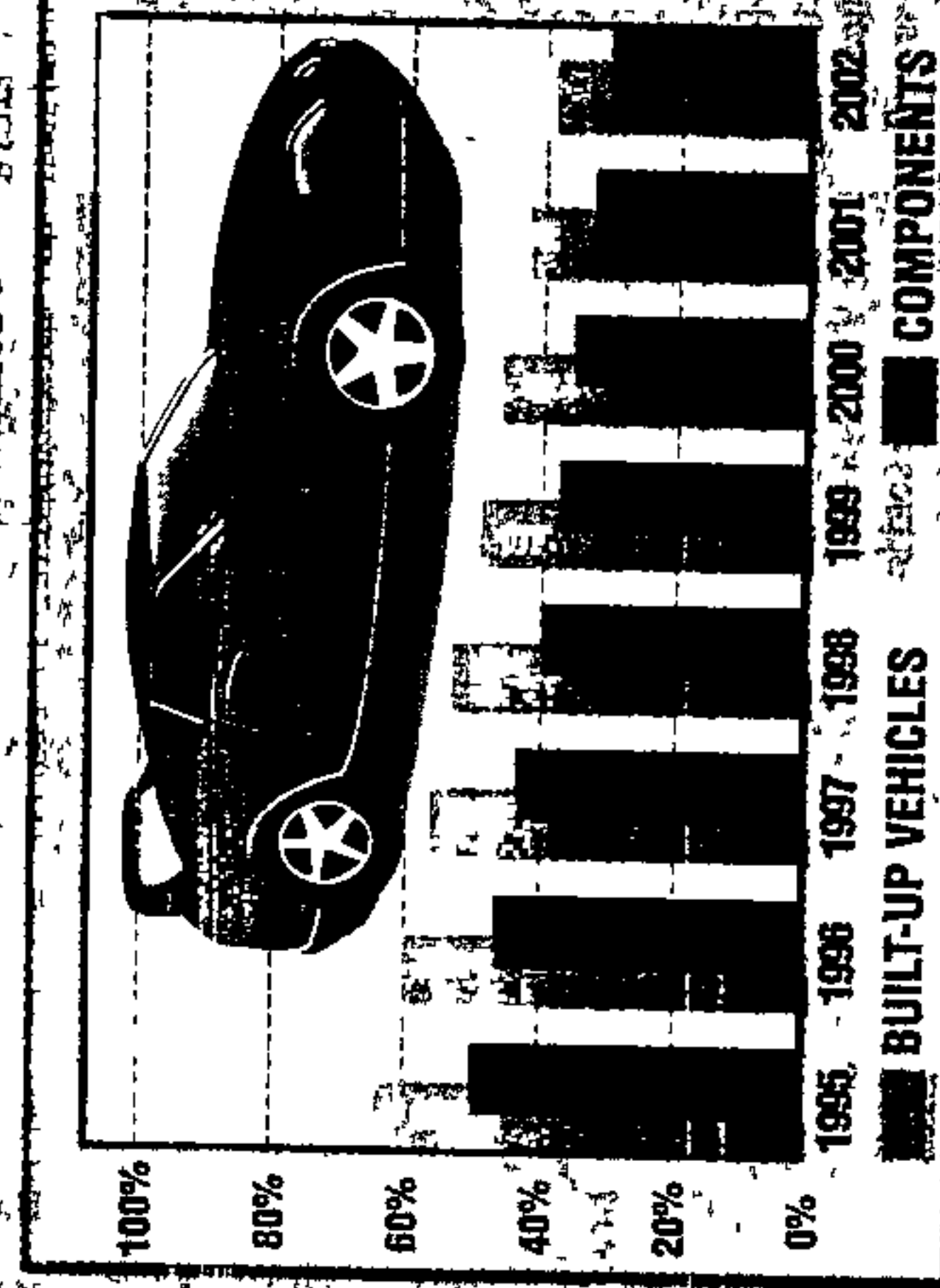

The graph shows how import protection for cars and light commercial vehicles and their components will be gradually phased down

R1,4bn Toyota expansion drive may need some help

ST 16/7/95 (PT) (192)

TOYOTA SA has announced plans to spend more than R1,4-billion in the next five years and has not ruled out a rights issue with possible Japanese participation to finance part of the expenditure

In the past capital expenditure has been funded largely from retained earnings with the dividend cover usually at around 5,5 times allowing a large portion of profits to be ploughed back into the company. With a turnover of almost R5-billion a year, borrowings at December last were a net R500-million, while distributable reserves stood at R959-million.

The ratio of total debt to total assets was an acceptable 42,6%

Announcing the capital programme, Bert Wessels, Toyota SA's chairman and chief executive, said that it might be necessary to raise capital from shareholders and that

By DON ROBERTSON

Toyota Japan might wish to participate in a rights issue

"This, however, will depend on a number of factors and the timing, but we (the family) will always retain control of the company," he says

Of the planned expenditure, R900-million will be for three major new model launches, the first being a new Corolla late next year costing about R300-million

Although the existing model will be replaced, it will remain on the market for years, similar to the ploy adopted by Volkswagen with the Citi Golf

An additional R100-million will be spent each year on upgrading facilities to give the plant world class

manufacturing facilities, while a further R4-million to R5-million, in addition to the current R20-million, will be used in the human resources programme and training

The company expects to be able to export at least one model to First World countries and emerging markets in the East in the next five years and hopes to sell left-hand drive vehicles to countries in Africa in the near future

It is intended to increase exports to between 15% and 20% of production by 2000

Toyota produced 51 586 vehicles in the first six months of the year and plans to increase output to between 450 and 500 units a day for a yearly figure of 110 000 to 115 000. Included in this increase will be a rise in production of the sought-after Venture which will rise from 900 a month to 1 500 a month

Workers want their jobs back

(192) Sowetan 17/7/95

By Josias Charle

HUNDREDS of former Samcor motor plant employees in Pretoria, who were laid off several years ago, are demanding their jobs back.

The former workers believe they were improperly retrenched or pensioned off by the company and are demanding that they be reinstated.

They have also demanded that pensioners, widows and children of former employees of the company should benefit from the more than 187 million US dollars left behind by the Ford Motor Corporation when it disinvested from South Africa more than seven years ago.

The money was to benefit Samcor workers and their beneficiaries. So far, about R63,2-million had been paid out in bonuses and special payments to workers over the last five years.

The ex-workers have clubbed together to form an organisation called "Dissatisfied Ex-employees of Samcor" in a bid to challenge management for reinstatement.

Chairman of the group Mr Abram Kola told *Sowetan* that several meetings had been held with management and marches and demonstrations had been held at the Waltloo plant, outside Mamelodi, east of Pretoria.

Kola alleged that hundreds of people were laid off when the company was apparently going through a tough trading period.

He claimed that this was done in order to deny them the right to enjoy benefits from Ford's investment. He also said that 171 workers dismissed for allegedly being members of a theft ring, were in fact victims of a management plot to get rid of more black staffers.

Kola said the former employees were meeting at least once a week at the Mamelodi Community Hall for reports-back on progress and other matters.

Samcor's Human Resources manager, Mr J Strydom, failed to return *Sowetan's* calls last week and he could not be contacted for comment at the weekend.

ANIES

19/7/95

(192)

R15m expansion a boost to AE Bearings' output

Nicola Jenvey

DURBAN — Engine bearing manufacturer AE Bearings had undergone a R15m capacity expansion programme which would boost output 30%, executive director Leigh Briggs announced yesterday.

The Pinetown-based manufacturer falls under the engine parts division portfolio of T&N Holdings.

Briggs said the expansion programme, which started in January 1993, had been aimed at meeting

increased demand in the export market sector.

The first stage of the project, the installation of a R1m fully automatic plating plant, was completed last month.

Since February this year output had grown more than 15%. The full 30% capacity growth would come into effect next year.

AE had obtained redundant machinery abroad and refurbished it. New machinery would have increased the cost of expansion to more than R25m.

Toyota cuts back supply

Sometan 20/7/95
Demand bearing hard on Toyota while
rival Nissan's sales soar (192)

TOKYO — Japan's biggest automaker, Toyota Motor Corporation, said on Tuesday a steady rise in its overseas production had helped depress its domestic output and exports in the first half of 1995.

Toyota, however, reported a gain in sales at home while its main domestic rival, Nissan Motor Co Ltd, announced increases on all fronts due to brisk sales of its new models including a popular sport-utility vehicle.

Toyota said its domestic production fell by 5,1 percent from a year earlier to 1 678 294 units in the first half while its vehicle exports declined by 16,3 percent to 641 641 units.

Overseas production up

The production cutback was "partly because of a decline in exports resulting from expanding local production," Toyota said in a statement.

On the other hand, Nissan said its domestic output rose by 10,9 percent to 861 670 units, with vehicle exports up by 5,8 percent at 299 024 units. "Exports to the United States, Europe and the Middle East increased," it added.

As for domestic sales, Toyota marked a 1,2 percent rise to 1 056 009 units. Car sales were down by 2,4 percent at 722 449 units but sales of trucks and buses in Japan were up by 10,1 percent at 333 560 units.

Market share down

Toyota took a 30 percent share of the domestic market in the six months, com-

Keen competition at home and abroad

pared with 31,5 percent a year earlier.

Nissan's domestic sales rose by 10,9 percent to 582 128 units, the first year-on-year rise since the first half of 1990. Sales of passenger cars rose by 11,5 percent to 431 446 and those of commercial vehicles 9,2 percent to 150 682 units.

Nissan said its market share for the first half rose by 0,8 percentage points to 22 percent.

Marginal difference

Toyota's overseas production, mainly in Britain and the United States, rose by 24,1 percent to 631 217 units and Nissan's rose by 7,3 percent to 576 312 units.

In June alone, Toyota said its domestic auto production fell by 12,2 percent from a year earlier to 287 536 units and exports fell by 20 percent to 102 657 units.

Domestic sales rose by 1,5 percent to 189 347 units, with car sales rising by 0,3 percent to 127 200 units and those of trucks and buses up by 4,2 percent to 62 147 units.

Toyota attributed the marginal rise to the launch in mid-June of its new Corolla Sprinter sedan models along with strong sales of recreational vehicles.

On the other hand, Nissan said its domestic output in June rose by 9,2 percent to 147 412 units and exports edged up by 0,5 percent to 54 682 units. —Sapa-AFP

Eskom plan for cars

CF 21/7/95

(192) (S)

JOHANNESBURG: Eskom suggested yesterday that free inner city "fill-up" points for electric vehicles would curb pollution.

Environment Minister Dr Dawie de Villiers had recently mooted taxation or penalties for those responsible for urban pollution, Eskom said.

Dr De Villiers felt a road fuel duty and other penalties could lead to faster development of electrical transport and better use of other options for private transport and deliveries.

Eskom's national electric vehicle programme head Mr Carel Snyman said that for several years Eskom had been alerting

the South African public to the environmental and cost benefits of electric transport.

Eskom was also working to help deliver affordable electric vehicles and the appropriate infrastructure.

For example, service stations could sell electric fuel alongside the traditional petrol pump.

A free "electrical fill-up" would cost the government less than combating greenhouse gases. This could also be an effective way to subsidise the taxi industry.

Home-owners could have a "smart-plug" re-charging system.

TOYOTA SA (192)
FM 21/7/95
Eastern promise?

In what may be the first indication of a direct investment by its Japanese supplier, Toyota SA last week announced a R1,4bn five-year capex programme

The move follows the recent signing of a 10-year manufacturing and distribution agreement between the SA company and Toyota Japan. Included in the agreement is an expansion of Toyota's drive into Africa and the manufacture of certain left-hand-drive vehicles for export. Chairman Bert Wessels says "We expect that exports could grow to a point that they account for

between 15% and 20% of our local production by around the year 2000"

Wessels says Japanese participation has not been discussed "at a high level". He adds "There are no firm plans for Japanese participation but it's a possibility one can't discount entirely"

With a dividend cover of five to six times, Toyota SA's traditional policy is to fund from internal reserves, amortisation and depreciation. However, the size of its latest capex programme suggests other options, including Japanese investment, can't be ruled out.

The company will spend R900m launching three new models and R100m a year on its manufacturing facilities over the five-year period. The first launch, targeted for late next year at a cost of R300m, will be a new Corolla. One of the others is likely to be a light delivery vehicle. Toyota also announced a new Conquest derivative, the Zip, which goes into production this week.

Wessels says despite recent market share losses, Toyota won't become involved in the current price war. "We are not convinced the cost and price reductions that are a feature at the bottom end of the market are sustainable and we are mindful of the impact of such desperate moves on vehicle residual values."

But he suggests Toyota might become involved in the rapidly growing entry-level end of the market. He hints at the possibility of a new marque when he comments that "it is a market in which we cannot compete at this stage"

Wessels has reservations, though, about the recently announced motor industry development plan. In particular, he is unhappy that the small vehicle incentive, in the shape of a 2,5% duty-free allowance, will remain for at least three years. The incentive could be better spent, he says, on minibus taxis where commuter needs are more deserving.

A further disappointment, he adds, is the delay in dropping tariff protection on built-up car imports to 65%. The motor industry is subject to long lead times and delays such as this make it difficult to draw up an efficient CBU import plan. Once tariffs drop to 65%, probably in September, Toyota "would be very supportive of a further lowering in January 1996." ■

Car makers collide over incentive programme

ST (BT) 23/7/95 (192)

By DON ROBERTSON

THE decision by the Board on Tariffs and Trade to continue with a small vehicle incentive programme for the next three years has caused discord among motor manufacturers.

Under the programme, which has been in place for a number of years, manufacturers are charged lower excise duties for making cars costing less than R37 500 wholesale.

It is estimated that last year, these incentives cost the fiscus about R205-million.

Toyota, which has no vehicle in the entry-level sector of the market, says it views with concern the continuation of the programme. It suggests that a similar incentive system should rather be made available to the minibus-taxi market, in which it is active.

Bert Wessels, Toyota's chairman and chief executive, says the SVI programme is contrary to the recommendations of all parties to the original development programme shaped two years ago.

He says cheaper prices do not necessarily attract first-time buyers, but rather assist the more wealthy customer to buy a second car.

Nissan, which has been marketing in this sector since the launch of the Fiat Uno more than five years ago, approves of the programme, with marketing director John Jessup commending the aims of the Board on Tariffs and Trade.

Nissan's Uno Fire costs R37 240.

The small car market now represents between 4 000 and 5 000 vehicles a month, says Mr Jessup. Manufacturers have been able to cut prices by as much as 15%.

"The SVI programme is the correct thing to do to stimulate the industry," he says.

Volkswagen, which has benefited from the programme in the past, sparked a price war in the market recently with the introduction of the Citi Golf Chico, which sells for R33 950. More recently Samcor took on Volkswagen with the Ford Tracer and Meteor and the Mazda Midge selling for R34 357.

Delta is expected to produce an entry-level car later this year, reportedly the Corsa, which could also qualify for increased rebates.

Heinrich Holtmann, Volkswagen SA's managing director, says making small cars more popular has been successful in Brazil and Mexico and should be encouraged in South Africa.

"We must ensure that government policy makes quality transport available to more South Africans," says Mr Holtmann.

"The success of the Chico, which in May captured over 14% of the car market, proves that more private buyers will come into the car market if entry level vehicles are well priced."

The SVI programme operates in a complex rebate system in which manufacturers are required to pay a 37,5% excise duty plus a 2,5% non-rebatable duty on the wholesale price of the vehicle, but may claim a 50% rebate of the local content value if they achieve a minimum 50% local content.

In the case of the SVI, they can claim a further 1,5% rebate for every R1 000 they reduce the

price below the R37 500 level, multiplied by the price.

For instance, if a manufacturer reduces the wholesale price of the vehicle to R36 500, he can claim an extra 1,5% or R547 from the fiscus.

There is, however, an offsetting effect in the excise duty formula as a result of the price reduction, which is equivalent to about 10% of the reduction.

The current rebate system will be in effect until September when the proposed new Motor Industry Development Programme will be introduced. Among other aspects, the MIDP will do away with the requirement to have a minimum local content in each vehicle.

The existing system, in which a 50% duty can be claimed on the value of local content, will be replaced by a 49% duty on the value of completely knocked down components imported from source countries. This duty will gradually be reduced to 30% by the year 2002.

At the same time, manufacturers will be able to claim a 27% duty-free allowance on total turnover.

For instance, if a manufacturer has a turnover of R1-billion and imports components worth R400-million, he would be able to claim a duty free allowance of R270-million or 27% of turnover. If this is deducted from imports, it would leave R130-million subject to duty, which, at 49% would amount to R64-million. From this, the SVI, at the same rate as present, could be claimed.

In terms of the MIDP, the R37 500 minimum price will be increased periodically in line with vehicle price inflation to allow the price advantages to be maintained.

Listing makes for flexibility — Nissan

Marcia Klein

BO 24/7/95

THE October listing of motor manufacturer Nissan should enable it to become more flexible, increase its shareholder base and enhance its global competitiveness, says chairman John Newbury

Nissan, manufacturer of Nissan and Uno, which makes its JSE debut towards end-October through holding company Automakers, would become only the second manufacturer — after Toyota — to list

Newbury said he could not release financial details at this stage, but it is believed money would be raised through the listing and that owner Sankorp could hive off about 45% of its share

The few details that are known are that Automakers' sales are about

R3,6bn and that its share of the total vehicle market is about 18,4%

Newbury said the decision to list was driven by many factors. The company had done reasonably well and the listing would provide it with substantial marketing benefits and enable it to be more transparent and visible. It would enable more people to have a share of the company, including employees

"We would have more flexibility to expand our activities into other areas, including component manufacture and export development," Newbury said

Management had for some time been looking at expanding the shareholder base, he said

It seemed unlikely its two supply principals, Nissan Japan and Fiat, would take part in the listing at first

Newbury said he was aware major investors would not be in a hurry until SA was seen as more stable

Commenting on the recent announcement by Trade and Industry Minister Trevor Manuel on the future of the motor industry, Newbury said the programme had addressed "the fundamentals of export, forex preservation and vehicle affordability", and Nissan was happy with that

"With the new programme there is no doubt manufacturers will all look carefully at economies of scale. We will need larger runs of models and will try to complement with a certain element of imports, and need to increase localisation"

But he felt the duty-free allowance on imported components, equal to 27% of the wholesale value of vehicles, was low

(192)

Russian cars to be built in Natal

By DON ROBERTSON

(192) (S)
A RUSSIAN car and motorcycle manufacturer plans to open an assembly plant in Phoenix near Durban. ST (M) 30/7/95

Following a successful visit to Russia and Malaysia earlier this month by Kwazulu-Natal Minister of Economic Affairs and Tourism Jacob Zuma, the Izhmash Joint Stock Company indicated its intention to build the plant.

Two members of the Izhmash group recently opened an office in Durban to assess the project, but have since returned to Russia to advise the board of directors.

A spokesman for Mr Zuma says the intention of Izhmash is to begin production of motorcycles and, later, cars.

She says although the investment would be welcomed, no further details of the project are available.

Mr Zuma's two-week overseas trip will be followed later next month by a visit by the Prime Minister of Malaysia, accompanied by 200 business executives as well as Russian bankers.

The main interest for Malaysian businessmen in Durban is the Point Development and the International Convention Centre. They are also interested in developing small and medium-sized enterprises.

Nissan set to list on JSE in October

Marcia Klein (192) BO 2/6/95

VEHICLE manufacturer Nissan SA would list on the JSE in October through its holding company Automakers, it announced yesterday

The Sankorp-owned company is SA's second largest motor company with an 18,4% market share and turnover of R3,6bn. It manufactures and distributes Nissan passenger and light commercial vehicles, Nissan diesel trucks and Fiat products, notably Uno.

The listing would be in line with the unbundling of Sankorp, and would enable Nissan to raise money and open the way for Nissan Japan to invest in the SA company. No details have been given, but it is clear it would raise money through the listing.

A spokesman said the company, which has a June year-end, would issue a prospectus in August and hoped to list in mid-October.

Automakers chairman Marinus Daling

said details would be determined once the content of the motor industry development programme was established and its implications had been studied.

"The proposed listing follows the re-organisation, unbundling and black economic empowerment initiatives implemented during the past few years in the Sankorp group." He said Sankorp's share could be reduced over time.

Automakers CE John Newbury said the listing would give Automakers "capital funding flexibility for long-term development such as dealer network expansion and maximisation of export potential".

It could use shares to finance opportunities in SA and international markets.

"Listing will also make it easier for future investment in Automakers by its international associates."

Market sources said the listing would be welcomed, and would provide some choice to shareholders in the motoring sector, where Toyota is currently the only listed manufacturer.

MOTOR INDUSTRY
Rank outsiders

(192)
 AM 2/6/95

Should consumers be allowed to learn from the experience of others when deciding which new vehicle to buy? If comparative research is available showing how different cars shape up in the eyes of those who have already bought them, shouldn't it be made available to others about to spend a small — often large — fortune following in their footsteps?

Yes, say most of the major motor industries worldwide. No, say SA vehicle manufacturers.

Although detailed statistics are published regularly in the US, Europe and elsewhere revealing what owners think of their vehicles — and of the sales and service experience that accompanies them — some SA motor companies remain adamant they don't want the same information published here. The information is available — but only to the companies.

Industry-commissioned research, called the Customer Satisfaction Index (CSI), is collated regularly to inform manufacturers, and some importers, how they, their dealers and vehicles all shape up in the public eye in comparison to competitors. But that's as far as it goes.

In other countries, by contrast, the public is informed regularly of the results. In the US, for example, the JD Power market research group publishes the results of

Consumers pay so much attention to the rankings that companies are forced to lay great store in being among the best.

The JD Power rankings list, in order and with scores, all those finishing above the industry average. Those below are listed alphabetically, with no reference to their score. Company analysts justify this lower-order anonymity by saying a simple below-average score is not necessarily an indication of failure. Rankings have had such an impact on customer satisfaction that the industry average is higher than the top score of 10 years ago.

And, interestingly, it is imported Japanese luxury models that have had the biggest single recent impact on the rankings. In particular, the high scoring of the Toyota Lexus has forced other companies to work even harder to narrow the gap and pull up the average.

So why shouldn't SA vehicle manufacturers and importers be subjected to the same competitive pressures? Because some of them don't want to be. The SA motor industry uses a Johannesburg company, the Centre for Proactive Marketing Research, to carry out the same sort of research among buyers as in the US. The centre then distributes results to companies.

While some say they would be happy for those results to be made public, others insist they remain confidential. And because the centre relies on all companies to provide it with customers' names and addresses for its research, it dare not publicise findings. If even one company were to withhold names,

say researchers, the whole comparative process would be put in jeopardy.

Predictably, it is chiefly those whose products don't perform so well, that oppose openness. Still, there is a move within the industry to persuade them to change their minds. According to one MD, there is a strong pressure group inside the industry's representative body, the National Association of Automobile Manufacturers (Naamsa), to approve open publica-

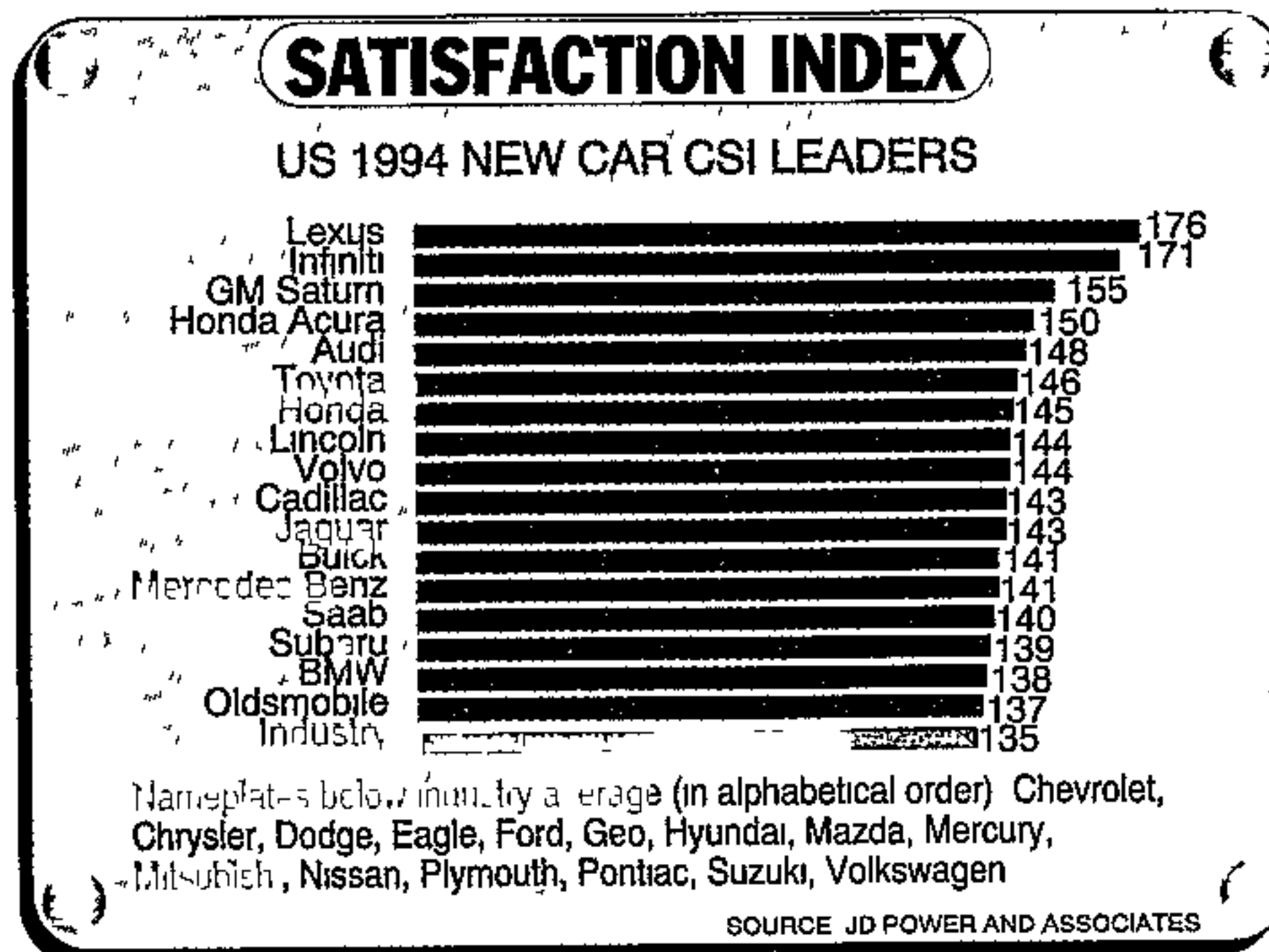

nationwide research into every model — local and imported — on the market.

Its information is based on questionnaires completed by owners of those vehicles. Among the issues they rate are the purchase experience with the dealer, vehicle quality, frequency of problems, and after-sales service including how good dealers are at fixing faults first time.

Companies may not always like the findings, but there is no doubt that they have helped lift the general level of quality and service in the US motor industry.

tion. He thinks it a matter of time before that happens, but only after a fight.

He says "It's not as if anyone has something to be ashamed of. All SA companies have put major resources into improving their products and their dealers. The improvements are there to be seen. And at the end of the day it's the consumer who benefits." Another senior industry figure notes "The trend worldwide is towards greater transparency. We in SA are still some way behind and we must catch up. It's in everyone's interests."

Automakers plans JSE listing this year

(192) CT(BR) 2/16/95

By JOHN SPIRA

GAUTENG BUSINESS EDITOR

Sankorp-owned Automakers, the holding company of Nissan SA, plans to list on the Johannesburg Stock Exchange later this year.

The move is bound to generate intense interest because

- The share issue which precedes the listing is likely to witness the first-time equity participation in the group of its foreign associates — Nissan Motor Company and Nissan Diesel of Japan, and Fiat Auto of Italy

- The share issue will be of fairly substantial dimensions, since Automakers' annual turnover runs at R3,6 billion. It is South Africa's second-largest motor company with an 18,4 percent share of the total market

- Shares will be offered to the public

- One motor manufacturer — Toyota SA — is listed. Toyota currently trades on a dividend yield of 2,2 percent and a price-earnings multiple of 8,4 — fundamentals which will probably accord closely with the price at which

Automakers' shares are pitched. Although Automakers' profit history is not known at this stage, the company's recent track record is bound to be impressive.

From 1990 to date, its share of the country's small hatch market has grown from 14,6 to 20,3 percent, of the small sedan market from 11,2 to 21,1 percent, and of the executive luxury market from 3,5 to 9 percent. And its share of the biggest component (the one-tonner) of the light commercial vehicle market has expanded from 16 percent to 20,3 percent over the past six years.

Stephanus Loubser, managing director of Nissan SA, believes his group is the country's second most profitable motor manufacturer.

Marinus Daling, chairman of Automakers, says the timing of the listing will be determined once the contract of the Motor Industry Development Programme has been established and its implications and impact on the motor industry have been studied.

"The proposed listing," Daling says, "follows the reorganisation, unbundling and black economic

empowerment initiatives implemented in the Sankorp group during the past few years — initiatives which could in time progressively reduce Sankorp's shareholding in Automakers in line with its general approach to holdings in its associated companies listed on the JSE."

John Newbury, Automakers' chief executive, says a JSE listing will give the group capital funding flexibility for long term development such as dealer network expansion and maximisation of export potential.

"Automakers will benefit through the use of shares to finance opportunities in both the local and international markets.

"The company is already investigating various possibilities in this regard. Listing will also make it easier for future investment in Automakers by its international associates.

"By being a public company, Automakers will also be able to offer institutional investors, the public and all other stakeholders the opportunity to participate in Automakers' continued growth and success."



BUBBLING OVER John Newbury, the chief executive of Automakers, toasts the news of their listing plans later this year. Automakers is the holding company of Nissan SA.

PHOTO JOHN WOODROOF

Robots lose priority at Toyota

(192)

ST(BT)
4/6/95

IN an effort to cut costs and counter the crippling impact of the soaring yen, Japanese motor giant Toyota is increasingly using labour rather than robots for production

The policy was adopted by Toyota SA when it introduced the Camry. While the Camry heralded a new era in body-shop technology and robotics, automation is now used in selected areas only

By DON ROBERTSON

"Our policy with the Camry, and one we will follow on all our new models in the foreseeable future, is that we will use robotics only for dirty work, heavy work or dangerous work," says Ralph Broadley, Toyota Manufacturing's managing director.

According to the British magazine The Economist, the rest of Toyota and the

world's car industry are watching the production of the multipurpose four-wheel drive RAV4 at Toyota City in Japan with interest

The company's Toyota Production System, which includes just-in-time, total quality management and continuous improvement, sparked a production revolution. It was internationally recognised as the "machine that changed the world"

Today, however, Toyota is pushing ahead towards a system which, rather than replace workers with machines, uses machines only to do work that make life easier for employees

Automation has been cut at this section of the plant by 66%, with an enormous cost saving. Defects on the RAV4 have fallen to 12% of the production method using automation. Productivity has risen by a fifth

It has also made a significant impact on the bottom line, despite Japan's high labour costs

In the six months to December, Toyota reported operating profits of almost \$1-billion compared with just more than \$100-million in the previous half, on an increase in turnover of just 2.1%. Of this profit increase, \$220-million represented cost savings through factory improvements such as that on the RAV4 line

In the annual report for the year to June, the directors say "We got carried away with automation a few years ago. We were trying to cope with the trend towards shorter working hours

"But we automated some work that we now realise can be done easily and far more economically by hand. Now we are achieving huge cost savings — and shorter working hours — by striking an intelligent balance between manual and automated work"

In Toyota's local production, the company is sometimes forced to use robotics where a weld point is difficult to do by hand

"But at our levels of production, you cannot cost justify the extensive use of robots," says Mr Broadley

"We rather look at all the operations that can be done on a more cost-effective, semi-automated welding basis. This we do by means of 'nagara' or 'home grown' machines and we have become quite expert at designing and building them

Nissan's long road to market

ST(BT) 4/6/95

(192)

By DON ROBERTSON

THE achievement of long-term growth targets set by Sanlam when it took control of Nissan SA in 1984 and the unbundling programme adopted by parent company Sankorp have laid the foundation for the October listing of the motor manufacturing group.

A prospectus will be issued in August, after the June financial year-end, prior to the listing of Automakers, the Sankorp-owned holding company of Nissan.

When Sanlam gained control of Nissan through the purchase of the Messina group, turnover was R570-million. Five years later, increased sales took turnover to R1,8-billion, although this was partly due to

vehicle price increases. The forecast for the current financial year is R3,6-billion, making it the second largest motor group behind Toyota's R4,9-billion in sales.

In 1985, Nissan had a total market share of 9%. This has since increased to 18,4%.

John Newbury, Automakers' chief executive, says the listing will provide capital funding for long term development of the dealer network and to maximise export potential.

"Automakers will benefit through the use of shares to finance opportunities in both the local and interna-

tional markets. The company is already investigating various possibilities in this regard. The listing will also make it easier for future investment in Automakers by its international associates — Nissan Japan and Fiat Auto."

The possibility of Nissan Japan taking a stake in the SA group might, however, be a long way off. The Japanese group suffered substantial losses with its Mexican operation after the currency devaluation and was forced to close an assembly line. This might make it wary of investing in a developing country, although an indirect holding through the stock market might not be viewed as being similar.

New car sales surge 41.7%⁽¹⁹²⁾

By Roy Cokayne
PRETORIA BUSINESS EDITOR

New vehicle sales in May bounced back impressively from the slump in April to record major gains in all sectors — and provide concrete evidence the economic upturn is still intact

The latest year-on-year vehicle sales figures rose 41,7 percent. This provided evidence of the accelerating boom in the South African economy, said Ed Hern Rudolph, strategic economist Nick Barnardt.

Any impression people may have got from the 1,5 percent first quarter GDP (gross domestic product) figure of an economic slowdown is misleading

The boom is continuing and the economy is still in an upswing phase which should accelerate into next year, he said.

But Barnardt warned that the more figures were released indicating increased spending and therefore bank credit extension, the greater the likelihood of another Bank rate hike

Consultancy Econometrix said the vehicle sales for May were amazingly strong bearing in mind the increasing incidence of vehicle imports that did not form part of the National Association of Automobile Manufacturers of South Africa's (Naamsa) figures and reflected the ongoing strength of certain economic indicators

The latest vehicle sales figures

prompted Toyota South Africa group marketing director Johan van Zyl to describe the overall prospects for the motor industry as the brightest they have been for many years

However, he tempered this optimism with a warning about future price increases

There are factors that could inhibit sales in the latter part of the year. A lot will depend on the ability of the industry to cope with price increases driven by a substantial depreciation in the rand in the early part of the year

Up to now the industry has exercised restraint in pricing but there will have to be adjustments sooner rather than later

Figures released by Naamsa revealed that new car sales in May this year rose 41,7 percent or 6 004 units to 20 398 compared to the 14 394 unit sales recorded in May last year. They also rose 29,5 percent or 4 651 units compared to sales of 15 747 units in April this year

New light commercial vehicles, bakkies and minibuses sales rose 43,5 percent to 11 405 units in May this year compared with the 7 947 unit sales in May last year. They gained 2 426 units or 27 percent compared with April's sales of 8 979 units

Sales of vehicles in the low volume medium and heavy commercial vehicle segments of the market recorded slightly smaller gains during May this year

Car sales

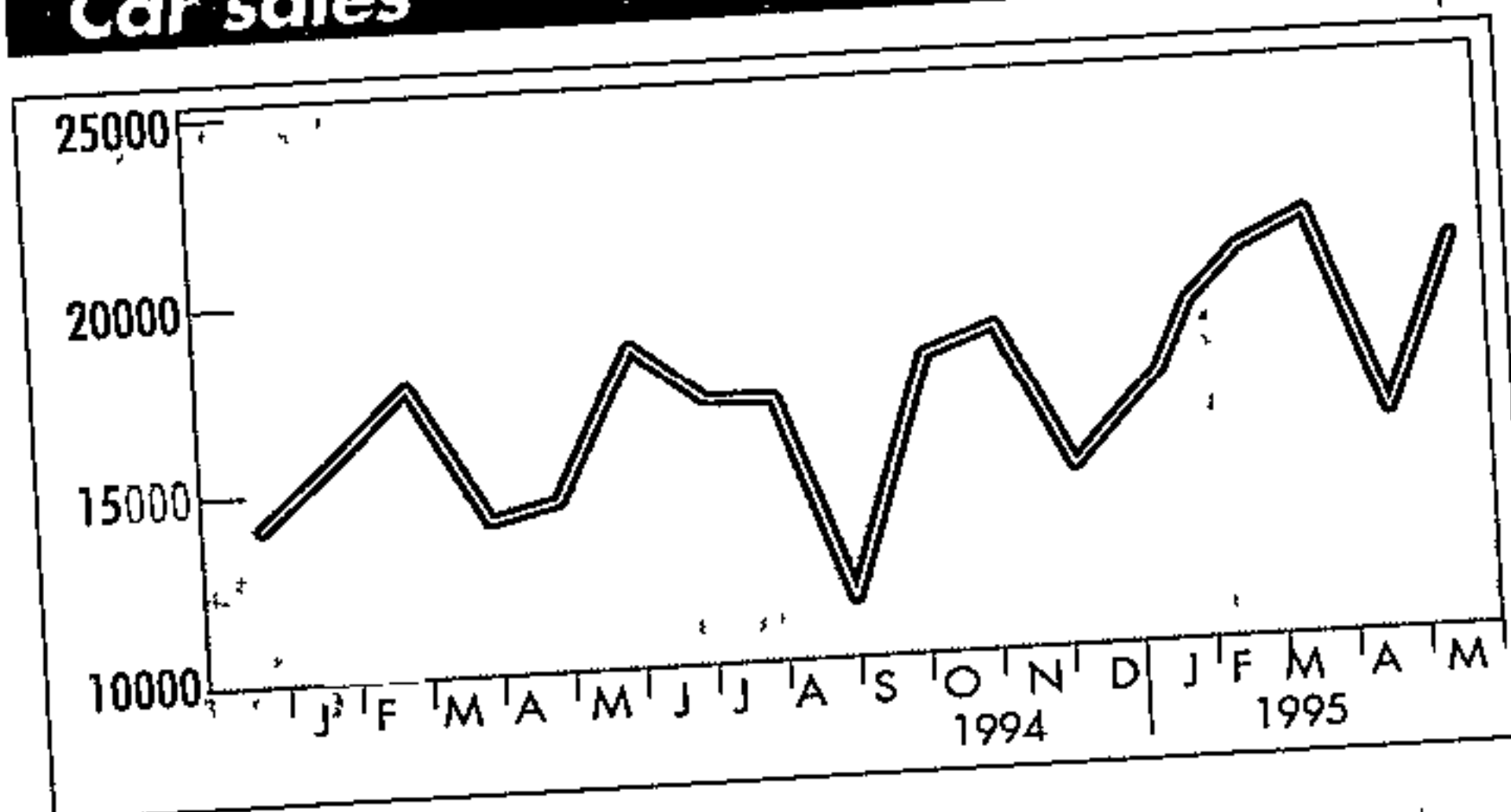

VW holds top sales slot

HENRI du PLESSIS
Motoring Reporter

VOLKSWAGEN's cheapest "people's car", the CitiGolf Chico, helped the company to the top-seller slot in May for the second successive month

Volkswagen has twice unseated Toyota as the top seller in the passenger car market and increased its monthly market share by more than a percentage point

May's sales were Volkswagen's highest in the passenger car market with a share of 25,9 percent, compared with April's 24,1 percent

This gave Volkswagen the lead for the first five months of the year, by a slim margin of 0,2 percent over Toyota.

Volkswagen sold 5 274 units in May compared with 3 796 in April and if the market continued to grow at the same rate, sales for the year could exceed 240 000, marketing director Graham Hardy said

The CitiGolf range achieved a new sales record of 2 948 units with a market share on its own of 14,4 percent, proving that affordabi-

lity was the issue that had to be addressed, Mr Hardy said

The sector still showing the greatest growth was the light commercial vehicle market with a growth of 43,5 percent.

The greatest growth in this sector was in one-ton pickups, while the sale of minibuses and panelvans showed a decline, industry sources said.

Minibuses and panelvans were heavily targeted by car thieves and hijackers, while the taxi industry did not replace vehicles regularly because of unique financial constraints on the industry, they said.

Toyota's pick-up lead had been clipped somewhat by their traditional opposition, Nissan and Isuzu, as well as new entrants to the market, the sources said.

Vehicle sales figures released by the National Association of Automobile Manufacturers of South Africa do not reflect sales of a growing range of new imported vehicles reaching the market, and the sales figures of large-scale entrant Hyundai.

(192) ARG 8/6/95

Car sales zoom upwards

W.M. (M) 9-14/6/95 (192)

CAR sales hit new highs in May — and Volkswagen South Africa (VWSA) pushed aside previous market leader Toyota to take the lead in the passenger car market.

New car sales of around 20 000 were 42 percent up on May last year, and almost 30 percent higher than April's figure, according to figures released by the National Association of Automobile Manufacturers of South Africa.

Eastern Cape News Agency's Shadley Nash reports from Port Elizabeth that sales of the new Citi Golf Chico, at the lower end of the vehicle market, VWSA's overall sales last month to 5 274 cars, pushing the

company to a market share of 25,9 percent.

Company marketing director Graham Hardy said "There is clearly a huge pent-up demand from potential buyers — who include thousands of emergent entrepreneurs — and the launch of the Chico is growing the market."

VWSA said the positive performance by the company was in line with the confident predictions made by new managing director Heinrich Holtman. He had given clear pointers on the need to reduce vehicle prices in real terms for the local industry to survive and grow.

In Johannesburg, Toyota marketing director Johan van Zyl agrees

that price is a determining factor, reports Reg Rumney.

"The ability of the motor industry to curb the affordability crisis will determine the overall size of the market," says Van Zyl. But, he points out, price is related to the foreign exchange value of the rand. Despite a "local content" programme, a significant number of the components of locally produced motor vehicles are still imported.

Toyota was hit by the strength of the yen against the rand, he says. From the beginning of the year the yen has strengthened against the rand by 20 percent.

Van Zyl is not perturbed that Toyota has been overtaken in the passenger car market. "We have set ourselves a strategic objective to sell 100 000 vehicles. We have done that only once, in 1984."

Whether Toyota achieves that will depend on a number of factors in the second half of the year, including interest rate movements and vehicle price increases. But he notes that business confidence is still high, and this will be a much better year than last year.

Vehicle sales are themselves an economic indicator. Van Zyl points out the passenger car market was boosted by higher-than-usual purchases by car rental companies, and so it is not an accurate reflection of light commercial vehicles.

Sales of light commercial vehicles are a reflection of the basic business cycle, and these were strong. Sales of light commercials, bakkies and minibuses were 44 percent up on May 1994.

Motor programme delays 'severely damage industry'

By JOHN SPIRA

GAUTENG BUSINESS EDITOR

Delays in implementing the motor industry development programme are severely damaging one of the most vital sectors of the South African economy.

The delay is damaging the motor industry's ability to export and it is placing in jeopardy the proposed JSE listing of Automakers, controlling company of Nissan South Africa, says John Newbury, the company's executive chairman and president of the National Automobile Manufacturers of South Africa.

A frustrated Newbury told

Business Report: "We've been talking about the motor industry development programme for two and a half years. The new programme was meant to be in by July 1. Here we are on June 8 and we still don't know where we are."

"I have a meeting with trade and industry minister Trevor Manuel on Monday, where I hope he'll move towards finality and not persist with talks about talks. We cannot continue to plan in the dark. We have capital expenditure and other projects on hold. We cannot be expected to proceed with these on the basis of assumptions."

Newbury is adamant that

Automakers cannot go ahead with its JSE listing unless certainty over the industry's future is apparent.

"We can't ask investors to buy shares in this company if motor manufacturing is not going to be possible in the years that lie ahead."

At the same time, Newbury is fairly confident that clarity on the programme will be forthcoming in the next six weeks.

What recommendations does he see ultimately coming through?

"The fundamentals of the programme — affordability and export complementation — are likely to be included. If the authorities keep within the broad framework of the recom-

mendations made by all the participants in the programme, it will be acceptable, though will not please everyone.

"It is the minister's job to make the decisions. We sat for two and a half years. Now it's time for action. Whatever his decisions, at least we'll know where we're going."

What will the programme mean for the man in the street?

"We are signatories to Gatt. If the programme goes ahead as I see it, and protection gradually comes down in accordance with Gatt (to around 50 percent in the next few years), the manufacturers will have to aggressively address the issue of affordability."

Copyright © 1992 by John Spira. All rights reserved. Printed in South Africa.

Battery makers in step on prices

By DON ROBERTSON

ST (R) 11/6/95

(192)

BATTERY makers this week deemed operating as a cartel despite simultaneously raising prices to take advantage of a change in the pricing mechanism.

For the past decade, a lead surcharge was added to battery prices, but from June 1 the amount has been incorporated into the wholesale price.

The surcharge was introduced in 1985 and was administered by the then Transvaal Chamber of Industry. It was set at a LME lead price equivalent of R650 a ton. For each R50 price increase, the sur-

charge rose by 50c.

"In the late 1980s, the SA Battery Manufacturers Association (Sabma) approached the Competition Board and was given permission to continue with this practice," says Louis Laubscher, managing director of First National Battery.

With lead trading on LME at around R2 200 at present, the surcharge has been as high as R20 on small batteries, or a 15% increase

Imports, which do not have a lead surcharge, are, however, rapidly increasing and it was decided to price our batteries in the same way other countries do, by adding the surcharge to the wholesale price, says Mr Laubscher.

The cost of other raw materials such as plastics and recent wage increases have, however, impacted on manufacturers such as First National, Willards and Sabat, and all increased recommended retail prices a week ago by between 3% and 12%, in addition to the surcharge.

Sakkie Filmalter, Willard's managing director, says imports are about 3% of the 3-million annual battery market and he expects this to rise to 5% by year-end.

The lead surcharge was published monthly and added to the retail price allowing for quick changes depending on lead price LME movements. It is doubtful, however, whether price adjustments will now be made as quickly, although Mr Filmalter insists that if the lead price falls market forces will ensure local industry meets these prices.

Car industry deal

(192)
JOHANNESBURG — The National Union of Metal Workers of South Africa and the Automobile Manufacturers' Employers' Organisation have in principle reached agreement on a three-year deal on working conditions. The deal covers wage policy, wage rates and human resources development strategies. **ARG 12/6/95**

COMPANIES

Curnow geared up to capitalise

Yuri Thumbra

(192) 2013/6/19
AUTOMOTIVE consumables supplier Curnow was positioned to capitalise on the improving economy and trading conditions now that new management and infrastructure were in place, chairman Peter Brunnschweiler said in the annual report.

He said the company would enjoy competitive advantages during the current year from new product introductions.

The review period had brought particularly difficult trading and operating conditions, arising from the effects of the strike in the motor industry and the company's continuing process of assimilating its acquisition of the Harveys Equipment Group.

Brunnschweiler said the latter process, which included the rationalisation of product lines and ranges, sales outlets, personnel, systems and management control, was now complete and the company was ready to participate in the opportunities pre-

sented by improved trading conditions. The period under review covered 13 trading months as a result of Curnow changing its year-end from December 31 to January 31 to conform with that of its parent, the Elzet group.

Sales rose 18%, mainly due to the inclusion of the sales of Harveys Equipment Group, and to improved gross margins from better stock controls and enhanced product mixes.

Net income improved to R652 000 (R431 000), but operating income at R1,9m was 2,7% of sales. Brunnschweiler said this was due mainly to the costs of rationalisation and other non-recurring expenses associated with the business combination with Harveys Equipment Group.

He noted that the company's interest burden increased 32% on an annualised basis over the previous period due to greater capital requirements.

Cheaper cars

'not likely'

(192)
CT(BR)13/6/95

BY DEREK TOMMEY

Don't expect much in the short-term in the way of cheaper cars, or a more competitive motor manufacturing industry, as a result of the government's new tariff structure announced last night

This is the view of Brand Pretorius, executive chairman of McCarthy Motor Holdings, which is the country's biggest motor dealer, and former marketing director at Toyota

But he said last night that on the positive side, employment levels in the motor industry should not suffer much which, in view of the high level of employment in South Africa, made the new programme acceptable. The motor industry was still the second largest employer in the manufacturing sector after the food industry

The new tariff structure was an acceptable compromise to all parties. But it would not necessarily make the local manufacturing industry world class or necessarily make vehicles cheaper

Manuel moves to slash tariffs

SPAN 12/16/98 (192)

■ BY BRUCE CAMERON

Motor car prices are expected to come down in the wake of the fundamental restructuring programmes for the clothing, textile and motor vehicle industries unwrapped by Trade and Industry Minister Trevor Manuel yesterday.

The programme focuses on major reductions in tariff protection barriers and the scrapping of local content requirements for the motor industry.

Manuel's pronouncements follow months of controversy and lobbying with fears raised that all three of the industries could be significantly damaged by the removal of the tariff barriers put in place during the sanctions era.

CAR prices are expected to come down with the introduction of new measures

In the motor industry the local content programme is to be dropped and a new system of "reduced and tradable" duties is to be introduced.

In the process, the range of motor vehicles assembled locally is likely to reduce and prices are expected to drop.

In the clothing and textile industries, Manuel has opted for a compromise between demands for a ten-year phasing out of tariffs — demanded by

the textile industry — and five years on textiles — as wanted by the clothing industry.

In all three industries Manuel is hoping that measures taken will improve competitiveness.

In the clothing and textile industries he has taken measures to improve management, technology and training to make them internationally more competitive.

Phased

Manuel said there would be phased reductions in the textile and clothing industries over eight years for ad valorem rates and over four years for specific duties, with a possible one year extension.

The decreases would be at a

minimum rate of 10% a year. All rebates would be phased out over ten years.

In the motor industry the whole structure of excise duties and rebates is to be scrapped and replaced by customs duties and tax free allowances.

In terms of the new scheme, the current excise duties of 100% plus a 15% surcharge on built-up motor vehicles, with a mass of not more than 3 500 kg, will be changed to a customs duty of 65%, including the surcharge, almost immediately. In turn this would be reduced to 40% over eight years.

Duties on components will be reduced to 49% almost immediately with a target of 30% within eight years.

To protect the local industry

motor vehicle manufacturers will be granted a 27% duty-free allowance for components based on the wholesale value of a motor vehicle.

Manufacturers will get further rebates if they export components or vehicles. For every one rand they earn in exports they will receive a one rand import credit. Manufacturers will be able to use the credits to import built-up vehicles or parts.

This could mean that manufacturers could stop assembling some models while exporting more of another.

Manuel said the changes would also comply with the requirements of the General Agreement on Tariffs and Trade.

'Simplification' the aim

■ BY BRUCE CAMERON

The Government intends to steer the motor industry onto a new track, which will give motorists a greater choice of vehicles, expand the manufacturing base of the industry and create a trade balance between imports and exports in the industry.

In the revised phase six proposals of the Board of Tariffs and Trade unveiled by Trevor Manuel, the Minister of Trade and Industry, recommendations are made for the phased reduction of Tariffs on imported parts and assembled motor vehicles, which will result in lower prices.

A tripartite task group, representing the Department of Trade and Industry, labour and manufacturers, has been appointed to finalise the proposals with an agreed September 1 date for implementation. The task group has been instructed to report back by July (192)

Manuel said at a media conference last night the recommendations amounted to a "substantial change" which would result in a simplification of the approach in dealing with the motor industry.

The programme would also bring the light and heavy vehicle industries closer together.

Star 13/6/95

No big surprises in import duties cuts

(192)

01/13/16/95

**Marcia Klein
and Edward West**

THE Board on Tariffs and Trade proposals for the local motor industry have been cautiously welcomed.

Sources said the board had simplified its earlier proposals, making them easier to follow and less open to manipulation.

The proposals were in line with expectations and not that dissimilar to what was gazetted last year. There was a strong focus on exports and competitiveness.

Sources said the scaling down of import duties on fully built up vehicles from 65% to 40% and components from 49% to 30% were the same as those proposed last year and were in line with expectations, although the Motor Industry Task Group had asked for 45% for built up vehicles.

A spokesman for the National Association of Automobile Manufacturers of SA (Naamsa) said yesterday it was

unlikely any programme would satisfy all players in the industry, but the proposals had attempted to reach a "balanced compromise" between all sectors of the industry

A spokesman for the National Association of Automotive and Allied Manufacturers (Naacam) said a major issue which had not been addressed by the board was a mechanism to ensure the rationalisation of models.

Naacam executive director Denzyl Vermooten said SA's relatively large range of locally manufactured vehicle models had resulted in inefficiency and higher costs.

A positive aspect to the proposals was the duty free allowance for motor manufacturers, which had been reduced to 27% from the 35% that was gazetted in December. "The 35% would have annihilated our industry," said Vermooten.

Motor vehicle manufacturers, component manufacturers and trade unions would meet in working groups until the end of

next month to discuss the proposals, so that the programme's September 1 1995 implementation date could be achieved, he said. "We have been talking about this for two and half years. We can run with it now"

Delta Motor MD Willie van Wyk said the challenge to the SA industry was clear — "compete or disappear"

The National Union of Metalworkers of SA (Numsa) said its initial impression was "that it lacks the interventionist approach we felt was necessary for a long-term programme in this industry"

Numsa said that to build a viable export oriented industry "would require more than simply reducing the protection afforded to the industry"

"The lack of more clear signals with regard to model numbers and policing of the programme leaves that modern economic miracle 'market forces' to carry out the restructuring of the industry"

Marcia Klein

TRADE and Industry Minister Trevor Manuel yesterday released proposals for the motor industry aimed at putting motor vehicle assembly and components manufacturing industries on an internationally competitive path

The plan, which has a strong emphasis on encouraging exports, foresees the motor industry moving away from excise duties and rebates on excise duties to becoming driven by customs duties

Motor vehicle manufacturers would get a 27% duty free allowance — down from the 35% suggested by the last Board of Tariffs and Trade proposal. As expected, import duties on fully built up vehicles and components would be scaled down, the definition of completely knocked down vehicles was clarified, there would be no minimum local content, and vehicle and component manufacturers were re-

Plans put motor industry on a competitive road

(192)
2013/6/95

quired to register with the board

In yesterday's proposal document, the board recommended excise duties and rebates be replaced by customs duties and duty free allowances

It recommended the customs duty on built-up cars, commercial vehicles and minibuses be brought down to 40% in 2002 from 65% this year, and components to 30% from 49%

Imported vehicles in a condition other than completely knocked down would be liable to the same duty as completely built up vehicles

The ratio of duty on built up vehicles to duty on com-

ponents was 1,331 and duties would be scaled down on a straight line basis

Original equipment components would be exempt from the payment of surcharges, and items like raw materials and parts would be liable to the normal customs duty and surcharge which were currently applicable

The board said all components used for the assembly of vehicles "cannot be sourced economically from local sources" In this light, importation of a portion of components should be allowed free of duty. This would not only contain costs of vehicles but would contribute towards balancing trade

Duty free imports would take place through a duty free allowance based on the value of the vehicles manufactured and an import/ex-

port trade balance rebate

The board said motor vehicle manufacturers would be entitled to a 27% duty free allowance, based on the wholesale value of vehicles manufactured. Excess duty free allowance could be used to import completely built up vehicles at a reduced duty

The import/export trade balance rebate would enable the duty free importation of vehicles and components equal to the local content value of the motor vehicles and components exported

The import duty on completely built up vehicles could be offset by import rebate credits derived from the export of vehicle components. The import duty on components could be offset by import rebate credits derived from the export of vehicles or components

The board tightened up its definition of completely knocked down units, a definition which had led to the entry of Hyundai into the market. These companies would be given a period of grace until June 30 1997

The board recommended a mid-term review to see if the programme objectives have been met

Promise of cheaper cars and clothes

(192)

Bold plan to slash tariffs

Tim Cohen

CAPE TOWN — Trade and Industry Minister Trevor Manuel yesterday unveiled final proposals for dramatic reform of the motor, textile and clothing industries designed to compel SA industry to become internationally competitive.

The proposals came after years of intensive negotiations and countless deadlocks over the way in which SA would get rid of its protective walls.

The plans will ultimately result in significantly cheaper cars and clothes, with the proposed phased tariff reductions to under half their current levels, outstripping SA's GATT offer in all sectors.

Clothing and textile industry representatives were yesterday given a month to comment on the reports while a new committee was set up to discuss the motor industry proposals.

After a briefing of senior representatives from both industries yesterday, Trade and Industry Minister Trevor Manuel said there was broad agreement on the architecture of the proposals. "Surprisingly, there was no blood on the carpet."

It was agreed by motor industry representatives that September 1 would be the outside date for implementation. In the meantime, a task group with three representatives from government, the trade unions and both the vehicle and component manufacturers would be set up.

Manuel said the task group would "flesh out the proposals as they stand now", with an interim report required on July 1. Manuel indicated his support for the current set of proposals saying: "We have workable proposals that we can go with."

The Board on Tariffs and Trade's motor industry proposal differs little from its proposals last year, except that the duty

free allowance offered to manufacturers on components has been reduced from 35% to 27% of the value of the parts involved.

The motor industry proposals suggest abandoning the local content system driven by excise duties — and its replacement with a programme driven by steadily reducing customs duties, offering duty free allowances and an import/export trade balance rebate.

Import duty on built-up motor cars, commercial vehicles and minibuses would shrink from a planned 65% this year to 40% by 2002 by roughly four percentage points every year, while import duty for components would decrease from 49% this year to 30% in eight years. SA committed

● For more details and reaction to the reforms, see Page 4

itself in its GATT offer to reduce import duty on motor vehicles from 100% to 50% within eight years.

To facilitate international trade, motor vehicle manufacturers would be entitled to a 27% duty free allowance on all parts to be used as original equipment for motor vehicles.

The plan aims at rationalising the number of models over the longer term. Proposals for a new textile and clothing industry tariff structure suggest that ad valorem rates would be phased down over eight years and specific duties phased down over four years with a possible one-year extension. This compares to the 12-year period envisaged in SA's GATT offer.

Rate reductions for clothing would be reduced from 90% to 49%, for household textiles from 55% to 30%, for fabrics from 45% to 22%, for yarn from 32% to 15% and



● MANUEL

polyester fibre from 25% to 7.5%

Some relief would be offered with a 50% subsidy on management consultancy fees for five years and the continuance of the duty credit certificate scheme, which gives exporters relief on import duties. Manuel said new conditions on training, productivity increases and human resource development would apply.

Manuel indicated he did not concur with the Swart Panel Report's suggestion for support to be provided for the capitalisation of new technology because it was probably not necessary.

He was concerned about "leakage" in the clothing sector at customs posts, and discussions were taking place with the finance department.

On balance of payments problems that might arise from the deep tariff reductions, Trade and Industry director-general Zaverah Rustomjee said the whole system was designed to be net BOP positive. Given SA's latent competitive advantages in its engineering industry, there were possibilities for "massive" BOP improvements.

Asked why the tariff reduction proposals were of shorter time periods than SA's GATT proposals, Manuel said the critical period for the industries would be the next four years. "We are suggesting that if people don't move soon, they are going to die in any event and there is no point in dragging that dead horse on."

National Association of Automobile and Allied Manufacturers president John Brandner said Manuel's proposal for a task group to discuss the plans for the motor industry was "fair", although the components industry was still highly critical of the scheme.

He said there was little change from

Tariffs

Continued from Page 1

previous proposals which one academic said would lead to 'carnage' in the components sector. "The current proposals are a result of a lobby process, rather than an empirical study of the industry."

Textile Federation president Merv King said: "The minister's ruling erases the opportunity to implement plans it has drawn up to become internationally competitive."

(192)

Continued on Page 2

Manuel slashes tariff protection

CT(BE)13/6/95 (192) (193) (194) (195)

By BRUCE CAMERON

PHYSICAL EDITOR

Fundamental restructuring of the clothing, textile and motor industries with major reductions in tariff protection barriers and the scrapping of local content requirements for the motor industry have been unwrapped by Trevor Manuel, trade and industry minister.

The release of the programmes yesterday followed months of controversy and lobbying with fears raised that all three industries could be significantly damaged by the removal of the tariff barriers which were put in place during the sanctions era.

Manuel hoped to save thousands of jobs with the programmes, while making motor vehicles and basic clothing and textiles cheaper.

Key to the success of the programmes will be the stimulation of exports.

Zivereh Rustomjee, director general of trade and industry, said indications were that all the industries were improving and there would be a positive balance of trade in value terms, even though tariff barriers were coming down.

Manuel said all three industries had no option but to adapt and this was recognised particularly by the unions.

Manuel briefed all sectors of the industries. He said there was "no blood on the floor" but some reservations had been voiced about whether enough was being done on supply side measures, which included upgrading training and technology.

The clothing and textile industries had been given a month to consider proposals. A task force representing government departments, labour and employers was set up to consider the recommendations for the motor industry.



BOLD STROKE Trevor Manuel, trade and industry minister and Nic Swart, chairman of the board of tariffs and trade, announce news of fundamental changes to the clothing, textile and motor industries

PHOTO: ALAN TAYLOR

The programmes for the clothing and textile industries were completed by the trade and industry department. The recommendations for the motor industry were made by the Board of Tariffs and Trade.

For the motor industries, the local content programme would be dropped and a new system of reduced and "tradable" duties would be introduced.

In the process the range of motor vehicles assembled in South Africa is likely to decrease and prices are expected to come down.

In the clothing and textile

industries Manuel has opted for a compromise between demands for a 10-year phasing out of tariffs, demanded by the textile industry, and the five years on textiles wanted by the clothing industry.

Manuel said that the reduction of tariffs in all three industries would be counter balanced by intensive programmes to upgrade training, technology and management skills.

The upgrading of supply side inputs would enable the industries to become internationally competitive in both local markets and

export markets.

In the clothing and textile industries he has taken measures to improve management, technology and training to make them more internationally competitive.

Manuel said there would be phased reductions in the textile and clothing industries over eight years for ad valorem rates and over four years for specific duties, with a possible one year extension.

The decreases would be at a minimum rate of 10 percent a year.

□ See next page

Manuel's manual

□ Import duties on built-up vehicles to be reduced almost immediately from 115 percent now to 65 percent and to 40 percent by 2002.

□ Motor vehicle manufacturers to be granted a 27 percent duty-free allowance for components and further rebates if they export components or vehicles.

□ Phased reductions in the clothing and textile industries over eight years for ad valorem rates and four years for specific duties. Decreases will be at a minimum rate of 10 percent a year. All rebates phased out over 10 years.

New road for motor industry

ET(BR)13/6/95

(192)

By BRUCE CAMERON

POLITICAL EDITOR

The government intends to steer the motor industry on to a new track to give motorists a greater choice of vehicles, expand the manufacturing base of the industry and create a balance between imports and exports

In the revised phase six proposals of the Board of Tariffs and Trade unveiled by Trevor Manuel, minister of trade and industry, recommendations are made for the phased reduction of tariffs on imported parts and assembled motor vehicles, which will result in lower prices

A tripartite task group representing the department of trade and industry, labour and manufacturers has been appointed to finalise the proposals with an agreed September 1, outside date for implementation. The task group has been instructed to report back by July

At a media conference last night, Manuel said the recommendations amounted to a "sub-

stantial change" which would result in a simplified approach in dealing with the motor industry

Long-term objectives of the Board of Tariffs and Trade (BTT) recommendations include

□ Growth in vehicle assembly and component manufacturing industries with improved profitability,

□ Job creation and stabilisation,

□ Reduced tariffs to improve competitiveness and to make motor vehicles more affordable locally, and

□ A value trade balance between increased local content and exports of built up vehicles and components against imports of original equipment, after market components (post sales service) and built up vehicles

To achieve this, the BTT wants the current local content programme scrapped and lower tariffs imposed, with rebates which will encourage, rather than enforce local content, and stimulate exports of both built up models and components. In terms of

the new scheme, current excise duties of 100 percent plus a 15 percent surcharge on built-up motor vehicles, with a mass of not more than 3 500kg, will be changed to a customs duty of 65 percent, including the surcharge, which will be reduced to 40 percent over eight years

Duties on components will be reduced to 49 percent almost immediately with a target of 30 percent within eight years

To protect the local industry, motor vehicle manufacturers will be granted a 27 percent duty free allowance for imported components based on the wholesale value of a motor vehicle

Manufacturers will get further rebates if they export components or vehicles. For every one rand they earn in exports they will receive a one rand import credit against which they will not have to pay any duties. Manufacturers will be able to use the credits to import built up vehicles or parts

This could mean that manufacturers may stop assembling some models, which they would

import, while exporting more of units of a locally manufactured model

The small vehicle incentive programme will be continued for another three years

A similar programme has been recommended for the heavy vehicle industry with customs duties on built up vehicles being reduced from the pending 40 percent down to 20 percent in six years. Numerous phasing-in scales have been recommended for different components

The BTT expects the recommendations to rationalise the market

CUSTOM DUTY - BUILT-UP VEHICLES

Year	Import Duty	
	Built up vehicles	Components
1995	65%	49%
1996	61%	46%
1997	57,5%	43%
1998	54%	40%
1999	50,5%	37,5%
2000	47%	35%
2001	43,5%	32,5%
2002	40%	30%

ADE clinches R63m US exports contract

Edward West

CAPE TOWN — Atlantis Diesel Engines (ADE) would supply crankshafts and exhaust manifolds to US engine manufacturer Detroit Diesel Corporation (DCC) over the next five years in a R63m export deal, the company said yesterday

ADE senior GM Johan Kellerman said the contract represented a breakthrough into the US and there was a good chance of gaining further business in the market.

The exported components are for truck engines to be used in the US market

SA's only diesel engine manufacturer, which is controlled by the Industrial Development Corporation, is currently investing about R140m for the manufacture of crankshafts and engine blocks for export.

MD Ron Shires said a further R300m would be invested over the next 3-5 years, establishing ADE as a "major international component manufacturer" The export order book for the year stands at R120m

The recent finalisation of contracts with

(192) 10/15/6/95 companies in the Far East, US and Germany, aside from current contracts in Europe, the UK, the Far East and South America, would take Atlantis to within reach of its annual export target of R250m, he said

Referring to changes in the tariff structure announced by government, Shires said ADE expected increased competition to occur at the top end of the heavy commercial vehicle market with almost immediate effect

"This will have a negative impact on ADE and other component manufacturers.

"Those market segments servicing this category — the professional hauliers — will probably be threatened most and we can expect that imported vehicles will play an ever-increasing role."

Other categories in the heavy commercial vehicle sector, including buses, would probably continue to be serviced by local manufacturers where volumes justified assembly, Shires said

ADE had been pro-active over the past five years in preparing for government's decision to lower tariffs

ADE signs contract for US components

CT (PR) 15/6/95 (192)

By Audrey D'Angelo

WEEKLY NEWS

Atlantis Diesel Engines (ADE) has signed a R63 million agreement to supply components to United States engine manufacturer Detroit Diesel Corporation (DDC) over the next five years

ADE senior general manager, sales and marketing, Johan Kellerman, said the contract, ADE's first in North America, was a breakthrough

ADE "stood a good chance of gaining further business in the North American market"

The contract with DDC is for R12.5 million worth of crankshafts and manifolds to be delivered every year until 1999

It follows an announcement by ADE's new managing director, Ron Shires, that it would invest R96 million in new plant equipment to meet increasing local and export demand

He said this would create a further 200 jobs. They would be in addition to the 200 extra workers already employed this year to

operate a third shift on six days a week

"ADE's export order book for the current year stands at nearly R120 million

"We have recently finalised other substantial contracts with companies in the Far East, North America and Germany. These will take us within reach of our export target of R250 million a year"

ADE invested a total of R34 million last year in increased capacity on its crankshaft production line and expanding its foundry

Shires said the need to expand capacity for export production had been "exacerbated by increased engine and replacement parts business as the upturn in consumer confidence has led to increased demand from the road transport industry"

He said the company had foreseen that competition would increase in the domestic market as protective tariffs were lowered, and had taken steps to transform itself into a world class components manufacturer



COMPETITIVE ADE managing director Ron Shires says he expects increasing competition in the heavy commercial vehicle sector

"We do expect increased competition at the top end of the heavy commercial vehicle sector with almost immediate effect. This will have a negative impact on ADE and other component manufacturers," said Shires

However, although imported vehicles were likely to play an increasing role in the road haulage market, bus companies would probably continue to use locally manufactured vehicles where volumes justified local assembly

MOTOR INDUSTRY

A decision at last

FM 16/6/95
Vehicle components manufacturers have finally won the ear of government in their attempts to limit the volume of imported components that may be brought in duty-free by vehicle manufacturers

Trade & Industry Minister Trevor Manuel this week ended months of industry frustration and uncertainty when he accepted a final report by the Board on Tariffs & Trade (BTT) for a long-term motor industry development plan.

It includes a duty-free allowance on imported components equal to 27% of the wholesale value of vehicles built by a manufacturer. This is above the 25% allowance



Manuel a chance for further representation

in force under the existing Phase Six local content programme, but below the board's earlier 35% recommendation, which was supported by local motor companies

Components manufacturers have argued that the higher figure would encourage motor companies to import more components than ever before — not only denying local manufacturers the volumes required for economies of scale, but also increasing the

industry's exposure to foreign exchange dangers

SA motor companies admitted recently that the rand's latest slide against the Yen and Deutschemark have damaged plans to limit vehicle price increases this year. This factor clearly influenced the board, as did the components sector's argument that its own cost and price increases in recent years were well below the producer price index. It contended that the 35% figure would add billions of rand each year to the industry's import bill.

The duty-free allowance in some instances will effectively start at 27,5%. The additional 2,5% is the allowance granted to manufacturers of small vehicles now. As in its previous reports the board recommends that this disappear over three years.

In announcing his acceptance of the BTT report, Manuel set September 1 as the latest date for its implementation (the original deadline was July 1). However, he said a task group made up of representatives from the components and vehicle manufacturing industries, and from the industry's main union, the National Union of Metalworkers, would be given the chance to make further representations before September. Ideally, he wants them to have a report ready by July 31.

With the exception of the duty-free allowance, most of the report is in line with previous versions. It still favours reducing the current 75% import duty on built-up cars and light commercial vehicles to 65% this year, then to an eventual 40% in 2002. Components import duties will drop to 49%, then gradually to 30%.

Though the board continues to applaud the idea of reducing the number of vehicle models produced in SA, it still shies away from hardline recommendations of the original government-appointed motor industry task group, which espoused punitive duty penalties on low-volume production.

The socio-political ramifications of full-scale rationalisation — likely to include plant closures, job losses and major damage to entire regional economies — continue to overshadow all attempts to restructure the industry.

Companies such as BMW which have devoted major resources to developing export markets, will continue to find comfort in the final plan. Exporters of locally built vehicles may import built-up vehicles free of duty to the same value as local content in exports. The effect, as is already happening, will be to encourage companies to export mass-produced models, and import low-volume models now built in SA.

Predictably, the report also incorporates a recent separate recommendation redefining local assembly, thereby plugging a loophole that allowed companies — most notably Korean car-maker Hyundai — to avoid import duties while carrying out only limited local assembly on certain vehicles. Hyundai has an effective two years to switch to full assembly or face tariffs.

The BTT report reinforces previous plans to reduce protection for the truck industry. Import protection against built-up trucks will drop to an immediate 40%, then downward to 20% by the year 2000, for imported engines, transmissions, axles and tyres, barriers will slide from 30% to a final 15%, and for cabs and bodies, from 20% to nil.

Given the small size of the SA truck market and limited size of companies' truck operations, the threat to investment and employment which will ensue from this far harsher cut in protection, is not expected to cause major anguish.

Companies most under threat, such as Atlantis Diesel Engines (ADE), have already begun diversifying.

Weak rand overtakes drop in motor duties

ST(BT)18/6/95

(192) (BT)

By DON ROBERTSON

HOPES that development programmes announced for the motor industry this week may result in lower car prices should be tempered by the likelihood that further declines in the value of the rand will wipe out most of the import duty cuts.

The revisions to Phase VI call for reductions in import duties on completely built-up cars (CBUs) and light commercials from 65% this year to 40% by the year 2002 — a rate of about four percentage points a year. Reductions in duties on component imports will come down from 49% to 30% over the same period.

Motor manufacturers say the reduction in protective tariffs will put pressure on the pricing of comparable, locally produced products, although they concede that in early years, vehicle imports will be in the high-priced luxury range and will not have a significant impact on lower priced vehicles.

Historically, however, the rand has depreciated against major currencies, particularly the Japanese yen and German mark by more than 4% a year. Since the beginning of this year alone, the rand has lost about 20% to the yen and about 17% to the mark.

Tony Twine of Econometrix says the reduction in duties is not an instant recipe for cheaper cars. It might offset some of the

damage caused by a weakening rand, but it won't cancel it out. Fears of a falling rand were constantly in the minds of the development programme's authors during its preparation and they still are, he says.

Nico Vermeulen, executive director of the National Association of Automobile Manufacturers of South Africa, hopes that cheaper prices will be achieved only in real terms, to keep prices below the inflation rate. However, as the economy grows, disposable income will increase, which should make cars more affordable in relative terms.

Willie van Wyk, managing director of Delta, says the programme "in the longer term will lead to more affordable products in real terms for our customers".

John Newbury, Nissan's chairman, says he does not expect any immediate reduction in prices.

At the beginning of the year, Bert Wessels, chief executive of Toyota, hoped price rises could be kept below 5% this year. The subsequent plunge in the rand put paid to this.

A mischievous industry source suggests there is a large interest group which would not like to see vehicle prices decline in nominal terms, as it will

affect residual values on cars bought on lease.

The revisions also propose a 27% duty free allowance for manufacturers, based on the wholesale value of vehicles produced. This is below the 35% requested and was reduced, probably at the insistence of component manufacturers as the local content requirement was dropped.

To encourage exports, manufacturers and component suppliers will be permitted to import vehicles or parts, equivalent to the export value of these items on a one-for-one basis.

Manufacturers exporting components, excluding autocatalysts, may bring in CBUs equivalent to 75% of the value of parts sold overseas.

Naamsa says that vehicle manufacturers and component suppliers will have to ensure that the difference between the price of locally produced parts and those available overseas is reduced.

Mr van Wyk echoes this point, saying future sourcing of components will depend on quality, service and price, "with the final

contract being placed with the best supplier, regardless of geographic location".

Inflation rates in Germany and Japan, the main source countries, is below 3%, so local component manufacturers will be hard-pressed to match these prices.

A task group has been appointed to resolve any remaining issues, but it is expected the programme will be introduced on September 1, although the cut in import duties to 65% will probably be implemented sooner.

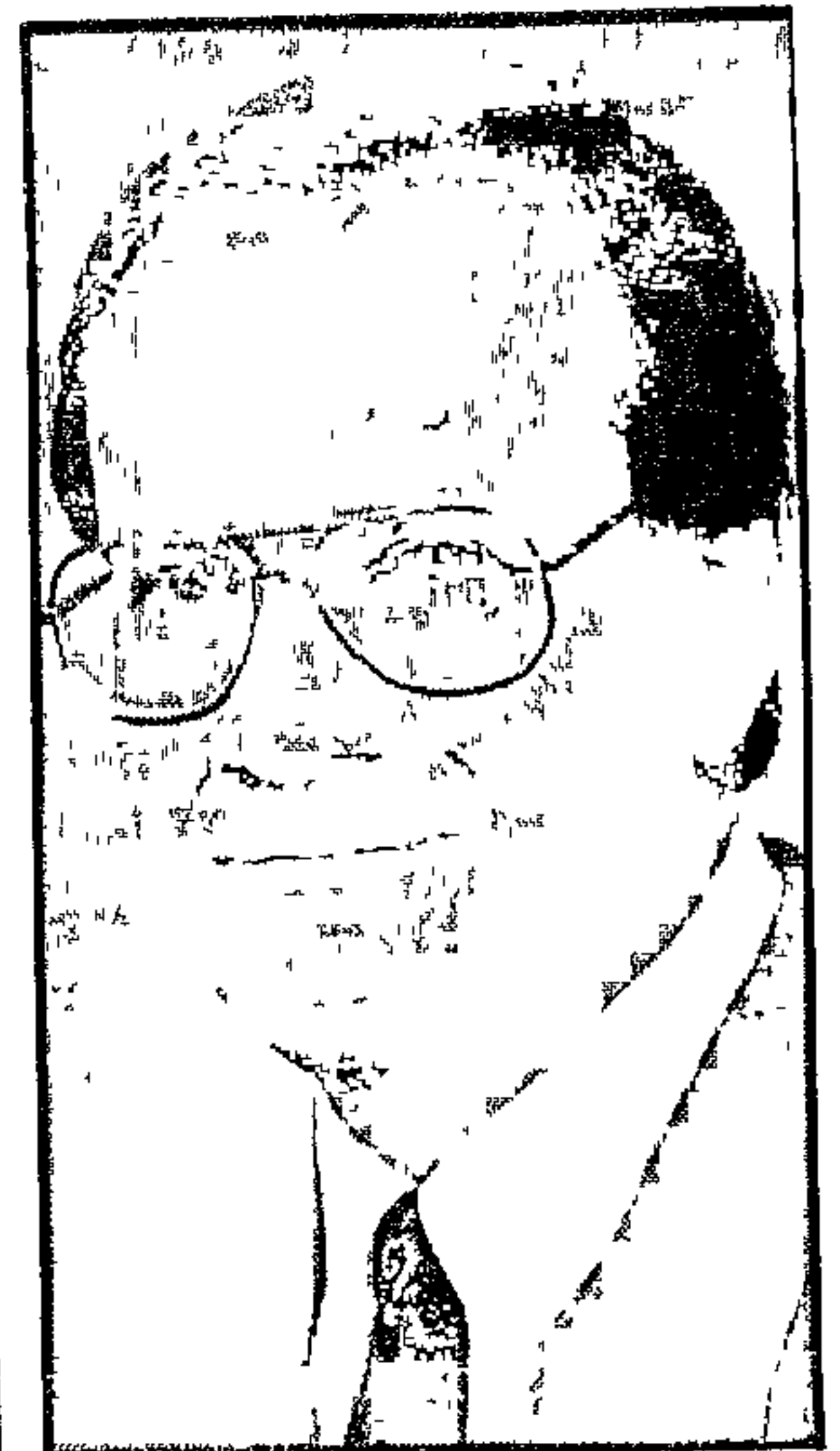

DASHED HOPES... Bert Wessels, MD of Toyota, and Delta's Willie van Wyk

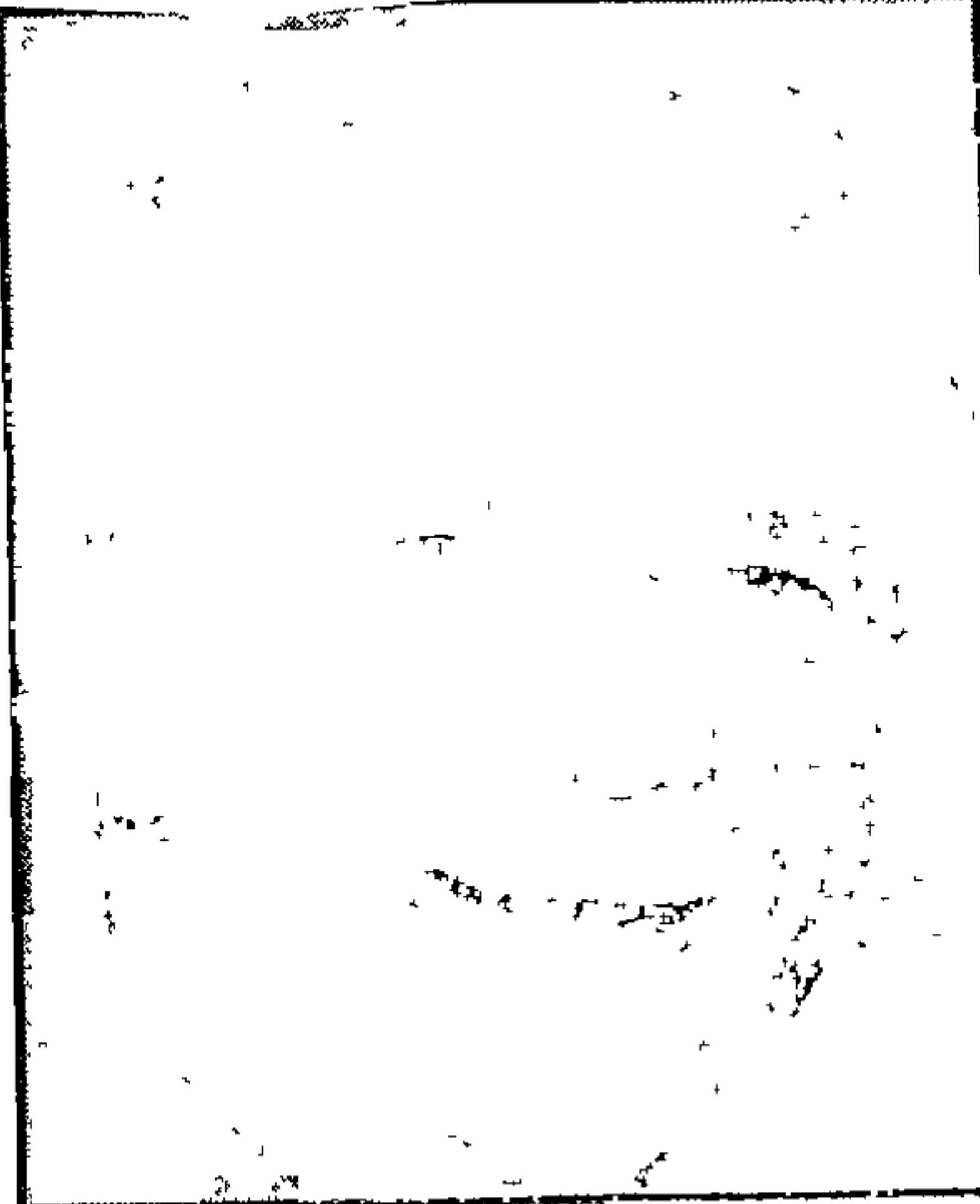

SIZING UP: Des Gush, director of Toyota SA Trucks

Toyota to get heavy in SA's truck market

TOYOTA plans to grab a bigger share of the heavy truck market with the introduction to South Africa of Peterbilt heavy trucks next month, writes DON ROBERTSON.

Although Toyota dominates the medium truck sector with a 45% market share, it is a distant second in the larger class, especially in the 6x4 range which has shown the largest growth over the past few years — from 20% in 1991 to 31% last year. (192)ST(BT)18/6/95

"Toyota Japan has no 6x4 vehicles in its product range," says Des Gush, director of Toyota SA Trucks.

To overcome this gap, Toyota SA has signed an agreement with US manufacturer Paccar, which builds Peterbilt, Kenworth and Foden trucks.

Paccar will develop right-hand drive Peterbilt trucks for South Africa and Toyota will assemble and distribute the vehicles and supply parts and service. It is the first time a North American truck will be assembled in South Africa, says Mr Gush.

Toyota has invested about R58-million in a separate assembly line at its Prospecton manufacturing plant near Durban. Production will be handled by a wholly owned subsidiary, Westruck Services, trading as Peterbilt SA.

It is intended to establish a company to service Kenworth trucks in southern Africa, while a range of Foden in-town freighters, fuel tankers and heavy-duty dump trucks might also be introduced. Toyota expects to produce about 100 trucks by the end of this year and has orders for 50. Next year it expects to produce 20 to 30 a month, which should help increase its share of the medium and heavy truck market from 27% to about 32%.

Although Peterbilt offers a wide range of products in the US, Toyota will distribute only two models, the 377 conventional or bonneted cab and the 362 cab over model. The trucks are powered by a 14 litre, six-cylinder engine producing 324kW at 1 800rpm with maximum torque of 1 966Nm at 1 200rpm. Other drive options are being considered. The Peterbilt trucks will be distributed and serviced by 15 dealers in South Africa, Namibia and Botswana.



MOVING . . . Ron Shires, who says ADE is on course for R250-million in exports

COMPANIES

(192)

ADE gears up with R440m expansion drive

(192) ST (BT) 18/6/95

ENGINE manufacturer ADE is to spend R440-million in the next three to five years to expand production capacity to meet new export orders worth over R220-million.

Ron Shires, the company's newly appointed managing director, says ADE is currently investing about R140-million to manufacture crankshafts and engine blocks for export.

A further R300-million will be invested later to establish ADE as a major international export manufacturer, he says.

Mr Shires succeeds Fritz Korte, who set the IDC-owned company on the path to profit five years ago.

By DON ROBERTSON

Hourly paid workers and staff were drastically reduced, the price of diesel engines was cut from an indexed 100 to 96 at present and productivity was improved. Price increases in the next 18 months to 24 months are expected to be moderate.

The company earns about R120-million a year from exports but, says Mr Shires, "the recent finalisation of substantial contracts with companies in the Far East, North America and Germany in addition to the current contracts in Europe, the UK, the Far East

and South America, will take ADE to within reach of its annual export target of R250-million".

Of the R140-million now earmarked for expansion, R52-million will be for flexible machines in the engine plant to meet export demand for castings and the balance for equipment to increase capacity at the Grey Iron foundry.

The company recently introduced a third shift at its machining and foundry plants, which now operate six days a week.

Recent export contracts include a R70-million order for V8 and V10 cylinder blocks for South Korean Daewoo Heavy Engineering, a R100-million

order for key components for MAN in Germany, a R63-million order for crankshafts and exhaust manifolds for Detroit Diesel Corporation in America and a R90-million contract for cylinder blocks, heads and crankshafts for Perkins Engines of the UK.

Referring to plans by the Department of Trade and Industry to reduce import duties on components, Mr Shires says he expects competition at the top end of the heavy truck sector to come into play almost immediately.

"This will have a negative impact on ADE and other component manufacturers. Those market segments servicing this category — the professional hauliers — will probably be threatened

most and we can expect that imported vehicles will play an ever increasing role," Mr Shires says.

"The other categories of the heavy commercial vehicle sector — including buses — will probably continue to be serviced by locally manufactured vehicles where volumes justify assembly," he says.

Nevertheless, turnover in the financial year to June is expected to increase to R750-million and to R1-billion by the year 2000, when it is hoped that 50% of income will be generated by exports, says Mr Shires.

In the next financial year, parts sales are expected to rise by 26% and engines by 42%.

Motor: SA can become a major car producer

CT(BR) 20/6/95 (192)

The uncompetitive motor vehicle industry and its associated component sector have the potential to become significant producers, but rationalisation is required

A study of the sectors by Anthony Black of the Industrial Strategy Project revealed that South Africa may have greater potential as a car producer than was generally realised

He rejected the "widely held view" that the industries should be forced to become competitive through the rapid lifting of tariff barriers to allow cheap imports

This would lead to loss of jobs and the basic technological competence that has been built up in the industry

Structural adjustments would have to take place behind the screen of gradually decreasing tariff barriers

Black said the motor vehicle industry should be encouraged to reduce the number of models and makes being produced, standardise components used, increase exports, and invest more heavily in research and development, training and improved work organisation

The recommendations should be seen against the background of increased internationalisation of investment and the emergence of new production sites in the international motor industry, with vehicle

assemblers and component producers looking for lower wage countries from which to source components or in which to assemble vehicles. The result was the development of niche markets for many developing countries

This has started to happen in South Africa, with growing exports of vehicles and components but

'The industry should reduce the number of models and makes it produces'

"competition is severe and highlights the need for a stable and effective policy regime and the need to build up further links with global networks"

Black said the vehicle industry is essentially unproductive for a number of reasons. These included

□ The high cost of locally produced components, which have received substantial protection through local content programmes,

□ A lack of economies of scale as a result of the unusually large number of models produced

Average annual production for each model is lower than low volume producers such as Brazil and Australia,

□ Low capacity utilisation,

□ Low standards of productivity with very limited progress made in training workers in new production methods or in getting them to support productivity goals, and,

□ Trailing world manufacturing benchmarks in quality and inventory levels

However, despite its flaws, Black said, the motor vehicle industry had considerable scope for expansion because of the large potential market growth in South Africa and the region

The emergence of tripartite policy making through structures like Nedlac also open the way for more stable industrial relations

The components industry is uncompetitive because

□ It lacked economies of scale with firms generally producing an unusually wide range of components at very low volumes by world standards, and

□ The high cost of raw materials such as steel and aluminium

Black found it was not all bad news. Component producers had developed considerable expertise in making small numbers of a wide range of components which could compete in niche markets

Samcor to cut salaried staff by 10%

By ROY COKAYNE

(192)

PRETORIA BUSINESS EDITOR
CT (PR) 22/6/95
Motor manufacturing giant Samcor has embarked on a rationalisation programme to cut its salaried staff by about 10 percent or 100 people

Dirk de Vos, Samcor public relations manager, confirmed that an early retirement/retrenchment offer had been made to all the company's salaried staff. The company has a total workforce of about 4 000 in Pretoria and Port Elizabeth

But he stressed a restructuring programme affecting the company's hourly paid workforce was not being contemplated nor negotiated at this stage

The catalyst for the salaried staff cutback was the reduction in import tariffs and the need for increased productivity to make the company more internationally competitive

A notice about the offer sent to salaried staff by Jim Miller, group managing director, said it had become necessary to take specific actions aimed at reducing costs and improving organisational efficiencies to ensure the long term viability of the company

De Vos said the early retirements and retrenchments were totally voluntary and would not be forced on anyone

Renault truck plant for Brakpan

(192) (BR) BD 22/6/95
Business Day Reporter

EAST Rand company SA Euro Truck is to set up a truck assembly plant in Brakpan on the East Rand, under a Renault Motor Company franchise

The project's first phase — the purchase of land from the Greater Brakpan transitional local council — is completed. Two more phases — a new headquarters for the company and a display room — will be completed by the end of the year

Euro Truck spokesman Johan Dippennary said the company would pro-

duce Renault commercial vehicles including light, medium and heavy trucks, as well as coaches

He said the project would include the distribution of the product, the assembly plant, building of new premises, and marketing

Dippennary said the company was SA's sole Renault representative

The Brakpan council that the company had bought about seven hectares of land

A council spokesman said the assembly plant would create about 2 000 jobs

INDUSTRIAL POLICY

No pain, no gain

Sensible long-term policy proposals have given way to compromise

(192) (184) (187)
PM 23/6/95

Trevor Manuel is no Jonah Lomu. The giant All Black winger knows where he wants to go and will trample all in his path to reach there. SA's Trade & Industry Minister also knows his goals but, unlike Lomu, is worried about hurting those in the way.

That's certainly the impression coming out of the two industrial strategy documents approved by government last week — one for the motor industry and the other for clothing and textiles. What started out as genuine attempts to revitalise industries distorted by protection and to create world-competitive sectors, have been softened along the way and turned into minimum-pain programmes.

Driven, to a degree, by the need to meet the trading requirements of Gatt, the proposals appear to some to offer the minimum needed to comply. Brave statements about creating competitive industries have been obscured by expediency.

When Derek Keys, the former Minister of Finance and of Trade & Industry, created a task group in October 1992 to devise a new long-term policy for the motor industry, he apparently envisioned something that would turn the industry on its head. That's certainly how Derek Riley, who was task group chairman, saw it. He and his group were confronted by an industry made inefficient by years of protection and successive government-imposed local content programmes.

Put simply, there were — and are — too many vehicle manufacturers making too many models for the size of the market.

Economies of scale, both for the manufacturers and for the components companies that supplied them, were negligible. Nor was there much pressure to improve, not when the industry was protected from foreign competition by tariff barriers of over 100% on built-up vehicles.

Also, the continued reliance on imported components exposed the industry to dangerous cost penalties as the rand continued its slide against foreign currencies. For consumers, the bottom line was vehicle prices that escalated beyond the rate of inflation. New vehicles were becoming unaffordable; this was reflected in falling sales and the marginalisation of private buyers in a market dominated by fleet and company sales.

The task group produced two reports — one on cars and light commercial vehicles, and the second on medium and heavy commercials. The latter was less sensitive. In terms of both sales and employment, it is a minor

part of the industry, and the economic effects of reduced protection are likely to be limited. So while car makers face a final import protection tariff of 40% by the year 2002, the truck sector will be down to 20% two years earlier. For local manufacturers of truck engines, transmissions, tyres and axles, it will be 15%.

The attitude of this sector is summed up by MD of Atlantis Diesel Engines (ADE) Ron Shires, who says his company has been diversifying for years in the knowledge that eventually it would no longer be able to rely on its traditional core business.

The report on cars and light commercial vehicles immediately touched some nerves. It recommended gradually reduced protection tariffs that would hit a base of 45%. As important, other proposals included onerous duty penalties on manufacturers failing to build minimum volumes of individual mod-

Naamsa document

Many of the task group recommendations survived. But casualties included the penalties for failing to meet minimum-volume targets, never to be seen again. The BTT took the view that the 45% tariff protection target was too high, and cut it to 30% — only to raise it to 40% in its next report.

Little changed between then and last week, when Manuel accepted the BTT's latest recommendations for the motor industry. The only rider is that a working group has been given the chance to smooth some of the plan's rough edges before its scheduled implementation on September 1.

But the plan contains positive elements. Protection for vehicles and components will diminish, exports are encouraged, and there will be a degree of local model rationalisation; indeed, the process has already started and companies are starting to import

low-volume models previously built here. The growing number of foreign makes being seen on the SA market is a sure sign that the market is opening up.

Delta Motor Corp MD Willie van Wyk, whose company builds Opel and Isuzu vehicles, says past local content programmes have isolated the SA motor industry from the global market and created an inefficient industry. The new policy will help correct this "in a regulated manner".

VW MD Heinrich Holtmann says the new programme will put pressure on all sectors of the industry to become more productive in order to compete on world markets. On the other hand, he is

worried that the small vehicle incentive, offering duty rebates to makers of small cars, may disappear after three years.

Already gone, though, are some of the toughest actions from the original task group report: a sure sign that the final programme plan is motivated by different objectives than those originally visualised by Keys and Riley.

As Riley explains it, his mandate was to encourage local vehicle manufacturing, and not just assembly. Rather than an industry which bolted together components from around the world, the aim was to create an industry in which as much as possible was manufactured locally. That meant a strong components sector enjoying long, cost-effective production runs. That, in turn, meant fewer vehicle models in greater numbers.

Of course, a hardline programme could have unpleasant social and political results. Australia, which adopted a tougher ap-



els, and minimum averages across their total product range.

The intention was to force manufacturers to reduce model proliferation. If it also resulted in one or two companies being forced out of the market, then so be it, in fact, so much the better. Riley, in fact, thought these proposals didn't go far enough and described them as "too cosy".

The report, effectively, was a majority view among the industry's warring factions. The depth of disagreement became clear when vehicle manufacturers, through the National Association of Automobile Manufacturers (Naamsa), appended their own comments to the report, disagreeing with many of its findings.

As industry analyst Tony Twine, from Econometrix, notes, by the time the Board on Tariffs & Trade (BTT) produced its first set of proposals based on the task group report, they were more a reflection of the

Samcor lining up to supply Mazda Japan

CT(MR) 27/6/95 (192)

By ROY COKAYNE

PRETOPIA BUSINESS EDITOR

Samcor is involved in negotiations to supply automotive parts to Japan's Mazda Motor Corporation

Dirk de Vos, Samcor public relations manager, confirmed that negotiations for business with Mazda Japan had been underway for some time

He said talks conducted so far were positive but stressed no agreements had been reached

Samcor is not currently a supplier to

Mazda Japan

However, De Vos said Samcor hoped to do some business with Mazda Japan, particularly because of the strength of the yen

He said Samcor initiated the negotiations prior to Mazda's announcement that it aimed to boost overseas procurement of automotive parts from its current level of 5 percent. The proposed boost is to deal with its corporate rehabilitation and the strong yen

The official responsible for the announcement said the company was

considering plans to source parts from South Korea's Kia Motors and Ford Motor of the United States, which owns 25,5 percent of Mazda

No mention was made of sourcing parts from South Africa

The official said the company had not made any concrete decisions on overseas procurement, such as targets or timetables

He also described as "unrealistic" a report that Mazda Japan would raise its overseas procurement ratio to as high as 30 percent over the next three years

Smog-eating cars fail to fire up platinum industry

By DEREK TOMMEY

MINING EDITOR

The platinum industry in South Africa is not showing much excitement at this stage about the plan by the American firm Engelhard to use a revolutionary system, using platinum, to convert American cars into smog-eaters

Industry sources said the plan is

seen as providing an escape route for American car manufacturers unable to reduce the emission levels on their vehicles to the standards being demanded by the Californian authorities

The standards apply to gross exhaust emissions. But the idea is that, hopefully, by converting cars into mobile vacuum cleaners so that they absorb pollutants as well

as give them off, their net emissions will conform with the high standards

The scheme involves placing a catalytic coating containing platinum on the surface of a vehicle's radiator and air-conditioning condenser. This converts ozone to oxygen and carbon monoxide to carbon dioxide

The technology of the system is

not in doubt, said a local industry official, but there are big question marks over how much smog it will actually extract from the air. The installation of the smog-cleaner is expected to add about \$1 000 to the price of an American car. Consequently, unless the authorities legislate for its introduction it is felt that few cars will have the new system

Plesgem awarded R25m contract for electricity meters

Plesgem, a division of Plescorp, which is to be listed on the JSE following the merger of Sankorp's electronic interests in Plessey Telumat SA and Tek Electronics, has been awarded a R25 million contract to supply prepayment electricity meters to the Cape Town city council

Alan Roy, managing director of Plesgem, said "We have already supplied over 60 000 units to the city council over the past year and are very pleased that we won this contract. There was stiff competition from four other suppliers but we won the tender"

The contract is for an additional

70 000 units and accounts for 17 percent of Plesgem's budgeted turnover

"Our systems have virtually become the council's standard prepayment meter," said Roy

Ted Doman, a city council spokesman, said the units, which were key-pad based, were well

suited to the council's requirements and had made a significant contribution to the stabilisation and recovery of electricity payments

Arrears had declined for three consecutive months and were now well below the November 1994 peak of R62,2 million, Doman said
— Staff Writer

Landmark deal to steady auto industry

(192)
ARLT 30/6/95

ROGER FRIEDMAN
Staff Reporter

CAR manufacturers and trade unions have concluded a landmark, long-term labour agreement designed to stabilise and regulate the industry until mid-1998.

"The path-finding accord is designed to change the shape of labour relations in an industry emerging from episodes of serious conflict in recent years," the Auto National Bargaining Forum announced yesterday.

The forum represents the Automobile Manufacturers Employers' Organisation, the National Union of Metalworkers of South Africa, and the Suid Afrikaanse Yster, Staal en Verwante Nywerhede-Unie.

According to the forum, the agreement "also promises to play an influential and precedent-setting role in the wider South African industrial relations context"

In broad terms, the agreement is intended to foster co-operative relations between the parties, enhance the skills base of all employees, redress historic wage disparities between hourly-paid workers and artisans, reduce wage spreads within companies and between companies, extend the life-span of wage and working conditions agreements, and promote stability and industrial peace.

The agreement will regulate wages, working conditions and other matters of common concern from July 1995 for three years.

By July 1998, all companies will be paying a base wage according to industry-wide grade bands, with specified minimum and maximum salaries.

This year, the majority of employees in the four lowest grades will receive an 11 percent wage increase.

For the next two years their wage increases will match the inflation rate.

Motor industry signs landmark agreement

(192)

CT (MR) 30/6/95

By ROY COKAYNE
PRETORIA BUSINESS EDITOR

Trade unions and employers yesterday signed a groundbreaking three-year agreement setting down productivity guidelines and a comprehensive training policy as well as wages and working conditions.

The accord was reached by the Auto National Bargaining Forum, representing the Automobile Manufacturers Employers' Organisation, Numsa and the Iron, Steel and Allied Industries Union.

All the major motor manufacturers in South Africa — BMW South Africa, Delta, Mercedes-Benz South Africa, Nissan South Africa, Samcor, Toyota South Africa and Volkswagen South Africa were represented in the talks.

The agreement signals a dramatic turnaround in an industry often ravaged by conflict and trauma — culminating in a lengthy strike by 25 000 workers less than a year ago which cost employers more than R2,5 billion.

A joint statement said "the path-finding accord is designed to change the shape of labour relations in an industry emerging from

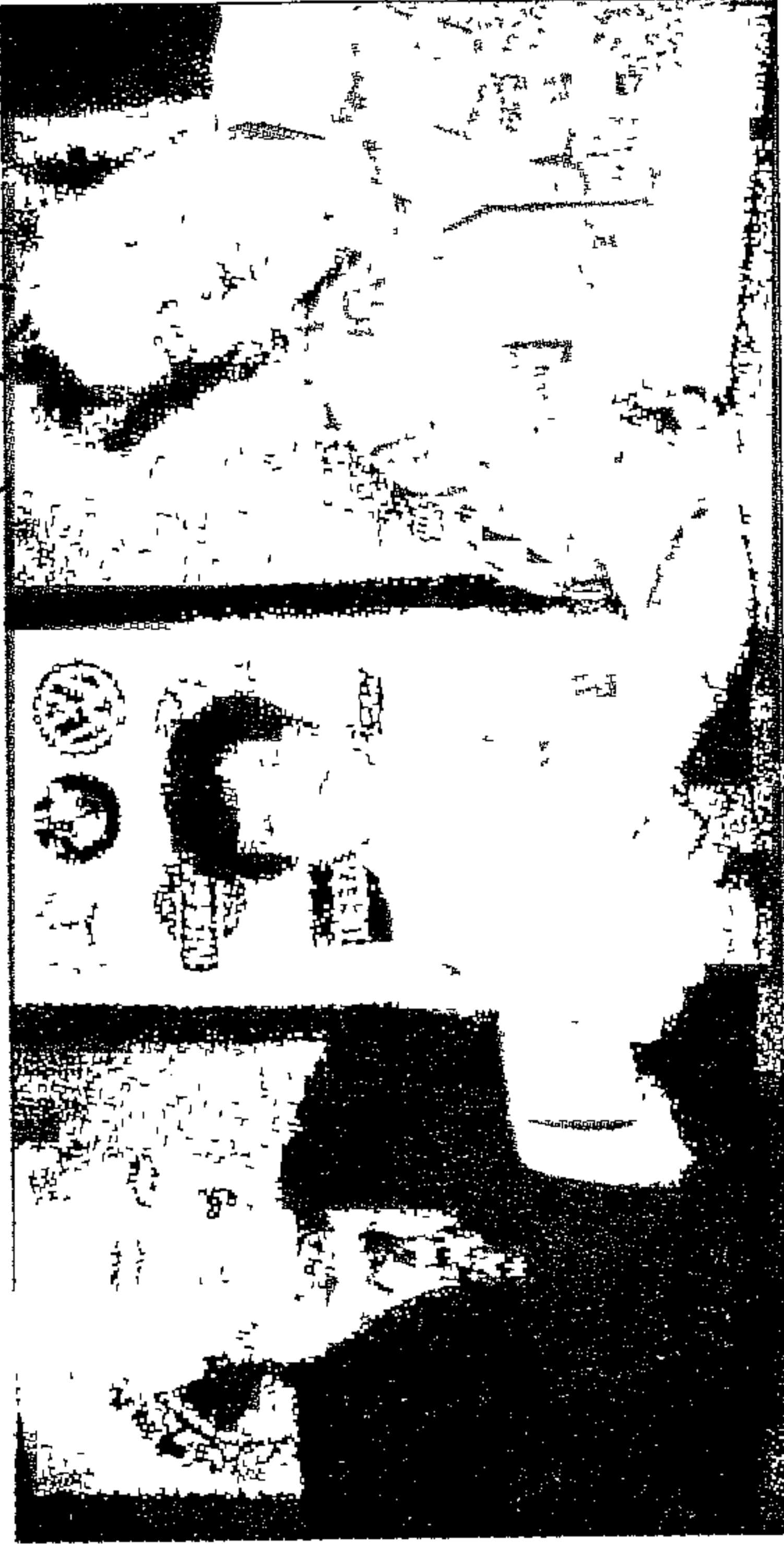

IT'S A DEAL George Stegmann, negotiator for the automotive industry employers (left), with Gavin Hatford, of the Iron, Steel and Allied Industries' Union, and Gavin Hatford of Numsa

PHOTO JOHN WOODPOOF

episodes of serious conflict in recent years — and also promises to play an influential and precedent-setting role in the wider South African industrial relations context".

Key features of the agreement are

- The pact is effective for three years, from July 1 this year until June 30 1998,
- A new wage model involving the progressive reduction in the wide spread of wages within job grades and the significant spread in wage rates between companies in the industry,
- An increase of 11 percent for

the 1995/96 employment period — and an increase matching the inflation rate in succeeding years — for lower level grades. The lower grades earning less than the target minimum for a particular grade will receive additional increases. The majority of artisans and technicians will receive 10 percent this

year and an amount slightly less than the inflation rate in succeeding years,

- Recognition that education and training are a vital element of the overall plan to increase the competitiveness of the industry, and committing funds for the Automobile Manufacturing Education and Training Board Career progression will also be based on the successful completion of adult education,

- A productivity guidance framework to facilitate initiatives in this area in a consultative, mutual interest manner,

- A proposal that the key actors in the industry consider a joint forum to deal with common concerns and to liaise with government. The establishment of a motor industrial council is also proposed

- An autonomous mediation-arbitration process will handle disputes and a mediation-opinion process for will be set up for various other types of disputes,

- A comprehensive peace obligation which restrains the parties from engaging in any industrial action in conflict with the provisions of the agreement

would provide

Richards Bay container terminal may go private

The planned new container handling terminal, which seems destined to go to Richards Bay, may be managed by a private sector operator

This was revealed in parliament by the minister of public enterprises Stella Sigcau in reply to a question asked by the National Party MP Piet Welgemoed

But Sigcau said Portnet had no immediate plans to allow shipping companies harbour facilities to handle their own containers to relieve current port congestion. Portnet would continue to operate the three container terminals which have been in operation since 1977, she said.

A final policy was still to be decided on the operation of a new container terminal. The terminal should be in operation by 1999. If it is decided to put the operation of the new terminal out to tender "it would be preferable to have an independent operator (and not a shipping line or cargo operator) running the terminal as that would be in the interest of optimal capacity utilisation" — Bruce Cameron

Broadacres changes name: Broadacres Investments, now listed on the JSE's diamonds sector, will change its name to Baobab Solid Growth and list on the JSE's investment trusts board from Monday. The company holds 14,9 percent of Mercantile Bank and 49 percent of Premier Freight as well as R10 million in cash.

SA urged to join African Development Bank: South Africa would benefit enormously from becoming a member of the African Development Bank as it was a major force in African finance, said Kobus van Rensburg, managing director of MBB Consulting Engineers.

Sanlam awards R22 million contract: Sanlam Properties said it had awarded a R22 million contract to Ovcon to build a mini-factory project, known as Kyalami Industrial Park, on a 3,8ha site near Pine Town, Durban. The facility would provide 17 000m² of factory space, with units of varying size.

Black businessmen in demand: David Hutton-Wilson, director of RES International Executive Search Consultants, estimated at a Geneva conference that the demand for black professionals could reach about half a million by 2013. According to reports, black businessmen enthused their Swiss and other European counterparts.

Packaging company sub-divides shares: Packaging print and paper company, Holdains, said it would sub-divide its shares 10-for-1. Richard Bruyns, chief executive, said the motivation behind the split was to make Holdains shares more affordable to a broader spectrum of investors and so increase their marketability.

Motor industry hails new labour dispensation

BY ROY COKAYNE

PRETORIA BUSINESS EDITOR

The new industrial relations dispensation for the vehicle manufacturing industry has been welcomed by industry participants.

National Association of Automobile Manufacturers of South Africa (Naamsa) executive director Nico Vermeulen said a key feature of the motor industry development programme would be the opening up of the South African market to international competition and the requirement for a continued focus on the export business.

Vermeulen said realities required employers and trade unions to join forces to control all cost items and to improve substantially the productivity of all factors of production.

Numsa auto sector chief negotiator Gavin Hartford said this agreement laid the basis for the South African car manufacturing

industry to survive in the global market while at the same time significantly improving the conditions of workers.

Numsa general secretary Enoch Godongwana said the agreement was a great victory for the union in pursuing the goals of the bargaining strategy which it adopted in 1993. "Within the next three years it guarantees that enormous strides will be made in closing the apartheid wage gap and readdressing the legacy of poor education and training of the majority of workers," he said.

Gwen Prinsloo, collective bargaining manager of the SA Yster, Staal and Verwante Nywerhede Unie (Iron, Steel & Allied Industries) said the agreement's most significant aspect was it zoned in on the long-term viability of the motor industry and the economy.

She said wage rates would be linked to the consumer price index for the next two years.

Sappi woos international investors

BY CHARLOTTE MATHEWS

INVESTMENT EDITOR

Paper group Sappi plans to issue dollar-denominated Euroconvertible notes, Eugene van As, executive chairman, said yesterday.

The notes will be convertible into Sappi ordinary shares and marketed to international investors.

The reason for the issue is that the group's funding costs have soared since last year's "1,6 billion

acquisition of control of American paper maker SD Warren.

Sappi also intends to reduce debt through an initial public offering of equity in one or more of its subsidiaries "in due course".

The group plans to make a series of investor presentations in mid-July and the notes will be placed in international markets outside South Africa. The issue is subject to the passing of the necessary resolutions by shareholders and Reserve Bank approval.

Unions strike healthy deal

(192) Sowetan 30/6/95

Motor industry unions bargain for good working relationship with Seifsa

By Abdul Milazi
Labour Reporter

THE National Union of Metalworkers of South Africa and the Steel and Allied Industries Union yesterday signed a historic labour agreement with employers in the motor manufacturing industry.

The workers and employers in the industry agreed on a 10 percent across-the-board wage increase and a 11 percent wage increase for the lowest paid workers.

The unions and the Steel and Engineering Industries Federation of South Africa were brought together by the 1994 strike in the motor manufacturing industry which threatened to bring the industry to its knees.

In a joint statement the two unions and Seifsa said the strike had forced the parties to re-examine their relationship and to search for ways of developing a new wage model, a new education and training dispensation and possible new industry struc-

tures. The parties said the agreement achieved two ends in that it settled a series of framework matters within the industry and also settled the issue of wages and working conditions.

The agreement is intended to foster cooperative relations between the parties, enhance the skills base of all employees in the industry on a continuing basis, redress historic wage disparities between hourly-paid and artisan workers, reduce wage spreads within and between companies in the industry.

It is also aimed at significantly extending the life-span of industry agreements on wages and working conditions, satisfy the further preconditions for an internationally competitive industry and promote stability, predictability and industrial peace in the industry.

The main features of the agreement are that it would regulate wages, working conditions and other matters of common concern for three years, starting from tomorrow, July 1.

Is your marriage



Assembly line cannot afford disruptions of the past

wage difference, but in reality was the result of sheer bloody-mindedness built up over several years

This year labour and management agreed to take a more mature approach to negotiations and they brought in two outside facilitators from an early stage — mediator Charles Nupen and Prof Clive Thompson, of

the University of Cape Town's labour law unit. Their efforts played a large part in achieving agreement on time ■

ment say sets this year apart, is the fact that they recognise the motor industry can no longer afford the disruptions of the past as it prepares to enter the government's new seven-year motor industry development plan (MIDP)

The plan is intended to create a streamlined, world-competitive industry with a strong focus on exports. Any continuation of the chaos of the past, and it can forget any hope of success.

Under the new three-year agreement, wages for hourly paid workers in grades one to four will rise by 11% from July 1 this year, then by the same rate as the Consumer Price Index (CPI) in 1996 and 1997. Artisans' wages will rise by 10% on July 1, then by a percentage point below CPI in the next two years. Over the same period, minimum wages will rise by 12,64%, then two years of CPI plus two percentage points.

The aim of these targets is to narrow the present wide wage differentials. A study group will also look at the long-term prospects for artisan wages. As part of the pact, the industry's two unions — the National Union of Metalworkers (Numsa) and Yster en Staal — have pledged not to make any more wage claims for the duration of this agreement.

Job security remains a key issue but unions recognise that some jobs will inevitably be lost in the course of motor industry rationalisation. Indeed, Numsa's response to the announcement of the terms of the MIDP was that it did not go far enough — acknowledging that short-term retrenchments may be necessary to achieve long-term gain.

In view of this, the new agreement includes a comprehensive retraining and support package for workers who lose their jobs. In fact, this package was included in a previous industry agreement, the difference this time, say negotiators, is that there's also a delivery mechanism to put it into practice.

Likewise, there is a new, comprehensive disputes procedure which both sides hope will reduce the risk of conflict in future.

No-one pretends the new agreement is a guarantee against conflict. But they do hope it sets the tone for a greater degree of long-term co-operation. Last year's five-week industry strike was theoretically over a 0,5%

MOTOR INDUSTRY

192

New labour pact

FM 30/6/95

Vehicle manufacturers and unions have settled on a three-year industry pact they hope will prevent the conflict that has battered the motor industry in recent years. Unlike previous agreements, which did little to lower volatile industry tempers, both sides say this one — signed in Johannesburg this week — is accompanied by a genuine commitment to make it work.

It's reassuring that for the first time in the five-year history of the industry's National Bargaining Forum (NBF), agreement has been reached before the July 1 annual implementation date. That in itself is no guarantee of success. What labour and manage-

Motor manufacturing industry signs ground-breaking deal with unions

Renee Grawitzky

(192) 30/6/95

THE motor manufacturing industry's national bargaining forum reached an agreement yesterday which laid the foundation for reshaping relations in the industry and ensuring its continued viability in the face of tariff reductions.

These sentiments were voiced by Numsa negotiator Gavin Hartford and Labour Minister Tito Mboweni at the signing of the groundbreaking agreement last night.

The agreement took three years to finalise and followed a lengthy and acrimonious

It spans the next three years and is aimed at "fostering co-operative relations between the parties".

Numsa general secretary Enoch Gondogwana said the parties came together to find a solution for themselves and did this without importing ideas from outside the country.

Cosatu general secretary Sam Shilowa appealed to employers in other industries to follow the example set.

The agreement provides for a 12,64% increase on the minimum wage this year and

a 2% increase above the rate of inflation in subsequent years. The new minimum wage for 1995 is R10,78 an hour and this will increase to a minimum of R13,66 in 1997.

Hartford said, "In the next three years the agreement guarantees that enormous strides will be made in closing the wage gap and redressing the legacy of poor education and training."

Employer negotiator George Stegmann said the agreement "provides certainty around the key issue of annual wage increases and secures a commitment to co-operatively address the critical issue of

productivity on a mutual interest basis.

"We have put in place processes to harness the key elements of education and training and related skills progression. We believe we have secured an agreement that places absolute restriction on unproductive industrial action and provides a platform for future interaction on a much more constructive basis."

The objective was "to achieve a productive and equitable collective relationship and in so doing to promote industrial stability over the lifespan of the contract", said Stegmann.

The agreement provides for:

- Closing the wage gap between semi-skilled and skilled workers and reducing the wage spread in grades;
- The enhancement of the skills base of employees and career paths up a skills and pay ladder, with provision for payment along different pay scales either for skills applied or for skills acquired;
- Mechanisms to ensure proper implementation of education and training;
- A productivity framework to provide

Continued on Page 2

Motor deal

Continued from Page 1

BD 30/6/95

(192)

guidance at plant level with additional performance award systems to be negotiated at plant level;

The introduction of work teams, new work methods and the disclosure of relevant information;

A peace clause which attempts to contain industrial action and create an envi-

ronment of peace and stability;

A clearly defined dispute resolution procedure providing for mediation and arbitration on issues arising out of the implementation of the education and training provisions and productivity; and

The establishment of a broad national motor industry bargaining council covering motor components, vehicle body building, bus building and tyre sectors.

2000
2000
2000

act includes peace clause

Historic agreement in auto industry

(192)

Star 30/6/95

BY ROY COKAYNE

A historic three-year auto manufacturing industry labour agreement — which, among other things, lays down wage policy and wage rates, productivity guidelines and contains a peace clause — has been signed in Johannesburg

It was clinched at the Auto National Bargaining Forum representing the Automobile Manufacturers Employers' Organisation (AMEO), the National Union of Metalworkers of South Africa (Numsa) and SA Yster, Staal & Verwante Nywerhede Unie (SA Iron, Steel and Allied Industries Union).

Ameo represents all the major motor manufacturers in South Africa: BMW SA, Delta, Mercedes Benz SA, Nissan SA, Samcor, Toyota SA and Volkswagen SA.

The principle agreement was agreed upon by representatives of the various parties on June 9 this year, and was subsequently endorsed by the rank and file union membership

A joint statement by the parties to the agreement said "the path-finding accord is designed to change the shape of labour relations in an industry emerging from episodes of serious

conflict in recent years"

It also promises to play an influential and precedent-setting role in the wider South African industrial relations context

Key features are.

■ It is effective for three years from July 1 this year until June 30 1998 Previous agreements were limited to one year.

■ A new wage model involving the progressive reduction in the wide spread in wages within job grades and the significant spread in wage rates between companies in the industry

■ An increase of 11% for the 1995/96 employment period and an increase matching the inflation rate in succeeding years for lower level grades Those in lower grades earning less than the target minimum for a particular grade will receive additional increases to bring them up to the specified minimum.

The majority of artisans and technicians will receive 10% this year and an amount marginally less than the inflation rate in succeeding years

■ A wage-cost stability clause in terms of which the unions have undertaken not to make any further claims in respect of substantive wage and bene-

fit on-cost items, either at industry or at plant level during the three-year lifespan of the agreement

■ Recognition that education and training are a vital element of the overall plan to increase the competitiveness of the industry. Career progression will also be based on the successful completion of adult basic education and vocational training modules, which will be developed according to an agreed timetable

■ A productivity guidance framework to facilitate initiatives in this area in a consultative, mutual interest manner

■ A proposal that the key actors in the industry consider a joint forum to deal with common concerns and to liaise with the Government The establishment of a motor industrial council is also proposed.

■ The establishment of a contract management committee to administer the ongoing implementation of provisions of the agreement Provision is also made for an autonomous mediation-arbitration process

■ A comprehensive peace obligation which restrains the parties from engaging in any industrial action in conflict with the provisions of the agreement

Motor industry proposal slammed

THE Board on Tariffs and Trade's proposals for the motor industry would force 60 component manufacturers to close, with the loss of 20 000 jobs, the National Association of Automotive and Allied Manufacturers warned yesterday (192)

Naacam president John Brandtner said government would lose R1bn in customs duty and the balance of payments situation could worsen by more than R1,5bn a year "Due to its slanted and economically dangerous approach, we believe the board no longer has any credibility." BD 11/2/95

The proposals included dropping punitive duties on components to 49% in July, with a gradual reduction to 30% by 2002

Naacam represents 160 motor parts manufacturers employing 45 000 people

Brandtner said that despite nearly two years of deliberations in the motor industry task group, where a high level of consensus was reached on an appropriate motor manufacturing industry for SA, the board had "discarded that holistic ap-

MICK COLLINS

proach" and replaced it with proposals that would lead to an elementary form of local vehicle assembly incorporating few locally made components

The proposals favoured vehicle manufacturers which preferred to scale down manufacturing operations and import fully built-up vehicles, doing away with locally manufactured components

A combination of imported cars and cars assembled locally with imported components would lead to greater fragmentation of local models, thus eroding the international competitive ability of local component producers and dashing hopes of providing affordable vehicles. Car prices would rise especially if the rand continued to weaken

Naacam would embark on a campaign to inform central government, provincial governments and trade unions about the likely effects of the proposals

Sales of new vehicles highest in 10 years

CT8/2/95

192

From ROY COKAYNE

PRETORIA. — New vehicle sales in January reflected the motor industry's bullish growth forecast for the year with new car and light commercial vehicle sales reaching their highest monthly levels in 10 years.

And the National Association of Automobile Manufacturers of South Africa (Naamsa) is anticipating a further boost for the new car sector in the months ahead.

Naamsa is expecting a substantial increase in car rental business because of the scheduled influx of tourists — largely for the Rugby World Cup — and the current high levels of business activity.

Sales of heavy trucks in January were also 83,2% or 218 units higher than the corresponding month a year ago while medium truck sales rose by 19,8% or 41 units in the same period.

Figures released by the National Association of Automobile Manufacturers of South Africa (Naamsa) revealed that new car sales in January rose 17,2% or 2/441 units to 16/661 units compared to the 14/220 unit sales in the corresponding month last year to

achieve the best overall January new car sales since 1985.

Sales in January this year were also 13,7% or 2/005 units higher than December's new car sales figure of 14/656.

New light commercial vehicles, bakkies and minibuses sales in January this year were the highest since January 1984, reaching 9/561 units — 46,1% or 3/019 units higher than the 6/542 new light commercial vehicle unit sales in January last year.

Sales of new light commercial vehicle in January this year were also 19,3% or 1/543 units higher compared to sales of 8/018 units in December last year.

Strong sales gains were also recorded in the low volume medium and heavy truck segments of the market. Sales of medium commercial vehicles in January this year totalled 248 units compared with 207 units in January last year — and were 21,6% higher than the 204 units sales in December last year.

In the heavy commercial segment, sales of 480 units achieved in January this year compared with 262 units sold in January last year and 398 units sold in December last year.

Naamsa said all commercial vehicle segments would benefit because of the increase in general economic activity levels and the higher levels of fixed investment generally because of the RDP.

The organisation remained bullish about sales prospects for the year which it said should be one of the best years for the new vehicle manufacturing and associated industries in the past decade.

All the key indicators, with the exception of the negative impact of the drought, were currently pointing in the right direction.

Moreover, the proposals for a future motor industry development programme held the promise of a real improvement in the affordability of new vehicles, however, general expectations of a lower rate of new vehicle price increases remained contingent on the value of the rand not depreciating excessively, Naamsa said.

Samcor Marketing managing director Arthur Mutlow said the performance of the commercial vehicle segment strongly indicated increased confidence and economic activity.

Mr Mutlow added that for the first time in Samcor's history, the company

had sold more than 1/000 half ton LCVs in a single month.

Nissan SA Marketing managing director Stephanus Louhser said the demand for new vehicles in January — traditionally a slow month — represented a particularly gratifying start to 1995 although not too much should be read into a single month's sales figures.

Toyota South Africa group marketing director Dr Johan van Zyl said Naamsa's sales figures for January reflected the expected trend of a market that would be investment led with the commercial vehicle setting the pace for the year.

January's sales reflect a positive situation for the total market which could see sales of 345/000 units for the year. This will give the industry its best performance since 1989, he said.

Dr van Zyl said the year had started with a continued and perhaps even more pronounced growth trend in the commercial vehicle sector led by a upsurge in fixed investment led by a sustained higher level of business confidence the underlying fundamental driving the growth in this sector. We can expect the demand for commercial vehicles will drag the whole market up a gear for the year, he said.

Best January car sales for 10 years

MARCIA KLEIN

(192)

NEW car sales — which rose a year-on-year 17,2% to 16 661 units last month — were the best January sales since 1985, the National Association of Automobile Manufacturers of SA said yesterday

January's new car sales were 13,7% higher than in December — a traditionally slow period

Naamsa said sales of light commercial vehicles, bakkies and minibuses remained exceptionally strong during January. Light commercial vehicle sales reached 9 561 units, a 46,1% rise over the previous year

Medium commercial vehicle sales rose 19,8% to 248 units, while sales of heavy trucks and buses rose a sharp 83,2% to 480 units against January 1994

Naamsa said underlying demand for new cars and commercial vehicles remained strong. The new car sector would be boosted over the next few months by an increase in car rental business for the Rugby World Cup and high levels of business activity. Commercial vehicle segments would benefit from increased economic activity and higher investment levels linked to the reconstruction and development programme

Volkswagen of SA marketing director Graham Hardy said VW's sales had increased "to within 13 units of the top spot" held by Toyota. This placed VW "on track with our objective of becoming leaders in

To Page 2

Car sales (92) BD 8/2/95

From Page 1

the passenger car market in 1995".

Toyota SA group marketing director Johan van Zyl said sales figures "reflect the expected trend of a market that will be investment led with the commercial vehicles setting the pace for the year"

January's figures indicated sales for the year could be 345 000 units — the industry's best performance since 1989. Growth in the commercial vehicle sector reflected "an upsurge in fixed investment led by a sustained higher level of business confidence". Nissan SA marketing MD Stephanus Loubser said sales were strong despite the short trading month. Nissan expected a

10% increase for the full year

Samcor marketing MD Arthur Mutlow said the industry's performance indicated increased business confidence and economic activity

Mercedes-Benz of SA commercial vehicles director Adolf Moosbauer said heavy commercial vehicle sales reflected an exceptional turnaround "This can only lend further impetus to the local automotive manufacturing industry which has reacted both timeously and positively to recent developments affecting the local content programme"

Car sales the best in 10 years ¹⁹²

9/11/85

■ BY ROY COKAYNE

New vehicle sales in January reflected the motor industry's bullish growth forecast for the year, with new car and light commercial vehicle sales reaching their highest monthly levels in 10 years

The National Association of Automobile Manufacturers of SA (Naamsa) expects a further boost for the new-car sector in the months ahead

According to Naamsa figures, new car sales in January rose 17,2 percent, or 2 441 units, to 16 661 units, compared with the 14 220 unit sales in the corresponding month last year — the best overall January new car sales since 1985.

Sales in January this year were 13,7 percent, or 2 005 units, higher than December's new car sales figure of 14 656.

New light commercial vehicle, bakkie and minibus sales in January were the highest since January 1984 at 9 561 units

This is 46,1 percent, or 3 019 units, higher than the 6 542 new light commercial vehicles sold in January last year

In the heavy commercial vehicle category, 480 units were sold, compared with 262 units a year ago

Sales of heavy trucks in January were 83,2 percent, or 218 units, higher than the corresponding month a year ago, while medium truck sales rose by 19,8 percent, or 41 units

COMPANIES

Tiger Wheels streaks ahead

INCREASED penetration of export markets and higher domestic retail sales allowed alloy wheel and tyre company Tiger Wheels to report a 71% hike in attributable income to R5,8m (R3,4m) in the six months to December. **30/14/2195 (192)**

Joint chairman and CE Eddie Keizan said the 65% rise in turnover to R111,6m reflected real growth in all operations. Margins improved, and income before interest was 77% up at R8,4m.

He said last year's motor industry strike "had no negative effect on operations". Local manufacturers became overstocked because of the strike, and the company's retail division took advantage of the buying opportunities. As a result, the interest bill rose sharply to R1,2m from R571 000. Gearing was nevertheless contained at 22% from 38% in the previous year.

A 175% hike in the company's share of associates' profit reflected a sharp in-

 **MARCIA KLEIN**

crease in the earnings of its UK and US wholesale distribution businesses.

Although bottom-line income was 71% higher than in the previous year, earnings were 45% up at 14,5c (10c) a share on additional shares in issue. In line with policy, dividends are considered only at the June year-end.

Keizan said the company was in the process of integrating Dorbyl's aluminium plants into its manufacturing division, but the full benefits would be felt only in the next financial year.

Tiger Wheels had a store network of 18 at end-December. It had since bought one store, and would establish other retail sites this year.

Tiger Wheels Holdings, which has a 70,4% stake in Tiger Wheels, reported earnings of 11,6c (8c) a share.

Motor industry 'vulnerable'

GAVIN STAFFORD

(192)

CRIME against motor industry traders has reached such "staggering proportions" that the Motor Industries' Federation has asked for to meet Police Commissioner George Fivaz to discuss the situation.

Federation executive director Vic Fourie said yesterday filling stations, parts outlets and delivery vehicles seemed to be the most vulnerable.

Members wanted to meet the commissioner to ask how dealers could protect themselves and fight back against criminals.

Cash petrol sales took place at more than 5 000 filling stations countrywide. Many operated on a 24-hour basis, which made them ideal targets for robbers, he said.

During the past few months a number of traders had been killed in incidents at their filling stations, Fourie said.

"What can we do but close at 6pm? That is not in the interest of the driving public," he said.

Delivery vehicles carrying expensive spares were another soft target, with some traders losing a vehicle a month.

Recent insurance company figures showed an average of 30 armed hijackings occurred in Johannesburg's CBD every day.

Many of the vehicles involved were delivery trucks used by parts traders, Fourie said.

BD 15/2/95

JANUARY VEHICLE SALES

Manufacturer	Cars	Number of sales	Total sales	% of total car market
Toyota	Corolla/Conquest	2 418	3 459	20,8
	Camry	1 002		
	other	39		
VW	Citi/Fox	1 706	3 446	20,7
	Golf/Jetta (new)	1 564		
	Golf/Jetta (old)	16		
	Audi	158		
	other	2		
Nissan	Sentra	1 393	2 894	17,4
	Sabre	257		
	Maxima	88		
	200SX/300ZX	2		
M-Benz	Fiat Uno	1 154	2 184	13,1
	Honda Ballade	1 192		
	M-Benz C-Class	752		
	E-Class	185		
	S-Class	39		
Samcor	other	16	1 827	11,0
	Laser/Meteor/323	1 239		
	Telstar/626	523		
Delta	other	65	1 675	10,1
	Astra/Kadett	1 675		
	Rekord	8		
BMW	Monza/Kadett	3	1 688	7,0
	Calibra	2		
	3-Series	1 029		
Subaru	5-Series	116	1 161	7,0
	7-Series	16		
	other	2		
		2	2	0
		1995	1994	% change
January		16 661	14 220	+17,2

December (14 656) to Jan +13,7

MEDIUM COMMERCIALS

	Number of sales	% of market		Number of sales	% of market
Toyota	131	52,8	Toyota	2 742	28,7
Delta	50	20,2	Nissan	2 358	24,7
Samcor	40	16,2	Samcor	2 204	23,1
Iveco	12	4,8	Delta	1 346	14,1
Nissan	10	4,0	VW	530	5,5
M-Benz	5	2,0	M-Benz (Cott)	351	3,7
			Land Rover	24	0,3

	1995	1994	% change		1995	1994	% chg
January	248	207	+19,8	January	9 561	6 542	+46,1

December (204) to Jan +21,6

HEAVY COMMERCIALS

	Number of sales	% of market		Number of sales	% of market
M-Benz	197	41,0	Toyota	6 402	23,8
Nissan	95	19,8	Nissan	5 357	19,9
Toyota	70	14,6	Samcor	4 071	15,1
MAN	40	8,3	VW	3 976	14,8
Delta	29	6,0	Delta	3 113	11,6
Tyco	25	5,2	M-Benz	2 737	10,2
Iveco	17	3,5	BMW	1 161	4,3
Erf	6	1,2	Other	133	0,5
AAD	1	0,2			

	1995	1994	% change		1995	1994	% change
January	480	262	+83,2	January	26 950	21 231	+26,9

December (398) to Jan +20,6 December (23 276) to Jan +15,8

Source: NATIONAL ASSOCIATION OF AUTOMOBILE MANUFACTURERS OF SA

While the Board on Tariffs & Trade (BTT) still hopes to produce a final workable plan in time, there is acceptance in some quarters that it may not happen

"It's not a disaster if we don't meet July 1," says a senior industry executive "Of course we would like the new plan in place by then, but it's not as if the industry will collapse if it doesn't. Government has more pressing priorities, and the existing Phase Six local content programme is working and can continue to do so after July while we still seek final agreement"

Vehicle assemblers, components manufacturers and unions are all anxious for the BTT, and ultimately government, to make an announcement as soon as possible, so the industry can make plans for its future

Long-standing uncertainty over future policy directions have hamstrung strategic planning, and several major investment programmes hinge on government's decision. However, with all the main players continuing to squabble over the BTT's published proposals, it is clear industry consensus remains a long way off. It is for this reason that there is support for relaxing the July deadline

Whether postponing a decision will make agreement any likelier, remains to be seen. John Newbury, president of the National Association of Automobile Manufacturers (Naamsa), and John Brandtner, his counterpart in the National Association of Automotive and Allied Manufacturers (Naacam), have held, and will continue, a series of meetings to seek ways of narrowing differences. Although they say common ground exists, recent statements suggest mistrust remains

In principle, the new plan will make the protected motor industry more competitive by steadily reducing tariff barriers over several years. As recent proposals are structured, however, Naacam argues many components companies will be forced to close, putting thousands of people out of work. It argues the cutting of duties will result in large-scale imports and reduce local components demand.

Considering the poor relation of the motor industry, Naacam, which in manpower terms is nearly twice the size of the vehicle manufacturing sector, says it has long advocated the need for a globally competitive industry and is prepared to forgo some business in favour of longer production runs. It lays claim to two thirds of the estimated R2,5bn exported by the auto industry last year and says it also realises some company closures are inevitable

The good news, for both sides, is that current demand for local vehicles is strong. As sales figures indicate, early 1995 demand for vehicles is well up on last year, particularly for cars. Commercial vehicle sales, though also comparatively buoyant, are expected to improve sharply after local elections, when new councils are empowered to undertake full-scale development programmes

MOTOR INDUSTRY Time to ponder

The July 1 target date for implementing a new motor industry development plan is not cast in stone, say some industry officials

T&N boosted by exports

■ BY CHARLOTTE MATHEWS

A significant increase in export turnover in 1994 took profit from engineering group T&N Holdings 20 percent higher to R29,0 million in the year to December 1994 against the same period in 1993.

While turnover grew by 17 percent to R577,2 million, exports rose by 22 percent to R93 million or 16 percent of turnover. Exports to Europe moved up by 20 percent and to Africa by 37 percent.

An extraordinary charge of R5,4 million was incurred on the sale of Butakem and the closure of the clutch division. This brought profit after extraordinary items down 11 percent to R23,6 million from 1993's R26,5 million.

On earnings of 125,9c (104,9c) a share, capitalisation shares or a final dividend of 26c (23c) was declared, bringing the total dividend to 38c (34c).

T&N Holdings chief executive Ted Waldburger said the group intends to develop expansion opportunities in new technology.

(192) slw 21/2/95

ST 26/2/95

Right-wing auto men join Numsa

By RYAN CRESSWELL

FOR years Dame Botha was a top man in the conservative whites-only Yster and Staal union in Uitenhage but he is now an outspoken member of Numsa, the most militant organisation in Cosatu.

Salaried staff at Volkswagen South Africa in Uitenhage became concerned last year after it was announced they would have to undergo assessment tests and started to seriously consider organising a proper bargaining forum

After a meeting in October, at which both unions were called on to explain their positions, far right Afrikaner auto workers have flocked to join Numsa, according to Mr Botha, a former Yster and Staal executive council member

"Numsa said their piece

at the meeting, but Yster and Staal did not because they would have had to admit that many of the workers present could not join them (192)

"I stood up and announced I was going to join Numsa. We later put it to the vote and almost everybody at the meeting, about 600 people, decided to back Numsa

"Some of those who filled in forms after that meeting were staunch rightwingers"

Numsa could not give exact figures of how many Yster and Staal members had joined because race and former union affiliations do not form part of the application form.

A Numsa spokesman said "dozens" had probably joined but an Yster and Staal member claimed only about 20 unionists had made the long walk.

192

MOTOR INDUSTRY

Going all right? FM 24/2/95

Some competitors are premature in believing Toyota's grip on the SA vehicle market is weakening, says CE Bert Wessels

Lost market share and the imminent departure of marketing MD Brand Pretorius have encouraged other companies to believe Toyota — SA market leader for more than a decade — is ripe for picking

Most rivals suggest projected gains this year will be primarily at Toyota's expense

Don't be so sure, says Wessels. While conceding that he is unhappy with some aspects of the company's performance, he insists remedies will be effective

For instance, he says Toyota's reduced market share is due more to its inability to meet demand than to competitors' performance. Months of prolonged vehicle stock shortages have left the company

unable to keep up with orders and enabled competitors to pick up sales. Reasons included a stronger-than-expected market, production disruptions in the build-up to the April 1994 general election and the prolonged industry strike later in the year.

The argument doesn't altogether stand up. Competitors also suffered from the strike and disruptions. Waiting lists for many models testify that inadequate production was a major problem for all companies.

Wessels says Toyota suffered particularly badly from additional intermittent disputes and production bottlenecks at the Durban assembly plant. As the only KwaZulu-Natal-based assembler, Toyota fell victim to the province's intense political problems and the labour issues that accompanied them. Now, with what he hopes is an improved labour relationship and heavy capital expenditure on increased capacity, he wants Toyota this year to compete without impediments.

The target is to assemble and sell at least 100 000 vehicles in 1995. If market predictions are reasonably accurate, that will translate into a domestic market share of about 28,5%, back towards previous levels.

Even allowing for the reputation of Toyota's products, competitors think that is ambitious. Having lost sales to competitors and seen traditional buying patterns altered, the company shouldn't assume it can automatically regain lost ground.

Still, Wessels looks forward to trying

"Just for once, I'd like us to be able to flex our marketing muscles with sufficient stock in hand," he says.

Toyota will do so without Pretorius, who leaves at the month-end to become CE of McCarthy Motor Holdings and executive director of McCarthy Retail. The unexpected departure of Pretorius, who was tipped to eventually become Toyota CE, will leave a huge hole in Toyota marketing.

Wessels has resisted the urge to appoint a successor from outside the company, preferring to leave Pretorius's position open for existing staff to stake a claim. Meanwhile, Wessels will take overall responsibility for integrating marketing activities.

A prime task will be to prevent erosion of the company's air of invincibility. For whatever reason, each time competitors close the gap on Toyota — for instance, VW car sales in January were barely a dozen behind — it chips away at the company's previously impregnable image.

Wessels counters that market leadership is only

part of the image formula but adds "Public perceptions are important. We have to make sure the image of the company remains strong."



Toyota's Wessels flexing marketing muscles

TIGER WHEELS
In higher gear

192
 FM 6/1/95

Activities: Makes and distributes aluminium alloy wheels, distributes high performance tyres and vehicle body parts.

Control: Directors (65,6% of pyramid Tiger Wheels Holdings)

Joint Chairmen: E L Keizan & M B Glatt

Capital structure: 37,8m ords Market capitalisation R161m

Share market: Price 425c Yields 2,4% on dividend, 6,1% on earnings, p/e ratio, 16,3, cover, 2,6 12-month high, 450c, low, 130c Trading volume last quarter, 108 000 shares

Year to June 30	'91	'92	'93	'94
ST debt (Rm)	1,1	1,0	1,9	2,2
LT debt (Rm)	6,5	5,5	4,6	5,5
Debt:equity ratio	0,55	0,34	0,15	0,18
Shareholders' interest	0,40	0,45	0,47	0,46
Int & leasing cover	2,5	3,5	5,4	13,3
Return on cap (%)	11,6	15,4	13,6	16,2
Turnover (Rm)	64	87	104	156
Pre-int profit (Rm)	4,0	6,4	6,8	13,2
Pre-int margin (%)	6,2	7,3	6,5	8,4
Earnings (c)	6,3	12,5	15,6	26,0
Dividends (c)	3	5	6	10
Tangible NAV (c)	48	60	71	98

Most people complain when they have to replace their car's tyres but it's these grudge purchases that provide the profits for Tiger Wheels (TiWheel). Turnover last year jumped 50%, earnings by two-thirds and more than R8m cash was generated after R3m was absorbed in 1993.

At 26c, EPS are now more than double the 12,2c posted in 1990, which was followed by a slump to 6,3c.

Joint chairman Eddie Keizan is proud of the latest achievement but does not see it as a quantum leap. "We have been building the group for many years and did not do anything out of the ordinary during the year to achieve the results."

He adds that TiWheel did not stop spending during the recession. Neither did

Tiger Wheels

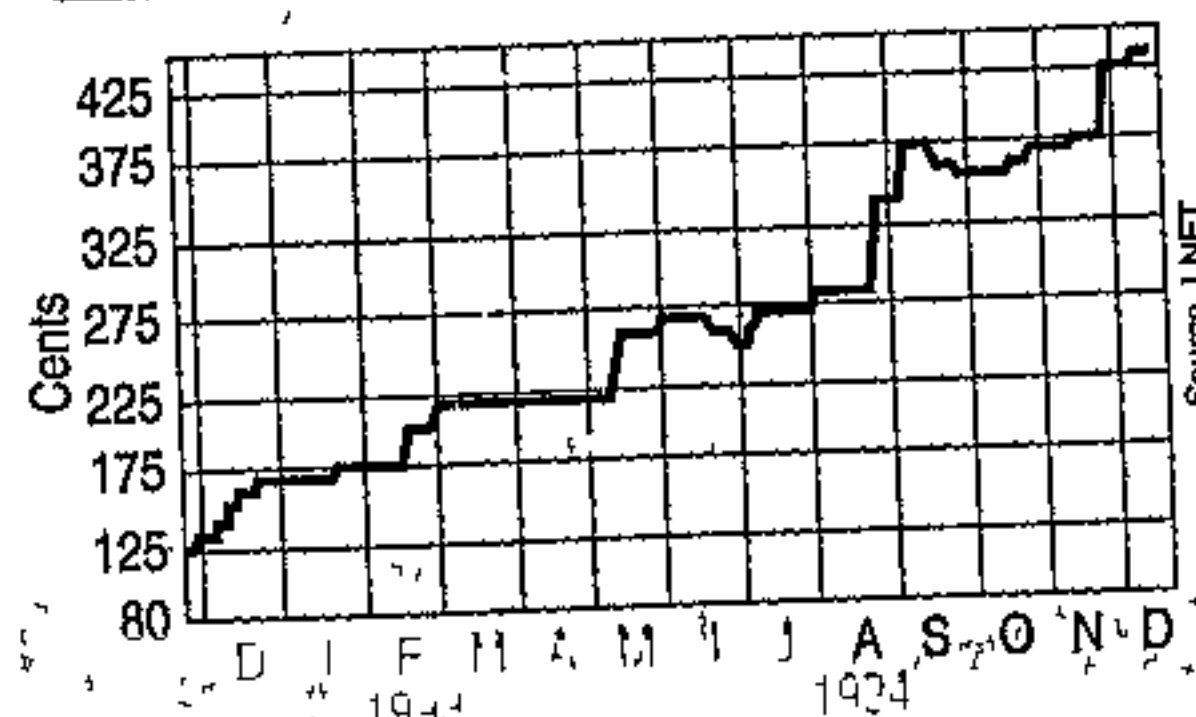

it change its niche business of distributing high-performance tyres and alloy wheels. As market share has increased, so too has customer awareness of brand names. This has made it a lot easier to open new stores and now they become profitable within a month or two of opening.

"We don't have an agenda whereby X number of stores must be opened annually," says Keizan. "The staff has to be trained first and this determines store numbers."

This conservatism has also ensured the balance sheet remains sound, gearing is only 18%. Most of the debt is medium term, financing equipment for the manufacturing division. In May, this division acquired Dorbyl's alloy wheel manufacturing business, which should increase overall production by about 50% this year. The deal was funded by the issue of 2m shares at R2,20 each and R8,6m cash.

In 1987, when TiWheel listed, the Wholesale division was the dominant activity. It was the distributor of Yokohama high-performance passenger tyres and aluminium wheels. Because of the growth of the TiWheel retail stores, with the relative decline of Yokohama passenger car tyres (owing to price and import control constraints), and the rapid expansion of TiWheel's manufacturing division, Wholesale merged with Manufacturing last year. This required a move to larger premises to accommodate higher sales. "Growth depends on the increase in volumes and

economies of scale, the ability to buy raw materials at world market prices and the value of the rand," says Keizan.

The share price more than quadrupled during 1994 — a boon for the directors, who hold more than 60%. Given the increased output after the Dorbyl purchase, earnings could grow strongly in 1995. The 16,3 p/e seems undemanding.

Kate Rushton

Dorbyl prospects greatly improved

(192)
star 11/1/95

■ BY CHARLOTTE MATHEWS

The prospects for Dorbyl's 1994/95 trading year are much improved because restructuring has placed it in a sound financial position, says chairman Joop de Loor said in the annual report.

Automotive products expects to lift profit over 1994 because of the modernisation of equipment and the expected weaker rand, which should help exports

Transport products has higher order levels than in the previous year and expects production capacity in the bus and commercial vehicle divisions will be fully utilised. The profitability of Dorfin, the finance company, should improve noticeably as it has now made adequate bad debt provision.

Light and general engineering is well placed to take advantage of state spending on community upliftment programmes, especially in water supply

'Stewarts & Lloyds' prospects for 1994/95 are excellent. It has 28 branches, mostly in rural areas, which supply water-handling equipment. The prospect of large-scale

spending on water reticulation is a key element of the RDP and, with the prospect of an end to the drought, demand from the agricultural sector should revive.

Baldwins Steel forecasts growth in demand, but no major changes in demand patterns. The direction of the automotive industry is of critical importance

Structural engineering plans to focus more on repair and refurbishment projects on sites in SA and neighbouring countries and is already well established in those markets.

Most of Dorbyl's heavy engineering's operations have good order books and will focus on expanding exports for roll works, ringrollers and gas-tainers.

Dorbyl marine should benefit from strong demand for dry-docking and repairs.

It should return to profitability in 1995 since non-recurring items have been fully written off and the contract with Cabinda Gulf Oil for two shallow-water offshore production platforms has been given the go-ahead.

Dorbyl properties is restructuring so that only strategic properties will be held by the end of the 1995 financial year.

UNIVERSITY OF CAPE TOWN
SALORU LIBRARY

The Argus

Car prices may go up as imports loophole is closed

ARG 13/1/95 192

HENRI du PLESSIS
Motoring Reporter

THE government is set to close a loophole in motor industry regulations which has allowed imported cars to be brought in to South Africa at competitive prices

This is expected to affect the popular Hyundai range of Korean cars as well as more expensive models such as BMW's M3s and Cabriolets — and prices are expected to rise as a result.

From July, manufacturers who were importing cars under the semi-knocked down definition will have to meet new requirements or face punitive tariffs, says a motor industry source.

This coincides with a general reduction in tariffs — from 80 to 65 percent — on completely built up imports in line with international tariff agreements

While most manufacturers made use of the loophole to bring more expensive vehicles onto the South African market at competitive prices, Hyundai based its

whole operation on it, believing that the international General Agreement on Tariffs and Trade (GATT) would ensure its future business security here.

Sources in the industry say Toyota South Africa led the campaign to have the loophole blocked because the company had lost a considerable percentage of sales to the new Korean range.

But all local manufacturers are expected to welcome the step as they have to conform to a required minimum of local content and heavy tariffs on imported parts and products

Until now, Hyundai has escaped heavy tariffs by importing semi-knocked down cars into Botswana, assembling them there and bringing them into South Africa on the back of the Southern African Customs Union agreement, which includes a tariff exemption on products from certain neighbouring states.

Hyundai could not be reached for comment.



Daimler-Benz has plans for SA

From LINDA ENSOR

STUTTGART. — The multibillion Daimler-Benz group is to strengthen its position in the SA market, the group's chief financial officer, Dr Gerhard Liener announced yesterday.

The group, which is involved in the manufacture of luxury passenger and commercial vehicles, aircraft, micro electronic goods, diesel engines and space and rail systems, produces Mercedes Benzes in SA.

Yesterday Liener and top Daimler-Benz executives — including president of its SA subsidiary, Christopher Kopke — met Deputy President Thabo Mbeki.

Liener said Daimler-Benz intended to invest in fields such as aircraft manufacture and space and rail systems in SA.

Daimler Benz Aerospace has a significant stake in the manufacture of the Airbus, the production of which involves a great deal of global outsourcing of component production. SA could become involved in

CT 16/1/95 (192)
this and could also participate in the production of Daimler-Benz's Fokker and Dornier aircraft

Furthermore, Liener added, there was scope for Daimler-Benz to produce satellites in SA as it was doing in a joint venture with the Chinese. "We can build and operate the satellites together," he said

There was also a need for SA to install a high-speed rail system, for which the group has the technology.

Last November Mercedes Benz SA announced the production of a Mitsubishi pickup in East London and this year will begin the production and marketing of initially 8 000 units of this model

● Meanwhile, German motor manufacturer, BMW was reported to have told the SA government that if it embarked on a clear and acceptable industrial and trade policy by the end of 1994 and the unions behaved responsibly, BMW might expand its plant involving hundreds of billions of rand in investment. If not, BMW would consider closing its plant in Pretoria.

Daimler-Benz aims to reinforce SA presence

STUTT GART — The Daimler-Benz group would strengthen its position in the SA market and diversify its activities, the group's chief financial officer, Gerhard Liener, announced on Friday

The group, which is involved in the manufacture of luxury passenger and commercial vehicles, aircraft, micro-electronic goods, diesel engines and space and rail systems, presently produces Mercedes Benzes in SA

And in a separate development, chemical giant Hoechst is soon to announce a major investment in SA

Liener said at a news conference after he and top Daimler-Benz executives had met SA Deputy President Thabo Mbeki, that the group intended to invest in fields such as aircraft manufacture and space and rail systems in SA

Daimler-Benz Aerospace has a significant stake in the manufacture of the Airbus, the production of which involves a great deal of global outsourcing SA could become involved in this and could participate in the production of Daimler-Benz's Fokker and Dornier aircraft

He said there was also scope for Daimler-Benz to produce satellites in SA There was also a need for SA to install a

LINDA ENSOR

high-speed rail system, a field in which the group had the technology and expertise.

During their discussions with Mbeki the group's executives explained the current and planned investment programmes of the group in SA Mbeki later met representatives of companies in the state of Baden-Wurtemberg which either had existing operations in SA or were planning future investments.

Last November Mercedes-Benz SA announced the production of a Mitsubishi pickup in East London, and an initial 8 000 units will be produced and marketed exclusively for the SA market this year

Meanwhile, another German motor manufacturer, BMW, was reported to have put a clear choice to the SA government and trade unions last year

BMW chairman Bernd Pischotsrieder said that if government decided on a clear and acceptable industrial and trade policy by the end of 1994 and unions behaved responsibly, BMW might expand its plant considerably to world scale. This would mean billions of rands in investment

But if not, BMW would consider closing its plant in Pretoria

Government plan believed to threaten 20 000 jobs

Car parts makers fear worst

span 26/1/95 (192)

BY DES PARKER

Car parts manufacturers are petitioning the government to overhaul a Board of Tariffs and Trade (Bot) plan they believe threatens to put the slids under thousands of jobs

They reckon as many as 20 000 of the 44 000 employees in their plants could be driven out of work if, as they fear, the Bot proposals result in a 40 percent reduction in business

In Durban, car parts factories, which employ 10 000 to 12 000, that could mean as many as 4 000 out of work, says National Association of Component and Allied Manufacturers (Naacam) president John Brandtner

National Association of Automobile Manufacturers (Naamsa) executive director Nico Vermeulen, however, reckons Naacam is crying wolf

"They are clamouring for increased protection because they have not been able to reconcile themselves to the fact it's going to be a much more competitive market and they will need to be-

come more cost-effective and efficient," he says

Both groups are making the Bot's deadline for written submissions on the plan, which flowed from the motor industry trade group (MITG) recommendations last year to modify the vehicle industry, among other things, to bring it in line with international trade rules

Brandtner feels little account will be taken of Naacam The organisation and the National Union of Metalworkers (Numsa) have a meeting with Trade and Industry Minister Trevor Manuel to air their concerns

He maintains Naamsa has gained the ear of the Bot, leaving parts makers and unions in line to make sacrifices that will enable motor assemblers to rationalise at a more sedate pace to meet oncoming competition

Naacam would like to see an accelerated reduction in the 30-odd different models of car made in SA to achieve economies of scale

Currently, fewer than 8 000 cars, on average, in each range

are produced every year

But it sees little prospect for this, with assemblers, in terms of the Bot proposals, able to import duty-free components to the value of 35 percent of the wholesale price of their vehicles

Under the existing Phase Six of the local content programme, car companies have to qualify for duty-free status by incorporating a minimum level of locally made components in vehicles

The new rules, Brandtner claims, would allow assemblers to shelter behind protection levels equivalent to 350 percent, while continuing to produce short runs of specialised, expensive vehicles using greater quantities of imported parts

"It won't mean cheaper locally made vehicles or job maintenance. It's a very consumer-unfriendly concept," he claims

Naacam wants the Bot to revert to MITG's original proposal to phase out the local content requirement over 3½ years to give component-makers time to adjust to reduced tariffs

This, they say, should force the assemblers to opt for longer runs of lower-priced models, while upper-end cars no longer made locally would be supplied by imports. Prices would be kept down by lower import tariffs

From July, duties on complete knocked-down (CKD) component kits will go to 49 percent, reducing to 30 percent over the next 6½ years

Tariffs on finished cars — already down from an effective 115 percent at 80 percent — will be lowered to 65 percent and eventually to 40 percent by 2002

Naacam expects that an additional R1.5 billion-worth of imported components a year would enter the country if the incentive to use local parts went. That, in effect, could wipe out 40 percent of its members' turnover

Translated into jobs, they say it means unemployment for two out of five workers

"We accept that high duty protection has to go for local industries to make their way in the world, and we welcome it

But for our companies to have the base they need to export, we need a strong local supply industry, not one that is shrinking"

Vermeulen says a cheque written in Naacam has the wrong end of the stick. Assembly plants will not abandon their local suppliers and the Bot programme has to be seen in its entirety

"Naacam wants manufacturers overnight to halve their model ranges. This is unrealistic, the companies have big investments in tooling and employees working on specialised lines. They cannot just write them off before the end of their useful life"

The Bot development programme envisages manufacturers moving to bigger runs of less specialised vehicles over time as they supplement lost models with increased exports

BMW has said it is to concentrate on the 3-series — 500 of which have already been sold to Australia — and it could become the German parent's producer of right-hand drive vehicles for markets worldwide

Audi finalising major investment in new model

AUDI was finalising a major investment project to produce a high volume model to increase market share in the face of the Board on Tariffs and Trade's recommendations to restructure the motor industry

Newly appointed MD Heinrich Holtmann said last night the A4 model would be produced at Audi's Uitenhage plant in the final quarter of this year. He saw the "very aggressive production and sales targets" for the high-volume A4 leading to a four- or five-fold increase in Audi sales in SA in the space of two years.

The weakening rand, price increases, recession and perks tax had led to "a progressive buy-down trend in the luxury car market", Holtmann said

MARCIA KLEIN

In the executive car market, in particular, there had been a repositioning — first by BMW, with its 3 Series, and recently by Mercedes-Benz, with its new C-class. Sales of more than 1 000 units a month were being achieved by both marques.

These developments had been noted with interest by Audi's sister company in Ingolstadt and its local marketing team AD 2/11/95

Audi's dealer network would also be restructured. This would include establishing more dedicated Audi centres

The full extent of the German partner's involvement would be announced in the next few months.

Holtmann said "With the Board on Tariffs and Trade recommendations steaming ahead, time is not on our side — our main objective is to ensure that we build more cars and increase our market share in SA"

Audi's daily vehicle production schedule would be increased and standards of quality would be improved (A2)

"The long-term vision of Audi AG is to make Audi the most attractive European car on world markets"

Audi was well on its way towards achieving this position in many markets, and this vision was part of the reason for the interest and accelerated drive into the SA market, Holtmann said

VW to invest R45-m in new assembly line

HENRI DU PLESSIS
Motoring Reporter

VOLKSWAGEN South Africa is to invest R45 million in an assembly line for a brand new Audi product in Uitenhage

This was announced by Volkswagen marketing-director Graham Hardy at a Press conference in Johannesburg yesterday

He said the investment would prevent the company from retrenching workers who are at present involved in a Volkswagen SA export project to China. This programme ends later this year.

Also unveiled earlier yesterday were the two Audi touring car racers to be campaigned in the growing AA Fleet Care touring car championships.

At the Press conference Mr Hardy introduced Audi and Volkswagen's new managing-director in South Africa, Heinrich Holtmann, who took over from Peter Searle three weeks ago.

(192) ARG 27/1/95

Dr Holtmann said the new Audi car, the Audi A4, was a small saloon which would compete with the BMW Three Series and would contain about 50 percent local content.

Many of the car's parts would be imported in a complete knocked-down (CKD) form and assembled at Uitenhage.

The factory would also manufacture Audi A4 parts for export to Germany. This assembly line would take the place of the presently very low volume Audi A6 assembly line and should produce at a far greater volume.

Dr Holtmann said the Audi A6 would be retained in the model line-up for this country together with a variety of upper market exotics on import as completely built-up units.

Mr Hardy said the A4's market would, however, mainly come from market share captured from Japanese manufacturers.

Motor industry row goes on

ED 271195 (192)

ERICA JANKOWITZ

THE simmering dispute between the National Union of Metalworkers of SA (Numsa) and the SA Motor Industry Employers' Association on the future of the motor industrial council was not resolved yesterday.

Numsa general secretary Enoch Godongwana said the union was disappointed at the association's apparent reluctance to discuss wages, as workers had not received wage increases since December 1991.

Garage attendants were among the most poorly paid workers in the country with some in rural areas receiving a weekly wage of R79,95. In urban areas, wages averaged R122,50 for a 45-hour working week.

The association was taking advantage of the unions' lack of organisation in the sector, which included garages and panel beating shops, he said. And, instead of driving a wedge between representative unions, employers had "unwittingly" brought Numsa and the Motor Industry Staff Association and the Motor Industry

Employees' Union closer together.

These unions were previously divided along political and racial lines, but they had now joined forces in calling for the intervention of the Labour Ministry to prevent the collapse of the industrial council, Godongwana said.

Negotiations, which broke down last year, were resumed only after Numsa agreed to relax the closed shop arrangement in the industry.

The unions had opened with a wage demand of 35% to which the employers responded with a 10% offer for petrol attendants and 16% to 18% for other workers.

Godongwana said although this was too low, in the past employers had refused to make any wage offer. After report-back meetings, the parties had met for further talks.

Association general secretary Vic Fourie was not available for comment yesterday.

MANUFACTURING - MOTOR INDUSTRY

1995

SEPT. — DEC.

1

TOYOTA *FM 1/9/95* (192)
Up to cruising speed

Despite the odd rumbling from analysts who suspect this streak can't last, Toyota continues to perform well enough. Turnover for the six months to end-June jumped nearly 40% to R3,13bn from the year-ago interim period on a 16,4% increase in retail sales volumes to 46 604 units.

In contrast with the rise in absolute numbers, market share declined marginally to 25,2% (27,1%) as the total retail market boomed. Executive chairman Bert Wessels predicts the current recovery will be sustained into the 1996 financial year.

Toyota takes the greater part of its market share from the upper-small, medium and medium-executive passenger segments, with Lexus providing a small presence in the top-luxury end.

Expansion at cut-price, entry-level boosted overall market size as competitors introduced basic models at low cost.

"Toyota does not have an entry-level model," says group finance director Peter Robinson. He estimates the segment at roughly 10% of the total passenger car market, a substantial prize for any manufacturer but is concerned that any activity by Toyota in this market may eat into its low-mileage, second-hand vehicle sales.

Attributable profit hit R53,6m but steep rises in interest (R44,6m) and tax — up 88% to R37,1m — held growth in net income to 21%. Operating margins ticked up to 4,3% (4,2%) — acceptable in a recovering market but in line for strong revision in the longer term. Of the second half, Robinson says "We expect it to be better than the first half."

Higher debt and fixed assets in the balance sheet reflect larger stock volumes — normal for this time of year, even though a week of production was lost. Also, stock costs are up because of the ever-strengthening yen, which raises the price of imported components. These items now make up 40%-50% of total content.

Management regularly evaluates the feasibility of manufacturing more parts locally

but volume production is a limiting factor. Tariffs on imported parts will decline, cutting costs of locally made vehicles. Robinson expects to see "a price reduction in real terms" in the next few years.

The group is in good financial health, with gearing comfortable at about 29% (25%). It needs to ensure that it remains in fighting shape for the battles it will undoubtedly face soon. Capex invested in the next two to three years to re-engineer some older models will position Toyota well for the fray. Robinson won't mention names but acknowledges that "most people suspect one will be the Corolla" — still the best-seller in the line.

At R24,25, the share is close to its annual high.

Margaret Anne Halse

CRUISING HIGH

Six months to	Jun 30 1994	Dec 31 1994	Jun 30 1995
Turnover (Rbn)	2,25	2,68	3,13
Operating income (Rm)	63,5	119,5	88,5
Attributable (Rm)	44,3	67,6	53,6
Earnings (c)	108,9	166,2	131,8
Dividends (c)	20	30	24

Entry-level vehicle price war takes a new turn

CT(P2R) 4/9/95 (192)

By ROY COKAYNE

PRETORIA BUSINESS EDITOR

The price war at the entry level of the motor vehicle market has taken a new turn with Nissan South Africa launching financial packages to reduce the cost of owning a Sentra, Uno and 1400 bakkie

Branded "The Nissan Affordability Plan", the firm said it had negotiated the innovative packages as part of its "ongoing efforts to make motoring as affordable as possible"

The new packages are in line with forecasts made by Stephanus Loubser, the managing director of Nissan SA Marketing, at the Afrikaanse Handelsinstituut Motor and Transport Congress last week

Loubser predicted there would be more affordable vehicles in the future because more suppliers would simply have to focus on price in a small and slow growing market — and the present price war in the market was a sign of the restructuring taking place in the motor industry

As pressure for more affordable vehicles increases, the profit margins of dealers will

decrease and many dealers would not be able to survive. By the year 2000, dealers' profits will be derived from parts and service and not from new vehicles," he said

Nissan SA said the new packages had resulted in the Uno Fire 1100 and 1400 bakkie becoming the lowest monthly-cost-to-purchase vehicles in their sectors of the South African market. In terms of the new package, the Uno Fire 1100 can now be purchased at a monthly cost of R399 including VAT

For the past few months Nissan has offered a similar financial package to its customers which permitted them to own an Uno 1100 Fire for R449 a month including VAT

The company said it had now managed to reduce the cost even further. Nissan has also extended the financial plan to include the 1400 bakkie and its Sentra 140. Nissan said its 1400 bakkie was now the cheapest light commercial vehicle on the local market

John Jessup, marketing director of Nissan South Africa Marketing, said these financial plans had been negotiated to give its customers the most affordable motoring possible, especially at entry level

Volkswagen SA sales hit record high

(192) CT (PR) 5/9/98

BY ROY COKAYNE

PRETORIA BUSINESS EDITOR

Volkswagen SA is rewriting its own record book

In August it set a new record for the number of cars sold to dealers in a single month — and for new wholesale sales figures for third-generation Golf and Jetta models

Graham Hardy, the marketing director for Volkswagen SA, said wholesale deliveries totalled 7 270 in August

He said this figure excluded 933 vehicles which were part of the final shipments of Volkswagen SA's export contract to China.

Wholesale sales figures for the third-generation Golf model totalled 1 080 and 1 611 for the Jetta model — both record highs.

Demand

In anticipation of strong customer demand for the recently launched A4 model range, Audi wholesale figures of 748 units for August were the highest since January 1984.

Hardy said the record wholesale figures would have a positive effect on Volkswagen SA's August market share. The retail figures are due out tomorrow.

Last year, the company delivered an average of 3 382 vehicles a month to its dealer network

In contrast, an average of 4 960 units a month has been achieved this year — a productivity improvement of 41 percent

"Our goal is to become world class in the next year or two in terms of productivity, cost and quality in order that the company can withstand the onslaught of global competition in this market as well as becoming a reliable partner in the Volkswagen group's global business plan," he said

Improved sales of cars expected

(192)
John Dlodlu

BD 5/9/95
SA CAR makers expressed cautious optimism yesterday that the industry would experience a rise in its monthly sales data for August, expected this week

Vehicle sales, compiled by the National Association of Automobile Manufacturers of SA, showed a month-on-month downward trend since June. In July total sales were 5,6% down at 30 418 compared with June. But the figures were better when compared with last year's sales.

Delta sales director John Cum-
ing said he expected the August figure to be marginally up on July's figure.

Mercedes-Benz SA passenger cars marketing manager Eric Scoble said he expected August sales for the passenger sector to reach 20 000. In July 18 676 passenger cars were sold against last year's figure of 16 937. However, the figure was down compared with June, when 19 781 vehicles were bought.

Scoble attributed his optimism to the continued strength of the economy and the car market. "(Car) prices have not increased that much, thanks to the price war in the bottom end of the market."

Econometrix director and leading motor industry analyst Tony Twine was also upbeat.

Volkswagen SA produced a record 7 075 vehicles at its Uitenhage plant last month.

VW SA also wholesaled a record 7 270 cars to its dealer network during August, compared with the monthly average for last year of 3 914 cars, the company said.

Tiger Wheels earnings race ahead (192)

By ANDY DUFFY

STAFF WRITER

Tiger Wheels lifted attributable earnings 55 percent to R14,5 million for the year to June, propelled by strong export sales which forced it to farm out production overseas

Sales rose 53 percent to R238,6 million, with more than half drawn from abroad, while operating income rose 58 percent to R21 million.

Higher interest charges and tax left net income ahead 59 percent at R14 million

Lower associate income and a larger share base left share earnings up 38 percent at 36c

The dividend was set 40 percent higher at 14c. The company is also offering a scrip alternative

Eddie Keizan, the chief executive and joint chairman, pinned the performance on thriving overseas sales for its TSW alloy wheels

The company was looking for further earnings growth this year

But Tiger Wheels had been unable to meet demand for TSW alloy wheels from its own factories, prompting it to allow their production under licence overseas

The Babelegi plant had lifted profit, though this was dampened by losses at the Elandsfontein plant bought from Dorbyl last year

CT(BR) 7/9/95

Automakers shares well priced

ST (BT) 10/9/95

(192)

By JULIE WALKER

SHARES in Automakers, the holding company of the SA operations of Nissan and Fiat, have been attractively priced and at 500c a share are a bargain for private investors

Automakers will be listed on the JSE on October 24. Sanlam's investment arm Sankorp, which owns Automakers, will reduce its holding to 55% after the listing. Financial institutions and the public will have 24%, with 25-million shares being offered to the public.

Management and staff right down

to the shopfloor have been offered 8% and the balance has been placed with investors to be announced shortly. Automakers will raise R125-million of new capital in the issue.

The issue price was arrived at after scrutiny of the forward price-earnings ratios of listed automobile manufacturers in Europe and the US. The average p/e for 1996 is 7,3, making Automakers, at only 5,7 times the

expected forward earnings of the company, a bargain.

John Newbury, chief executive of Automakers, says South Africa's motor industry can still be competitive despite relaxed import tariffs.

The group is currently making 320 vehicles daily, with installed capacity for 450. It has the second-largest share of the vehicle market at 17,2%. Toyota has 24,8%, and Mr Newbury says that the gap between the two has narrowed from 19 percentage points 10 years ago.

Bearing Man now 'at the forefront'

BY JOHN SPIRA

GAUTENG BUSINESS EDITOR

Real earnings growth is planned for Bearing Man in the year to June next year

In his annual report to shareholders, chairman David Royston said since the acquisition of the bearing business of Steelmetals in 1991, Bearing Man had grown faster than was envisaged

"Growth rates of about 50 percent a year are not sustainable over the long term. This growth has, however, placed the group at the forefront of its industry"

From this dominant position, and given plans for further geographic and product expansion, together with improved efficiencies expected from the group's warehousing and management information systems, Royston was looking for real earnings growth in 1995/96

Over the past three years, Bearing Man had achieved a 50 percent a year compound rate of growth in earnings a share, 43 percent growth in dividends a share and 27 percent in turnover

Bearing Man's rights issue in March this year, which raised R24,3 million, had helped bring the debt-equity ratio down to 10 percent from 24 percent a year ago

Royston said borrowings were at a level "which will allow continued growth and expansion in the medium term without exceeding prudent debt levels"

Bearing Man's share-price performance reflects its huge earnings gains of recent years. From 500c in 1993, the shares have galloped up to 3750c, at which level they yield 2,3 percent and offer a price-earnings multiple of 16,7

Bearing Man, 55,4 percent owned by Anglovaal Holdings, distributes a comprehensive range of ball and roller bearings

Japan boosts SA motor industry

CT (BR) 14/9/95

(211)

(192)

By ROY COKAYNE

PRETORIA BUSINESS EDITOR

Two Japanese companies, Nissan Diesel and Mitsui, have invested a total of R112,5 million in Automakers, the holding company of Nissan South Africa, which is scheduled to be listed on the JSE at the end of next month.

Nissan Diesel has invested R37,5 million and Mitsui R75 million in Automakers, the first investment by Japanese companies in the South African motor industry and one of the few direct Japanese investments in South Africa.

John Newbury, the chief executive of Automakers, said the companies' investment would give them a 12,9 percent shareholding in Automakers — 4,3 percent to Nissan Diesel and the balance to Mitsui.

Newbury said Mitsui would also be represented on Automakers' board, membership of which had been set at 7,5 percent of the shareholding.

He said the investment was made through Nissan Diesel because Nissan Motor Company had just gone through a major restructuring. But he said he hoped Nissan Motor Corporation would invest in the future, and possibly Sankorp could release a piece of its shareholding in Automakers to Nissan.

Mitsui's investment is the second by the group in South Africa. It recently announced it was investing in South Africa's ferrous raw material industry through Consolidated Metallurgical Industries.

Sankorp will reduce its investment in Automakers from 100 to 55 percent in order to reduce its shareholding from absolute to effective control.

The 45 percent balance will be held after the listing by a mix of institutions, including Nissan Diesel and Mitsui, the public and staff, who will acquire their shares through a private placing and preferential and public offerings.

The prospectus for the preferential and public offerings is due for release at the end of this month. Newbury said the listing would



IN JOVIAL MOOD John Newbury, Automakers' chief executive

PHOTO JOHN WOODROOF

raise R244 million, of which R125 million would go into Automakers. The remainder was to run down Sankorp's shareholding.

He said 180 million shares would be listed at an issue price of 500c a share.

Nissan Diesel, one of the world's leading manufacturers of trucks, buses, engine, and special purpose vehicles and 40 percent owned by

Nissan Motor Company, is listed on the Tokyo Stock Exchange and has a market capitalisation of about \$1 billion. Automakers has the exclusive rights in South Africa to manufacture and sell Nissan Diesel's range of medium and heavy commercial vehicles.

Mitsui is one of Japan's giant trading houses and had a turnover of \$195,8 billion in its financial year

ems
ture

ms
uld

her
aid

is
ic-

n
a
n

na-
y

an-

nd
r/s

r-
d

0,1

R112,5m investment in Automakers

Michael Urquhart

~~745~~ (192) ~~66~~
BD 14/9/94
JAPANESE industrial giant Mitsui Corporation and motor group Nissan Diesel would invest R112,5m for a 13% stake in soon-to-be-listed SA motor manufacturer Automakers, Automakers announced yesterday

As part of the new structure of the group, which is the holding company for Nissan SA, investment group

Sankorp would reduce its stake in Automakers from 100% to 55%

Nissan Diesel would be investing R37,5m, giving it a 4,3% stake in Automakers, while Mitsui would be investing R75m.

Automakers CE John Newbury said the listing of the group, on October 24, would raise about R224m. Of this,

Continued on Page 2

Automakers

Continued from Page 1

R125m would go into the company, and the remainder would be used to reduce the holding of Sankorp

He said Nissan Motor Corporation in Japan had not been able to take a stake in Nissan SA, as it was busy cutting back its operations in Japan and it would not like to make an offshore in-

vestment at the same time. But further Sankorp equity could be released at a later date to give the Japanese motor-ing giant a stake in Nissan SA, he said

The unions and workforce would be encouraged to take a stake in Automakers, with an assisted issue to staff members down to shop-floor level

Newbury said the investments by the two Japanese groups gave Nissan SA strong international partners as it moved into the next phase of domestic growth and expanded internationally

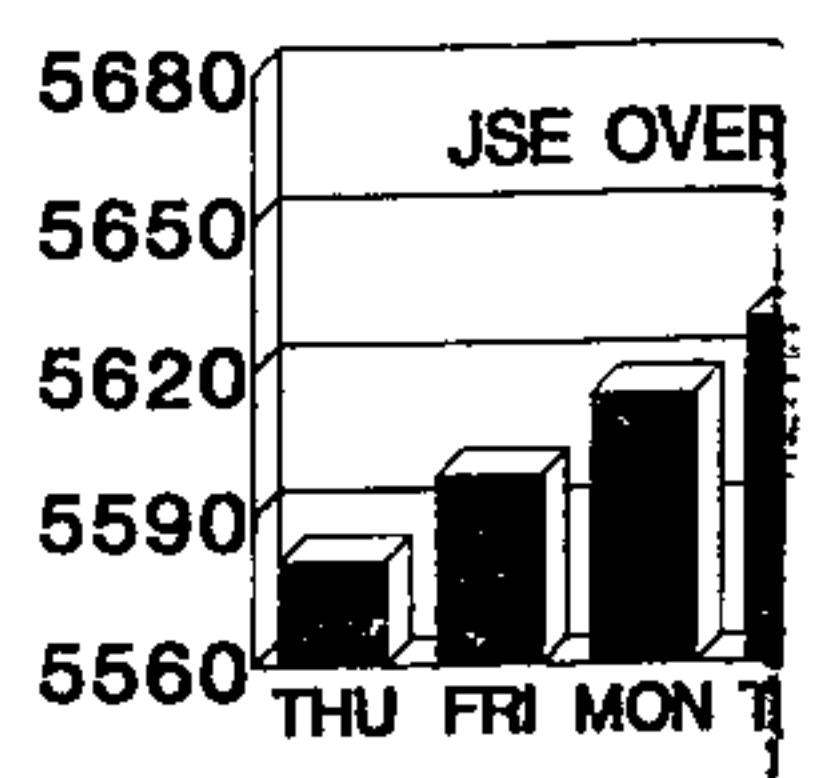

Japanese boost for South African motor industry

(192) Star 14/9/95

■ BY ROY COKAYNE

Two Japanese companies, Nissan Diesel and Mitsui, have invested a total of R112,5 million in Automakers, the holding company of Nissan South Africa, which is scheduled to be listed on the JSE at the end of next month

Nissan Diesel has invested R37,5 million and Mitsui R75 million in Automakers, the first investment by Japanese companies in the South African motor industry and one of the few direct Japanese investments in South Africa.

John Newbury, the chief executive of Automakers, said the companies' investment would give them a 12,9 percent shareholding in Automakers — 4,3 percent to Nissan Diesel

and the balance to Mitsui. Newbury said that Mitsui would also be represented on the board of Automakers, membership of which had been set at 7,5 percent of the shareholding

Restructuring

He said the investment was made through Nissan Diesel because Nissan Motor Company had just gone through a major restructuring

But he said he hoped Nissan Motor Corporation would invest in the future, and possibly Sankorp could release a piece of its shareholding in Automakers to Nissan

Mitsui's investment is the second by the group in South Africa. It recently announced it was investing in South Africa's

ferrous raw material industry through Consolidated Metallurgical Industries

Sankorp will reduce its investment in Automakers from 100 to 55 percent in order to reduce its shareholding from absolute to effective control

The 45 percent balance will be held after the listing by a mix of institutions, including Nissan Diesel and Mitsui, the public and staff, who will acquire their shares through a private placing and preferential and public offerings

Prospectus

The prospectus for the preferential and public offerings is due for release at the end of this month. Newbury said that the listing would raise R244 million, of which

R125 million would go into Automakers.

The remainder was to run down Sankorp's shareholding.

He said 180 million shares would be listed at an issue price of 500c a share

Nissan Diesel is one of the world's leading manufacturers of trucks, buses, engines and special purpose vehicles and 40 percent owned by Nissan Motor Company, is listed on the Tokyo Stock Exchange and has a market capitalisation of about \$1 billion.

Automakers has the exclusive rights in South Africa to manufacture and sell Nissan Diesel's range of medium and heavy commercial vehicles

Mitsui is one of Japan's giant trading houses and had a turnover of \$195,8 billion in its financial year.

IN BUSINESS

TIGER WHEELS ~~(196)~~ (192)

Worth the ride

PM 15/9/95
For those who believe large and diversified is the only way to go, think again Tiger Wheels (Tiwheel) is the perfect example of a company which makes one product — aluminium wheels for passenger vehicles — and does it so well its TSW brand is now global. Executive chairman Eddie Keizan says buyers include Toyota and Delta in the OE (original equipment) market and all makes of cars in the “aftermarket” (replacement market).

The group is strongly vertically integrated, it operates a growing number of retail shops throughout SA which sell wheels and a range of tyres to the motoring public. Keizan estimates Tiwheels has a sizeable chunk of the replacement tyre market.

Annual results for the year to June 1995 reveal the pay-off turnover up 53% to R238,6m, operating profit up 58% to R21m and attributable income up 55% to R14,5m. These figures take into account losses from an “ill-judged expansion” in the US and capex on upgrading plant. EPS rose 38% to 36c, diluted by the large issued capital.

Tiwheel's success rests on three pillars: its cutting-edge product design, hi-tech manufacturing process, and comprehensive quality control systems. Wheels are designed on state-of-the-art CAD/CAM systems which allow for fast and flexible design modification. This is a large consumer of capex, about R1m per year is spent on computer upgrades and training.

FOX

design engineers, who have to keep abreast of latest trends.

The factory turns out a complete provenance for each wheel, down to the hour it was made, and the 400 wheel designs are identified electronically and bar-coded before they are packed. The ID machine was developed in conjunction with the CSIR and is now sold to other wheel makers. Keizan says the quality of the wheel finish is a key advantage in the market, the process is labour-intensive but “you get top German or Italian quality at SA prices”.

Bought from Dorbyl for R13m last year, the Elandsfontein wheel factory has been rebuilt, and should boost earnings next year. Though capacity usage at the Babalegi plant is high, Keizan reckons that increased productivity stemming from the move to continuous production should raise it further. He expects production to double in 1996. Overseas operations continue to contribute strongly. “The international trading of wheels is a hugely growing business”.

At 725c, the share is highly rated in a lacklustre sector, its price has more than doubled in a year and is still heading up. It is a growth share, go along for the ride.

Margaret Anne Halse

MOTOR INDUSTRY (192)

Up a gear *FM 15/9/95*

Car sales are on target for their best annual performance in over a decade, says Mercedes-Benz marketing manager Eric Scoble

Renewed market strength in August has led Scoble to predict 1995 total car sales could go as high as 225 000 — a view shared by Delta Motor Corp marketing director John Cuming. And that's just from official figures supplied by members of the National Association of Auto-

mobile Manufacturers (Naamsa). Other companies, such as Hyundai, Volvo and Peugeot, could account for another 15 000. Official sales last year were below 200 000.

Naamsa figures show August car sales were 12% up on the previous month and nearly 25% on August 1994. For vehicles as a whole, the improvements were 10% and 30%. Biggest year-on-year increase was in the light commercial vehicle segment where, for the first time, manufacturers have given a detailed breakdown of sales.

From there, one of the most interesting — if predictable — pictures is the renewed strength of Land Rover products in the up-market four-wheel-drive sector. Japanese producers of competing vehicles had expected to suffer from the greater availability and affordability of "Landies". Also of note is the performance of Toyota's multipurpose Venture.

Naamsa director Nico Vermeulen says August's vehicle sales confirm the "inherent vitality" of the economy and investment-led nature of the upswing.

Volkswagen marketing director Graham Hardy describes the latest industry figures as "very encouraging". He's understandably pleased with his own company's continued leadership of the car market but says there are plenty of battles to be fought by manufacturers. With the progressive reduction in import tariffs and other changes to motor industry rules, "the fight for position among motor manufacturers has begun in earnest," says Hardy.

CARS				
Manufacturer	Cars	Number of sales	Total sales % of total car market	
VW	Citi/Fox	2 767	5 067 24,2	
	Golf/Jetta	2 126		
	Golf Cabrio	37		
	Jetta (old)	1		
	Audi A6	100		
	AB	36		
Toyota	Corolla/Conquest	3 680	4 511 21,5	
	Camry	680		
	Other	151		
Samcor	Laser/323	1 722	2 660 12,8	
	Mazda Etude	519		
	Telstar/626	357		
	Other	82		
M-Benz	Honda Ballade	1 249	2 550 12,2	
	M-Benz C-Class	1 024		
	E-Class	147		
	S-Class	91		
	Other	39		
Nissan	Sentra/Sabre	1 193	2 539 12,1	
	Maxima	66		
	Fiat Uno	1 263		
	Other	17		
Delta	Astra/Kadett	1 853	1 895 9,0	
	Monza/Kadett	42		
BMW	3-Series	1 472	1 718 8,2	
	5-Series	140		
	7-Series	106		
Subaru	Legacy	5	9 0,0	
	Impreza	3		
	SVX Sport	1		
		1995	1994	% change
August		20 969	16 805	+24,8
January to August		153 724	128 270	+19,8
July (18 676) to August				+12,3

AUGUST VEHICLE SALES				
LIGHT COMMERCIALS				
Manufacturer	Cars	Number of sales	Total sales % of market	
Toyota	Hilux	2 091	3 351 28,9	
	Venture	633		
	Stallion	327		
	Hiace bus	193		
	Hiace van	69		
	Landcruiser	38		
Nissan	Hardbody	1 457	2 352 20,3	
	Half tonner	772		
	Fiat Uno	107		
	Other	16		
Delta	Isuzu KBK	1 521	2 155 18,6	
	KBP	573		
	Trooper	3		
	Suzuki Vitara	44		
Samcor	Samurai	14	2 123 18,3	
	Courier	898		
	Bantam/Rustler	838		
	Husky/L-Series	212		
	Spectron/Marathon	175		
M-Benz	Colt	809	809 7,0	
VW	Microbus	536	657 5,7	
	VW pickup	121		
Land Rover	Defender	80	146 1,3	
	Discovery	66		
Iveco	Turbodaily	7	7 0,1	
		1995	1994	% change
August		11 600	8 144	+42,4
January to August		87 168	67 313	+29,5
July (10 670) to August				+8,7

MEDIUM COMMERCIALS				
	Number of sales	% of market		
Delta	143	38,6		
Toyota	129	34,9		
Nissan	45	12,2		
Iveco	28	7,6		
Samcor	24	6,5		
M-Benz	1	0,3		
		1995	1994	% change
August		370	321	+15,3
Jan to Aug		2 746	2 215	+24,0
July (377) to August				1,9

HEAVY COMMERCIALS				
	Number of sales	% of market		
M-Benz	271	42,1		
Toyota	88	13,7		
Nissan	83	12,9		
Delta	64	10,0		
Tyco	60	9,3		
MAN	41	6,4		
Iveco	20	3,1		
ERF	16	2,5		
		1995	1994	% change
August		643	511	+26,3
Jan to Aug		4 994	3 565	+40,4
July (695) to August				-7,5

TOTAL VEHICLE SALES				
	Number of sales	% of market		
Toyota	8 079	24,1		
VW	5 724	17,0		
Nissan	5 019	14,9		
Samcor	4 827	14,4		
Delta	4 257	12,7		
M-Benz	3 631	10,8		
BMW	1 718	5,1		
Other	327	1,0		
		1995	1994	% change
August		33 562	25 779	+30,2
Jan to Aug		248 632	201 363	+23,5
July (30 418) to August				+10,4

Source: NATIONAL ASSOCIATION OF AUTOMOBILE MANUFACTURERS OF SA

NISSAN SA

(192) ~~748~~

Japanese buy in

FM 15/9/95

Two major Japanese corporations have bought into Automakers, the holding company of vehicle manufacturer Nissan SA. Mitsui and Nissan Diesel have invested a combined R112,5m, which will be used to buy a significant stake in Automakers when it is listed on the Johannesburg Stock Exchange next month.

Mitsui has invested R75m and Nissan Diesel R37,5m. They are the first direct investments by Japanese companies in the SA motor industry. Others are likely to follow. Apart from the lure of foreign capital, SA companies recognise Japanese shareholdings will open doors wider to exports.

Automakers CE John Newbury acknowl-

FINANCIAL MAIL • SEPTEMBER • 15 • 1995 • 89

BUSINESS

edges the point when he says "These (Mitsui and Nissan Diesel) investments give Automakers strong international partners as we move into the next phase of the domestic growth of the company and expand our operations internationally."

Nissan Diesel is one of the world's leading manufacturers of heavy vehicles and engines, and supplies Nissan SA with its products for the local markets. It is 40% owned by Nissan Motor Co which, for now, has declined to make a direct investment in the SA company. That is likely to change in the future.

Mitsui is one of the world's largest companies, with turnover last year of US\$196bn. Its interests span industry, commerce, finance and services in 90 countries. It has provided financing for the import into SA of Nissan cars and commercial vehicles, and has helped develop the company's other import and export activities. Mitsui's invest-

ment in Automakers is its second in SA. It recently announced it was investing in SA's ferrous raw material industry through Consolidated Metallurgical Industries (CMI).

In addition to Nissan vehicles, Automakers also builds Fiats for the SA market. Newbury recently announced that the company is about to start importing Alfa Romeos, which are part of the Fiat group. In view of the Japanese investment, it wouldn't

come as a surprise if the Italians were also eventually to come in.

The Automakers listing, scheduled for October 24, is intended to reduce the 100% control of Sanlam's industrial investment arm, Sankorp, to 55%. The Mitsui/Nissan Diesel cash will secure a solid slice of the remaining 45%, to be shared between institutions, Automakers employees and the public.



Newbury

Share deal for Automakers' workers

CT(BR) 15/9/95 (192) (8)

By ROY COKAYNE

PRETORIA BUSINESS EDITOR

Automakers, the holding company of Nissan SA which is scheduled to be listed on the JSE on October 24, is keen for the unions to take a "strong" shareholding in the company in the future

John Newbury, the chief executive of Automakers, said discussion would take place today with Numsa about the shareholding offer

Newbury told a news conference earlier this week that two Japanese companies, Nissan Diesel and Mitsui & Co were to invest a

total of R112,5 million in Automakers and indicated that large amount of shares would be made available to workers

He said all salaried and hourly paid staff would be assisted to acquire shares in the company

The investment by Nissan Diesel and Mitsui will give them a combined 12,9 percent shareholding in the company — 4,3 percent to Nissan Diesel and the balance to Mitsui. This is in line with Sankorp's strategy to reduce its shareholding to effective control by reducing its investment in Automakers from 100 to 55 percent

The 45 percent balance will be

held after the listing by a mix of institutions, including Nissan Diesel and Mitsui, the public and staff, which will acquire their shares through a private placing and preferential and public offerings

The listing would raise R244 million, of which R125 million would go into Automakers, the remainder will be used to run down Sankorp's shareholding

He said 180 million shares would be listed at an issue price of 500c a share

Newbury said they were not looking at employing the cash raised from the listing during the current year

VX

R112m coup for Automakers

(192)ST(BT)17/9/95

By **DON ROBERTSON**

NISSAN Diesel and Japan's Mitsui will take a R112-million preferential stake in the R244-million listing in October of Automakers, Nissan SA's holding company

The R37,5-million investment by Nissan Diesel — 40% owned by Nissan Japan — and the R75-million by Mitsui make up the first Japanese investment in South Africa's motor industry and will give them a 12,9% stake in the enlarged Automakers

John Newbury, chief executive officer of Automakers, says a direct

investment by Nissan Japan is not possible as this stage because of a major restructuring of the company, but it is understood that Sankorp, Automakers' holding company, might be prepared to reduce its current 55% control to make such an investment possible

The Automakers prospectus, to be issued in two weeks' time, will show earnings for the current financial

year to June 1996 at 87,9c a share on the issued capital of 185-million shares, offering an attractive price earnings ratio of 5,7 on the issue price of 500c

Forecasts for this year are for a 15% increase in turnover to R3,6-billion from last year to produce operating income of R286-million, up from R235-million. After finance charges and tax, an attributable profit of R156-million is expected, and a dividend of 22c a share, covered four times by earnings

Automakers won't reveal share offer (192)

BY ROY COKAYNE

PRETORIA BUSINESS EDITOR

CF (BR) 21/9/95
It appears unlikely the National Union of Metalworkers (Numsa) will take a shareholding in Automakers, the holding company of Nissan South Africa which is set to be listed on the JSE on October 24.

Discussions took place between representatives of Automakers and Numsa on Friday following comments by John Newbury, Automakers' chief executive, that it was keen for the unions to take a "strong" shareholding in the company in the future.

Newbury said Numsa was pleased Automakers had made a share offer to the union but believed it would not take up the offer as it did not have a share portfolio.

Numsa officials were unavailable for comment.

Newbury would not disclose how many shares had been allocated to its staff and the unions, adding that this would be revealed when the prospectus for the preferential and public offerings was released at the end of this month.

A total of 180 million shares are to be listed at an issue price of 500c a share. Of the R244 million raised, R125-million will go into Automakers and the remainder will be used to run down Sankorp's shareholding in Automakers from 100 to 55 percent.

Two Japanese companies, Nissan Diesel and Mitsui & Co, are to invest a total of R112,5 million in Automakers, giving them 12,9 percent shareholding in the company.

The 45 percent balance will be held after the listing by a mix of institutions.

Outsourcing programme paying off for Delta

~~CT~~ CT(BR) 21/9/95 (192)

Pretoria — Delta Motor Corporation in Port Elizabeth has achieved its first real success story since starting a major outsourcing programme that focuses on increasing its business with black suppliers

It has negotiated a three-year contract for the outsourcing of component-storage carrier-maintenance to Zama Engineering, established at the Community Self Employment Centre in Port Elizabeth

Mark Derry of Delta's corporate communication division, said the contract was fairly substantial and other areas

of outsourcing were being considered

The outsourcing formed part of the company's affirmative action strategy Derry said it took more than 18 months of negotiation to get the Zama Engineering outsourcing project going

Brian Sullivan, Delta's special-business projects manager, said outsourcing business activities not directly connected with the company's core business of building motor vehicles formed part of Delta Motor's drive to become a world-class competitor — Staff Writer

Automakers won't reveal share offer

(192)

By ROY COKAYNE

PRETORIA BUSINESS EDITOR

CT(BR) 21/9/95
It appears unlikely the National Union of Metalworkers (Numsa) will take a shareholding in Automakers, the holding company of Nissan South Africa which is set to be listed on the JSE on October 24

Discussions took place between representatives of Automakers and Numsa on Friday following comments by John Newbury, Automakers' chief executive, that it was keen for the unions to take a "strong" shareholding in the company in the future

Newbury said Numsa was pleased Automakers had made a share offer to the union but believed it would not take up the offer as it did not have a share portfolio

Numsa officials were unavailable for comment

Newbury would not disclose how many shares had been allocated to its staff and the unions, adding that this would be revealed when the prospectus for the preferential and public offerings was released at the end of this month

A total of 180 million shares are to be listed at an issue price of 500c a share. Of the R244 million raised, R125-million will go into Automakers and the remainder will be used to run down Sankorp's shareholding in Automakers from 100 to 55 percent

Two Japanese companies, Nissan Diesel and Mitsui & Co, are to invest a total of R112,5 million in Automakers, giving them 12,9 percent shareholding in the company

The 45 percent balance will be held after the listing by a mix of institutions

the company

Solchem is 79 percent owned by CTP, a subsidiary of newspaper and magazine publishers Caxton

Edwin Jankelowitz, the chairman of Solchem who is also the chairman of CTP and a director of Caxton, said yesterday there were no plans to delist Solchem

The reason for retaining the list-

it had an arm's length relationship with us, as it does with other printers," he said

Solchem shares have not been a spectacular investment. They listed at 50c in 1987 and in the first eight months of this year have ranged between a high of 65c and a low of 50c, although they reached a high of 125c last year

Secondary tax saved companies billions

By DEREK TOMMEY

CT(BR) 21/9/95
The introduction by Derek Keys in March 1993 of the secondary tax on companies has probably saved listed companies from paying out about R6 billion in cash dividends in the intervening period, figures compiled by the JSE indicate

The secondary tax is paid by a company on any cash dividends it declares. But scrip dividends which take the form of shares are exempt from the tax

As a result many industrial and financial companies have switched to paying scrip dividends and to paying cash dividends only at the request of shareholders

The cash companies have saved by paying scrip dividends has been available for reinvestment in their operations

This additional interest-free capital helped boost the growth rate of many companies. It is likely that had manufacturing companies not had this cash saving, investment would have been weaker

JSE figures show that scrip dividends paid by listed companies in 1993 were worth R697 million. This figure spurted to R2,27 billion last year and in the first eight months of this year amounted to R3,02 billion

However, many mining companies are still paying cash dividends only and in the 12 months ended

August their dividends totalled about R17 billion. Thus, and the fair amount of double counting which takes place as dividends pass from one company to another, helps to explain why scrip dividends were still only a small proportion of the R22,3 billion in total dividends paid in the 12 months ended August

Share incentive and option schemes have also contributed extra capital to listed companies. In the first eight months of this year R341,4 million worth of shares were taken up by members of option and share incentive schemes

This is based on the price at which the shares were issued to members of these schemes and does not show the price at which they were sold.

This year has been a poor year for the exercise of share incentives and option schemes.

Shares worth R1,09 billion were taken up last year and in 1993 R590,4 million.

The heavy exercise of options last year followed the doubling of share prices in the previous two years and was probably triggered by the view that shares prices were unlikely to rise as fast in the next few years. This view has been sustained by the behaviour of the JSE this year. At the end of August the all share index was down 5,5 percent on its December level

Ideas save Nissan millions

(192) CT (PR) 25/9/95
An ideas programme launched by Nissan South Africa eight years ago has resulted in savings of R64,2 million

Stephanus Loubser, the managing director of Nissan SA Marketing, said the saving had helped Nissan contain price increases and bring affordable motoring to its customers

A total of 15 070 ideas had been received since the programme was launched and the

participation rate — the number of suggestions received for every 100 employees — had risen from 13 percent in 1987/88 to 67 percent in the past two years

The company uses the conventional suggestion system coupled with Kaizen, a Japanese system of innovation and continual improvements. It also has a simple recognition and reward system with overseas travel a key component in prizes — Staff Writer

Motor spares set to hit the R5,5bn sales mark

BA 26/9/95 (192)

John Dlodlu

SA's auto components manufacturers last week expressed optimism that their industry was set for a 10% rise in the value of car parts sales this year

In an interview yesterday, Autoquip Group MD Bruce Coquelle said the parts industry was likely to sell R5,5bn of its components this year — about 10% more than last year.

According to the National Association of Automobile Components and Allied Manufacturers (Naacam), an association that represents 160 of the industry's 200 main players, the sector's exports — which had risen "considerably and consistently" in recent years — would again increase "substantially" this year

Naacam executive director Denzyl

Vermooten said he expected exports to rise 23% to R3,2bn this year

"The effects of the MIDP (the motor industry development programme — a plan aimed at restructuring the motor industry to increase its competitiveness) on exports will become visible only in the course of next year"

Naacam president John Brandtner said exports would eventually make up more than 50% of the output of the components manufacturing industry "We have proven our industry's ability to address productivity, and to achieve global quality standards"

"Our ability to source from global suppliers makes us also confident that we'll be able to meet our export commitments" Autoquip exports to neighbouring countries, mainly Zimbabwe, Mozambique and Malawi

Competition Board probes motor spares industry

By ANDY DUFFY

STAFF WRITER

The Competition Board is investigating the motor spares industry amid allegations that major distributors are bullying manufacturers into cutting off supplies to smaller rivals.

Board chairman Pierre Brooks said yesterday the preliminary investigation followed a complaint

by Johannesburg-based spares distributor QSV

American-owned Federal Motor, South Africa and Alert Engine Parts were named by QSV in its complaint. QSV's owner, Roland Bauer, was the joint founder of FMSA subsidiary V&R Holdings.

Brooks said the board was contacting various equipment manufacturers to check QSV's claims before quizzing the distributors

ET(BR) 27/9/95 (192)

"We want to give these people a chance to respond," Brooks said

"It has been alleged that certain manufacturers are refusing to supply certain retail outlets, and that these manufacturers have had pressure put on them"

The investigation comes 18 months after the board overruled similar fears in clearing Varex's plans to buy Alert

The deal, later aborted, would

have given the two companies 25 percent of the spares market

But the board found no evidence that manufacturers were discriminating against the companies' competitors

FMSA chief executive Rob Crockett rejected suggestions that manufacturers were being pressured into not supplying smaller rivals

"We have expressed our con-

cerns that the market is being over-traded and already we're suffering from a back-order situation

"But I don't believe there's any company supplied by the manufacturers powerful enough to call the shots on that issue"

FMSA's annual sales were currently around R560 million, he said, against R500 million last year, as it had been consolidating despite the acquisitions

Automakers riding in the fast lane

(192) Apr 28/9/95

■ BY JOHN SPIRA

Institutions have already oversubscribed the Automakers share issue by a factor of four, says John Newbury, the group's chief executive

Automakers, the holding company involved in the manufacture and distribution of a wide range of motor vehicles and components under licence from Nissan Motor, Nissan Diesel and Fiat Auto, will offer 5 million shares to the public and 5.5 million shares via a preferential offer before its listing on the JSE on October 24

The offers, at 500c a share, open on September 28 and close on October 19

Automakers recently acquired the rights to market Alfa Romeo vehicles in South Africa

In addition to the institutions, the share offer is likely to attract keen demand from

the public, with the forecast price-earnings multiple at a low 5,6 on the 500c a share issue price

The forecast yield is 3,3 percent on a dividend covered 5,3 times by earnings

The directors intend adopting a four times dividend cover policy, suggesting ample scope for the distribution to be raised

The only motor manufacturer presently listed on the JSE is Toyota, whose price-earnings multiple of 8,2 and dividend yield of 2,2 percent indicate that Automakers has pitched its share issue at a level which can safely be described as generous

Newbury acknowledges such generosity, saying that Automakers would be delighted for its suppliers, customers and principals to benefit from the issue

He is not, understandably, prepared to predict the extent

Total market

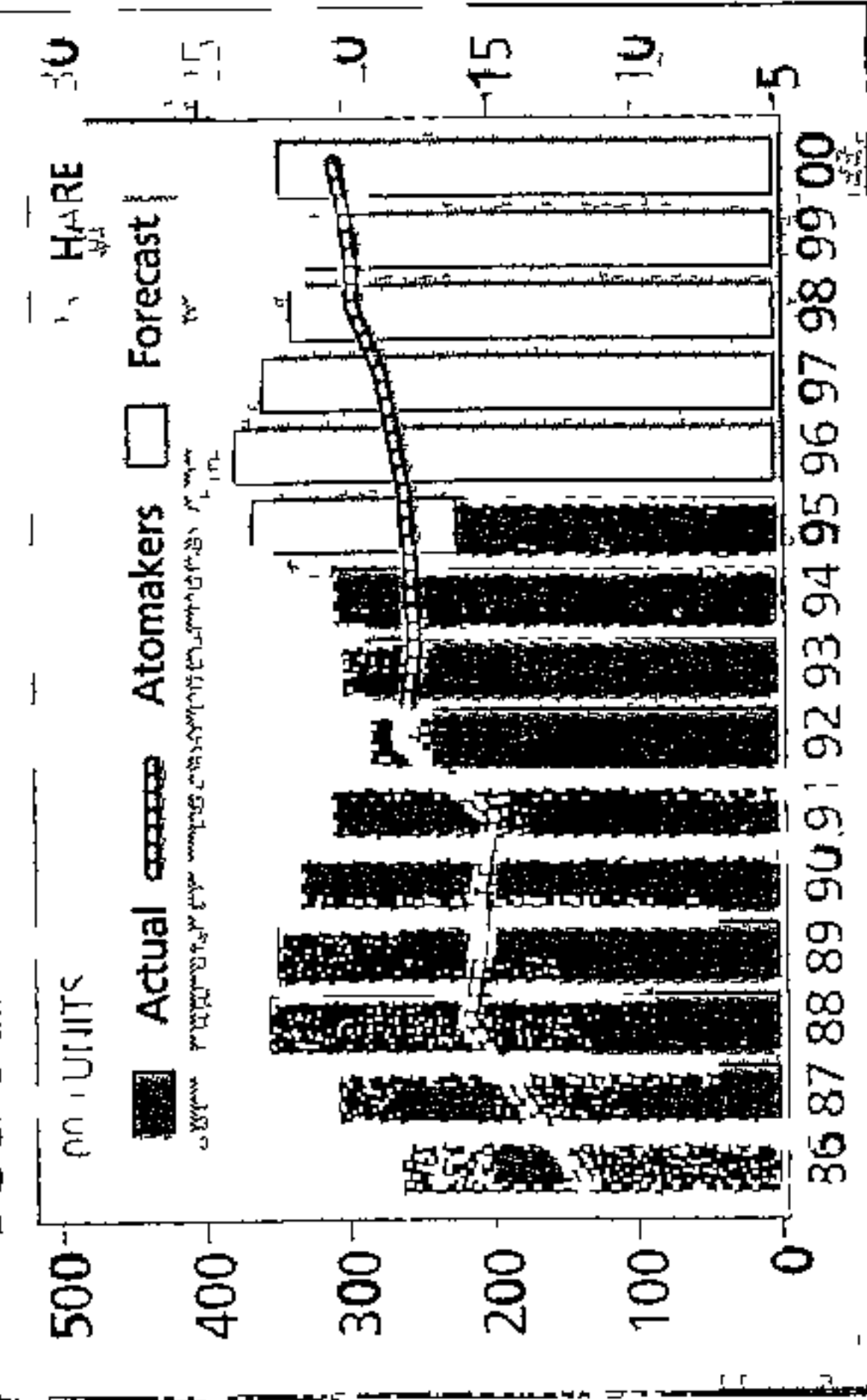

of that benefit. In assessing the forward multiple, one needs, of course, to be confident that Automakers is not only able to achieve its earnings forecast but that it shapes up satisfactorily against Toyota. Here the following considerations apply

1986 — from 12 percent to close to 18 percent last year

■ Automakers' operating margins have improved from 5 percent in 1992 to a present 8,5 percent. During the same period, Toyota's margins have slipped from 9 percent to a shade under 6 percent

■ Automakers' return on assets has risen from 3 percent in 1992 to 18 percent. The respective Toyota figures are 19 percent and 10 percent

■ Since 1988, units sold by each employee have been constant at about the eight level for Automakers. The statistic for Toyota has declined from 16 to eight over the same period

These indicators do not pinpoint the likely level of the Automakers share price

They do, however, suggest that a fairly healthy premium is certain when the shares make their debut towards the end of next month

■ For the past three years Toyota's price-earnings multiple has been consistently above the multiple on which Automakers is going to the JSE

■ Automakers' share of the total South African vehicle market has risen steadily since

Total market

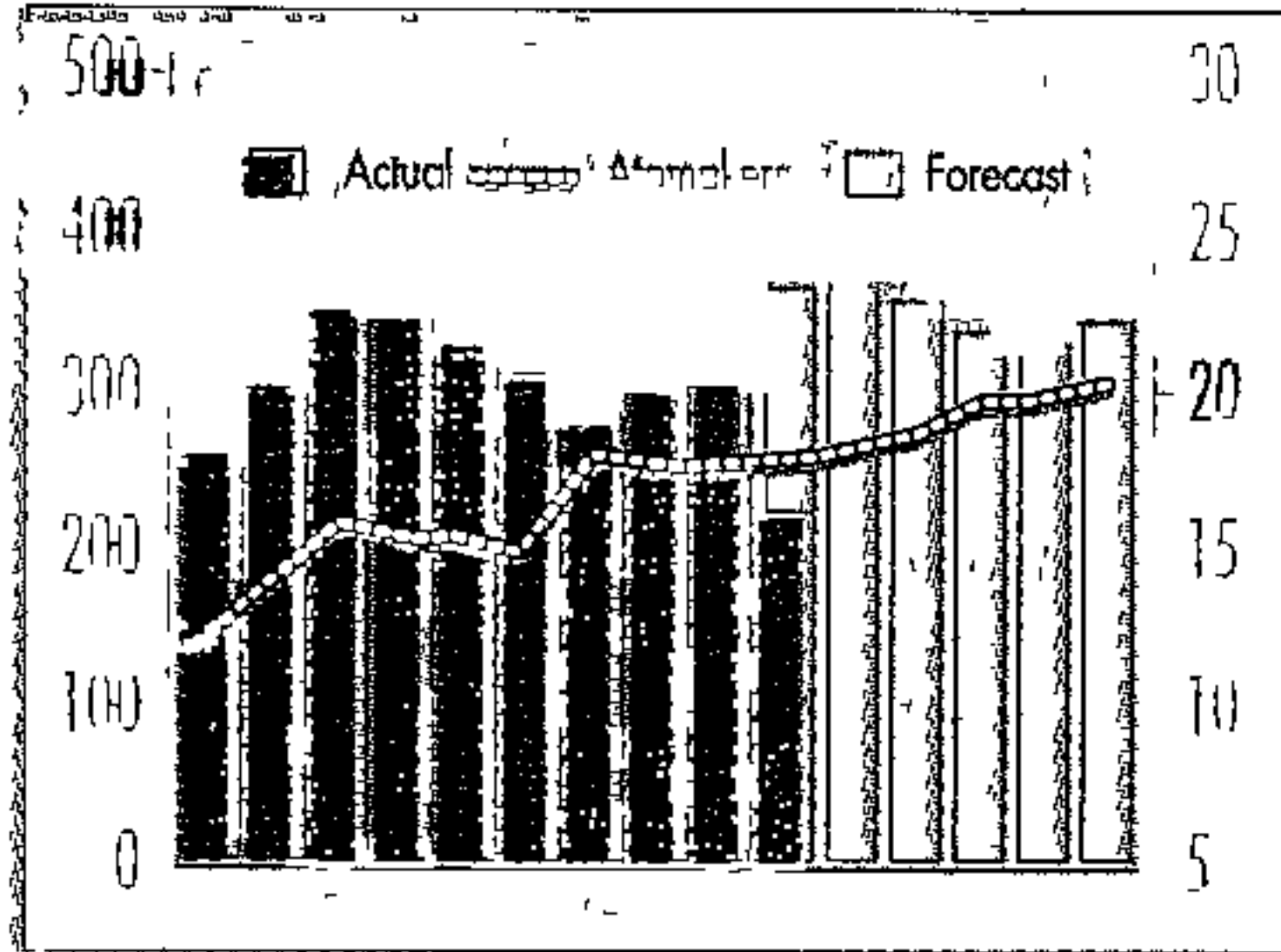

Automakers is in the fast lane

(192) CT (MR) 28/9/95

BY JOHN SPIRA

GAUTENG BUSINESS EDITOR

Institutions have already oversubscribed the Automakers share issue by a factor of four, says John Newbury, the group's chief executive

Automakers, the holding company involved in the manufacture and distribution of a wide range of motor vehicles and components under licence from Nissan Motor, Nissan Diesel and Fiat Auto, will offer 5 million shares to the public and 5,5 million shares via a preferential offer before its listing on the JSE on October 24

The offers, at 500c a share, open on September 28 and close on October 19

Automakers recently acquired the rights to market Alfa Romeo vehicles in South Africa

In addition to the institutions, the share offer is likely to attract keen demand from the public, with the forecast price-earnings multiple at a low 5,6 on the 500c a share issue price

The forecast yield is 3,3 percent on a dividend covered 5,3 times by earnings

The directors intend adopting a four times dividend cover policy, suggesting ample scope for the distribution to be raised

The only motor manufacturer presently listed on the JSE is Toyota, whose price-earnings multiple of 8,2 and dividend yield of 2,2 percent indicate that Automakers has pitched its share issue at a level which can safely be described as generous

Newbury acknowledges such generosity, saying that Automakers would be delighted for its suppliers, customers and principals to benefit from the issue

He is not, understandably, prepared to predict the extent of that benefit

In assessing the forward multiple, one needs, of course, to be confident that Automakers is not only able to achieve its earnings forecast but that it shapes up satisfactorily against Toyota

Here the following considerations apply

□ For the past three years Toyota's price-earnings multiple has been consistently above the multiple on which Automakers is going to the JSE

□ Automakers' share of the total South African vehicle market has risen steadily since 1986 — from 12 percent to close to 18 percent last year

□ Automakers' operating margins have improved from 5 percent in 1992 to a present 8,5 percent. During the same period, Toyota's margins have slipped from 9 percent to a shade under 6 percent

□ Automakers' return on assets has risen from 3 percent in 1992 to a present 18 percent. The respective Toyota figures are 19 percent and 10 percent

□ Since 1988, units sold by each employee have been constant at about the eight level for Automakers. The statistic for Toyota has declined from 16 to eight over the same period

These indicators do not pinpoint the likely level of the Automakers share price. They do, however, suggest that a fairly healthy premium is certain when the shares make their debut towards the end of next month

Good showing predicted for Automakers shares

BA 28/9/95 (192)

John Dlodlu

AUTOMAKERS, holding company of vehicle manufacturer Nissan SA, which is to list on the JSE next month, has forecast a 24,7% rise in attributable income to R156,8m for the year to June 1996

In its prospectus, the company has predicted a 12,8% rise in pro forma earnings to 88,7c a share on turnover of R3,7bn compared with R3,2bn in financial 1995

Interviewed yesterday, Automakers CEO John Newbury said "The earnings per share forecast is conservative as we are calculating the rand/yen exchange rate at 23 as opposed to the current range of 28 and we will also be bringing in a certain amount of additional cash onto the balance sheet, which might not be employed in high yielding investments in the first year, but will obviously offset any borrowings."

The public offer of 5-million shares at R5 each opens today and will close on October 19. A further 5,48-million shares would be sold

through a preferential offer. A total of 185-million shares would be listed, the prospectus said

The listing, planned for October 24, is expected to broaden the firm's shareholder base and increase its capital base

Newbury said institutional investment would be about 20%

In a statement accompanying the prospectus, the company said it planned to cover dividends four times by earnings. This "relatively high" dividend cover policy was being pursued due to the high capital nature of the industry

Newbury said that the company, which is SA's second largest carmaker in terms of market share, had performed well over the past few years, and its market share stood at 17,5%

It was sitting on substantial amounts of cash, which should bolster its efforts to expand exports, investments in component activities, capex in the plant and new model-related developments

Japanese industrial leader Mitsu Corpora-

tion and motor group Nissan Diesel would invest a total of R112,5m in Automakers

Newbury reiterated that Nissan Motor Company in Japan might choose to participate in the company at a later stage. This step could be facilitated by further dilution of Sankorp's equity — currently at 55% from a previous 100%

However, Nissan investment would depend on market conditions.

Newbury said the firm did not "seriously anticipate" any other major foreign players investing in Automakers, although the Fiat Group might want to take part in marketing activities

AUTOMAKERS

(192)

Full house

FW 29/9/95

Automakers' share offer to institutional investors has already been over-subscribed four times, says CE John Newbury.

The institutions have been offered 44m shares in the soon-to-be-listed holding company which manufactures and markets Nissan and Fiat vehicles in SA.

Of 185m ordinary shares, Sanlam's investment arm, Sankorp — which currently holds 100% of Automakers — will retain 101m. With two Japanese corporations, Mitsui and Nissan Diesel, having secured further stakes, the number of shares to be issued to individual investors on October 24 will be 10,5m, at 500c. EPS are forecast at 88,7c with a dividend of 16,6c expected in the first year of operation. The p/e ratio comes in at 5,6 times.

The intended structure will give Sankorp 55% of the company, Mitsui 8,6%, Nissan Diesel 4,3% and other shareholders the remaining 32,1%. Newbury discloses that Nissan Motor Co asked for a block of shares to be set aside for its eventual use, but the request was turned down. When the company, which has been undergoing major restructuring in Japan, is ready to invest, it is likely to buy part of Sankorp's stake — possibly as much as 10% of Automakers.

Hourly-paid Automakers' employees will be able to buy a block of 1,4m shares, which will be administered through a workers' trust.

Automakers also exports vehicles and components and recently announced the local import franchise for Alfa Romeo cars.

The listing prospectus, published this week, reveals a better-than-expected profit performance by the company in the last few years — including the mid-to-late Eighties.

when the SA motor industry underwent a period of crisis.

With the exception of 1986, the company has made an operating profit every year since 1985. In the four financial years from 1992, when year-end was changed from December to June, operating income has been R130m, R170m, R216m and R285m. Turnover during the same period was R2,9bn, R2,4bn, R2,5bn and R3,2bn. Forecast for the current year is income of R286m on turnover of R3,7bn. Attributable income over the five years, including the 1996 forecast, is R13m, R62m, R93m, R126m and R155m respectively.

With the new motor industry development plan now in place — though a few important ground rules still have to be decided — Newbury is confident the company is well placed to take advantage. The domestic vehicle market, in which its products have been increasing market share progressively, continues to show signs of sustained growth, and the company is also active in export markets. Automakers is currently the second biggest seller in SA, with about 18% of the market. Its new role as the chief Nissan supply base for sub-Saharan Africa is expected to increase volume demand markedly, and there is also a burgeoning international market for components.

Though Newbury insists the money raised from listing won't be thrown into the

fray immediately, the company has considerable capex commitments to carry out its plans. Following capex of R193m in the 1995 financial year, proposed spending for the next three years is R197m, R204m and R108m. Most of it is related to the introduction of new Nissan and Fiat vehicles. ■

SA's VW on world map

Lopez on fundamental restructuring plans for the future (192) *fm 29/9/95*

SA will become Volkswagen AG's main centre for the manufacture of all right-hand drive models for its global markets, although not immediately.

Had we been told this by anyone other than Jose Ignacio Lopez de Arriortua, we'd have been sceptical. But it carries the full force of the most formidable executive in the world auto industry circles.

This month Lopez came to SA for a day — to meet President Mandela. "That has been my dream. Once I get back to my office, the only picture to be seen will be a photograph of the President and myself. That's all."

This was a rare emotional outburst from the ice man of Wolfsburg — the slightly built man who holds controversial sway over the lives of thousands of German auto workers.

Ever since his headhunting by VWAG from GM's European subsidiary Adam Opel, the media have branded the Spanish-born production engineer traitor, savage and savour — all in one breath.

After more than two years of investigation by a German court, allegations that Lopez engaged in industrial espionage and a possible breach of trust against his former company have not been proven.

In one of the biggest controversies in the history of the industry, GM and Adam Opel allege Lopez and some of his colleagues took confidential documents when they left the US company in 1993 for VW.

Despite Adam Opel claiming losses and threatening to sue VWAG and Lopez for "several billion marks," he has not been indicted. He disdains to speak of the matter beyond saying it is "nonsense".

As a member of VWAG's board of man-

agement Lopez is the author of the company's fierce cost-cutting strategies to restructure its bloated German operations. The company barely outran the unions when an aggressive plan to reduce working hours at its plants to four days a week was pushed through two years ago. But Lopez points out the alternative was massive layoffs.

To prove his point metals and electronics union IG Metall's wage commission last week approved, by an overwhelming majority, a new wage agreement with VW. The union said 93 commission members voted in favour of the agreement and 10 against it, with no abstentions.

But Lopez knew the outcome even before the ink had dried. As far as he is concerned the deal is done. For the balance of 1995 each employee will receive an extra DM200 a month.

From January 1996 there will be a 4% increase in return for guaranteed jobs for two years.

The motor manufacturer won several concessions on more flexible working hours and overtime pay from the union.

The initial proposals put to IG Metall included provisions that workers accept a

two-year contract that provided for no hourly pay rises, a 13% increase in hours worked each week and an end to time-and-a-half for Saturday work.

But Lopez has only "beautiful things" to say about the workers. "The unions acted very professionally. They acted in a responsible manner in a difficult situation and will rise to the challenge to improve productivity."

Asked if the workers will work a shorter week, Lopez says this will be dictated by the vagaries of the market. "When the market is going up the week can be enlarged. When the market is going down the week can be reduced. It is a flexible week for the first time in the industry."

"People are the most important asset, you cannot afford to lay off people. This agreement is a great achievement for management and labour."

In theory correct, but in fact Lopez now has his flexible week — he has won ground from one of Europe's most powerful unions. He has accomplished the impossible. But in fairness to him analysts say that layoffs, without the compromise, could have amounted to as much as 30%, or 29 000 workers, of

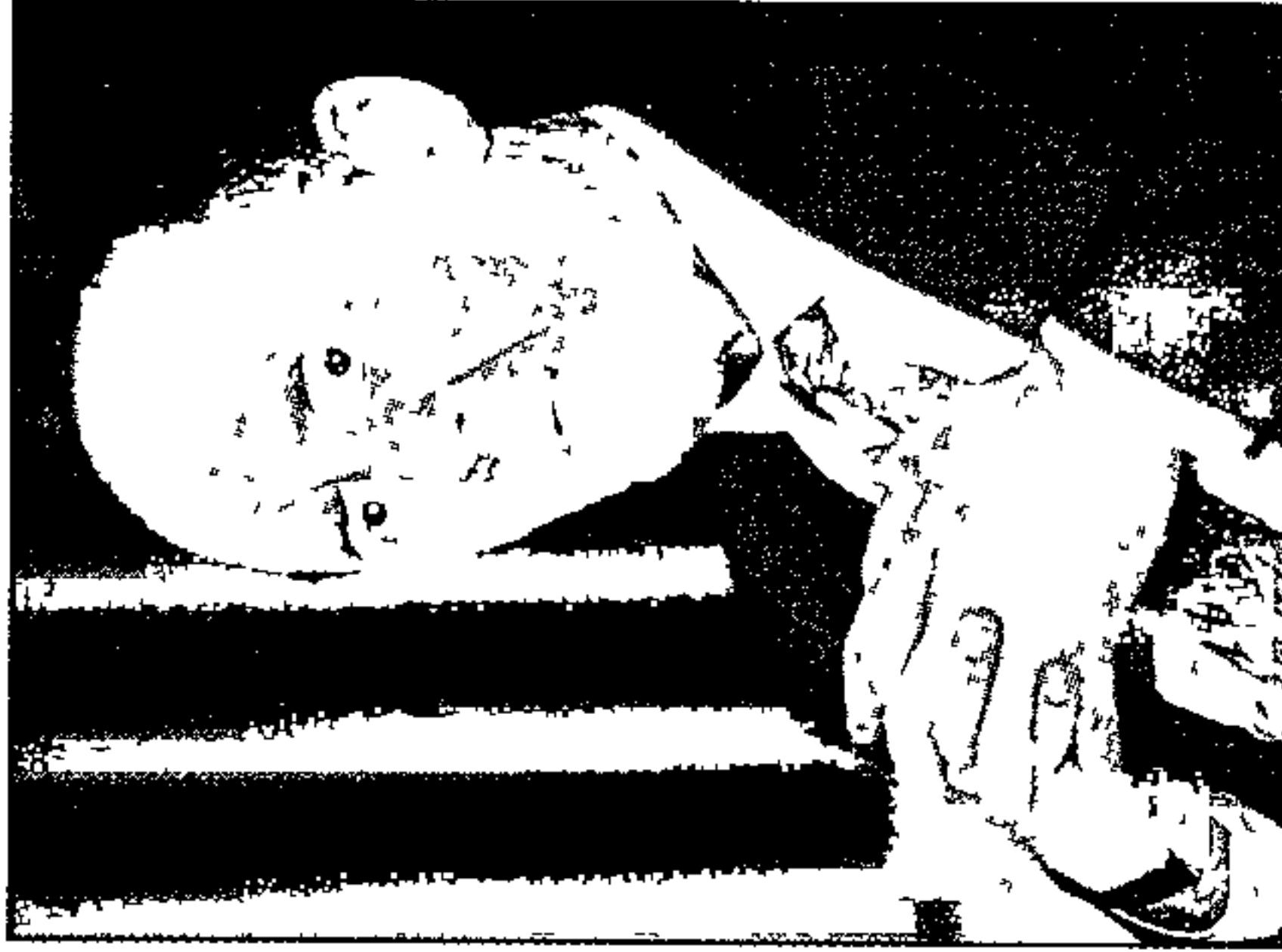

Lopez wins flexible week for VW in German

the company's current German work force. Despite rampant speculation about the company moving offshore, VWAG's core activity will remain in Germany. Of that he is emphatic.

Lopez took on the role of hatchet man over two years ago as VWAG's sales began to slide and profit margins dwindled. He soon made his presence felt and the company reported a DM150m profit in 1994 after a disastrous 1993 when losses of over DM1bn were recorded. The trend has continued into 1995 with the first six months showing a net profit of DM165m.

VWAG is making gains against strong opposition, claiming a 16,65% market share for January to June compared with 16,37% for 1994.

Figures are expected to improve following the launch of two new models, the Audi A4 and the Polo. But that is in Europe.

In Africa, Lopez revealed another side to his polemic nature when he addressed about 100 local VW suppliers and dealers hastily summoned to Midrand for his visit. They listened spellbound as he laid out his vision for the future of the industry.

Lopez, who is also chairman of VWSA, told them the industry was in the eye of a hurricane, the classical approach was finished, the days of management from the top down were over. He wove a magic that enthralled as he spoke of the "revolution" in the industry.

"If today's car manufacturers don't realise what is coming, new car manufacturers will appear on the scene. Electronics will dominate. Mechanical parts will disappear. New car manufacturers may even be Sony, Hewlett Packard or Anglo American."

His description of the car of the future — which he claims will be introduced closer to the year 2000 than the year 2010 — mesmerises. Steel as a component will drop from 75% of a vehicle to 15%.

The use of plastics (50%) will see car mass halved to around 400 kg, making power steering superfluous. Suspension will be electronically controlled. Fuel consumption will drop to between 2l and 3l per 100 km. Safety will be proactive. Engine development (ceramic) will see emissions all but disappear.

And so Lopez captured his dealers. He tantalisingly drew tidbit after tidbit out of a seemingly bottomless hat. "The customer will not just be the king, he will be the em-

peror. The customer will dictate what price he wants to pay. Price for value will go low. Today it takes eight months of a German worker's salary to buy a new vehicle. This could drop to two months.

Suppliers will become more integrated with the manufacturing company. They will be involved in the design of new cars at concept stage. Manufacturing time will drop from 30 hours per vehicle to seven — all overseen by a "meister" car maker.



Audi A4 SA is first foreign market

The master will take responsibility for the vehicle and, as in the case of the violin master, will personally sign the car on completion. "This is our vision. It will come sooner than expected. If you miss the boat, too bad. The car population of the world will increase, with the driving force being leisure. With what is coming there is no Third World or First World. Cars will be easily accessible to all."

But like the conjurer, he saves the best for last. His legerdemain hinges on the concept of service. There will be a change in logistics. Currently it takes five weeks for a customer to take delivery of his vehicle. This will drop to two weeks, then to two days and within a short time to two hours.

The out-of-this-world concept, once one has grasped its basic tenet, is simple. Lopez refers to it as the module concept. The dealer will carry all marques, all basic models, delivered from the manufacturer. The customer will then decide, in the dealer showroom, on engine capacity, colour, airconditioning, upholstery — in essence, the car of his choice.

The dealer will stock inventory which, according to customer needs, will be installed or mounted in the vehicle — all in the space of two hours. The dealership will have an electronically controlled, vacuum-environment paint shop where a car will be painted in a short time.

The average car will have a life of 25 years — that is the chassis. All the customer has to do is revisit his dealership any time he wants to update his model and he will have the latest in two hours. And all

this means less maintenance, fewer spare parts. The dealer may lose out on repairs but will gain on retrofits. The first plant in the world where the modular manufacturing concept will be introduced is in Brazil and it will be built soon.

The dealers were poleaxed.

Later in the calm of the executive suite Lopez, his inflexion tinged with a Basque lisp, spoke quietly of his plans for VWSA. "Today we are the leaders in the markets here. We are leaders in product. In appreciation and recognition of SA's role in our plans we have introduced our best car, the A4 Audi, within months of having launched it in Germany. SA is the first country to have this. SA will also have our new concepts a few months after we have them in Germany. In the year 2000 you will already be familiar with these concepts."

Lopez says VWSA will surprise people — looking at how many cars are being produced today, how many cars are going to be produced tomorrow and the way this is going to be accomplished.

Ranking creativity as important as capital investment, Lopez says VW will increase market share as it has the vocation to be number one and is not going to give it up. "Thanks to the competition we are number one. We have the vocation to maintain leadership in SA and the vocation for exports."

VWSA now has an export plan, and considers that quality in SA is reaching world standards in benchmark terms. SA is considered a centre of excellence. "We will go step by step — we will go with discipline — these are our dreams."

Declining to disclose planned capex for the export drive, Lopez quietly reiterates that the SA operation will, at some stage, become the sourcing point for all right-hand drive models for all VWAG's world needs.

"We need to work together inside our company and today was a symbol of all this. A person came to visit our company — President Nelson Mandela. He is more than a leader, he is a symbol of how extraordinary one human being can be. Today you could see how the people in our company reacted — whites, blacks, Indians, South Africans, Spanish, Germans, Hollanders — we had tears in our eyes, all of us."

In the spirit of today we need to stand and maintain a life for every day, every working day. In this spirit of working together, in this spirit of helping each other, VWSA will grow.

For a motor manufacturer to disclose company plans and reflect on his vision for the future is extraordinary. In a sector where anything that smacks of corporate planning is veiled in secrecy, Lopez was extremely candid.

His visit to SA — en route to South America — was short. But it certainly had impact, both in what he had to say and the enchanting way in which he said it.

BEARING MAN
Still attractive

(192)
FM 29/9/95

Activities: Imports/distributes bearings, seals power transmission products and other engineering consumables

Control: AVI (through Aveng) 55,4%

Chairman: D Royston MD G J Till

Capital structure: 10,4m ords Market capitalisation R390m

Share market: Price 3 750c Yields 2,3% on dividend 6,0% on earnings p/e ratio, 16,7, cover, 2,6 12-month high, 4 050c, low, 2 000c Trading volume last quarter, 111 605 shares

Year to June 30	'92	'93	'94	'95
ST debt (Rm)	16,4	14,9	16,7	9,5
LT debt (Rm)	4,9	3,9	0,4	—
Debt equity ratio	0,50	0,38	0,30	0 10
Shareholders' interest	0,43	0,46	0,45	0,53
Int & leasing cover	3,0	4,8	7,9	13,1
Return on cap (%)	14,0	18,5	20,8	21,5
Turnover (Rm)	126,6	154,9	200,0	262,3
Pre-int profit (Rm)	13,9	19,9	26,3	38,4
Pre-int margin (%)	11,7	12,8	13,2	14,6
Earnings (c)	66	114	148	225
Dividends (c)	30	40	56	87
Tangible NAV (c)	459	522	611	911

Last year's "Worth a look" heading on the FM's review of the 1994 annual report turned out to be a monumental understatement the share price, then 2 150c, has since virtually doubled to peak at 4 050c before backing off to its current 3 750c for a net 74% gain during a period when market conditions have been indifferent

The main thrust of last year's review was that Bearing Man was underrated relative to its performance and prospects The same

could be said now Strong earnings and dividend growth has kept yields largely maintained The 2,3% dividend yield is not significantly lower than last year's 2,6% And while the p/e multiple has stretched to 16,7 (1994 14 6), it is still not expensive

The question that does arise is how much longer Bearing Man can maintain its current performance Over the past three years earnings and dividends have shown compound growth rates of 50% and 43% respectively As chairman David Royston notes, this is not sustainable indefinitely

But in a sense that misses the point The 1992 base year in the comparison was a low point for the group, which had recently been formed out of a merger of the original Bearing Man with the related trading activities previously housed in AVI's Steelmetals Before the merger the two were cutting each other's throats The merger eliminated this element

Royston adds that this progress has far exceeded expectations at the time of the merger But the process initiated by the merger has been extended by acquisitions of complementary businesses The pattern has been to buy the trading activities, rather than the companies themselves, which means the acquisition of market share without a proportionate addition to overheads This undoubtedly contributed to the improved economies of scale reflected in the progressive widening of trading margins

Also not mentioned is that with imports making up a major portion of the product range, it must have benefited from the normalisation of SA's international trading relationships It may not be complete coincidence that 1995's improvement in trading margins was proportionately larger than at any time since the merger

None of the above contradicts the view that growth rates of the past three years must be expected to moderate Profitability has been progressively brought up to speed, current returns of 21,5% on total assets and 24,6% on equity are respectable rather than excessive for what is essentially a trading operation A significant portion of the "growth" should be seen as recovery

That process is now largely complete The group will have to rely increasingly on general market conditions and expansion within the economy which may, as with the relatively new flat belting division, involve branching out into new product lines It has the infrastructure and financial resources for this and there should not be much doubt that the group has the capacity to continue producing real growth

The share is still worth a look Unfortunately, for most small investors a look is about all they are likely to get as little more than 4,5m shares are available outside the controlling block A share split would improve marketability, and would almost certainly enhance the market rating

Brian Thompson

MOTOR INDUSTRY (192)

Foresight

FM 3/11/95

South Africans' liking for four-wheel-drive (4WD) vehicles is being put to the test by a battery of new products. Established marques are being challenged by a number of newcomers, some from unlikely sources.

Land Rover has already upset the previ-

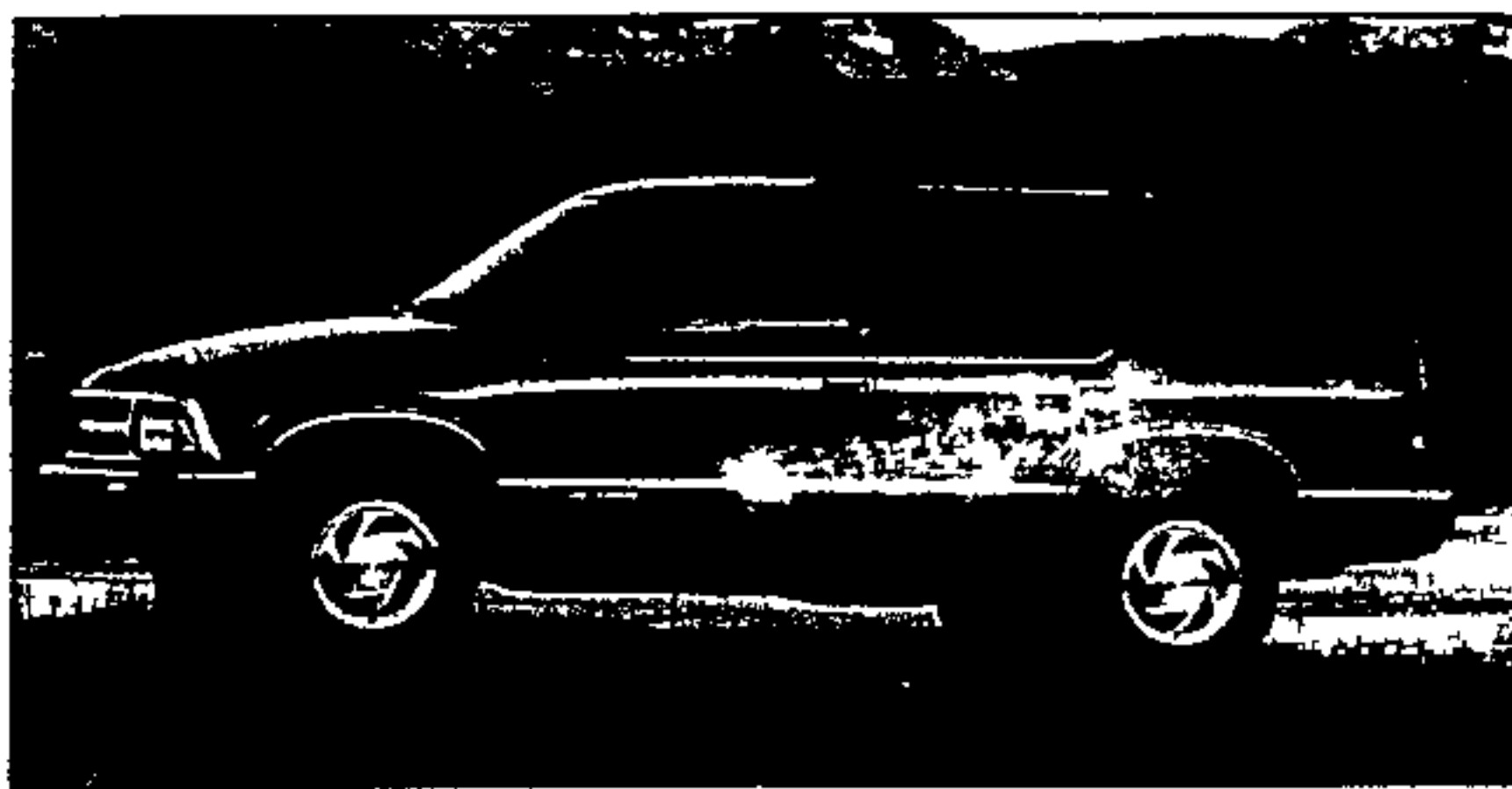

The Suburban one of Chevrolet's first imports

ously comfortable equilibrium at the top end of the 4WD market since opening a new factory near Pretoria. Increased production and significant price reductions have enabled its Defender and Discovery ranges, in particular, to chew off a sizeable chunk of this market.

As fully built imports, most top-end rivals have been hampered by punitive tariff protection. But now that tariffs are shrinking they, too, are looking to strengthen their market positions. From a one-time high of 115%, import tariffs now stand at 60% and will eventually hit 40%. Thus products — such as the latest Isuzu Trooper from Japan, just announced for the SA market — can also expect to improve their local price competitiveness.

Other companies are also planning 4WD product updates. Few, though, are likely to excite as much interest as Chrysler, which has announced its return to SA 12 years after pulling out due to financial difficulties in its domestic US market. Its first SA imports will be two versions of its famous Jeep — the Cherokee and Grand Cherokee.

Chrysler hopes to follow these with other utility vehicles and achieve the success they have earned in other major markets.

Chevrolet, another US returnee, is also concentrating initially on this segment. Its first imports will include the Blazer and Suburban ranges.

But not all new 4WDs are for general public consumption. Local company TFM, which specialises in military protection vehicles, recently launched its new Scout armoured patrol vehicle, and Reumech introduced its A-Wagon, an armoured 4WD — though not exclusively for military use.

Other new products — chiefly from Japan and Korea — have targeted SA buyers. And now an Indian name is about to join the queue — Mahindra. It claims to control 80% of its 4WD domestic market and is preparing to launch a seven-vehicle range in SA.

New entrants are evidently

encouraged both by the reduction in import tariffs and the continued growth in SA vehicle sales. McCarthy Motor Holdings CE Brand Pretorius believes imports could eventually account for up to 20% of the total SA new-vehicle market. That figure, however, includes vehicles imported by SA manufacturers and includes some currently manufactured here.

The National Association of Automobile Manufacturers (Naamsa) is certainly optimistic about market prospects. Director Nico Vermeulen, in Naamsa's latest quarterly review, says positive factors include continued business and consumer confidence, ongoing economic recovery, higher levels of fixed investment, improved productivity and renewed car rental demand.

He suggests current Naamsa forecasts of a 234 000 car market next year, on top of this year's projected 227 600, could be conservative, particularly if the SA economy grows at 3,5% next year.

However, there appears to be general consensus among industry analysts that the current improvement in vehicle sales could run out of steam. Where Naamsa suggests a slight decline in 1997, Pretorius suggests it could be a year later. ■

Delta offers 400 more jobs

By ROY COKAYNE

(192) CT (MR) 8/11/95

Pretoria — Delta Motor Corporation in Port Elizabeth has launched a recruitment drive for more than 400 new jobs at its Struandale assembly plant, which it purchased from Samcor a year ago.

A Delta spokesman said to date 9 000 applications had been received in response to the recruitment drive.

The spokesman said most of the applicants had satisfied the minimum entrance requirement of either a matric or N3 with mathematics and science.

Delta's human resources director George Stegmann said Delta had placed more than a R100 million worth of orders with Port Elizabeth-based suppliers in the first few months of upgrading and refitting the Struandale plant.

SA may supply whole world with some Audis

CT(BR) 8/11/95 (192)

By AUDREY D'ANGELO

Cape Town — Volkswagen SA is likely to supply the entire world with the right-hand drive version of an Audi model and possibly the right-hand drive version of the fourth generation Golf

Only three years ago, its German parent was seriously considering the closure of the South African operation, an executive admitted. Since then productivity and quality have improved to such an extent that the Uitenhage factory gives the second-highest return on investment of any Volkswagen subsidiary.

Cars made there have been sent to Britain to be tested for quality.

"This is a radical departure from the closeted inward-looking approach in former years," a spokesman said.

He said the group was now considering making all right-hand

drive versions of some models in South Africa. Countries which would be supplied from here would include Britain and Japan.

"Volkswagen SA is being seen as a meaningful part of the group for sound bottom-line reasons and not just because this country is the flavour of the month.

"There has been an improvement in productivity of between 50 percent and 60 percent compared with last year. In September a production record of 7 000 cars in one month was achieved."

He said this was having a positive effect on sales. "In the past, they were limited by availability of stock. Now, although dealers are not getting quite all they want, the supply situation has been improved."

Volkswagen sold 5 809 new cars in October, pushing the former market leader, Toyota, into second place.

Boom year predicted for motor industry as sales soar

ARG 8/11/95
192

HENRI du PLESSIS, Motoring Reporter

SOUTH Africa's motor industry is headed for a boom year after almost a decade of drought, with total sales of new cars this year expected to reach at least 225 000, and possibly even 230 000.

Predictions for commercial vehicle sales are hovering around the 150 000 mark

Elated motor industry sources say sales figures for October, issued by the National Association of Automobile Manufacturers of South Africa (Naamsa), are outstanding

These exclude sales figures of marques which do not have to report to Naamsa

Included in this group is the popular Hyundai company, whose Korean imports have seen their sales break records since they started business early last year

But spokesmen forecast that growth would continue well into next year and that price rises would be below inflation.

This was primarily because of the government's programme to reduce import taxes and the rand's recent stability against the yen and Deutschmark.

The only local company brave enough to predict total sales for importers was Nissan South Africa

This should add a further 15 000 to the Naamsa figures, said Stephanus Loubser, managing director of Nissan SA Marketing

Foreign confidence in the South African motor industry became evident this year with a number of foreign makes of cars appearing in this country following the lifting of international sanctions

Apart from Hyundai, manufacturers like Peugeot, Volvo, Saab and Alfa Romeo, as well as previously unknown makes such as SsangYongcor, Asia and Subaru have entered the fray

Ford also reinvested in local manufacturer Samcor and Delta Motor Corporation, the local makers of certain General Motors products like Opel and Isuzu, have been able to do foreign business through support from General Motors

At the same time, the government has reduced import tariffs in line with General Agreements on Tariffs and Trade principles from an outrageous 110 percent to 65 percent, and is expected to reduce it to 61 percent in January

The reduction has been designed to bring the import duty down to 41 percent by 2001

South African car makers are, however, preparing themselves for some real competition and they have already had a taste of it from Hyundai

Estimates are that imported vehicles will make up 25 percent of the local market by the turn of the century

All the spokesmen approached admitted that a sudden drop in import taxes would spell disaster, forcing local manufacturers to shut their plants and climb on the imports bandwagon

Labour would be the losers in the end, as thousands of jobs would be lost, said Toyota public relations manager Roger Houghton

"Toyota is investing R70 million in a new programme, but if the tariffs had to be dropped to 41 percent straight away it would be stupid of us to continue with the plan," he said

"Then we might as well import and be done with it"

The plan would rather be to allow the locals time to become competitive and world-class in their own right, sources said

"We have to be able to reach the stage where we can compete overseas with our products," one source said

Meanwhile, local car makers do not expect a drop in interest rates next year — something they would have loved to see as it would have further enhanced sales

"I believe present consumer spending patterns will keep interest rates high to curb inflation," said Eric Scoble, Mercedes Benz South Africa's marketing manager for passenger cars

Sales of commercial vehicles acted as an indicator of business confidence, sources said

"We expect that the ongoing strength of fixed investment will underpin the upward trend currently being experienced in lorry sales," said Delta's director of sales and marketing, John Cumming

"It is essential from a long-term perspective that, with the legitimacy of the South African government gaining acceptance abroad, South Africa has freer access to foreign capital in order to sustain the economic upswing," Mr Cumming said.

Good time ahead for SA motor industry

(192)

Analysts predict growth in the sector will continue well into next year

Star 9/11/95

OWN CORRESPONDENT
Cape Town

South Africa's motor industry is headed for a bumper year after almost a decade of automotive drought, with total sales of new cars this year expected to reach at least 225 000, with some predictions of more than 230 000

Predictions of commercial vehicle sales are hovering around the 150 000 mark.

Motor industry sources say the sales figures for October, released by the National Association of Automobile Manufacturers of South Africa (Naamsa), are outstanding

These figures exclude the sales figures of groups who do not have to report to Naamsa

Among these is the highly popular Hyundai company, whose Korean imports have seen their sales break record after record since they started business early last year

Bullish spokesmen predicted the growth in the industry would continue well into next year and forecast that price increases would be sub-

dued to stay below inflation.

This was primarily because of the Government's programme to reduce import taxes and the rand's recent unexpected stability against the yen and the deutschmark, they said

The only local company brave enough to predict total sales for importers was Nissan South Africa

This should add another 15 000 to the Naamsa figures, said Stephanus Loubser, managing director of Nissan SA Marketing

Foreign confidence in the South African motor industry became evident this year with a number of foreign makes of cars appearing in the country following the lifting of international sanctions

Apart from Hyundai, manufacturers like Peugeot, Volvo, Saab and Alfa Romeo, as well as previously unknown makes such as SsangYong, Asia and Subaru have entered the fray

Ford also reinvested in local manufacturer Samcor and Delta Motor Corporation, the local makers of certain General Motors products like Opel and Isuzu, have been able

to do foreign business through support from General Motors

At the same time, the Government has reduced import tariffs in line with General Agreements on Tariffs and Trade principles from an outrageous 110% to 65%, and is expected to reduce it to 61% in January

The reduction has been designed to bring the import duty down to 41% by the year 2001

South African carmakers are, however, preparing themselves for some real competition and they have already had a taste of it from Hyundai

Estimates are that imported vehicles will make up 25% of the local market by the turn of the century

All motoring spokesmen approached admitted that a sudden drop in import taxes would spell disaster, forcing local manufacturers to shut plants and climb on the imports bandwagon.

Labour would be the losers in the end, as thousands of jobs would be lost, said Toyota public relations manager Roger Houghton.

"Toyota is investing R70-million

in a new programme, but if the tariffs had to be dropped to 41% then we might as well import and be done with it," he said

Meanwhile, local carmakers do not expect a drop in interest rates next year, which they would have liked as it would further enhance sales

"I believe present consumer spending patterns will keep interest rates high to curb inflation," said Eric Scoble, Mercedes-Benz South Africa's marketing manager for passenger cars

Sales of commercial vehicles acted as an indicator of business confidence, sources said

"We expect that the ongoing strength of fixed investment will underpin the upward trend in lorry sales," said Delta's director of sales and marketing, John Cumming

"It is essential from a long-term perspective that, with the legitimacy of the South African Government gaining acceptance abroad, South Africa has freer access to foreign capital in order to sustain the economic upswing," Cumming said

CT (BR) 13/11/95

Delta leads the export race into sub-Saharan Africa

(192)

By LEWELLYN JONES

Johannesburg — Delta Motor Corporation established itself as the leading exporter of one-ton light commercial vehicles into sub-Saharan Africa in the first eight months of this year

Andre van Rooyen, Delta's director of industrial and commercial holdings, said the Isuzu KB one-ton line-up had captured 37 percent of the market, four percentage points ahead of its nearest rival

In the passenger vehicle category, the Opel Astra and Kadett are in second place with 22 percent, behind the front-runner Toyota

"It has been our policy to pursue the export of automotive components on a worldwide basis, and to focus on the penetration of our Opel passenger and Isuzu commercial vehicles in Africa," he said

"Since being granted the rights to export vehicles into sub-Saharan Africa two years ago by Isuzu Motors of Japan and Adam Opel of Germany, Delta has progressively expanded its dealer network in Zimbabwe, Zambia, Malawi, Mauritius and Mozambique. These facilitate the regular supply of new vehicles, as well as high-quality parts and service back-up," Van Rooyen said

He said this had paid off for Delta, with one in four products now exported into African territories being supplied by the motor corporation

"In the first eight months of the year, 25 percent, or 5 784 units, of all the vehicles sold in these countries were either Opel or Isuzu vehicles. This is an impressive three percentage point growth over last year's sales," Van Rooyen said

No sign that Dorbyl destabilised union

BD 14/11/95

(192) ~~(192)~~

Renee Grawitzky

AN INDEPENDENT external investigation conducted by Aiken & Peat had been unable to find evidence linking Dorbyl's bus manufacturing division, Busaf, to alleged "third force activities" against the National Union of Metalworkers of SA (Numsa).

This investigation began after documents allegedly implicating Busaf in attempts to destabilise the union were released to the media.

These documents, allegedly compiled by Investment Surveys and addressed to the Busaf strategic planning committee, were faxed to Numsa, Cosatu and high-ranking officials at the transport department at the beginning of October.

At the time Dorbyl said the release of the documents was linked to "certain investigations" which were ongoing, and that the documents were an attempt to discredit the company in the eyes of the investigating authorities and government.

Aiken & Peat's investigation, conducted with Numsa approval, found that Busaf had engaged Investment Surveys to conduct covert investigations into the affairs of a competitor

However, the investigation could not find a link between the document allegedly compiled by Investment Surveys and Busaf.

The investigation was not able to verify the authenticity of the document as Aiken & Peat was not able to obtain the original document.

The investigation also found that a number of prominent, high-profile companies have engaged the services of Investment Surveys.

Numsa general secretary Enoch Godongwana said the union had not had time to analyse the report and could not comment.

He said that irrespective of this report, both the union and Dorbyl had committed themselves to waiting for the outcome of the police investigation.

A spokesman for the SAPS' criminal investigation service said the investigation had been completed, and the police case docket referred to the public prosecutor's office in Pretoria. He said the office would take a decision by the end of the week.

Sources within the SAPS have indicated they were unable to confirm that Investment Surveys had drafted the document for Busaf and whether the document was authentic.

Women muscle in ⁽¹⁹²⁾ on motor industry _{CP 19/11/95}

By PEARL RANTSEKENG

WOMEN Investment Portfolio is the 'sheer driving pleasure' behind WIP Motors which was launched in Johannesburg this week

The company is a joint venture between Imperial Motor Holdings, one of the country's top automotive retail groups, and WIP, a consortium of black women investors using their purchasing capacity to negotiate economic empowerment

WIP motors opened its doors in June this year and offers all the BMW vehicle sales and services

WIP and Imperial hold a 50 percent share each

WIP president Wendy

Luhabe said WIP was a portfolio investment company that intends to facilitate a significant participation of women in the economic potential of South Africa

She said WIP went for the BMW dealership because of the popularity of the car

She said one of WIP's roles was to empower women by facilitating the participation of groups of women, not only individuals

"We go beyond Gauteng That in itself is empowerment," she said

She added that they also share financial knowledge with women by conducting workshops countrywide entitled "Beyond labour and consumption"

Luhabe said "Our commitment to our vision is quite exceptional, and the contribution to the country is quite phenomenal We have not done anything as exciting, challenging and revolutionary as this before"

Minister of Public Enterprise Stella Sigcau advised that joint ventures should be based on integrity and mutual respect and not as means of using blacks as fronts for big businesses

"All that the blacks are expected to bring are so-called political contacts Such relationships are disgraceful and all of us have a responsibility to ensure that the culprits are exposed and punished," Sigcau said



BEHIND THE WHEEL . . . WIP president Wendy Luhabe seeks to empower women.

■ Pic: ANDRIES MCINEKA

She said there was an urgent need to open up the economy, to improve competitiveness and to encourage the participation of the historically disadvantaged community, which includes

women

"This joint venture is a step in that direction It is also a fine example of how partnerships or joint ventures should be structured - everyone wins," she said

More jobs created as Delta focuses on exports

ET(BR) 20/11/95 (192)

By ROY COKAYNE

Pretoria — Delta Motor Corporation in Port Elizabeth is in the throes of a four-year R610 million expansion programme

"This is a sure sign of the company's financial strength and belief in the future of South Africa," the company said in its latest annual report

Delta purchased a second assembly plant in Struandale, Port Elizabeth from Samcor a year ago for R30 million and a further R270 million would be invested in tools and refurbishment to provide an increased total production capacity of 100 000 units a year Delta recently announced it had launched a recruitment drive for more than 400 new jobs at the Struandale assembly plant More than 1 000 jobs had been created by the company in the Port Elizabeth area in the past two years, including an extra 650 jobs in its body shop and paint shop at its Kempston Road facility

A Delta spokesman said the R610 million expansion programme also included R280 million to be spent on product upgrades and other capital expenditure improvements to different

areas of its assembly plants, including its Kempston Road facility He said the expansion programme commenced last year, but at this stage did not involve any single major project

The company's annual report emphasised that for the future, Delta's growth was focused on the export market The changes this demanded involved improving quality and productivity while lowering vehicle costs

"Delta believes that it is firmly on the road from outdated mass to lean production and the vision in terms of cost, quality and delivery was shaped by international manufacturing and assembly benchmarks," it said

The company's materials holding section at the Port Elizabeth plant handled in excess of 4 200 tons and 11 000 different components on a daily basis Material usage came to more than R4 million a day

Delta said that since 80 percent of

the vehicle manufacturing cost was tied up in the materials used, improving materials management through outsourcing allowed the company to focus on its core business of assembling cars

Effective management in this area was seen as vital to the economic health of the company

Toyota plant wins exports worth R22m

ET (BR) 20/11/95 (192)

By ROY COKAYNE

Pretoria — Toyota's tool and die manufacturing plant in Prospecton near Durban has clinched three new foreign export orders worth a total of more than R22 million

They are

□ A R14,9 million contract for tooling from Toyota Australia, the first it has won for tooling from that company,

□ A R5,2 million contract from Toyota in Turkey, its second contract from this quarter, and

□ An order from August Lapple in Ireland for R2,5 million

A Toyota South Africa spokesman said its tool and die plant, which opened in 1989 at a cost of R55 million, had now covered its costs just through export orders

"We are negotiating for other big orders and are confident that the plant will be at full capacity this and next year," said the company's general manager, George Whitehead

He said the plant had established an excellent relationship with motor and component manufacturers around the world and had notched up foreign sales of R67,5 million

"Our Australian order is for suspension component dies for the Camry assembled at Toyota's plant in Altona, Melbourne. The Turkish order is to replicate some of the tooling we will be using in South Africa when we start manufacturing the all-new Corolla," he said

Since its establishment, the plant has won orders from many top international motor manufacturing companies

In December 1993, BMW Munich placed an order for floorpans for a new model. The company has consistently used the plant for follow-up orders for its new plant in the United States and Munich

The company has also made dies for a large Italian component manufacturer supplying Ferrari and Pininfarina, tooling for a pressing plant in Canada and roof panel and body side inner tools for General Motors in the United States

Quality

Whitehead said Toyota South Africa's decision to invest in only the highest quality equipment had paid dividends. The tool and die plant came on stream at a time when there was excess toolroom capacity in die manufacturing worldwide, the motor manufacturing industry was in serious international recession and plants in areas such as eastern Europe were quoting for work on the open market as their government subsidies were withdrawn

Whitehead said the plant had remained successful largely owing to the efficiencies and modern technology being used by the company while the weakness of the rand against cost currencies had assisted it in remaining competitive

Former Mercedes workers arrested

ARG 22/11/95

JOHANNESBURG. — About 140 former employees of Mercedes-Benz South Africa including their families were arrested by police after a two-hour sit-in at the company's East London plant

The former employees were part of a group of 500 workers dismissed by Mercedes-Benz in 1990 after a nine-week strike at its manufacturing plant in East London and were demanding re-employment, company spokeswoman Dalene Stroh said today:

"About 140 people were arrested last night after a short sit-in at our administrative office in East London in terms of a court order we obtained from the Supreme Court," she said

Mercedes-Benz said in a statement "The conduct of the occupants was every aggressive and it was made clear that their primary purpose was to hold a management board member, Mr Ian Russel, hostage until their demand for reinstatement was met". It said it was the fourth time that the same group had occupied the building — Reuter

Sacked workers arrested at sit-in

(192) (~~192~~)
About 140 former employees of Mercedes-Benz South Africa and their families were arrested by police late on Tuesday after a two-hour sit-in at the company's East London plant, an official said yesterday.

The former employees were part of a group of 500 workers dismissed by Mercedes-Benz (MBSA), a subsidiary of Germany's Daimler-Benz AG in 1990, after a nine-week strike at its manufacturing plant in East London. They were demanding re-employment, company spokesman Dalene Stroh said.

Mercedes-Benz said in a statement the former workers, together with some women and children, occupied the premises at 5pm and threatened to take staff hostage.

"The conduct of the occupants was very aggressive and it was made clear that their primary purpose was to hold Mr (Ian) Russel (a management board member) hostage until their demand for reinstatement was met," the statement said.

This was the fourth time the group had occupied the building, despite a Supreme Court order restraining them, the statement said.

The protesters were arrested and removed peacefully from the MBSA premises at 7pm. - Reuters

Star 23/11/95

Workers back on the job after illegal VW strike

ARG 23/11/95
Argus Correspondent

PORT ELIZABETH. — Production is back to normal at Volkswagen of South Africa after workers embarked on an illegal strike over a medical aid payment issue.

VWSA spokesman Raymond Hartle said the Uitenhage plant was operating normally yesterday after Tuesday's "illegal and unprocedural stoppage over employee demands that the co-payments made to the Sizwe Medical Aid be stopped immediately".

Mr Hartle said the co-payment meant that when an employee visited a service provider the account was forwarded to Sizwe which settled the full amount, and 20 percent of this was then deducted from the workers' pay by the company and paid over to the medical aid.

He said that in March this

1992
year, based on the financial performance of VW's Sizwe account, the medical aid requested a 31 percent contribution increase.

After consulting with Sizwe and Numsa it was agreed to rather introduce the co-payment system effective from April 1, 1995.

VWSA human resource director Brian Smith said: "The stopping of the co-payment is a very serious issue with huge financial, legal and personal implications for the company and its employees.

"One potential consequence is that employees may find themselves without medical cover and VW could be liable for costs totalling millions of rands. Management and the union are exploring a range of options in an effort to resolve the problem

Controversy sheds no light on cars most likely to be hijacked

MG 24-30/11/95 (192)

Justin Pearce

INSURANCE brokers in Johannesburg are advising clients that drivers of luxury cars such as BMWs run the most serious risk of being hijacked

BMW South Africa has in turn accused the insurance industry of giving customers inaccurate information about car hijackings and has called on the police to reveal the truth about which cars are the most likely to be hijacked

Three major insurance companies approached by a *Mail & Guardian* reporter posing as a customer were unanimous on one point: BMWs are the make of car most likely to be hijacked

At present, police keep mum about this information, in terms of a "gentlemen's agreement" with the motor industry. Police representative Faizel Kader said the purpose of the agreement was to avoid the misperceptions which might result if these figures were published in the media. Kader said the police and the motor industry had been concerned that raw data on the numbers of cars hijacked is meaningless unless it is placed in the context of the market share of each brand of car

But BMW has gone against the flow in the motor industry by calling for the statistics to be made available. "The agreement started innocently, to stop companies from scoring brownie points," said company representative Chris Moerdyk. "But now there is complete silence from the manufacturers except for BMW."

Most insurers compile their own statistics on which cars are most frequently hijacked, and this data is factored into the cost of insurance premiums for a particular car. While insurance companies are reluctant to disclose statistics to the media, customers who approach the companies for advice are told that upmarket cars — especially BMWs — carry the greatest risk of being hijacked.

"The insurance industry is working off perceptions, not statistics," Moerdyk

said, arguing that in the absence of police data the insurers had become caught up in a popular perception that drivers of expensive cars were at risk. This perception was created by the fact that big-time hijackings are more likely to make the news than the far more common hijacking of less valuable cars in the townships

Moerdyk said his company had done its own research on the topic, which indicates that the rates of car theft and hijacking are proportional to the market share of each make of vehicle. The details of these findings are to be released shortly

Although insurers were unanimous in their opinion that luxury cars were favourite targets, they were divided as to other types of vehicle

One broker said that the luxury versions of mid-market brands were also a risk — a Volkswagen Golf GTi is more likely to be hijacked than an ordinary Golf, for example. Minibuses are a popular target according to one source, and hijackers are showing an increasing interest in four-wheel-drive vehicles, which are popular north of the Limpopo. Models not more than two years old are the most desirable catches for hijackers. All the insurers acknowledged, however, that no one is entirely safe from hijacking

An Automobile Association survey of car hijackings, thefts and break-ins concludes that Toyota drivers constitute 29 percent of car crime victims, and BMW drivers 14 percent, followed by Volkswagen at 13 percent, Mazda at 10 percent, Nissan at eight percent, and Mercedes at seven percent. The AA survey does not take into account market share of the various marques, and is not comprehensive, since it relied on data submitted voluntarily by AA members and respondents to a newspaper advertisement who had been the victims of car crimes

It does, however, support the insurance industry's assumption that BMW hijackings constitute a disproportionately large part of the total number of hijackings

15 000 apply for 400 new jobs at PE car plant

ARG 24/11/95 (192)

The Argus Correspondent

PORT ELIZABETH — Unemployment is so severe in the Eastern Cape region that 15 000 people responded to advertisements for 400 new jobs in the motor industry

The 400 staff are needed for a new Delta plant, opening in Struandale next February

Eight full-time staff at the Eastern Cape Training Centre are processing the applications, which are all in writing

Prospective candidates must have matric

Delta spokesman Mark Derry said the corporation preferred to employ people who had not worked before, so it could train them from scratch.

The company is seeking assembly operators, several specialised key operators and assembly team leaders

Staff will be appointed after a stringent selection process

Earlier this year, Minister without Portfolio Jay Naidoo underlined the desperate struggle by thousands of people for a share in the Eastern Cape's limited resources when he released survey figures showing the province had the second-highest unemployment rate in the country

In Eastern Cape metropolitan areas, 32,4 percent of the workforce is unemployed

In the province's rural areas, 60 percent of people are unemployed — the highest rate of all nine provinces

Mr Naidoo said the Eastern Cape and Northern Transvaal — where urban joblessness was highest — were most in need of human resource development

Training centre communications manager Dave Randle said applications for the latest recruitment project were the highest number yet processed by the centre.

"There are a lot of people with relatively good qualifications unemployed in Port Elizabeth

"More and more pupils are matriculating each year, and this leads to greater unemployment"

Mr Randle said about 800 to 900 previously unemployed workers were involved in Reconstruction and Development Programme (RDP) job-creation projects

They were being trained in plumbing, bricklaying and other trades

"Hopefully, as business and investor confidence increases, the situation will improve," he said

Customers To

win as motor dealers get ready for war

(192) ST (BT) 26/11/95

By DON ROBERTSON

NEW cars will be cheaper in real terms next year as motor dealers and manufacturers face competition from imports and a resulting cut in profit margins, says Brand Pretorius, chairman and chief executive of McCarthy Motor Holdings

"There is a war out there. Customers will win and dealers will lose when it comes to finances," he says

But with lower dealer margins customers should not expect the same level of service from dealers, many of whom might have to move to less plush showrooms, he says

Intense competition brought about by the phasing down of duties on imported cars in terms of the Motor Industry Development Programme will restrict price increases as more cars and models become available.

"I expect to see the number of makes increase to 17 and the number of models to 75 within three years compared with the 13 and 64 of today," says Mr Pretorius

These factors will drastically reshape the role of dealers who will have to trim break-even levels and may have to lay off staff.

"Dealer margins were around 17% but have been cut to about 12,5% in recent months and in the quest to enhance affordability and to increase value to customers, they will continue to decline

"As a result established manufacturers may have no option but to reduce the number of dealer outlets, while multi-franchising of a number of vehicle makes may become the survival mechanism and dealer choice, now restricted by franchise agreement, may be entrenched in legislation," he says

To overcome these challenges, McCarthy has introduced various solutions which it believes will allow sales of new cars to increase to 45 000 and used cars to 28 000 in the current financial year

A focal area will be reduction in property costs as showrooms are moved to cheaper areas while deliveries will be based more closely on orders, keeping new vehicle and parts stockholdings down. Mr Pretorius believes excess stock of new vehicles in the dealer system is now worth about R500-million

Information technology will be increasingly used to reduce stockholding — currently about R300-million in McCarthy Motors — to customise orders, trace vehicles and communicate with customers. Vertical integration will be accelerated which will reduce the work done outside the group, while efforts will be made to regain business from fast-fit chains

Despite the margin squeeze, customer satisfaction will remain a key priority

"If customer service levels do not match up, the offending dealers might be penalised by their manufacturers. Customer service will become the most important differentiating factor in this highly competitive market in which reliability and quality of all vehicles is taken as a given

"We remain positive about the future of the industry and the future of McCarthy, but we must recognise that the business has changed forever," he says.

Similar challenges face motor manufacturers

Bert Wessels, chairman of Toyota, says customers will benefit from the more open market now being experienced in South Africa

"The higher level of competition has encouraged established local manufacturers to examine cost structures and to act to reduce costs. This, linked to the stability in the value of the rand and lower inflation, has led to a marked slowdown in vehicle price increases with pricing restraint on the part of local manufacturers"

Manufacturers are also facing difficulties with the MIDP, says Mr Wessels

Referring to the assembly of vehicles by Hyundai in Botswana, Mr Wessels says it is quite obvious to all that in some instances, the government is unable or unwilling, perhaps because of underlying diplomatic pressure, to deal with the flow of semi-knocked down units that violate the spirit of the MIDP

"An even greater threat is posed by the emergence of a trade in imported used vehicles. The South African government does not issue permits for the large-scale importation of these vehicles but cannot stop other SA Customs Union countries from doing so and inevitably these vehicles have South Africa as the ultimate destination," he says

Another problem is the importation of relatively low cost, unsophisticated vehicles from Eastern Europe and Asia, for which there is no commitment for future parts and service facilities

Toyota will in future put more emphasis on export opportunities which have opened up, especially when volume production of left-hand drive vehicles begins soon. This will benefit the company and the customer as it will add economies of scale which will help contain costs



BRAND PRETORIUS

ERS

2

M

ersity

year

of the

bour

rture

ss or

have

must

New straight and narrow Benz

Certain vehicles will be cut from the Mercedes Benz range, reports
Karen Harverson

MERCEDES BENZ of South Africa, in keeping with local motor industry sentiment to cut production of low volume models, will no longer manufacture all Mercedes Benz ranges but stick to the C-class model and limited production of the E-class

Production of the S-class and present E-class models will cease by November this year.

"We have the most complicated Mercedes Benz factory in the world and it's just not viable to continue to manufacture the whole range of Mercedes Benz cars, the Honda Balade cars, the Mitsubishi Colt and our heavy commercial vehicle range all under one roof," said managing director Christoph Köpke, speaking at a press conference held at the East London manufacturing plant last week.

He said the United States — which produces 12-million units compared to South Africa's 400 000 — was the most competitive producer in the world and the local market was hard pressed to compete

"We are not Mexico with the world's biggest market on our doorstep so the logistics of becoming a competence centre for fully built up vehicles is extremely difficult."

Instead, Köpke said the salvation of the local industry lay in the component industry "There are components in this industry which can be

(192) MG (mm) 27/10 - 2/11/95
manufactured at world class standards and exported"

The company will export more than R600-million worth of components this year such as catalytic converters, gearboxes, aluminium components, jacks, alloys wheels and leather upholstery "Our target in the

next two to three years is to reach R1-billion in future component exports"

On the heavy truck market, he said international pressure was fierce "Two years ago there were four competitors in the market — this has risen to 15 of which the US is the most competitive"

He added that the price of trucks had been reduced by five percent in the past two years and would fall a further 4,5 percent in November this year.

The company is in the process of re-engineering and reduced its overheads last year by more than R283-million compared to 1989.

Production in 1995 has doubled to 41 800 units compared to 21 500 units in 1989 In the same period, employment dropped from 5 519 to 4 300

"Having reduced overheads by R283-million, no further jobs are at risk, and we'll now be attacking the systems and processes within the company," Köpke said

He forecasts the company will post an increase in rand turnover of more than 50 percent this year compared to 1994 with turnover expected to breach the R5-billion mark by year end

"We have the third biggest turnover of all the Mercedes Benz operations in the world despite currency pressures and increased competition as a result of change in local content regulations," says Köpke

ADE negotiates road to the

future

(192)CT(BR)30/11/95

BY LLEWELLYN JONES

Cape Town — Atlantis Diesel Engines has bitten the bullet of restructuring that will hopefully propel the company into the 21st century as a global player

Arising out of South Africa's need to ensure a steady supply of diesel engines during the sanctions era, the company was only marginally profitable up to 1990 with the help of ever increasing prices and various subsidies and tax breaks

But in the past five years, the company's prices have fallen in real terms as it waged battle on costs and strived for competitiveness, first using its own resources and later in partnership with Gemini Consulting

Ron Shures, the managing director, said the company recognised the need for radical change in 1990 when it became clear that the South African market would open up

"Change came with the recognition that the domestic market was under tremendous threat and we needed to create new markets for the company," Shures said

"The company was born out of the apartheid era. We were a strategic industry put in place to satisfy South Africa's need for engines and we realised this role would disappear under a new dispensation"

But the company was competitive in certain areas of its business. Like all monopolies it was bureaucratic in its approach, not price competitive, had very little sensitivity to its customers and none of the characteristics of an international player

For three years, management set about removing costs, reducing manpower and introducing changes to the company's customer focus using management theory gleaned from leading texts

"While the big blitz had made the company a leaner organisation, it had not necessarily ensured long-term competitiveness," Shures said

At this time, it was introduced to Gemini Consulting by the University of Stellenbosch. It had been involved in a strategic planning exercise with the university

"There were things we had to do which are difficult to inflict on yourself and probably couldn't be done without help," Shures

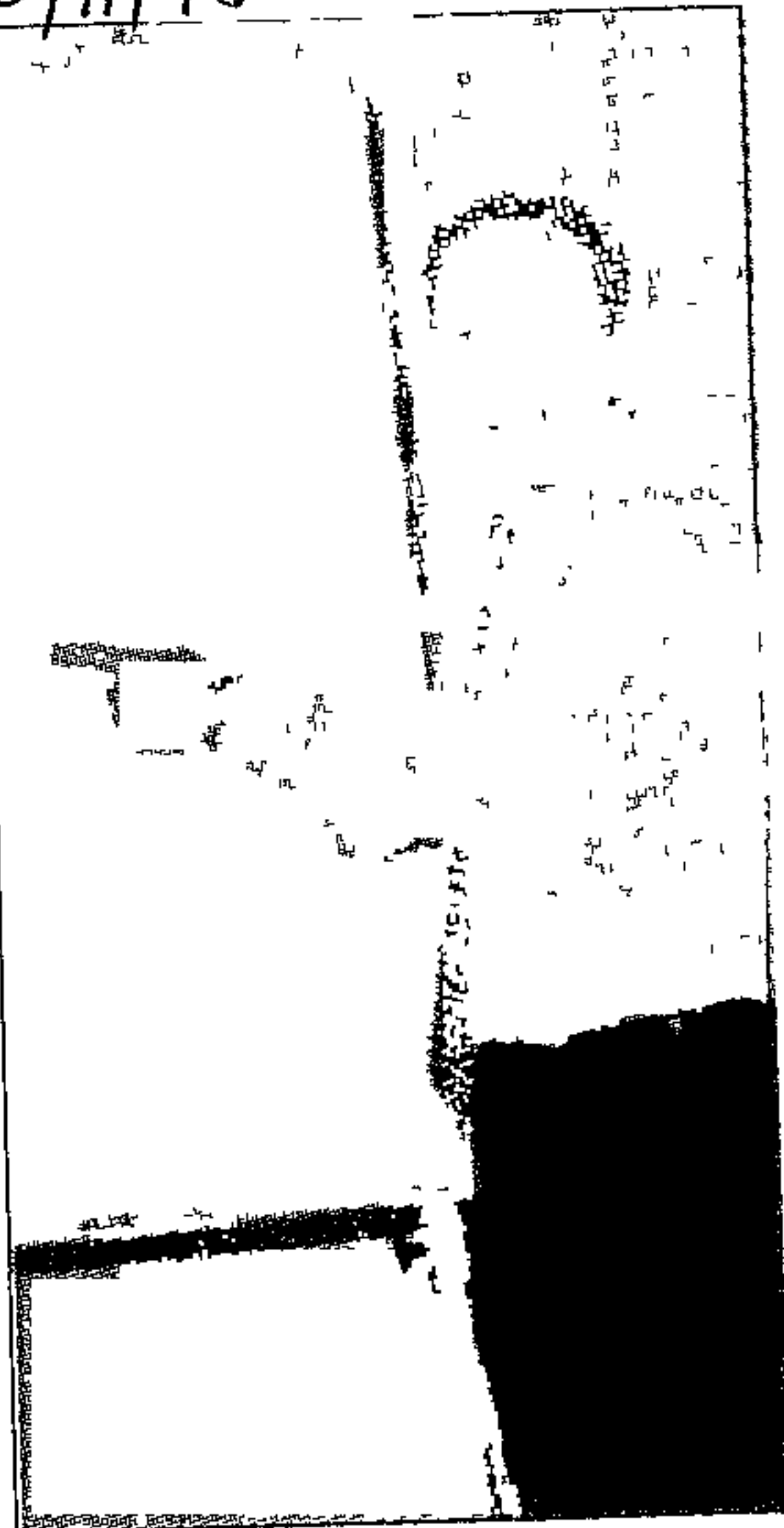

BIG BLITZ Ron Shures, the managing director of Atlantis Diesel Engines, says the group has undergone restructuring that will hopefully take it into the 21st century as a global player

said. The company's partnership with Gemini focussed on strategies for growth and improving operational effectiveness

"The problem areas identified — organisational structure, productivity, stock levels and cycle compression — are typical of just about every manufacturing company. But just like any other manufacturing company, we found other priorities always overtaking us, pushing what really needed to be addressed down the list"

Shures said the company had moved from a position where it believed it would have to diversify to survive. "I like to give the example that we came inches away from buying a bicycle factory. Sense pre-

vailed as we realised we could bring nothing to an already ailing bicycle factory." The partnership outlined four elements for future competitiveness

- A recognition that the engines business would diminish and the development of a defensive strategy around that to extend it as long as possible,

- A still growing parts business,
- A distribution business which would be the powerhouse component, and

- Component exports, primarily in cylinder blocks and crankshafts, to be pursued aggressively

In the latter category, the company had certain intrinsic advantages — a purpose built block foundry, the second-cheapest electricity in the world and relatively cheap labour — that could bring about global competitiveness

Although it exports goods worth R150 million a year it aims to expand that to R400 million within three years

John Davies, the foundries senior general manager, said the partnership with Gemini helped the company focus closer attention on the potential and actual target markets for products and to restrict them to those where the company could add value

"We realised our core competencies were in the production of large crank cases and cylinder blocks," Davies said. "There are few competitors who can make large in-line or V-configured cylinder blocks or multi-impression small cylinder blocks"

At the operational level, a new shop floor approach involved team-based techniques never before used in the company and an ethos of empowerment

John Smuts, the melting manager, said employees were initially terribly negative because they did not believe that management could rid itself of its old style and change its culture

Smuts inherited what was probably the most fractious area of the operation, with poor discipline and safety levels. But under his guidance, melting has become the most successful area, improving its capacity from 80 tons to 120 tons a day

He has done this by building a sense of competition and achievement in the teams

and encouraging them to learn their job to invite promotion operators can do any job. The phrase 'not my job' is seldom heard"

But the level of buy-in to the team structure still has some way to go. Fear of commitment, loss of status and lack of enthusiasm within the team framework has made the process a long slog

"But people become more enthusiastic the more they win," Smuts said. "The management largon was 'celebrating successes'. Success breeds belief in the system and, in turn, builds enthusiasm"

According to Davies, one of the downsides of transformation is that those who "don't get it" end up "losing out"

Another problem slowing down the momentum was the lack of union involvement. Shures said the company decided at the beginning of the process that union involvement would be limited. "We would do it quite differently now, even involving the union at the executive level. Union involvement in the planning stage would have made the implementation process much easier going"

Despite this, he said, one of the key benefits was the stream of ideas coming from the shop floor. "We have never had this sort of involvement from the rank and file before. Through empowerment and involvement, productivity is continually improving. We have some way to go before we can be assured of our global competitiveness, but this drive to succeed is the real success for me"

The question that begs to be answered is where the company will be 20 years from now?

Although breakthroughs in battery technology were bound to see electric cars become the standard, Shures said the conversion ratios needed to power large trucks using batteries were a lot further off. "In 20 years, trucks will probably still be powered by something akin to a diesel engine"

As for becoming a global player, the jury is still out, but the company already supplies to SaangYong and Daewoo of Korea, and the Detroit Diesel Corporation of the United States