

Industrial Relations — Employers' Organ.

1982

JAN. — DEC.

Strikes not disaster—Reynders

SOUTH AFRICANS must expect more strikes by black trade unions, says Dr H J J Reynders, chairman of the National Manpower Commission.

Strikes were a normal part of the collective bargaining situation, and with the growth of the black trade union movement, there was likely to be an increase in the

number of strikes, he told delegates to an advanced management programme at the University of Cape Town's Graduate School of Business.

He said strikes by black unions should not be regarded as a national disaster.

Another factor likely to lead to an increase in the number of strikes was the lack of experience by both management and labour in the intricacies of collective bargaining.

Many of last year's strikes would have been quickly solved had the participants had more experience.

Most of the strikes were really only work stoppages occasioned by small disputes.

Dr Reynders condemned those employers who called for the police or for officials of the Department of Manpower at the first signs of a labour dispute.

'They must learn to handle these themselves. We should be the last people to be called in,' he said.

Questioned on the need to bring in immigrants to do skilled work, Dr Reynders said even if there were an unlimited number of suitable blacks available, it would take several years to train them and South Africa could not afford this delay.

However, the number of black apprentices was small—about 400. This partly reflected the unwillingness of black matriculants to enter into apprenticeships and also the poor standard of their education.

However, some companies were now providing crash courses in mathematics for these people and were having considerable success, getting a 90 percent pass rate.

ARGUS 14/1/82 (133) #2

The chart depicts the relationship between the variables in the model.

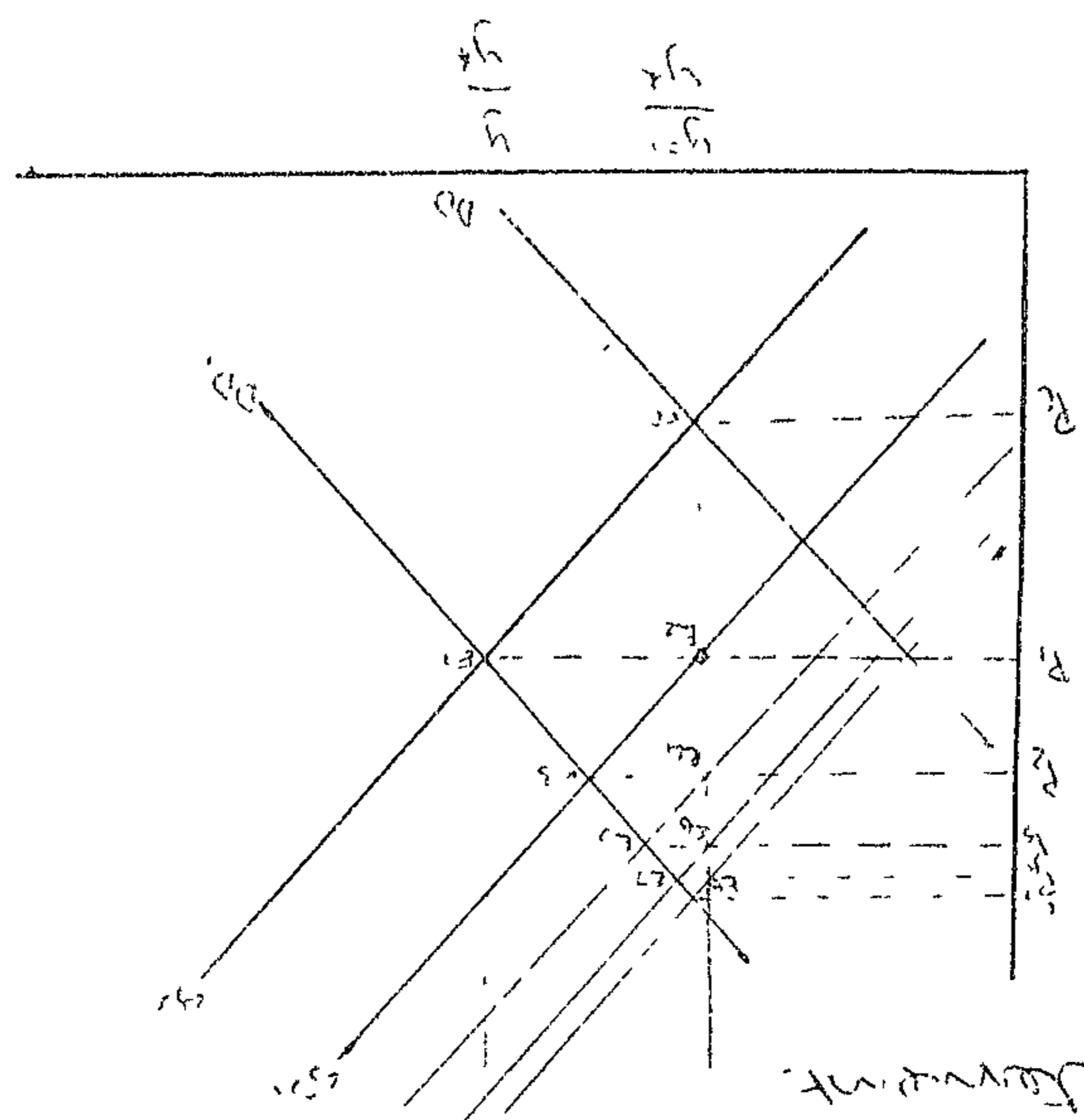

The Phillips curve is derived from the Phillips short-run curve which is a downward-sloping curve. This is because the rate of change of the Phillips short-run curve is negative effect in the economy as if any rate is negative effect in the economy on the economy in the long run is dead weight loss. The rate curves will be discussed in the following way the real volatility of the above

(8)

KENNISGEWING 49 VAN 1982

DEPARTEMENT VAN MANNEKRAG

WET OP ARBEIDSVERHOUDINGE, 1956

AANSOEK OM VERANDERING VAN DIE REGISTRASIEBESTEK VAN 'N WERKGEWERSORGANISASIE

Ek, Mattheus Willem Johannes le Roux, Nywerheidsregisrateur, maak ingevolge artikel 4 (2), soos toegepas by artikel 7 (5), van bogenoemde Wet hierby bekend dat 'n aansoek om die verandering van sy registrasiebestek ontvang is van die Natal Soft Drink Manufacturers' Association Besonderhede van die aansoek word in onderstaande tabel verstrek

Enige geregistreerde werkgewersorganisasie wat teen die aansoek beswaar maak, word versoek om binne een maand na die datum van publikasie van hierdie kennisgewing sy beswaar skriftelik by my in te dien, p/a die Departement van Mannekrag, Mannekraggebou 449, Schoemanstraat 215, Pretoria (posadres Privaatsak X117, Pretoria, 0001)

TABEL

Naam van werkgewersorganisasie — Natal Soft Drink Manufacturers' Association

Datum waarop aansoek ingedien is — 2 November 1981.

Belange en gebied ten opsigte waarvan aansoek gedoen word — Werkgewers betrokke by die Sagtedrankvervaardigingsnywerheid in die provinsie Natal

“Sagtedrankvervaardigingsnywerheid” of “Nywerheid” beteken, sonder om die gewone betekenis van die uitdrukking enigsins te beperk, die nywerheid waar sagtedranke berei, vervaardig, gebottel, geblik of andersins in 'n houer geplaas, toegedraai en/of verpak word

“sagtedrank” beteken enige vloeistof wat bedoel is vir verkoop as 'n drank vir menslike verbruik en sluit in—

- (a) enige vrugte- of groentedrank,
 - (b) water, sodawater, Indiese of kinientonikumwater, natuurlike fonteinwater en enige versoete kunsmatig gekarboneerde wáter, hetsy gegeur of ongegeur,
 - (c) gemmerbier of enige kruie- of plantdrank,
 - (d) vrugtesap, versoet of onversoet, kwasse en stroopdranke,
 - (e) gegeurde gortwater en vloeistofprodukte wat by die bereiding van gortwater gebruik word,
 - (f) enige hoeproteïendrank; en
 - (g) enige ander onversoete drank;
- maar sluit nie die volgende in nie
- (i) melk of enigiets wat van melk berei is,
 - (ii) tee, koffie, kakao of sjokolade of enigiets wat daarvan berei is;
 - (iii) enige eierprodukt;
 - (iv) vleis- of gisekstrakte, sop of sopmengsels, en
 - (v) enige drank binne die bepalinge van die Drankwet, 1977 (Wet 87 van 1977), soos gewysig.

Posadres van applikant — Posbus 1177, Durban, 4000

Kantooradres van applikant — Ridgeweg 491, Durban, 4001

Die aandag word gevestig op onderstaande vereistes van artikels 4 en 7 van die Wet

(a) Die mate waarin 'n beswaarmakende werkgewersorganisasie verteenwoordigend is, word ingevolge artikel 4 (4), soos toegepas by artikel 7 (5), bepaal volgens die feite soos hulle bestaan het op die datum waarop die aansoek ingedien is, en wat die lidmaatskap betref, word alleen lede wat ingevolge artikel 1 (2) van die Wet op voormelde datum volwaardige lede was, in aanmerking geneem

NOTICE 49 OF 1982

DEPARTMENT OF MANPOWER

LABOUR RELATIONS ACT, 1956

APPLICATION FOR VARIATION OF SCOPE OF REGISTRATION OF AN EMPLOYERS' ORGANISATION

I, Mattheus Willem Johannes le Roux, Industrial Registrar, do hereby, in terms of section 4 (2) as applied by section 7 (5) of the above-mentioned Act, give notice that an application for the variation of its scope of registration has been received from the Natal Soft Drink Manufacturers' Association Particulars of the application are reflected in the subjoined table

Any registered employers' organisation which objects to the application is invited to lodge its objection in writing with me, c/o the Department of Manpower, 449 Manpower Buildings, 215 Schoeman Street, Pretoria (postal address Private Bag X117, Pretoria, 0001), within one month of the date of publication of this notice

TABLE

Name of employers' organisation — Natal Soft Drink Manufacturers' Association.

Date on which application was lodged — 2 November 1981.

Interests and area in respect of which application is made — Employers engaged in the Soft Drink Manufacturing Industry in the Province of Natal

“Soft Drink Manufacturing Industry” or “Industry” means, without in any way limiting the ordinary meaning of the term, the industry in which soft drinks are prepared, manufactured, bottled, canned or otherwise containerised, wrapped and/or packed

“soft drink” means any liquid intended for sale as a drink for human consumption, and includes—

- (a) any fruit or vegetable drink;
- (b) water, soda water, Indian or quinine tonic water, natural spring water and any sweetened artificially carbonated water, whether flavoured or unflavoured,
- (c) ginger beer and any herbal or botanical beverage;
- (d) fruit juice, sweetened or unsweetened, squashes and cordials;
- (e) flavoured barley water and liquid products used in the preparation of barley water,
- (f) any high-protein drink, and
- (g) any other unsweetened drink,

but does not include—

- (i) milk or any preparation of milk;
- (ii) tea, coffee, cocoa or chocolate, or any preparation thereof,
- (iii) any egg product,
- (iv) meat or yeast extracts, soup or soup mixtures, and
- (v) any drink falling within the provisions of the Liquor Act, 1977 (Act 87 of 1977), as amended

Postal address of applicant — P O. Box 1177, Durban, 4000.

Office address of applicant. — 491 Ridge Road, Durban, 4001

Attention is drawn to the following requirements of sections 4 and 7 of the Act:

(a) The representativeness of any employers' organisation which objects to the application shall in terms of section 4 (4) as applied by section 7 (5) be determined on the facts as they existed at the date on which the application was lodged and, as far as membership is concerned, only members who were in good standing in terms of section 1 (2) of the Act as at the aforesaid date shall be taken into consideration.

I R - Employer

128

eenheid
unit

Iste een
1st unit
... dan
... caeter
die Iste
1st unit
heid/pe

die Iste
1st unit
eenheid
there

ENT

other
on of
of 19
Com-

of the
fact
ovi-
to
by
eme
the
rom
to
te
-t
-ie
-y

g
ion
y
el

v-

2
-
-
-
-

(b) Die prosedure voorgeskryf by artikel 4 (2) moet gevolg word in verband met 'n beswaar wat ingedien word
M W. J. LE ROUX, Nywerheidsregistrateur
(22 Januarie 1982)

(b) The procedure laid down in section 4 (2) must be followed in connection with any objection lodged
M W J LE ROUX, Industrial Registrar
(22 January 1982)

KENNISGEWING 50 VAN 1982
DEPARTEMENT VAN MANNEKRAG
WET OP ARBEIDSVERHOUDINGE, 1956
INTREKKING VAN REGISTRASIE VAN 'N
WERKGEWERSORGANISASIE

Ek, Mattheus Willem Johannes le Roux, Nywerheidsregistrateur, maak hierby kragtens artikel 14 (1) van die Wet op Arbeidsverhoudinge, 1954, bekend dat aangesien ek rede het om te vermoed dat die Port Elizabeth en Uitenhage Master Hairdressers' Association gelikwieder is, sy registrasie ingetrek sal word tensy redes daarteen binne 'n tydperk van 30 dae vanaf die datum van publikasie van hierdie kennisgewing aangevoer word.

M W. J. LE ROUX, Nywerheidsregistrateur
(22 Januarie 1982)

138 NOTICE 50 OF 1982
DEPARTMENT OF MANPOWER
LABOUR RELATIONS ACT, 1956
CANCELLATION OF REGISTRATION OF AN
EMPLOYERS' ORGANISATION

I, Mattheus Willem Johannes le Roux, Industrial Registrar, hereby notify in terms of section 14 (1) of the Labour Relations Act, 1956, that as I have reason to believe that the Port Elizabeth and Uitenhage Master Hairdressers' Association has been wound up, its registration will be cancelled unless cause to the contrary is shown within a period of 30 days from the date of publication of this notice

M. W. J LE ROUX, Industrial Registrar.
(22 January 1982)

KENNISGEWING 51 VAN 1982
KENNISGEWING VAN 'N VERGADERING VAN
SKULDEISERS KRAGTENS ARTIKEL 22 (1) VAN DIE
WET OP LANDBOUKREDIET, 1966

Hierby word 'n vergadering van ondergenoemde applikant en sy skuldeisers op die plek en datum hieronder genoem belê, met die doel om skuldeisers in staat te stel om hul vorderings teen die applikant te bewys en 'n skikkingsvoorstel van die Landboukredietraad te oorweeg

D W. IMMELMAN, Direkteur-generaal Landbou en Visserye

Aansoek van/Application by
Abraham Nel, Barnard, Posbus/P O Box 161,
Dewetsdorp
(22 Januarie 1982)/(22 January 1982)

Plek van byeenkoms/Place of meeting
Kantoor van die Landdros/Office of the Magistrate,
Dewetsdorp

Datum en tyd/Date and time
10 Maart/March 1982 om/at 10h00

NOTICE 51 OF 1982
NOTICE OF A MEETING OF CREDITORS IN TERMS
OF SECTION 22 (1) OF THE AGRICULTURAL CREDIT
ACT, 1966

A meeting of the undermentioned applicant and his creditors is hereby convened at the place and date mentioned hereunder for the purpose of enabling creditors to prove their claims against the applicant and of considering a proposal for a compromise by the Agricultural Credit Board

D W. IMMELMAN, Director-General: Agriculture and Fisheries

KENNISGEWING 52 VAN 1982
DOEANE- EN AKSYNSTARIEFAANSOEKE —
LYS 1/82

Onderstaande aansoeke betreffende die Doeane- en Aksynstarief is deur die Raad van Handel en Nywerheid ontvang. Enige beswaar teen of kommentaar op hierdie vertoe moet binne ses weke na die datum van hierdie kennisgewing aan die Raad van Handel en Nywerheid, Privaatsak X342, Pretoria, 0001, gerig word.

Verhoging van die reg op:

Sjokolade en suikergoed wat kakao bevat, indeelbaar by tariefsubpos 18 06.20, van 27,5 persent *ad valorem* of 33c per kg tot 48 persent *ad valorem* of R1,20 per kg [RHN-verw T5/2/4/2/1 (B68/81).]

Applikant:

Suid-Afrikaanse Sjokolade- en Lekkergoedvervaardigersvereniging, Posbus 933, Pretoria, 0001.

Intrekking van die kortingsfasiliteit ten opsigte van:

Talolievetsure, vir gebruik in die flotteringsproses in die mynbounywerheid (item 305.01/15.10). [RHN-verw T5/2/6/2/4 (E1/82).]

NOTICE 52 OF 1982
CUSTOMS AND EXCISE TARIFF APPLICATIONS.—
LIST 1/82

The following applications concerning the Customs and Excise Tariff have been received by the Board of Trade and Industries. Any objections to or comments on these representations must be submitted to the Board of Trade and Industries, Private Bag X342, Pretoria, 0001, within six weeks of the date of this notice.

Increase in the duty on.

Chocolate and sugar confectionary containing cocoa, classifiable under tariff subheading 18 06 20, from 27,5 per cent *ad valorem* or 33c per kg to 48 per cent *ad valorem* or R1,20 per kg [BTI Ref T5/2/4/2/1 (B68/81)]

Applicant:

South African Chocolate and Sweet Manufacturers' Association, P.O. Box 933, Pretoria, 0001.

Withdrawal of the rebate facilities in respect of:

Tall oil fatty acids, for use in the flotation process in the mining industry (item 305 01/15.10). [BTI Ref. T5/2/6/2/4 (E1/82).]

Politics

Sunday

lowers

mine

mineral

24/1/82

prices

Finance Reporter

PRESSURE from overseas politicians and to a much smaller extent from the Chamber of Mines to force them to close the wage gap between black and white mineworkers is making it increasingly difficult for small South African base-mineral producers to stay in the export market.

Without export they cannot survive.

This pressure is constantly increasing at a time when there are already mountains of base minerals in many parts of the Europe. The only way to sell is to drop prices to dangerously low levels.

Wille Brugner, managing director of Metramco, a subsidiary of the powerful Klockner Group, said nearly all the pressure to close the wage gap emanated from politicians in the EEC countries.

"Paradoxically, people who buy our products in their countries do not want to pay any more," he said. "They want us to reduce our prices and frequently buy from producers in countries where mineworkers are not even paid a headline wage."

"Our costs have risen tremendously in the past four to six years and we are paying our black mineworkers between six and eight times as much. However they want us to pay them about four times as much as they are getting now."

"Those people are not bothered about asking for any increase in productivity or persuading firms to pay us more."

Brugner said he was obliged to render "progress reports" on black mine-workers twice a year.

"It doesn't matter what progress we report, it is never enough. We are always criticised for not doing enough and, invariably, those reports are leaked to the overseas Press in such a way that we are damned and condemned."

A spokesman for the Otavi Mining company, Agilolf Fock, who does not want to be named, agreed with Brugner in part, but added that there was little doubt that the Chamber of Mines' avowed policy of closing the wage gap between black and white mineworkers was forcing costs up to such an extent that it was now most difficult and sometimes impossible to meet competition abroad.

133 plc

Naam van persoon Name of person	Geboortedatum Date of birth	Geboorteland Place of birth	Huidige nasionaliteit Present nationality	Datum van verklaring Date of declaration	Permanente verblyfpermitnommer Permanent residence permit number
Ramositli, Manini Rosy Mohapi	-/1/38	Suid-Afrika/South Africa	Burger van Lesotho/Citizen of Lesotho	24/8/81	19bis (1) (a) (ii) (bb)
Rathebe, Johanna Melata	4/9/38	Suid-Afrika/South Africa	Burger van Lesotho/Citizen of Lesotho	16/7/81	19bis (1) (a) (ii) (bb)
Schuller, Lilian Rose	10/1/26	Suid-Afrika/South Africa	Burger van Duitsland/Citizen of Germany	29/9/81	19bis (1) (a) (ii) (bb)
Sibi, Olivia Mamontseng	-/1/37	Suid-Afrika/South Africa	Burger van Lesotho/Citizen of Lesotho	6/7/81	19bis (1) (a) (ii) (bb)
Songca, Sasha Natasha	7/9/58	Suid-Afrika/South Africa	Burger van Lesotho/Citizen of Lesotho	26/10/81	19bis (1) (a) (ii) (bb)
Soqaka, Diniwi Dorothy	26/9/38	Suid-Afrika/South Africa	Burger van Lesotho/Citizen of Lesotho	8/7/81	19bis (1) (a) (ii) (bb)
Soyiswaphi, Lirontso Agnes	17/4/50	Suid-Afrika/South Africa	Burger van Lesotho/Citizen of Lesotho	26/10/81	19bis (1) (a) (ii) (bb)
Speyers, Joyce Alice	30/1/19	Suid-Afrika/South Africa	Burger van Nederland/Citizen of The Netherlands	14/8/81	19bis (1) (a) (ii) (bb)
Stona, Tselane Elizabeth	2/2/26	Suid-Afrika/South Africa	Burger van Lesotho/Citizen of Lesotho	23/11/81	19bis (1) (a) (ii) (bb)
Tau, Isaac	10/6/20	Suid-Afrika/South Africa	Burger van Lesotho/Citizen of Lesotho	19/1/81	19bis (1) (a) (ii) (bb)
Tayleur, Trevor Nigel Lindsay	31/12/55	Verenigde Koninkryk/United Kingdom	Burger van Verenigde Koninkryk/Citizen of the United Kingdom	8/7/81	16 (2)
Tseka, Sele Cicilia	± 1944	Suid-Afrika/South Africa	Burger van Lesotho/Citizen of Lesotho	7/10/81	19bis (1) (a) (ii) (bb)
Tsibela, Mapulumu Almah	29/2/58	Suid-Afrika/South Africa	Burger van Lesotho/Citizen of Lesotho	28/7/81	19bis (1) (a) (ii) (bb)
Zamrazil, Martin	25/7/70	Suid-Afrika/South Africa	Burger van Oostenryk/Citizen of Austria	10/7/81	16 (2)

(5 Februarie 1982)/(5 February 1982)

KENNISGEWING 73 VAN 1982
DEPARTEMENT VAN MANNEKRAG
WET OP ARBEIDSVERHOUDINGE, 1956

AANSOEK OM VERANDERING VAN DIE REGISTRASIEBESTEK VAN 'N WERKGEWERSORGANISASIE

Ek, Mattheus Willem Johannes le Roux, Nywerheidsregistrator, maak ingevolge artikel 4 (2), soos toegepas by artikel 7 (5), van bogenoemde Wet, hierby bekend dat 'n aansoek om die verandering van sy registrasiebestek ontvang is van die South Western Furniture Manufacturers' Association. Besonderhede van die aansoek word in onderstaande tabel verstrek.

Enge geregistreerde werkgewersorganisasie wat teen die aansoek beswaar maak, word versoek om binne een maand na die datum van publikasie van hierdie kennisgewing sy beswaar skriftelik by my in te dien, p/a die Departement van Mannekrag, Mannekraggebou 449, Schoemanstraat 215, Pretoria (posadres Privaatsak X117, Pretoria, 0001).

TABEL

Naam van werkgewersorganisasie —South Western Furniture Manufacturers' Association

Datum waarop aansoek ingedien is.—1 Desember 1981

Belange en gebied ten opsigte waarvan aansoek gedoen word —Werkgewers betrokke by die Meubelnywerheid in die landdrostdistrikte George, Knysna, Mosselbaai en Oudtshoorn.

“Meubelnywerheid” beteken, sonder om die gewone betekenis van die uitdrukking enigsins te beperk, die vervaardiging, hetsy in die geheel of gedeeltelik, van alle tipes meubels, ongeag die materiaal wat gebruik word, en dit sluit die volgende werksaamhede in.

NOTICE 73 OF 1982

DEPARTMENT OF MANPOWER
LABOUR RELATIONS ACT, 1956

APPLICATION FOR VARIATION OF SCOPE OF REGISTRATION OF AN EMPLOYERS' ORGANISATION

I, Mattheus Willem Johannes le Roux, Industrial Registrar, do hereby, in terms of section 4 (2) as applied by section 7 (5) of the above-mentioned Act, give notice that an application for the variation of its scope of registration has been received from the South Western Furniture Manufacturers' Association. Particulars of the application are reflected in the subjoined table.

Any registered employers' organisation which objects to the application is invited to lodge its objection in writing with me, c/o the Department of Manpower, 449 Manpower Buildings, 215 Schoeman Street, Pretoria (postal address Private Bag X117, Pretoria, 0001), within one month of the date of publication of this notice.

TABEL

Name of employers' organisation —South Western Furniture Manufacturers' Association

Date on which application was lodged —1 December 1981

Interests and area in respect of which application is made —Employers engaged in the Furniture Manufacturing Industry in the Magisterial Districts of George, Knysna, Mossel Bay and Oudtshoorn.

“Furniture Manufacturing Industry” means, without in any way limiting the ordinary meaning of the expression, the manufacture either in whole or in part of all types of furniture irrespective of the materials used, and includes the following operations.

Heelmaak-, stoffeer-, herstoffeer-, beits-, spuit- of poleerwerk en/of herpoleerwerk, die maak van los oortreksels en/of stoelkussings en/of gordyne en/of die maak en/of die heelmaak van raamveermatrasse en/of rame vir stoffeerwerk, houtmasjienwerk, fineerwerk of houtdraaiwerk, houtsnijwerk in verband met die vervaardiging en/of heelmaak van meubels, die poleer en/of herpoleer van klaviere, die vervaardiging van en/of beits, spuit en poleer en/of herpoleer van meubels vir teekamers, kantore, kerke, skole, kroee en teaters en kabinette vir musiekinstrumente en radio- of draadlooskabinette en die draai en/of uitsny uit hout van ornamente en/of siersels, en sluit in die vervaardiging van of die prosesse in die vervaardiging van beddegoed, wat só omskryf en uitgelê moet word dat dit alle soorte matrasse, veermatrasse, bo-matrasse, kopkussings, peule en stoelkussings insluit, en ook die werksaamhede wat uitgevoer word op alle persele waar houtmasjienwerk, houtdraaiwerk en/of houtsnijwerk uitgevoer word in verband met die vervaardiging van meubels; en ook nog die heelmaak, herstoffeer of herpoleer van meubels in of in verband met bedryfsinrigtings waarin die vervaardiging van meubels of enige werksaamheid wat geassosieer word met die finale bereiding van 'n meubelstuk vir verkoop, of in sy geheel of gedeeltelik, uitgevoer word, en die fineerwerk aan deure van gelamelleerde blokbord of laaghout wat vir meubels gebruik word en alle gedeeltes van materiaal wat by die vervaardiging van meubels gebruik word, maar uitgesonderd die vervaardiging van artikels wat hoofsaaklik van biesies, gras en/of rottang gemaak is en die vervaardiging van metaalmeubels, met inbegrip van die vervaardiging van metaalkatels

Belange en gebied ten opsigte waarvan registrasie gehou word —Werkgewers betrokke by die Meubelnywerheid in die landdrostdistrikte George, Knysna, Mosselbaai en Oudtshoorn

Posadres van applikant —Posbus 746, Knysna, 6570

Kantooradres van applikant —p/a Fechter en Fechter (Edms) Bpk, Mainstraat 26, Knysna

Die aandag word gevestig op onderstaande vereistes van artikels 4 en 7 van die Wet

(a) Die mate waarin 'n beswaarmakende werkgewersorganisasie verteenwoordigend is, word ingevolge artikel 4 (4), soos toegepas by artikel 7 (5), bepaal volgens die feite soos hulle bestaan het op die datum waarop die aansoek ingedien is, en wat die lidmaatskap betref, word alleen lede wat ingevolge artikel 1 (2) van die Wet op voormelde datum volwaardige lede was, in aanmerking geneem

(b) Die prosedure voorgeskryf by artikel 4 (2) moet gevolg word in verband met 'n beswaar wat ingedien word

M W J LE ROUX, Nywerheidsregistrator

(5 Februarie 1982)

KENNISGEWING 74 VAN 1982

DEPARTEMENT VAN LANDBOU EN VISSERYE
WET OP AGENTSKAPSVERKOPING VAN LANDBOU-
PRODUKTE, 1975 (WET 12 VAN 1975)

Ooreenkomstig artikel 14 van die Wet op Agentskapsverkoop van Landbouprodukte, 1975 (Wet 12 van 1975), word hierby vir algemene inligting bekendgemaak dat mnr Ebrahim Mohamed wat te Cradock, onder die handelsnaam Cradock Mark, besigheid gedryf het as kommissie-agent, as sodanig vrywillig besigheid gestaak het met ingang van 17 Julie 1981

(5 Februarie 1982)

Repairing, upholstering, re-upholstering, staining, spraying or polishing and/or repolishing, the making of loose covers and/or cushions and/or curtains and/or the making and/or the repairing of box-spring mattresses and/or frames for upholstering, woodmachining, veneering or woodturning, carving in connection with the manufacture and/or repair of furniture, the polishing and/or repolishing of pianos, the manufacture and/or staining, spraying and polishing and/or repolishing of tearoom, office, church, school, bar and theatre furniture and cabinets for musical instruments and radio or wireless cabinets and the turning and/or carving out of wood of ornaments and/or novelties, and includes the manufacture or processes in the manufacture of bedding, the definition and interpretation of which includes all manner or types of mattresses, spring-mattresses, overlays, pillows, bolsters and cushions, and includes the activities carried on in any premises where wood machining, wood turning and/or carving in connection with the production of furniture is carried on, and includes further the repairing, re-upholstering or repolishing of furniture in or in connection with establishments in which the production of furniture or any operation associated with the final preparation of an article of furniture for sale, either in whole or in part, is carried on, and the veneering of laminated blockboard or plywood doors used for furniture and all parts of materials used in the construction of furniture, but excludes the manufacture of articles made principally of wicker, grass and/or cane and the manufacture of metal furniture including the manufacture of metal bedsteads

Interests and area in respect of which registration is held —Employers engaged in the Furniture Manufacturing Industry in the Magisterial Districts of George, Knysna, Mossel Bay and Oudtshoorn

Postal address of applicant —P O Box 746, Knysna, 6570

Office address of applicant —c/o Fechter & Fechter (Pty) Ltd, 26 Main Street, Knysna

Attention is drawn to the following requirements of sections 4 and 7 of the Act

(a) The representativeness of any employers' organisation which objects to the application shall in terms of section 4 (4) as applied by section 7 (5) be determined on the facts as they existed at the date on which the application was lodged and, as far as membership is concerned, only members who were in good standing in terms of section 1 (2) of the Act as at the aforesaid date shall be taken into consideration

(b) The procedure laid down in section 4 (2) must be followed in connection with any objection lodged

M. W. J. LE ROUX, Industrial Registrar

(5 February 1982)

NOTICE 74 OF 1982

DEPARTMENT OF AGRICULTURE AND FISHERIES
AGRICULTURAL PRODUCE AGENCY SALES ACT,
1975 (ACT 12 OF 1975)

It is hereby notified for general information, in terms of section 14 of the Agricultural Produce Agency Sales Act, 1975 (Act 12 of 1975), that Mr Ebrahim Mohamed who carried on business as a commission agent at Cradock, under the trade name Cradock Market, voluntarily ceased carrying on business as such with effect from 17 July 1981

(5 February 1982)

...timber-framed housing

5/2/81

133

1870

1884

Evening Post

New policy of training for electricians is big success

By FRED ROFFEY
Business Editor

A NEW policy adopted by the electrical construction industry of emphasising practical training is paying handsomely

The industry's compulsory training programme for apprentices of three 40-hour sessions a year has proved to be a success as a result of the practical experience they gain

Mr James Baker, director of the Electrical Contractors' Association (ECA), says some two years ago the Minister of National Education agreed to the apprenticeship period of electricians being reduced from five to four years, on condition that these apprentices every year receive intensive practical training

Under the auspices of the ECA and the South African Electrical Workers' Association — employers and employees in the industry — a practical training programme was devised with the emphasis strongly on

practical experience

These programmes are already in full swing at a number of technical colleges

Mr Baker says "These programmes endeavour to provide the maximum benefit to the apprentices

"The programme is a totally practical one, based on extensive practical experience of the employers and employees in the industry

"These programmes are undertaken in conjunction with the academic training given at the technical colleges

"The reaction of the apprentices is overwhelmingly favourable

"Virtually to a man they state they are looking forward to their next session"

Mr Baker stresses that the reduction in the apprenticeship period does not mean a lowering of standards — it merely means an intensified training period

There is a worldwide tendency to endeavour to re-

duce apprenticeship periods

"The success we are having with our practical training programmes can be attributed to the fact that the programmes are tailor-made to fit the individual needs of the apprentice, plus the excellent training provided by the technical colleges

"As far as possible these practical training sessions take place as close as possible to the apprentice's work situation

"In conjunction with the technical colleges we regularly monitor these programmes to ensure that they fulfil the needs

"These programmes are continuously adapted to keep abreast of technological advances"

The curriculum covers aspects such as safety precautions, the use of instruments such as the various meters, installation testing, motors and starters, conduit and wiring work

The apprentices are tested regularly

D. Dispatch 5/2/82

FCI calls for ¹³³ ~~H66~~ changed union register system

JOHANNESBURG — The influential SA Federated Chamber of Industries (FCI) wants the government's union registration system changed so that it does not attempt to control unions

This was revealed in a statement issued by the chairman of the FCI's labour affairs committee, Mr Rod Ironside, yesterday. It indicated some of the evidence submitted by the FCI to an official probe on union registration and recognition

The FCI also stated the government's industrial registrar should not take race into account when registering a union — A decision by the registrar to do this when unions affiliated to the Federation of SA Trade Unions applied for registration last year sparked a major row

Further, the FCI said union representation and bargaining rights should

not be affected by union registration

But Mr Ironside's statement does not make a specific recommendation on a key issue being considered by the probe — whether labour law should provide for direct union recognition by individual employers

The statement calls on unions and the government to join in a search for an "acceptable industrial relation framework"

Last year the government asked the National Manpower Commission (NMC) to probe controversial elements of the official labour system which have been slammed by unions

These include registration and recognition of unions and bargaining within individual companies. The probe is expected to recommend key changes to the official system

Mr Ironside said the FCI had told the inquiry that union registration "should be a neutral and voluntary process and should not attempt to curb or restrict the functioning of trade unions"

Registration should not influence a union's bargaining status or other rights granted to unions in labour law

He added registration should be "synonymous" with the registration of companies under the Companies Act "which would create limited liability for trade unions and give them legal status"

The FCI had "consistently supported" principles of labour reform already accepted by the government, such as freedom of association and minimum state intervention in labour relations, and had recommended to the NMC that the government implement these principles, he said — DDC

Socialism will come unless SA changes

133

ARGUS

28/1/82

IN the further creation of wealth and its equitable distribution lay the only hope of a firm base of stability in South Africa and the survival of the free enterprise system, Mr Mike Rosholt, chairman of Barlow Rand, told a businessmen's meeting in Johannesburg this week.

The alternative he said, would be its replacement in due course by some form of socialism — and the due consequences we have observed over the years in many countries to the north of us.

Mr Rosholt said the government was publicly committed to basic change in the socio-economic field. 'And even if at times we are exasperated by the pace of change there can be no turning back. Nor can the private sector stand aloof... in the move towards a more just society.'

SATISFIED

'The private sector should examine its own performance. Are we in business satisfied we are taking full advantage of the government's amendments to laws and regulations, particularly in the field of labour?'

'Of equal importance has been the significant change in the past few years in intergroup attitudes. Are we taking this factor sufficiently into account in formulating our labour policies? Are we really keeping pace with the developing scene in this country?'

'A growing number of businesses are keeping pace. But all are involved in this process, the private sector should not be satisfied with its performance.'

On the subject of the elimination of discrimination in the work place Mr Rosholt said 'It is of the greatest importance that businessmen accept the basic fact that discriminatory practices and the achievement of the full economic potential of South Africa were just not compatible.'

OBSTACLES

There were in fact very few remaining government obstacles to a businessman eliminating discriminatory labour practices in his own business.

Are we in business really moving on the elimination of discrimination or are we merely paying lip service?'

'In common with many other companies our group concluded some years ago that a major objective should be its elimination and the promotion and preservation of the dignity and self-esteem of all our employees. This called for a full commitment to such concepts as selection and promotion solely on the basis of ability, the provision of similar benefits for all employees and the acceptance of some responsibility for their quality of life outside of the work place.'

As a start we introdu-

ced a written code of employment setting out our objectives and calling for a definite commitment to its principles by every employee. To ensure that the commitment was carried out we introduced direct monitoring of performance... with annual face to face presentations by the chief executive of each of our divisions to our board, to executives and staff of other divisions and to selected outside specialists on labour matters.'

On remuneration Mr Rosholt said 'There is absolutely no law or government regulation which prescribes discrimination in remuneration or which deals with the quantum which can be paid to anyone — other than minima laid down in certain industries.'

Quite rightly, remuneration is considered to be a matter which can only ultimately be settled by negotiation, formal or informal, between employer and employee.'

Of education and training, Mr Rosholt said: 'There is now a general consensus among busi-

'There are very few remaining Government obstacles to a businessman eliminating discriminatory labour practices in his own business,' says Mr Mike Rosholt, chairman of the giant Barlow Rand organisation.

nessmen that here lies the key as to whether or not South Africa will ultimately be able to take full advantage of its great natural resources — human and material.'

Are we all doing sufficient training within our own organisations? Taking maximum advantage of government external training programmes and incentives? Making sufficient effort in the indenturing of black apprentices? Or are we just sitting back complaining of the impossibility of doing so?'

There is no question that indenturing of blacks is a far easier process now than it was in the past.

In the wider national sense, the black population group will not be trained sufficiently to use its skills to the utmost and consequently to share in the fruits of the private enterprise system. This will inevitably lead to a rejection by it of the system, with all the implications on the stability of the country.

'But what is sufficient? How much should we be investing in training? While in no sense seeking to boost our own achieve-

ments — because we know we are not doing sufficient, mainly because we do not yet have enough trainers or training establishments — our budgets this year call for a 30 percent increase in expenditure over last year.'

'Our training costs, capital and revenue, direct and indirect, including salaries and wages paid to employees while undergoing training in company time, were R24-million. This represents R123 per employee on our strength of 196 000, although of course not every employee received training during the year.'

'If as a country we spent an equivalent amount on each of the 10 million of our economically active labour force, the national bill would be R1,2-billion. This may sound a very great deal of money, but it represents only 2 percent of our 1980 gdp.'

TRAINING

I would suggest we shall have to spend more. But whatever the figure should be, it is quite clear that both the public and private sector will have to face up to significantly increased investments in this area.

'But can one talk of effective training when basic education is lacking in so many of our employees? A survey of our group some three years ago showed that 60 percent of our black employees were either illiterate or semi-literate and had had six years of formal education or less.'

'It was clearly futile to talk of training, particularly technical and supervisory, for the majority of those people. And so in an attempt to remedy this situation, we introduced literacy and numeracy schools, staffed by professional black teachers. We now have 60 such schools providing employees with two hours a day of basic education — in company time — for 10 to 15 weeks depending on the level of literacy and numeracy with which they start.'

EXPENSE

'On any given day we are now dealing with 1 800 employees and in a full year some 6 000 will pass through our schools. The expense, part of our overall training costs, is significant but we believe that only such basic educational courses, followed by specialised job training, will produce the skilled labour which our forward plans call for.'

'And that is why the ultimate response of government to the De Lange report of the Human Sciences Research Council is of such immense importance. Hopefully it will bring about a complete overhaul of our national educational system on a non-discriminatory basis.'

FCI seeks end to curbs on unions

By STEVEN FRIEDMAN

THE influential SA Federated Chamber of Industries wants the Government's union registration system changed so that it does not attempt to control unions.

It also implies that the Government's industrial registrar should not take race into account when registering a union

There was a major row last year over a decision by the registrar to do this when unions affiliated to the Federation of SA Trade Unions applied for registration

And the FCI says whether or not a union has registered should not affect its representativeness or bargaining rights

These points are contained in a statement issued yesterday by the chairman of the FCI's labour affairs committee, Mr Rod Ironside, revealing some of the evidence submitted by the FCI to an official inquiry on union registration and recognition

But Mr Ironside's statement does not make a specific recommendation on a key issue being considered by the probe — whether labour law should provide for direct union recognition by individual employers

Search

It simply says there are "many options open" in the search for an "acceptable industrial relations framework" and calls on unions and the Government to join a search for such a system

Last year, the Government asked the National Manpower Commission to investigate controversial elements of the official labour system

These include registration and recognition of unions and bargaining within individual companies. The probe is expected to recommend key changes to the system

Mr Ironside says the FCI has told the inquiry that union registration "should be a neutral and voluntary process and should not attempt to curb or restrict the functioning of trade unions"

Registration should not influence a union's bargaining status or other rights in labour law

Liability

He says registration should be "synonymous" with the registration of companies under the Companies Act, "which would create limited liability for trade unions and give them legal status"

Mr Ironside adds "Representativeness is a factor that should be determined in the bargaining arena and the onus placed squarely on trade unions to demonstrate their ability to organise and sign up members"

He says the FCI has "consistently supported" principles of labour reform already accepted by the Government, such as freedom of association and minimum State intervention in labour relations, and has recommended that the Government implement these principles

This implied "a non-discriminatory labour relations structure where race should not be singled out as an 'interest' in negotiations"

ALLY
MONTHS
UPPERS

VALUE FOR MONEY

he's
any
in
the
se

Unions plan nationwide Aggett day

133

133

133

133

RAM
8/2/82

FEERDEN
AHER
ams —
oking As-
junior-
tle fight
an Ossie
as rained
Stadium
has been
friend
name her
ber at the
lay night
raining in
a greater
the world
t
he said
he Sigma

n Durban
l a super-
emonium
an 20 000
the fight
l a boxer,
as triam-
ankle in-
ken fans
ter
ve prom-
at the
Saturday
ie repeat
on those
ets away
m
ctor Mr
esterday
problem
de ticket
ded peo-

who is
tions for
said
hecking
rmation
it where

tried to

ently of
ide the
rm was

off and
singing
eir un-
uddled

By STEVEN FRIEDMAN

SOME of the country's biggest black unions are planning a national, half hour work stoppage on Thursday morning to mourn the death in detention of unionist Dr Neil Aggett — and will ask employers to agree to this step.

The call on workers and employers to observe a half-hour stoppage in mourning has been made by Dr Aggett's union, the Food and Canning Workers' Union

It has been supported by the Federation of SA Trade Unions, which has more than 90 000 members

The call is unprecedented and unions say they hope the brief stoppage will take place with the co-operation of employers

The leaders of South Africa's two main employer organisations, Assocom and the Federated Chamber of Industries, who have both expressed concern over the death reacted cautiously to the unions' call yesterday

Action plan

A Fosatu spokesman said yesterday that three union national executives had already met to plan action for a period of mourning. And in the Transvaal, he said, Fosatu had organised shop steward council meetings in Springs, Benoni, Katlehong, Vereeniging and other areas to discuss plans for the brief stoppage

In addition, a meeting of the Transvaal Solidarity Committee — which comprises all local independent unions, regardless of affiliation — will be held tomorrow

It is understood that worker representatives in all factories where the unions have a presence will approach their managements and ask them to agree to a stoppage starting at 11 30 on Thursday morning

Unionists are hopeful many employers will treat the request sympathetically

Serious

They say statements by Assocom and the

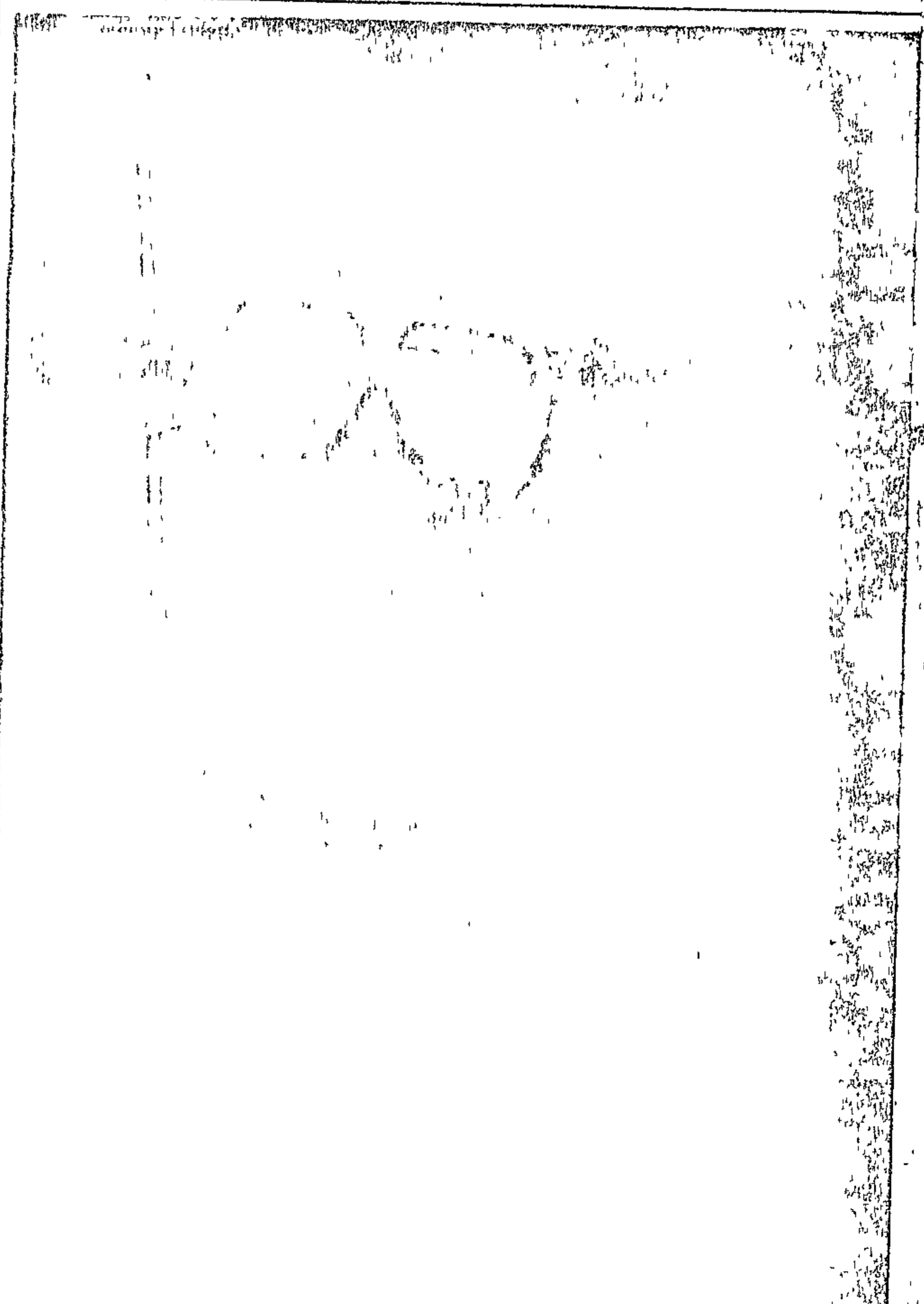

...last Friday, acknowledged the seriousness of the situation caused by Dr Aggett's death

Yesterday Mr Gordon Stuart-Reckling, president of Assocom, said the organisation had already called for the recommendations of the Rabie Commission on security to be implemented and had asked that detainees be brought to trial as soon as possible

"The Rabie recommendations go a long way towards improving the handling of detainees and they should be implemented as soon as possible," he said

"I do not know how employers will react to this latest situation and I am not here to tell people how to run their businesses

"We have given our view, that the death in detention of Dr Aggett can only complicate the evolution of sound industrial relations in South Africa

"But the implementation of the Rabie Commission's recommendations is the crux of the matter"

Mr Chris du Toit, the FCI president, said he would not comment until he had discussed the union statement with senior executives

Original

The original call for a stoppage came in a statement yesterday by the FCWU, of which Dr Aggett was Transvaal secretary

It said "A day of mourning on Thursday, February 11, is being called by the union of which Neil Aggett was Transvaal secretary. Employers and workers at all factories are asked to observe a national work stoppage at 11 30am on Thursday for half an hour"

The union said Dr Aggett died "because of his outstanding work for our union and the unity of all workers"

It added "His death must be commemorated in a proper manner and those who are responsible must feel our full shock and anger"

The union blamed Security Police and the Department of Manpower "which has condoned the vendetta of the Security Police against trade unions" for the death, and said it "marks a turning point in relations between unions and the State"

It added "The statements made by major employer associations such as Assocom and the FCI show that they realise this and we look to all employers and employer bodies to support our call"

© In London yesterday, SATIS, a trade union pressure group within the Anti-Apartheid Movement, delivered a message to the British Prime Minister, Mrs Margaret Thatcher, urging her to put pressure on South Africa for an independent inquiry into Dr Aggett's death in detention.

© See Page 5

Floyd 'adjusting' to Aggett's death

1204 8/2/82 By ANNE SACKS (329)

DETAINEE Dr Liz Floyd is still in the psychiatric unit of the Johannesburg Hospital, where her parents said she was "bearing up well" to the death of her boyfriend, Dr Neil Aggett

Dr Aggett, 28, Transvaal secretary of the Food and Clothing Workers' Union, died while in security police detention on Friday morning. When Dr Floyd was

told of his death by her parents, she collapsed and was rushed to the Johannesburg Hospital, where she is under armed police guard. She is a medical officer for several Soweto clinics.

Her parents, Mr Hugh and Mrs Mary Floyd, who flew to Johannesburg from Cape Town on Friday, said Dr Floyd, 27, was adjusting not only to the death of her boyfriend of seven years but also to being out of solitary confinement. She was detained 71 days ago and held in terms of Section Six of the Terrorism Act.

Six people were arrested, charged and released after a motor cavalcade of 90 cars circled John Vorster Square on Saturday afternoon to protest against deaths in detention and to show solidarity with other detainees.

A cavalcade circled the Hillbrow police station, where a Johannesburg journalist, Miss Liz McGregor, was charged for disturbing the peace and told to appear in court this morning.



Aggett action call spreads

RON 9/2/82 138 133 140A

Court order on blood transfer

Court Reporter

A TRANSVAAL judge, Mr Justice ... go, authorised a Johannesburg Hospital doctor to give blood to a seriously injured Jehovah's Witness at the week...

A transfusion was necessary to save the life of the patient, Mr William Andrew Dyson, who was seriously injured in a car accident.

Mr Dyson, his wife and two daughters objected to a blood transfusion on religious grounds, the court heard.

The application, on behalf of the Administrator of the Transvaal, was made by telephone late on Friday night.

was granted the same night.

Dr Mathew Zultzman, in charge of the respiratory intensive care unit of Johannesburg Hospital, said the court Mr Dyson had been admitted with multiple serious injuries. He was in the intensive care unit and undergoing an operation Friday morning.

It was possible Mr Dyson was bleeding internally, the abdomen, he said.

Mr Dyson was unconscious but his wife and daughters were categorically opposed to a transfusion.

But a blood transfusion was clearly needed, Dr Zultzman said. Mr Dyson did have a 100 percent chance of survival but his chances would improve greatly if he was given blood.

Dr Hymie Green, a specialist...

By STEVEN FRIEDMAN

TWO more major union groupings have backed plans for a national half-hour work stoppage on Thursday to mourn the death of Dr Neil Aggett — which means unions representing up to 200 000 workers have now decided to take part.

And yesterday the giant Federated Chamber of Industries recommended a course of action over the proposed stoppage to its member chambers.

No details were available but it is likely employers have been advised to adopt a flexible attitude.

It was also learned that unions are planning to hold mass protest meetings in the townships to protest at Dr Aggett's death.

And the Transvaal inter-union solidarity committee met last night to plan implementation of the stoppage and other protest measures.

The ball started rolling at the weekend, when the Federation of SA Trade Unions announced it was supporting a call by Dr Aggett's union, the Food and Canning Workers' Union, for the half-hour stoppage.

Protests

Yesterday, the general secretary of the 45 000 member Council of Unions of SA, Mr Piro-haw Camay, said Cusa had also agreed to take part.

A meeting of Cusa's executive at the weekend had also decided to support mass protest meetings.

Mr Camay said last night's solidarity meeting was deciding whether these meetings would be jointly organised by the unions.

The executive of the Cape-based General Workers' Union was meeting last night to decide whether to join the stoppage action. But it is regarded as certain that the GWU will take part.

Anger

A statement issued by the union yesterday said: 'The spontaneous reaction of anger and grief from our factory committees to the death of Neil Aggett will unquestionably ensure that the Food and Canning Workers' Union's call will receive the full endorsement of our executive.'

The unions are hoping employers will react sympathetically to the proposed symbolic stoppage.

Yesterday, the FCI issued a statement saying it would not comment publicly on the unions' call but that it had advised its members what action to take.

Regional chambers of industry have been informed of the FCI's views.

Tensions

Bank calls for GST increase

INCREASING general sales tax by two or even three percent, to as much as seven percent — but exempting basic foods, transport and fuel from the increase — would give Mr Horwood the extra money he needs this year with the least disturbance to the economy, says Dr Johan Cloete, economic consultant to Barclays Bank.

He says in Barclays Business Review...

By HAROLD FRIDJON

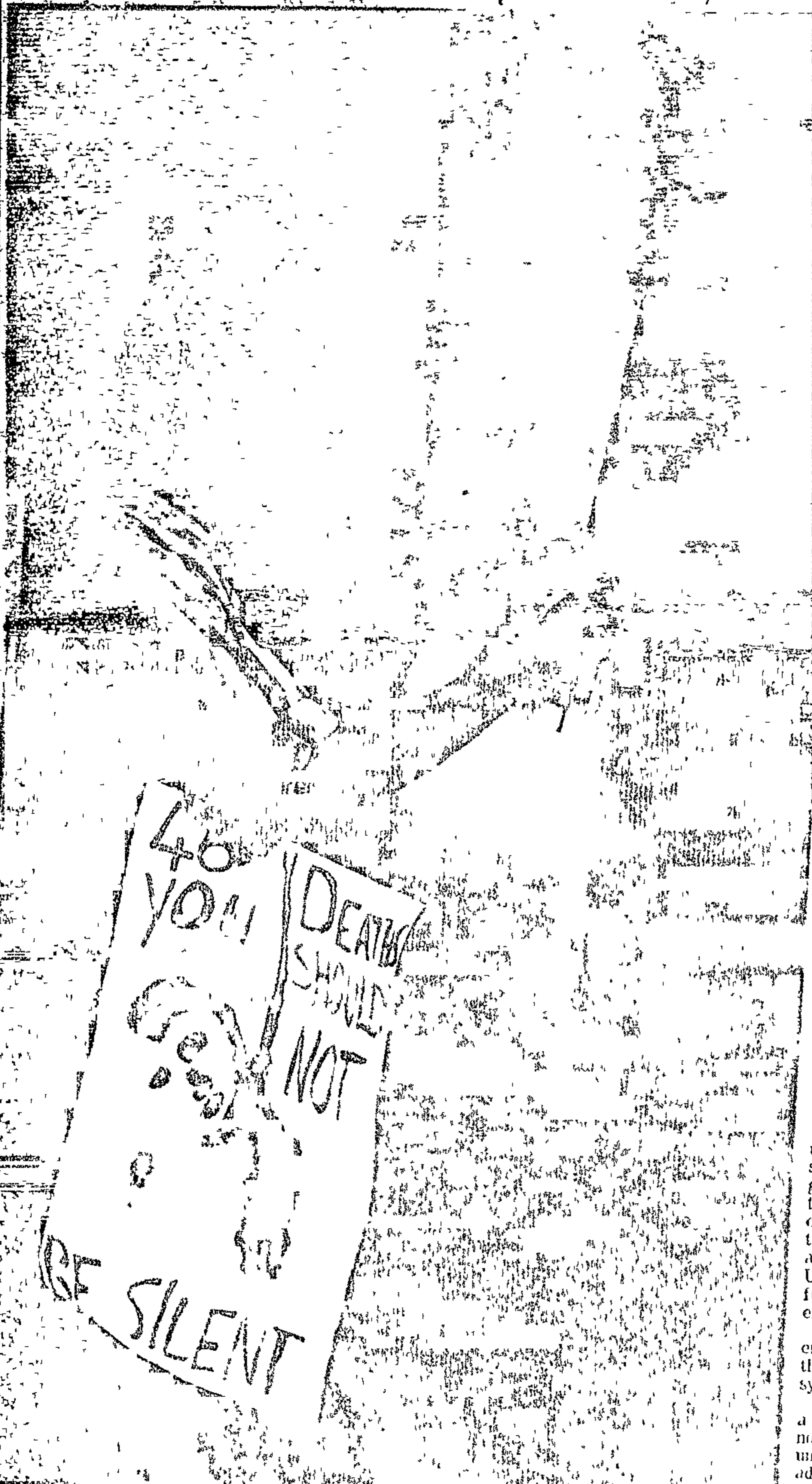

SPARK OF PROTEST ... this demonstrator was among the 40 students standing at intervals along Jan Smuts Avenue outside the Wits campus yesterday in memory of Dr Neil Aggett.

ning

TUESDAY, FEBRUARY 9, 1982

ce launch huge hu r preacher is knif wounded compan

Day Pastor
New Apos-
Mrs Van
allegedly
nife-wield-
veld, about
the hos-
dragged

from his bakkie and stabb-
ed several times with a
knife His last reported
words were "Mona, I am
dying, I am dying — you
must go and get some
help"

Although there was a
construction camp nearby,
Mrs Van de venter decided

to run to the
seek help

The attacker
stripped off t
threw her on
and stabbed
times She man-
cape and ran to
where she coll.
front door

roceful ship of

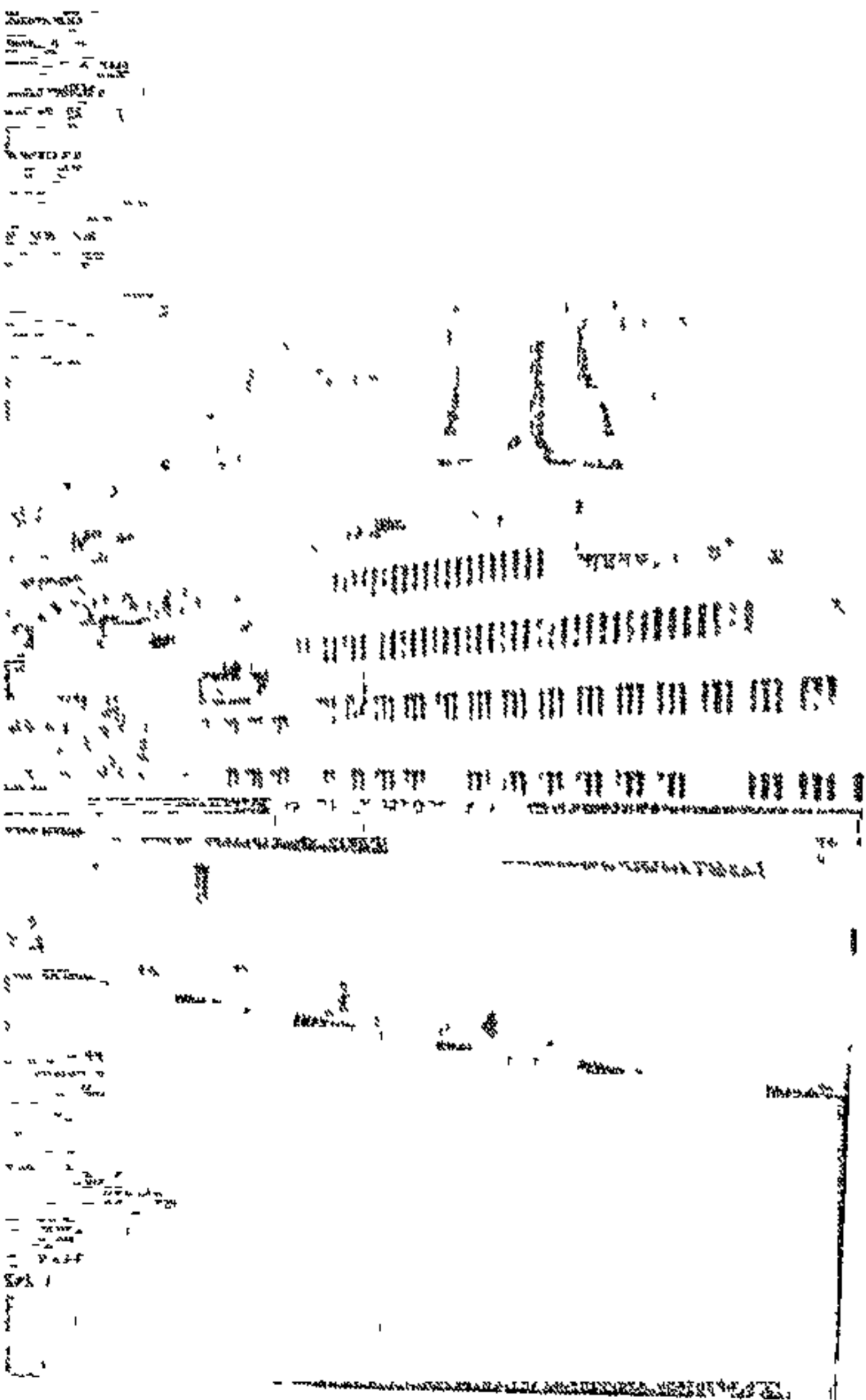

enger
its
from
Port
today
histles
to the
pas-
sacked
and

Europa bring on a perfec

fast the gangway was low-
ered and the passengers
began to triekle ashore

Strict security was the
order of the day, even
though there were only
about 100 people on hand

interpreter,
Zylka, of Bo
trip has been
organised"

They left
January 8 a
Elizabeth u

Chamber cautions

unions on Aggett stoppage

By JIMMY MATYU

THE Port Elizabeth Cham-
ber of Commerce under-
stands the strong trade
union reaction to the death
in detention of Dr Neil
Aggett, the chamber's
director, Mr Anton Mas-
ters said today, but work-
ers should think seriously
about the proposed work
stoppage

He said the half-hour
stoppage planned for
Thursday to mourn Dr
Aggett's death would seri-
ously disrupt the manufac-
turing process.

Mr P Camay, general
secretary of the Council of
Unions of South Africa
(Cusa), to which Dr Aggett's
African Food and Canning
Workers' Union is affili-
ated, said from Johannes-
burg today that workers
throughout the country had
been asked to observe a
half hour stoppage from
11 30am to noon on Thurs-
day

Mr Masters said the
chamber did not support
strikes or work stoppages

He appealed to employee
groups to "consider care-
fully the action to be taken
if they are employed by
crucial industry"

By "crucial industry" he
said he meant essential ser-
vices

The president of the Mid-
land Chamber of Indus-
tries, Mr Peter van der
Merwe, said individual
companies should make
their own decisions

Mr Camay said Cusa had
received support from sev-
eral companies on the work
stoppage, but the identity of
these firms could not be
disclosed

Miss Athalie Crawford,
organiser of the African

Food and Canning Workers'
Union in Cape Town, said
today that memorial ser-
vices for Dr Aggett would
be held in Cape Town, East
London and Durban

In Johannesburg the
South African Council of
Churches yesterday called
on the Government to abol-
ish detention without trial
before the system claimed
more lives

The SACC president, the
Rev Peter Storey, said
"The most terrifying thing
about Dr Aggett's death,
and the 45 other deaths in
detention, is that we will
never know for sure how or
why they happen"

"The blame lies squarely
at the door of this cruel,
inhuman form of punish-
ment called detention with-
out trial"

In London, Sapa-Reuter
reports, members of the
Anti-Apartheid Movement
and trade unionists
picketed the South African
Embassy yesterday to pro-
test against the death of Dr
Aggett

The movement's General
Secretary, Mr Mike Terry,
criticised Mrs Thatcher's
silence on the death, saying
"If this had happened in Po-
land I don't imagine for one
moment that Mrs Thatcher
would have kept silent"

Mrs Thatcher's Downing
Street office had no com-
ment to make and the Brit-
ish Foreign Office said its
views on detentions and
bannings were "well
known"

In New York the chair-
man of the United Nations
Committee against Apart-
heid, Mr Yusuf Maitama-
Sule, of Nigeria, expressed
shock at the death of Dr
Aggett

OPERA HOUSE
February 16 to 20

Book now at Theatre
PIETER TOERIEN

pre 111

VIEW

To spend
R1,7m on

post
9/2/82

33

T
T
PI
WI
In
Ac
t
c
g
t
g
c
T
n
h
t
G
t
A
L

Employers to wait and see, over wolk stoppage

Mercury Reporter

EMPLOYERS have adopted a wait and see attitude to tomorrow's proposed half-hour work stoppage called by certain trade unions in remembrance of the death in detention of unionist Dr Neil Aggett

The call for the stoppage was initially made by Dr Aggett's union the Food and Canning Workers Union, this weekend and has been supported by the majority of South Africa's trade unions including the solidarity committee representing 11 Natal unions

In a significant meeting earlier this week representatives of Natal's predominantly black trade unions said they held 'all State departments responsible for the Dr Aggett's death' and decided to avoid contact with the State at every possible point

The meeting was the first time that Natal trade unions had shown a united front but union sources said it was a pity Dr Aggett's death prompted the formation of a solidarity committee

The committee also expressed its abhorrence of all the security laws, particularly the four-

Students blockade SAA office in Aggett protest

London Bureau

LONDON University students blockaded the offices of South African Airways yesterday in protest at the death in detention of Dr Neil Aggett

Students from King's College University of London brought business to a halt for an hour when they blocked the entrance to the office in Oxford Circus

Police were called to remove the demonstrators who left the premises voluntarily after a brief discussion with police officers, according to a spokesman for the British Anti-apartheid Movement

Four overseas games for Natal

On that date the Kings Park Duicets, in effect a near-strength Natal side, will play against the touring San Isidro (CIS) side

Over Dr Aggett's death the British Labour Party has applauded South Africa's non-racial trade unions for calling a half-hour general strike tomorrow in protest at the death

At the party's headquarters its international committee passed a resolution expressing its horror at Dr Aggett's death

Dr Aggett was a key member of the non-racial trade union movement and we hold the South African regime responsible for his death

He was one of more than 600 people in detention in South Africa many of them active trade union members

The non-racial trade unions have called a general strike for February 11

We pay tribute to their courage and assure them of our support and solidarity

In the picture: Some of the demonstrators

MR. BUSINESSMAN...

How much business are you losing because of your absence from your office?

THIS IS THE ANSWER!

THE STL 1500 REMOTE TELEPHONE RECORDER

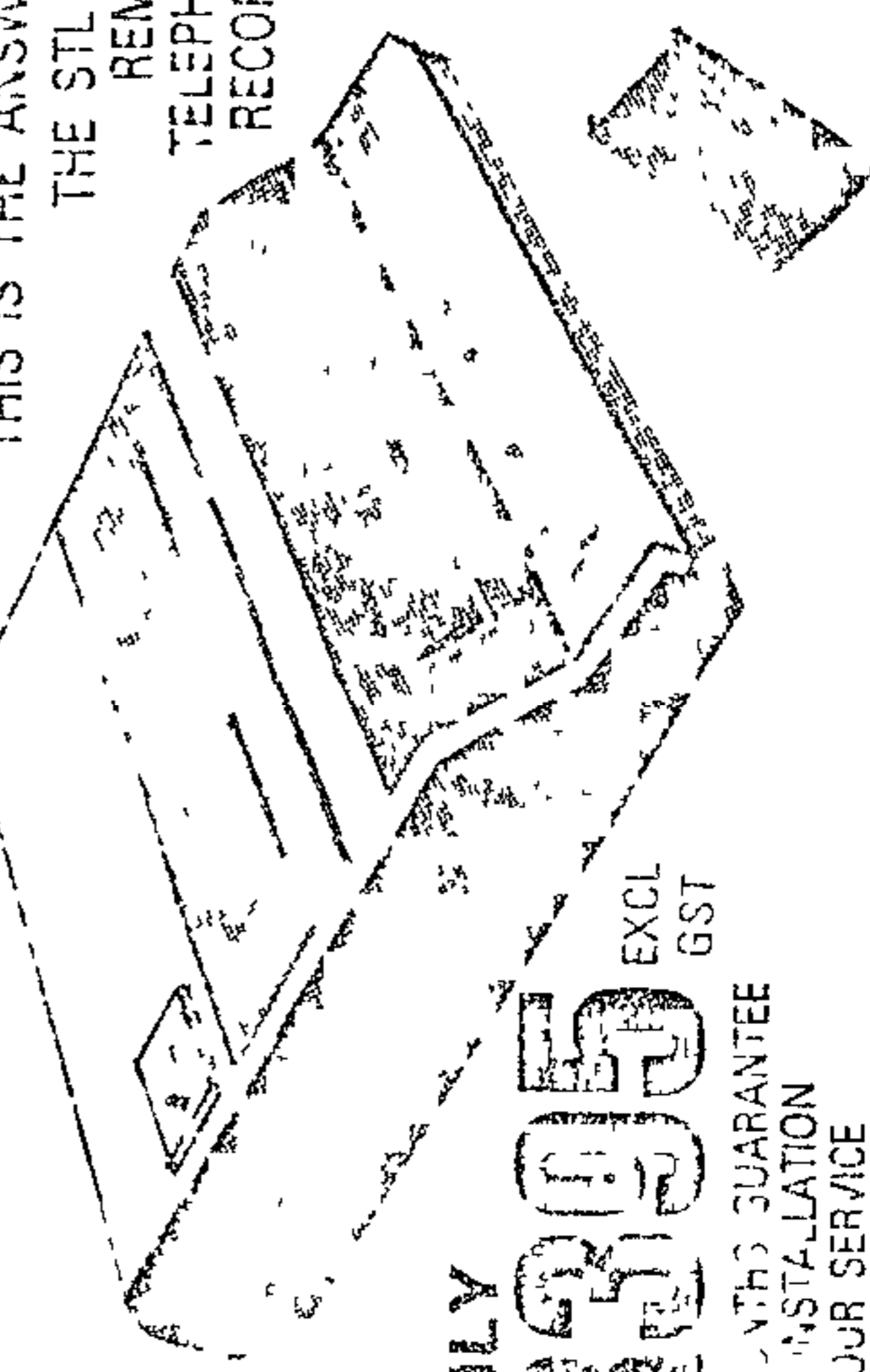

ONLY 4995 EXCL GST

2 YEAR WARRANTY FREE INSTALLATION 24 HOUR SERVICE

Your STL 1500 takes and records your messages and plays them back to you anywhere in the country or in the

out trial, called for their scrapping and demanded the immediate and unconditional release of all detainees

Not contacted

It was found in a survey conducted by the Mercury yesterday that the majority of employers had not been contacted by the unions and therefore had not formulated a policy on the proposed work stoppage

It was felt though that if trade unions continued with the work stoppage many employers would in future become hostile to their cause

The managing director of the South African Pulp and Paper Industry Mr Eugene van As, said they had not been approached but did not feel that the circumstances in this situation justified involving employers by way of a work stoppage

Service

The personnel manager of Hebox Textiles at Hammisdale, Mr John Harker, said 'We haven't had a request from the unions for a work stoppage but should we get one we will take it from there'

A Pietermaritzburg memorial service for Dr Aggett has been arranged for 6 p.m. tomorrow at the Lotus Hall in Longmarket Street and a protest meeting will be held in Durban's Emmanuel Cathedral tomorrow night

The meeting has been organised by Diakonia, the Durban-based ecumenical agency and the Detainees' Support Committee

Mr Paddy Kearney, director of Diakonia, said yesterday the meeting would be chaired by Archbishop Denis Hurley

Other speakers would be Mrs Helen Suzman PFP MP for Houghton, Mr Jan Theron general secretary of the African Food and Canning Workers Union, Dr Jerry Coovadia vice-president of the Natal Indian Congress and the Reverend Wesley Mabuza, vice-chairman of the Natal coastal district of the Methodist Church

See Editorial Opinion

133

19/2/82

Metalmen bend on withdrawal of pension cash

By STEVEN FRIEDMAN

THE Metal Industries Pension Fund rules — a key issue in a recent strike — have been changed recently to make it possible for some workers to withdraw their contributions after losing their jobs.

This means workers who leave the metal industries can recover the money they have put into the fund after six months — if they have not rejoined the industry in that time, according to the director of the Steel and Engineering Industries Federation Mr Sam van Collier.

He said the change had been made after talks with unions who had raised objections to the fund's rules.

The fund rules sparked a recent strike at Defy Industries' Durban plant — the second strike to hit the company in a few months — over worker demands to withdraw their money from the fund.

It ended in the sacking of 1 200 workers.

During the strike, Defy urged changes to the rules arguing that employers were placed in "an impossible position" because they were

unable to agree to requests to withdraw money.

The fund originally provided for all contributions to be 'frozen' until death or retirement age — the same stipulation as that contained in the Government's proposed pension Bill, dropped last year after worker unrest.

But last year, Seifsa held talks with unions on the fund's rules as part of a process of consultation with unions in the metal industries including those which have refused to join the metal industrial council.

Effective

The unions argued that the fund perpetuated the principle workers had rejected nationwide.

Mr Van Collier said that the change to the rules had been decided after these meetings and had become effective recently.

"We have assumed that for the first six months after a worker loses a job, he will be able to claim from the Unemployment Insurance Fund.

"But after that time if the worker has not rejoined our industries, he can claim his contribution," he said.

50

133

127

Call for ^{Skaw} release of ¹⁹⁴³ detainees Employers likely to tolerate demo stoppage

By Drew Forrest

Most mathematics lecturers at the University of the Witwatersrand have come out strongly in support of their colleague Mr Ismael Momoniat who was detained on January 20.

In a statement yesterday they called for the release of Mr Momoniat and all other detainees.

The statement read: "We wish to register our concern and anger at the detention, in solitary confinement, of our well-respected friend and associate and we are dismayed at the recent spate of detentions and bannings."

"Any debate or activity which in any way challenges the status quo of our undemocratic country gives rise to the most inhumane repression."

Many major employers and employer bodies have adopted a tolerant and pragmatic stance on tomorrow's planned work stoppage in honour of trade unionist Dr Neil Aggett who died last week in detention.

Although employers were tight-lipped yesterday, sources indicate that the country's largest industrial group, Barlow Rand, has joined the Federated Chamber of Industries in recommending a course of action aimed at preventing confrontation with workers.

Sources indicate that the metal industries' giant umbrella body, Seta, has also recommended that no disciplinary action should be taken against

workers in the event of an orderly stoppage.

A spokesman for the Food and Canning Workers' Union — of which Dr Aggett was Transvaal regional secretary — said four of the major groups recognising the union had agreed not to place obstacles in the way of the stoppage.

APPEAL

One of these is believed to be the Pioneer Milling group, although neither management nor the union would confirm this.

Mr Ies Keteldas regional secretary of Fosatu in the Eastern Cape said that management in the vast

majority of Fosatu-organised factories in the region had agreed not to oppose tomorrow's action.

The Media Workers' Association of South Africa and the Witwatersrand Council of Churches have added their voices to the stoppage call.

Mwasa urged its members to demonstrate such solidarity and support as will add to the momentum of the trade union call for action.

The Witwatersrand Council of Churches asked individual Christians to influence their employers to recognise the 30-minute protest vigil.

Read the following passages in order to determine the writer's purpose(s) in writing, his analysis of audience and the language he uses to achieve his purpose(s).

1.1.1 It is common knowledge that water may exist in three

melty, gaseous, liquid and very...
and...
Dr Aggett will be buried in Johannesburg tomorrow...
in the future...
need for further action...
take steps to avoid the...
note of the protest and...
the system should take...
"those responsible for...
told The Star that...
A union spokesman...
TAKE NOTE...
degree of support...
they could gauge the...
take some time before...
Industries said it would...
The Federated Chamber of...
"negligible." The...
distributive trades as...
in the commercial and...
response from workers...
described the stoppage...
Commerce (Assocom),...
Associated Chambers of...
A spokesman for the...
be viewed as "illegal."...
that such protest would...
and warned workers...
towards any stoppages...
adopt a hard line...
country, managements...
Sappi...
At the large...
work attitude...
equi...
what...
our...
enem...
Sovi...
the...
comp...
cons...
which

ook for college, others...
Hitlerite Germany...
is continuing...
as been forced upon...
rips with its bitter-...
Fascism. Our troops...
enemy armed to the...
vercoming numerous...
Navy are self-...
ch of Soviet soil...
e coming into action...
nd planes...
the danger imperilling...
be taken to smash the...
that our people, the...
the full immensity of...
try and give up all...
ntality of peaceful...
ral before the war, but...
radically changed the...
nel and implacable. He...
by the sweat of our...
secured by the labour...
oy our national culture...
es of the Russians, the...
ans, Latvians, Estonians,
ans, Armenians, Azer-...
ples of the Soviet Union,
to the slaves of German...
ne is one of life and

Stoppages

by 70 000

Star 12/2/82,

a success

By Tony Davis
Labour Reporter

Trade unionists have described yesterday's countrywide work stoppage to protest the death in detention a week ago of Dr Neil Aggett as a "wide success"

Well over 70 000 workers across the country are known to have joined the stoppage which ranged from five to 30 minutes

The stoppage has been described as a success because it reflects a growing strength in a recently evolving black and non-racial trade union movement

The stoppage also saw many managements and employer bodies "turning a blind eye" to the worker protest and offering their "sympathy and understanding"

Officials of the Federation of South African Trade Unions (Fosatu) which has 11 affiliate unions, estimated that half their members — more than 52 000 — observed the stoppage

"This was the first-time that such a countrywide protest has been organised by trade

unions," a Fosatu spokesman said.

CUSA officials said that more than 12 000 of their members took part in the protest

Managements by and large permitted stoppages to go ahead after consultations with the unions, but in some cases companies adopted a "no pay for no work attitude"

At the large Sappi mills throughout the country, managements adopt a hard line towards any stoppages and warned workers that such protest would be viewed as "illegal."

A spokesman for the Associated Chambers of Commerce (Assocom), described the stoppage response from workers in the commercial and distributive trades as "negligible." The Federated Chamber of Industries said it would take some time before they could gauge the degree of support

TAKE NOTE

A union spokesman told The Star that "those responsible for the system should take note of the protest and take steps to avoid the need for further action in the future"

Dr Aggett will be buried in Johannesburg tomorrow

Star 18/2/82. (143)
**Black unions
slate Bifsa 133
labour guide**

By Drew Forrest

The tough new industrial relations guidelines of a major user of black labour the Building Industries Federation of South Africa have drawn sharp criticism from black unions concerned.

The guidelines have been circulated to Bifsa's 3600 affiliates which employ more than 300 000 workers.

The recommendations include:

- No negotiation outside the industry's 11 industrial councils on matters within the councils' jurisdiction. These include wages and pensions.
- No negotiation of management decisions on with workers on strike.
- Only 'very informal contact' with unregistered unions. Employers should grant only officials of registered unions access to their workers.

Bifsa also opposes recognition of union shop stewards. A spokesman

for the federation commented: 'We will talk to proven representative of our employees but will not recognise their affiliation to any outside body.'

Mr David Lewis, general secretary of a union organising black building workers in the Western Cape the unregistered General Workers' Union said the guidelines "fell far short" of those issued by other local employer bodies.

'The building industrial councils have an incredibly low standing among black workers' he said. 'They simply would not join a union operating only at council level.'

Mr Frank Mohlala, general secretary of South Africa's only industrial union for black building workers, the registered Building Construction and Allied Workers Union said: 'We would not be interested in joining an industrial council on these terms — the guidelines give all power to management.'

JUST

(133) Star 16/2/82

Bifsa issues new tough guidelines

By Drew Forrest

Tough industrial relations guidelines have been issued by one of South Africa's largest employer bodies, the Building Industries Federation of South Africa, to its 3 600 member companies.

The guidelines are the first formulated by Bifsa whose affiliates employ more than 300 000 workers, mostly black. Circulated last year, they have now been made available to the Press.

In the guidelines, Bifsa says it favours strong trade unions "as a recipe for stable conditions" and supports the formation of unions for building workers "regardless of race or colour".

However, it urges there should be no site-level negotiations on any matter falling within the scope of the building industry's 11 industrial councils — including wages and pensions.

An employer could discuss such matters with his employees and if necessary refer them to the association for discussion or negotiation at council level.

But discussion on matters "which could have a ripple effect on the industry" should be handled "with great tact and circumspection," Bifsa says.

And while an employer should not refuse to talk to any union for fear of "unnecessary friction and strike action" — contact with unregistered unions "must be very informal".

Unregistered unions should be encouraged to register, Bifsa recommends, and only officials of registered unions should be allowed access to members.

Other recommendations include:

- No negotiations with striking workers

- The supervision of strike ballots by "a person mutually agreed on by management and the trade union"

- "Behind the scenes" contact between management and union leaders prior to negotiation to establish how firm views are

In the work stoppage following Neil Aggett's death . . .

AS THE coffin of Dr Neil Aggett was borne from St Mary's Cathedral on Saturday, mourners sang a Zulu song — "Farewell, dear friend"

Last Thursday, the emerging black trade union movement tried to translate that sentiment into action. All of them, despite the fact that they have been bitterly divided, called for a brief work stoppage to mourn the death.

It was to be "dignified and disciplined" and was to disrupt production as little as possible. And they called on employers to support them.

They seemed to want to demonstrate that the union movement was alive on the factory floor and that there was genuine worker anger at the death.

Response

The unions also appeared to want employers to make a gesture — to demonstrate that they, too, were concerned.

In this, they received a public response which would have been unheard of a short two years ago.

The Federated Chamber of Industries and the Steel and Engineering Industries Federation told members not to obstruct the stoppage (although Seifsa added, some sources say, that those who took part should not be paid). When the stoppage took place, not one violent incident was reported — nor did any stoppage last longer than 30 minutes as some employers had feared.

Several employers praised the "orderly" manner in which the protest was conducted and at one Uitenhage plant, management contacted the relevant union to congratulate it on the way the stoppage was run.

In some plants, there were

A new spirit is abroad on factory floors

RDM 19/2/82 (133) (134) (329) (138)

The work stoppage observed late last week to mark the death in detention of trade unionist Dr Neil Aggett was the first action called by unions since the 50s on a broad social issue. A Special Correspondent talks to unions and managements in this assessment of events.

moving shows of support for the call. At one, workers stood still at their benches for the full half-hour. At another, white workers and supervisors joined a service for Dr Aggett. At many, hymns and freedom songs were sung.

The protest was observed in places as far-flung as Sasolburg and Grabouw.

But how effective was it? How many workers rallied to the call?

Very few, say employer sources. "The stoppage was isolated and support for it was absolutely minimal," said Mr Vincent Brett of Asocom. "The unions blew it," adds a management source.

But few employer sources are prepared to estimate yet how many took part — though one says "I wouldn't put it at more than 30 000".

The unions tell a different story. Fosatu estimates that more than 52 000 of its members in 83 plants around the country took part.

Effective

It says 14 780 workers in 31 factories took part in Natal, 25 000 in 23 plants in the East Cape, and most of the rest in the Transvaal.

Mr David Lewis, general secretary of the Cape-based General Workers Union, says 4 000-6 000 GWU members took part.

Mr Jan Theron of the Food and Canning Workers Union (for which Dr Aggett worked), says the stoppage was effective at almost all

FCWU's organised factories in the Transvaal and Cape. This would put support at more than 15 000.

Mr Piroshaw Camay, general secretary of the Council of Unions of SA, puts the Cusa response at 10 000-12 000, making a total of more than 80 000.

There was also significant support from members of the Motor Assembly and Components Workers Union in PE, and from members of the SAAWU in East London. Some Engineering and Allied Workers Union members took part on the Reef.

There were also stoppages at some factories which are weakly unionised.

Thus Mr Lewis, on behalf of the unions, says more than 100 000 took part.

Who is right? The stoppage is impossible to measure and we may never know.

It is also clear that some claims were made hastily. A large conglomerate says it had no stoppages — two of its biggest subsidiaries say they did. There were one or two cases of unions who expected stoppages which did not occur.

But there is some independent evidence. In the West Cape, a researcher with good management contacts says "We checked with factories where we know there is a majority emergent union presence. They all had stoppages."

He adds that this applied to the food industry — even in country areas — and to en-

gineering and other industrial firms in the Peninsula.

He, too, "guesses" support was around 100 000.

Some management men, of course, suggest unions inflated their figures in order to demonstrate their strength.

Perception

But there is an important sense in which both sides may have been right.

"It's a problem of perception," says Mr Camay. "Managements hear about something like this and they assume the whole workforce is going to come out. They then look around and say 'Look, it didn't'."

"But we look around and say — when last did even 50 000 workers take part in an action like this?"

Unions argue that this is the first time they attempted a stoppage of this sort, that they had short notice to organise it, that they concentrated only on unionised plants, and that in the circumstances surprising numbers took part.

One statistic may illustrate their point. A turn-out of 100 000 is about 2% of the entire workforce and would hardly be noticed in many industries.

But it is more than the total number who struck throughout 1973 — the country's biggest strike year for decades.

In other words, it is trends, not total numbers, that are important.

The protest was also not always observed as a full 30-minute stoppage. In some plants, workers agreed to work in lost time later; at others their unions called only a five- or ten-minute stoppage.

At some, workers simply sang freedom songs while they worked or wore black armbands (although unions have excluded them from their figures).

This leads a management man to say "That's just a token stoppage. It hardly makes much difference to management."

Unionists reply that the aim was not to disrupt production. We asked for a show of mourning — and we got it," says one.

Both sides acknowledge that the stoppage was organised at short notice.

"The reaction of our clients is — they didn't have enough time to do it this time — maybe they'll have enough next time," says a labour consultant.

"You don't simply issue a pamphlet and wait for things to happen. We just didn't have time to get to everybody," says an East Rand unionist.

What of management's reaction? There were firms who threatened to fire workers — "we're not having a stoppage over a dead terrorist", said one — and many warned workers their pay would be docked.

But throughout the country, only one dismissal was reported. A surprising number of firms agreed to pay workers for the stoppage period. Some made joint arrangements with unions on how it was to happen.

By doing so, they sent messages to their workers and to Pretoria.

Many managements have been saying they are not the Government and they cannot be blamed for Government actions.

Many of them reply that they wanted that demonstrated — in actions, words. On Thursday, employers did something which, for the first time, distanced them from official actions.

That may have hidden effects in lessening tensions in their factories — just as employers who took a tough line might have to live with hidden tensions which will surface later.

And the message to Pretoria? Not one firm needed police to restore order.

At volatile plants, those in the Cape motor and food industries, they handled the event on their own — nothing untoward happened.

Identified

In other words, both sides showed that they can keep order without the banning of union meetings, the arrest of workers — or detentions of unionists.

Ultimately, Thursday's events were not a demonstration of union power.

But in many parts of the country, tens of thousands of workers — many of whom probably did not know Dr Aggett personally — identified in some form with the protests at his death and at detention without trial.

Whatever the actual numbers, more of them did than would have been believed possible a few months ago. And, in the main, they and employers saw to that the show of unionism went off peacefully.

The signs are there. Something new is abroad in the factories.

Agriculture would resist wage rises for workers

Mercury Reporter

NATAL farmers yesterday reacted cautiously to the proposed investigation into the conditions of farm labourers by the National Manpower Commission but warned they would resist any attempt to raise wages above present levels.

South Africa's 1 200 000 farm workers have so far been excluded from labour legislation.

Farmers interviewed by the Mercury said that if the commission led to an increase in workers' wages then they would mechanise and reduce their labour force.

A spokesman for the Maitlé and Timber Growers' Union said farmers were having to bear increased fertiliser costs, equipment cost and increased interest rates set by the Land Bank.

'If they had to cover increased wages on top of this most of the farmers would reduce their labour force,' he said.

The spokesman said there had been an incredible drop in the number of people entering farming because of increased costs.

He added it was a difficult situation for the Government and the farmer to cope with as a drop in the number of farmers would lead to an increase in unemployed workers.

Mr Heinz Bartels, an Impendle farmer, said 'You can't pay labourers something you haven't got.'

Farmers interviewed felt that the situation of farm workers was very different to that of a worker in industry in that they received various perks. If these were taken into consideration, they said they would welcome the commission.

We will cut

back on our

labour force,

farmers warn

1399
133
355
465
294

Mercury

23/2/82

'Some types of farming rely on casual labour, some on seasonal labour and others had a semi-skilled permanent labour force.

'The position in farming is much more complex than industry where they have nothing to do with the worker once he has left work. The farmer provides accommodation and often medical services for his workers,' he said.

The general secretary of the National Federation of Workers, Mr Mathews Oliphant, said they would be presenting their demands to the commission as they regarded it as a 'step in the right direction'.

quiry as a 'priority' and have said that 'regional' conditions should be taken into account.

'This inquiry is long overdue. We have been asking for this for some time and I can only hope that it will be done with all speed,' Mrs Helen Suzman, chief Opposition spokesman on urban black affairs, said yesterday.

'It is a complicated issue. Great care should be taken not to jeopardise existing employment and the investigators should make allowances for regional factors.'

'These two categories of workers are among the most exploited in the country in terms of wages, working hours and general conditions.'

Both categories had the added disadvantage of 'immobility', particularly farm workers.

Mr Ron Miller, chief NRP spokesman on manpower said: 'If ever there was a group of workers who were open to abuse by employers it is the domestic workers. I urge the inquiry to treat the investigations as top priority.'

Mr Ralph Haddingham, the NRP's agriculture spokesman, said farmers would welcome the inquiry because there had been a great deal of 'unfounded' criticism about their treatment of staff.

The public had not appreciated the bond of loyalty and responsibility which existed between the farmer and his staff.

This responsibility had not fallen on the shoulders of employers in the urban areas, he said.

She said that Mrs Audrey Cobden, the founder of NRPD...

(Surrender value of policy is zero - therefore no amount can be capitalised)

Independent unions invited to pay talks

By STEVEN FRIEDMAN
Labour Reporter

IN AN unprecedented move, unregistered unions are to be invited to take part in this year's annual industrial council wage negotiations in the giant metal industries

And registered unions in the industry have come up with a surprise demand — that legal minimum wages be raised to R2 an hour within a year — almost double the present minimum. The metal council is the biggest in the country, determining minimum pay and conditions for nearly half-a-million workers

Both moves come in the wake of attacks on the industrial council system by emerging black and non-racial unions. The Steel and Engineering Industries Federation (Seifsa), which strongly supports the metal council, has initiated talks with emerging unions on the council system and other issues.

Although most of these unions are unlikely to take up the wage talks offer, the unregistered Black Allied Workers' Union has already taken part in a union caucus to draw up wage demands for the negotiations

Unregistered unions may not take part officially in council bargaining, but the metal council — which comprises regis-

tered unions and Seifsa — has invited them to take part informally.

Mr Ben Nicholson, director of the Confederation of Metal and Building Unions, said yesterday that unions on the council had invited all unions in the industry to take part in their caucus meeting to formulate wage demands

Unions such as the General Workers' Union and Fosatu's Metal and Allied Workers' Union had not taken up the offer, but BAWU had.

Mr Ike van der Watt of the Boilermakers Society added that the industrial council had then agreed to invite all unions to take part in the negotiations, scheduled for March 9

This was confirmed by Seifsa's director, Mr Sam van Coller

Mr Nicholson disclosed the unions were demanding a minimum wage of R1.75, rising every three months until it reached R2 within the year. Unions were also asking for a 20% rise in the minimum for the highest-paid workers. The present minimum is R1.13

The demand for a R2 minimum was voiced in several strikes last year and adopted as a target by Fosatu

But both unionists denied this was the reason for the demand "It was simply the decision of unions at the caucus," Mr Van der Watt said

Both said they expected employers to strongly resist the demand, citing the downturn in the economy

have
to
the life
direct

id

tip

000

460

540
23 460

300

60

300

Income from Life Policy	Jan 2:	73 660
Income from Life Policy	Jan 2:	24 000
Life Policy	Jan 2:	300
Debtor (Insurance Company)	Jan 2:	300
Bank	04, Jan 1: Life Policy	300
Policy written down to surrender value (See Note 1 below)	Dec 31:	60
Income Statement	Dec 31:	60
Life Policy	03, Jan 1: Life Policy	300
Bank	03, Jan 1: Life Policy	300

(2) Premiums Treated as an Asset - Cont'd

Milestone
for
Durban
builders

Property Editor

THE executive committee of the soon-to-disappear Durban Master Builders' and Allied Trades' Association, which has been in existence since 1901, has been re-elected *en bloc* to see it through its transitional stage to become an organisation on a provincial level

Mr Andrew Stewart will remain president, supported by vice-presidents Frank Bax and Bent Hoffmann-Jensen, it was decided at the annual meeting this week.

Mr Stewart told members that previous presidents had worked towards rationalisation of the Master Builders' Associations in Natal

'This has been brought to fruition during the past year to the extent that this is the last meeting of this association and that shortly the inauguration meeting of the Natal association will be held,' said Mr Stewart, who described it as a milestone in the history of the building industry in Durban.

Cement

Mr Stewart also criticised the cement position and said the shortages had placed considerable costs on the construction industry. (Since his speech, the industry has announced that rationing will end on Monday because the position has been improved — see today's *Property and Home* supplement).

However, his comment on the brick position, which varied greatly during 1981, was, 'I am sure that the management of Corobrik, for whom I have the highest regard, have carefully analysed their experience over the past two years and are planning accordingly.'

The annual report of the executive committee emphasises the enormous demand for building during the period 1980-1981

Plans valued at R195 416 000 were passed in the association's area during that time, compared with R36 456 000 in 1977-78, R39 288 000 in 1978-79; and R73 225 000 in 1979-80

(2) Premiums Treated as an

Year 02 - same as year 01			
<u>03, Jan 1:</u>	Life Policy Bank		
<u>Dec 31:</u>	Income Statement Life Policy Policy written (See Note 1)		
<u>04, Jan 1:</u>	Life Policy Bank		
<u>Jan 2:</u>	Debtor (Insurance) Life Policy Income from being accrual		
<u>Jan 2:</u>	Income from Insurance Income Statement being closing		
<u>Jan 31:</u>	Bank Debtor being receipt		

Note 1:

At the end of year 03, the liability balance sheet as a non-current

Note 2:

The death of a partner automatically creates accounting entities. For this to be drawn up for the period to ascertain the correct balance sheet policy would be shown as income to the partners' capital accounts

	300	300
value	60	60
	300	300
able	24 000	540
		23 460
	23 460	23 460
	24 000	24 000

reflected on the partnership under value of R240.

the partnership as legal and its income statement would have the death of the partner so as to be correct. The proceeds from the life insurance statement and NOT credited directly

Industrial week

SEBE WARNS UNIONS

USA 60 133 105

2/3/82

MOVE which must be reassuring to the growth of prospective investors in Ciskei, General Charles Sebe - head of security - says the Ciskeian government is prepared to ban all trade union activity.

His warning follows the February 19 court conviction of 35 "agitators" - members of the influential SA Allied Workers Union which claims a "mixed" membership of 95 000 and featured in recent major strikes in the Eastern Cape

Stability in labour is a major incentive to investors and the warning by General Sebe, brother of President Sebe, coincides with the fresh announcement by the President that more than 30 industrial "giants" and other concerns are seriously considering setting up business interests in Ciskei

"The Government may have to ban the SA Allied Workers Unions," General Sebe says

Godfrey Shiba, acting general secretary of the SAAWU, says there are about 5 000 union members at King Williams Town and 800 at Ciskei's Dimbaza industrial township. The remaining members are made up of Blacks, Coloureds, Indians and about 50 Whites throughout South Africa and the Homelands

"We are expecting General Sebe to ban us. He's afraid of us and any group and intends to ban all organisations with more than 1 000 members, including burial societies," says Shiba

In addition to applications being investigated by the Ciskei National Development Corporation from industrialists in South Africa, United States, Israel, Taiwan, France, Germany, Hong Kong, Italy and Australia almost all of the 47 industries established in Ciskei (35

By Lynn Carlisle

at Dimbaza) are embarking on expansion programmes totalling more than R10 million

"The announcement of improvement incentives to attract industrialists has accelerated interest in Ciskei. Some industrial giants from South Africa and abroad are now coming forward to invest here," says President Sebe

It is believed the growing interest could lead to investments exceeding R100 million over the next few years, sources say

Climate

Dimbaza Chamber of Industries chairman, Ian Duncan-Brown, says there is a need to promote secondary and services industries there. Any industrial unrest would put off investors coming to Ciskei.

"We must create a climate for more industrialists who have a greater responsibility for providing the unemployed with jobs than just improving conditions for those already working," says Duncan Brown

He has had no dealings with the SAAWU, and no worker unrest has taken place at Dimbaza. Duncan Brown sees the type and amount of

unrest which took place at East London and Port Elizabeth as having been "out of all proportion"

"Yet those industries affected Mercedes Benz Assemblers CDA, Johnson & Johnson, Wilson Rowntree and others are model employers and industrial leaders paying well above the average salaries in industry," he says

It is pertinent that good labour relations should be promoted in the area, especially as Prime Minister Piet Botha considers Ciskei and the Eastern Cape as the prime area for concentrated development, adds Duncan Brown

After refusing to include Berlin into an independent Ciskei, the South African Government has undertaken to develop an industrial estate adjacent to Berlin and to provide for the development of its infrastructure while offering more attractive decentralised incentives to prospective industrialists

The Ciskeian Government has now completed a scientific resources survey and multi-disciplinary planning and has identified about 38 viable agricultural projects. A development fund in the order of R332 million over 10 years will be needed to exploit these agricultural possibilities

Labour 'freeze' alleged

The Industrial Court sits today to hear a fresh unfair labour practice case brought by the S. Diamond Workers' Union

The union will argue that the employer body, the Master Diamond Cutters' Association, has through one of its by-laws unfairly restricted the free movement of labour in the industry

The rule, enacted in 1961, requires member

companies to contact the association for all their labour requirements. The union alleges that it has been used to block the employment of certain workers and thus "freeze" labour mobility

It will ask for the deletion of the rule from the by-laws, and damages for a worker, Mr B C Bonthuis, who it claims was unemployed during last year because of a freeze applied

by the Association

Last year the union won a major unfair labour practice case in the Industrial Court, which effectively strengthened job reservation in the diamond cutting industry

133
2/8/82
S/Jan

300

300

24 000

300

24 000

24 000

300

300

300

Jan 31: Bank Debtor (Insurance Company) being receipt of proceeds 24 000

Jan 2: Income Statement Insurance Expense being closing entry 300

Jan 2: Income from Life Policy Income Statement being closing entry 24 000

Jan 2: Debtor (Insurance Company) Income from Life Policy being accrual of proceeds receivable 24 000

04, Jan 1: Insurance Expense Bank 300

Years 02 and 03 - same as 01

Dec 31: Income Statement Insurance Expense being closing entry 300

01, Jan 1: Insurance Expense Bank being payment of premium 300

(1) Premiums Treated as Business Expense

01, Jan 1: Life Policy Bank

(2) Premiums Treated as

SOLUTION TO: GL5

Metal Unions, Selsa to thraash out wages

133
9/3/82

By Drew Forrest

Registered metal unions meet the giant Steel and Engineering Industries Federation of SA (Selsa) in Johannesburg today to negotiate new minimum wages and conditions for the metal industries 400 000 workers.

The annual industrial council talks take place against the backdrop of mounting unrest over wages in the last Rand metal industries. They also follow a systematic offensive by some black unions on the industrial council system.

In an unprecedented step — apparently aimed at softening resistance to the council — unregistered unions have been offered 'observer status' at the talks.

ACCEPTED

The Black Allied Workers Union and the Engineering and Allied Workers Union are known to have accepted

ted the union and will take part in the union council meetings. But the offer has been spurned by several key worker bodies.

Although the unions on the council agree that sharp increases are needed for the poorest and workers, they have not been able to agree on a common platform for the first time.

BOTTOM RATE

The established unions are demanding a bottom rate of R1.75 and hold, rising to R2 during the year — the current minimum is R1.13 — and 20 percent in the minimum rate for artisans.

But the only independent black union on the council, the Steel, Engineering and Allied Workers' Union has put in a separate demand for a bottom rate of R1.80 rising to R2.10, and only 3 percent for artisans.

The division is seen to reflect the different constituencies of the unions — skilled workers on the one hand, and unskilled and semi-skilled black workers on the other.

Long-standing tensions between established and emergent metal unions surfaced during the run-up to the negotiations. Explaining its refusal to attend, the unregistered General Workers'

Union said it would not join the same caucus as affiliates of the Trade Union Council of SA — which had been "consistently hostile to the independent unions".

And two key Fosatu affiliates who refused observer status said they could not allow certain caucus members to speak for them, as serious allegations against these unions were pending at the International Metalworkers Federation.

Clothing workers want rise

Mr F M Galland-Buerke, managing director of

J H Henochsberg, a Dounfontein Johannesburg, clothing factory, said about 140 workers stopped briefly yesterday over a misunderstanding.

Staff sources said close to 500 struck over pay. Officials of the National Union of Clothing Workers said the root cause was the adherence of many employers to an industrial council agreement expiring in June.

Strikes hit two more metal firms

Labour unrest over wages hit two more East Rand metal factories yesterday, on the eve of annual wage talks in the metal industries' industrial council.

The unrest appears to be spreading to Germiston from nearby Wadaville where workers at four metal factories struck over wages last week.

About 300 workers at the Afrox gas equipment factory, engineering contracts department.

ment and supplies division in Germiston are still out after striking yesterday for an increase of R2.50 an hour.

A spokesman said the strike followed a verbal demand last week for planned July increases to be put into effect immediately. He added that the management would not grant the increase, as it "would make the man-

hour

ufacture of gas welding and cutting equipment at the complex uneconomical."

No union is involved, and the workers have appointed four negotiators at the request of the management.

And at Fensecure, also in Germiston, a management spokesman said about 30 workers were still on strike for an increase of R2 an hour.

Unwise to ignore unions—Minister

ARGUS 11/3/8- (133) (134) (135)

THE Minister of Manpower, Mr Fanie Botha, today pointed out that it was not illegal to negotiate with unregistered unions and asked whether it was wise to ignore them when they represented an appreciable part of an employer's workforce

Speaking at a meeting of the executive committee of the Afrikaanse Handelsinstituut in Cape Town today, on labour relations and methods and procedures for negotiation with trade unions, Mr Botha said the State did not want to prescribe structures for negotiation.

Referring to unions that did not want to register and registered unions that did not want to be included in the

ordered legal system, Mr Botha said communication and liaison with them was not prohibited

He asked whether, if such unions represented an appreciable part of the labour force, it would be wise to ignore their spokesmen

KEY ROLE

Mr Botha said that effective and meaningful communication between employer and employee had a key role to play in the goal of healthy labour relations

Every manager should gain the trust of his employees, identify dissatisfaction and grievances timeously and do something to solve problems

Disturbed labour rela-

tions could have far-reaching socio-economic and even political implications and prevention was better than cure, Mr Botha said

LIAISON

In his address, Mr Botha emphasised the importance and necessity of effective and regular liaison between employers and union representatives, saying that attitudes, honesty, candour and fairness played big roles

He said that all levels of management should be involved in the liaison process. Labour relations experts claimed top management in South Africa spent far too little time building and maintaining healthy labour relations.

Britain to buy Trident system

LONDON — The Cabinet of the Prime Minister Mrs Margaret Thatcher yesterday approved a decision to buy the Trident 2 strategic nuclear missile system from the United States

The details of the new submarine-launched ballistic missile system were to be announced in Parliament by the Defence Secretary Mr John Nott yesterday

The system, costing at least R14 000-million, will form Britain's independent nuclear deterrent system into the next century

More than 60 missiles will be bought, to replace the submarine-based Polaris missiles in the mid-1990s

Approval was virtually a formality since the decision already had been authorised by a special Cabinet sub-committee chaired by the Prime Minister

Mr Nott recently defended the proposed purchase by saying Britain needed the system in case the Nato Western Alliance collapsed over the next 40 years and Britain stood alone

Apart from the United States, Britain and France are the only members of the 15-nation Western Alliance to maintain independent nuclear deterrents

The four submarines that will carry the missiles will be built in Britain Mr Nott was expected to announce that component parts of the missile system will be built in Britain as well, offsetting some of the cost and creating badly needed jobs

Critics fear the cost could escalate dramatically, since the Trident 2 missile — with greater range than its predecessor and more possibility of penetrating Soviet defences — is still under development in the United States

The opposition Labour and Social Democratic parties have said they will scrap the system if voted into office in the next general election in 1984 Labourites say the multi-warheaded missiles will fuel the arms race

The Cabinet's decision brought an immediate reaction from the disarmament campaigners

"The peace movement will

Bosses discuss wave of strikes

By STEVEN FRIEDMAN
Labour Reporter

METAL industry employers met yesterday to discuss the labour unrest in the Wadeville/Germiston area as news of four more work stoppages was received — bringing the total of reported strikes to 12 in the past 10 days

A spokesman for Fosatu's Metal and Allied Workers Union said yesterday the strikes showed that workers had no confidence in official industrial council negotiations.

But the director of the Steel and Engineering Industries Federation, Mr Sam van Coller, said there were several factors at work

The strikes are almost all over wage demands

They coincide with annual wage negotiations at the metal industry's industrial council The wage talks have been postponed for a month

The clothing industry has also been hit by wage strikes

Yesterday reports were received of strikes at Hawker Siddeley Machines, Alumco, Buhler-Maig and Woltube

Two have been resolved while employers at the other two say they have dismissed workers and are recruiting new employees

Mr Van Coller confirmed that Seifsa had called a meeting of employers to discuss the unrest yesterday

But he said there was nothing unusual about this

"We hold numerous regional meetings and there was clearly a need for one on this issue"

Mr Van Coller acknowledged that the strikes were at least partly linked to what workers thought of the industrial council bargaining

But he added "A key factor is obviously inflation, which is hitting workers and employers alike

"Clearly in times of inflation it is more difficult to make industry-wide agreements stick, but we still believe industrial councils are the most suitable forum for both sides"

Indications yesterday were that much of the latest strike action was centred around Germiston South

At Woltube a Metal and Allied Workers' Union spokesman said a three-day strike had ended yesterday This strike had been over wages, and calls for the dismissal of a security officer.

Some worker demands had been met, but management had not granted a pay increase, he said

At Hawker Siddeley Machines, a company spokesman said 113 workers who went on strike over wages had been fired The company was recruiting more people.

"The workers did not begin work on Tuesday and were given a Wednesday deadline to return," he said

At Alumco, in Wadeville, a management spokesman said all 45 black workers had gone on strike on Tuesday, but had been replaced

At Buhler-Maig, a union spokesman said all 200 workers had been fired after a strike last week, and later all but 20 were taken back. A company spokesman confirmed this

The union spokesman said the strikes showed that workers had no faith in the negotiations between Seifsa and the unions on the council

He added that most employers had agreed to meet the union to discuss the unrest at their plants

133
12/3/82

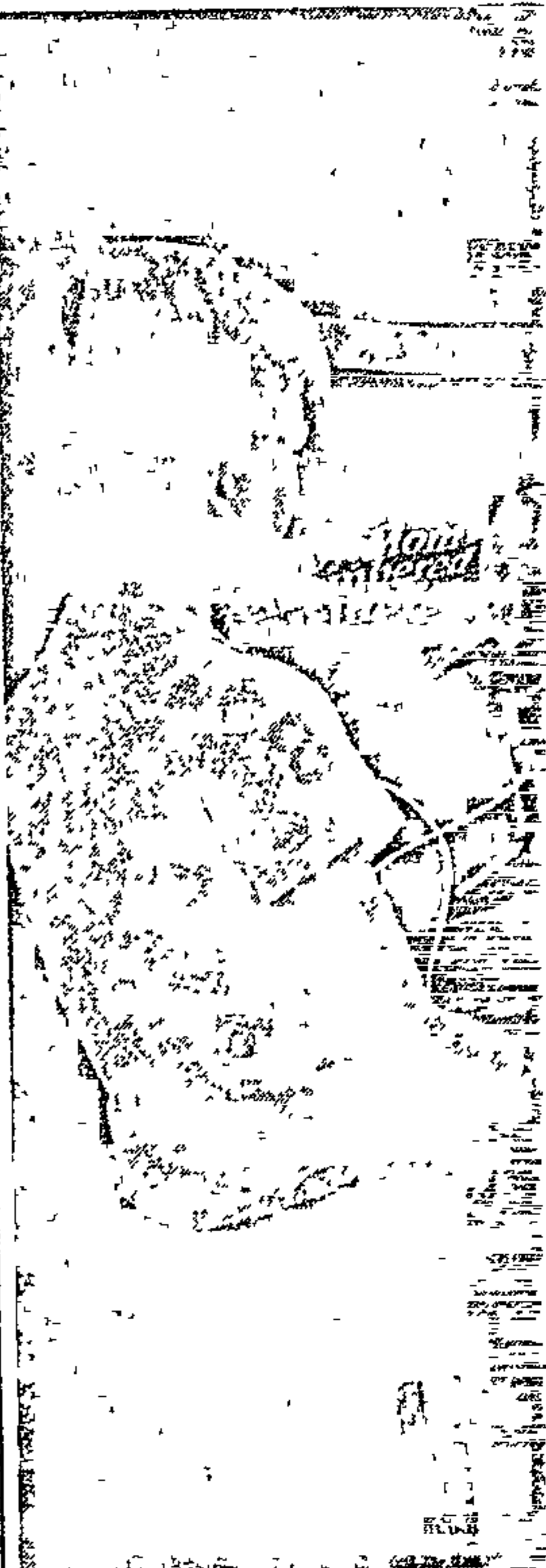

AFTERMATH... This car was suspicious police. One man was

Rain at long last

Africa Bureau

WINDHOEK — The villagers of Rosh Pinah, near the diamond digging area of South West Africa's deep south, have had rain for the first time in seven years

SWA, which has had reasonable rains in some parts, had been facing its worst drought this century.

When rain fell in Rosh Pinah on Wednesday there were celebrations not seen since the days when big diamond finds were made. A whole 56mm fell

In some areas children had never seen rain

Egypt's oldest skeleton?

CAIRO — An American expedition has unearthed a human skeleton believed to be the oldest found in Egypt, national antiquities director Mr Ahmed Kadry said yesterday

Dr Fred Wendorf, leader of the expedition from the Southern Methodist University of homo sapiens (modern man) He said the skeleton was "encased in a concrete-like sediment which has to be removed very slowly Until then we cannot reach a decision"

Mr Wendorf said the skeleton was found

S
O
THE
tries
str
bers
to
sour
The
plan
seven
ville
An
ad
ers
work
If
a
that
in
d

10-
Ma-
who
any
begin
were
time,
a
man
had
day,
union
work-
a
all
A
con-
said
work-
the
em-
meet
he un-

AFTERMATH... This car was stolen by four men yesterday morning. The theft ended in a crash after a high-speed chase by suspicious police. One man was shot and arrested, but the other three escaped over a garden wall.

Picture: ROBERT TSHABALALA

Rain at long last

Africa Bureau
WINDHOEK — The villagers of Rosh Pinah, near the diamond digging area of South West Africa's deep south, have had rain for the first time in seven years.
SWA, which has had reasonable rains in some parts, had been facing its worst drought this century.
When rain fell in Rosh Pinah on Wednesday there were celebrations not seen since the days when big diamond finds were made. A whole 56mm fell.
In some areas children had never seen rain.

Steel men advised on how not to bend

Labour Reporter

THE giant Steel and Engineering Industries Federation has issued confidential strike-handling guidelines to its members, which advises employers not to negotiate with strikers until they agree to return to work, according to employer sources.

The guidelines, described as a "contingency plan" to handle unrest, have been followed by several employers in handling the wave of strikes which is at present gripping the Wadeville/Germiston area, sources said.

An employer source, who described the document as the "Seifsa plan", said it also advised employers to set a deadline for strikers by which they would have to return to work.

If they did not return, the company was advised to dismiss the men and to "assume that they have resigned", he said.

Seifsa's director, Mr Sam van Coller, confirmed yesterday that Seifsa had issued a document offering guidelines to members on handling industrial unrest.

He stressed, however, that no pressure was placed on member companies to follow them. They had been issued merely to advise employers, he said.

Mr Van Coller declined, however, to comment on details in the guidelines.

"At the time they were adopted, the committee handling the issue felt that it was a management document and that it should not

be distributed beyond our members," he added.

Informed sources said yesterday they believed other employer associations had also circulated guidelines to their members on strike-handling.

"After all, it would be surprising if they hadn't," a source said.

Most of the responses of Wadeville and Germiston metal companies to the strikes of the past 10 days have been consistent with the guidelines.

Those who have been willing to discuss workers' wage demands have indicated that they would only do so once strikers returned to work.

In cases where demands have centred around issues unconnected with wages, however, these have been resolved before workers returned.

Most employers have set deadlines to their striking workforce and have regarded them as having "resigned" if deadlines have not been honoured.

But some have re-employed their entire workforce after setting a second deadline, one withdrew its plans to fire workers and at least two have set about recruiting entirely new workforces.

In its industrial relations guidelines, Seifsa also advises employers not to bargain on wages outside the industrial council system.

In the present strike wave, only two employers have indicated to union representatives that they may be prepared to grant an increase outside the council system.

Car chase ends in crash but 3 escape

Mall Reporter

THREE car thieves escaped on foot and a fourth was slightly wounded by police after a high speed car chase through Robertsham, Johannesburg yesterday.
The chase began when police became suspicious of the men, and ended when the four crashed into a bus shelter on the corner of Xavier Street and Bentley Road, Robertsham.
The thieves broke into a car outside a Booyens printing shop yesterday morning.
The printing shop receptionist, Mrs A Penny of Ridgevale, heard a noise and ran outside to see the four driving her car away.
Later, by chance, police noticed the four men in the car, became suspicious and gave chase.
After the crash, the driver sprang out and ran.
Police wounded one man who was arrested and the other three escaped over garden wall.

skeleton?

sapiens (modern man)" said the skeleton was "encased in a like sediment which has to be revery slowly. Until then we cannot a decision".

Wendorf said the skeleton was found and taken to Cairo's Antiquities on Monday for examination.

Kadry said that previously the oldest skeleton dug up in Egypt dated back 15000 years.

Wendorf said his team was part of a prehistoric expedition that began in southern Egypt in January. The partners are the Polish Academy of and Egypt's Geological Survey Department — UPI.

fends off ally by Nat MPs

was found that 10 times as many blacks as whites used Rissik station then the proportionate quota of available facilities should be made available to the various race groups.

"We will have to make a plan at Daan se stasie," Mr Schoeman said.

When Mr Van der Merwe asked the Minister to re-instate apartheid signs at Rissik station he drew derogatory moans from both the Government and PFP benches.

During Mr Schoeman's reply Mr Harry Schwarz, MP for Yeoville, interjected several times to ask Mr Schoeman whether apartheid notices were necessary to avoid friction, but the Minister side-stepped the interjections.

Minister: No racism in SAA staff choice

THE Minister of Transport Affairs, Mr Hendrik Schoeman, yesterday gave an assurance that there was absolutely no prejudice on the basis of race in the selection of cabin crew and air hostesses for South African Airways.

Selection was undertaken by an impartial panel and the requirements for acceptance of black, coloured and Asian candidates were exactly the same as for whites, he said in

committee on the Transport Services budget.

When posts were advertised this year for cabin crew and air hostesses of all race groups, only 204 of the 830 white applicants were accepted while "with the best will in the world", only one out of 341 black and one out of 50 Asian applicants could be accommodated.

Of the 37 coloured applications received, six were accepted — Sapa.

NRP call for probe

THE Minister of Transport, Mr Hendrik Schoeman, said yesterday he would investigate the issue of free rail passes.

He was reacting to a call by Mr George Bartlett (NRP, Amanzimtoti), during the committee stage of the Transport Services Appropriation Bill for a probe.

Mr Bartlett said figures for the 1978/79 financial year showed that 56 643 first class mainline free passes were issued that year.

Estimating that three members of a family availed themselves each of a free pass, nearly 170 000 people travelled free in that time.

According to a memorandum on transport estimates issued by the Minister, only 337 000 long-distance train journeys were travelled during 1978/79, Mr Bartlett said.

Locals to run SWA rail

Political Staff

SOUTH Africa is training South West Africans to run their railways after independence, the Minister of Transport, Mr Hendrik Schoeman, told Parliament yesterday.

In the first indication of Government thinking on how the vital transport services will be kept operating, Mr Schoeman also said South Africa would be prepared to administer them either as an agent of the new government or for its own profit or loss.

He was replying to Mr Pierre Cronje, Progressive Federal Party MP for Greytown, who wanted to know what Government plans

Hendrik show rolling

MR HENDRIK Schoeman has always brought a personal touch to the presentation of his portfolio.

Anybody who can laughs from an agitated debate possesses a rare political talent.

Now that Mr Schoeman is in charge of transport, could put him on the ask him to reply to the reading of the Transport Services Appropriation Bill charge R5 a seat.

On Wednesday the man Show got off to a start when he explained apartheid had nothing to do with train passenger losses.

"You could paint all people in South Africa same colour," he cried.

"Light green," suggested Nationalist colleague. "It doesn't matter colour," said Mr Schoeman.

sta 18/3/82 (133) (101) (59)

'Don't undermine the PWV' ASSOCOM warns on overplaying homeland role

By Tony Dugan

Organised commerce has warned the Government not to undermine the role of the metropolitan areas as the main generators of wealth for the sake of stimulating development in the homelands

In a memorandum to the Prime Minister's office on the Government's regional development proposals, Assocom makes the following points

- It supports economic decentralisation wherever the Government's proposals are based on "sound economic principles"

- Acknowledges the problems of poverty and unemployment in

regions in southern Africa

- Warns that the metropolitan areas in general — and the PWV in particular — should not be deprived or harmed in their role as the main generators of economic activity and job creation

Assocom's comments on the Government's strategy for co-ordinated regional development were sent to the Prime Minister's office last week as a top-level committee finalised the details of a new package deal to attract investment in the black states

The new deal is expected to come into effect on April 1 and Government develop-

ment officials are pinning their hopes for a big upswing in homeland industry on the incentives being offered investors

All the major employer and industry bodies — Federated Chamber of Industries, Afrikaanse Handelinstuut and the Steel and Engineering Industries Federation of SA — have submitted their comments to the Prime Minister's office

In its memorandum Assocom welcomed "the opportunity to take a fresh look" at regional development and the Government's new approach of using the carrot rather than the stick

One positive feature was the proposal to use decentralised advisory committees to define the needs of each region, the memo continued

CONCESSIONS

But the major part of the Assocom memo contained criticisms and warnings about aspects of the new decentralisation proposals

Other points made by Assocom were that industries already in homelands may tend to relocate at the end of their initial contract period for the sake of getting the fresh concessions elsewhere, Assocom added

It also remained the single most important factor to businessmen that watertight guarantees were given to ensure full compensation in the event of nationalisation

Minimum wages for domestics on the cards

E. Post 18/3/82

133 294

By CHARLENE BELTRAMO

MOST employers will have to pay their domestic servants 50% more. That is the view of experts following the recent announcement of a Government-appointed inquiry into the conditions of domestic workers.

The inquiry, regarded by many as long overdue, has been heralded as a breakthrough in Government thinking.

The aim is to lay down minimum working conditions for South Africa's 2 million domestic and farm workers.

But experts in these fields have warned that it will be no easy matter to make findings.

First, there is likely to be controversy concerning figures suggested as minimum "cost-of-living" wages compared with those suggested as "living" wages.

Second, experts have stressed, other working conditions, such as hours, over-time, leave and employment contracts, should not be neglected in the inquiry.

Ms Donna Wurzel, of the Domestic Pension Fund, asked what she thought the commission would suggest, said "If you want good service, you are going to have to pay for it."

"Many employers say 'My maid is part of my family'. Of course she isn't and never will be."

"The servant is an employee. She is not there to be part of the family but to make a living, like all of us."

"And, like any commod-

ity, if you can't pay for it — you can't have it."

The Domestic Worker's Employment Project (Dwep) recommends a minimum "cost-of-living" wage of R79 a month for unskilled workers and R96 a month for skilled servants expected to cook and look after children.

The average wage presently paid to domestic workers in South African cities is R65 a month.

The Women for Peace organisation sees a minimum "living" wage as R100 for unskilled and R120 for skilled workers.

But Mrs Irma Xenopolous, president of Women for Peace, said the organisation would like to see adjustable minimum wages for domestics.

"It is important that training be set up for domestics so that, like a secretary with a diploma, a domestic is able to command a wage in line with her qualifications."

The Domestic Worker's and Salesladies' Association (Dwasa) advises a minimum monthly wage of R110 for full-time workers, R10 a day for daily workers and R5 for a half-day.

Many other experts in the field have refused to lay down minimum figures, saying the issue is far too complex to deal with yet.

Mrs Joyce Harris, president of the Black Sash, said it was important the

commission laid down rules not for a minimum wage "but for a living wage" for domestic workers.

"Domestics need protection and they ought to be eligible to receive all the other benefits available to workers in industry," she said.

Mrs Roberta Johnston was a member of the ad hoc committee on the Legal Possession of Domestic Workers, formed after a symposium on domestic workers held in Johannesburg last year.

The organisation formulated a memorandum which has been submitted to the Manpower Commission.

Mrs Johnston said "We would like to see the institution of permitted maximum hours, overtime pay, provision of working clothes, minimum standards of furnishing for live-in servants and minimum annual leave."

"It is also important that amendments be made to the Labour Relations Act, the Wage Act and the Workmen's Compensation Act to include domestic and farm workers."

The ad hoc committee's findings — supported by 24 organisations throughout South Africa — also suggest that employment contracts should be set up for domestic workers and that statutory records of service should be kept.

"The committee is

continuing efforts to have the proposals made in the memorandum accepted," Mrs Johnston said.

Independent ombudsman Mr Eugene Roelofse, who is an expert on farm labour conditions, said it was important the commission did not merely rely on agricultural unions and farmers for their findings in this field.

"Traditionally there is a great credibility gap between what the farmers claim to be paying their labourers and what the labourers claim to be receiving," he said.

"Whatever the outcome of the inquiry into the wage structure of the farm worker I believe it will be a waste of time if they do not look at housing conditions, the health situation on farms and particularly the incidents of brutality towards workers."

Recently, a report on an investigation by the Child Labour Programme of the Anti-Slavery Society in London, which was put before the United Nations, stated that there were 60 000 child slaves — that is, children below the legal working age of 16 — employed in South Africa.

The report said at least 90% of them worked on South African farms — a form of exploitation unavoidable at present because of the low wages paid to their farm labourer parents.

Newspaper investigations have revealed that child labourers — and their parents — are, in many cases, paid a pittance by the farmers.

In one case, a man with six children was paid R7 a month.

Mr J F van der Merwe, deputy director-general of the South African Agricultural Union, said labour relations was a field his organisation was "constantly looking into."

He said agriculture was different from all other industries.

"Farm labourers are paid in a package deal. Wages are only part of it — the rest of the labourers' remuneration is made up with housing, transport and food."

"For that reason it would

d
I
als
the
ted
ing
the
ion
rts
in
of-
en

a
w
se
w
th
la
ln
wa
lot
eni
br
low
alle
hc
wor
cor
be
tr
of
The
ket
tr
the
hor
I

Steelworkers' Federation should be the first to return to work

The powerful Steel and Engineering Industries Federation has advised management in the strike hit metal industries against the "over-hasty use of ultimatums" and "threatening language when faced with labour unrest".

Confidential guidelines on dealing with labour unrest. Issued by the Steel and Engineering Industries Federation (Seifsa), have been obtained by The Star. Circulated to companies employing about 440 000 workers, they are an important response to the metal industries' mounting labour troubles DREW FOREST reports.

The recommendations are contained in a confidential 'contingency plan for handling labour unrest' which has been circulated to Seifsa's 3500 members.

15 strikes, mainly over wages, have hit East Rand metal industries in recent weeks. The guidelines appear to reflect a greater willingness on the part of employers to defuse tensions, rather than confront the general secretary of the Council of Unions of South Africa, M. Puroshaw. In the guidelines, Seifsa says management

should undertake to investigate strikers' grievances provided they return to work. But if stresses that a return to work should not be insisted upon in the early stages of a strike. It may be necessary to live with the stoppage until a negotiating body has been appointed by strikers and the nature of the grievances is known," Seifsa states.

Although the thrust of the guidelines is to secure an early return to work they appear to leave room for negotiation while a strike is in progress. Managing a strike is a form of negotiation and, as in any bargaining situation the overhasty use of ultimatums generally hinders options. And while Seifsa sets out a procedure for a

return-to-work deadline if management decides a strike "should no longer be tolerated" it does not recommend this action. But it says that if an ultimatum is issued the company must stick to it "if it becomes necessary".

Other recommendations include:

- Police intervention only as a last resort when injury to people or damage to property is imminent.
- A public assurance to strikers that their spokesmen will not be victimized and report-back facilities for these spokesmen.
- Protection for those who do not want to take part in organized labour action and who face intimidation.

Seifsa's director Mr Sam van Collier, said yesterday that member companies were free to decide on whether and how to implement the guidelines and companies used that various factors were at work in the East Rand strikes.

He added the guidelines may have helped prevent the escalation of disputes in a period of high conflict.

133 Star 18/3/82

Seifsa gives advice on managing strikes

187
133
137
257
Wine workers get 25pc

March 1982

Labour Reporter

Workers in the wine and spirits' industry have won a 25 percent wage increase for 1982 over two stages, following negotiations in Stellenbosch this month

The four-day negotiations were held between the National Union of Wine, Spirit and Allied Workers and the SA Wine and Spirit Industry Employers' Association.

Workers will receive a 15 percent increase across the board from April 8 and another 10 percent on October 8. The increase is based on each worker's wages, says the union.

The 46-hour work week was also

reduced by an hour and the annual bonus increased from three to four weeks' wages.

Provisions were also negotiated for overtime meal allowance, sick and holiday leave, maternity leave and other particulars.

The employers also agreed to allow union officials two hours of company time annually to address workers on union matters and shop stewards one hour a month to report back to workers on union company matters.

The general secretary of the union, Mrs Fay Mandy, said it was satisfied with the terms of the agreement.

Enige geregistreerde werkgewersorganisasie wat teen die aansoek beswaar maak, word versoek om binne een maand na die datum van publikasie van hierdie kennisgewing sy beswaar skriftelik by my in te dien, p/a die Departement van Mannekrag, Mannekraggebou 449, Schoemanstraat 215, Pretoria (posadres Privaatsak X117, Pretoria, 0001)

TABEL

Naam van werkgewersorganisasie —South African Federation of Civil Engineering Contractors

Datum waarop aansoek ingedien is —20 Januarie 1982

Belange en gebied ten opsigte waarvan aansoek gedoen word —Werkgewers betrokke in die Siviele Ingenieursnywerheid in the Republiek van Suid-Afrika

“Siviele Ingenieursnywerheid” beteken, sonder om die gewone betekenis van die uitdrukking enigsins te beperk, die nywerheid waarin werkgewers en werknemers met mekaar geassosieer is vir—

(a) die konstruksie van vliegvelde, waterkanale, opgaarkuile, brandstofruime, brûe, kabelgange, caissons, vlotte of ander skeepstrukture, kanale, koel-, water- of ander torings, damme, dokke, hawens, kaaië, grondwerke, bedekkings, omhulsels en/of stutte vir installasies, masjinerie of uitrusting, fabriek- of werkeskoorstene, filtreerbeddings, land- of seeverdedigingswerke, mynskagtorings, pyplyne, piere, treinspore, reservoirs, rivierwerke, paaie of strate, rioolwerke, riole; skagte en/of tunnels, silo's, sportvelde en/of -terreine, swembaddens, viadukte en/of waterbehandelingsinstallasies, gas-houers,

(b) die uitgrawingswerk en/of die konstruksie van fondamente, hyserskagte, heiwerk, keermure, trapkuile, ondergrondse parkeergarages of ander ondergrondse strukture,

(c) die asfaltering, betonnering, begruising, gelykmaaking en/of bestrating van parkeergebiede, sypaadjes, paaie, strate, vliegveldaanloopbane of vaste blaaië, persele en/of terreine,

en omvat enige ander werk van soortgelyke aard wat probleme van 'n siviele ingenieursaard behels of werk wat gepaard gaan met of voortspruit uit enige van voormelde werksaamhede.

Posadres van applikant —Privaatsak X1, Garden View, 2047.

Kantooradres van applikant —Agtste Verdieping, Oostoring, Bedfordsentrum, Kirkbyweg, Bedfordview

Die aandag word gevestig op onderstaande vereistes van artikel 4 en 7 van die Wet

(a) Die mate waarin 'n beswaarmakende werkgewersorganisasie verteenwoordigend is, word ingevolge artikel 4 (4), soos toegepas by artikel 7 (5), bepaal volgens die feite soos hulle bestaan het op die datum waarop die aansoek ingedien is, en wat die lidmaatskap betref, word alleen lede wat ingevolge artikel 1 (2) van die Wet op voormelde datum volwaardige lede was, in aanmerking geneem

(b) Die prosedure voorgeskryf by artikel 4 (2) moet gevolg word in verband met 'n beswaar wat ingedien word

M. W. J. LE ROUX, Nywerheidsregistrator

(19 Maart 1982)

Any registered employers' organisation which objects to the application is invited to lodge its objection in writing with me, c/o the Department of Manpower 449 Manpower Buildings, 215 Schoeman Street, Pretoria (postal address Private Bag X117, Pretoria, 0001), within one month of the date of publication of this notice

TABLE

Name of employers' organisation —South African Federation of Civil Engineering Contractors

Date on which application was lodged —20 January 1982

Interests and area in respect of which application is made —Employers engaged in the Civil Engineering Industry in the Republic of South Africa

“Civil Engineering Industry” means, without in any way limiting the ordinary meaning of the expression, the industry in which employers and employees are associated for—

(a) the construction of aerodromes, aqueducts, bins, bunkers, bridges, cable ducts, caissons, rafts or other marine structures, canals, cooling, water or other towers, dams, docks, harbours, quays and wharves, earthworks, encasements, housings and/or supports for plant, machinery and/or equipment, factory and/or works chimneys, filter beds, land and/or sea defence works, mine headgear, pipelines, piers, railways, reservoirs, river works, roads and/or streets, sewerage works, sewers, shafts and/or tunnels, silos, sportsfields and/or grounds, swimming baths, viaducts and/or water treatment plants, gas-holders;

(b) the excavation work and/or the construction of foundations, lift-shafts, piling, retaining walls, stairwells, underground parking garages or other underground structures,

(c) the asphaltting, concreting, gravelling, levelling and/or paving of parkingareas, pavements, roads, streets, aerodrome runways and/or aprons, premises and/or sites,

and includes any other work of a similar nature involving problems of a civil engineering character or work incidental to or consequent on any of the aforesaid activities

Postal address of applicant —Private Bag X1, Garden View, 2047

Office address of applicant —Eighth Floor, East Tower, Bedford Centre, Kirkby Road, Bedfordview

Attention is drawn to the following requirements of sections 4 and 7 of the Act.

(a) The representativeness of any employers' organisation which objects to the application shall in terms of section 4 (4) as applied by section 7 (5) be determined on the facts as they existed at the date on which the application was lodged and, as far as membership is concerned, only members who were in good standing in terms of section 1 (2) of the Act as at the aforesaid date shall be taken into consideration

(b) The procedure laid down in section 4 (2) must be followed in connection with any objection lodged

M. W. J. LE ROUX, Industrial Registrar

(19 March 1982)

Handwritten notes: *employers' orgs*, *133*, *See full text*, *see*, *88 8110*

Big 2 clash on labour, say unions

~~133~~
RDH
~~133~~
133
~~133~~

V

By STEVEN FRIEDMAN
Labour Reporter

A "MAJOR" dispute on labour issues between the country's two biggest industrial groups, Anglo American and Barlow Rand, erupted at a recent meeting of metal industry employers which decided to take a "hard line" against strikers, Fosatu's Metal and Allied Workers Union has claimed

The union said Anglo proposed a "very hard line", while Barlow adopted "a more pragmatic approach"

It said the meeting — a regional Steel and Engineering Industries Federation (Seifsa) meeting held on the East Rand earlier this month — decided on a tough line against strikers and claimed companies were "taking production losses and stoppages to maintain the Seifsa/Anglo American ideological line"

Barlow declined to com-

ment yesterday but Anglo angrily rejected claims that it was unwilling to negotiate with workers. And Seifsa's director, Mr Sam van Coler, questioned the union's account of the meeting

In a statement yesterday, MAWU referred to a regional Seifsa meeting held on March 11 to discuss the Wadeville/Germiston strikes

It said it had learned that the meeting recommended that no talks should be held with workers on general pay increases outside the industry's industrial council negotiations — now in progress

It also charged that the meeting recommended a tactic to "break strikes and intimidate workers" by dismissing and then re-employing them

The union said Seifsa members were inviting unrest by "refusing to talk to their employees"

It added that the industrial council system was being "imposed" on black workers who had no belief at all in the system

Mr van Coler said yesterday the meeting had not "taken any resolutions" and was

"just an exchange of views"

But there had been a "consensus" that employers would continue with their "present view" that pay would be negotiated only on the council.

He said no firm decision had been taken on firing strikers

In a statement yesterday, Anglo said it "deplores wild-cat strikes", but added that Seifsa's strike guidelines "have at no time recommended a tactic to break strikes and intimidate workers by dismissing employees and then re-employing them" Anglo supported this fully, it said

Seifsa, it added, was fully committed to bargaining with unions representing metal workers. It had thus invited unions not on the industrial council to attend the current wage negotiations, but MAWU had declined

It had also begun talks with all metal unions to see whether the bargaining system should be changed. Discussions with Fosatu, to which MAWU belonged, were due shortly

S,
W

23/3/82 Star (133)

Mawu warns bosses

By Drew Forrest

The Metal and Allied Workers Union has warned employers in the strike-hit metal industries that they are "trying to put a lid on a volcano" by refusing to talk with their employees.

The union accuses the Steel and Engineering Industries Federation and the Anglo American Corporation of hard-line opposition to plant-level wage bargaining and says companies are suffering work-stoppages to maintain their "ideological line"

Its statement follows

a wave of unrest, mainly over wages, in the Reef metal industries. Most affected firms have refused to discuss wages pending the Industrial Council talks

Mawu claims that at a meeting on March 11 to discuss the strikes, Seifsa members opposed wage talks outside the council and urged the dismissal and re-employment of workers as a strike-breaking tactic.

It claims the meeting was marked by a major dispute between Anglo, adopting a hard line, and Barlow Rand, which "took a more pragmatic approach."

Taking issue with employers who blame "instigators," Mawu says the strikes occurred because workers need money — "no union has to tell them that" It added that the drought had increased the burden of metal workers, many of whom were migrants with families in the rural areas

In response, an Anglo spokesman said the corporation backed Seifsa in its discussions with the metal unions, which aimed to see "if the present bargaining structures need revision in any respect"

"No fair-minded per-

son could describe this as a refusal to talk to employees," he said, adding that Anglo fully supported the Seifsa strike-handling guidelines which "at no time" recommended the dismissal and re-employment of strikers

The spokesman said the corporation was convinced that separate bargaining with the different races would "heighten racial tensions"

"For this reason we are committed to a collective bargaining structure which will involve all represented employees," he said

Mercury
25/3/81

Blacks 'reject capitalist system'

Mercury Reporter

THE attitude of the Nationalist Party was responsible for the rejection of the capitalist system by blacks

This was said by Mr P G Gumede president of the Inyanda Chamber of Commerce and Industry and deputy president of Nafcoc, in his presidential address delivered at the chamber's 18th annual conference in Durban yesterday

Warning on the dangers of the Nationalist Party putting party interests above the country's interests Mr Gumede asked how long the private sector was prepared to sit back and watch the destruction of all that the capitalist system had produced in the country

Basing his argument on the Nationalist Party's rejection of the findings of the Buthelesi commission, Mr Gumede said that 'just as the Nationalists prefer to die rather than sacrifice their policies, the blacks too prefer to die mercilessly at the hands of the Nationalists rather than subject themselves to Nationalist policies ad infinitum'

Mr Gumede said the Buthelesi commission acknowledged that both blacks

and whites were permanent and inter dependent in this country, and that the logical conclusion was that we would either survive or perish together

'We can only reject the findings of the commission at our own peril' he said

Mr Gumede added that he continued to believe that the private sector in Natal had something to offer the rest of the Republic 'I still believe that the coming forward of so many associate member companies is an expression of the goodwill that only exists in Natal,' he said

Mr Ian Hetherington of the Small Business Advisory Services (Pty) Ltd in Johannesburg addressed the conference on the subject of supporting small business

Mr Hetherington said one of the obstacles facing small businesses was the numerous laws governing them. The laws often fell under the same Companies Act and had to comply with the same returns to the Registrar of Companies and audit procedures, that were applicable to companies such as Anglo American

'A recent study at Pretoria University,' he said, 'has so far unearthed more than 500 laws, regulations and proce-

dures which in one way or another impinge on small businessmen. It is not surprising that the civil service finds itself understaffed'

Mr Hetherington said the situation was even worse for the small black businessman

Licence

'In one self-governing State where I am familiar with the situation, a licence is required if you employ 10 or less people. To get a licence, there are 37 required steps through the bureaucracy which have been known to take five years to accomplish'

Mr Hetherington urged associate members to support small businessmen by purchasing a portion of their requirements from small suppliers and manufactures. This would aid Nafcoc's efforts to move South Africa towards free enterprise, he said

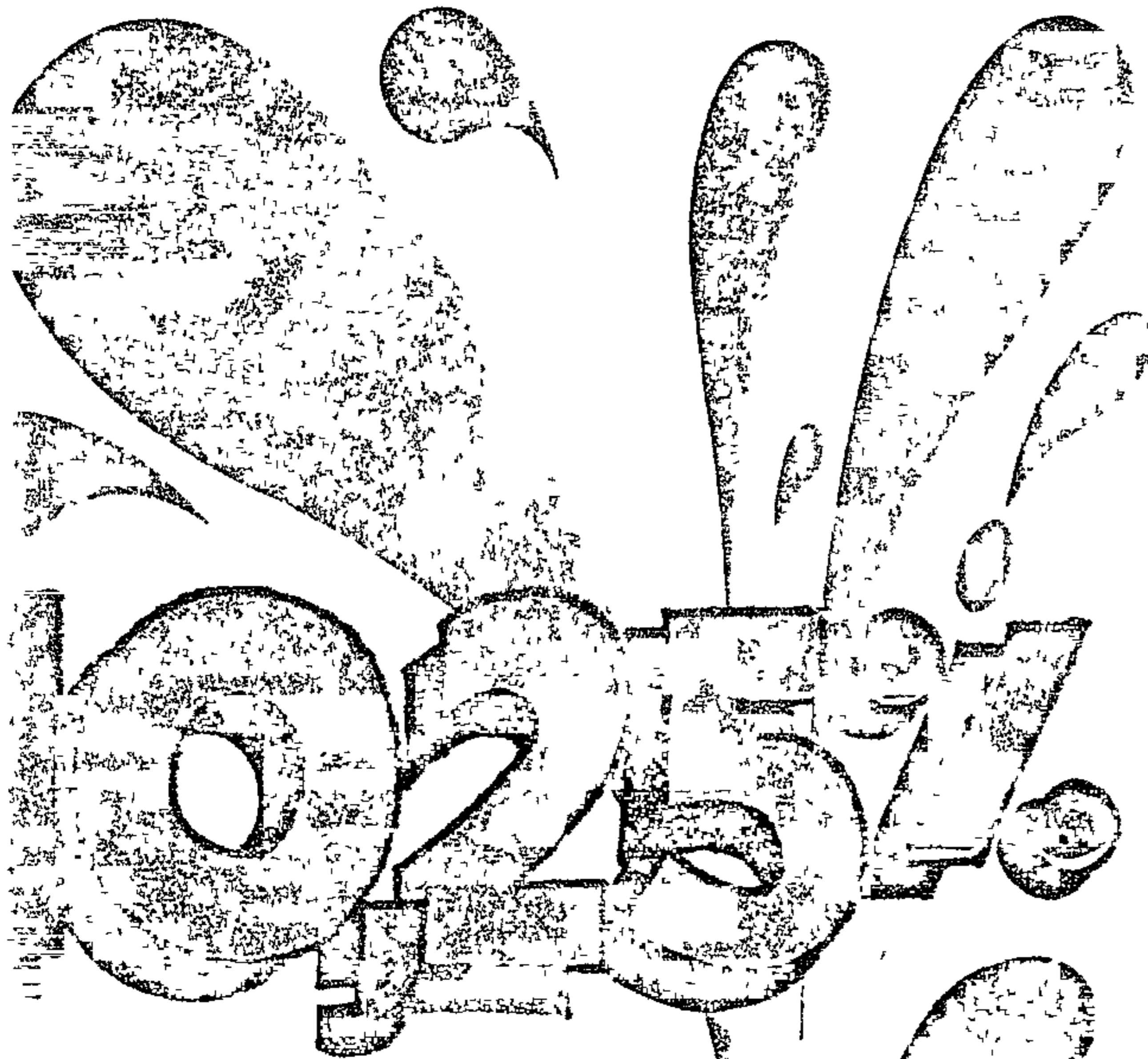

We've blown the top off savings rates.

As ordinary savings accounts go, Reactor-Save is quite extraordinary. It gives you interest rates which are immediately and automatically adjusted according to the size of your savings balance. And when you want to know what your money's earning power is, there's no complex arithmetic involved. Our rates are straightforward and down the line. What we quote is what you get.

But see them for yourself.

Less than R 200	= 3,50%
R 200 to R 499	= 5,00%
R 500 to R 4 999	= 8,00%
R 5 000 to R14 999	= 8,75%
R15 000 to R23 999	= 9,75%
R24 000 plus	= 10,25%

Every Trust Bank branch is your branch. You can deposit or withdraw money from any one of our branches countrywide... at no extra cost. And for your convenience, we have unusually long banking hours. Our doors are open from 08h00 to 16h30 on weekdays (Wednesdays included) and on Saturdays from 08h00 to 11h30.

Visit us soon. We're sure that there's a lot we can do to help make your dreams come true.

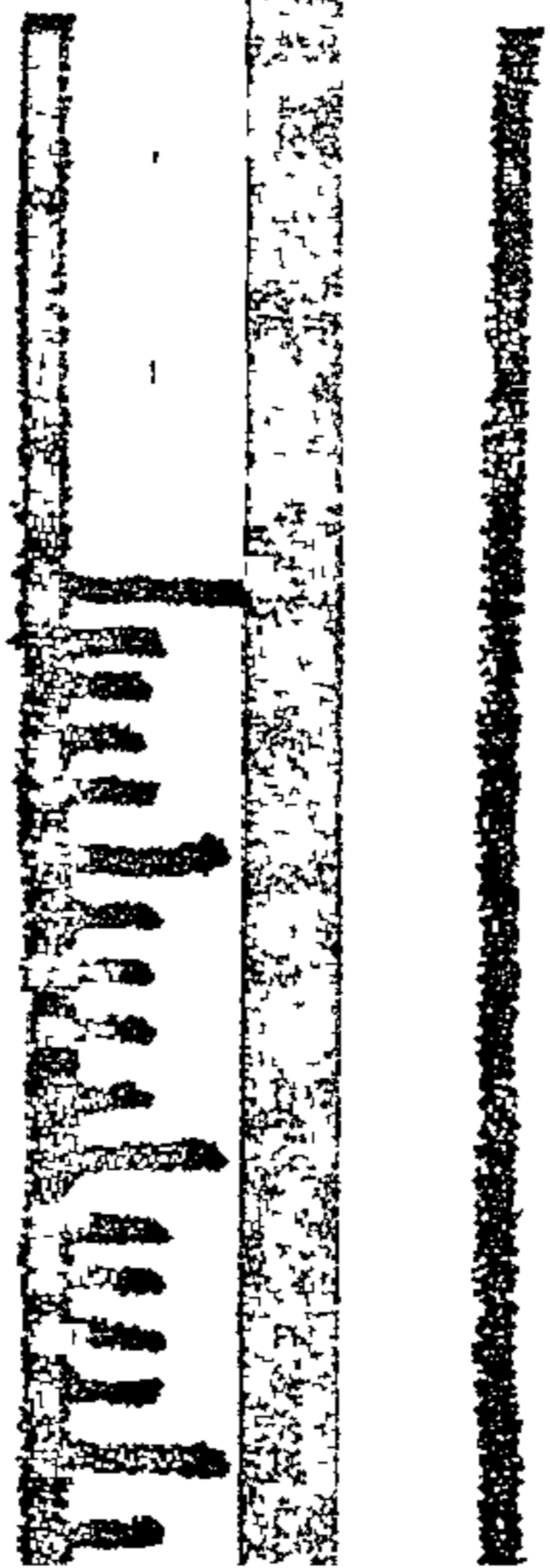

NEWS

Labour mobility freeze judged 'unfair'

A "freeze" imposed by employers on the movement of skilled workers in the diamond cutting industry has been ruled an unfair labour practice by the Industrial Court.

The application, heard in Johannesburg on March 8, was brought by a tenacious white union, the SA Diamond Workers Union.

It centred on a rule adopted in 1961 by the industry employer body, the Master Diamond Cutters Association, which required employers to go through the association for all labour needs.

The court upheld the union's contention that the rule had been unfairly used to freeze labour mobility in the industry. It ordered that the rule be deleted from the association's constitution.

It also ordered the association to pay damages to a worker, Mr B C Bonthuis, who the union said had been frozen out of employment for a two-week period last year.

The general secretary of the union, Mr Robin Rich, said the judgment had "smashed a 20-year-long Draconian practice". He added that when the industry moved out of its current recession the ruling would strengthen the bargaining position of workers.

An employer spokesman said the judgment "would have little effect" as there was already a termination of employment agreement with the union which precluded the free movement of labour in the industry.

WHAT'S ON

TODAY

Employers hit back at union

133

By Hugh Poulter

ANGLO American Corporation and the Steel and Engineering Industries Federation (SEIFSA) have hit back at the Metal Allied Workers Union (MAWU), who claimed last week that Anglo and Seisa were taking too hard a line with striking metal workers.

Sam van Collier, Seisa's director, tells Industrial Week: "As employers we have set in motion discussions with non-party trade unions about attitudes to the Industrial Council."

"We have set out guidelines to the members of Seisa and hopefully they will use them but in individual management makes it's own decisions."

"We have not pushed or recommended that management should fire or reinstate their employees in an effort to break strikes. The ideal objective is to try to de-escalate a conflict," he says.

A spokesman for Anglo American says Seisa is fully committed to negotiating wages with unions representing workers in the metal industry.

"For this reason it urged the Industrial Council to invite the unions that had not yet joined the council to attend the wage negotiations that are currently taking place, but unfortunately MAWU declined to attend."

Speaking at a meeting earlier in March to discuss the wave of unrest that has affected the Reef metal industries, MAWU general secretary David Sibabe said: "Employers are sitting on the lid of a volcano unless they agree to negotiate on pay directly with workers."

GENERAL NEWS

Talks on mine pay may hit deadlock

By Drew Forrest
 Crucial talks on wages for about 25 000 white workers on South African mines reopen in Johannesburg today — and the parties seem to be heading towards a deadlock

In negotiations with the Chamber of Mines the Council of Mining Unions — which embraces unions for artisans on the mines and the Mine Workers Union — has demanded a 16 percent pay rise and improved fringe benefits

Employers offered 3 percent on Friday

Describing the offer as a "kick in the teeth" union sources indicated that a deadlock was likely at today's meeting and a formal dispute could be declared

Industry sources said the low offer was because of the downturn in the economy and worsening of general economic conditions

A dispute was declared during last year's wage talks in the mining industry, but settlement was reached finally without recourse to the Government's conciliation machinery



STICKY END . . . Mrs Merle Be with a mouse her son Jonathan



DION WHERE YOU CAN BUY VIDEO EQUIPMENT AT LOW LOW PRICES AND KNOW THE QUALITY IS GUARANTEED!

FAMOUS MAKE BETA FORMAT VIDEO RECORDERS

- 3 hours and 45 minutes recording time using L830 tapes
- Records 1 programme over 3 days

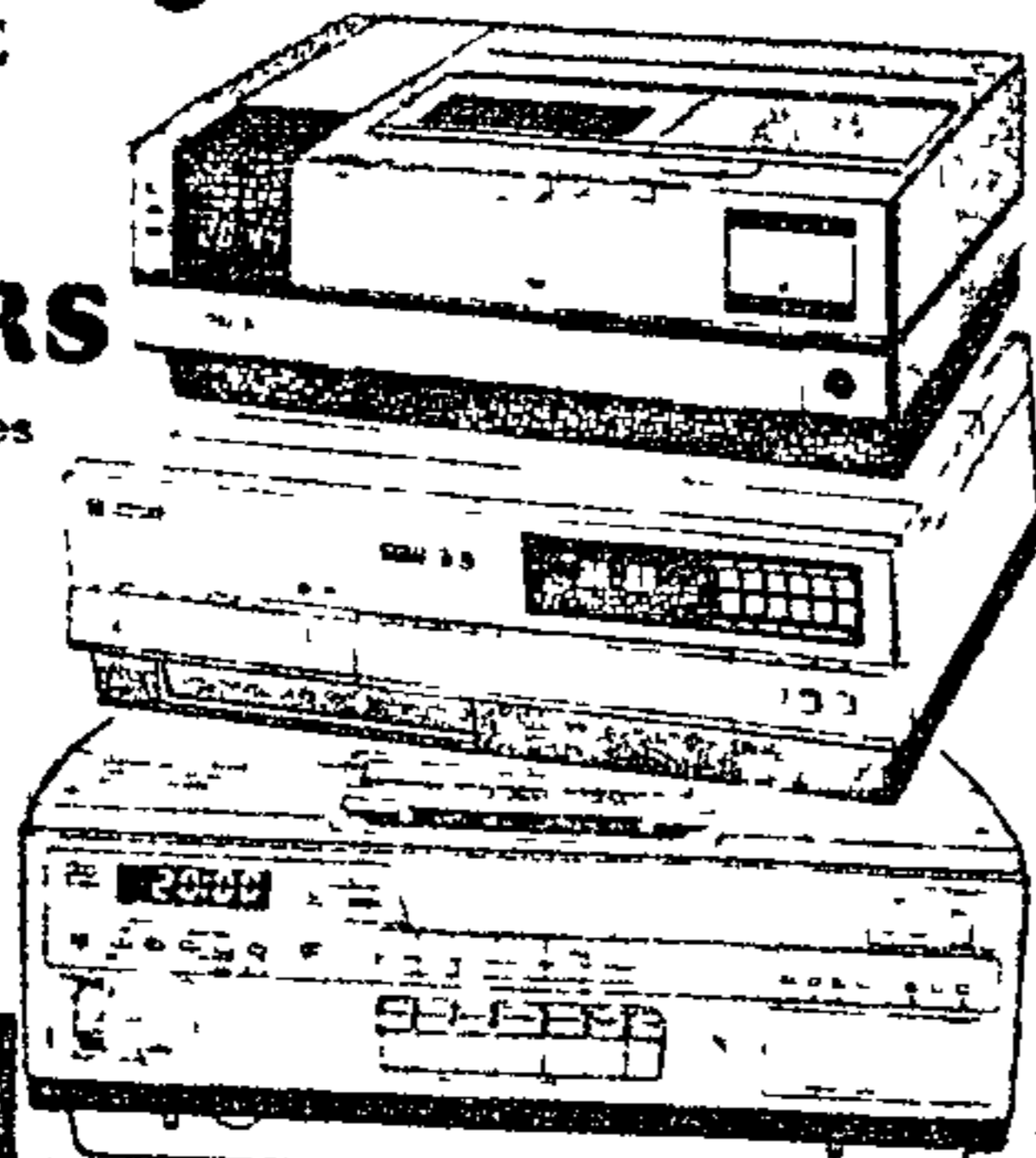

DION'S LOW PRICE **899⁰⁰**

FREE MOVIE & MEMBERSHIP
 Valued at R150 with every purchase of a video camera or video recorder. A fantastic selection of top quality imported movies.

FAMOUS MAKE JAPANESE BLANK TAPES • FULLY GUARANTEED •

1500 famous make Beta video tape 2 hours
 DION'S LOW PRICE **13.88**

E120 VHS famous make tape 2 hours
 DION'S LOW PRICE **17.88**

1750 famous make Beta video tape 3 hours
 DION'S LOW PRICE **19.88**

E180 VHS famous make tape 3 hours
 DION'S LOW PRICE **19.88**

Great value from DION This attractive all-wood



TV & VIDEO TROLLEY
 DION'S LOW PRICE **39.95**

DION ARE STOCKISTS OF ALL THE FOLLOWING VIDEOS & EQUIPMENT
 SHARP SONY
 HITACHI TOSHIBA
 SANYO JVC

TV & VIDEO CABINETS

- Sturdy wooden construction with rigid castor wheels
- Matches in with your modern lounge furniture
- Takes all sizes of TVs

DION'S LOW PRICE **69.88**

NATIONAL BACKED BY **MASTERCARE** VIDEO RECORDER SERVICE

DION

Low prices, high quality
 A promise we make is a promise we keep
 Prices exclude GST



PAY RENT

Only too true. But we cannot expect rent from Bricks that cannot pay rent. We have in excess of 200 tons of bricks for Paying that are

waiting to be used on your driveway. Now is your chance to get a brick driveway at a reduced price as we have old stock that is costing us

UNITED PAYING

133
2011
15/4/82

Another signing for union

By STEVEN FRIEDMAN
Labour Reporter

A SUBSIDIARY of the Anglovaal group, Feralloys, has recognised the Fosatu-affiliated Metal and Allied Workers Union (Mawu) at its Cato Ridge, Natal, plant — the union's third recognition agreement in Southern Natal.

Because of the Steel and Engineering Industries Federation's tough stance against bargaining with unions outside the official industrial council system, only a handful of employers have recognised these unions.

A union statement said the agreement, signed after three months' negotiation, gave Mawu sole negotiating rights at the plant, recognition of shop stewards and a negotiated grievance and disciplinary procedure.

An Anglovaal spokesman confirmed that Feralloys, which employs 550 workers, had recognised Mawu.

The union welcomed the agreement as an advance for metal workers in the area.

~~USA~~ ~~USA~~ ~~USA~~ (133) Stav

Metal industries pay talks fail—unions declare dispute ^{19/11/82}

By Drew Forrest

Industrial council pay talks covering almost 500 000 workers in the metal industries broke down for the second time yesterday — and the trade unions on the council have declared a dispute

The union move sets in motion the dispute procedure of the metal industries industrial council, and a council meeting scheduled for today marks its first stage

If the council fails to settle the dispute the parties could initiate

procedures for a legal strike or lockout — but they would have to wait for the expiry of the present agreement on June 30 before taking industrial action

At yesterday's talks the 14-strong union caucus rejected the pay offer of the employer organisations on the council which are all members of the Steel and Engineering Industries Federation (Seifsa)

A Seifsa statement said employers offered increases in scheduled wage rates ranging from 14.6 percent for

artisans (from R3.62 to R4.15 an hour) to 22.1 percent for the lowest grade of worker (from R1.13 to R1.38)

The unions are understood to have held out for a bottom rate of R1.63 an hour. Their original demand was for R1.75 rising to R2.00

There was also sharp disagreement over guaranteed increases, with the unions apparently demanding between 50c an hour for artisans and 30c for the lower grades and employers offering 25c for all categories

Mining Union declares dispute

Wage talks in Johannesburg between mining unions and their employers broke down yesterday with the unions declaring a dispute.

The Council of Mining Unions which represents about 25 000 white miners, announced that it would apply for the establishment of a conciliation board to arbitrate in the wage dispute

In a statement, the Chamber of Mines stated that it had asked the council to "substantially lower" its wage demands of 15 percent for the year and that it was willing to consider increasing its offer of five percent on standard rates

The breakdown in talks appeared inevitable in the light of earlier talks on Tuesday when the employers offered three percent to the council's demands for 16 percent

A spokesman for the unions who attended yesterday's talks said the Chamber of Mines opened the short meeting by giving a "lengthy lecture on current economic difficulties

"They told us they wouldn't even meet us half-way on our wage demands," the spokesman said.

"In light of their statement that they couldn't even meet us half-way, we declared a dispute"

A similar dispute was declared two years ago but was resolved before a conciliation board was established

17/4/82
S. Fein







133





Strike on mines looms as talks fail

A CONFRONTATION between white miners and their employers loomed yesterday as the Council of Mining Unions declared a dispute with the Chamber of Mines over pay demands.

Disputes have now been declared in the country's two biggest non-farming industries this week.

Registered metal unions declared a dispute with employers on Wednesday.

A dispute is the first step towards a legal strike

Yesterday unionists described the chamber's pay offer — 4% according to the unions and 5% according to the chamber — as ridiculous and accused it of taking its toughest stance in living memory on pay demands

They said it was "throwing down the gauntlet" to union men and one source said workers were set on holding a strike ballot unless the chamber changed its stance

But a chamber statement suggested the deadlock had been caused by the refusal of the CMU, which bargains white wages, to moderate its demands

The decision to declare a dispute — it will be declared formally on Monday — came after talks yesterday at which unionists demanded a 15% increase after originally demanding 16%

The chamber's first offer was 3%

One unionist said yesterday

"They took an extremely tough line. They offered 4% and then told us they were not even prepared to talk further unless we agreed to drastically drop our demands. They made it clear that unless we demanded less than 9%, they would not negotiate."

Another source said the chamber indicated it would offer 5% if unions agreed to slash their demands

A chamber statement yesterday confirmed it had asked the CMU to substantially lower its demand for a 15% increase in standard rates of pay

But, the statement said, the chamber indicated it was willing to consider increasing its offer of 5%

"No reciprocal gesture was made by the CMU, which then declared that a dispute existed," the statement said

By STEVEN FRIEDMAN
Labour Reporter

10/4 12/4/82

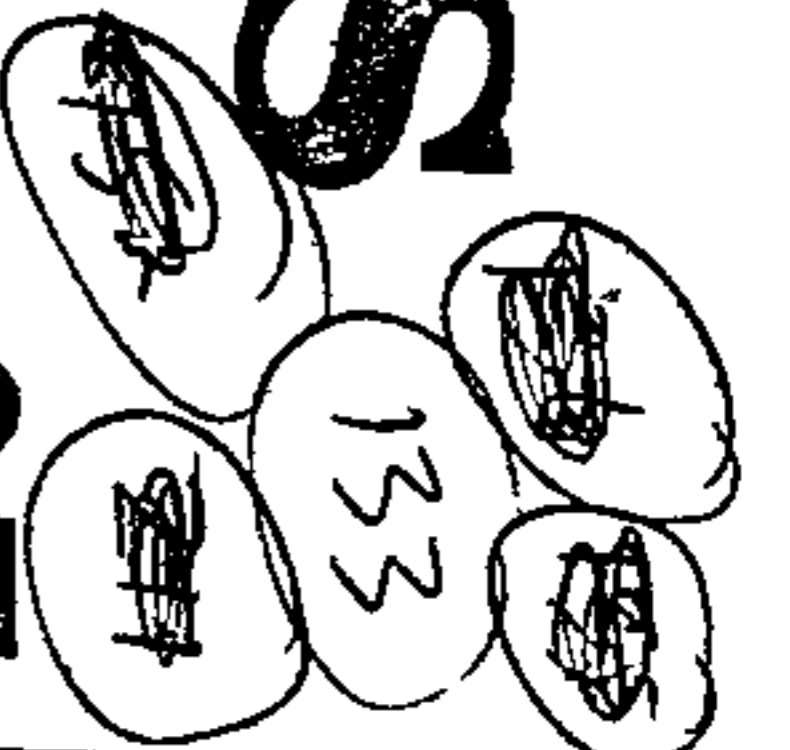

By STEVEN FRIEDMAN

Some 'chillingly familiar' advice for employers

22/4/82 RDM
133

EMPLOYERS who feel communication with their workers is adequate — and then complain they can't find out the reasons for a strike — might care to ponder the following document

It contains advice to workers from a major union and is quoted by Ford industrial relations director Mr Fred Ferreira, writing in the magazine Leadership SA. The union advises workers

- In the case of a strike, stay among the workers, don't create a strike committee. There must be no leader.
- In your conduct with the forces of order, you must be naive. You know nothing; you are bewildered.
- Work slowly, criticise the disorder and inefficiency of the managers; don't do their thinking; be a fool, and
- Take sick leave or time off to take care of your children as often as possible.

Mr Ferreira said employers who have experienced strikes over the past year or two may find this advice "chillingly familiar".

In many strikes, worker leadership has been "markedly reticent" about actual causes. Employers have had to "ferret (causes) out" themselves by "discussions, enquiries and cajoling".

The catch is that it does not come from South Africa — but from Poland. The document contains instructions from the International Metalworkers Federation to workers in Silesia and Warsaw during the Polish strike wave.

Mr Ferreira doesn't draw any conclusions, except to ask "Are we not fostering circumstances in this coun-

try conducive to the development of a Solidarity here?"

The lesson for local labour relations is simple but important. In a society in which workers have learned over many years not to speak up for fear of reprisals they will remain very suspicious.

This does not mean they won't strike — it simply means their employer, whether the Polish State or local business — won't know what they are thinking.

Building a climate in the factories in which workers and union leaders really believe they can speak frankly is not only essential if employers are going to avert unrest but requires a good deal of work from employers.

Despite the problem of accurately pinpointing what workers are thinking, Mr Ferreira names four issues as "major union concerns" — job security, pensions, detentions and homeland independence.

On the first point — no doubt with the economic downswing in mind — he notes a growth in union demands for "participation in decisions affecting the security and separation bene-

fits of their members'.

Detentions Mr Ferreira adds are leading unions to question the integrity of Government reforms and the recent pension unrest 'graphically exemplifies the total absence of consultation and a penchant to legislate'.

With recent East Cape tension over the effect of homeland independence on unemployment benefit in mind Mr Ferreira noted opposition to independence. The transfer of benefits to independent homelands "only serves to render such security suspect".

These points demonstrated the impossibility of discussing labour matters without tackling socio-political issues. The two are linked because, as long as city blacks are denied "meaningful" political rights, they will use labour power to pressure the Government and employers — powerful agents of change.

The future of labour relations depends on what reforms the Government introduces and what pressure labour brings to bear on employers. It is unlikely the Government will consider moves such as meeting recognised black labour leaders and negotiating on political issues. Employers

will continue to "bear the brunt".

"A reasonable prognosis for the medium term" was a growth in "community-based" unionism, more shop-floor bargaining and a strike incidence not lower than the 1981 level.

Employers needed to make known their position on union recognition, and initiate change on wages training and advancement — but with worker involvement. Employers should avoid deciding what was right, implementing it and then "looking round for applause".

Communication systems should be reviewed and easy-to-understand discipline and grievance procedures implemented. All this did not mean employers should abdicate their position, he said. They should not "be expected to make amends for the next 300 years for a system which was often unilaterally developed but which also grew out of a mutually responsible set of circumstances".

Employers had to assess their "back-off positions" — the extent to which they compromise.

But worker groups had to do this too, and there was already a risk that employer willingness to negotiate "is interpreted as a sign of vulnerability".

Because a particular stoppage had benefitted workers, worker groups should guard against believing more benefits could only be gained by more strikes. Outside the workplace, employers have to look at housing, health services and job creation — together with workers.

This did not mean a delegation of authority, but employers had been preoccupied with authority and control for so long workers resented this

d. th — M in sh m. M th h. ex ce ba Bl Bl pr su M. in ha hn pr St I A in Sc ec M ex P N F

'Agents' spying on workers for the bosses

24/4/82 S Post
133
~~206~~
~~255~~
~~277~~

Weekend Post Correspondent

JOHANNESBURG — "Secret agents" are infiltrating workers' unions at large industrial companies in South Africa

Their task is to inform the employers of any labour unrest and to name the ringleaders

This was revealed this week by Mr Archie Griffiths, managing director of Security Service Consultants, who disclosed that black agents he had employed had been very successful

He also warned that labour unions with strong ANC links moved into companies where there was unrest or dissatisfaction

He said that much of the unrest went on without the knowledge of the managements

"Our job is also to identify the real trouble-makers, not the front men who are usually stooges

"The trouble-makers can create grievances out of nothing. Workers may be happy and there will be a demand that they strike, and they strike

"Often grievances are inter-related with sab-

otage We found in one case that workers were overpacking soft goods for export, and on another occasion a quality controller was rejecting goods which were perfectly good. These goods were destroyed at a great loss to the company

"Strong-arm tactics have also been used. We uncovered evidence of a blackleg in Germiston being murdered

"Many companies have workers' councils, but true grievances are not raised by them. They are not taken seriously by the workers who consider them just one step above a suggestion box. They have no teeth. The first knowledge the managements have is when there is a strike

"Our investigations reveal the grievances, and the ringleaders and we have managed to pre-empt some of the strikes. In other cases managements have refused to accept our assessment and then been hit with a strike

"Once there is a strike or other labour unrest unions move in and take

over. Managements have been forced to accept these unions to break the strikes, but often these unions are not too concerned about the workers. They are after political power — and they want the grievances to continue"

Mr Griffiths said his company's recommendations were always to solve the grievances

"Sometimes managements have promoted the trouble-makers or transferred them, but that does not solve the problem

"The workers at one company demanded an increase of R2 an hour, but they settled for an increase of only 7c an hour just so that the union could be recognised

"Managements must treat staff in a responsible way and find out the causes of their grievances. The old system of labour exploitation is past, and unless managements keep themselves fully in the picture they are going to have serious political problems"

Mr Griffiths said that managements often underestimated the sophistication of their workers

A
w
u.
cc
P.
F.

er
in
Al
ho
th
Se
th

go
cre
fr
the
ha
va
ra

th
ti
an
int
in

se
in
th
C
th
h
d

/
/
t

133
1860

Dispute declared in unions' wage row

RDM April 1982

By STEVEN FRIEDMAN
Labour Reporter

REGISTERED trade unions in the giant metal industries yesterday declared a dispute with metal employers represented by the Steel and Engineering Industries Federation on workers' pay demands — the first step on the road to a legal strike

The dispute will now be handled by a special procedure set out by the industries' industrial council and the procedure will get under way at a council executive meeting today

A legal strike or lock-out will become possible if the dispute is not settled by the time the present industrial council agreement, which covers over 450 000 workers of all races, expires at the end of June

This is the first time a dispute has been declared in the industries since the mid-1970s. On two occasions then the dispute was settled before a legal strike ballot was called, but both union and employer sources believe it will be more difficult to settle the dispute this time because of strong wage pressure from black unskilled workers

The dispute was declared after a meeting of the council yesterday at which unions rejected a new Seifsa wage offer. Yesterday's council meeting followed one in March in which the two sides deadlocked over Seifsa's unwillingness to grant "across the board" increases.

Seifsa's director, Mr Sam van Coller, said last night that Seifsa had offered unions a 25c

across the board increase for all workers at yesterday's meeting

He said it had also offered a new minimum rate of R1,38 an hour — an increase of 25c over the present rate

Mr Van Coller said Seifsa had also offered a new minimum rate of R4,15 for artisans as compared to the present rate of R3,62. It had also offered a full investigation into aspects of overtime work and had undertaken to finance basic courses in arithmetic and literacy for unskilled workers

The director of the Confederation of Metal and Building Unions, Mr Ben Nicholson, confirmed this account of Seifsa's offer. But he said that while the offer "appeared reasonable to those without a knowledge of the industry" it was "unacceptable" to union members

He said the offer would give skilled workers in effect a five to 6% increase because these workers would not benefit from an increase in the minimum rates

The unions were also unhappy about granting higher-paid workers the same increase as those lower down the scale

He added that the offer was also "totally unacceptable" to black workers who were demanding a major effort to close the wage gap and boost unskilled wages

"Black workers feel the time has come for a showdown on their demands and they will not settle for this offer," Mr Nicholson said

A dispute will now be discussed at an executive meeting of the industrial council today and attempts to continue to resolve it will continue. If these fail, mediation or arbitration could be introduced if both sides agree

Iron men won't bend — meeting date fixed

Labour Correspondent

THE executive of the giant metal industries' industrial council will meet on May 11 in a fresh attempt to settle the wage dispute between employers and unions over minimum pay and conditions for nearly half-a-million workers of all races

And yesterday, the biggest white union in the industries, the SA Iron, Steel and Allied Workers Union, issued a statement spelling out its objections to employer wage proposals

The May meeting was revealed yesterday in the statement, by the union's senior deputy general secretary, Mr H Ferreira.

Unions on the council declared a dispute with the Steel and Engineering Industries Federation after rejecting an offer of a 25c "across the board" increase for all workers and raises in minimum rates of between 14.6% and 22%.

A dispute is the first step on the route to a legal strike or lock-out ballot. The dispute is now being processed by the council's dispute-settling machinery and the May 11 meeting is the next step in this process.

In his statement yesterday, Mr Ferreira said the employer offer meant "many, if not most" skilled workers would receive no rise or "very little"

Terminated membership of TUCSA in 1973 as about to fold.

Year	Membership		
	African	Asian and Coloured	White
1970			200
1971			200
1972			200
1973		156	156
1974			
1975			
1976			
1977			
1978			
1979			
1980			

SAB labour plan backed by Sutton

133 Star 28/4/82

Labour Reporter

A sound industrial relations policy for the South African Breweries group of companies was evident by the lack of labour unrest over recent years.

This is the view of Mr Dick Sutton, former industrial relations advisor for SAB and member of the Wiehahn Commission.

Mr Sutton retired at the end of March and has taken up a professorship at Unisa's School of Business Leadership. He maintains a retainer relationship with SAB.

When Mr Sutton joined SAB in 1973 several of the group's Durban firms were hit by the general labour troubles sweeping the area.

A system of liaison committees was established for black employees which was different from other committees in that workers elected their own representatives and the committees were independent of white, managerial supervision.

From 1974 SAB also instituted a system of company monitoring of basic minimum wage and working conditions for employees.

Mr Sutton was also involved in the drawing up of a group code of employer practices several years later.

He said they tried to instil in management personnel a high level of awareness towards labour developments long before the Wiehahn reports



SAB's former industrial relations adviser, Mr Dick Sutton.

During his career with SAB Mr Sutton also served on the Wiehahn Commission which investigated labour reforms.

On the subject of trade unions Mr Sutton said the SAB's stand had been that if workers wanted to form a trade union they were free to do so.

He said once workers received registered trade union rights after 1979, the company saw no reason to discontinue the committee system, but envisaged that they could run parallel to, or in harmony with trade unions.

There are several trade unions which currently operate and recruit SAB workers in the commercial, distributive, furniture and food trades.

Mr Sutton said SAB's policy of recognising unions was based on a policy of representativeness.

Unions preferably had to prove membership of workers in a given sub-

diary industry on a provincial basis, he said.

Union registration or membership of an industrial council were not hard and fast prerequisites for recognition.

The issue of representativeness was the grounds for recent disputes between SAB and the Food, Beverage Unions at the group's brewery plants on the Reef.

There are several industrial councils involved in wage and other determinations for the group. These are for example the beer, furniture and show industries.

SAB was hit by the wave of pension unrest in Natal last year.

Mr Sutton said they conceded there were misconceptions about the group's pension fund and that the issue was being examined.

SAB has experienced little unrest over recent years.

"Issues such as minimum wages and working conditions have been examined and adjusted from time to time. We haven't waited for labour pressures," Mr Sutton said.

On the subject of an extended military call-up system in the future, Mr Sutton said the army had not yet come to grips with the manpower position in South Africa and has not established a body to examine these problems.

554691

\$	216
\$	138
\$	338
*	078
*	221
*	238
*	2372
*	2424
∅	2500
∅	2500
∅	2500
	Total

Registra
Founded:
Area of
Officia
Address

198
197
197
191
19
19
19
19
19
19
19

Ye

Court looking at status of sugar workers

28/4/82 Mercury

133

Mercury Reporter

IT WAS important for the sugar industry that costs were maintained at a low level so that it could successfully compete in the export markets, the general manager of C G Smith's Management Services, Mr Don Macleod said yesterday.

He was giving evidence in this week's Industrial Court sitting to consider the distinction between farm labourers and industrial workers in order to resolve a 30-year-old dispute within the sugar industry.

The dispute revolves around the status of workers loading and unloading cane at 'mill sites' and 'loading zones' and who have been regarded as agricultural workers and therefore not covered by the Sugar Industrial Council agreement.

The Industrial Court, which is being presided over by the president, Mr B J Parsons and the vice president, Dr D B Ehlers,

has been asked by the Sugar Manufacturers and Refining Employers Association and the National Union of Sugar and Manufacturers and Refining Employees to consider whether these workers should not fall within the agreement.

Mr Macleod told the Court that if cane loading workers were brought into the Industrial Council agreement each miller/planter — a miller who also farms sugar — would have to pay a higher transport rate and therefore would be prejudiced in comparison with the farmer.

Under cross-examination by Mr M Pillimer, representing the National Union of Sugar Manufacturers and Refining Employees Union, Mr Macleod conceded that the present sugar transport system was in the interest of the miller.

'It is absolutely essential for the miller to make

sure the cane is delivered properly in order for the mill to operate,' he said.

Mr Pillimer said it was therefore in the interest of the miller to continue the present transport operation even if he had to pay higher wages to the cane loader workers.

Earlier, Mr K R McCall, representing the Sugar Employers' Association, outlined the numerous types of 'mill sites' and 'loading zones' where cane was loaded before being transported to the mill.

The Court heard how a substantial number of workers — more than 543 — employed at these sites to load and unload cane were paid agricultural wage rates, but no contributions to an unemployment insurance fund were paid. Workers covered by the agreement had the benefit of an unemployment insurance fund.

The hearing continues today.

Mixed feelings on industrial councils

TRADE unionists have expressed mixed feelings about the future of the Industrial Council system — the official mechanism for collective bargaining at an industry level.

Union sources maintain the system will not be able to cope with pressures from the emerging black unions, which place great emphasis on plant-level negotiation on wages and working conditions.

However a spirited defence has also been made by those unionists who believe that the industrial council system should be maintained.

to show if the new labour dispensation by the Government has been given enough time to prove its responsiveness to the needs of the parties in labour.

The industrial council is made up of unions and employers — from the whole industry — who sit together. In the coun-

Joshua Raboroko on the labour beat



cil they meet to negotiate wages and working conditions, for the whole industry. These are then published by the Government as law and any employer can be prosecuted for ignoring them.

In effect, the council is half-union. It would not exist if either the union or employer organisation withdrew from it. Through the council, the unions can with employers, decide to establish various benefits. Such benefits may differ from industry to industry because it of course all depends on what the union tries to

achieve. An industrial council secretary and staff are employed to administer these benefits and funds and to ensure that the agreements on wages and working conditions are observed in each and every factory.

Recently in two sets of negotiations — in the mining and metal industries — trade unions have declared disputes, refusing to accept terms offered by employers.

The disputes are as a result of wide gaps in the employers' offers and union expectations.

The dispute was declared after a meeting of the council at which unions rejected a new

Steel Engineering Industry Federation of South Africa (Seitisa) offer.

Seitisa's director, Mr Sam van Coller, has said that Seitisa had offered unions a 25c across-the-board increase for all workers at the council discussions.

It had also offered a new minimum rate of R1,38 an hour — an increase of 25c — and a new minimum rate for artisans of R4,15 as compared to the present rate of R3,62. It has also offered to investigate overtime and to finance basic courses in arithmetic and literacy.

The director of the Confederation of Metal



MAKING DEMANDS Can industrial councils help?

and Building Unions. Mr Ben Nicholson was also reported to have said the offer would give skilled workers a 5 to 6 percent increase because these workers would not benefit from an increase in the minimum rates.

The unions were unhappy about granting higher paid workers the increase as this would mean much less to skilled workers in percentage terms.

He said the offer was unacceptable to blacks who demanded a major effort to boost unskilled wages and to close the gap

Year	African	
1970		
1971		
1972		
1973		
1974	150	
1975	150	
1976	273	
1977	500	
1978	451	
1979	542	
1980	765	

Address: P.O. Box 6
Johannesbu
2000

Officials: Secretary:

Area of Operation:

Founded: 1973

Registration: No

Other employers who serve on the councils have declared that this government-created labour dispensation should be given a chance to prove its effectiveness.

"There is a place for both centralised and decentralised bargaining. We have to look for a compromise," one said.

The employer warned that if no compromise was reached between employer and unions on the councils, labour can be permanently scarred. Bargaining on plant-level can only be for short-term advantages for a limited group of

Address: P.O. Box 6
Johannesbu
2000

Officials:Secretary:

Area of Operation:

Founded: 1973

Registration: No

and Building Unions Mr Ben Nicholson, was also reported to have said the offer would give skilled workers a 5 to 6 percent increase because these workers would not benefit from an increase in the minimum rates.

The unions were unhappy about granting higher paid workers the increase as this would mean much less to skilled workers in percentage terms

He said the offer was unacceptable to blacks who demanded a major effort to boost unskilled wages and to close the gap

The deadlock in these discussions meant that the workers could legally go on strike, and already some 1 700 workers in the Reef have gone on strike seeking higher pay About 380 have been sacked at a Wadeville steel industry

Many discussions between employers and unions have ended in a deadlock — does this mean that the industrial councils have any future?

Yes says the president of the Garment Workers' Union of SA, Dr Anna Scheepers, whose union recently concluded an agreement for over 250 000 workers in the clothing industry

She has urged workers to fully realise how important the Industrial Council was in winning improved and working conditions for all

Dr Scheepers says it was vital that union representatives and employers should 'get round the table' to negotiate the new agreement in the industrial council

It is the job of the council to see that all employers in the clothing industry should carry out the new wage agreement and other benefits

"This will prove to workers the necessity of an industrial council to see that the agreement made by union and employers is carried out, and to administer the benefits in terms of the agreement" she said

Other employers who serve on the councils have declared that this government-created labour dispensation should be given a chance to prove its effectiveness

"There is a place for both centralised and decentralised bargaining We have to look for a compromise," one said

The employer warned that if no compromise was reached between employer and unions on the councils, labour can be permanently scarred Bargaining on plant-level can only be for short-term advantages for a limited group of people.

But Mr Jan Theron, general secretary of the African Food and Canning Workers' Union, said this "system of bargaining" should be rejected and his union has refused to serve on them

Most unions treat the councils with suspicion and do not trust them. Basically the employers are at an advantage in the council because they organise while unionists and workers lack organisation

Most blacks are unskilled and therefore bargaining for them is often difficult It is therefore vital that plant-level agreement be reached, he said

The recent inter-union summit in Wilgespruit strongly recommended that unions leave the industrial councils and requested that participating unions refer this back to their respective unions for endorsement

Most unions agreed to support each other in the event of any union resisting participation in the council

Fosatu also debated this issue at its recent congress and said the industrial councils in their present form were unacceptable

Unions were not to enter them on terms which were to their disadvantage, and they should begin industry-wide bargaining with the framework of Fosatu's principles

BIF to comment on political matters in SA

133 Mercury
27/3/82

THE building industry is gearing itself to make official comments on political matters.

Mr Leon Glaser, president of the Building Industries Federation (South Africa), says in his regular column in the magazine SA Builder 'Following recent events which certainly demanded and deserved the attentions of all concerned South Africans, I must again pose the question. Are we just a group of builders who are just interested in their immediate short term economic

results or are we a group of builders with vision and an interest in the future?

'If the former, fine; we are doing a good job. If the later, not so fine; we are almost inconspicuous.

'The fact that a detainee committed suicide for no reason known to the public would seem to make it unnecessary and undoubtedly there are those who would say wrong, for Bifsa to even issue a statement let alone take a stand

'Surely the fact that we, firstly on a business level, secondly on a moral level,

require a stable if evolving climate in which to carry out our daily tasks, surely this fact requires us to stand up and have our say in the overall management of our affairs

Isolation

'The industry is not divorced from national events. The industry cannot prosper in isolation. In fact, the first industry to suffer in any period of instability will be ours

'It is therefore incumbent on the leaders of the industry to state unequivocally their condemnation of the events which led to the suicide and resulting disruption of our business and our moral consciences.

'We realise that oversimplification is dangerous but we cannot accept that the incarceration of people should continue without them being brought to trial on charges.

'It is not competent for any man to make a balanced judgement of any event without being in possession of all the facts. For that reason, the aura of secrecy which surrounds many of our legislative procedures only serves to foster the worst possible interpretation of Government action.

'At a far lower level, consider your heated emotions as a contractor when items such as the secret award of building contracts without the disclosure of tender results occur'

The magazine also criticises what it calls the logic used by the otherwise sophisticated building public. It describes their

logic as just as impressive as the logic of 'the March hare and the Mad Hatter with their exploits in Alice in Wonderland'

It says 'It will never cease to amaze the building industry that business enterprise, which has acquired its considerable wealth on the cornerstone of capitalistic philosophy — profit, supply and demand, economic utility and the cost of scarce and abundant resources — can still believe in the fantasy of obtaining exotic buildings and structures at no cost — less two-and-a-half percent.

'No doubt it is easy to demand fierce negotiations to depress workers wages when those who make the demands do not have to live off depressed salaries

Hands

'The building industry is one which historically has to use hands — for hands create houses, flats, churches, hospitals, stock exchanges, country clubs et al. Hands also have to feed, clothe, house, entertain, educate and support other hands.

'Let us hope that during this March all the madness will be dissipated with the realisation that the building public by way of trading fairly and honestly with the building industry will be honouring its commitment to the free enterprise capitalistic ideologies, as well as affording great services to its fellow South African citizens — not by way of charity, but by way of payment for a job well done regardless of race, colour or creed.

133

EXPRESSSCOPE

LOOKS AT THE BACKGROUND OF UNREST.

SA can't afford political silence from leaders of private sector

LAST YEAR, after dozens of trade unionists were detained, Tony Bloom, chairman of one of South Africa's top 10 companies, tried to convene a delegation of businessmen to see Minister of Police Louis le Grange.

Despite contacting many influential business contemporaries he found it impossible to put a delegation together.

He is not able to put his finger on why businessmen fear 'becoming involved' on social or political issues.

TEN days ago Tony Bloom, dynamic young chairman of Premier Milling and one of the country's leading companies, called on businessmen to stand and be

Special report



by CHARLENE BELTRAMO

counted on matters of national socio-political and economic importance. The response, as his speech might have indicated, has been a predict-

able, apathetic, uncomfortable silence. He spoke about his controversial stand and quoted from his highly significant speech.

mer company, the following day but he was detained. Dr Aggett was found hanging in his cell four months later.

Mr Bloom's instincts place into question those of his contemporaries. "If businessmen expressed displeasure with certain government measures I think the Government would

its in a disintegrating community. The continuance of the status quo does not suit the preservation of a healthy economy."

Mr Bloom sees a danger in businessmen appearing to tacitly support all government action and laws by never being seen to question or oppose.

"As things stand, free enterprise is seen and accepted as part of the system. This system is unequivocally rejected for its perceived support of oppression and apartheid."

Mr Bloom said "The whole question of politics and economics in this country is so interwoven, businessmen cannot help but be involved

Mr Bloom lashed out at the business community for being "very badly orchestrated".

He said last year's Good Hope conference and the Carlton conference before that were examples of the Government orchestrating the business community to achieve certain objectives.

tent predictable. "It does not have half the impact it could have if an executive in a more conservative mould came out with a critical standpoint."

In his recent speech at the annual dinner of the South African Institute of Chartered Accountants in Durban, Mr Bloom said "The idea that business has one and only one objective — to maximise profits — has been the majority view for the better part of business history and this view is still held by some



● Tony Bloom time to take a stand

particularly a country which faces as great a challenge as South Africa does today, be deprived of the involvement of one of its most vital constituencies and why should the professions expect or allow other interest groups to dominate our national thinking?"

"There can be no profits for business or careers in a disintegrating community, a community characterised by unemployment, civil disorder or crime. "In South Africa, formal acceptance of social responsibility has been slow but in

Private Sector

Special report

By CHARLENE BELTRAMO



LAST YEAR, after dozens of trade unionists were detained, Tony Bloom, chairman of one of South Africa's top 10 companies, tried to convene a delegation of businessmen to see Minister of Police Louis le Grange.

Despite contacting many influential business contemporaries he found it impossible to put a delegation together.

He is not able to put his finger on why businessmen fear 'becoming involved' on social or political issues.

"Many people, including businessmen, have the dangerous psychological attitude of where there's smoke there's fire."

Perhaps indicative of Mr Bloom's finely-tuned instincts, nearly all those trade unionists have been released after months of security police detention without charges being laid against them.

The sad exception was Dr Nell Aggett of the African Food and Canning Workers Union who, on the Thursday before his detention, completed negotiations with Epol, a Premier company. He was to have met executives of Epic, another Pre-

TEN days ago Tony Bloom, dynamic young chairman of Premier Milling and one of the country's leading companies, called on businessmen to stand and be

counted on matters of national socio-political and economic importance. The response, as his speech might have indicated, has been a predict-

able, apathetic, uncomfortable silence. He spoke about his controversial stand and quoted from his highly significant speech.

mer company, the following day but he was detained. Dr Aggett was found hanged in his cell four months later.

Mr Bloom's instincts place into question those of his contemporaries. "If businessmen expressed displeasure with certain Government measures I think the Government would have to sit up and listen."

"They often dismiss critics as the lunatic radical fringe. university students and do-gooders but if the conservative business community verbalised dissatisfaction I think they would have to sit up and take notice."

"I'm not advocating subversion — I'm a conservative — but there are no prof-

its in a disintegrating community. The continuance of the status quo does not suit the preservation of a healthy economy."

Mr Bloom sees a danger in businessmen appearing to tacitly support all government action and laws by never being seen to question or oppose.

In this regard he is fond of quoting Mr Justice Jan Steyn, executive director of the Urban Foundation, a man he holds in high regard. "The real danger facing South Africa, and therefore the total business community, is that unless a system of free enterprise is perceived by blacks to provide acceptable standards and values, it will be rejected as the ally of racism."

"As things stand, free enterprise is seen and accepted as part of the system. This system is unequivocally rejected for its perceived support of oppression and apartheid."

Mr Bloom said "The whole question of politics and economics in this country is so interwoven, businessmen cannot help but be involved."

"Politics are an integral part of economics, one cannot avoid being drawn in. Statutory discrimination exists at a huge cost to business."

"Migrant labour is integral to most businesses in this country. — one simply cannot afford not to use it, but we can make it as humane as possible."

Mr Bloom lashed out at the business community for being "very badly orchestrated".

He said last year's Good Hope conference and the Carlton conference before that were examples of the Government orchestrating the business community to achieve certain objectives.

"The business community should have got together beforehand and said 'you handle this aspect, and you that' but instead all pitch up like a bunch of dummies and take a terrible hiding and wonder why."

"We also need new men to take a stand on certain issues. If Harry Oppenheimer, Mike Rosholt or myself take a controversial, or dissenting, view it is to some ex-



● Tony Bloom

time to take a stand

tent predictable. "It does not have half the impact it could have if an executive in a more conservative mould came out with a critical standpoint."

In his recent speech at the annual dinner of the South African Institute of Chartered Accountants in Durban, Mr Bloom said:

"The idea that business has one and only one objective — to maximise profits — has been the majority view for the better part of business history and this view is still held by some eminent and notable business thinkers."

"Public exposure by professional people — such as accountants or lawyers — is frowned upon and viewed as undignified flamboyance to be avoided wherever possible."

"I believe the time has come for a re-assessment of this view."

He said that in the professions the acceptance of a doctrine, and greater involvement in the broader issues of society was not only desirable, but necessary. "Why should any country,

particularly a country which faces as great a challenge as South Africa does today, be deprived of the involvement of one of its most vital constituencies and why should the professions expect or allow other interest groups to dominate our national thinking?"

"There can be no profits for business or careers in a disintegrating community, a community characterised by unemployment, civil disorder or crime."

"In South Africa, formal acceptance of social responsibility has been slow but in South Africa it is doubly important because generally speaking (and unlike most other Western countries) both the professions and business find themselves to the Left of the Government and an important force for change and social reform."

"Why does it always take a crisis to evoke our conscience?"

He told the accountants to compare the "magnitude of the shrieks of anguish" over the proposed fringe benefits tax (where it was possible to mobilise an orchestrated re-

3/2/84

response to the Government's committees memoranda, (B) spokesmen seminars) with the deafening silence" of business leaders and leaders in professions over the years on issues such as land tenure, for Africans in urban areas, forced squatter removals, or detention without trial of much of the trade union leadership in this country.

"I am absolutely appalled at the lack of courage displayed by the business community in not speaking out on this important issue.

"Apart from the human considerations which are considerable if the government is going to lock up many of the leaders of the trade union movement and detain them without trial, and then release them after a period of months in detention, as has already happened, then we in the business community are in for a very rough ride indeed.

"I hold no particular brief for the people concerned, neither do I know what they are alleged to have done - but if they have been involved in subversive activities then the proper place for that to be decided is in the courts and not by administrative action.

"These are the people whom management is going to have to negotiate with - a legacy of bitterness will have been created and a surer formula for conflict is hard to devise.

"All of us involved in the free enterprise system must re-examine our role in society and question to what extent the scope of our activity should be extended to protect the economic structures we have built over the years.

"All of us must ask ourselves to what extent our particular areas of expertise and knowledge can be put to use in effectively improving the environment and opportunities.

"I believe the acceptance of this broader role is not an expensive luxury but a fundamental necessity for all who care deeply about this country.

"I am sorry to say that I believe too many of us have been guilty of sitting on the sidelines for too long and that it is a basic duty for all of us to involve ourselves in every aspect of South African life whether political, economic or social.

"Several years ago, former Prime Minister John Vorster warned businessmen not to meddle in politics. This was an unqualified nerve.

"I totally reject the notion that we should stay out of the political field - although I would like to emphasize I am certainly not making an appeal for any particular political party or philosophy.

"Let us discard the semantics of whether our opinions should be characterized by consultation or confrontation and settle for opinions characterized by involvement, honesty and integrity."

and Allied Workers Union
Catering Trades Employees Union
Salesladies Association
and Allied Trades Assistants Union
and Allied Workers Union
Trade Union
and Allied Workers Union
Salesladies Association
and Allied Trades Assistants Union
Commercial, Catering and Allied Workers
Distributive Workers
for die Kleinhandel Meisbedryf
Great Trade Employees Union
Catering Trades Employees Union

TRADE AND CATERING AND ACCOMMODATION SERVICES

and Allied Workers Union
Kers Association
and Allied Workers Union
Society
ative, Plumbers Employees Association
Engineering, Industrial and Allied Workers
Workers Union
onal Workers Union of South Africa
ed Workers Union
ed Workers Union of South Africa
ed Trades Union of South Africa
on and Allied Workers Union
ond
s Union
Building Trade Workers
ing Union of South Africa
Of Woodworkers

Local Water Work Mechanics Union
Association
Undertaking) Salaried Staff Association
s Union

Dental Mechanics
Union
Dental Mechanics

South Africa
withs Union

Spies on factory floors keep tabs on labour unrest

SECRET agents are infiltrating unions at large industrial plants to inform the employers of any labour unrest and to name the ringleaders

This was revealed to me this week by Mr Archie Griffiths, managing director of Security Service Consultants, who disclosed that black agents he employed had been successful

He also warned that labour unions with strong ANC links moved into companies where there was unrest or dissatisfaction.

He said that much of the unrest was carried out without the knowledge of the managements.

"Our job is also to identify the real troublemakers, not the front men who are usually stooges.

The troublemakers can create grievances out of nothing. Workers may be happy but there will be a demand that they strike and they go on strike.

Often grievances are in-terrelated with sabotage. We found, in one case, workers were overpacking soft goods for export, and on another occasion a quality controller was rejecting goods which were perfectly good. These goods were destroyed at a great loss to the company.

By DESMOND BLOW



"Many companies have workers' councils, but true grievances are not raised by them. They are not taken seriously by the workers who consider them just one step above a suggestion box. They have no teeth. The first knowledge the managements have is when there is a strike.

"Our investigations reveal the grievances and the ringleaders and we have managed to pre-empt some of the strikes.

"In other cases managements have refused to accept our assessment and then been hit with a strike.

"Once there is a strike or other labour unrest unions move in and take over. Managements have been forced to accept these unions to break the strikes, but often these unions are not too concerned about the workers. They are after political

power — and they want the grievances to continue.

"We bring the grievances, both genuine and imaginary, to managements."

Mr Griffiths said his company's recommendations were always to solve the grievances.

"Sometimes managements have promoted the trouble makers or transferred them, but that does not solve the problem.

"The workers at one company demanded an increase of R2 an hour, but they settled for an increase of only 7c an hour just so the union could be recognised."

Mr Griffiths said that industries which employed more than 100 blacks were the most susceptible.

One large company which employs more than 2 000 blacks did not accept his assessment from his "spies" of what was going to happen, "because the grievances had

not been raised through the workers' council."

He said he had infiltrated three men into the company and two of them had made reports to him which indicated that there were troublemakers pushing for a strike.

"There was a strike as forecast, and the management lost the initiative."

Mr Griffiths said "managements must treat staff in a responsible way and find out the causes of their grievances.

He said that half the time his sympathies lay with the workers. Often managements didn't go into workers' grievances in depth.

"Both managements and labour in South Africa are inexperienced in dealing with each other. They do not have the experience of other Western nations.

"Even genuine unions have been manipulated by subversives for their own ends."

Mr Griffiths said that managements often underestimated the sophistication of their workers.

"In one case the workers had stolen a manual from management which laid down the procedure they would adopt in strikes, so the workers anticipated every move."

Archie Griffiths says managements must tackle workers' grievances effectively or they will have serious problems which could be exploited by outsiders. His spies have pinpointed problems

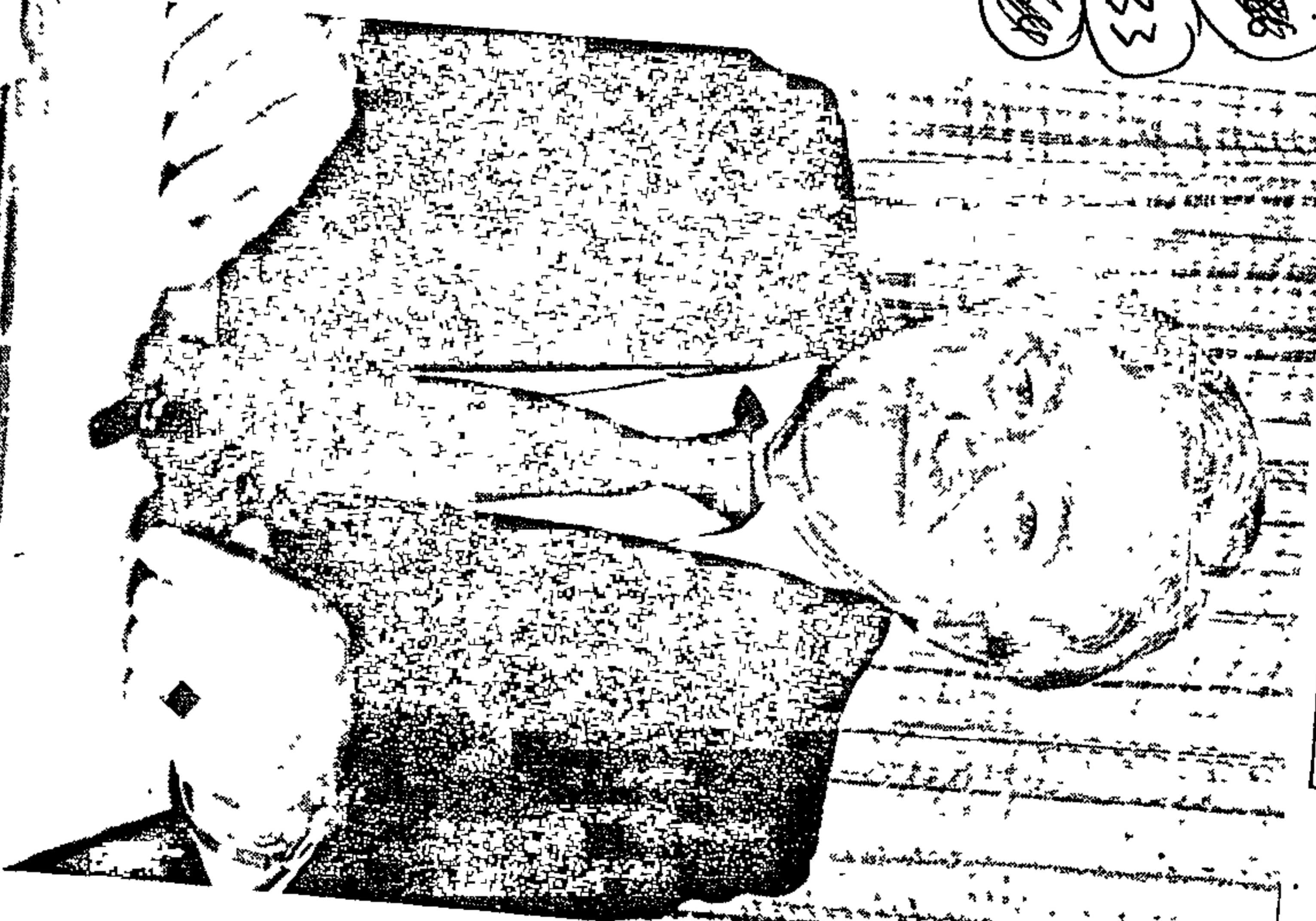

Archie Griffiths says managements must tackle workers' grievances effectively or they will have serious problems which could be exploited by outsiders. His spies have pinpointed problems

Fresh bid to resolve wage talks deadlock

By STEVEN FRIEDMAN
Labour Correspondent

EMPLOYERS and delegates of registered unions in the giant metal industries meet today in a fresh attempt to resolve the deadlock in wage talks — covering nearly 500 000 workers — but industry men do not expect a settlement

The unions have declared a dispute with employers, which means they can hold a legal strike ballot if the deadlock is not broken by the end of June

The deadlock — which has delayed a wage agreement in the industries — has also led to strikes by black metal workers on the East Rand

Some sources believe employers, represented by the Steel and Engineering Industries Federation, may increase their last offer at today's meeting

But industry sources said yesterday it was likely the parties would be deadlocked again. Registered unions met yesterday and decided they were not prepared to accept the present offer

At the last negotiating meeting, employers offered a 14%-22% increase on minimum wages together with a 25c an hour guaranteed increase for all workers

Unions rejected this, arguing that the rise in minimum pay would not raise the pay of skilled workers, who earn far above minimum rates

They added that the guaranteed increase would only raise skilled pay by between 3% and 6%

They also said the increase, which would raise minimum pay for unskilled black workers to R1,38 an hour, would not quell growing wage unrest among blacks

The unions have demanded a 20% increase for artisans and a minimum rate for unskilled workers of R1,75 an hour

Employer sources on the East Rand have suggested over the past week that Seifsa may be willing to increase its offer in order to achieve a settlement

There is support for this among some East Rand firms whose workers have struck, saying they cannot wait for the council negotiations to end

Chemical & Chemical Products, Coal, Rubber & Plastic Products

Black Allied Workers Union

Cape Explosives Industrial Workers Union

Chemical and Allied Workers Union

Chemical Workers Industrial Union

Chemical Workers Union

Durban Rubber Industrial Union

Engineering and Allied Workers Union

Engineering Industrial Workers Union of S.A.

Federated Mining, Explosives and Chemical Employees Union

Industrial Salariat Staff Association

General Workers Union

Metal and Allied Workers Union

National Union of Engineering, Industrial & Allied Workers

National Union of Motor Assembly & Rubber Workers of South Africa

S.A. Chemical Workers Union

South African Allied Workers Union (SAAWU)

Steel, Engineering and Allied Workers Union

Umbogintwini Industrial Workers Union

Weskapse Plofstof & Chemiese Operateursvakbond

Non-Metallic Mineral Products

Building, Construction and Allied Workers Union

Glass & Allied Workers Union

Glass Workers Union

National Cement Employees Union

National Union of Brick and Allied Workers

Transport & General Workers Union

Base M

Machin

Amalgam

Amalgam

Black

Electr

Electr

Engne

Engne

Genera

Genera

Iron M

Metal

Motor

Motor

Motor

Nation

Nation

Radio

S.A. E

S.A. E

S.A. I

S.A. L

South

Steel,

Trans

United African Motor and Allied Workers Union

(133)

508

S

S

RDM
12/5/62
151 133

New hopes for metal industry wage deadlock

Labour Correspondent

HOPES for a settlement of the wage dispute in the giant metal industries rose sharply yesterday as employers and registered unions agreed to resume full negotiations on Monday

And union sources said employers had indicated they could make a new wage offer when the talks resume

The talks broke down early last month, and registered unions on the metal industries' industrial council declared a dispute with employers, represented by the Steel and Engineering Industries Federation

This would allow them to hold a legal strike ballot if the dispute were not settled by the end of June

The council agreement sets minimum pay and work conditions for nearly 500 000 workers of all races

Yesterday the council's executive met to discuss the dispute in terms of a dispute procedure

A statement issued after the meeting said the two sides had agreed to return to the negotiating table

A meeting of the full council, comprising full delegations from Seifsa and the unions, would be held on Monday

It said both sides agreed "that the best course of

action would be for the parties to return to the negotiating table at the earliest possible opportunity

"Both sides agreed that the full negotiating body the national industrial council, be reconvened on Monday in a further attempt to reach agreement

"The prompt reconvening of the council indicates the desire of the parties to resolve the dispute through the negotiating procedures of the council," the statement said

Union sources said Seifsa had not made any new wage proposals yesterday, but would give unions its new proposals on Monday morning

"There was a definite change in the atmosphere of the meeting I believe we could settle the dispute on Monday," a source said

The delay in finalising a new wage award has prompted some strikes by black workers on the East Rand

Unions declared the dispute after rejecting a Seifsa offer of guaranteed increases of 25c an hour for all workers and rises in minimum rates of 14%-22%

They have said this offer is "unacceptable" and that it is up to employers to change their offer if the deadlock is to be broken

FCI urges employers and unions to negotiate

1978 and with

133

MM

12/5/82

1974 affiliated to other unions form

By STEVEN FRIEDMAN
Labour Correspondent

THE influential Federated Chamber of Industries (FCI) has backed the official industrial council system — but adds that direct bargaining between unions and individual employers in the factories should be encouraged.

Bargaining systems should not be imposed on either unions or employers but must be worked out by agreement, says the FCI

Despite its support for councils, the FCI's views conflict with those of powerful employer associations who have rejected direct bargaining between employers and unions on the factory floor

The FCI's views on collective bargaining are contained in its submissions to the Government's National Manpower Commission, which is investigating key elements of the country's official bargaining system

It says the council system has advantageous methods of monitoring agreements to ensure they are implemented, and of settling disputes

The system's chief disadvantage was that black workers had been excluded from it and therefore distrusted council decisions which had been taken without their "knowledge and participation"

The FCI adds that it is a

misconception to believe councils must only bargain at the industry level

The system was "as flexible as the parties wish to make it"

This implies that councils could allow direct bargaining in the factories — the demand of most emerging, mainly black, unions

The FCI adds, however, that a bargaining framework "cannot be imposed on either party and both parties must agree to the choice of bargaining systems"

It adds "In the present transitional phase of industrial relations, the role of decentralised bargaining should not be underestimated and the Chamber is of the opinion that it should in fact be encouraged"

In the present "transitional period relatively sophisticated and unsophisticated systems will continue alongside each other". It should be left to time to develop the best system

The ultimate goal was a unified bargaining system in which bargaining would take place mainly at industrial councils, "albeit in a modified form"

The FCI also backs factory works councils, which have been opposed by emerging unions

But it stresses that these councils must not be seen as possible substitutes for unions

Report 1980/81
Fosatu Annual

Year	Membership		
	African	Asian and Coloured	White
1980			460
1979			445
1978			..
1977			377
1976			222
1975			331
1974			322
1973			418
1972			
1971			
1970			
			Total

Registration:
Founded: 1939
Area of Operati
Officials: Sec
8001
Cape
Corpc
Address: 201/
201/

INDUSTRIAL RELATIONS

FCI proposals

FM 14/5/82

132
133

The National Manpower Commission (NMC) should investigate the collective bargaining process in its entirety, largely because "in the present transitory period relatively sophisticated and unsophisticated systems will continue to exist alongside each other"

This is at the heart of important proposals on industrial bargaining submitted to the NMC by the Federated Chamber of Industries (FCI). The NMC is investigating SA's official industrial bargaining system at a time when widespread labour unrest has caused serious concern among employers (*Currents* May 7 1982)

The FCI recommends an essentially fluid, pragmatic approach to the vexed issue of employer-employee bargaining. No particular system should be favoured above any other. Rather, the different systems must be allowed to grow and develop into a sophisticated one.

Ideally, says the FCI, "all unions (and all employer parties) representative of the bargaining unit, should participate in a common bargaining forum such as provided by an industrial council (IC)". The IC system provides a "framework for bargaining" and a forum for developing a neces-

sary degree of mutual trust

Importantly, though, the Chamber says that a bargaining framework cannot be imposed on either party and both "must agree to the choice of bargaining systems". In the present transitional phase of industrial relations in SA "the role of decentralised collective bargaining should not be underestimated and the Chamber is of the opinion that it should in fact be encouraged"

Decentralised, or non-formal, collective bargaining says the FCI, "is the only method open to unorganised industries but can also be used effectively by organised industries, especially as an educational and training device for Blacks who have not been part of the formal system until very recently"

The FCI regards the statutorily recognised system of works councils as one that "could play an important role in the evolutionary development of the collective bargaining system". But works councils should be seen as forums for communication and consultation on domestic matters of mutual interest, not as institutions for collective bargaining. In the current industrial relations scene, the FCI favours the present legislative arrangement which enables wide scope to institutionalise and regulate works councils "as the parties wish"

The Chamber urges, however, that government support for works councils be spelt out as a "non-competitive system of bargaining between trade unions and employers" in the preamble to the Labour Relations Amendment Act. "Works councils should not be seen to be regarded by government as possible substitutes for trade unions"

The Chamber feels that in a country where most workers have little or no experience of collective bargaining, works councils should not be regarded as substitutes for trade unions, but as complementary to the development of an organised labour movement.

Although it considers the registration of unions by the State to be desirable, the FCI feels that this should not be left to the discretion of government officials. Instead registration "should be structured in a way that is broadly similar to the registration of companies". Registration is in many quarters considered to be a non-issue, however, especially if collective bargaining is developed into a professional, rational instrument.

133 (133) (146) 2011 19/5/82

Assocom call on strikes

Labour Correspondent

THE Association of Chambers of Commerce (Assocom) says the right of workers to strike should be recognised by the Government and that all laws which make it a crime to strike should be scrapped

The same should apply, it says, to lock-outs by employers and it should be left to management and workers only to agree on when strikes or lock-outs may occur

This call is contained in Assocom's submissions to the Government's National Manpower Commission, which were released yesterday. The NMC is investigating key aspects of the country's official labour system

Assocom also suggests that all labour laws should be "enabling" (voluntary) only and that no labour law should be introduced which does not

have the support of both employers and workers

Referring to legal penalties for striking, Assocom says "It is appreciated that no right (to strike or lock-out) exists in South African law at present and such activities should be decriminalised"

This, it says, would enable management and workers to negotiate conditions under which strikes or lock-outs can occur

Such agreements should spell out some "regulatory measure before strikes or lock-outs can be accepted"

In its submissions on bargaining, Assocom notes that established unions have tended to bargain with employers at industry level. This meant they were usually "organisationally weak" on the factory floor

But emergent, mainly black unions had sought to

concentrate on the shop floor "where they are particularly strong and well organised"

This meant that two bargaining systems were emerging and that the future development of bargaining would be from the bottom up

However, Assocom did not believe the industrial council system "is necessarily breaking up or doomed"

Although it believed that industry-wide negotiations should predominate, the two levels of bargaining should "complement" each other "and neither should be seen as a substitute for the other"

"It cannot be stressed sufficiently strongly that the views of Assocom are that legislation must be purely enabling and that no law must be introduced with regard to labour legislation unless it has the support of both parties"

Metal unions push for separate talks

By STEVEN FRIEDMAN
Labour Correspondent

THIS year's Industrial Council pay negotiations in the metal industries — which ended yesterday — will be the last in their present form if metal unions have their way

Unions on the council, as well as those who have not joined it, have made proposals for far-reaching decentralisation of the negotiations, which affect pay and work conditions for nearly half a million workers of all races

And established union sources say this year's negotiations have made them determined that "this will be the last time we negotiate in this way — the council will have to be split into smaller units to stay manageable"

At present, metal unions negotiate on pay with the Steel and Engineering Industries Federation, which re-

presents dozens of metal employer associations

Unions on the council have proposed to Seifsa that the council be split into various 'sectoral' councils. This would mean negotiations in the industries in which Seifsa members are active would be held separately

This is a repetition of suggestions made by these unions in the 70s. But unionists insist that this split-up is now "imperative"

During the bargaining which has just ended, they say, a settlement was held up because some sectors of the industry could afford to meet union demands while others could not

At the same time, unions who have not joined the council have been holding talks with Seifsa. These unions favour plant-level negotiations, but have made various other suggestions for decentralising bargaining

Seifsa's director, Mr Sam

van Collier yesterday confirmed that unions had made proposals for decentralising bargaining. Seifsa had also, he said, completed its first round of talks with most unions not on the council

Meanwhile, it was learned yesterday that some employers in the industries are concerned because wage increases granted before Monday may not be offset against the guaranteed minimum increase of 30c an hour negotiated yesterday

Metal industry sources said employers who had granted increases before Monday and wanted to deduct these from the agreed rise would have to apply for an exemption. But their workers would have to have agreed to offsetting when the rise was granted, they said

Some employers are expected to grant increases now and offset these against the agreed rise, which comes into effect on July 1

Handwritten notes: 277, 133, 9/5/82, and other scribbles.

Big firms 'plotting' against workers

By Drew Forrest

Employers in the mining and metal industries are working together to undermine established trade unions for skilled workers, a leading registered trade unionist claims

To "prepare the battlefield in their favour" the employers are seeking to buy off unskilled and semi-skilled workers, says the general secretary of the SA Electrical Workers Association, Mr Ben Nicholson.

Writing in the union's journal, Power, Mr Nicholson said this year's wage negotiations in the metal and mining industries had indicated a great degree of collusion between the two sets of employers

"This is hardly surprising, since the tentacles of the octopuses which some giant corporations have become stretch into all sections of the economy," he said.

Wage talks in the metal industries had shown that employers were no longer concerned with meeting the demands of skilled workers, Mr Nicholson said. Instead, they were prepared to go to maximum lengths to appease demands made by those claiming to represent unskilled employees

In an agreement reached this week, metal employers granted minimum wage increases ranging from 16 percent for artisans to 26,5 percent for unskilled workers

In the mining industry, where the Chamber of Mines and artisan unions are in dispute over wages, Mr Nicholson predicted that unskilled workers would be made a similar offer to that made to their metal industry counterparts

His allegations were denied by the director of the Steel and Engineering Industries Federation, Mr Sam van Coller, and a spokesman for the Chamber of Mines

"We greatly value our relationship with the established unions," Mr van Coller said.

The preparation of the employers' offer in the metal industries' wage talks was a "participative exercise," involving many employers, and thus precluded collusion of the kind alleged

able Red or green ink may be used only for underlining, emphasis or for diagrams, for which pencil may also be used

- 3 Names must be printed on each separate sheet (e.g. graph paper) where sheets additional to examination book(s) are used
- 4 Do not write in the left hand margin

Any dishonesty will render the candidate liable to disqualification and to possible exclusion from the University

WN
300K

EVERY CANDIDATE MUST enter in column (1) the number of each question answered (in the order in which it has been answered), leave columns (2) and (3) blank

	Internal	External
(1)	(2)	(3)
7(b)	18 = 72	
Examiners' Initials		

Paper)

Paper)

WARNING

- 1 No books, notes, pieces of paper or other material may be brought into the examination room unless candidates are so instructed
- 2 Candidates are not to communicate with other candidates or with any person except the invigilator
- 3 No part of an answer book is to be torn out
- 4 All answer books must be handed to the commissioner or to an invigilator before leaving the examination

Voice of the worker 'not heard'

ARGUS 28/5/81 (133)

Labour Reporter
 The present industrial council system was not in substance a democratic one because it did not allow for rank and file participation of workers. Mr David Lewis, general secretary of the General Workers Union said yesterday.
 Mr Lewis was speaking in a panel discussion on 'Collective Bargaining - Which System?' organised by the Institute of Personnel Management. Also on the panel were Mr Jack Roos, director of the Cape Chamber of Industries and Mrs Kate Jowell, assistant director of the Graduate School of Business at UCT and a mem-

ber of the National Manpower Commission.
 "The industrial council system has established a set of practices over the past 60 years which do not allow rank and file participation. If the workers are to control the union they must also have control over negotiation," said Mr Lewis.
 Referring to the spate of strikes on the East Rand in the steel and engineering industry, he said the reason was that the voice of the ordinary worker was not heard on the industrial council.
 "With in-plant bargaining employers have a reasonably good assurance that the agreement

reached between them and the workers will be adhered to," he added.
 Mr Roos said industrial councils if they included all workers, could be an instrument for stability and advancement on the labour sphere. Where industrial council agreements existed they tended to improve the lot of the worker, he added.
 Referring to in-plant bargaining Mr Roos said he had no difficulty supporting it where no industrial council existed but it was "hardly fair

to expect an employer to submit to two levels of collective bargaining".
 Summing up, Mrs Jowell said plant level links were important to the stability of an industry. She said there was a particular danger in South Africa that industrial councils are barely representative of the employers or white and coloured workers who created them, let alone the millions of black workers who have had no part in their deliberations.

Founded: 1973

Area of Operation: Transvaal, Natal, Eastern Cape

Officials: Secretary: D. Sibabi

4001

Durban

Address: 1 Central Court
 125 Gale Street

Telephone: (031) 69215

Report Nov. 1980/81
 Fosatu Annual

Year	Membership			Total
	African	Asian and Coloured	White	
1980				8 400
1979				..
1978				..
1977	7 000			7 000 *
1976	6 700			6 700 *
1975	3 900			3 900 *
1974	3 900			3 900 +
1973				
1972				
1971				
1970				

METAL AND ALLIED WORKERS UNION

Industrial body 'obstacle to democracy'

133
Cape Times
3/5/82

Staff Reporter

THE Industrial Council (IC) was the parliament of industry, Mr Jack Roos, director of the Cape Chamber of Industries, said in a discussion on the IC system hosted by the Institute of Personnel Management last week.

But Mr David Lewis, general secretary of the General Workers' Union, said the IC was a serious obstacle to democracy, whereas in-plant negotiations fostered a leadership of rank-and-file working class people.

In support of the system, Mr Roos said the IC was a well-tryed and orderly system which should not be undermined by limited, short-term demands.

"The most undesirable aspect of the IC — the exclusion of blacks — has been eliminated.

Legislation

"Once an IC agreement is made, it carries the full weight of legislation and can be enforced.

"Wage rates on the whole are substantially higher in industries governed by IC agreements than those that are not.

"While ICs do contain certain limitations and adaptations are necessary in a rapidly-changing situation, it is no use throwing the baby out with the bath water.

"A two-tier system in which collective bargaining operates both at the level of the IC and the

shopfloor is unfair to the employer, who then has to conduct two sets of negotiations."

Mr Lewis said the IC was "a large bureaucratic machinery operated by a few skilled experts."

"By entering ICs we would be diluting our power. At the shopfloor level employers understand clearly what the consequences would be if no agreement is reached, but in an IC situation, the unions don't carry nearly as much clout.

Not representative

"The ICs are not representative. How can we sign an agreement on behalf of 500 000 workers when we only represent 20 000?"

"One of our biggest objections would be sitting at the same side of the table of unions who are considerably more antagonistic towards us than some employers.

"The IC suffers from a lack of credibility among workers and is seen as a tool of the bosses.

"It sets an artificially low rate of pay which is set by the lowest common denominator — the most insubstantial firms.

"We are not opposed to multi-plant bargaining, but we set three conditions. The rank-and-file must express themselves, the companies must be logically grouped together and the unions must be speaking on behalf of their members.

Anglo's Relly 'a Humanitarian'

ARGUS 3/6/82
133

Argus Correspondent

JOHANNESBURG — Mr Gavin Relly, who is to become the new man at the helm of the vast Anglo American Corporation, is regarded as much as a mining and industrial magnate

He is a humanitarian who holds firm and usually vigorously expressed views but his broad outlook keeps him free of rigid formula or doctrine

Mr Gavin Relly

responsibility and the wider issues facing South Africa on local and overseas platforms

He told a recent London conference that those involved in South Africa undergo emotions of rage, triumphs, despair and sheer excitement over quite short periods of time

DULL LIVES

"One might argue, therefore, that being involved in South Africa will lead to a short but spicy life," he said.

"But who is to say that this is less desirable than long and dull lives endured in other parts"

Mr Relly's life has certainly not been dull or undemanding.

Born in Cape Town in 1926 and educated at Diocesan College and at Trinity College, Oxford, he joined Anglo American in 1949 and was private secretary to Mr Harry Oppenheimer and Sir Ernest Oppenheimer.

Later he gained experience in all the important

aspects of the business of the corporation.

He was leader of the team whose work in the early sixties paved the way for the entry of the group into local steel and vanadium production

He identified himself completely with the project and as colleagues said, "he travelled the world, living and talking steel and vanadium"

Crucial in shaping his outlook was his later direction of the group's large copper interests in

Zambia during the years of political and social change there after independence

RESPONSIBILITY

Some observers believe that his work in the '60s was part of a preparation for his increasing involvement in the wider international aspects of group business and in handling the complications of differing national considerations

Elected to the board of Anglo in April 1965, he was appointed a deputy

chairman in May 1977 and succeeded Mr Oppenheimer as chairman of the executive committee of the Anglo Board in November 1978

Mr Relly is not only much concerned about the people who work with him but sees social responsibility as meaning that a corporation "voluntarily expends its resources to do something not required by law and without immediate economic benefits"

NEWS

Big shake up for Naamsa

133

Industrial Week
8/6/82

Special Correspondent

THE National Association of Automobile Manufacturers of SA (Naamsa), the official representative body of the vehicle manufacturing sector, has restructured itself to play a more dynamic role in industrial affairs

For some time the motor industry has been split by a number of independent lobbies which, although paying lip service to the unifying aims of Naamsa, have effectively made it impossible for the organisation to bring about meaningful changes with the Government

This is expected to change now that three distinct operating divisions have been established to look after passenger cars, light commercials, and heavy commercials

Each division has its own president who also sits on the executive committee with Naamsa's president and vice president

Executive director

This development coincides with a move of offices from Port Elizabeth to Pretoria, and the appointment of a new ex-

ecutive director Nico Vermeulen

Retiring director, Frank Lock, takes up an appointment as consultant to Naamsa in August

It was also originally intended that statistics relating to industry vehicle sales would be prepared by the CSIR Vehicle Data Bureau (VDB), a move which has been deferred until the VDB is able to obtain computerised information from all provinces

The new-look Naamsa will need to unify the industry's approach to labour relations and local content

These have become a controlling influence and it has long been felt that Naamsa, first formed in 1935, has failed to keep pace with the industry's needs

Local content

Local content in particular is a bone of contention. In the absence of a unified approach, individual manufacturers have sought concessions from the Government that have often been counterproductive

When local content was introduced in 1962 there was virtually no manufacturing

Phase two, in 1964, started a six year programme of local component supply and, by 1973, the industry was producing 200 000 passenger cars worth R400-million (300 000 to day, worth R2 200 million)

The industry was still divided on local content when the Government proposed a 70% level by 1976

Naamsa suggested 60%, which the Government turned down flat. A compromise was reached on 66% which has become increasingly costly and difficult to meet

In labour affairs, Naamsa set up the Automobile Manufacturers Employers' Organisation (AMEO), which has virtually fallen dormant in recent years

The Industrial Council in the eastern Cape still represents the only organised labour body for the manufacturing sector, and may soon be joined by a new Regional Council for the Transvaal

AMEO revitalised

AMEO has been revitalised to handle this development and talks between Transvaal manufacturers are in progress. The new council should be formed within the next two years

Warning on effects if union is ignored

10/6/82

WASA

133

E. Post

DWB

By SANDRA SMITH

THE Midland Chamber of Industries and an industrial relations expert have warned of possible serious economic consequences if the South African Transport Services continues to refuse to recognise the General Workers' Union (GWU)

The GWU has attempted unsuccessfully to arrange a meeting with SATS management, which has moved from a position of refusing to deal with an unregistered union to saying the GWU is not sufficiently representative

GWU general secretary Mr Dave Lewis said the union had more than 1 000 members on the Port Elizabeth and East London docks

He said the GWU was not asking for the right to negotiate national conditions for dock workers but to negotiate in respect of local matters in the Port Elizabeth and East London docks

The executive director of the Midland Chamber of Industries, Mr Brian Mathew, said today the chamber was seriously concerned, as any disruption of "our supply lines" would affect industry in the area

"We are hopeful the matter will be amicably resolved to the benefit of all concerned," he said

Ford's director of industrial relations, Mr Fred

Ferreira, said it would be a pity if the SATS management were "to continue to underestimate the seriousness of the situation developing in this area — particularly in the light of potential international ramifications"

"It seems totally senseless for an impasse to develop when the issues involved appear to be essentially questions of principle which are totally consistent with current perspectives on labour relations in South Africa," he said

"One hopes that this is not another case of different Government departments each going off in their own direction"

The country could not afford to have its harbour activities crippled through potential strike action and the SATS ought therefore, at least, to show a willingness to discuss the issues involved, he said

In an open letter to the SATS general manager, Dr Kobus Loubser, this month, the GWU said its members had met with "an extraordinarily brutal response" from the SATS and Railway Police in their activities

The union warned of the possibility of bloodshed if the dispute led to open conflict. Overseas transport unions have shown an interest in the dispute, and the International Transport Workers Federation has promised its support

(220) (12/15) (62) 204 12/6/82

SATS peace bid by Ford man

(133) Labour Correspondent

IN AN unprecedented move, Ford's industrial relations director in Port Elizabeth has asked SA Transport Services to hold talks with the General Workers Union which is demanding recognition from SATS at two East Cape ports

Mr Ferreira said yesterday he did not ordinarily comment on "the problems of other employers", but was doing so now because the dispute was "of national importance"

He said it would be "a pity if SATS were to continue to underestimate the seriousness of the situation, particularly in the light of the international ramifications"

The Midland Chamber of Industries, which represents industrialists in the Port Elizabeth area, has also publicly expressed concern about the dispute

And in a reaction to their statements, the assistant general manager (staff) of SATS, Dr

Anton Moolman, flew to Port Elizabeth on Friday to talk to Mr Ferreira and the Midland Chamber

Although Mr Ferreira would not comment on the visit, an SATS spokesman confirmed that Dr Moolman visited Port Elizabeth on Thursday. He said he did not know who Dr Moolman had seen or what they had discussed

The GWU claims majority membership among SATS workers at Port Elizabeth and East London docks, but SATS refuses to deal with it. There are fears the dispute could spark a confrontation with local stevedores and sympathy action by dockers at foreign ports

Mr Ferreira said it seemed "totally senseless for an impasse to develop when the issues involved appear to be essentially questions of principle which are totally consistent with current perspectives on labour relations in South Africa"

Shoe industry 'on the line' — MCI chief

Business Editor

THE footwear and other industries were standing on the dividing line between the past and the future of South African labour relations, the president of the Midland Chamber of Industries, Mr Peter van der Merwe, said at the annual dinner of the Footwear Manufacturers Federation in Port Elizabeth

"When our Government created legislation to give effect to the recommendations of the Wiehahn Commission, it released forces that are bringing about a new industrial relations environment — one that will contain a number of areas where the workers themselves will become an ever-increasing reality in business," he said

"A leading force in this changing environment is the role being played by the emergent black trade unions"

He said there would be emphasis on change and social reform and, because black workers would be a leading force in the clamour for change, management and employers would have to manage the bulk of the adjustments that brought change

Mr Van der Merwe said managers must ask themselves if they knew what their workers' perception of the management role was, and if the workforce knew what the management expected from it

"Management always has a problem in managing

effectively when it is unable to predict events or behaviour with any measure of certainty," he said

"This will be particularly true if it is unaware of its workers' attitudes on such issues as punctuality, overtime and productivity

"Attitudes are directly linked to a society's system of values

"What I am trying to convey is that if the value systems of management are the opposite of the values adopted by its workers, there will be a conflict of interests which could lead to confrontation and work stoppages

"For instance, management may have the rewarding of shareholders as a major item in its value system

"If the workers do not hold that item in their set of values, then the need for a return on capital will not be accepted as an argument for greater productivity

"It is a matter of urgency that you and your workers establish a common value system over a wide variety of subjects, so that when you talk to each other you know each other's norms that form the basis for the decisions to be taken," said Mr Van der Merwe

He added that managers also had to understand the Press, and that it was no use saying "No comment" when approached, because managers had to realise they were not living in isolation

30

40

10

Cool it call from a captain

133

ROOM
16/6/82

Its June 16 today, the day marking the nation-wide unrest which began in Soweto in 1976. JOHN RYAN speaks to the former Springbok cricket captain, Peter van der Merwe, who finds himself in a particularly hot seat — and issues to industry, the unions and the police an impassioned plea for restraint.

the local tariff the lowest in the country — along with the Eastern Transvaal's — and certain cash grants to industrialists from tax savings on training schemes. These followed an economic survey by the Midlands Chamber helped initiate

"The whole objective of punting for these concessions," says Van der Merwe, "was to make it more attractive to investors to locate industry in this area

"The unions also have a responsibility to ensure that industry develops here so that additional job opportunities are generated. Management and worker representatives need to co-operate on this particularly when it comes to wildcat strikes"

Asked to explain the timing of his appeal, Van der Merwe says carefully "It's a

case of not wishing always to be reacting to a situation. We would rather state where we stand before things happen"

What sort of things? "It doesn't matter. It can be detentions, it can be June 16 (demonstrations), it can be all sorts of things

"Also, it's the situation as we see the unions in relation to the unemployment situation. It's not just industry and commerce which have to create jobs. It's a combination of industry, commerce and labour"

Pressed on the point, Van der Merwe says "Look, we would say (to the unions) we can do all we can to create jobs. But unless you act in a responsible way you're not going to land that extra company here"

He admits he is concerned that the Eastern Cape seems to have gained the image of being the industrial area with the most worker unrest. "The fact is that investors shy away from areas where there is a high potential for frequent labour unrest"

There is also a need to guard against the danger of existing industries moving out or taking their expansion plans to other areas where there are concessions but less risk of work stoppages through union action

His appeal, Van der Merwe emphasises, should in no way suggest that he and his organisation are not sympathetic to "the emotions" of June 16 — "though, frankly, we have so many emotive days in our history that it might be a good idea to scrap them all and start again"

Does he have any appeal to make to the police over June 16? "Yes," he says at once, "I would ask them to show as much constraint as possible during the period and be as open as they possibly can be about why they take action against people"

Is his chamber concerned about the number of black trade union leaders who have been detained without trial?

"Industry has difficulty with detention without trial irrespective of who it is, because we believe in a system of free enterprise and an

integral part of that system is that a person is innocent until proved guilty in a court of law

"Detention without trial cuts across one of the basic principles, the right of every citizen to be tried in court"

"At this time, industry is in the centre of the changes that are taking place with the emergence of black trade unions and we have all seen the difficulty that industry has had with work stoppages

"In other words, the labour force is extremely volatile and when a trade union leader is detained then this becomes even more sensitive"

Van der Merwe adds "The problem is that industry is not in a position to judge whether the detained person is being held because of his activities as a trade union leader or for some subversive activity not related to normal trade union work, but we feel the reaction through worker attitudes

"Workers simply see it as a trade union leader being held, irrespective of the reason, and this makes it very difficult to negotiate any genuine labour issue in such a strained climate

"We believe it would do both the authorities and industry a great deal of good if these people were charged in court. Everyone would then know exactly in what area they had been infringing the law. All doubt would then be removed"

Sixteen years on, the earnest young parson look has not left Van der Merwe. In fact, he has worn considerably better than most of his peers. The skipper who led the Springboks to historic victories on the 1965 short tour of England and in the 1966-67 series here against Bobby Simpson's Australians appears as tautly fit as in his prime

The clerical forehead creases and lean fingers flex with impatient energy as he considers a question about unemployment, high and growing in the Eastern Cape with the downturn of the economy. Will it pose special problems for worker-employer relations?

Van der Merwe says "I see the whole question of job security as an issue that will feature more and more in negotiations between employers and workers — particularly in this area where we are very susceptible to the ups and downs of the business cycle"

He adds "Industry is very concerned about unemployment and the hardship that it causes and the situation will be aggravated as companies retrench workers in line with the slackening in demand for their products

"Industry is very conscious of this hardship but it has a responsibility to its entire workforce which greatly exceeds (the responsibility for) those being retrenched"

He cites British Leyland in Britain as a prime example of what can happen to a company if it doesn't base its decisions on sound financial facts. The firm resisted moves to modernise its production process in an attempt to retain as many workers as possible

"The result was that it continually lost its market share and, in the end, had to close plants and make mass dismissals to get itself back into a competitive position where the British people would once

Ex-Bok captain Peter van der Merwe sits in an Eastern Cape hot seat

more buy its cars in preference to imported models

"To sell cars our three — Ford, GM and VW — must be competitive in the market place. This area has shown a declining percentage of the market over many years"

A view strongly held by some trade union leaders is that unemployment may be alleviated if companies cut working hours to help create jobs. This is a myth, Van der Merwe suggests

He refers to a survey carried out in France among 30 firms which had substantially reduced working hours by more than two hours a week. In all cases the number of new jobs created was negligible — barely 0.2% of the overall work force

In the end, he stresses, "it is management's responsibility to ensure the long-term viability of the company which, in essence, is for the ultimate good of all its employees"

Does he read much hope into the fact that Louis Rive will be coming down to trouble-shoot the problems of the Eastern Cape?

"Well, he's a man of stature, isn't he? So presumably he has the ear of Government. And for a man of stature to be more aware than he was before of our problems must be something worthwhile

"But whether Mr Rive is actually going to get something done I don't know. He seems to have had a pretty tough path to tread in Soweto. What perhaps is disappointing is that the authorities have to send in people to have a look at an area

they are supposedly governing when they are not prepared to accept the statements of those who are actually living in the area."

Is he despondent about the prospects for improvements in the Eastern Cape situation?

"No, I don't think so," says Van der Merwe contemplatively. "We have forces which are causing things but the basic industry, or the nub of it, is still sound. And I think the people in Port Elizabeth are aware of the situation within the South African economy far more than they used to be and, because they are aware, the problem is that much closer to solution"

The final and inevitable question. Does Van der Merwe think his experience as a Springbok captain has done anything to equip him for his present position? The answer comes slowly, through tented fingertips

"I think so," he says. "I was in an extraordinarily good position to make decisions because I wasn't the best player on the field. If you're in the side for your batting or bowling, you have a vested interest in making runs or taking wickets and to hell with anything else, type of thing I obviously had to do something" — with a laugh — "and it was making the decisions"

"I think any situation of authority must accustom you to other authority," Van der Merwe adds. "And, of course, you do (as a Springbok captain) get to meet a lot of people. And people are what we are talking about"

Indeed

^{E. Post}
**Official
has talks
in PE
on union
issue**

14/6/82
133
THE assistant general manager (staff) of the South African Transport Services (SATS), Dr Anton Moolman, came to Port Elizabeth last week for talks after warnings of possible economic disruption if recognition for the General Workers' Union (GWU) was refused.

His visit was confirmed today by the SATS manager of public relations, Mr M P van der Berg, who said Dr Moolman's visit "was not entirely connected with the GWU issue".

Mr Fred Ferreira, Ford's director of industrial relations, confirmed today he had met with Dr Moolman. However, it could not be confirmed that Dr Moolman also had discussions with Mr Brian Matthew, executive director of the Midland Chamber of Industries.

Last Thursday Mr Matthew said the chamber was seriously concerned about the SATS refusal to recognise the GWU as any disruption of "our supply lines" would affect industry.

Mr Ferreira said then that the country could not afford to have its harbour activities crippled through potential strike action and the SATS ought therefore, at least, to show a willingness to discuss the issues involved.

Stevedores' union given all ports OK

By STEVEN FRIEDMAN
Labour Correspondent

THE unregistered General Workers Union (GWU) yesterday became the recognised representative of stevedores at all four of the country's major ports after an historic agreement was signed in Durban between it and stevedoring employers

The recognition agreement, announced yesterday by the GWU and the SA Stevedoring Employers Association (SASEA), grants a stevedores' committee elected under GWU auspices full bargaining rights at Durban harbour — the country's biggest port

The union is already recognised at Cape Town, Port Elizabeth and East London docks

And a union spokesman said yesterday discussions aimed at introducing industry-wide bargaining on certain issues were under way — a move which could produce the country's first industry-wide bargaining arrangement outside the official industrial council system

A joint statement by the GWU and SASEA said the agreement had been signed between a GWU committee representing more than 2 000 Durban stevedores and their employers, the SA Stevedores Services Company and Remies-Grindrod Cotts Stevedoring

The agreement is "substantially similar" to those reached in the other three ports. It gives the committee "full rights of negotiation and incorporates a mutually-agreed disputes procedure", the statement said

"The Durban agreement effectively means that GWU committees are now recognised on the four major ports and as such represent the overwhelming majority of workers employed in the stevedoring industry," it added

"The relationship between stevedores and management in Cape Town, Port Elizabeth and East London has been productive and harmonious and has secured more than two years of uninterrupted industrial peace in the three Cape ports

"SASEA and the GWU are confident similar harmony will prevail in the Durban docks," the joint statement said

The series of agreements in the four major harbours mean that stevedores' wages and work conditions are now covered by the most wide-ranging bargaining agreement in any industry outside the official system

At present, negotiations take place separately at each port and this will continue to be the case, according to a union spokesman

But he added that memoranda had been exchanged between SASEA and the GWU aimed at producing industry-wide bargaining at the four ports

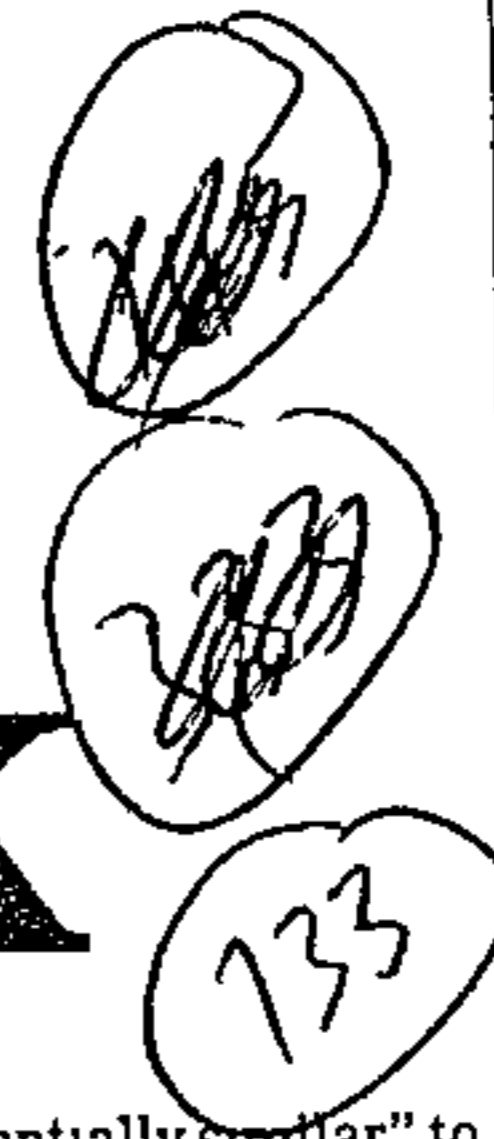

Star
AHI quits
23/6/82
Volkskas

Political Correspondent

The Afrikaanse Handel-
sinstituut has decided
to take its banking
business away from
Volkskas and give it to
the Trust Bank.

AHI president Mr
Jan Horn said today
the decision had noth-
ing to do with "dif-
ferences between cer-
tain large groups
presently being aired
in the media".

"This is a simple and
logical decision, taken
purely on merit, to ro-
tate the AHI banking
account among its
members."

The diplomat and the diggers

Rainy day deal

Star 24/6/82

1335

221

1335

By Tony Davis,
Labour Reporter

Deadlock in conciliation board talks this week between the mining unions and the Chamber of Mines

came as no surprise, because of the gulf between the unions' wage demands and the employers' counter offers

The eight unions, representing 22 000 white miners through the Council of Mining Unions, had demanded a 15 percent wage increase.

But the Chamber of Mines would go no better than nine percent, an increase of one percent over its previous offer.

The conciliation board earlier this month failed to resolve the dispute, as had the

regular wage talks held in April.

The talks were dominated by the strong personalities of individuals in the two negotiating teams

The Chamber of Mines is the vast umbrella body representing nearly all employers in the gold industries

The main visible authority in the wage negotiations for the chamber is its industrial relations adviser, Mr Johann Liebenberg

Mr Liebenberg is no stranger to wage talks, having been involved in labour matters since 1968, when he was involved with the industrial council for the motor industry

And he is also no stranger to diplomacy, having worked for the South African diplo-

matic service in West Germany during the 1960s

Mr Liebenberg's appreciation for union interests comes naturally, as his father was once president of the white-member Con-

ederation of Labour and also president of the Artisan Staff Association

Facing the refined Mr Liebenberg and his associates around the negotiating table were the heads and representatives of the eight-member CMU

The chairman of the council, Mr Arrie Paulus, who is also secretary for the Mine Workers Union, has made no bones in the past about his or his members' attitude towards the Chamber

has always had the interests of his members at heart. Recent miner rallies have shown the extent of his support and backed his rejection of the chamber's wage counter offers

Another potent force in the CMU is the SA Electrical Workers Union secretary, Mr Ben Nicholson

The diminutive unionist was away in Europe for the second conciliation board talks but had previously made his views known to the chamber about the wide difference in the two wage figures

Mr Nicholson had plenty of practice in negotiating skills from his many years of involvement on industrial councils

To Mr Ike van der Walt secretary of the SA Boiler makers

Society, the chamber's eight percent counter offer was totally unacceptable

He noted that when the gold price was over R700, the chamber granted the large wage increases, but warned that the money should be put away for times of decline in the industry

"Now the rainy days are here and where is the money?" asked Mr van der Walt

Mr Tommy Neethling is the secretary for the 32 000-member Amalgamated Engineering Union and another opponent of the chamber in the negotiations

Mr Neethling said that at the start of negotiations in mid-April, the chamber had said the gold price would not be used as a bargaining lever

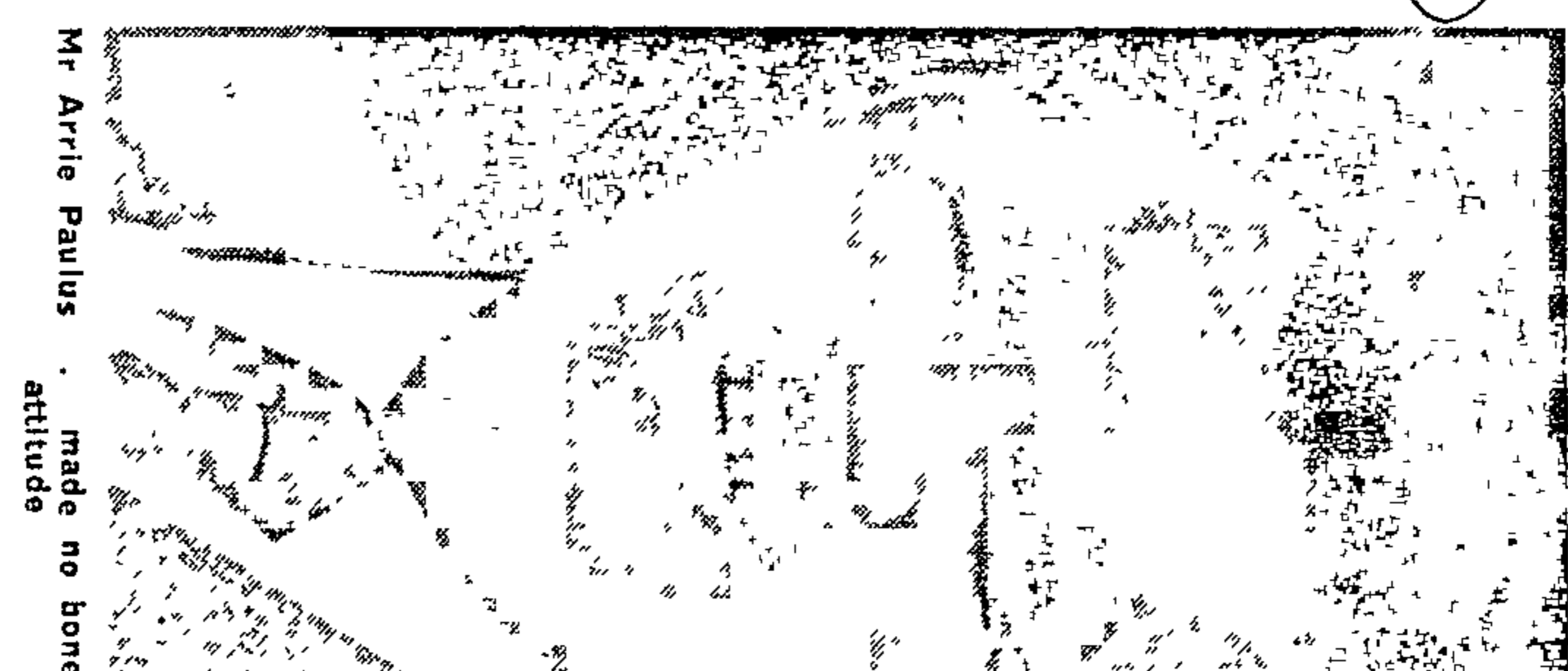

Mr Arrie Paulus made no bones attitude



no stranger to

Cape Times 25/6/82 **133**

Govt 'aware' of need for change

Staff Reporter

THE HEAD of the largest industrial group in South Africa and a sharp critic of Nationalist policy told businessmen in Cape Town yesterday that he believed the government was aware of the need for change

Addressing a Free Market Foundation lunch — one of the largest gatherings of top businessmen in the City since the Prime Minister's Good Hope Conference — the executive chairman of the R3.7-billion Barlow Rand conglomerate, Mr Mike Rosholt, said the status quo could not be maintained in the Republic if there was to be stability. "Fundamental change is called for and it is encouraging to sense that the government is well aware of this"

'Great pity'

Mr Barlow said it was a great pity that the economy had slowed down "just as the majority of government and white opinions and attitudes had changed so markedly"

Important changes which he believed should be implemented included

- The elimination of discriminatory legislation which would in due course lead to the elimination of discriminatory practices

- Improved black education and training

- Equality of opportunity and treatment in



Mr Mike Rosholt

labour practices and pay

- An increase in the numbers of blacks in management positions

Referring to the debate surrounding the constitutional proposals of the President's Council, Mr Rosholt said that unless there was some form of political dispensation acceptable to blacks, the entire private enterprise system would remain at risk.

Support

To boost the free enterprise system, businessmen should actively assist in bringing about change. In addition to creating the additional wealth and jobs which would allow a more equitable economic distribution between population groups, the business community should support organizations such as the Small Business Development Corporation and call for the removal of the mass of State interventions in the economy

In spite of examples of unjustified State intervention in areas of the economy which should have been the preserve of the private sector, there had recently been a marked policy change and the free enterprise system was now "almost a buzz word in the corridors of power"

But it was also imperative that the economy be freed from excessive controls and regulations including

- The many restrictions on labour, in particular the operations of the labour bureaux and influx control

- Job reservation, which was still a bar to blacks in the mining industry

Land tenure

- Land tenure which specifically prohibited freehold title for blacks in urban areas and which to a large extent prevented white participation in the development of the homelands

- Housing standard laws which obstructed the provision of urgently required low income housing

- The use of certain security laws for interference in the operations of the trade union movement

- The plethora of control boards whose operations cut across the free enterprise system, particularly in the agricultural sector

RY CANDIDATE MUST enter in column (1) the number of each question answered (in the order in which it has been answered), leave columns (2) and (3) blank

	Internal	External
	(2)	(3)
1	21 } 47 20 }	
2	40	
3		
4		
5		
6		
7		
8		
9		
10		
11		
12		
13		
14		
15		
16		
17		
18		
19		
20		
21		
22		
23		
24		
25		
26		
27		
28		
29		
30		
31		
32		
33		
34		
35		
36		
37		
38		
39		
40		
41		
42		
43		
44		
45		
46		
47		
48		
49		
50		
51		
52		
53		
54		
55		
56		
57		
58		
59		
60		
61		
62		
63		
64		
65		
66		
67		
68		
69		
70		
71		
72		
73		
74		
75		
76		
77		
78		
79		
80		
81		
82		
83		
84		
85		
86		
87		
88		
89		
90		
91		
92		
93		
94		
95		
96		
97		
98		
99		
100		

Notes, pieces of paper or other materials brought into the examination room are so instructed

2. Blue or black ink must be used for written answers. The use of a ball point pen is acceptable. Red or green ink may be used only for underlining, emphasis or for diagrams, for which pencil may also be used.
3. Names must be printed on each separate sheet (e.g. graph paper) where sheets additional to examination book(s) are used.
4. Do not write in the left hand margin.

2. Candidates are not to communicate with other candidates or with any person except the invigilator.
3. No part of an answer book is to be torn out.
4. All answer books must be handed to the commissioner or to an invigilator before leaving the examination.

Any dishonesty will render the candidate liable to disqualification and to possible exclusion from the University

CAPE TIMES 15/7/82

Chamber to hit at apartheid

Industrial Reporter

A MOTION urging an end to the coloured labour preference policy in the Western Cape is among several hitting out against discrimination based on race and colour to be presented at the annual regional congress of chambers of commerce in Paarl next Thursday

In a background document the Cape Town Chamber of Commerce said the policy discouraged blacks from acquiring skills therefore depriving the economy of skilled labour, while at the same time possibly depriving blacks of the right to jobs commensurate with their skills

"Accordingly the chamber urges that the black labour regulations be amended to allow qualified blacks resident in the Western Cape to be employed without the restrictions presently applicable to them"

Representations

The chamber said it had made representations to the Riekert Commission, the National Manpower Commission and the Minister of Co-operation and Development, Dr Piet Koornhof, urging the government to distinguish between migrant blacks and those with permanent residential rights

"It is beyond all understanding that before be-

ing able to employ 'qualified' blacks, it should be obligatory in terms of the black labour regulations to have to first satisfy the labour officer that suitable non-black labour is not available"

Other motions by the Cape Town chamber call for a removal of apartheid in cinemas, theatres and restaurants and the dismantling of Group Areas restrictions in commercial centres

'Frictions avoided'

"Freed of restrictive influences of statutory and administrative controls, as to whom they may cater for, businessmen would regulate their operations so as to best satisfy their own particular clientele, while at the same time avoiding situations likely to cause embarrassment to or friction among their customers," the chamber said in background documents to the motion

The day-long conference at the Nedeberg Wine Estate will be opened by the mayor of Paarl, Mr S du Toit

Speakers will include the manager of the Anglo American Corporation, Mr M C O'Dowd, the head of the University of Stellenbosch Department of Economics, Professor S J Terreblanche, and the past president of Assocom, Mr H Wolffe

Argus Correspondent

JOHANNESBURG — United States companies in South Africa are embarking on an ambitious programme to improve black standards in this country

The improvements form part of the rapidly accelerating programme in terms of the Sullivan principles formulated by the Rev Leon Sullivan

Dr Sullivan's righthand man, Mr Dan Purnell, executive director of the International Council for Equality of Opportunity Principles, visited South Africa this month and disclosed the goals of the Sullivan code for 1985

MANAGEMENT

In 1985, US firms in South Africa will

- Train 5 000 blacks in management and supervision
- Award 6 500 scholarships to students
- "Adopt" 1 000 schools with 700 000 pupils
- Support 24 technical centres training 10 000 people

Signatories to the Sullivan code have reached close to a 100 percent performance on desegregation and union recognition essential components of the principles

Sullivan upgrade forges ahead

ARGUS

19/7/82

132

133

134

Mr Purnell said that for the first time since progress reports were prepared in 1978, firms submitting reports on their progress in terms of the Sullivan code over the past year, will have to be certified by a public accountant.

He emphasised that while US companies employed only a small part of South Africa's work force, the Sullivan principles acted as a guide for other overseas companies as well South

African companies to follow

Several companies operate their own codes while some European firms follow the European Economic Community principles.

Mr W H Magruder, chairman of a committee of task group chairmen who head various aspects of the Sullivan principles said that in joint ventures with local firms Gencor and Samancor, these companies "are progressing faster than us"

Bid to raise cash for labour relations unit

133
E. Post
21/7/82

By LOUIS BECKERLING
Business Editor

THE Midland Chamber of Industries has launched a campaign to raise R150 000 over three years in order to expand and improve the services of the Industrial Relations Unit at the University of Port Elizabeth.

In his mid-year address to industrialists yesterday the president of the chamber, Mr Peter van der Merwe, revealed that the campaign would be launched by way of circulars which were presently being prepared.

The request for grants to the university, which would be tax-deductible, would "allow this body to expand its important field of operations", said Mr Van der Merwe.

"Industrial peace is very important to this region if we are to turn to best account the benefits that will accrue from the concessions of transport, training and electricity that were granted to the Port Eliz-

abeth/Uitenhage area" Asked for comment today, Professor Roux van der Merwe, head of the Industrial Relations Unit at UPE, said the attempt to raise additional funds had been "in the pipeline" for some time

"It is important to maintain our independence and not to be seen as a commercial consultancy," said Prof Van der Merwe.

"Since our inception last year we have become increasingly involved in assisting in ad-hoc inquiries from management. We do not normally charge for these services unless they become routine and this is one of the reasons for going to industry for additional funds"

Prof van der Merwe said the money would be used for increasing the three-man staff of the unit and to help finance visits to the university from overseas lecturers

● See Page 16

Claims
by labour
Mercury
congress
are denied

3/9/87
Labour Reporter

7
-
3
3
-
1
S
a
-
-
1
NO responsible employer would deliberately foster strike action in order to retrench workers, the executive director of the Natal Federated Chamber of Industries, Mr Roland Freakes said yesterday

He was responding to a claim by Fosatu's Natal regional congress that there was strong evidence to suggest that employers were provoking strikes to retrench workers, re-organise employment conditions and smash union organisation

The claim followed discussions on recent labour disputes last weekend, by the 70 shop stewards which form the congress

Mr Freakes added that employers were rather looking for stability in industrial relations

'The fact of the matter is that the economic down-swing is beginning to bite and an increasing number of companies are reducing staff

Mr Freakes was backed by the national chairman of the Textile Yarn and Fabric Manufacturers Association, Mr Lawrence Lurie, who said the congress's claims were 'absolute nonsense'

PE Sakekamer does not favour council politics

Post Reporter

THE chairman of the Port Elizabeth Afrikaanse Sakekamer, Mr Ronnie Kruger, today denied the organisation was political and wanted to see party politics in the Port Elizabeth City Council

He was commenting on the latest newsletter issued by the sakekamer, which supported two candidates in the forthcoming municipal elections because they "broadly supported the National Party"

The candidates are Mr Frikkie Kotze in Ward 8, and Mr Bill Hayward in Ward 12

This led to Mr Hayward denying last night that he had stood for any political affiliation when he asked the Chamber of Commerce, the Central Business District Association and the sakekamer, for support in the election

Mr Kruger said he believed there was "no room" in the council for party politics

The newsletter merely commented on a recent article in Die Oosterlig, which claimed that a political party was dominating the City Council, he said

The newsletter urged its members to support candidates who "broadly" supported the National Party — but not slavishly — and who were willing to criticise

If the other candidates also indicated they "broadly" supported the Government, then they, too, would enjoy the support of sakekamer members

The organisation was a-political but supported the Government of the day, Mr Kruger said

But this did not extend to a point where everything the Government did was regarded as sacrosanct, he added

133
BDAI
4/8/82
E Post

SA Foundation praises labour laws

133

LABOUR legislation in South Africa has created new industrial opportunities but, in the absence of similar political development, workers' leaders will use labour as a political platform.

This was said by Mr Gavin Relly, president of the South African Foundation, when he addressed members of an employers' association, Verband van Nederlandse Ondernemers, in Amsterdam Netherlands, this week. Mr Relly said new legislation had opened

trade unionism to all races and the country was now free to advance, retreat or go sideways with other countries enjoying the burdens and supposed rewards of industrial democracy.

POLITICAL

This, Mr Relly said, was a dramatic change from the past and excited the enthusiasm of those who wanted to use the new-found industrial freedom for wider political purposes.

He also said South Africa was forced into an excessive and seemingly obsessive preoccupation with security by a determined programme of destabilisation by revolutionary movements.

Commenting on the recent controversial recommendations of the President's Council and the subsequent specially convened Federal Congress of the National Party in Bloemfontein last week, Mr Relly criticised the exclusion of blacks from partic-

pation in central government

FLAW

"Although greater autonomy is envisaged at local-government level, the intention to co-opt coloureds and Indians will emphasise this exclusion. This is an obvious flaw, which is being severely criticised.

"But to be realistic, the Prime Minister probably went as far as he could, given current white political constraints," said Mr Relly

He saw the progressive changes initiated by Mr P W Botha as aimed essentially at righting "a generation of neglect and stupidity"

"For some years now, change in South Africa has largely taken place outside of Parliament — in the areas of labour and a freer economy and in the attitudes of employers and many South Africans in general.

"The essential unity of the economy has been re-emphasised and, with one exception, all formal race discrimination

in industry has been re-moved

"The focus of South African affairs has shifted dramatically to the area of industrial relations and the future will be largely bound up with problems of trying to make an enlightened industrial-relations system work," he added.

He went on to say that the split in the National Party had broken the logjam of Afrikaner political unity and signalled a new period of more-realistic and less-ideological politics.

THE Midland Chamber of Industries has called for a delegation comprising a City Council representative and labour relations experts to find a solution to the dispute between the South African Transport Services and Port Elizabeth dock workers.

The chamber's call comes after about 600 dockers signed a letter calling on the Port Manager to open discussions with the workers' committee by next Monday at the latest.

The letter said the efforts of the General Workers' Union (GWU) over 10 months to negotiate with SATS had failed.

"If the SATS administration does not agree to the workers' request, they will be forced to conclude that there is no point in further efforts to initiate discussions," the letter said.

While the workers were not seeking a confrontation with SATS, such a confrontation would undoubtedly draw in GWU stevedore members in all four South African ports, and would gain supportive action from members of the International Transport Workers Federation (ITF).

"A conflict of this scale will inevitably spill into the already tense black townships of Port Elizabeth," the workers' letter added.

"We call upon the leaders of the city and all those concerned with Port Elizabeth's economic and political well-being to intervene urgently in this conflict to try to persuade the SATS administration to negotiate a solution to this potentially dangerous conflict."

The chamber's executive director, Mr Brian Matthew, said today "The chamber is concerned that the entire labour situation seems to be deteriorating."

"In order to protect industrialists in this area a delegation, perhaps consisting of someone like the Mayor, assisted by experts like Professor Roux van der Merwe, head of the department of industrial relations at UPE, and the former chairman of the chamber, Mr A de Kock,

should meet with SATS and the union concerned to attempt to find a solution to the problem," he said.

However, Port Elizabeth's Mayor, Mr H van Zyl Cillie, said he felt the dispute was an internal SATS matter.

"I would not consider interfering in their affairs," he said.

Commenting on the chamber's letter, the head of the department of industrial psychology at UPE, Professor L Kamfer, said that if a body had the potential to take a labour force out on strike one should talk to it.

He said the issue was something SATS should consider very carefully because of possible international ramifications.

"It could lead to South African goods rotting in world ports," he said.

The PFP MP for Walmer, Mr Andrew Savage, today called the GWU's request for discussion on work-place issues "a moderate and conciliatory approach" as the union was not, in fact, demanding recognition.

"Not to talk is a dangerous attitude to take in a sphere where the stakes are very high and there is a danger of South Africa becoming isolated," he said.

SATS had to regard South Africa's harbours differently from the rest of its operations. The docks were vulnerable contact points with world trade.

"Clear thinking, enlightened policy-making and diplomacy are called for — or we're going to bump our noses," Mr Savage said.

SATS confirmed receipt of the workers' letter and reiterated that approaches to its management had to be conducted "through the correct channels."

By SANDRA SMITH

2. Post 16/8/82
Chamber warns
that ports could
come to a halt

Plea for talks with dockers

(133)

SATS union row under the spotlight

Post Reporter

THE Labour Affairs Committee of the Midland Chamber of Industries today discussed the Port Elizabeth harbour clash between the South African Transport Services (SATS) and members of the General Workers Union

Beforehand, the chamber's executive director, Mr Brian Matthew, said the overall labour situation, including the dispute in the motor manufacturing industry which has crippled production for more than a month, would be discussed

A report on the situation in the harbour, where the GWU has given the SATS an ultimatum to meet its workers' committee by Monday, would also be received

Academics, opposition spokesmen and the chamber have called on the SATS to do so

h
h
N

in a good year output rises to q_3 . Now buffer stocks reserves. so quantity q_3 is put onto the market at price p_1 . and put it into must by quantity $q_1 - q_3$ at price p_1 . and put it into buffer stocks reserves. so quantity q_3 is put onto the market at price p_1 . Now in a bad year output falls to q_2 . In order for the price to remain at p_1 the government must put $q_2 - q_1$ on the market, transfer quantity q_1 given on market at price p_1 . In this way government has been able to stabilize the system, although farmers income & venues.

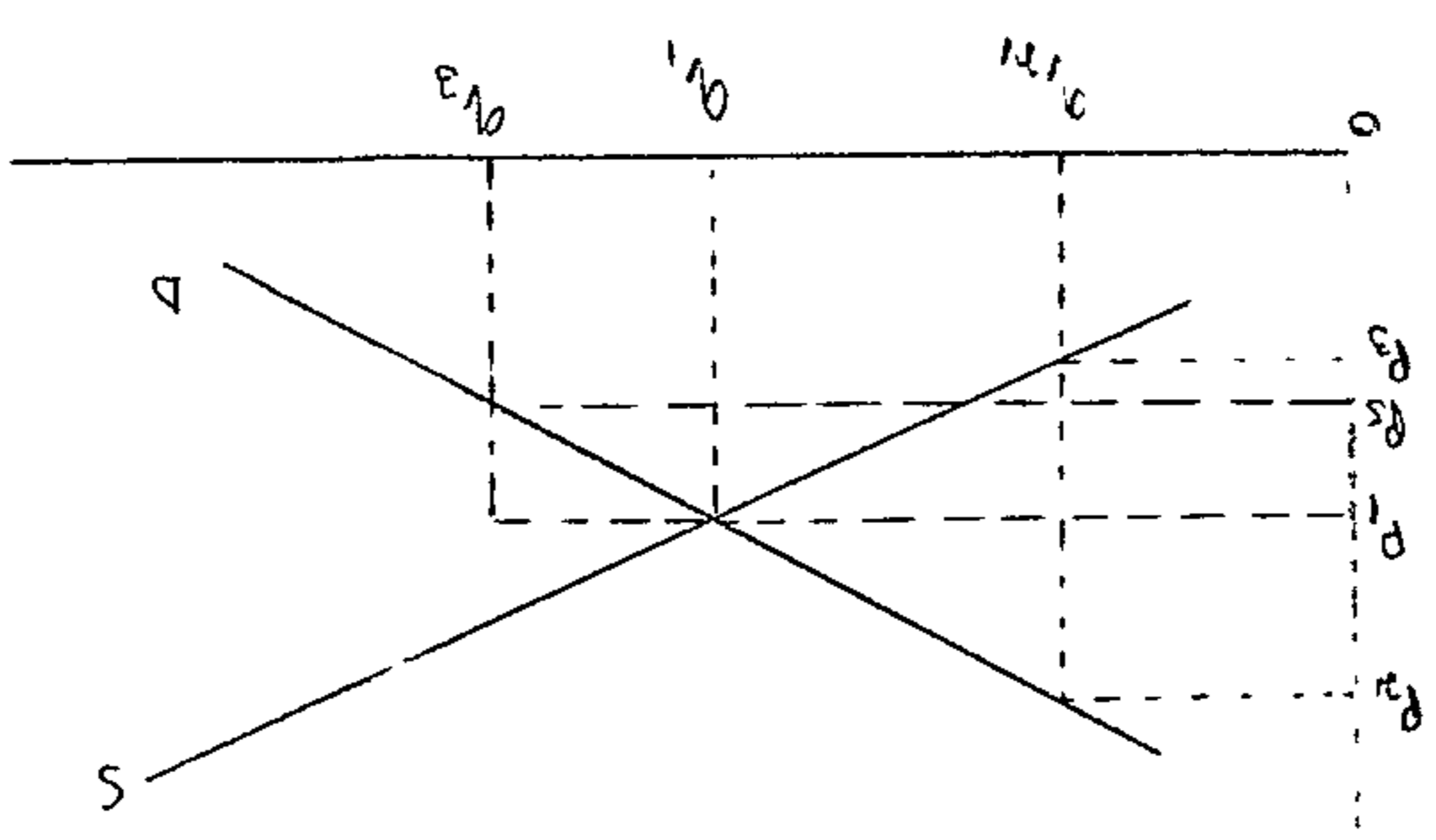

In a good year output rises to q_3 . Now if the government wish to stabilize the price they must by quantity $q_1 - q_3$ at price p_1 . and put it into buffer stocks reserves. so quantity q_3 is put onto the market at price p_1 . Now in a bad year output falls to q_2 . In order for the price to remain at p_1 the government must put $q_2 - q_1$ on the market, transfer quantity q_1 given on market at price p_1 . In this way government has been able to stabilize the system, although farmers income & venues.

Question 6 (Cont.)
 long run. If however the demand was unstable then the situation would be unstable and the price fluctuations would increase over time. The government may wish to stabilize the price and they can do this by buying and selling in the agricultural field

PE Mayor's help sought in dispute

133 263 149 270
E. Post 19/8/82

By SANDRA SMITH

THE Midland Chamber of Industries has formally asked Port Elizabeth's Mayor, Mr H van Zyl Cillie, to intervene in the dispute between the South African Transport Services (SATS) and the General Workers' Union (GWU)

The union, which represents nearly 1 000 workers in the harbour, has tried for 10 months to hold talks with SATS on conditions of employment of its members and has now given the employers until Monday to respond

The SATS has consistently refused to meet a GWU delegation because approaches have not come through recognised SATS channels

The Transport Services have also said there will be no negotiations with any worker body other than its own staff associations

The Chamber of Indus-

tries, Opposition spokesmen and academics have called on the SATS to hold talks with the union, and have warned of international repercussions if negotiations do not take place

On Monday, the Chamber of Industries called for a delegation comprising the Mayor and labour relations experts to find a solution to the dispute

Mr Van Zyl Cillie today confirmed receipt of a letter from the chamber on the issue, but said the contents were confidential

It is believed he was asked to intervene urgently and hold talks with top SATS management on the issue

"I am very concerned about the labour unrest in the Eastern Cape and am doing everything in my power to try to reach a favourable conclusion in this matter," he said

Mayor may initiate ~~132~~ meeting on labour ~~132~~ 133

20/8/82 Post Reporter

THE mayor of Port Elizabeth, Mr H Van Zyl Cillie, has been asked by city councillor Mr Bill Hayward to call a meeting of top industrialists to discuss "labour unrest"

Mr Hayward said the mayor had asked for a list of those who should attend

Mr Hayward also intended raising the issue at a meeting of the Greater Algoa Bay Development Committee (Gabdec) on Monday

"It is important that labour unrest, as a disincentive to potential entrepreneurs, should be removed as soon as possible," he said

Industry understood the importance of negotiation but deplored wild-cat strikes and could not accede to "high" wage demands, he said

Excuse police

would keep me in custody for six to 18 months if I did not co-operate

"If I did co-operate, W/O Taylor said he would talk to a magistrate to make things easier for me

"Capt Truter said if I did not tell the magistrate what they told me to tell him in my statement, I would be in trouble, and I thought I would be assaulted"

Mr Arumugam said he had been taken to Kempton Park police station after his arrest on February 24

A detective asked him if he wanted to make a statement

"I said no He said there were certain questions he wanted to ask and they were compulsory He left the room Then another detective, Arthur Lombardi, came into the room, stood in front of me and smiled

"Suddenly he slapped me across my left ear and punched me in the stomach I collapsed I was panting to get my breath back

"He said to me 'Are you crying? I'd like to see tears in your eyes'

"He kicked me on the thigh while I was lying on the ground"

The trial starts today

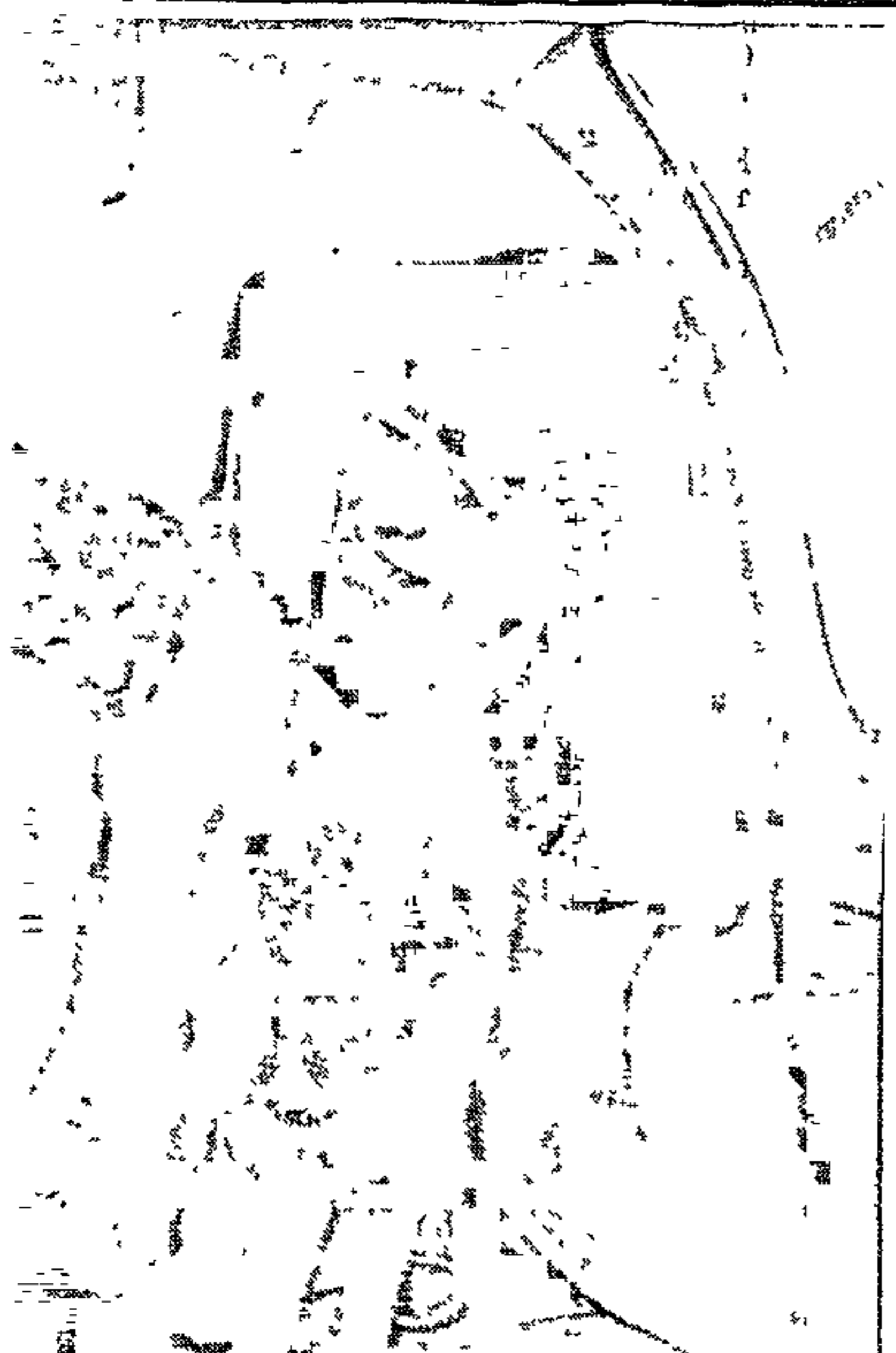

They from Zululand to Durban are three orphaned cubs. Mellet, director of the Centre for the Rehabilitation of the Blind, is pilot Tony Bustin of Eastcoast Airways, which will fly them.

Home for 3 lonely cubs

which were shot after the Umfolosi new "tempo"

and two female cubs. Mellet, Rehabilitation Mr Herman

Bentley, who had been caring for them since their mother was killed last week

Mr Bentley said yesterday the cubs were about six hours old when he found them

Mrs Mellet, who chartered a plane to fetch the cubs, said she would look them until they were fit enough to survive on their own and she was able to find a decent home — but she was adamant they would not be given to a circus or zoo

Pay rise turn for motor industry

Labour Correspondent
THE deadlocked Eastern Cape motor industry wage dispute took a new turn yesterday as employers announced they would unilaterally implement a 20c-an-hour interim wage increase which worker meetings rejected last week

Employers said despite the rise — which will come into effect retrospectively from August 22 — negotiations on workers pay demands would continue. They said they believed many workers were pleased with the decision.

But a spokesman for the National Automobile and Allied Workers Union, whose members downed tools several times in support of pay demands, warned yesterday that the move would spark "strong reaction" from workers. "It may well escalate the problem," he said.

And at the same time employers said while "intense" negotiations were likely with NAAWU over the next month, there were fears that no agreement between employers and the union would be reached this year.

The dispute is deadlocked with employers offering a rise which would bring minimum pay to R2,20 an hour and workers demanding R2,50.

NAAWU quit the industry's industrial council during the dispute and has been holding talks with the employer association representing the three companies. During these talks employers suggested that workers accept the R2,20 as an interim increase while talks continued.

But worker meetings rejected this, arguing that it was a "delaying tactic" which would "take the pressure to find a solution off management".

Yesterday employers informed NAAWU at an unofficial bargaining meeting that they were implementing the interim increase.

Duke of Kent for funeral

MBABANE — Prince Michael of Kent will represent Queen Elizabeth II at the funeral of King Sobhuza of Swaziland on Friday

The British High Commission in Mbabane announced yesterday that Prince Michael will arrive in Swaziland tomorrow evening on

board an aircraft of the Queens Flight, leaving again on Saturday morning

Representatives of several African countries including several heads of state, are expected to attend. No final list has so far been released by Swaziland — Sapa

Weather Mail

THE Weather Bureau's forecast for today —

TRANSVAAL — Fine and warm but hot over the north and east. It will become partly cloudy and cooler over the south-west

FREE STATE and CAPE north of the Orange — Fine and warm but the cloudy and cold conditions with light showers over Gordonia will spread eastwards to Griqualand West and later to the south-west Free State

CAPE south of the Orange — Cloudy and cold with showers but partly cloudy and mild over the east at first. Good falls are possible over the south-west Cape and the south coast, while snowfalls will occur over the south and south west Cape mountains

NATAL — Fine to partly cloudy and warm, becoming cloudy and colder in the south later with occasional rain

SOUTH WEST AFRICA — Fine and hot in the north but cold over the southern half

BOTSWANA — Fine and hot but partly cloudy and cold over the south — Sapa

Temperatures are Celsius maximums expected for each city

Rand Daily Mail Weather Station
YESTERDAY
Tuesday, August 31, 1982
Temperatures:
09h00 14h00 21h00
18°C 24°C 17°C
Humidity
40% 23% 42%
Max temp 24°C
Min temp 10°C
Rain 24 hours to 20h00
Nil
Sunset today 17h55
Sunrise tomorrow 06h21

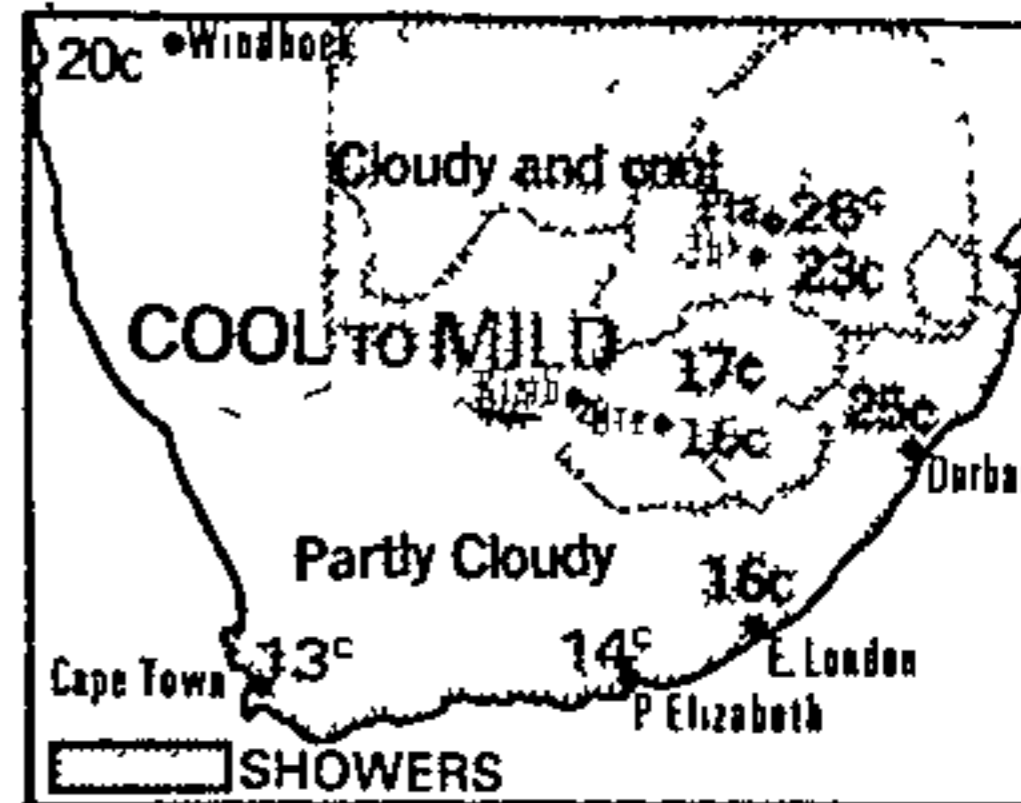

SOUTH AFRICA YESTERDAY

Temperatures at 14h00

City	°C	City	°C	City	°C
Bloemfontein	27	Jan Smuts	24	Potchefstroom	27
Cape Town	13	Nelspruit	31	Pretoria	26
Durban	28	Pietersburg	26	Skukuze	34
East London	19	Port Elizabeth	20	Standerton	27

SOUTH AFRICA Hottest at 14h00 Skukuze 34°C Coldest at 08h00 Sutherland 4°C
TRANSVAAL Hottest at 14h00 Skukuze 34°C Coldest at 08h00 Standerton 4°C

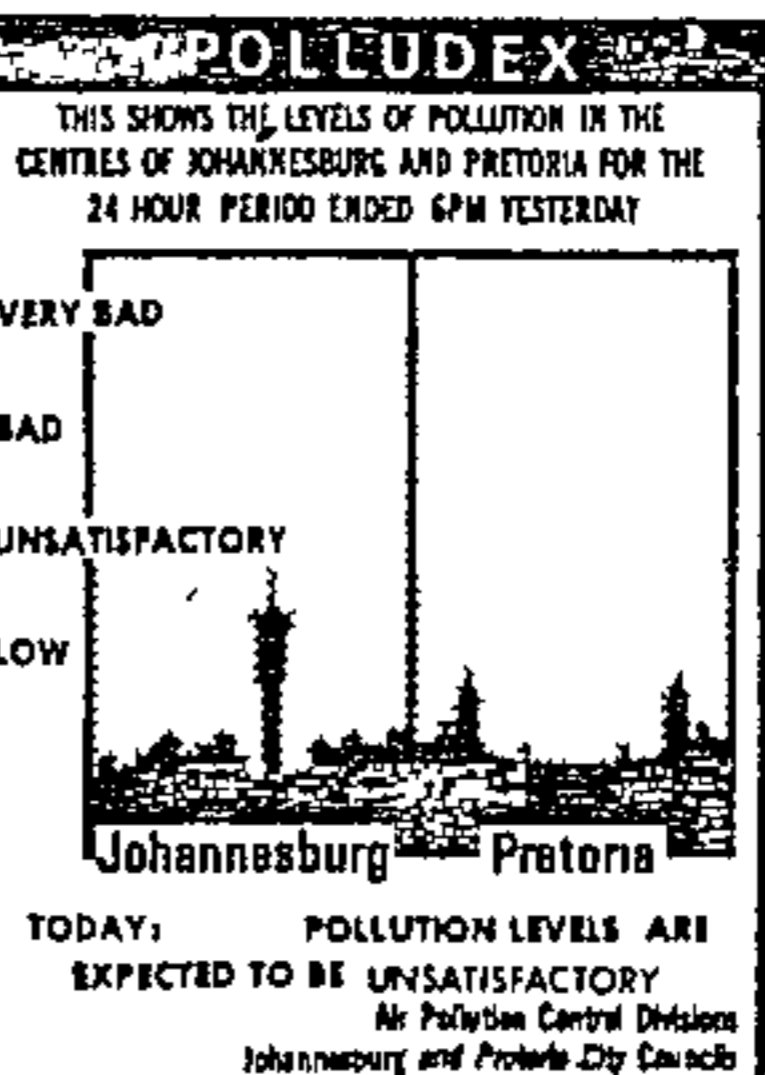

THE WORLD YESTERDAY

City	Min °C	Max °C	Weather
Amsterdam	13	20	Rain
Athens	22	34	Clear
Berlin	13	23	Cloudy
Brussels	7	18	Rain
Buenos Aires	10	17	Cloudy
Chicago	18	25	Cloudy
Hong Kong	27	32	Cloudy
Jerusalem	18	29	Clear
Lisbon	17	28	Clear
London	11	18	Cloudy
Los Angeles	20	30	Clear
Madrid	16	31	Cloudy
Miami	27	31	Cloudy
Montreal	8	18	Cloudy
Moscow	10	19	Clear
New York	16	22	Cloudy
Paris	12	22	Cloudy

TWO NEW members have been appointed to the President's Council to succeed Mr W C Dempsey and Mr P J V Pretorius
Dr Francois Jacobz will serve on the economic affairs committee of the council. He

PC gets two new members

succeeds Mr Dempsey, who has been appointed Ambassador to Belgium
Mr Pretorius becomes Commissioner-General for

the North Sotho in November and will be succeeded by Mr Sidney Goodwin, who will serve on the planning committee — Sapa

MATTER OF FACT

Decentralised DET scheme will speed up teachers' pay

Paint & Hardware Centre
2 Malherbe Street
Newtown, Johannesburg
(Opposite East Entrance of Oriental Plaza — off Bree Street)
ALL PAINTS AT LOWEST PRICES

GLOSS ENAMEL 5 litres R10,50 WHITE ONLY	ROOF PAINT 5 litres R12,50 25 litres R59,95 BRIGHT RED & BLACK
HIGH GLOSS ENAMEL 5 litres R12,50	CONTRACTORS ACRYLIC PVA

Questions to Minister over fired dockers

133
E. Post 2/9/62

By JERRY McCABE

THE dismissal of 400 workers by the South African Transport Services yesterday was raised during a question-and-answer session with the Minister of Manpower, Mr Fanie Botha, at his meeting with Eastern Cape businessmen today

Mr Brian Matthew, executive director of the Midland Chamber of Industries, asked Mr Botha why, when the Government had issued a White Paper accepting certain principles of maximum self-government, these principles were not carried out by Government departments like the SATS

Mr Matthew said a situation had arisen where the private sector was almost being held at ransom by what had happened in the Port Elizabeth harbour

Mr Botha replied that, as far as possible, the various Government departments were all dedicated to the principle of self-government and autonomy

"I am sure if you discussed the problems with the relevant department the matter could be sorted out. That department is

also dedicated to self-government," he said

The Government sometimes had to "look forward when other people neglected to do their duty", Mr Botha said

Another questioner asked Mr Botha to what extent he thought the police should be involved in industrial disputes

The Minister answered that his department never called on the police to solve its problems, and that the police became involved only when those involved in industrial disputes gave them reason to be

Mr Botha was also told that certain unions had difficulty in obtaining official recognition, and was asked what could be done about this

"We do try to expedite the recognition of unions as far as possible. Sometimes we do have a great problem getting the right information from the unions to enable us to recognise them. Sometimes the problem lies with the other side and not with us," Mr Botha replied

"It is to the advantage of all concerned that all unions should be registered"

RDM 137
3/9/82

Seifsa plea to Govt on negotiation

Labour Correspondent

THE director of the Steel and Engineering Industries Federation, Mr Sam van Coller, this week appealed to the Department of Manpower to "continue" backing Seifsa's efforts to retain the metal industries' industrial council system despite demands from unions to bargain outside the system.

Mr Van Coller addressed this appeal to the Minister of Manpower, Mr Fanie Botha, at Mr Botha's meeting with Johannesburg employers this week.

In his reply Mr Botha merely said his department would hold talks with Seifsa on any changes it planned to the country's official bargaining system.

Mr Van Coller had referred to the Minister's address in which he had said demands from some unions to negotiate directly with individual companies posed a difficulty to employers.

Mr Van Coller said metal employers had also been met with demands by emerging trade unions to negotiate outside the industrial council system.

In his reply, Mr Botha said he had originally believed that bargaining could be channelled into a "rigid system" but that he had since changed his view.

White union behind workers' aid move

By STEVEN FRIEDMAN
Labour Correspondent

THE Government's controversial R2-million plan to compensate "loyal" motor workers who don't want to join strikes was introduced at the express request of the country's biggest all-white union

The union, the SA Iron, Steel and Allied Workers' Union, is a power in the Rightwing Confederation of Labour

But neither employers nor the National Automobile and Allied Workers' Union, which represents about 11 000 black and coloured motor assembly workers, were consulted

In other developments yesterday

● A spokesman for the Unemployment Insurance Fund said the authorities had not yet worked out how the scheme would be implemented, and,

● Mr Botha's move was attacked by the SA Allied Workers' Union and criticised by the chief manpower spokesman of the Progressive Federal Party, Dr Alex Boraine

The scheme will set aside R2-million

from the UIF for workers who want to work but cannot because plants are closed by strikes

Yesterday Mr H Ferreira, general secretary of the SAISAWU, said he had asked the Government to introduce the scheme because of its experience in the Eastern Cape motor strikes when its members had wanted to work but had been unable to, because the plants had been closed

Mr Ferreira said he had specifically drawn the Government's attention to Section 46 of the Unemployment Insurance Act, which provides for relief for the jobless in this connection

"We want to insure that innocent workers do not suffer for the actions of others," he said

But Mr Rod Ironside, who chairs the Eastern Cape Motor Employers' Association, said yesterday employers had not been consulted

"We had an inkling through the grapevine that something like this was coming, but that is all," Mr Ironside said

He said employers were waiting to see how the fund was to be adminis-

tered, before taking the matter further
"This is crucial. However worthwhile the principle may be, there is no way we can decide which of our workers want to work and which don't," he said

It was established yesterday, however, that details of how the fund is to be run have not been worked out

"All we have done is set aside the money. We are waiting for suggestions from the Department of Manpower on how the fund is to be administered," a UIF spokesman said yesterday

Dr Boraine yesterday urged the Government to reconsider the move

He said it was "understandable" but would "seriously affect relations between management and worker and between worker and worker"

If workers affected by lock-outs did not also benefit from the scheme, it would seem to be "one-sided", he said

And Saawu said that, instead of the fund, the Government should ensure that black workers who had difficulty drawing unemployment benefits because they were homeland citizens were helped to do so

Support
for ~~133~~ 133
SATS in
harbour
dispute
E. Post

7/9/82
Post Reporter

THE executive of the Port Elizabeth Forwarding Agents Association, whose members control the movement of cargoes through the Port Elizabeth harbour, both inward and outward, have come out in support of South African Transport Services

After a meeting yesterday at which the latest harbour developments in the labour situation were discussed, the association issued a Press release which said

"A good deal of Press coverage has been given to this issue, the tenor of which supports the principle of dialogue between the SATS and its workers through the medium of the General Workers Union

"SATS, on the other hand will not recognise the unregistered GWU whose strength, taking the most optimistic of conflicting reports, totals possibly some 800 dockworkers

"This decision must be viewed against the background that, there are established lines of communication through the SATS staff association acceptable to in excess of a quarter of a million workers, also there is no apparent dispute as such between SATS and its black employees since no grievances have been defined," the statement says

"The PE Forwarding Agents Association wishes to associate itself with the stand taken by SATS and view with concern the current involvement of stevedoring labour in what is essentially a domestic matter between the SATS and its employees "

No chance for GWU — Schoeman

Labour Correspondent

THE Minister of Transport Affairs, Mr Hendrik Schoeman, yesterday issued a tough statement which appeared to shatter all hopes of a successful settlement of the simmering dispute in Port Elizabeth harbour

His statement came as private stevedoring employers continued efforts to avoid a strike by stevedores in sympathy with their fellow-members of the General Workers' Union. GWU men employed by SA Transport Services were fired last week

Yesterday the stevedores agreed to postpone planned sympathy action, due to begin today, while talks continued

But Mr Schoeman's statement, in which he said SATS would never recognise an "outside union", appeared to have torpedoed settlement hopes. The statement criticised employers who had commented on the dispute and implied SATS might intervene in a stevedores' strike, even though the stevedores are not employed by it

Mr Schoeman said that in Port Elizabeth some SATS workers had joined "an outside trade union" even though "there is a registered trade union recognised by SATS which can represent them"

He said it was "undesirable" for a union to have members both within and outside the public service — as the GWU does — and SATS had therefore recognised only unions "within its sphere of influence"

New chemical union wins rights for shop stewards

Labour Correspondent

EMPLOYERS and an emerging trade union in the Transvaal chemical industry have negotiated an official industrial council agreement which grants rights to union shop stewards for the first time

The agreement brings to an end the first negotiations in which the SA Chemical Workers' Union (SACWU) has been involved and also raises minimum pay by 50%, the highest rise in many years

It was negotiated between the Transvaal Chemical Manufacturers Association, the SACWU, and the (white and coloured) Chemical Workers' Union

SACWU general secretary Mr Dan Tau yesterday hailed the agreement as "proof of our view that if a union is strong enough it can win gains for its members on an industrial council"

In a joint statement yesterday the unions

and the employers association said the agreement which will come into effect when it is gazetted, provides for among other things

● Raising minimum pay from R43 to R65 a week, an effective increase of 50%. The minimum will be raised by 10% on July 1 next year

● Reducing the wage difference between the highest and lowest paid workers from 10 to 1 to 8 to 1 by granting lower paid workers higher percentage increases

● Allowing any union on the council with at least four members in a plant to appoint one shop steward to represent them

● Compelling employers to give written notice to workers before working short time

A spokesman for the employers association, Mr Alan Cohen said employers believed the increase was "not unrealistic bearing in mind increases negotiated in other industrial council agreements this year"

SACWU CWU Sowefam agree to wage hike

By SELLO
RABOTHATA

THE TRANSVAAL Chemical Manufacturers Association and various workers' unions recently came to an agreement on a number of issues in a bid to improve working conditions in the chemical industry.

The association, together with the South African Chemical Workers' Union (SACWU) and the Chemical Workers' Union, issued a joint press statement which among other things, reflected a wage agreement of an increase of 50 percent for weekly paid workers.

They agreed to:

- increase minimum wages in the industry for the period ending June 30, 1983 to R65 per week from the present R43 per week,
- reduce the existing differential of one to 10 to one of one to eight between the lowest and the highest paid categories of workers,
- further increase minimum wages by 10 percent as from July 1 next year which means the minimum wage will then be increased to R71 50 per week,
- negotiate a new agreement which will be effective from February 1 1984,
- ensure that employers give reasonable written notice to workers before working short time,
- bring public holidays granted into line with the provisions of the Public Holidays Act.

- increase sick leave provisions by allowing up to 30 days accumulation of sick leave over a three year period,
- accept that, providing a union has a minimum of four paid-up members in an establishment, it may appoint one shop steward to represent the workers. For every 50 workers or part thereof additional shop stewards may be appointed. Such accredited shop stewards will be granted three days paid leave for the purpose of attending trade union courses or seminars,
- allow council agents to interview alone workers who wish to make representations to them, and,
- appoint a Disputes Committee comprising one representative from each party to resolve disputes.

Politics not motive of unions experts

~~133~~ ~~133~~ ~~133~~
133

S. Post

11/9/82

By SANDRA SMITH

RECENT increases in trade union activity and worker militancy in South Africa have led to speculation that the labour movement is being used largely as a channel through which blacks can achieve political expression. There have also been claims that overseas union groupings are manipulating the South African labour situation for political aims. Weekend Post spoke to authorities in the field to canvass their opinions.

LAST week saw the sacking of several hundred dockworkers in Port Elizabeth after a go-slow aimed at forcing the South African Transport Services to hold talks with the General Workers' Union

For almost a year, the union has attempted to meet the SATS management. But the Transport Services are adamant that they cannot deal with any body representing workers other than their staff associations

Employer representatives, trade unionists — nationally and internationally — and Opposition spokesmen are united in their criticism of SATS' refusal to concede an internationally-recognised right — that of workers to be represented by a union of their choice

The SATS has never refuted the GWU's claim that most of the dockers — about 900 out of a workforce of 1100 — belong to the union

Against this background, the belief is still widely held that the South African trade union movement is being used as a political platform and that this is the root of labour unrest

Weekend Post asked trade unionists, major employer representatives, a sociology lecturer and an industrial relations expert how they viewed statements that action by workers or trade unions was largely politically motivated

The Executive Director of the Federated Chamber of Industries, Dr J van Zyl, felt such generalised statements were often aimed at undermining the status of all trade unions.

"If the intention of such allegations about political motivation is to cast doubt on the whole black labour movement, they should be rejected. They are not true, and possibly dangerous," he said

On the other hand, how-



Manpower Minister Mr FANIE BOTHA called for dialogue.



Naawu's Mr FREDDY SAULS says labour demands reflect need.

ever, it was probable that political influences motivated by considerations other than the welfare of workers were at work, he said

The executive director of the Midland Chamber of Industries, Mr Brian Matthew, pointed out that trade unions had never raised political issues or demands in strikes or labour action in the Eastern Cape

The Director of the Institute of Industrial Relations, Mr Henk Botha, said all trade unions had political views but this was not necessarily sinister

The fact that South African blacks did not have political rights meant the trade union movement would be used to express political views. This was not necessarily a bad thing as long as it did not effect the employer-employee relationship.

not merely in the workplace — and that is why trade unions will always be used to express political views — in black as well as white trade unions," Mr Botha said

However, workers' real concerns were with wages, and the long-term political situation was a secondary concern

A political interest expressed through a trade union did not invalidate wage demands, Mr Botha felt

Mr Jan Theron, general secretary of the Food and Canning Workers' Union, felt the Port Elizabeth dock dispute made nonsense of statements that the trade union movement was being used as a political platform.

"I do not believe workers choose strikes as a way of resolving disputes: it is a last resort when it appears

course of action is available," he said

Those acting on the supposition that strikes were orchestrated by union leaders or outside forces had no conception of the working class, particularly in the face of high unemployment

"People who are well-paid and have a say in determining their working conditions are not going to place everything at risk at the urging of some outside agent. Neither do workers expect employers to change the political status quo," Mr Theron said

Far from attempting to "cause chaos" to focus international attention on South Africa, unionists were trying to build organisations for the benefit of workers

While there were political implications in people belonging to trade unions, it was not possible for them

say in the running of factories without having any say in the running of the country, he said

Referring to the dispute between SATS and the GWU in the Port Elizabeth harbour, a Rhodes University sociology lecturer, Mr Paul Stewart, said the Government's present stand on labour relations was "riddled with contradictions"

These contradictions forced trade unions into the political arena, to the detriment of attempts in the private sector to establish sound labour relations

On the one hand, the Government was attempting to provide a framework for collective bargaining, while on the other it employed "its traditional strong-arm tactics to squash worker organisation"

The contradictions between, for example, the call by the Minister of Manpower, Mr Fanie Botha, on the private sector to keep open the channels for dialogue with unions, and the SATS refusal to talk with the GWU, served to politicise the labour situation.

The general secretary of the National Automobile and Allied Workers' Union (Naawu), Mr Freddy Sauls, said people who believed the trade union movement was primarily political in nature "show a clear lack of understanding of what is really taking place in the South African labour situation"

He cited the example of the wage demands in the Eastern Province automobile industry which were "based purely on the socio-economic needs of the workers and have nothing to do with political aspirations"

The reason for the widespread view that trade unions were politically motivated was that often those confronted with workers' demands needed to avoid the issues with which they were confronted — to invalidate them

"Workers are not going to listen to someone else dictating to them what they should do," Mr Sauls said

Connections between South African and foreign trade unions were based on co-operation on matters of

Naawu refers talk to its lawyers

By SANDRA SMITH

THE National Automobile and Allied Workers Union (Naawu) has referred statements about trade unions made by the head of the Department of Economics at the University of Port Elizabeth, Professor J H Smith, to its attorneys

Naawu's general secretary, Mr Freddy Sauls, said today the union did not wish to comment on Prof Smith's allegations and had referred the matter to the union's attorneys

Addressing the Afrikaanse Sakekamer of Murraysburg at the weekend, Prof Smith said the nature of strikes and "labour unrest" in the Port Elizabeth and Uitenhage areas indicated that the economic onslaught against South Africa, which was part of a "total onslaught", had reached a national level.

He said strikers' actions were "finely planned" in accordance with "the East German model", whose union leaders had been trained "behind the Iron curtain".

Negotiations were conducted specifically at a time when the motor industry was in a decline, Prof Smith claimed, so that they could be negotiated from a position of strength

Multinational companies were chosen as strike targets so that their parent companies would pressurise them to concede to demands

The aim was also to escalate costs to such an extent that it would be unattractive for foreign companies to invest in South Africa, he said

The underlying strategy was to keep a strike going as long as possible and thereby to "incite" as much "unrest" as possible

Grievances could then more easily be used "for terrorism movements and sabotage"

The real reasons for strikes were thus not economic, but political, with the aim of destroying the free enterprise system

Naawu represents more than 10 000 workers in the Eastern Province automobile industry. Its members recently went on strike after wage talks broke down

The Executive Director of the Midland Chamber of Industries, Mr Brian Matthew, and the head of the Department of Industrial Relations at UPE, Professor Roux van der Merwe, have criticised Prof Smith's statements

P
t
t
6
" O O R O C
h
T
o
c
s
P
F
r

MCI bulletin sets out workers' rights



Post 14/9/82

Post Reporter
IN an editorial in its latest Information Bulletin, the Midland Chamber of Industries has laid down some of the principles involved in labour relations

Freedom of association and the right of workers to organise were accepted as inalienable human rights in

the Western world, to which South Africa was linked both in investment capital and technology, the editorial said

As a result of a difference of opinion over the interpretation of these basic rights, Port Elizabeth had once again been the scene of management-worker

confrontation

The editorial was referring to the dispute between the South African Transport Services and the General Workers Union which led to the sacking this month of 425 dockworkers after a go-slow

The GWU, which represents most dockworkers,

has tried for nearly a year to hold talks with SATS on working conditions

Freedom of association and the right to organise were entrenched in two International Labour Conventions of 1948 and 1949, the bulletin said

Convention number 87 stated that workers and

employers should have the right to establish and join organisations of their own choosing, and the rejection of any interference by any public authority was spelled out clearly

South African labour legislation followed the principles in the Labour Rela-

tions Act which stated that an employer "and all or any of his employees" could set up a Works Council.

"It is this concept that this chamber believes should be applied to all labour, irrespective of which Act it may fall under," the editorial said

Hopes rise for PE docks peace

Labour Correspondent

HOPES that an escalation of the labour dispute in Port Elizabeth docks will be avoided rose yesterday after a meeting between a stevedores committee of the General Workers Union (GWU) and SA Stevedores Ltd, which runs stevedoring operations at the harbour.

The GWU's general secretary Mr David Lewis said the two sides had a "fruitful and important meeting" and added that proposals which had been discussed would today and tomorrow be put to meetings of stevedores and dock workers fired by SA Transport Services.

The SATS dockers were fired and bussed out of the harbour after launching a go-slow in support of demands that SATS talk to the GWU about recognition. SATS has refused to do this for the past 11 months.

SA Stevedores has warned that its workers have planned a sympathy strike in support of the fired dockers and their

demand for reinstatement as well as talks between SATS and the GWU.

Since then the two parties have been seeking ways to prevent this, a move which has involved attempts to settle the dispute between SATS and its dockers.

Mr Lewis would not elaborate on yesterday morning's discussions.

But it is likely the worker meetings will discuss whether the GWU should give evidence to a committee set up by the Minister of Transport Affairs, Mr Hendrik Schoeman, to examine SATS's labour relations structures.

Although SATS says the committee was established in May, its existence was revealed for the first time in a statement by Mr Schoeman late last week.

Some sources see a decision by the GWU to give evidence to the committee as a way of beginning communication between the union and SATS and as a way of resolving the dispute.

Cape Times 17/9/81
'Increase salaries to meet bus fares'

Staff Reporter

IT WOULD be better for employers to increase salaries to meet the latest increase in bus fares than for them to pay a higher clipcard subsidy, the president of the Chamber of Commerce, Mr Harold Groom, said yesterday

Commenting on Wednesday's announcement by City Tramways that the cash price of bus fares would increase by an average of 11,6 percent and a maximum of 14,3 percent, he said he believed "employers will take this and other recent price rises into account when reviewing salaries"

At present, employers in the Western Cape pay a weekly levy of 20c for each coloured and Indian employee, and a monthly levy of R1 for each African employee

'Bureaucratic'

This goes into a fund for the subsidization of the clipcard system

Mr Groom said it would be better to increase salaries than to increase the levies paid because administering the present levy was a "cumbersome, bureaucratic procedure"

City Tramways have pointed out that fares for certain, unspecified 10-ride clipcards would remain unchanged, while increases in general ranged from one to three cents a journey, excluding highway and long distance trips

The price of 10-ride scholar clipcards would increase by one cent a journey. The increases come into effect on Tuesday, although clipcards bought at old prices will remain valid after that date

City Tramways' previous cash fare increase came into effect in March this year, when fares rose by an average five percent to meet the increased petrol price

Mr Groom said it was "very unfortunate that the people who are suffering the major impact of the increase are those who for reasons other than choice are living so far from the centre of town"

Industrial councils: Seifsa warning

CAIG Tmk's
17/9/82
133
154

Staff Reporter

WHILE welcoming steps to extend full trade union rights to black employees, the director of the Steel and Engineering Industries Federation of South Africa (Seifsa), Mr Sam van Coller, warned the government yesterday against taking action which might undermine the functioning of industrial councils

Mr Van Coller was speaking at a sitting of the President's Council's economic committee to investigate measures which inhibit the effective functioning of a free market-orientated economic system in South Africa

'Opportunity'

Mr Van Coller said Seifsa believed full trade union rights would provide an important opportunity for black employees to participate in the process of allocating the rewards derived from successful economic activity

He said the National Industrial Council for the Iron, Steel, Engineering and Metallurgical Industry provided employers and employees with the opportunity to negotiate national minimum conditions of employment in the metal industries

"It is essential that the industrial council system is maintained so that collective bargaining can continue to take place within a sound structure in future. But because of their exclusion from this forum, black workers are

suspicious of the industrial councils

"As it is likely to take time to overcome these suspicions, Seifsa believes it is essential that the government does not take any steps which might undermine the functioning of the industrial councils," Mr Van Coller said.

He said the process of registration of trade unions provided for in the Labour Relations Act was currently giving rise to serious reservations among the emerging trade unions towards the official collective bargaining system

Seifsa, in response to an investigation being conducted by the National Manpower Commission, had recommended that registration of trade unions be placed on a par with the registration of companies

Recommended

They had also recommended that the question of representativeness should be a matter for employers and trade unions to determine and not the Industrial Registrar

"It is understood that any changes to legislation that might occur in this area will be only in 1984. In view of the urgency of this matter, Seifsa believes every effort should be made by the National Manpower Commission to complete this investigation, so that appropriate amendments can be made to the legislation in 1983

Seifsa chief in plea for industrial councils

300
133
18/1/82
D. Dipatch

CAPE TOWN — While welcoming steps to extend full trade union rights to black employees, the director of the Steel and Engineering Industries Federation of South Africa (Seifsa), Mr Sam van Coler, has warned the government against taking action which might undermine the functioning of industrial councils

Mr Van Coler was speaking at a sitting of the President's Council's economic committee to investigate measures which inhibit the effective functioning of a free market-orientated economic system in South Africa

nomie system in South Africa

Mr Van Coler said Seifsa believed full trade union rights would provide an important opportunity for black employees to participate in the process of allocating the rewards derived from successful economic activity

He said the National Industrial Council for the iron, steel, engineering and metallurgical industry provided employers and employees with the opportunity to negotiate national minimum conditions of employment in the metal industries

"It is essential that the industrial council system is maintained so collective bargaining can continue to take place within a sound structure in future. But because of their exclusion from this forum, black workers are suspicious of the industrial councils," Mr Van Coler said

"As it is likely to take time to overcome these suspicions, Seifsa believes it is essential the government does not take any steps which might undermine the functioning of the industrial councils," Mr Van Coler said.

— SAPA

~~133~~

133

~~133~~

~~133~~

~~133~~

DDLO PAKL
24/9/82

Motor worker well-being a priority — employers

PORT ELIZABETH — Employers in the Eastern Cape automobile industry would pursue "whatever course of action" was necessary to ensure the well-being of the workforce was maintained the chairman of their union Mr R J Ironside said yesterday

Mr Ironside the chairman of the employer members of the Eastern Province Automobile Manufacturers' Association (Epama) was reacting in a statement on recent conditions in the automobile industry in the Eastern Cape

He said Epama had demonstrated clearly over many years that it believed in negotiating

conditions of employment collectively with those unions representing its workforce

In the industrial council for the automobile manufacturing industry in the Eastern Cape negotiations for a new agreement broke down two months ago when the parties could not reach consensus on new conditions of an employment package

The council decided to go to arbitration, at which point the National Automobile and Allied Workers' Union (Naawu) resigned and withdrew from the council

To try to overcome the impasse that Naawu's action had created, the

statement said, the employers volunteered to continue negotiations outside the industrial council with all representative employee parties

Naawu and the Motor Assemblers and Component Workers' Union of South Africa rejected this

"In the spirit of constructive action which the employers believe is critical to maintaining orderly industrial relations, they intend to pursue whatever course of action is necessary to ensure that the well-being of the workforce in this industry is maintained," the statement concluded — SAPA

Teargas can be used by more employers now

Post Correspondent

JOHANNESBURG — Anti-insurgency measures have been strengthened by a new regulation, gazetted last week, which allows more employers to use teargas

A spokesman for the Department of Justice said the regulation, which revises an earlier one issued two years ago, is intended to give authority to those in charge of certain key points to possess and use teargas if they wish

The new law extends permission to use teargas to people who undertake the supply of water and who house more than 100 workers in compounds

Since 1981 local authorities, mines, electricity suppliers and companies which house more than 100 migrant workers in compounds have been authorised to use teargas

Mr A A Lood, assistant legal manager of Escom, said the organisation had applied for permission to use teargas

"We've never had to use it, but you never know when we may have to," he said

The Chamber of Mines refused to comment, saying it was up to individual mining companies to decide on their own security measures

A spokesman for Gold Fields security division refused to comment

A spokesman for LTA public relations division said "Teargas doesn't fall under public relations — it falls under industrial relations"

The LTA industrial relations officer was not available for comment

A spokesman for the Food and Canning Workers' Union said "We're absolutely appalled at the use of teargas in compounds"

"It has never been used in our industry, but the mere fact that such a method of controlling workers has official approval shows that managements would rather use force than negotiate"

133
E. Post 27/9/82

into line

New FCI boss planning to get 'industrial philosophy

Finance Reporter

RON IRONSIDE, who is to be inducted as president of the Federated Chamber of Industries (FCI) at its annual congress in Pretoria this week, is to devote his two-year-term to "bringing South Africa's industrial philoso-

phy into line with the rest of the world's"

Ironsides, who claims he "is Scottish by birth, South African by adoption and American by contamination," and who speaks Afrikaans fluently and is assistant managing director of General Motors SA, has been laying the founda-

tion for his crusade for the past two years, while he was chairman of the chamber's labour affairs committee. Right now South Africa's middle management has about the toughest job in the world," he said.

"It is dealing with conditions that exist nowhere else in the world, it is dealing with a non-industrial society that is becoming an industrial society in a situation that is complicated by language, culture and ethnicity.

"The only way that we are going to overcome those problems will be by getting government, employers and employees to get their thinking right, for government to adopt more practical policies and for all to depoliticise the workplace."

Ironsides said these problems were to be expected in a country such as South Africa which is still learning to become an industrial society, and while it learnt the counter-productive and irrelevant cross currents, and socio-political and socio-economic factors that are, in fact, impeding progress must be expected.

"The chamber is in an ideal position to bring home to all the parties that these counter-productive forces exist and that they are critical to the ultimate success of our becoming an industrialised nation and must be eliminated," he said.

"So I will try to use the FCI to get all together and persuade

133

Switburne

3/10/82

them to pull together, to broaden their base and to become an industrial community in the true international sense of the phrase.

"We will try to broaden the base of technological, industrial and social relations that involves analysis, research and consultation between all the interested parties which the FCI can orchestrate.

"We must get the labour organisations to realise that there's a philosophy that must be developed. We will help them develop it. That's my mission," he said.

RDM 12/10/82

Slowdown in SA metal industry

184
133

Financial Reporter

MOST sectors of the metal industries were being affected by adverse trading conditions, said Mr J E D Bramwell, president of the SA Steel and Engineering Industries Federation, yesterday.

A major exception was the sector involved in the continuing expansion programme in power generation, he told the federation's 39th annual meeting in Johannesburg.

Although buoyant conditions of the previous two years had extended into 1982 for some sectors of Seifsa, the South African economy was entering a potentially serious recessionary phase.

In 1981 output of steel ingots was 8 000 000 tons, down 0,9% on the peak level of 1980. Pig-iron production at 7 400 000 tons was marginally up on 1980, and the export-intensive ferroalloy industries' output of 1 400 000 tons was slightly under the 1980 figure.

Foundry output for last year for all types of metal was 677 000 tons, matching 1980 production.

Mr Bramwell said the major Western economies had made real progress in reducing inflation, there were signs that interest rates were coming down and the energy crisis appeared to have passed, albeit temporarily.

In contrast, South Africa had made no real progress in reducing inflation. High inflation at a time when the economy was in recession had all the makings of serious difficulties.

Although many employers had tried to keep redundancies low, significant numbers of employees were being retrenched.

Inflation was tending to reduce the competitiveness of South African industries internally and overseas in spite of the declining rand. A major initiative was required if progress was to be made in cutting the inflation rate.

The annual gross output of the Seifsa group of industries, now R11 000-million, constituted a third of total manufacturing output in SA. Its well being was essential for SA.



Mr P E Streicher, managing director of SA Manganese Amcor, was elected president of Seifsa yesterday.

FCI worried by state powers

133
D. N. D. Path
PRETORIA — The Federated Chamber of Industries is disturbed at the growing tendency for ministers to be granted "sweeping" powers

6/10/80
The chamber also warns that unemployment is a potential source of instability, especially among urban blacks, in the current volatile industrial relations climate.

In his annual report, tabled at the FCI conference here yesterday, the executive director, Dr J. C. van Zyl, said peace and progress in South Africa could only be achieved in the long run if the aspirations of the different racial groups could be accommodated and fears dispelled

"What is needed is a new economic and socio-political order in which white, brown and black can enjoy full scope for realising legitimate aspirations while sharing responsibility for matters of common concern."

The chamber was, however, disturbed at the growing tendency for government to introduce legislation which incorporated very wide ministerial powers, although it had been assured that they would not necessarily be exercised.

The wide powers were noticeable particularly in the National Supplies Procurement Bill, Armaments Development and Production Amendment Bill, the Defence Amendment Bill and the Protection of Information Bill.

"While we accept the threat against South Africa is real, the question is whether it is really necessary for the authorities to be granted such sweeping powers — particularly against a background of the steps being taken to bring about a climate of prosperity and stability for southern Africa"

The chamber claimed the pace of change in industrial relations was considered too slow by many foreign governments and interest groups, and also called for a balanced approach to the utilisation of available manpower in defence. This was the only chance of economic survival in the longer term, it was stated

The FCI predicted that in the current transitional stage of industrial relations the number of strikes and work stoppages would increase —
DDC

Council for Blind Investigates Grievances

Post Reporter

THE chairman of the National Council for the Blind, Professor Theo Pauw, held talks with the manager of the Mount Road factory of the Port Elizabeth Society for the Blind, Mr D W Glendinning, today after the sacking of six workers this week

Long-standing grievances of blind workers at

the factory are reported to have come to a head with the sacking of a supervisor and instructor and six workers, the calling of police to remove workers from the premises and fist fights between Mr Glendinning and employees

The series of incidents began last week when a worker and Mr Glendinning are reported to have had a

disagreement which led to a fist fight

The worker was told to leave the factory to "cool off". A supervisor and instructor who intervened were later sacked

The worker continued to report to work, and colleagues say two days after the incident police were called to remove him

Other workers intervened. However, a police spokesman said he had received no reports of police being called to the factory

When employees were paid on Friday about nine of them were reported to have found amounts missing from their pay packets

A fight again broke out between Mr Glendinning and workers

On Monday morning six workers were given termination wages. Fourteen of their colleagues walked out in sympathy with the dismissed workers

Unexplained deductions from their pay packets are one of the blind workers' long-standing grievances

Neither Mr Glendinning or Prof Pauw could be contacted for comment today

Bifsa attacks 'vicious' mortgage rates

~~133~~ 133 ~~133~~ Star 12/10/82

Building societies have come under attack from the Building Industries Federation of South Africa

In a statement accompanying the Bifsa annual report the executive director, Mr Lou Davis, says "The performance of the building society movement in increasing mortgage interest rates to ridicu-

lous levels in order to offset their inability to attract institutional deposits, is a circumstance which makes the average young worker despair of ever owning a portion of South African equity

On the activities of the societies' development companies, Mr Davis said Bifsa had maintained a "critical review" with a view to protecting the interests of those members to whom the shortage of mortgage bond financing presented such a critical threat

Commenting on Mr Davis's remarks, Mr Keith Gibbs, senior general manager of the South African Permanent Building Society, said "Societies have always borrowed short and lent long

The entire movement is structured on this basis

"The societies can offer lower mortgage rates because of their share portfolios as well as tax benefits Other than that the rates must be market-related, or the money will flow away

"It is not necessarily a case of attracting new funds but fair rates are important if you are to retain existing funds"

This pattern applied not only to institutional investors but to man-in-the-street investors, who accounted for 90 percent of society depositors

On prospects for the building industry Mr Davis says "Despite predictions of a negative growth rate next year for the general

economy followed by a significant upsurge from 1984 onwards, Bifsa can find no sound reason to alter forecasts of a constant steady growth of about 5 percent a year in the long-term"

He warns against allowing financial analysts to "talk the building industry into recession" If they do, he says, the next upswing in prices to satisfy normal building demand will be "mind-boggling"

On costs, Mr Davis makes the point that average builders' profits ("not trading profits enjoyed by marketing and sales agencies") amount to an average of 6 percent on turnover which must be regarded "as moderate, if not downright suicidal"

RIDGID

300 Power Drive

- All metal lightweight construction
- Heavy duty 0.37 kW motor
- Full 25 mm capacity (pipe and solid rod)
- Adapts to threading by using low



DO YOU WANT TO SELL YOUR BUSINESS?

Public companies are looking for acquisitions if our profits are more

C H ... in US

133
**Stop order
ban appeal**

Labour Correspondent 6

1
1
1
3
FOSATU's Metal and Allied Workers Union (Mawu) is to appeal to the Minister of Manpower, Mr Fanie Botha, against a decision by the Metal Industrial Council banning it from receiving stop orders from employers

The union will ask Mr Botha to overrule the ban and its appeal will be a key test of Government attitudes to unions who do not join industrial councils

1
1
e
o
e
In a statement yesterday, the union charged that the stop order bar was a result of its failure to join the council and that unions on the council and the Steel and Engineering Industries Federation were working together "to try to bring MAWU into line"

12/10/82

12/10/84

Unions to consider proposals today

Labour Correspondent

THE giant Steel and Engineering Industries Federation has endorsed proposals aimed at making important changes to the metal industrial council — the country's biggest

Details will be put to unions on the council at a meeting today

They include one enabling metal firms to draw up agreements with unions on the shop floor on issues like shop steward recognition and to lodge these with the council — a key departure from previous practise on the council

News of the proposals was announced yesterday in the

presidential address at Selk's annual general meeting by outgoing president Mr Bill Bramwell

Mr Bramwell said there was "a serious level of distrust among black workers of the council system" and it was important for the council to show all workers it could provide both protection and effective procedures for the resolution of their problems

With this in mind, the parties to the council were "structuring a procedural agreement aimed at establishing effective mechanisms for handling the tensions that have characterised industrial relations over the past year"

Damelin

CORRESPONDENCE COLLEGE.

Is your lack of education preventing you from earning a higher salary?

The Damelin method is a study method which will help you complete your education.

And a better education means a better salary. Call in at Damelin Centre, 114 and 116 in Street 15 or cut out this coupon and send it in today for a free brochure.

High School and Professional Diploma Courses

Putco makes way for Union bargaining says report

Some from Sept. 1982

PUTCO, the largest bus industry in the country, views trade unionism as a suitable vehicle for the collective expression of employee concerns and ideas.

In its latest publicity brochure the company says once majority support for a particular union is proved at any depot, negotiations are conducted for the recognition of the union and the election of shop stewards takes place.

In this way an agreement has been signed with the Transport Allied Workers Union, and shop stewards have been elected at Boksburg, Putcoon and Wynberg.

A preliminary agreement has also been signed with Fransport and General Workers Union which has majority representation at the Springs depot.

The company also recognised liaison committees representing Putco employees as

these continue to provide effective communication channels between workers and management.

Recent negotiations on wages, and conditions of service, reached an historic milestone by including for the first time representatives of both unions as well as the Central Liaison Committee.

As a member of the South African Bus Employers Association, Putco has made a contribution to the drafting of a model, "trade union" recognition as a guide for bus operators in the country.

The company provided an essential transport service to half-a-million black commuters on the Reef, in Pretoria and in the Durban areas.

"The Government controls its fares and administers a subsidy which makes up the difference between the economic fare level and that paid by the

passenger," says the brochure.

Part of this subsidy is contributed by commercial and industrial employers, many of whom depend on Putco to provide transport for their workforce.

Putco recognises the passenger as number one, caters to the needs of the workforce, rather than an elite. Ninety-four percent of Putco's drivers are black.

In addition to normal bus company operations, a professional management team copes with procedural complexities in fare increases in an inflationary and politically sensitive climate.

Referring to Putco's future plans, the brochure says that while the workforce in South Africa grows by 18 percent annually, about 50 new buses a month are added to the Putco fleet at a current cost of R70 000 each.

Concerning fare increase,

Putco says it must first apply to the local Road Transportation Board, and then allows 21 days for any objection to be lodged.

The application must be heard by either local board, or the National Transport Commission, together with any objections. This establishes what the tariff — without subsidy — should be.

However, the many procedures which the company has to undergo before the fares are actually implemented often cause delays. Putco's last application was delayed for nearly two years.

The most significant contribution the company makes to the black community is the un-economic service it operates for school children at a cost of R2.9 million per year.

The other side of the coin is free transport for old age pensioners after they receive their pensions every second month.

Everything at Bloom's!

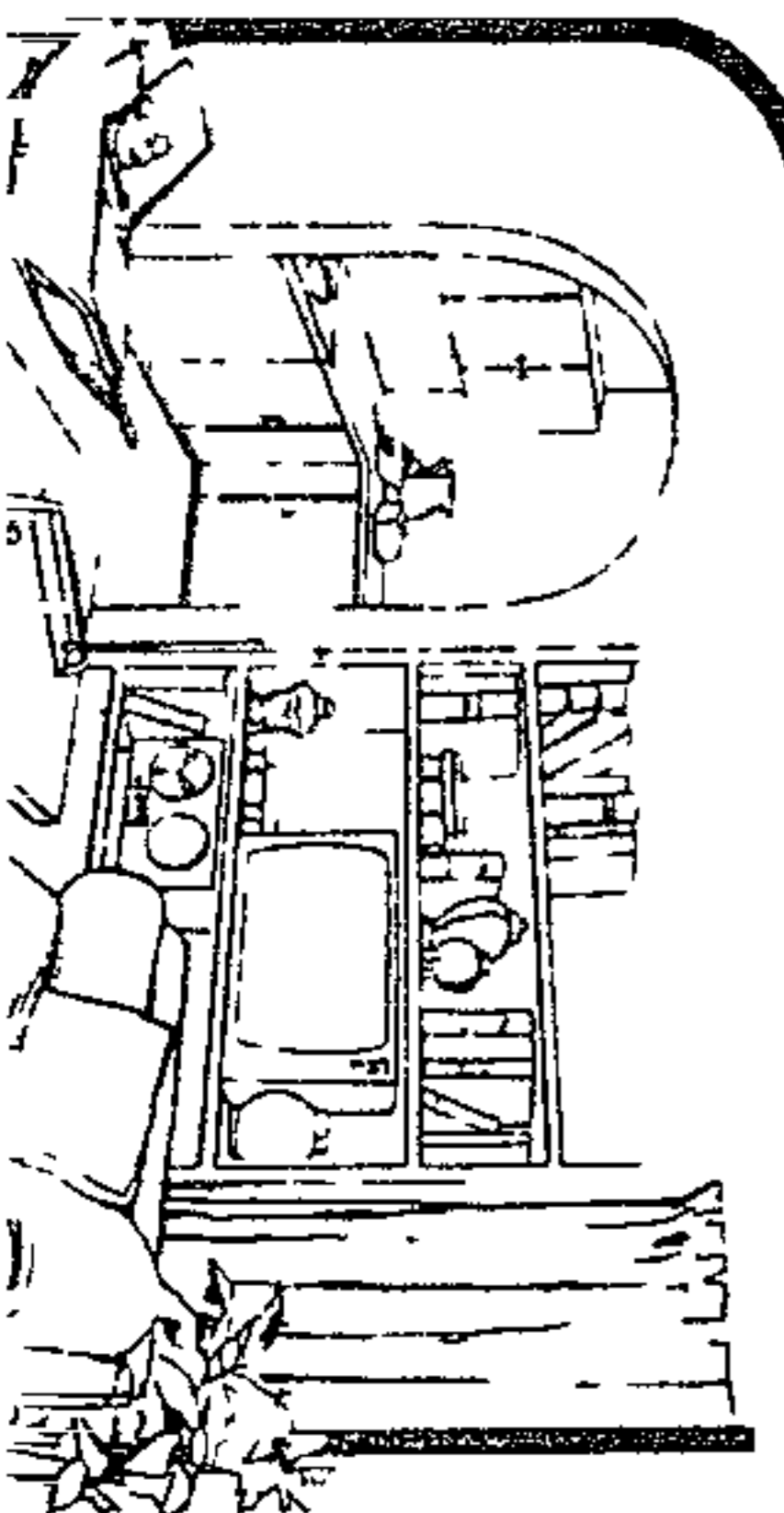

September babes keep rolling in — try your luck

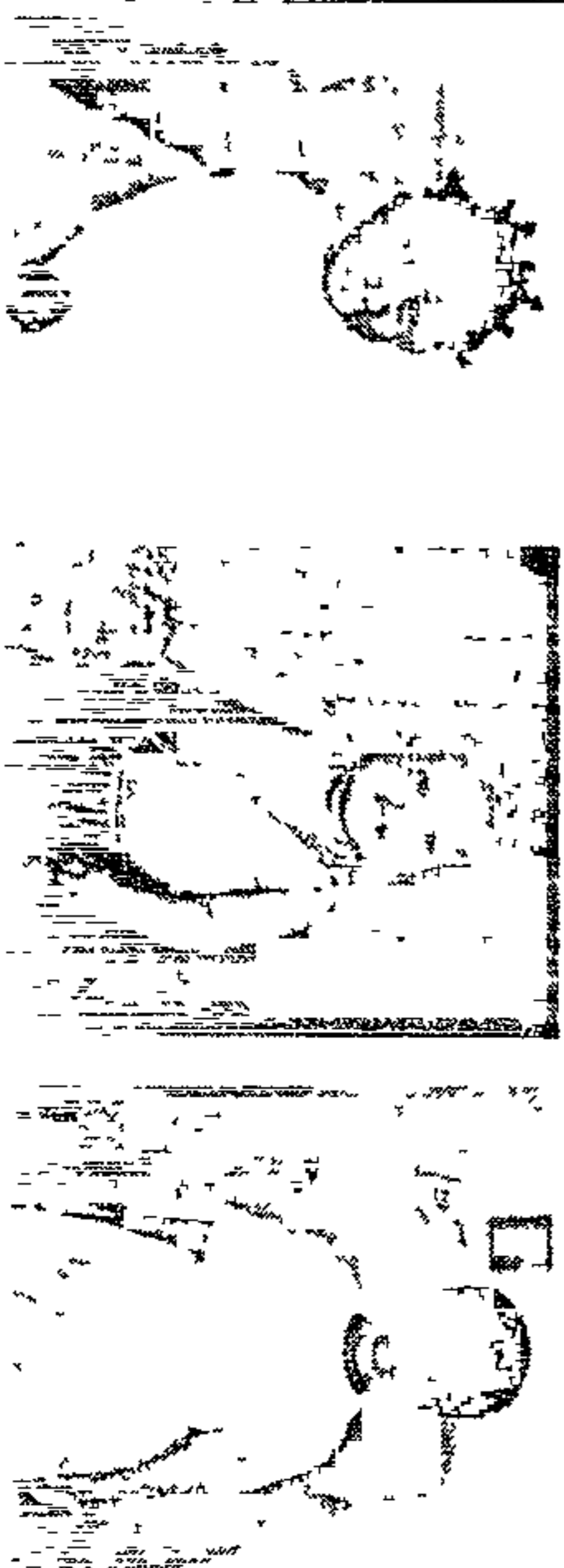

Other speakers told about 200 people that time was past when all the problems of the black people should be blamed on whites.

"We know who our enemy is and that we are fighting for the liberation of our country. But at the same time a start should be made to educate people working with the public that they should have respect.

"It is heartbreaking to see the way our elderly people are ill-treated by clerks in township manager's offices and other places. These people should know better because if they do not respect the elderly, how will other races respect us," Mr Mthembu said.

Turning to problems of the aged, he said it was high time that the community become actively involved in programmes and projects that would be of benefit to them.

He said there was no point in moaning that "the white man is oppressing us".

"I challenged the community to seriously partake in anything that will help us to uplift and liberate ourselves. The youth in particular should play a major role because no-one is going to fight our struggle," he said.

Another Azapo speaker said it was a pity that blacks were not looked after, in their retirement years, as well as other races. He

Assocom warns on power of Ministers

ARGUS 22/10/82 (20) (133) 2

Staff Reporter
PORT ELIZABETH — The Assocom congress yesterday hit out at legislation which granted arbitrary powers to Cabinet Ministers, excluding recourse to courts of law or making it difficult

The congress adopted a motion which said that in view of South Africa's

commitment to the free enterprise system and to democratic procedures, the congress urged government, in considering new legislation and reviewing existing legislation, to avoid creating arbitrary powers for Ministers and officials by the exclusion of any right, on the part of an

aggrieved party, to appeal to the courts
The motion was proposed by the Johannesburg Chamber of Commerce because of the "disturbing trend", becoming increasingly evident, of legislation granting wide discretionary powers to Cabinet Ministers, with no recourse for

reviewing decisions in a court of law

CONTRADICTION

The chamber said this was a complete contradiction of the country's free-market orientated economy and the rule of law

One piece of legislation referred to by the chamber in its motivation was the Orderly Movement of Black Persons Bill, in terms of which the removal of "unauthorised persons" may not be "interfered" with by a court of law

While the chamber believed government officials were people of "the highest integrity", they should not be placed in the invidious position of being required to be judges in their own cause

"Our courts have a deservedly high reputation for fairness and an ability to deal with a wide range of complex matters, and should, as a matter of fundamental principle, be allowed to serve their rightful function," said the chamber

5 kg capacity of laundry
10 wash programmes
one of which is pure virgin wool
3 compartment detergent drawer—
prewash ● wash fabric softener
2 different water levels to improve the results of various types of laundry
Speed spin 400 rpm

GUARANTEE

88



carpet/base floor selector

Just-full alarm

powerful 600 watt motor

attached long crevice tool for those difficult corners

88

CRICKET fans — win two air tickets to Johannesburg to see the Datsun Shield Final on February 19'

This exciting prize will include transport from Jan Smuts Airport to the Wanderers and back, two grandstand tickets, lunch in the Datsun marquee and an invitation to a cocktail party

To enter all you have to do is answer the question on the entry form about the Western Province/Boland Datsun Shield match to be played at Stellenbosch tomorrow

And as the closing date for the competition is October 30 there is time for you to read all about the match in The Argus before submitting your entry form

Win tickets to final

The two teams playing on Saturday are

Western Province Peter Kirsten (captain), Graham Gooch, Lawrence Seeff, Ken McEwan, Adrian Kuiper, Stephen Bruce, Bossie Clarke, Garth le Roux (vice-captain), Danie du Toit, John Emburey, Stephen Jefferies 12th man Eric Simons

Boland Eddie Barlow (captain), André du Toit, Kim Barnett, Peter Swart, Louis le Roux, Stephen Jones, Howie Bergins Les Kets, Sakkie Lambrechts, Pienaar Anker, Charl Coetzee 12th man C Hendrikse

RULES

● The competition closes at noon on Saturday October 30

● No photocopies of the entry form will be accepted as entries

● Entries may be posted to or placed in the entry box at C L Datsun, Merriman Avenue, Stellenbosch 7600, or dropped into the competition box in the foyer of The Argus building, 122 St George's Street

● No member of The Argus Company or Datsun and their immediate families may enter

● The judges' decision will be final and no correspondence will be entered into

● The winner will be the first correct entry drawn after October 30

The Argus

DATSUN SHIELD PLAYER OF THE MATCH COMPETITION



Name the player who you think will be the player of the match

Name

Address

.....

TEL NO

Pianos, Organs

All makes
YAMAHA
BEST BUY,
BEST PRICES
BEST SERVICE

Only at the Piano and Organ specialists



Cape Town
Golden Acre
Ph 21-4669 or 21-7705

Stellenbosch
112 — 114 Bird Street
Ph 02231-72938

1985 (13) 22/08/82

Setback for plan to curb lay-offs

By STEVEN FRIEDMAN
Labour Correspondent

PLANS by unions for a meeting between employers and worker leaders at 71 metal plants in the Witwatersrand to discuss safeguards for workers against lay-offs received a set-back yesterday when the Steel and Engineering Industries Federation said it would advise its members against attending.

The plan was launched by the Metal and Allied Workers Union (MAWU) of the Federation of SA Trade Unions.

The union has claimed that many employers in the metal industry were retrenching

workers without consulting majority unions and that many employers were laying off workers simply to cut costs.

MAWU has drawn up its own proposed retrenchment procedure and announced it was inviting employers at 71 factories, where it has members, to a meeting to negotiate an agreed procedure to safeguard workers against "unnecessary" retrenchments.

But yesterday, the director of Seifsa, Mr Sam van Coller, said Seifsa did not believe that "a meeting like this is the right direction retrench-

ment negotiations should go".

He said Seifsa believed that "substantive" retrenchment issues such as how much redundancy pay workers should get was an industry-wide matter and should be negotiated at the metal industrial council only.

But "procedural" issues such as whether companies should work short time instead of retrenching should be worked out between management and unions at company level "because of the inevitable difference between the situation of each company".

The planned meeting thus

runs counter to both criteria — firstly because it is planned outside the council and secondly because it seeks to draw up industry-wide procedures which Seifsa believes unions should take up separately with individual companies.

Metal firms are not forced to abide by this policy, but Mr Van Coller said firms who approached Seifsa for guidance would be given advice in accordance with this view.

However, a MAWU spokesman said yesterday the union was going ahead with plans for the meeting and had written to each of the companies.

Labour relations 'key area'

133

Argus 25/10/82

Staff Reporter

AS SOUTH AFRICA moved into an area of increased politicisation in the labour field it would be well of managements to convince employees that the free-enterprise system was in everyone's interests, the chairman of the LTA group, Dr Zac de Beer, said in Cape Town

Otherwise "we may find the baby of free enterprise thrown out with the bathwater of apartheid", he said

Dr de Beer told delegates at the 77th annual congress of the Building Industries Federation "It is clear that South Africa has now entered a phase through which other industrial nations have largely passed, in which the labour relations area becomes the theatre in which major social and political tensions find expression

DIGNITY

"What is seen in all trade unions is simply part of the universal struggle of mankind to rise from the status of serfdom to that of full, equal human dignity"

Managements would find an increasing amount of their time spent on industrial relations

He called on management to adapt to changing circumstances, to become a symbol of leadership rather than repression. Management should put itself in a situation where it did not merely react to unions, but interacted with them. Management should develop a participative style

BOTTOM

Dr de Beer said South Africa had a rock-bottom rating among producing countries

South Africa's GDP per economically active person in 1980, at constant 1975 prices and exchange rates, was R2 755, more than R400 below that of Portugal (The Netherlands led in a survey of seven Westernised countries with R14 036)

He laid the blame largely on inadequate black education and its effect on training the workforce

Mawu meets with employers

THE Metal and Allied Workers' Union (Mawu) claims its employer body Seifsa, is circulating letters to employers urging them not to attend a meeting with Mawu scheduled for tomorrow.

According to a statement released by Mawu, the meeting to discuss retrenchment procedures with employers will be held as planned at the D H Williams Hall in Katlehong.

The statement also said that in letters addressed to employers

Seifsa recommended that employers do not accept Mawu's invitation to negotiate on a redundancy procedure but rather handle the matter at a company level within Seifsa.

The letter added that Seifsa would be pleased to arrange a meeting of East Rand employers to discuss the matter further if its members felt the need for it and also offered to assist individual companies with difficulties they may have in this regard.

Handwritten notes:
TASA
29/10/82
132

133

Macwusa leader slams 'intimidation' of unionists

20M
Sept. 1987

By JOUBERT MALHERBE
Pretoria Bureau

THE TRANSVAAL secretary of the Motor Assemblies and Components Workers' Union of South Africa (Macwusa), has strongly criticised his arrest and that of two Macwusa organisers last Friday while they were collecting subscriptions at a Rosslyn plant near Pretoria

Mr Donsie Khumalo, the Transvaal secretary, and two organisers were arrested outside the premises of Laursen Brothers (Pty) Ltd, a member of the Steel and Engineering Industries Federation (Seifsa), while they were busy collecting contributions from Laursen employees

Yesterday Mr Khumalo asked "Is it now Seifsa policy to use the police to intimidate trade unionists?"

According to a statement issued by Mr Khumalo, he and the two organisers, Mr Zolile Mtshilwane and Mr Khorombi Dau held talks with members of the management of Laursens last Friday afternoon

After the meeting they were collecting subscriptions from Macwusa members when

they were approached by police and a member of the management who, they claim, knew who they were

The management official denied that he knew the three unionists and he allegedly told the police he did not want to see members of an unregistered union — such as Macwusa — in front of the Laursen premises

The three unionists failed to produce their pass-books on demand and police took them to the Pretoria North police station

They were later released without charges being pressed against them, but a policeman allegedly warned them that they would be arrested for trespassing if they went to Laursens again

A spokesman for Laursens confirmed yesterday that his company, a division of British Tyre and Rubber Industries, South Africa — refused to hold official discussions with Macwusa until Seifsa recognises the union

He denied that Laursens called the police last Friday, but he added that Laursens would not allow Macwusa organisers on their premises

A police spokesman yesterday confirmed the arrests of the three unionists on Friday

nom
11/11/82 (133)

Bosses boycott union meeting

Labour Correspondent

ONLY one Reef metal employer ignored a request from the influential Steel and Engineering Industries Federation (Seifsa) and attended a meeting at the weekend called by the Metal and Allied Workers Union to discuss retrenchments

The union had invited 85 East and West Rand metal companies, where it has members, to negotiate with union shop stewards on safeguards for workers against retrenchment

It charges that most of the employers have not negotiated lay-offs with majority unions or offered workers a deal which could cushion their effect

It hoped employers would negotiate a binding retrenchment procedure for all the factories

However, Seifsa advised members not to attend the meeting, arguing that detailed retrenchment procedures should be negotiated by individual companies, rather than industry-wide, because of the different problems facing companies

It also argued that industry-wide issues, such as redundancy pay, should be negotiated at the Metal Industrial Council only

Yesterday, an MAWU spokesman said only one employer had attended the meeting in Katlehong township, near Germiston. The union had agreed not to release the company's name

The spokesman added that shop stewards from 61 East and West Rand townships had attended and that the meeting had adopted several resolutions on retrenchment

Details of the resolutions would be released in a statement today, he added

The union had invited all 85 companies to the meeting by letter

In all 16 replied to the letter, all refusing to attend. Five have already negotiated retrenchment procedures with the union and said they therefore saw no purpose in attending

1
2
3
4
5
6
7
8
9
10
11
12
13
14
15
16
17
18
19
20
21
22
23
24
25
26
27
28
29
30
31
32
33
34
35
36
37
38
39
40
41
42
43
44
45
46
47
48
49
50
51
52
53
54
55
56
57
58
59
60
61
62
63
64
65
66
67
68
69
70
71
72
73
74
75
76
77
78
79
80
81
82
83
84
85
86
87
88
89
90
91
92
93
94
95
96
97
98
99
100

Employers avoided talks — metal union

By STEVEN FRIEDMAN
Labour Correspondent

THE Metal and Allied Workers Union has hit out at employers in the metal industry for staying away from a meeting where union shop stewards wanted to discuss retrenchments with them — and is to press for a new meeting on the issue.

The union has also attacked retrenchment guidelines issued by the Steel and Engineering Industries Federation (Seifsa).

In a statement yesterday, MAWU confirmed that only one employer attended the meeting — held near Germiston at the weekend — although 85 had been invited.

It said shop stewards from 61 companies had attended and had passed several resolutions including one condemning both employers and the Seifsa, which advised companies not to attend.

The union said workers had claimed that employers were "always calling for joint negotiations on matters of common interest, but were afraid to attend a meeting where they would negotiate in this way with their own employees."

MAWU said it would take up the issue again with Seifsa and press for a new retrenchment meeting, on November 27, and would also go ahead with attempts to get employers to negotiate with it on safeguards for workers' jobs.

It accused employers of using the economic downturn to take a 'hard line' and 'crack down' on unions. This meant that workers would take a "much harder line" with employers when the economy picked up.

Seifsa said it opposed the meeting because it believed retrenchment details should be worked out between workers and individual companies, not industry-wide.

The Seifsa guidelines urge employers to consider alternatives to retrenchment such as shorter working weeks, controlling overtime and not replacing workers who leave.

They warn that lay-offs have an extremely serious effect on workers.

They say employers should consider the last-in first-out principle demanded by unions but only after considering merit and the need to retain skilled workers.

The guidelines also urge employers to help workers claim unemployment insurance and find new jobs. The metal industry's industrial council bound employers to rehiring retrenched workers "where practicable" after the economy picked up.

MAWU says the guidelines "omit the major issues." It says they talk of "consultation" rather than "negotiation" — "presumably workers can talk but in the end they must agree."

SAM VAN COLLER

FM 5/1/82



133

Perils of two-tier bargaining



The FM spoke to Sam van Coller, director of the Steel and Engineering Industries Federation of SA (Seifsa)

FM: Metal industries employers face the difficult task of conducting a relationship not only with trade unions which are parties to the industrial council (IC) for the industries, but also with non-party unions. What is Seifsa's basic approach to this problem?

Van Coller: Firstly, we have to recognise that both groups of unions represent our employees, and because of this one wants to achieve a healthy relationship with both. Secondly, we continue to support the IC because we believe it offers the best solutions in the long term. At the same time we want to work towards that IC being representative.

When one is faced with conflicting demands, one has to avoid acting in an arbitrary manner. One must consider what is sound in terms of industrial relations, and what employers consider to be fair and equitable, even if people on the other side of the table might disagree.

A number of changes to the IC are being considered. There are reports that one of these might allow employers to grant a limited form of recognition to unions at plant level. What are the implications of this?

I must stress that the proposals have not been approved yet. We will get the party union response in November. Limited recognition is not a term we have used. What we are talking about are procedural agreements that companies may sign with trade unions — preferably all the unions in their plant. Such agreements may then be lodged with the IC for administration purposes and this would give them greater status within the IC system. They can deal with issues such as the accreditation of shop stewards, joint consultation, resolution of grievances, and discipline.

Do you think the proposed changes will have a significant effect on efforts to attract non-party unions into the IC system?

They are not intended to do that. I

think the media have placed the emphasis on the wrong area. Far more important than the proposed procedural agreements are the dispute settlement procedures. We believe that side of the draft is particularly important because our dispute settlement procedure was designed during the early days of ICs for disputes between the parties.

But disputes are now arising at company level and access to the official dispute settlement machinery has to be via the IC. As a result, even if the non-party unions do not support the IC they have found it necessary to bring certain of their disputes to it. We from our side found it very difficult to follow the old procedure for this kind of dispute, and we therefore think that it is in this area that the proposals stand to play a very constructive role.

What is your response to complaints by some union leaders that the IC for the metal industries is too large, and covers too many companies and too many workers doing a wide variety of jobs?

Certainly it is large and has a diversity of interests. But there are a number of points to bear in mind. One is that these diverse interests are often inter-linked and it would be very difficult to separate them.

Secondly, within the council a good deal of activity does take place on a decentralised basis. For example, the regional councils essentially administer the agreements. The technical committees are specific to industry sectors and are handling problems in their sectors. The negotiation of the technical schedules, the job structures, takes place on an industry sector basis.

In addition to the main agreement, we also have a number of industry sector agreements and we have a certain number of house agreements. There is much more flexibility in the system than some people make out. However, wage negotiations do, largely speaking, still take place on a centralised basis.

Why does Seifsa oppose supplementary wage negotiations at plant level?

We believe this is unwise for many reasons. Basically we do not believe you can sustain formal collective bargaining at two levels, because one of them will become irrelevant. Employers have as-

sociated with each other for collective bargaining because it is in their interests to do so. One increasingly sees signs of non-party unions realising the need to operate on a wider basis. Fosatu shop stewards' meetings on the East Rand are a manifestation of this. It is almost a natural evolutionary pattern. Seifsa must obviously be concerned about retrenchments.

Yes, we are. Managements are having to take difficult decisions. Obviously your first priority is to ensure that your business survives. But equally one wants to ensure that management/employee relationships remain as sound as possible through such difficult times.

I think there has been a major effort by employers to avoid retrenchments, but this downturn has hit us far more dramatically than the previous one did. People in this country don't realise how serious the difficulties in the steel industry, worldwide, are. This does have an impact on us and we have to guard against our industry being so overmanned that it is not competitive. What is your reaction to claims by some unionists that certain employers are shedding surplus labour through selective rehiring after strikes?

While this is certainly not an approach that one wants to see encouraged, one also does not want to see workers just taking strike action. If employers were to use lockouts because they were not achieving the response from employees that they wanted, that would anger workers. One must therefore realise that workers who take precipitate industrial action are bound to get a negative response from an employer. But of course if people go on strike in a downturn they are even more vulnerable to losing their jobs.

Does training remain a priority?

Much effort is going into training in a number of areas with the co-operation of the established unions. Possibly the most important area at the moment is the establishment of industry-level apprentice training centres. The first one will face the problem of coming on stream in a recession year, when everyone is trying to cut back on training. But we are still going ahead because it is such an important project.

Sowetan
5/11/82

Few attend metal union talks

THE Metal and Allied Workers' Union (Mawu) this week condemned employers and Seifsa for refusing to attend a meeting with the union to discuss retrenchment procedures last weekend.

The meeting, which was called by the union's Transvaal branch, was held at the D H Wilhams Hall in Katlehong on Saturday. It was attended by representatives of the union in 61 companies on the East Rand and by observers representing members from the Vaal and West Rand areas.

Only one employer, out of 85 invited, attended the meeting. Other companies either replied that they had already negotiated with the union on the subject or that they were unable to attend. Mawu condemned this action and pointed out that employers were always calling for joint negotiations on matters of common interest, but were afraid to attend a meeting where they would negotiate in this way with their own employees.

The meeting noted that employers were being hypocritical. They refused to negotiate in a meeting with representatives from organised factories. Instead they referred the matter to the Industrial Council which only represented a minority of workers.

East Rand employees often meet as a group through Seifsa to discuss problems. Seifsa has offered to call such a meeting on retrenchment yet employers claim they cannot negotiate as an East Rand group.

The meeting resolved

- to condemn employers for not attending the meeting
- to condemn Seifsa for interfering. This could cause conflict between employers and their employees.
- to condemn both employers and Seifsa for being afraid of democratic negotiations,
- all Mawu members should continue to press their employers to accept Mawu's retrenchment procedure,
- workers should press their employers to attend another meeting on November 27

Sour aftertaste to sugar strike

Tribune Reporter

MORE than a hundred people working in Natal sugar mills lost their jobs this week because they say they are not getting enough to eat.

The issue which drew more than three thousand people who work in the mills and live in company hostels out on strike last weekend centred on the way hostel-dwellers were being fed and the amount spent on food for each worker.

For years their employers have provided two meals a day for them in hostel canteens, spending R30 a month on food for each of worker.

Said Glyn Taylor, chairman of the Sugar Manufacturing and Refining Employers' Association "There is nothing wrong with the food and they are adequately fed."

But about three months ago the workers,

represented by the National Union of Sugar Refining and Manufacturing Employees, decided they would prefer to buy and cook the food themselves. They asked their employers to give them R107-a-month food allowance.

According to the union's general secretary, Selby Nsibande, this figure had been carefully worked out by totalling up the cost of food items a man would buy each month.

The food allowance has been the subject of negotiation between the union and the employers for the past three months. Last Friday they finally reached deadlock at an industrial council meeting when the employers' offered a food allowance of R40 a month.

"We have no objection if they want to cook the food themselves, although there are no facilities in the hostels. But

there is no way we can afford to raise the allowance by more than R10.

"You can't look at these things in isolation. As recently as April they got a raise of 20 percent in their pay packets," said Mr Taylor.

But last weekend more than 3 000 people working at various mills in Natal stopped work. A few hundred returned to work on Monday and on Tuesday the remainder — those employed by the Tongaat-Hulett's group — were given an ultimatum to return to work or face dismissal. On Thursday about 1 200 workers were paid off.

On Friday the employers were waiting for the union to return to the negotiating table, the union took legal advice and some workers were selectively re-employed. According to a reliable source, about 160 people

employed by the Tongaat-Hulett's organisation have lost their jobs.

Summing up the week's events from the employers' point of view Mr Taylor said: "No-one is ever happy with strikes. They are disruptive not only to production but to industrial relations as well."

"The union should have seen the negotiation process through. This issue has been on the table for two or three months. It is therefore surprising to wake up one morning and find they're out on strike. We believe the negotiating process must be followed."

Mr Nsibande had little time for the Press this week. The wildcat strikes involved his members at six different mills and he was hard pressed to keep tabs on all of them.

When the Sunday Tribune tried to speak to him he said he was too busy.

MD calls for law on 'equal amenities'

Cape Times 8/18/82

Cape Times 8/18/82

133

Staff Reporter

FAR-REACHING changes in labour relations have been recommended to the Community Relations Committee of the President's Council by Mr P E Streicher, managing director of SA Manganese Amcor

In a report released last week on submissions which he made to the committee on Monday, Mr Streicher, also a member of the Mineral Advice Committee of the Department of Mineral and Energy Affairs, said most South Africans favoured peaceful change

"If the politicians carry out their promises we will

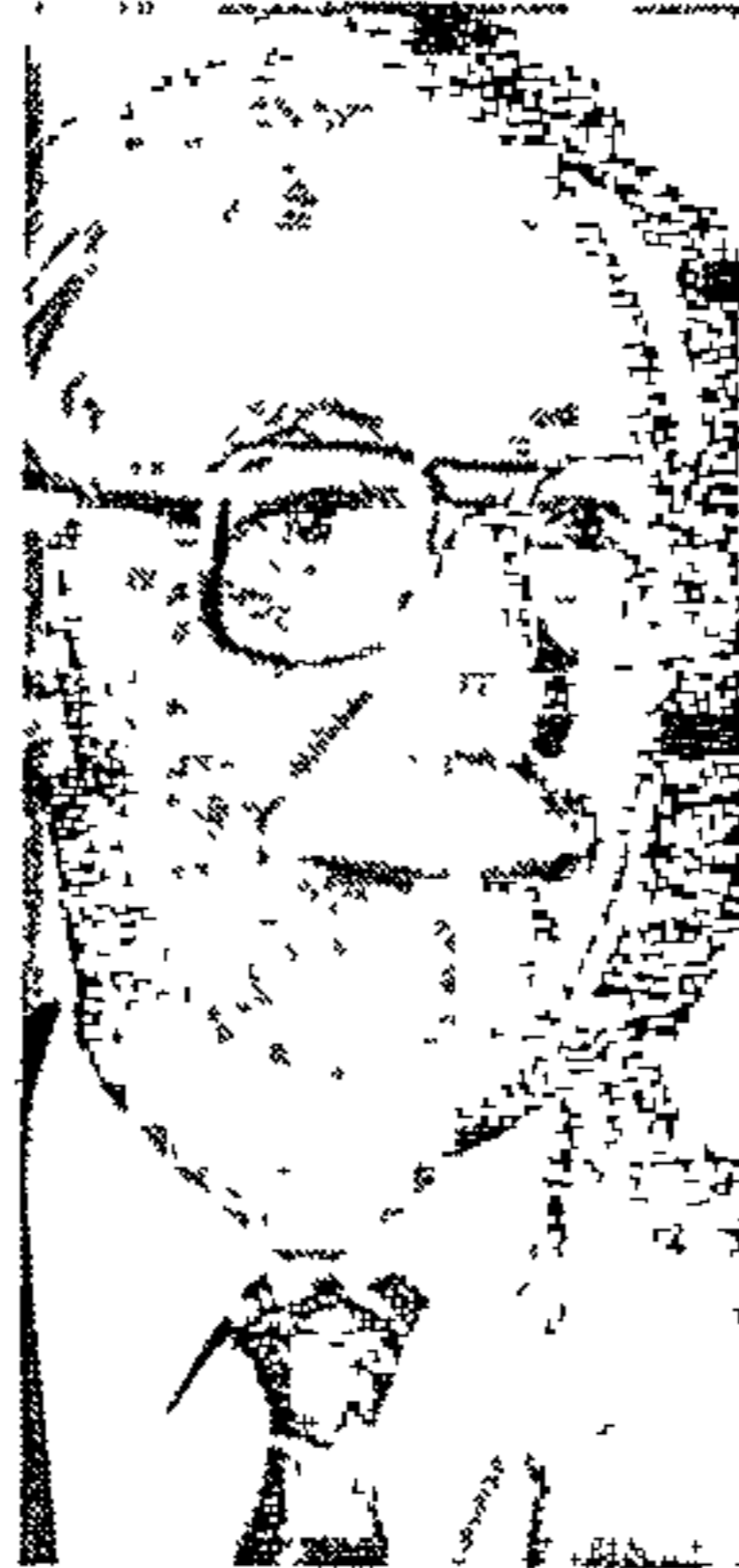

Mr P E Streicher

do our share in the industry," he said

"We appreciate that the bureaucratic system is slow-moving, but state officials are not receiving clear guidelines which in the short term may not be politically convenient but in the long run will improve labour relations"

He called for workers on the same grade to be granted access to the same amenities, otherwise labour relations would be undermined. Laws on separate amenities should be replaced by laws on equal amenities, he said

"It cannot be over-emphasized that the business leader must gain his workers' confidence by accepting their right to negotiate industrial differences, their right to legal strikes, promotion based on merit, equal pay for equal work, training and security benefits. This will put the manager in the position of a change agent"

He said that pass laws and influx control were "hard to justify" as they were seen as the infringement of the individual's freedom

"But I believe that some sort of influx control should be negotiated with the black local authorities. I also believe that the worker has the right to belong to the trade union of his choice. If businesses maintain an honest and open relationship with the union it can only be beneficial to labour relations"

Shift in emphasis

Mr Streicher criticized the education system, saying it had to shift its emphasis from differences among people (andersheid) to their equality (eendersheid). Educational standards and facilities had to be equal for all races

"While our educational establishments are producing academics we need technicians

"Technical schools and technikons should get much more support and vocational education must be instituted as soon as possible. To achieve this there must be much closer liaison between educational institutions and industry"

He said it was a "miracle" that there were "so few" strikes in South Africa

"Free enterprise is a foreign concept in our education system. Concepts such as labour costs, mechanization and long-term profits are foreign concepts to trade union officials and Greek to members"

ARGUS, TUESDAY NOVEMBER 9 1982

Chamber warns of 'politics'

Consumer Reporter

ARGUS 9/11/82

153

11/18/82

SOME strikes and disputes in the past year appear to have had some political motivation, the executive committee of the Cape Chamber of Industries says in its annual report

The chamber points out that levels of productivity in this country are comparatively low, and that unemployment is likely to rise because of the downturn in the economy

It warns that because of these factors it is increasingly important that industrial disputes be resolved without strike action which is harmful to both sides

Strife

A particularly regrettable feature of some strikes during the past year was that "they related to disputes over matters for which the companies concerned were not responsible and over which they had little or no control"

In some cases the disputes involved inter-trade union strife

"This has become increasingly evident with the emergence of new unions in recent times," the report says

"There have also been indications of political motivation underlying some of the action taken against employers

"Such disputes are accordingly more difficult to resolve than straightforward differences between management and labour on issues such as wages, hours of work and general conditions of employment

"With the economy already experiencing the initial indications of a cyclical downswing and with unemployment rising, it has become increasingly important that industrial conflict should be resolved by way of orderly negotiations between the parties, using the processes of conciliation available to them"

The report says the chamber is doing its best to promote sound em-

ployer-employee relations at all levels

It is doing this by issuing guidelines to member firms and by arranging for them to exchange information about their experiences

Its policy of encouraging the resolution of conflict through conciliation will be expanded during the coming year

● See page 19.

(or Supplied)

Ceteris Paribus
Price
Function
Inferior Goods
Substitutes
Complements
Perfect Competition
'Rise' in
'Increase'
Equilibrium
Maximum Profit
Minimum Profit
Rent Control
Minimum Wage
Inflation
International
Transport
Tariff
Economic Re-

New deal provides ^{merely} big increases for ^{9/11/82} clothing workers

Labour Reporter

MORE than 40 000 clothing workers will receive wage increases of up to 96 percent in terms of an agreement signed by the Natal Industrial Council for the Clothing Industry yesterday

The agreement, signed by the Tucsa-affiliated Garment Workers' Industrial Union and the Natal Clothing Manufacturers' Association, replaces the old agreement which was due to expire at the end of this year

It covers all clothing factories in the magisterial districts of Durban, Pinetown, Pietermaritzburg, Inanda and the lower Tugela

Women, who constitute the majority of employees in the industry, will receive substantially higher wage hikes than their male colleagues due to the removal of sex discrimination in the wage agreement

Qualified female clerks, who up to now have been paid R39,25 a week, will shoot up to R70 at the beginning of next year and then up to R77 in 1984 — a total increase of 96 percent

The wages of male clerks accordingly will rise to R77 over the period of two years from R59,60 — an increase of 37 percent

Skilled machine operators and pressers will have their wages increased to R55 over the two years. This will mean an increase of 52 percent for women and 30 percent for men

EAST LONDON — The Da Gama Textile Company is to lay off 1 368 workers at its East London and King William's Town plants.

At the same time, the Textile Manufacturers' Federation (Texfed) has warned the government that 10 500 jobs will be lost nationwide between now and the new year. It points out further that all major companies are closing for four to five weeks over Christmas.

In the case of Da Gama, most of the retrenchments are at King William's Town — 1 100 weekly paid workers and 65 monthly paid staff. At East London the figures are 179 weekly paid and 24 monthly paid employees.

All will end their employment with Da Gama on December 10, when the company closes down — a week earlier than usual — for Christmas.

A statement issued by the managing director of Da Gama, Mr Casey B Joesse, says the retrenchment has been made inevitable by the continuing decline in the volume of orders, reduced profit margins and a generally depressed future outlook.

The statement says the company regrets making a decision of such gravity for many loyal employees.

"However," it con-

tinues, "the current state of the economy, future outlook and recent trading results have made it necessary to abandon our policy on retrenchments in order to safeguard the financial position and future of the company."

By TOM LOUW
Business editor

Texfed is putting to the government a case for action to curb the inflow of cheap textile imports, mostly from the Far East.

It points out that demand at retail level is still good. It is two per cent up on last year, which makes it roughly 28 per cent higher than the 1976-79 plateau.

At the same time, order books of local textile manufacturers are down by 39 per cent.

The reason for this is cheaper imported fabrics. In the first six months of the year, imports of worsted fabrics were up 40 per cent, cottons up 13 per cent, and polyester cotton imports up 22 per cent.

Mr Joesse put the point plainly yesterday: "External trade is all

very well, but why should we help give a textile worker in Taiwan or Hong Kong wages to take home, when our own people are being thrown out of work altogether?"

The Mayor of King William's Town, Mr Eric Weyer, said he was "deeply concerned" at the number of lay-offs at Da Gama's King William's Town plant.

"We are going to keep a close watch on this situation," he said. "We are all very concerned at the unemployment in this area."

A spokesman for Ciskei's Department of Manpower Utilisation said a statement on the retrenchments may be issued today.

Our Durban correspondent reports that Romatex is not likely to make any "meaningful new investment" in the fabrics sector until the government clarifies its policy on protection for the industry.

Chairman Mr Jack Ward said in the annual report the compulsion to buy local raw materials at high prices and the widening gap between local wage rates and those in the competing developing countries were their main problems.

The Tongaat Hulett group has been hammered by declining world sugar prices and the crisis facing the local textile industry.

The group has reported half year earnings 115 per cent down on the pro-forma result of both groups a year ago.

Its textiles division has "experienced extremely difficult trading conditions in recent months and will not reach the same level of earnings as last year."

In another development, Iscor has announced it is to lay off 1 500 workers — almost all of them unskilled labourers — within the next few months.

More retrenchments could be due if Iscor's position continues to worsen, the corporation announced last night.

Paper No 1

(to be copied from the heading on the Examination

NOTE CAREFULLY

- 1 Enter at the top of the block on the question you are asked. Blue or black ink answers. The use of a red or green underlining, which pencil may also be used.
- 2 Names must be printed on each separate sheet (e.g. graph paper) where sheets additional to examination book(s) are used.
- 3 Do not write in the left hand margin.

Iscor's managing director, Mr F P Kotzee, said the corporation's Newcastle steelworks and its Sishen iron ore mine would be the worst affected.

Mr Kotzee noted that "owing to the slackness in the domestic and overseas steel markets" Iscor had been forced to decommission some of its production units.

Bleak job prospects.
Page 6

Any dishonesty will render the candidate liable to disqualification and University

1 368 jobs lost in textile plants

*D. B. ...
18/11/82*



Rbm 26/1/82

Question

(133) (488A) (388) (88)

a)

What the process is against affording them a mess a double

The may so through example an emy that pe that th

By STEVEN FRIEDMAN
Labour Correspondent

Mawu suffers talks setback

A MEETING planned by the Metal and Allied Workers' Union to try to get about 70 Rand employers to discuss retrenchment procedures with worker leaders may be postponed - only four employers have agreed to attend.

Mawu had invited employers to a meeting tomorrow with union shop stewards at their factories Mawu claims that most metal employers have not been willing to negotiate on retrenchments

This follows an earlier meeting with the same aim, called by the union in October After the Steel and Engineering Industries Federation of SA (Seifsa) urged employers not to attend, arguing that this was not the correct forum to discuss the issue, only one employer attended

After that meeting, Mawu accused employers of being "afraid to face their workers" and said it was calling another meeting this month

Yesterday, Mawu's general-secretary, Mr David Sibabe said the union's office-bearers were due to meet last night to discuss postponing the meeting

"Most employers have once again refused to attend and there is a feeling that perhaps we should wait until next year before trying to hold another meeting."

He said many employers had written to say they did not believe a general meeting was an appropriate forum to negotiate on retrenchments

According to Mawu sources, only four companies have agreed to take part in the meeting, but they refused to reveal their names

Seifsa's director, Mr Sam van Coller, confirmed yesterday his organisation's attitude to the meeting was the same as it had been to the first one

Seifsa's view is that issues such as redundancy pay should be dealt with at the metal industrial council level only and that detailed retrenchment procedures should be negotiated by individual companies and unions, not industry-wide, because each company faced different problems

obs colour bar is jobs for particular discrimination rights that are as but not to ther be seen as governed to maintain

Bar is enforced in practices. For shop agreement a person if a trade union in agreement

with. In this way Blacks are prevented from holding skilled jobs. The Wiehahn Commission recommended that the closed shop agreement be done away with but the government did not accept this proposals. This proved to be one of the major failings of the Wiehahn Commission.

A second way that trade unions protect their members from competition is through Industrial Council Agreements. For example, a master craftsman (white) is only allowed to have a maximum of 4 assistants (black) In this way the ratio of skilled worker to unskilled is kept to a minimum. The Wiehahn Commission did not

Rbm 26/11/82

(133)

~~1420~~

~~1421~~

~~1422~~

By STEVEN FRIEDMAN
Labour Correspondent

A MEETING planned by the Metal and Allied Workers' Union to try to get about 70 Rand employers to discuss retrenchment procedures with worker leaders may be postponed — only four employers have agreed to attend

Mawu had invited employers to a meeting tomorrow with union shop stewards at their factories. Mawu claims that most metal employers have not been willing to negotiate on retrenchments.

This follows an earlier meeting with the same aim, called by the union in October. After the Steel and Engineering Industries Federation of SA (Seifsa) urged employers not to attend, arguing that this was not the correct forum to discuss the issue, only one employer attended.

After that meeting, Mawu accused employers of being "afraid to face their workers" and said it was calling another meeting this month.

Yesterday, Mawu's general-secretary, Mr David Sibabe, said the union's office-bearers were due to meet last night to discuss postponing the meeting.

"Most employers have once again refused to attend and there is a feeling that perhaps we should wait until next year before trying to hold another meeting."

Mawu suffers talks setback

He said many employers had written to say they did not believe a general meeting was an appropriate forum to negotiate on retrenchments.

According to Mawu sources, only four companies have agreed to take part in the meeting, but they refused to reveal their names.

Seifsa's director, Mr Sam van Coller, confirmed yesterday his organisation's attitude to the meeting was the same as it had been to the first one.

Seifsa's view is that issues such as redundancy pay should be dealt with at the metal industrial council level only and that detailed retrenchment procedures should be negotiated by individual companies and unions, not industry-wide, because each company faced different problems.

not abolish

The Wiehahn job reservation
5 remaining
What will
at present
non-existent
is above
that Blacks
Whites for
the job
opposed to
of statute
The good
it will
labour
seen in

By STEVEN FRIEDMAN
Labour Correspondent

A MEETING planned by the Metal and Allied Workers' Union to try to get about 70 Rand employers to discuss retrenchment procedures with worker leaders may be postponed - only four employers have agreed to attend

Mawu had invited employers to a meeting tomorrow with union shop stewards at their factories Mawu claims that most metal employers have not been willing to negotiate on retrenchments

This follows an earlier meeting with the same aim, called by the union in October. After the Steel and Engineering Industries Federation of SA (Seifsa) urged employers not to attend, arguing that this was not the correct forum to discuss the issue, only one employer attended

After that meeting, Mawu accused employers of being "afraid to face their workers" and said it was calling another meeting this month

Yesterday, Mawu's general-secretary, Mr David Sibabe, said the union's office-bearers were due to meet last night to discuss postponing the meeting.

"Most employers have once again refused to attend and there is a feeling that perhaps we should wait until next year before trying to hold another meeting."

133
RBM 26/11/82
Mawu suffers talks setback

He said many employers had written to say they did not believe a general meeting was an appropriate forum to negotiate on retrenchments

According to Mawu sources only four companies have agreed to take part in the meeting, but they refused to reveal their names

Seifsa's director Mr Sam van Collier confirmed yesterday his organisation's attitude to the meeting was the same as it had been to the first one

Seifsa's view is that issues such as redundancy pay should be dealt with at the metal industrial council level only and that detailed retrenchment procedures should be negotiated by individual companies and unions not industry wide, because each company faced different problems

statutory
Only the
remains
with Africa
virtually
movement
a part is
serve for
h man does
godworker as
abolition
example of
Commission
age in the
not be
at job

reservation abolition together with the closed shop agreement and then consider the consequences

An important played by both the Wiehahn and the Rickett Commission is to make the public and employers more aware of the rights of the African. In the past, customary racial bigotry has been played a large part in the implementation of the Industrial Colour Bar, and with the publicity afforded to these 2 documents, it is hoped that in the future there will be less ignorance of the law. & Africans should first know their rights

SOUTH AFRICA YESTERDAY

Temperatures at 14h00

	°C	Jan Smuts	°C	Potchefstroom	°C
Town	30	26	26	21	1
...	27	Nelapruit	25	Pratoria	29
...	25	Pietersburg	23	Skukuza	30,4
...	24	Port Elizabeth	23	Standerton	24

AFRICA Hottest at 14h00: Vredendal 38°C Coldest at 08h00: Suther-

Hotest at 14h00: Rustenburg 31,2°C Coldest at 08h00: Stan-

THE WORLD YESTERDAY

Area	Min °C	Max °C	Weather
...	0	3	Clear
...	12	18	Cloudy
...	1	5	Cloudy
...	2	7	Cloudy
Alrea	18	25	Cloudy
...	5	14	Rain
Kong	16	21	Clear
...	5	14	Clear
...	7	17	Clear
...	3	8	Cloudy
...	14	17	Clear
...	-2	9	Cloudy
...	25	27	Clear
...	0	1	Rain
...	-3	3	Clear
urk	7	14	Cloudy
...	2	6	Cloudy
Janeiro	20	35	Clear
...	9	14	Rain
...	9	13	Cloudy
...	-4	1	Clear

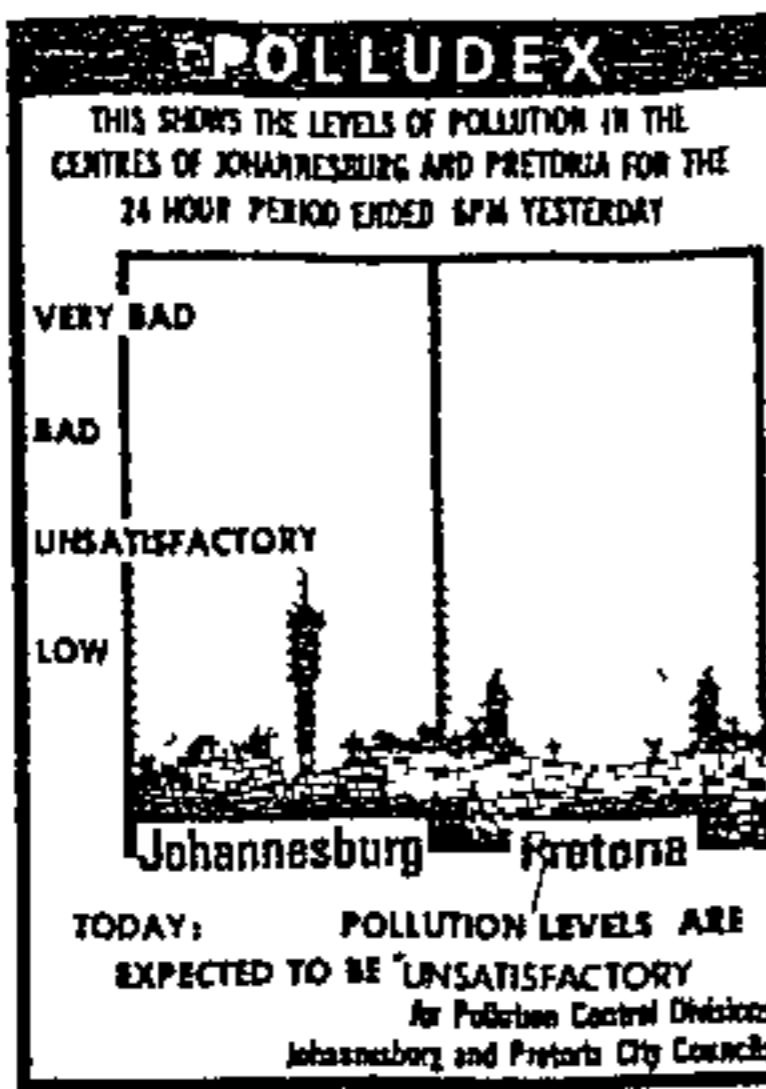

...to a large extent the man was described as being in his early 50s overalls Anyone with information should contact the Jeppe police at 618-4931

New deal for 125 000 workers

By STEVEN FRIEDMAN
Labour Correspondent

FOR the first time, all 125 000 workers in the civil engineering industry throughout the country — except black "homelands" — are protected by a wage order which lays down legally-binding standards for their work conditions.

And labourers in the "white" rural areas, who have never before been covered by minimum wage regulations, enjoy this protection for the first time. They now cannot be paid less than 55c an hour.

This follows a Government wage order which extends standards covering hours of work, overtime, sick pay and other conditions for civil engineering workers in most

"white" areas to several rural areas for the first time.

The order was introduced at the request of the industry's employer association, the SA Federation of Civil Engineering Contractors (Safcec).

In a statement, Safcec welcomed the order and said it meant that "the industry is ahead of many others where industrial council agreements or other wage measures apply only in certain areas and by far the greater part of the country is not covered".

Its director, Mr Kees Lagaay, said yesterday it was difficult to estimate how many workers would enjoy statutory protection for the first time as a result of the order but suggested it could

be in the region of 25%

Safcec concedes the 55c minimum pay for labourers — who are the only workers in the rural areas covered by the new order who now enjoy minimum wage protection — was "moderate".

But Mr Lagaay said it was the industry's practice to introduce low minimum rates in areas where wage orders had just been introduced and then to start raising minimum pay. He said some employers in these areas already paid more than the minimum, but some did pay less.

In the four main industrial areas — the Witwatersrand, Cape Town, Port Elizabeth and Durban — the minimum rate for labourers is R1,01 an hour.

HAMRAD HAMRAD



INSTALL THE MAJOR HOUSE ALARM SYSTEM AND SAVE A FORTUNE!!!

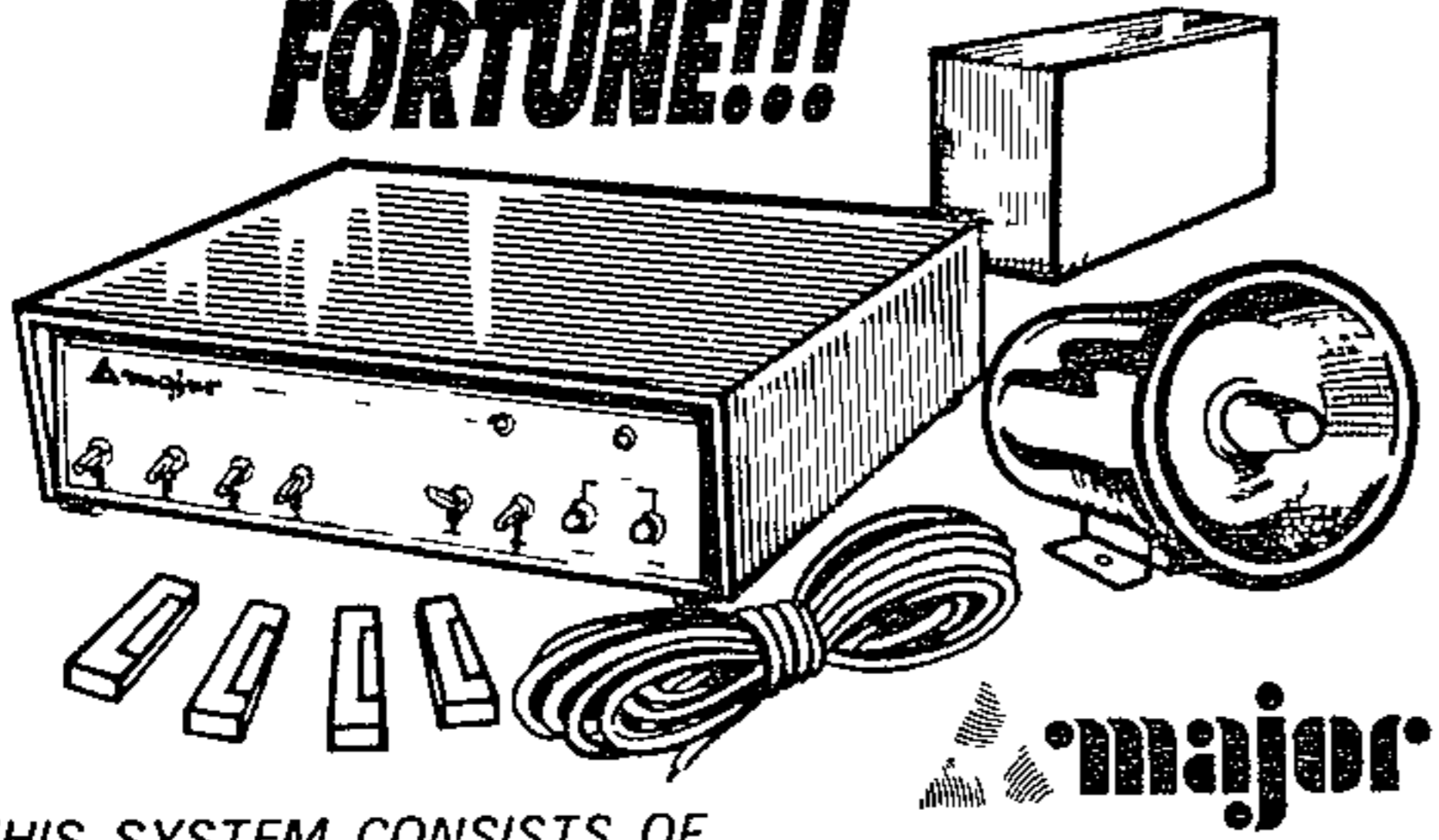

- THIS SYSTEM CONSISTS OF
- MAIN CONTROL UNIT R99,95
- MAGNETIC SWITCHES R2,30 EACH
- VIBRATION SWITCHES R3,30 EACH
- KEY SWITCHES R9,40 EACH
- SIRENS FROM R21 — R54,00
- WIRE 10c per metre

MAINS OR BATTERY OR BOTH — NORMAL 12V CAR BATTERY, WHEN ON MAINS — WILL THEN CHARGE BATTERY AUTOMATICALLY.

THIS SYSTEM WORKS OFF YOUR POWER SUPPLY YET CONTINUES OPERATING DURING A POWER BREAK, FROM THE BATTERY PACK (WHICH IS AUTOMATICALLY RECHARGED WHEN THE POWER IS RECONNECTED) FULL INSTALLATION INSTRUCTIONS ATTACHED

CONTACT HAMRAD FOR FURTHER DETAILS
PRICES EXCLUDE GST

114 BUITENGRACHT ST
CAPE TOWN
TEL 43 5264
45 3601

HAMRAD

J. ESKAF & CO (PTY) LTD

Suppliers to the trade of

WALL-TO-WALL CARPETING

Quality imported
rugs and carpets

159 Commissioner Street
Johannesburg
Phone 28-2836

By Lucille McNamara

The Association of Chambers of Commerce of South Africa has called for some form of common citizenship for all people in Southern Africa

It has also called on the Government to spell out clearly in legislation the broad rights to citizenship to give effect to proposals for a new constitutional structure

Certain basic personal rights relating to freedom of economic performance had to be taken into account and given constitutional endorsement. These included the rights to

- Own property
- Contract freely with any person
- Reside or conduct business or engage in employment at any place

Assocom's call on citizenship

and basic rights

● Organise or belong to voluntary organisations such as recognised trade unions, federations and associations.

● Reasonable political expression

"Assocom believes that if all persons concerned in the South African economy can be given goals based on economic ideals, political goals will be easier to achieve"

TRAINING

Assocom said it was essential for the country to retain and to be seen to support a free and strongly independent judiciary, which should be strengthened and expanded rather than weakened by excessive legislation

Education and training for all was essential for the establishment of an informed society able to make sound political judgments and evaluations

For this reason the Government should commit itself to granting citizens equal access to education and to the support of educational institutions at all levels

Assocom was critical of constitutional proposals which would give an Executive President strong centralised powers. These, it felt, had to be controlled to

curb excessive use or abuse of executive power

There should be a clearly formulated means of removing the Executive President from power and his proposed seven years in office should be pruned to a five-year term

SCEPTICAL

"The constitution should provide that the Executive President is not exempt from criticism in his role as Chief Executive and as a politician
"It should be made clear that the Execu-

tive President is in no special position of privilege in relation to the law of the land or in parliamentary procedures."

Assocom was sceptical of the effectiveness of separate white, coloured and Indian legislative assemblies to handle new legislation efficiently.

CUMBERSOME

"There is nothing to prevent a particular Parliament from failing to reach a decision on a Bill for joint consideration and, because of the cumbersome

procedure envisaged, it can only be foreseen that the legislative process will become more protracted than at present"

It pointed out that if the Parliaments did not function properly it was likely that the Executive President would have to assume more powers which would be detrimental to the community

TRADITIONAL

Another point made by Assocom was that consultation between all levels of Government and the governed would become of greater importance in future to avoid confrontation along ethnic or traditional divisions. It believed that

greater use should be made of public referendums to gauge support on certain broad directions of Government policy or on important issues. In appropriate circumstances referendums could also resolve deadlocks in the Houses of Parliament

OUTMODED

Referring to proposals for change at local government level, Assocom favoured the abolition of provincial government systems which it felt were outmoded

All local authorities, regardless of the colour of their inhabitants, should be subject to a common form of control, either by a central Government department or a common higher metropolitan or regional authority, on matters of planning, land use and urban transportation

133
Stew 14/12/82
11
2041
(0,1226 + 0,1503)
(0,0923)(0,1226)

Assocom calls for common citizenship

CAPK TOMLS 14/12/82

20441
133

Political Correspondent

THE Association of Chambers of Commerce (Assocom) has urged the government to ensure that common citizenship and labour mobility for all races are enshrined in any new constitution

Assocom also endorsed the call for a government statement of intent about further constitutional development for black people, and said this should be preceded by a clear ruling on citizenship rights

Assocom has released a 22-page report on how organized commerce and industry views the President's Council proposals for constitutional change. The report, submitted to the government last month, contains strong pleas for the free enterprise system and the involvement of businessmen in evolving new constitutional structures

The report said citizenship was a sensitive and unresolved issue, and many people did not want to lose their South African citizenship rights. It urged common citizenship, possibly on a confederal basis, for all those who would have been eligible for these rights within South Africa's original borders.

Assocom also set out "basic rights" which it said should be given constitutional endorsement. These included the right to own property, to contract freely with any person regardless of race, colour or creed, to organize or belong to recognized unions and the right to reasonable political expression

The report said the right to live, work or conduct business in any area should be subject only "to the reasonable requirements of public health, safety or amenity"

Mr Raymond Parsons, Assocom's chief executive, said in a statement that Assocom believed national and local political structures should be changed from the Westminster system to one more appropriate for South African circumstances but embodying democratic safeguards

"Political and constitutional change must be handled in such a way as to sustain business and investment confidence. Economic progress and political stability are interdependent," he said

With some reservations, the report gave general support to proposals for local local government reform. Proposed changes at central government level were looked at from a business rather than a political viewpoint

In a free enterprise, market-orientated system, the social goals of stability, peace, security, full employment and a just society were inextricably linked to economic advancement

Judiciary

Assocom also appealed for a strengthened and independent judiciary, and said the powers of the executive president had to be controlled to curb excessive use or abuse of executive power

Criticizing the proposed parliamentary procedure as "drawn out and cumbersome", it foresaw difficulties for organizations trying to put their views on legislation when measures would be dealt with by three separate parliamentary chambers and the President's Council

Assocom urged time limits on the passage of some legislation, more joint sittings of the three chambers and for public comment on a bill to be published when comment had been invited.

Staw 17/12/82 (133)

Employers irate over pay

A row has broken out in the Transvaal chemical industry with some employers up in arms over recently gazetted minimum wage increases for workers.

The "rebel" employers have condemned the industry's employer body, the Transvaal Chemical Manufacturers Association, for the increases.

A group of these employers met in Johannesburg this week to co-ordinate their opposition to the TCMA.

Employers at the meeting said they disapproved of the way the TCMA had handled the increases and said that some firms had had to dismiss workers and replace them with machinery because they could not afford the increases.

The increases come into effect next year and largely bring unskilled weekly-paid workers in the industry into line with similar workers in other industries.

The increases had also resulted in some dissatisfaction in the workplace with semi-skilled workers objecting that their unskilled colleagues would be earning almost the same weekly wages,

some employers claimed.

The meeting resolved to put pressure on the TCMA in future to ensure that similar decisions were not taken again.

There are about 200 employers in the Transvaal chemical industry and about 85 belong to the TCMA.

Mr Mike Klein, chairman of the TCMA, said there was always likely to be some dissatisfaction with any industrial council wage determinations.

He said membership of the association was voluntary and not expensive.

Some TCMA members criticised the "rebel" employers, saying that the association had notified all its members in advance of negotiations for the increases but only a few firms had turned up for the talks.

Critics of the employers' association had gone so far as to suggest an alternative employer body be formed in the chemical industry.

● The SA Chemical Workers Union and the Chemical Workers Union were involved in the council determinations.

MAN OF THE YEAR

South Africa's black workers

~~133A~~ 133 FM 24/12/82

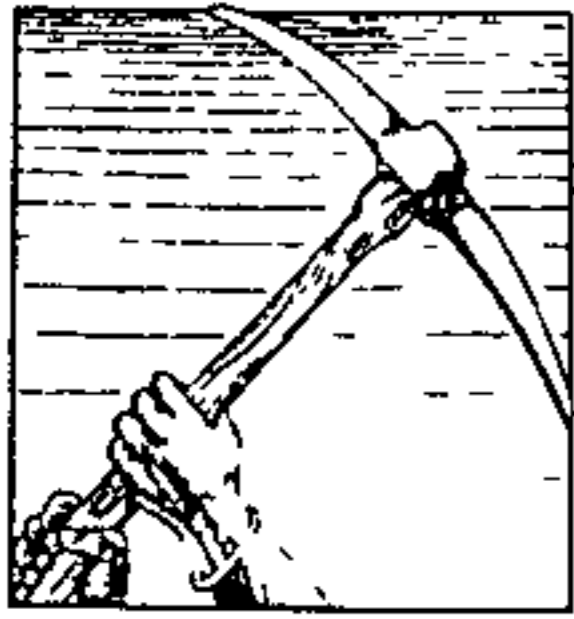

There are those who regard South Africa as seething with violence and discontent. And indeed it is sobering to reflect that the prosperity and stability of the country depends on so many

people who face severe social and political disadvantages

Millions of black people struggle daily to cope with an appalling shortage of adequate housing and public amenities. Their lives are governed by increasingly stringent influx control laws which break up families and make blacks aliens in the land of their birth.

Statutory and non-statutory measures are still formidable barriers to their advancement in the workplace. Their often meagre incomes are eroded by inflation, while the increasing scale of retrenchments testifies to their lack of job security.

Yet, despite these handicaps, they are actively involved in an evolutionary process which will surely change the face of the society they live in.

The battle for recognition of black unions has not been an easy one. Gains made in recent years have, in the main, not been achieved by political activists, but by ordinary men and women who perceived the power which lay in group action. In view of the impact they have made in the three years since statutory collective bargaining rights were granted to blacks, the *FM* believes it appropriate to name the black worker as our Man of the Year.

Few people would have dared to predict, only five years ago, that by the early 1980s unions representing large numbers of black workers would be posing a serious challenge to labour policies pursued by government and employers.

However, events on the labour front this year have served to confirm what was already becoming apparent a year ago. Black

unions are here to stay. Never before in this country's history has there been such an urgent need for mutual trust to be established between black workers and all the other parties participating in this country's turbulent labour arena.

Although, by some estimates, fewer than 350 000 of a total of 6.3m economically active blacks are unionised, it is especially members of the new emerging unions who are restructuring the relationship between capital and labour in SA. The most immediate effects of their new sense of assertiveness is revealed in the rising number of strikes. There are estimates that about 400 took place this year, virtually all by black workers. This is four times the annual number of strikes in the years immediately preceding the Wiehahn reforms.

The present wave of black unionism is, of course, not the first in South African labour history. Several major unions and union groupings have grown spectacularly during the past 60 years. But they were largely ignored or fiercely opposed by employers, and many collapsed or were forced into exile due to government pressures.

It was the large-scale labour unrest in 1973 which finally prompted government to begin to re-examine its labour policies. An almost spontaneous display of anger by black workers over low pay, these strikes were the prelude to the formation of a new breed of emerging black unions.

Where previous black unions concentrated on mass mobilisation, but failed to secure an enduring power base in the factories, most of the new emerging unions have placed great emphasis on building up and consolidating support, factory by factory. Unlike black unionists in the past, their leaders have not been trained to become charismatic orators. Instead, they have concentrated on developing the union skills of grass-roots representatives in factories, adopting the traditional British shop-steward system as an integral part of their strategy. Although these unions have committed themselves to representing

workers of all races, the vast majority of their members are blacks.

It cannot be denied that many have made grievous and costly errors. Unrealistic wage demands, strikes to retrieve pension contributions, and too rapid growth which has impaired the ability of some to service the needs of members adequately, are some of the mistakes that have been made.

But it is worth noting that at least so far, most of the gloomy predictions made in recent years by opponents of government labour reforms have not been fulfilled.

The more than 250 recognition agreements negotiated between managements and emerging unions during the past three years are possibly the most tangible evidence that black unions have arrived. These agreements vary considerably in form and content, but they have a common feature. Although many aspects of the authority previously wielded arbitrarily by management are being modified, the agreements actually reinforce management's right to manage. The basic right to manage is not challenged — and it is significant that unions are not objecting to this being formally enshrined in agreements.

It is natural, however, that unions should seek to modify some of management's powers. It is also logical that unions representing unskilled black workers should raise issues which have not been on traditional negotiating agendas between employers and white unions. For example, because they represent unskilled people who are easily replaced if dismissed, they are especially concerned about job protection. For migrant workers, loss of a job also means a loss of residence rights in an urban area, while it can also be argued that in the society we live in, a black man's job is his only real form of property. It is not surprising therefore, that these unions are demanding a say in issues such as the formulation of disciplinary, grievance and retrenchment procedures.

Because emerging unions realise that at this early stage of their development their



power lies at plant level, it is also not surprising that they have opposed industry-level bargaining through industrial councils

Rod Ironside, president of the Federated Chamber of Industries (FCI), emphasises that "understanding the other party's perceptions" is vital. Managements that have had the sensitivity to appreciate the issues at stake to black workers have been remarkably successful in structuring productive relationships with even the most tough-minded emerging unions

The South African Allied Workers' Union (Saawu) is, for example, regarded by many employers and government officials as beyond the pale, and its leaders have been detained for lengthy periods. But Theo Heffer, one of SA's most respected industrial relations practitioners, achieved extraordinary success in helping to create a healthy relationship between it and Chloride SA. In retrospect, he says that virtually everything that the company was told three years ago about the union's approach, techniques, strategies and officials has proven to be untrue

One of the most visible effects of a change in management attitudes is revealed by the radical revisions that some employer organisations have made to their labour policy guidelines in the past two years. Just this month, for example, the Chamber of Mines announced that mining employers will recognise unregistered unions if they are representative

Remarkable too was the FCI's sympathetic attitude to the brief work stoppage by about 100 000 workers in protest against the death in detention of unionist Neil Aggett

But it is not just employers who have had to make fundamental readjustments to their attitudes and policies. Government has been compelled to heed the power being exercised by emerging unions. It may be regrettable that widespread strikes forced the withdrawal of legislation to preserve pensions. But by South African stan-

dards it is extraordinary that government should actually scrap a proposed law in the face of pressure from black workers

Perhaps more significant is government's proposed amendment to the Labour Relations Act, aimed at making official dispute-settling machinery available to unregistered unions. The effect of this is to downgrade registration (which is seen by emerging unions as a form of unnecessary government interference in their affairs) as an issue in industrial relations

But there is a rich irony to government's proposed amendment. Only a few years ago National Party spokesmen on labour were emphasising to nervous white workers that registration was the crucial mechanism through which emerging black unions would be controlled. However, during the past year the Department of Manpower has shown an increasing willingness to move away from direct control of events in labour

Manpower Minister Fanie Botha told the Institute of Personnel Management conference two months ago "As long as employers and employees, or their respective organisations, do not negotiate wages and conditions of service which are less beneficial than those provided for in basic legislation, they are free to structure and regulate the relationship between themselves. This is what self-government in labour relations means, and this principle applies from the factory floor to industry level"

A singular feature of many new unions has been their ability to successfully use structures and systems created by government to achieve their goals. In doing this they have been able, unlike some black political organisations, to recognise that strategic considerations can sometimes have a higher priority than some other issues which they might be tempted to regard as matters of principle

Many emerging unions object in principle to registration, but they have realised that from a strategic point of view registration can aid recruitment and recogni-

tion. Similarly, some are finding that participation in the officially-sanctioned system of collective bargaining through industrial councils can, in certain circumstances, provide tangible benefits

It would naturally be unwise to underestimate the value of the advice these unions have received from young white intellectuals and activists. However, because of the democratic nature of most new unions, grass-roots membership has been closely involved in all potentially risky decisions.

Anyone trying to assess future trends in SA labour cannot ignore the fact that while black workers have been granted a vote in the workplace, they are still denied fundamental political rights. The obvious danger is that unions will be used to redress grievances which do not lie within the normal scope of the employer/employee relationship. Managements are already being confronted with such issues and are learning that the industrial relations function does not necessarily stop at the factory gate

However, it is remarkable that emerging unions have, by and large, so far been able to avoid the temptation to play an overt political role or to forge links with black political movements. Attempts by the State in recent years to prosecute unionists for security-related crimes have failed

Given all the perils that lie ahead, it is remarkable that many of SA's most experienced industrial relations practitioners are still able to display a cautious optimism about the future

"The South African labour situation today certainly has the potential for revolution," says Fred Ferreira, Ford's director of industrial relations. "But if the protagonists — labour, employers and government — recognise at least some of the inequities and remove these, they will tip the scales in the direction of evolutionary change"

The South African black worker is on the move. And the early indications are, hopefully, that he is on the move towards participation and greater prosperity

BRICKBATS AND BOUQUETS

Not a very good year

Most South Africans will not look back on 1982 with happy memories, for many, it was far from being a vintage year. For white politicians, it was the year of the big split in the National Party, and of by-elections which yielded ambiguous results. For businessmen, who had enjoyed three years of life in the fast lane, shifting back into the lower gear required for negotiating the steep downturn was painful for most, very traumatic indeed for a few

The Slim Jannie Smuts Award for splitting Afrikanerdom is awarded jointly to PM P.W. Botha and Conservative Party

leader Andries Treurnicht. Botha does, however, deserve a minuscule bouquet for at least trying to maintain a modest pace of reform

Two pairs of tortoiseshell spectacles, to alleviate his severe short-sightedness, go to Minister of Co-operation and Development Piet Koornhof. One is for closer scrutiny of the innumerable submissions which have been made to him over the years on influx control laws. In particular, he appears to have been unable to focus on the reasonable suggestions of the Grosskopf committee. The other pair — which he can pass on to

Pik Botha — should help the Foreign Minister to read the signs of local, national and international opinion before he acquiesces to Koornhof giving away parts of SA to Swaziland

It hasn't been a good year for "Piet Promises," aka "Piet Pinnochio," aka many less savoury titles. What with the Orderly Movement and Settlement of Black Persons Bill and the debacle over Ingwavuma and KaNgwane, he must be reeling. In countries like the UK and the US, ministerial heads roll for getting it wrong. Fortunately for Piet, the tradition here in SA is

FM 31/12/82 133

THE CONSTITUTION ~~2011~~ Business weighs in

Extend and protect free enterprise This is the gist of Assocom's response to the President's Council's (PC) latest proposals on constitutional change. The association's submission on the reforms stresses economic rights as the essential basis of constructive change in SA.

Assocom's leaders are concerned that there be checks and balances on the power of the executive president and his Cabinet. How far government will accept, and integrate these, and other, points into legislation — particularly on citizenship, equal ownership rights and labour mobility — is moot. But, as the 22-page submission points out, Assocom represents some 20 000 businesses via its 100 affiliated chambers of commerce.

It says that "although the business community in general, and Assocom in particular, are not committed to any particular democratic political form, the constitutional recommendations have been examined from the point of view of the interdependence of political stability and economic performance." Increased access for blacks to a share of the economic cake would defuse more militant attempts to gain a

provincial government systems in favour of the eight metropolitan or regional authorities, adding that the main purpose of these authorities must be to co-ordinate economic development in the regions.

Assocom supports the PC's principle of maximum devolution of authority to local authorities. However, it opposes the financ-

place in the sun through radical political means.

Assocom calls first for a resolution of the tangled question of SA citizenship for blacks, since access to all other rights are dependent on it. At present, people who legally qualify for homeland citizenship because of ethnic descent lose SA citizenship when the relevant homeland opts for "independence," no matter where they are born.

"Provision should be made for some form of common citizenship" — possibly on a confederal basis, Assocom says, for all those who would have been eligible within SA's original 1910 borders.

Assocom endorses the PC's call for government to make a statement of intent on further constitutional development for blacks — once a clear ruling on citizenship rights is reached.

A number of basic free enterprise rights should form part of any new Constitution Act, according to the submission. These are:

- The right to own movable and immovable property, and to be protected against expropriation without due process of law and adequate compensation,
- The right to contract freely with any person on any matter — subject only to common law and other legal restraints,
- The right to live, work or conduct busi-

ness in any place subject only to reasonable requirements of public health, safety or amenity,- The right to organise or belong to voluntary organisations which further the legitimate economic rights of members, and
- The right to reasonable political expression on matters affecting individuals' broad interests.

Furthermore, "the role of the courts should be strengthened and expanded rather than weakened by, for instance, excessive legislation allowing wide administrative discretion coupled with limitation of ordinary rights of appeal against such decisions."

Also objectionable is the increasing tendency to establish boards of control which exercise quasi-judicial, or clearly judicial, functions to the exclusion of the courts. Realistically inexpensive and easy access to the courts is also desirable.

"It is strongly recommended that constitutional enactments should also refer to a commitment by government to grant all citizens equal access to education and to the support of educational institutions at all levels."

On the role of the proposed executive president, Assocom — like many other institutions — is concerned that his powers be controlled, and that there be a means of removing a president from power. The submission favours a five-year rather than a seven-year presidential term.

Providing balance

Cabinet ministers' accountability should be clarified. Ministers should be drawn either from the Parliaments, or from PC members. Otherwise the president's choice of Cabinet ministers should be subject to the PC's approval, Assocom suggests. The association clearly sees the need for a body to provide a balance to the powerful executive outlined in the proposals, and the PC is seen to fit the bill.

Assocom goes on to propose that the PC should also be given a review function, able to act as a check on the powers of the legislature, to review legislation and make amendments. It should have powers to recommend or initiate new legislation or require reconsideration of legislative proposals.

On the present proposal for separate white, coloured and Indian legislative assemblies, the statement adds that occasions for joint sittings may be essential for considering financial Bills.

The question of lines of communication to the legislatures is also raised. There is some uneasiness about a massively slow and unwieldy system emerging. The submission urges greater use of referenda to gauge public support of broad policy directions, or important issues.

Assocom is generally in favour of the recommendations on regional and local government. It supports the phasing out of

vices, or even zone land for anything but domestic dwellings.

Assocom's document is a thoughtful and well-argued proposal for beginning real reform with real economic rights, rather than concentrating exclusively on complex political structures. It is a clear expression of the private sector's opinion.

INDUSTRIAL REL. - WORKERS' Org.

1983

JAN. — DEC. ✓

SEIFSA head fears more unrest

A FEAR of further industrial unrest this year in the metal and engineering industries in South Africa is expressed by Sam van Coller, director of the Steel and Engineering Industries Federation in his annual review this week

But he is confident that sound industrial relations procedures can be established at both company and industry level for solving disputes when they arise

One of the bones of contention is bound to be unemployment and in the 1977 recession there was a drop in job levels of some 10 percent. So far figures are not available for the present downturn but there have been significant numbers retrenched in the past year

By Mike Peirson
Finance Editor

Many employers have adopted alternative courses of action in an effort to avoid retrenchments where this has been possible

Van Coller explains that increases in scheduled wage costs in the metal industries ranged from 14 percent in 1976 to 6,7 percent in 1977 climbing to 16,1 in 1980, 18,9 in 1981 and 20,2 last year

This was due mainly to a shortage of skilled workers whose pay has accelerated during the boom and resulted in inevitable higher wage demands from unskilled and semi-skilled workers

The removal of the artificial barriers which contributed to the scar-

city has cleared the way for these industries to get to grips with the problem

In this respect the following developments have taken place

- New apprentices approved at regional committees last year reflected a further significant increase over the all-time high of 1981

- An alternative route to the apprentice system for training artisans has been agreed with the trade unions. This approach is open to those who have missed the opportunity to become an apprentice

- Additional money being generated from increased training levies has been earmarked for

the establishment of industry level apprentice training centres the first of which is due to open early this year on the East Rand

- The introduction by many employers of modern training workshops

The substantial capacity in the foundry industry continued to be under-utilised in 1982 and demand is expected to weaken further this year in line with the declining activity of major end users in the automotive, heavy engineering and automotive industries

The shipbuilding industry experienced a general drop in activity last year and the absence of orders in the medium to long term and continuing

severe competition from overseas yards are matters of major concern

Substantial volumes of low cost imports coupled with favourable foreign financing offered for a number of major projects, continued to erode the markets of domestic manufacturing, particularly in the machinery and electrical machinery sectors

Van Coller sees the coming year as one of consolidation and realistic adjustment for the basic metal metal fabricating and engineering industries

Top bosses help reform education

133
18/1/83
Industrial Week

THE Manpower and Management Foundation (MMF) of SA has formed a study committee to investigate education and training, consisting of some of the country's top businessmen

The committee, set up to look into ways of utilising educational and training facilities for all races, will be chaired by the MMF's executive director Dr John Burns

On the committee are Dr Zac de Beer, chairman of Anglo American, Theo Shippey, director of the Cape Technikon, Amod Tayob, chairman of Amod Tayob, Alf Leveson MD of Pilot Furniture Manufacturing, Jack Clarke, MD of IBM and Wilby Baqwa, industrial consultant for Barlow Rand

Staff Reporter

The Foundation has pinpointed education and training as a priority in



David Thebehali... more money needed for education.

providing an adequately skilled workforce, essential for economic growth and stability

The committee will conduct an in-depth study into the full utilisation of educational facilities, following this they

will make recommendations to the Government

Burns said the Government must ensure that black educational facilities are fully utilised

"Taxpayers have invested heavily in such facilities and they must be productively utilised into the night to provide for adults, unemployed and all who wish to receive training and become qualified to fill a job," said Burns

David Thebehali, chairman of the Soweto Council said the existing educational facilities were "a drop in the ocean" when compared to the need

"We would like to see the Government providing more money for education and the private sector increasing its contribution

"We are already seeing a move in this direction, but it is not enough"

Thebehali said that vigorous training programmes were needed to develop black entrepreneurs

"There is no other way to guarantee economic development. We want a direct role in the overall economic development of this country"

133 27/2/83

Steel men set for pay battle

By BEVIS FAIRBROTHER
THE country's 500 000 iron and steel workers are nervously pacing the sidelines waiting for union representatives and management to start annual pay negotiations.

But this year the workers know they are unlikely to get increases as usual in June.

The industry is in a serious financial crisis

Hundreds of workers have been retrenched and smaller sub-contractors are in danger of closing

"I can't stress strongly enough how serious the situation is," Mr Sam van Collier, director of the Steel and Engineering Industries Federation of South Africa (Selfsa), said

The federation asked to put off negotiations until October.

Management and unions deny there will be a showdown, but sources believe it is imminent

Workers have refused to accept a six-month "freeze".

Selfsa has put suggestions to the unions and is waiting for counter-demands.

The issues will come under discussion again at the next meeting in March.

Smaller companies, essential to the industry, are especially battling

Mr Henry Ferreira, acting general secretary of the SA Iron, Steel and Allied Industries Union, said its members were also feeling the economic crunch.



Dr Rick Turner with his mother and daughters, Jann, then aged eight; Kim, four, on the steps where he was murdered outside his home

MARRI MONIE

Commerce and industry told to demand a role in the Government's reform programme

By Stan Maher

BUSINESSMEN and industrialists meeting in Durban this week were told it was their duty to demand that the Government allow them a real say in P.W. Botha's reform programme.

About 80 representatives of commerce and industry — among them former Anglo American Corporation chairman Harry Oppenheimer — heard Ron Ironside, president of the Federated Chamber of Industries, warn that "for too long we have taken a passive role."

"It is the duty of South Africa's businessmen to demand a quid pro quo from Government in return for all we are putting into society," he said.

And a key area the Government would have to look at would be the quality of the officials implementing its reforms at

Give business a REAL say



Among the key figures at this week's seminar were (from left) Ron Ironside, Professor Jill Nattrass, Harry Oppenheimer and Professor Lawrence Schlemmer

ground level.

Mr Ironside and Robert Godsell, an industrial relations consultant for Anglo American, were the key speakers for industry

and commerce at a seminar at the University of Natal.

The seminar was to launch the Indicator project, an intelligence

service which will do fact-finding and analyses on socio-political trends for its sponsors.

Mr Ironside and Mr Godsell gave glimpses of

the unease with which business and industry view the tensions inherent in Mr Botha's reform programme. And both said reform could not be restricted to the labour field, since the tensions spilled over into other areas, social, economic and political.

Mr Ironside said "There is no future for the paternalistic, subsidised framework in which we have been operating for years. It has to be turned around."

He said business should demand from the Government "that it is worth more recognition and more co-operation".

In an interview afterwards, he said that a key area in need of urgent improvement was the interface at which employers and workers had to negotiate with Government officials.

This problem was highlighted in a recent research project for the Department of Co-operation and Development, by a team headed by Professor Louis de Clercq of the University of Zululand.

The report, which tackled development problems in the homelands, said the Government's ideal was sometimes jeopardised by officials carrying out the work "because of a lack of sincerity, interest or even knowledge".

Mr Ironside said this was also a key area for business and industry.

"The quid pro quo which business must demand from the Government, must include looking at the standard of the people doing the job for the Government," he said.

Good industrial relations were crucial for the phase the country was entering, Mr Ironside said. "Without the orderly and constructive management of the nation's human resources we are going nowhere."

"Industrial relations also have to accommodate other influences affecting the lives of some employees, both at and away

from the workplace, such as harassment, intimidation, social sanctions and plan obstruction in community and other services.

"Ultimate success hinges essentially on respect for human dignity and perceived fair treatment and justice for all persons."

Both Mr Ironside and Mr Godsell spoke about a fundamental shift of power in South African society. Mr Ironside said it was "abundantly clear" that workers' demands, sporadic industrial unrest, and the new stress on employee relations, were due to this shift in power and not to the "63 different varieties of excuses advanced from time to time".

Mr Godsell said that because South Africa was becoming a complex modern society, Parliament was now only "one of several sources of power."

Mr Botha had emerged as the country's first modern leader trying to create a new society, not by Parliamentary dictate, but by co-ordinating "the forces already at work changing and shaping the social order."

He said there were real problems for a bureaucratic government with a single ideology, which was working in partnership with the private sector. "A loose concept of 50 000 registered companies with differing managerial styles."

Reform could not be contained in one section of society. "When you have change in the workplace and stagnation outside, it must create tension," he said.

Since the Sixties, much of the black labour force had become permanent, semi-skilled, unmon-repre-

Harry Oppenheimer, former chairman of the Anglo American Corporation, at this week's seminar in Durban



sented employees. This conflicted with the Government's idea of migrant workers as people temporarily in urban areas.

Influx control had become a problem for businessmen because it was inefficient and simply did not work.

"I am told that Durban is now surrounded by a ring of squatter settlements housing between 500 000 and 800 000 people," said Mr Godsell.

"That happens in every place where a piece of black land is adjacent to an urban area. We have arrived at the point where it is worth these people breaking any rule simply to feed themselves."

Professor Jill Nattrass and Professor Lawrence Schlemmer of the University of Natal, quoted from surveys showing black attitudes on a range of current issues.

Professor Schlemmer said the surveys showed many blacks believed that substantial numbers of black people might be sent to "confront the system in a crunch situation".

But at the same time, the majority believed in a patient approach, rather than in making demands.

"They took a practical view and voted for overseas investment, rather than boycotts."

"There is clear evidence of a dual consciousness among black people," he said. "They are highly political and critical of capitalism. But the rank and file are not yet ready to reject the system for any kind of socialist system. They are constrained by what is practical and feasible and what will affect jobs and welfare."

A great weakness was the lack of mediating figures at the work interface between employers and workers, he said.

"Who is there who can go on radio or television with sufficient credibility in crisis situation?" he asked.

123

LABOUR

The calm before the storm?

AR645 16/3/83

133

This is the last in a three-part series on the South African labour scene, by HUGH ROBERTSON and PIPPA GREEN

THE good news for employers might be that there are now fewer strikes and that unions are being more conciliatory in wage negotiations. The bad news is that it may turn out to be the calm before a storm.

Only one out of every 10 South African workers currently belongs to a trade union and even this relatively small number has revolutionised labour relations in a way which was unthinkable a mere three years ago.

More members

In the next few years, according to union leaders, labour consultants and industrial sociologists, the trend will be towards bringing millions more workers into trade unions until not one in every ten, but probably five or six in every ten, are unionised.

And, they predict, unions will undoubtedly become even more politicised than they are, requiring management to respond to and become involved in political issues

which they currently show little or no interest in

"Industrial relations in South Africa obviously are overlaid by racial tensions and this means management will have a far more exacting task as the union movement grows in strength," an industrial sociologist at the University of the Witwatersrand said.

"Management is going to have to think of the wider inequities in South African society and unless they can express themselves on these issues they will become increasingly identified with the Government in the eyes of workers. They will be seen as a part of the problem."

He added "Many demands in the coming decade will go well beyond the factories. Influx control, for instance, is a growing issue in the union movement and its relations with management."

The African Food and Canning

Workers' Union in Cape Town has secured agreement from Fattis and Momi, for example, to support applications by contract workers to be given permanent residential rights in the city.

Johnny Copelyn of the National Union of Textile Workers believes that even issues like the President's Council constitutional proposals have stirred political feelings in the unions.

"Many unions have coloured, black and Asian members whose economic wellbeing and aspirations coincide, who advance their mutual interests through collective action."

"Suddenly they are to be separated on a political level. The blacks are embittered, the coloured and Asian members are in a dilemma. It's a tricky situation for union leaders to handle and it is an issue which nobody in the unions can be indifferent to."

Mr Copelyn's advice to employ-

ers "It is very necessary to acknowledge the politicising of the workforce, to accept it as an unavoidable reality. It will be one of the trends in the future, whatever the official reaction to it is. Employers need to show caution and flexibility in dealing with it, as do union leaders."

"I can tell you that mistakes in the political area can, for a union's leadership, be far more disastrous than a poor wage agreement. I would say the same applies to employers. They are going to have to do crash courses in politics."

For employers to rely on the Security Police to "handle" the politicising of unions is short-sighted, labour consultants say. "If a union leader is not truly representative of the workers then his detention might well cause the union to collapse. But where he has a real mandate, workers are simply antagonised and angered."

The general secretary of the AFCWU, Mr Jan Theron, noted recently "Look at the way in which the union in Johannesburg has gone from strength to strength since Neil Aggett's death."

There appears to be a consensus among labour experts that the post-recession era will also be marked by a reduction in the plethora of small unions in each industry and the emergence of more national industrial unions.

And most of the growth, they expect, will be in the black independent unions with groups like the Trade Union Council of South Africa (Tucsa) and the white right-wing South African Confederation of Labour (SACL) losing both support and influence.

"Management is going to have to accept that they will have to share decision-making with their workforce in areas where up to now management alone has been calling the tune," says a Johannesburg labour consultant.

133 ROM 21/3/83

THE Johannesburg Chamber of Commerce has appointed its first full-time labour adviser, one of whose chief jobs will be to help members in their dealings with unions

What makes the move sure to be controversial is the adviser's identity. He is former Tuca president, Mr André Malherbe

Tuca is constantly at war with emerging black unions, some of whom say they would prefer to ally themselves with hard-line employers than Tuca

Relations between Mr Malherbe himself and emerging unions are less than cordial, and were not improved last year when he played a key role in defeating a motion condemning detention without trial at the last Tuca congress

Black unions are certain to note his appointment with interest

SA — scriptland for TV newsmen

133

By John D'Oliveira
The Star Bureau

WASHINGTON — I swear: if South Africa did not exist, American television would be forced to invent the place.

After all, where else are the good guys so obviously good and the bad guys so obviously bad? Where else are the issues so clear-cut, the moral lessons so obvious and the picture painted in such bold strokes of white and black?

Most of all, where else are the participants in such a racist system so accessible? Where else can television producers and their assistants travel in five-star luxury while recording such great evil? And where else can they imply brave defiance of a police state without actually being in any great danger?

Where else can they find both an Arrie Paulus and an Auret van Heerden?

Where else a secret police chief as leeringly sinister as Ciskei's General Charles Sebe? Where else could they serve all this up against a background of the hauntingly beautiful chanting of black South Africans?

EXAMINATION

These thoughts were prompted by Friday's screening of ABC's hour-long programme entitled "Adapt or Die" and billed as an examination of South Africa's emerging black trade union movement

In fact, the programme is no more than a look at four South African black unions: a mine-workers' union, two unions at the Ford Motor Company in Port Elizabeth and a dock-workers' union, also in Port Elizabeth.

They do their work skilfully — and they use television's inherent facility for oversimplification and glib commentary to make a breathtaking leap from the specific (the four trade unions) to the general (South

Africa itself).

Mr Elliot Abrams, the Reagan Administration's Assistant Secretary of State for Human Rights and Humanitarian Affairs, put it last year when he released the department's 1982 report on human rights around the world: "South Africa is a unique blend of good and evil."

Few people who know South Africa would quarrel with this.

But ABC producer Christopher Eisham acknowledges very little that might be good about South Africa

He does not even concede that many of the black mineworkers he pictures have come from neighbouring "free" black countries, sometimes waiting weeks or more for the opportunity to work in "racist, repressive" South Africa.

In contrast, last week a select company of Americans — the Chicago Foreign Relations Council — was given a totally different picture by Mr Harry Oppenheimer, chairman of South Africa's mighty Anglo American Corporation.

Mr Oppenheimer stated his

A much-publicised American TV film called "Adapt or Die" turns out to focus on four black South African trade unions. But, writes John D'Oliveira after watching the documentary, the producer presents a somewhat one-sided picture.

Two figures who represent opposite sides of an endless South African controversy: Mr Auret van Heerden (left), ex-Nusas president who was detained last year, and Mr Arrie Paulus, general secretary of the Mine-workers' Union.

opposition to racism, his belief in government by the consent of the governed and the need for peaceful change

He referred to the economic trends in South Africa's "free" neighbours, said these had been little short of disastrous, bringing a grave restriction of individual liberty and stressed that economic growth was the factor with "much the greatest potential for effecting peaceful change in South Africa"

He gave statistics of what he called the "quite remarkable redistribution of wealth" in South Africa in the past 10 years and said that these statistics made nonsense of the claim that economic growth in South Africa was based on the exploitation of blacks — and that it boosted apartheid.

He spoke of other positive changes in South Africa including the change in government policy towards black unions

When, in 1973, the government came to realise that black workers were becoming increasingly conscious of their power, it reacted in a conciliatory fashion and, in 1979, extended trade union rights to blacks on the same basis as whites.

He conceded that the growth of black industrial unions would make the lives of employers more difficult and more complicated. However, if the worst came to the worst, strikes were preferable to disorganised violence.

Mr Oppenheimer said he had tried to paint a picture of both light and shade and that it remained to be seen whether South Africa could find its way into the full light of day.

"It can at least be said that South Africa is on the move as never before . . ."

Mr Oppenheimer made a convincing case — and so did ABC

But ABC failed even to concede that there was another side to the issue: that what it was examining was the effects of a deliberate decision by the Nationalist Government to liberate the South African economy from some of the ravages of apartheid; that for every industrial confrontation in South Africa now there were a dozen satisfactory negotiations and that for every Arrie Paulus there were 10 white trade union leaders trying to accommodate the new situation

Star 5/4/83

237

48

Trade unions meet in Cape for unity talks

200 unionists meet for fourth time

MORE than 200 trade unionists from South Africa's major black and non-racial union groupings which represent more than 500 000 workers will converge on Cape Town tomorrow for historic unity talks.

The Cape-based General Workers' Union (GWU) has invited all emerging unions to the Mother City to discuss the formation of a new union body. Mr David Lewis, general secretary of GWU, said the summit talks would be held over two days.

Leaders in the worker movement interviewed this week all seem to agree that the meeting of unions will be crucial for workers in South Africa.

An expert on labour matters said a new super body would be an asset to the workers, something to give the powers that be the "biggest shock of their lives". He said a united worker movement in South Africa "has nothing to lose

but chains"

Unions likely to send delegates to the talks are the Food and Canning Workers' Union (FCWU), the African Food and Canning Workers' Union (AFCWU), the powerful Council of Unions of South Africa (Cusa), the non-racial South African Allied Workers' Union (Saawu), the Eastern Cape-based Motor Assembly and Components Workers' Union of South Africa (Macwusa) and the giant Federation of South African Trade Unions (Fosatu).

The meeting follows three others held last year. None yielded re-

sults. The question that bogged down negotiations involved registration and the Industrial Council.

However, since the last "indaba" there has been a great deal of rank and file discussion on the question of unity in many unions. The Cape Town talks take place at a crucial time in trade unionism, when police and State action has put fear in the hearts of many, with large scale detention of union leaders.

The meeting also takes place in a wave of strike retrenchments.

The formation of an umbrella trade union body will not be the first



DELEGATE: Emma Mashinini will represent Ccawusa.

to be formed in South Africa. During World War II such a body operated. It was called the Federation of African Trade Unions. Later there was the South African Congress of Trade Unions. Like its predecessor the leadership of Sactu was intimidated and harassed by authorities.

Companies 'depression'

packaging market once held by tin plate, has undermined the use of zinc in die-casting and continues to be a strong competitor to copper for certain electrical applications

Plastics

"Meanwhile plastics have made significant inroads directly and indirectly into most of the base metal end uses

"It has displaced lead in cable sheathing pipes and corrosive chemical containers, it remains a major threat to copper in pipe and domestic construction materials, it has taken a large share of the packaging market at a cost to tin and finally plastic has been a direct substitute of zinc in die-casts though indirectly as a replacement for brass"

"Looking to the future, copper faces a potential major threat from optic fibres in the telecommunications end-use market

"It is too early to assess with accuracy, the extent of this threat but it is real enough. It has been variously estimated at displacing 100 000 tons to 1m tons per annum of mine copper production by 1990

"It is my personal opinion that real metal prices will remain by post-war comparison, for most of this decade"

st in arring

caused by this loss was severe"

Mr Graubart also alleged that De Beers threw huge quantities of industrial diamonds onto the market in order to punish Zaire for not having renewed the the marketing agreement

Exceptions

Summing up, Mr Tarring commented, "when Zaire broke away, a big fish was seen to escape the CSO's net. To an extent that fish has now been recaptured but there remain some more significant exceptions to the rule than before

"That, as Jacques Graubart has highlighted, undermines stability in the market and is to be re-



Mr Martin Rippen has been appointed manager, property administration, at the head office of The Southern Life Association

Samstel profits up

JOHANNESBURG — Sam Steele Holdings (Samstel) increased attributable profit by 11 percent to R1 817 000 (R1 635 000) in the first six months of this financial year. The interim dividend has been raised to 4,5c per share (4,25c)

Profit before taxation was R3 400 000 (R3 110 000) and after tax profit amounted to R1 827 000 (R1 645 000)

Earnings per share rose from 15,0c to 16,52c

The directors comment that the continued profit growth of the group is most pleasing, considering the extremely difficult conditions and high interest rates

The chairman of Samstel, Mr Hugh McNeil, says that barring any unforeseen circumstances, he feels that an increase in the previous year's record profit can be expected for the full financial year ending August 31, 1983

Three new stores are scheduled to be added to the retail network in the second half of the year — Sapa

For the Connoisseur's Cabinet

BELL'S Old Scotch Whisky

Industrial relations improved — Wiehahn

Own Correspondent

JOHANNESBURG — The industrial relations system of South Africa in general, and of the mining industry in particular, has improved considerably in the last four years, according to Professor Nic Wiehahn, of Unisa's School of Business Leadership

"It compares favourably against most of the international standards," he told the Southern African Metals and Minerals Conference in Johannesburg yesterday

The issue of statutory job reservation on the basis of race in the mining industry remains the most important area in which South Africa still conspicuously lags behind those standards, he said

Conflict management

"In certain areas of industrial relations such as conflict management, and the protection and training of workers, the mining industry of South Africa exceeds the international level and also the standards of many other mining countries"

South Africa must try its best to maintain those standards which are internationally acceptable for a number of reasons including the fact that the country is becoming more and more exposed through its in-

volvement with the international world of finance, commerce and industry

More than 30 of South Africa's trade unions are already affiliated to twelve international trade union federations

"This type of affiliation forms an important interface between those unions and the international la-

bour world

"A large number of multinational companies operate in South Africa and employ virtually hundreds of thousands of our people. Labour practices of these companies are exposed to the standards of various international declarations and codes of conduct," he said

Take the initiative and let Court Republic Helicopters fly you in Jet Turbine style Saldanha in as little as 40 mins. Worcester in 35 Flights depart from Table Bay Docks to any destination within 200 km to suit your busy schedule. We are efficient and dependable

CR COURT REPUBLIC HELICOPTERS
P.O. BOX 2546, CAPE TOWN 8000
TELEPHONE 75-2965

G.K.S. 400

Joint announcement

Kohler Kohler Limited ("Kohler")

DRG DRG (S.A.) Limited ("DRG SA")

Scheme of arrangement to constitute DRG SA a wholly-owned subsidiary of Kohler ("the scheme")

Approval of the scheme

At the meetings of shareholders of DRG SA held on April 12, 1983, the scheme was agreed to and the special and ordinary resolutions necessary to give effect to the scheme were duly passed by the requisite majorities of the shareholders of DRG SA

The scheme was sanctioned by the Supreme Court of South Africa (Cape of Good Hope Provincial Division) on April 15, 1983. The Order of Court and the special resolutions referred to above were registered by the Registrar of Companies on April 22, 1983 and the scheme accordingly became operative on that date

Stock exchange listing

The listing of DRG SA shares on The Johannesburg Stock Exchange terminated at the close of business on Friday, April 22, 1983. The listing of the new ordinary shares in Kohler to be issued

Unions Want Pension Control

26/4/83
133
Labour Correspondent

THE future of the Metal Industries Group Pension Fund, which covers about half a million workers, hangs in the balance because three unions have refused to agree to a renewal of the agreement setting up the fund.

None of the three are members of the metal industrial council, which set up the fund, and the agreement could, therefore, be renewed without them. However, unions on the council fear the government might then refuse to extend the pension agreement to workers who do not belong to council unions.

In a statement yesterday, the Metal and Allied Workers' Union announced that it and two other unions, the General Workers' Union and Chemical Workers' Industrial Union, had refused to support the renewal at a meeting last week.

Their key demand is that worker representatives should make up more than half of the members of the board which runs the fund. The pension fund was set up five years ago and the agreement setting it up is now due for renewal.

The three unions are due to meet the fund's board of management, made up of employers and unionists, on May 27, to discuss their demands for changes.

The statement said the unions' two representation on the board of management should be based on their number of members and that the Steel and Engineering Industries Federation (Seifsa), which represents metal employers, should have less than half the seats.

Both Seifsa and the Confederation of Metal and Building Unions, whose members belong to the council, want the fund to continue in its present form.

Seifsa told the unions it would never give up 50% representation on the board because its members contribute 50% of the fund's revenue. The CMBU argued that employer help was needed to run the fund. The statement said the three unions rejected this, arguing that "the money paid by Seifsa is only deferred wages — which the worker can claim later". It also said most workers were dissatisfied with the fund, which was made up of worker money and should be controlled by worker organisations.

27/4/83 (29) (30) (31) (32) (33) RW 133

Seifsa agrees to make wage offer

By STEVEN FRIEDMAN
Labour Correspondent

KEY pay negotiations in the metal industries, which affect about 500 000 workers, adjourned yesterday after the Steel and Engineering Industries Federation (Seifsa) agreed to make unions a wage offer

This means Seifsa has abandoned its earlier stance that the state of the industries was such that there should be no negotiated rises at all for at least six months

It is almost certain, however, that Seifsa's offer will fall well short of union demands for at least a 14% rise

It is understood that Seifsa adopted the same stance for much of yesterday's meeting of the metal industries' industrial council — which was

called to negotiate the industries' annual pay agreement

But union sources said it agreed towards the end of the meeting to consult its members and then come back to the unions with an offer

Another meeting will take place on May 24 and a document setting out the employer position in the negotiations will be sent to the unions before then

Both Seifsa and the unions will now go back to their constituents to discuss their next moves

However, Seifsa, which represents employer associations in all sectors of the metal industries, told unions at yesterday's meeting that some sectors of the industries would not be able to make unions an offer

Union sources believe steel producers are most likely to stick to the view that a wage freeze is necessary

Unionists also pointed out yesterday that the metal pay agreement expires in mid-year and that the May 24 date would leave "very little time to negotiate an increase

They said Seifsa had originally wanted the next negotiating meeting to be held in June — a move they described as "a delaying tactic to increase pressure on the unions" but had then agreed to the May date

Seifsa's director, Mr Sam van Coller, yesterday referred the Rand Daily Mail to a statement released by the industrial council

The council statement said both unions and employers

had voiced viewpoints on wages at yesterday's meeting which took the current state of the industry into account

The statement said both sides had agreed to return to their constituents before meeting again on May 24 and that employers had agreed to present unions with a document outlining their position before the meeting

It said "a large number" of delegates had attended the talks

Yesterday's negotiations were the first which were attended by Fosatu's Metal and Allied Workers' Union, which has applied to join the council but has not yet been admitted as a member.

It is understood that a large MAWU delegation took part in yesterday's talks

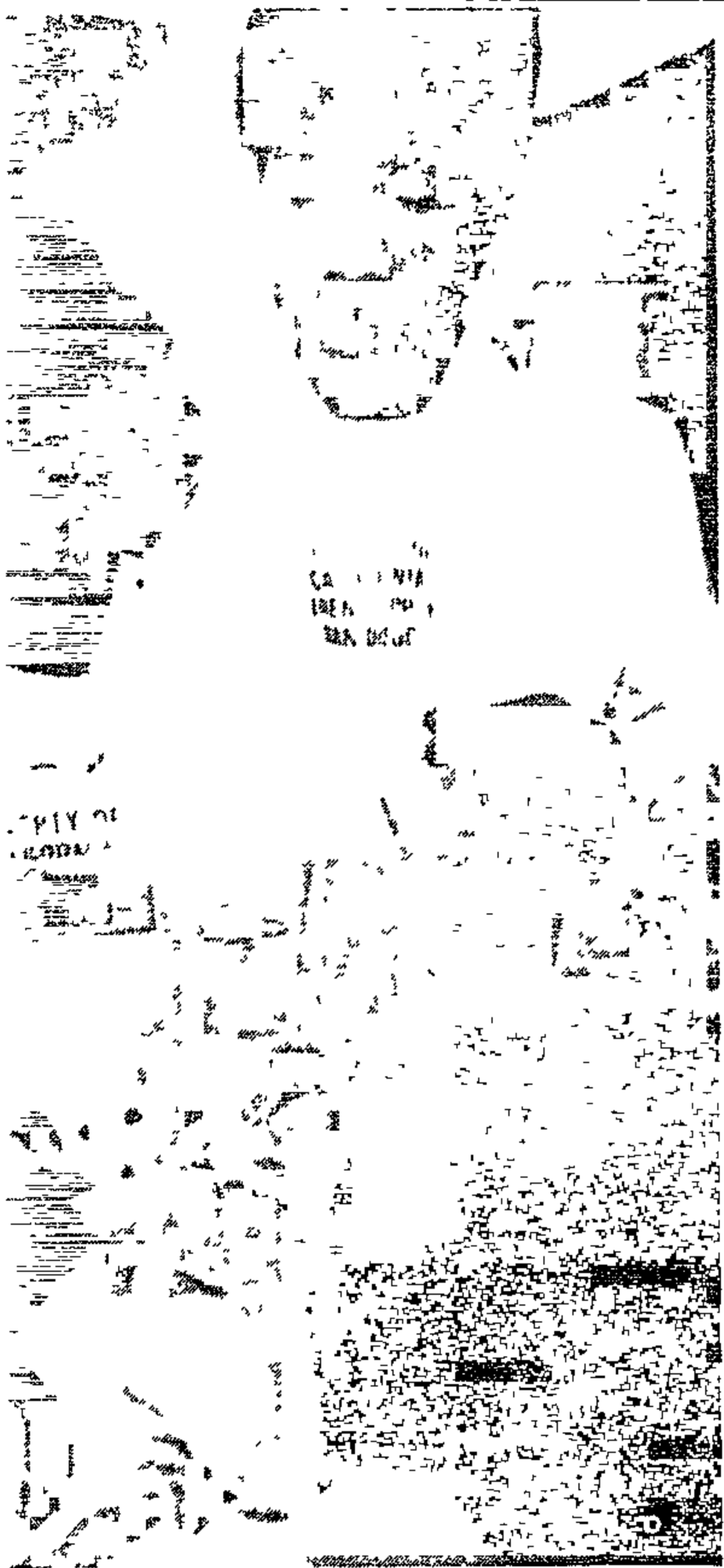

Workplace 'a model for society at large'

AR6-65
27/4/83
~~133~~
133

Labour Reporter

THE new patterns of interaction, compromise and partnership in the workplace that were emerging in South Africa could provide a model for co-operation in society at large, according to a top industrial relations consultant

Mr Bobby Godsell, Anglo-American industrial relations consultant and chairman of the Federated Chamber of Industries' labour affairs committee, was speaking at a conference on Trade Un-

ions and Change organised by the Stellenbosch Aktuele Aangeleenthedskring (SAAK) at Stellenbosch University last night

Unions were public organisations and had been and should be concerned with public affairs. He was optimistic that unions would be avenues of reform rather than "agents of the apocalypse"

"Good sense"

"In part, I draw my hope for the future from the fundamental good sense and wisdom that is displayed daily at the

working places of this nation"

Speaking earlier, Mr Jaap Cilliers, former Director-General of Manpower, said the State recognised the principle of freedom of association as a basis of trade union membership

The State's perspective was that sound labour relations could best be achieved by all parties "making full use of all the possibilities provided by the new legislative and institutional framework"

"Whether we like it or not, the more we integrate into society the trade union movement and accept it as a legitimate partner for economic development, the lesser the chances are of labour unrest"

First

Mr Jeff Lever, a lecturer in the Sociology Department at UCT, said the independent, emerging unions were "setting the pace" for other, more established unions

The strength of the independent unions lay in the fact that they were the first to "wholeheartedly commit themselves to the organisation of the mass of African workers"

Mr Chris du Toit, chairman of the South African Co-ordinating Committee on Labour Affairs (SACCOLA), which represents 10 employers' federations, said a participative society in the workplace would build the basis for a participative society in the social and political arenas

Record number
of plans passed

TROUSERS

BEST MAKES — LOWEST PRICES

(Compare our prices with any other reputable store)

ALL WOOL, TREVIRA/WOOL, IN TOP BRANDED MAKES

SIZES 69 cm to 137 cm

2

PAIRS FOR **R49⁹⁵**
OR R25,95 EACH

NEW STOCKS ARRIVED

SUPPLEFLEX OR AEROFLEX TROUSERS, IN TOP BRANDED MAKES

SIZES 69 cm to 122 cm

2

PAIRS FOR **R37⁹⁵**
OR R19,95 EACH

LIGHT COLOUR TROUSERS IN TOP BRANDED MAKES

SIZES 71 cm to 122 cm

2

PAIRS FOR **R27⁹⁵**

Wepcos slams City Engineer's sports plan

AR6-65
27/4/83
~~133~~
133

Staff Reporter

THE Western Province Council of Sport has condemned a recommendation by the City Engineer, Mr Jan Brand, as "dictatorial"

He has recommended to the Executive Committee that the City Council refuse to lease sports facilities to organisations affiliated to the South African Council on Sport

Wepcos president Mr Yusuf Ebrahim said today "Wepcos totally condemns the dictatorial stand of this municipal employee and his open and unashamed attempts to support the Government's multinational sports policy"

Wepcos is the largest national affiliate of Sacos

VICTIMISATION

Mr Ebrahim said "The recommendation by Mr Brand is blatant racial

discrimination and protected the interests of the white electorate"

The City Council could not consider Mr Brand's recommendation yesterday because he is out of town

The Cape Areas Housing Action Committee, which represents more than 30 civic associations in the Western Cape, said the "arrogance of the council was well demonstrated by Mr Brand's statement"

A statement released by the committee read "What the City Engineer is saying once again is that the people are incapable of deciding and that the council must decide"

"If the City Engineer knew the aspirations of the inhabitants of this city he would know that the overwhelming majority have freely chosen to participate in non-racial sport

Govt 'can do more by doing lots less'

133 Post
18/5/83

By LESLEY LAMBERT

THE best solution to problems in the labour market was like the solution to most problems — to prevent the cause, according to Mr Leon Louw, executive director of the Free Market Foundation.

Writing in the latest edition of Forum, the official journal of the South African Society for Training and Development, he said although changes from more to less Government control had recently been made in parliamentary Bills affecting labour, the "meddle imperative" had not been avoided and the Government still intervened to the worker's disadvantage

Instead of leaving workers and employers to negotiate freely with each other, wage increases to be controlled by competition among employers and full employment to be achieved by competition amongst employees, the Government over-reacted by making more laws

Some changes in labour legislation, including the Bills presently before Parliament (the Manpower Training Amendment Bill, the Labour Relations Bill and the Basic Conditions of Employment Bill) were described by Mr Louw as "a retrograde step because they try to right the wrongs of previous bad labour laws by further legislation rather than repeal alone"

"Generally the symptoms of unsatisfactory laws have been combated by more laws, without due regard for the causes of the problems"

He mentioned examples of Government intervention which in some way disadvantaged the workers and said the decentralisation policy, which "creates" jobs in a decentralisation development area probably cost the Government "five times more" than it would have in an established metropolitan area

As a result there were less jobs and less money to pay in wages since resources got allocated to capital investment

He said influx control was "an elitist indulgence for upper class people, mainly whites, who did not want the discomfort of observing slum dwelling conditions" And the long-term condition of workers would be best served by allowing them to move to wherever they would prefer to be, and by allowing employers to establish industries wherever they believed it to be viable.

He said it was assumed that laws like those governing buildings and factories were "in the public interest" or to "protect" the people concerned, but such laws were passed in response to the lobbying of some very small, vested interest groups

He said his proposals were based on universally applicable truths, leading to conclusions that in labour affairs the Government could do more for the people by doing less.

and manpower
Industry

Utilisation to
1980 - The Union
Industrial Coun

(011) 294 177

≠	150
≠	187
≠	190
*	190
*	192
*	333
*	276
*	394
∅	457
∅	544
∅	471
	Total

Registration:
Founded:
Area of Operat
Officials: Sec
200
Job
156
Address: 25

1980
1979
1978
1977
1976
1975
1974
1973
1972
1971
1970
Year

Star 19/5/83

Talks to stagger pay days likely to be held shortly

By Michael Chester

Talks are likely to be held soon between employers and trade unions on the feasibility of introducing staggered pay days for millions of wage-earners and so ease the month-end shopping and traffic chaos.

Initial talks have been held by the labour affairs committee of the Johannesburg Chamber of Commerce.

The issue has now been referred to the Commercial Employers Association for its views, and the attitude of unions in the retail and distributive trades will be tested.

Protagonists believe that most people would benefit if salaries and wages were paid in a staggered pattern.

Supermarkets are expected to be among the first to back the proposals, because of the prospect of a more even flow of sales rather than the present month-end crush.

Banks and building societies are also likely to support the proposals because of the advantages of unclogging pay-day congestions when customers all try to deposit or withdraw cash at the same time.

Much merit

Mr Marius de Jager, chief executive of the Johannesburg Chamber of Commerce, confirmed today that talks were under way.

"The idea has lots of merit," he said, "but there are numerous snags that will have to be disentangled. Not least is the way black families at the moment need to pay rent within a set period near month-end."

"If the Commercial Employers Association approve, we shall run a survey among our company members."

Mr Brian Muskin, regional general manager of the Standard Bank, said: "We welcome the idea. We have already instituted a routine to begin salary and wage payments from around the 20th of each month, spreading pay-outs over several days so that it breaks the month-end jam."

"Staggered pay days deserve a lot of consideration, aside from the potential as a solution to security problems when firms all try to draw vast amounts at one time."

"It is not only monthly pay days that should be staggered. So should weekly pay days."

133
Both
19/7/83 ROH

FCI speaks out on new Bill

By CHRIS FREIMOND
Political Reporter

THE Federated Chamber of Industries would use all available channels in attempting to have free enterprise and the aims and objectives of the programme of evolutionary reform entrenched in the new constitution, the FCI president, Mr Rod Ironside, said yesterday

On Tuesday the FCI pledged support for the Prime Minister's "renewed commitment to the reform process", but expressed reservations about the Constitution Bill

In an interview yesterday, Mr Ironside said the FCI was supporting the "principle of reform" which was needed for progress and industrial expansion, but it was only conditionally supporting the Constitution Bill in its present form

The FCI believed part of the Bill's preamble which stated one of its aims was "to further private initiative and effective competition" was not a powerful enough defence of free enterprise South Africa's economy was "essentially" free enterprise and it should be safeguarded by being built into the constitution

To enable "all men of goodwill" to support the Bill, the FCI believed various issues had to be clarified including

- The various phases in the evolutionary constitutional development
- The institutions and procedures for negotiation and ratification as well as constitutional review
- Whether in due course the present preamble to the constitution would be replaced with a Bill of Rights setting out the basic minimum rights and freedoms of all individuals in South Africa

The Chamber also wanted the Prime Minister's declaration of intent, in his reform guidelines released in Bloemfontein last year, to be included in the preamble to the constitution

The status of the President's Council should also be more clearly defined so that it can be "a true body of review" within Parliament

The constitution should also be more explicit about the "vitally important" issues of budgetary and fiscal procedures

Mr Ironside said yesterday both the Prime Minister, Mr P W Botha, and the Minister of Constitutional Development and Planning, Mr Chris Heunis, had been informed of the FCI attitude. They had not yet responded

The FCI would use the opportunity to put its views to the parliamentary select committee which is to review the Bill following the second reading, he said

133
SA could be 'workshop of Africa' — claim

Post Reporter

IF South Africa's labour and material resources were properly developed the country could easily become known as "the workshop of the African continent".

This was said yesterday by Mr Rod Ironside, president of the South African Federated Chamber of Industries and assistant managing director of Gen-

eral Motors South African.

Mr Ironside was delivering an address at the Port Elizabeth Junior City Council's seminar on "Port Elizabeth in the year 2000", held in the University of Port Elizabeth's auditorium yesterday

Mr Ironside said 75% of South Africa's natural work force was black, and it was of paramount importance that political channels for

black people be established

"People tend to bring their problems with them to work," he said. "This, in turn, has a negative effect on morale and the quality of work

"Therefore it is essential that the everyday life of black people be improved," said Mr Ironside

He said another stumbling block was the lack of

communication between the employer and employee.

The Eastern Cape's reputation for labour unrest had come about because the standard of labour education in the region was high. "This means the labour force in the Eastern Cape is very aware of the deficiencies of the current system," he said

Another speaker at the

seminar, the executive director of the Eastern Cape African Chamber of Commerce, Mr M B Damane, said the position of power among black people had shifted from the older generation to the youth

"It is these people, the youth of today, who will be actively engaged in negotiations by the year 2000," he said

Jobless threat to stability

RDH
24/1/83
133

By HAROLD FRIDJHON

THERE is no reliable way of establishing unemployment figures among blacks in South Africa, but unemployment is high by any Western standard and perhaps represents the greatest threat to political stability

This view was expressed by Mr Chris Saunders, chairman of the Tongaat Hullett group, at the Standard Bank seminar in New York

He said that industrial relations were in a state of flux as a result of changes in labour legislation which in the past had been restrictive and undermined the possibilities and power of black trade unions

Many discriminatory elements of past laws had been reversed and heralded the era of black trade unions

There was limited experience in union relations. Experience gained over the years would not necessarily apply to the changed situation because of cultural differences

The emerging black trade-union movement was divided as a result of intense competition for membership and the scope for union activity was curtailed by the recession.

The wage gap had been closing gradually in the past 10 years, but there was no doubt that when the economy recovered the unions would direct all their attention to wage demands

Wage increases exceeded productivity improvement and the prospect of renewed cost-pressure inflation and reduced international competitiveness were of great concern to South African businessmen

"A further dimension in the field of labour relations is the fact that it was to be expected that a disenfranchised community would grasp at any opportunity to exert a degree of political power," Mr Saunders said

133 ~~133~~ ROM 25/9/83

Ways to reduce the number of strikes

By SIMON WILLSON
Industrial Editor

CAPE TOWN — South Africa's labour relations were more tortuous than those of most other countries because blacks lacked a meaningful form of political participation, delegates to the Afrikaanse Handelsinstituut's annual congress were told yesterday

Mr F H Ferreira, director of industrial relations of Ford SA, told an AHI sectoral congress that labour relations had become one of the country's most important challenges

"It is fruitless to discuss industrial relations in South Africa without also investigating social and political affairs which directly influences labour"

The number of strikes had risen from 207 in 1980 to 394 last year, with the number of man/days lost rising to 365 337 from 174 614 over the same period

Mr Ferreira said limits were being placed on some of the black trade unions' more vocal leadership elements

"One of the consequences of this is that the frustrated aspirations of the black

worker are transferred to virtually the only officially-tolerated forum in which he can air his opinions the trade unions — provided he is willing to run the risk of persecution."

Industrial relations were hindered by socio-political factors and what in most situations would be regarded as a labour problem takes on political overtones with business becoming involved in a black-white struggle

After the Wiehahn Report, the State had comprehensively changed the country's labour affairs, but had not introduced any parallel re-

form in other fields of black affairs

"A characteristic of most strikes which have occurred in South Africa is that, in most cases, their origins were not known beforehand

"Usually employers had to take the trouble themselves to try to determine what a strike actually was about. Often it was found that the causes were not only labour-connected but also ideological"

Mr Ferreira recommended that South African industrialists take the following measures to reduce the frequency of strikes

- Introduce a minimum wage based on either direct negotiations or on acceptable standards
- Revise all fringe-benefit programmes with recognition of special circumstances, workers' financial status and the removal of discrimination
- Formulate a reasonable standpoint on trade unions and make it known to the workforce
- Improve channels of communication
- Encourage workers to participate in employers' programmes

AHI 133 backs ~~2001~~ 'new 2001 deal' 27/5/83

By SIMON WILLSON
Industrial Editor

CAPE TOWN — The new president of the Afrikaanse Handelsinstituut, Mr Hennie Klerck, yesterday aligned the AHI with other national business organisations in pledging its support for the Government's new constitutional proposals

Mr Klerck, managing director of an advertising agency KMP-Compton, was installed as president at the AHI's annual congress in Cape Town yesterday

"I propose that the AHI give its wholehearted support to the constitutional proposals and to the process of reform," he said.

The AHI appreciated the great problems that the authorities had at present with the process of the rationalisation of society, the search for labour peace and for an increasing growth rate to ensure work opportunities for all the people of South Africa

He assured the Government of the AHI's full support, but said it would not abdicate from its role as an opinion-former and sounding-board for matters of national importance

He said the external image of the AHI would be promoted during his year in office, as there was still room for more awareness of the role of the organisation

An emphasis would be placed on helping the small businessman, because present conditions did not allow the small businessman to tread a lone path. The business environment was too demanding and its problems too complicated to be handled adequately by the individual entrepreneur.

The AHI would continue to strive for contact with black businessmen in both the urban areas and the national states.

The findings of an AHI investigation into structural inflation would emerge during the next year and would receive top priority

Factors needed for stimulation of growth in industry

133

ε. Post

30/5/83

Post Reporter

GROWTH in the Port Elizabeth-Uitenhage area could be stimulated by labour stability, increased productivity and efficiency in industry, according to a leading industrialist, Mr Fred Polacsek

Speaking at a Uitenhage Toastmasters dinner at the weekend, Mr Polacsek, managing director of Hella, said industry and development in the area had suffered severely because of labour problems and that compared with national development "we have gone backwards"

"For every hour lost, be it through inefficiencies or even strikes, we lose to our competitor, whether he be local, national or international. We could either find investment diminishing or disinvestment in our area," he said

"Labour, as a major component to industrial and commercial development, must realise the need for stability. Trade

unions and employee representatives must be well advised to realise the need to be competitive

"More than in the past, labour productivity and efficiency will determine the existence and expansion of industry and commerce"

Whatever changes were required to ensure a solid future should be found on a peaceful basis because violence would only bring about retaliation and harsh reaction

He stressed the need for communication between employers and labour leaders and criticised the Chambers of Industry and Commerce and other development committees in the region for not having trade union or labour representatives

"I know there are responsible people in the labour movement," said Mr Polacsek. "We must accept them, talk to them and make them understand our problems and our aims

"In turn, our employees, their leaders and our peoples of the area must accept the need to be responsible at all times

"I believe that we and the State must take the responsibility and look after our sick, the infirm and the elderly. But I believe equally firmly that we must not shelter the lazy, the work-shots and the drop-outs

"I do not accuse or excuse either employers or employees, but I do not remember responsible employers making irresponsible statements. Perhaps it can be said that employers in the past did not respond quickly or frankly to the media

He said labour restrictions, some of which had been removed, had left an enormous burden and that hundreds of millions of rands were required to provide housing, schools and training for the predominantly black and also the coloured populations

Bosses of SA are expelled

Labour Reporter

Jan 11/68

An influential South African employers' organisation was expelled this week from the Geneva-based International Organisation of Employers (IOE).

The South African Employers' Consultative Committee on Labour Affairs (Saccola) was expelled on Monday as a result of lobbying by African employer federations

A statement issued by Saccola said that the decision to expel it was taken on the ground that South Africa was not a member of the International Labour Organisation and therefore Saccola could not represent its employees internationally.

Twenty-eight African employer federations were under pressure by their Governments to resign from the IOE if Saccola was not expelled, the statement said

Saccola was represented at the meeting by Mr Johan Liebenberg of the Chamber of Mines, Mr Chris du Toit of the Federated Chamber of Industries and Mr Bill Hamilton of the Building Industries Federation of SA.

Before the decision to expel Saccola was taken Mr du Toit told the IOE council that such a move would mean that the credibility of the IOE would be jeopardised and it would no longer be democratic or representative of "free employers", the statement said

Saccola had deeply regretted the IOE's decision and said it had received messages of support from other IOE members

SA EMPLOYERS OUT

FM 3/6/83 (133)
The SA Employers' Consultative Committee on Labour Affairs (Saccola) has lost its membership of the International Organisation of Employers (IOE)

At a meeting this week of the IOE general council, it was decided that if a country is not a member of the International Labour Organisation (ILO) an employers' federation representing employers in that country cannot be a member of the IOE

An amendment to the statutes of the IOE makes provision for the organisation to accept employer federations on a two-thirds majority vote even if their country is not a member of the ILO However, this did not prevent Saccola losing its membership

Sources at the meeting say 28 African employer federations were under pressure from their governments to terminate their membership of the IOE if Saccola remained a member

Saccola chairman Johan Liebenberg says he deeply regrets the general council decision However, although this loss of membership represents yet another step towards excluding SA from international forums, it is not necessarily a severe blow to SA employers In recent years, some have found the bilateral links they have created with employer bodies of countries with substantial investments in SA have been far more useful to them than membership of the IOE

IOE expulsion closes SA channel to ILO ³³ ^{Quest} 5/6/83

By Julian Kraft

SOUTH Africa's expulsion this week from the International Organisation of Employers (IOE) brings to an end a long-standing channel of communication this country has had into the powerful International Labour Organisation (ILO)

The IOE is the employers' world body on labour matters, and South Africa has been represented there by the SA Employers Consultative Committee on Labour Affairs (Saccola).

Since it lost its direct representation in the ILO in 1964 it has made use of the IOE as a lobby to argue its case in the ILO. Now it has lost this platform.

South Africa's expulsion, which

could be achieved only through a change in the IOE constitution, highlights the extent to which the body, like the ILO, is politicised.

Commented Dr Johan van Zyl, executive director of the Federated Chamber of Industries (FCI), a member body of Saccola: "South Africa's labour legislation is today as free of discrimination as the best of ILO members."

"This has had the effect of undermining the unity of the Organisation of African Unity (OAU), which is torn by much disagreement but is held together almost solely by its members' common opposition to South Africa

"By complying with ILO labour

principles, we have threatened the only thing holding the OAU together.

"Consequently, although we have many friends in the IOE, including African members, the pressure by African governments on their employer bodies to push us out of the organisation has intensified."

He said that most IOE members realised that more could be achieved in removing discrimination in South Africa through South Africa's continued membership than if it ceased.

"Since there are no longer any grounds for attacking South Africa on the labour front, other means had to be resorted to."

Thus South Africa's expulsion was achieved on the basis of a constitu-

tional change to the effect that a country which is not a member of the ILO cannot be a member of the IOE.

A total of 28 African employer bodies were under pressure from their governments to terminate their membership of the IOE if South Africa remained a member.

Chris du Toit, one of the Saccola representatives, stated at the meeting in Geneva that the move called the credibility of the IOE into question and that the body was no longer representative of free employers.

And Johan Liebenberg, chairman of Saccola, disclosed in a statement that a number of IOE members wish to maintain links with South Africa unofficially.

The future of the South African Employers' Consultative Committee on Labour Affairs (Saccola) hangs in the balance following its expulsion from the International Organisation of Employers (IOE)

Saccola represents SA's major employer federations. Its IOE membership was terminated last week (*Current affairs*, June 3) when the IOE's general council agreed that if a country is not a member of the International Labour Organisation (ILO), an employers' federation from that country may not be a member. SA withdrew from the ILO in 1964. An amendment to the IOE statutes allows it to accept employer federations on a two-thirds majority vote, even if their country is not a member of the ILO. But this did not prevent Saccola from losing its membership.

Questions now arise about Saccola's future role, as it has been primarily geared towards representing SA employers at the IOE. Indeed, as Saccola chairman Johan Liebenberg points out, this was the main reason for its existence.

"We will now have to meet and reconsider our future," says Liebenberg. "We will have to decide whether to continue as Saccola — and if we do, what our function will be."

Will this result in the demise of the Saccola/Urban Foundation Code of Employment Practice which is subscribed to by many companies in SA? Liebenberg does not rule out the possibility of the code being preserved, even if Saccola is disbanded.

Urban Foundation executive director Robin Lee says the foundation will obviously have to await Saccola's deliberations about its future. The foundation's policy has been that it is committed to promoting the code "in the short to medium term," he says.

"The view we have taken is that while we are continuing to promote the code, a situation is emerging where conditions of employment are becoming the subject of genuine negotiation between employers and employees. To that extent, in the longer run, the role of a non-company code could decline as it is replaced by negotiation."

Migrant decision hailed

E-port
25/6/87
133
~~20/3~~

SOUTH AFRICA's top industrialists met in Port Elizabeth this week and hailed the Government's decision to accept the Appeal Court's ruling on migrant workers

Referring to the "Rikhoto case", in which the court upheld a migrant worker's claims to permanent rights in an urban area, the executive committee of the SA Federated Chamber of Industries said in a statement

"It can be assumed that the process of urbanisation can now occur in an orderly manner, which is essential to the development of a stable and productive industrial workforce"

The statement was released following the excom meeting on Wednesday and Thursday

The chamber was also currently preparing a further submission to the Select Committee on the Constitution Bill, said the statement, which aimed at ensuring that in time progress on the constitutional front will be in step with the development of the black urban community

"The chamber sees this as essential to meet the rising aspirations of the black urban workforce in South Africa on which the economic future of South

Africa heavily depends"

The impact of the crippling drought on the economy was debated at length during the meeting, and the chamber said it believed that the full effects of the drought "are yet to work through the economy and are likely to hamper the recovery process in 1984

"Excom also reviewed the emergency and contingency measures which have been introduced in various areas to conserve water and sustain the critical electrical power generating capability"

According to the statement, the Chamber of Industries "fully supports all necessary water conservation measures to maintain water and electricity supplies which already are critical in some parts of the country

"Delegates to the FCI Excom meeting believe that the situation can be contained provided that the necessary conservation measures are accepted and strictly applied

The Regional Chambers of Industry have undertaken to continue to urge their member companies to apply the necessary conservation measures and to cooperate with local authorities in this national effort

Assocom warns on high cost of reform

RD 01
27/83
133

By JOHN MULCAHY

AN article in the Associated Chambers of Commerce review raises serious questions on the economics and tax implications of the new constitutional proposals.

Pointing to the vigilance of the business community, which has led to the postponement of the fringe benefits tax, the article stresses the need for similar vigilance on the proposed constitutional changes "to dampen official ardour to raise money to pay for all the idealistic plans and programmes which will flow from the new constitutional dispensation".

"Almost immediately money will have to be raised to support the vast new bureaucratic infrastructure which will be part and parcel of the devolution of power

"Money will also have to be found for regional development and for other recommendations which have been made for the betterment of the country and its people"

Professor Jan Lombard, economic adviser to the Reserve Bank, told an Assocom tax symposium that the constitutional change were likely to give rise to a revolution of rising expectations of what the Government could and could not do.

"Chances are also that the economics of the tax implications of these expectations will be seriously neglected in the political bargaining processes.

"The question then is whether this kind of New Deal political economy will not firstly push State spending and taxation beyond the levels of fiscal soundness, and secondly, transform the South African economy into one which will be chronically suffering from high inflation and low real growth."

The Assocom article says the danger of overtaxation is implicit in the devolution of power because each authority will claim the right to tax.

Each will need money to pay for its functions, and the question is where the money will come from

One of the most important questions is whether there will be one money bill, or whether each chamber will have the right to raise funds

to finance "own" affairs

"If there is one budget with allocations made to other chambers will this not be regarded as denigrating the powers and authorities of those chambers?"

Further down the ladder, will local and decentralised areas of administration and power have the right to raise money to finance their own needs, or will they have to depend on central Government hand-outs?

There is a strong argument that if administrations are allowed to proliferate, the central Government will lose control of fiscal and monetary policy, with the threat of overspending, deficit spending and of the money supply getting out of control, resulting in runaway inflation

The article quotes the 1969 report of the Franszen Commission "Where various tax authorities impose different taxes on the same persons and incomes, the maintenance of an integrated fiscal policy is impeded"

Mr Mickey van der Walt, the Commissioner for Inland Revenue, said at Assocom's symposium. "The ease of collection (of taxes) could lead to proliferation of levies, duties, etc, which although taken individually appear to be

innocuous, can collectively add significantly to costs

"This effect can be greatly exacerbated if the duties and levies are not imposed by the central fiscal authority which has regard to the overall view of the level of taxes in regard to the whole economy, but by various other boards, bodies and agencies"

Mr Van der Walt said this not only led to a proliferation of taxes but to a proliferation of fiscal authorities, each requiring staff and laying a different administrative burden on the tax-paying public

Mr Van der Walt was not referring specifically to the implications of the constitutional proposals but to the existing situation which allows boards, committees and other local administrations the right to tax.

From a business and economic viewpoint the prospect of every legislative body being given the right to tax is a nightmare, according to the Assocom article.

Unless there is overall control on spending, it argues, government at all levels will again start swallowing too large a share of the national income and wealth, leaving the private sector with less money to finance reinvestment and growth.

he argued, be legally entitled to stop work in protest

It was also argued that the employer's right to fire workers without giving reasons fell away when a company had a set disciplinary procedure — as many do

The employer would then be bound to stick to the procedure if faced with a stoppage. If as most procedures do, it provided for a hearing for workers accused of an offence, the company would have to give each alleged striker a hearing before firing him

These issues may not be tested in the court's judgment on this case

Much of the argument concerned the facts of the case, with The Star denying that it had breached its agreement with MWASA

So the ruling could simply give the court's view of these facts, rather than of the broader issues

But the judgment should give at least some idea of the court's stance on these issues

(133) □ □ □ RDM 27/6/83

It was, perhaps not surprising that Dr Piet Koornhof would seek to introduce legislation watering down the Rikhotso judgment on migrant worker rights

What is surprising is that the American government and influential employer bodies like the FCI and Assocom have welcomed the Government's decision to introduce a Bill curbing the rights of migrants who qualify in terms of Rikhotso to live with their families

The only key business body to warn against this aspect of Dr Koornhof's announcement was the Urban Foundation

Worker and emerging union concern about tougher influx control is growing, and much of it is centred around opposition to Dr Koornhof's planned Orderly Movement of Black Persons Bill

The proposal to link families' city rights to "approved accommodation" duplicates a key measure in the Bill

If workers and unions decide that employers approve of this measure, it could become a labour relations issue

Labour rule is criticised

RAM

2/6/83

Labour Correspondent

IN-AN unusual move, the Chamber of Mines has criticised a key aspect of the labour law introduced in the wake of the Wiehahn Commission report

In his address to the chamber's annual meeting yesterday, its outgoing president, Mr Willie Malan, criticised the clause in labour law which allows the Industrial Court to take action against employers for "unfair labour practice"

The clause had "potential for considerable damage to labour relations", he said

The chamber wanted it changed so that a dispute of "interest" — for example, a wage dispute — would not fall within the definition of an "unfair labour practice. This should be left to negotiation rather than the law

Meanwhile, the Anglo American Corporation said in its annual report yesterday that the emergence of black unions on the mines was "the most important development" in the industry over the past year

(S)

(S)

(S)

(S)

All races must join in ensuring progress

Dr John Burns, executive director of the Manpower and Management Foundation, acknowledges the complex problems facing this country but remains optimistic about the prospects for sound economic growth.



That events in South Africa during the next decade will prove more crucial than any in our history is undeniable

A burgeoning black population, changing political dispensations, emerging black trade unions, low productivity, pressures from within and without, are but some of the forces shaping events in this decade

Despite the problems inherent in these factors, I remain optimistic because of the calibre of person with whom I share responsibility for the future

The Manpower and Management Foundation has trustees and directors committed to the promotion, within the free enterprise system, of progress and prosperity through the development, optimal utilisation, and fair treatment of all people in Southern Africa

These men and women, representing all race groups, agree with Dr A M Rosholt who says in a submission to the Economic Affairs Committee of the President's Council, that "the future can only be achieved in an evolutionary way if our economy is basically sound and strong

Among factors contributing to sound economic growth in South Africa are

- Continued growth of the mining industry
- Entrepreneurial skills which have established South Africa as the industrial and business giant of Africa
- South Africa's public and private financial leadership which is respected internationally
- Developed infrastructure and international trading links
- Small business development
- Emergence of world-class major business groups

However, there are serious factors mitigating against economic development which could result in serious economic and political problems. Some of these are

- Increasing shortage of qualified managerial staff
- Critical backlog of technically-qualified blacks

- Inadequate understanding by many managers of the role of black trade unions
- Inferior quality of non-white education and training
- Growing unemployment exacerbated by drought
- Low productivity
- High inflation
- Negative attitude of many blacks towards the free enterprise system
- Regulations denying blacks freedom of movement in pursuit of work
- Land tenure regulations prohibiting freehold title for blacks in urban areas
- Exclusions of urban blacks from political decision-making

If our ability to initiate political change that will accommodate a wide spectrum of demands is predicted upon a sound and strong economy, do not the foregoing factors spell trouble?

No, because with the emergence of Afrikaans business leaders into the big-league business world the National Party Government is more susceptible to arguments urging the abandonment of ideological policy in favour of economic survival realities

The key to survival is the keen judgment, courage, and integrity of the Afrikaans business leaders. These qualities are not lacking in the English-speaking business community, but it is the Afrikaner who is most likely to prevail upon Government

But no matter how spectacular the economic growth or how equitable a new political dispensation might be, ultimately the fate of South Africa and the sub-continent depends on co-operation by black leaders who must

- Preach the necessity of family planning
- Change tribal land tenure systems
- Ensure intensive, co-operative farming methods are initiated so people can feed themselves
- Enforce nature conservation to prevent

the devastation that is denuding Africa

- Insist on fiscal responsibility

The public and private sectors must support black leaders. Thus all education and training facilities must be rationalised and fully utilised. Educational standards must be equal for all

Development of the human aspiration must be a prerequisite of all development programmes. There must be a commitment by private and public sectors to develop blacks for upward mobility in business and Government.

Local communities must articulate their own needs and, where possible, decide on local resources to meet local needs. Participation in self-determination is a pre-requisite for self-respect

Self-respect, adequate training and equal opportunity are precursors to improved productivity, which will help lower inflation and South Africa will become a more effective exporter of goods. Where Korea, Taiwan and Japan have blazed a trail, South Africa could then compete. And the slice of the economic pie would be bigger for all

This scenario will not unfold today. But a start must be made if tomorrow is to be secured. I, and those with whom I work through the MMF, are committed to a basic belief in social justice and equality under the law for all. The basis for all MMF activities must stem from this premise

The English-speaking business community has long preached (if not always practised) this credo. The pragmatic Afrikaans business leaders are as morally committed as any

With mutual support, trust and co-operation between white and non-white, English and Afrikaans, this decade should see South Africa lead the sub-continent towards a prosperous and peaceful new century

Act damaged labour relations says Malan

UNFAIR labour practices implicit in the Labour Relations Act has caused "considerable damage" to labour relations and collective bargaining in South Africa

In his presidential address to the Chamber of Mines, the outgoing president, Mr W W Malan, said that the application of the practice should therefore be handled with the greatest circumspection

He said the "very unsatisfactory" definition of the practice was of much concern to the chamber, although it was intended as a

measure of protection for labour against exploitation

The chamber has asked that the notion of an unfair labour practice should apply only to conflicts of rights and not to be extended to conflicts of interest

Conflicts of interest should be left to the ordinary process of negotiation between the parties, Mr Malan said.

Referring to labour reforms in the country, he said that they had resulted in very "real and significant" advances in the min-

ing industry

Mr Malan said achievements resulting from amended labour legislation included

- The agreement reached with unions on the training of apprentices of all races in the full range of skilled artisan trades,

- The decision of the three official associations in the industry to open their ranks to all races;

- The agreement reached with the Underground Official's Association on the employment conditions of black, coloured and Asian officials

Business

urged to speak out

133

e-post 8/7/83

Post Reporter

NOT enough businessmen were speaking out on issues which impinged on their ability to carry out the Prime Minister's Carlton Centre mandate on private enterprise, the executive chairman of Barlow Rand, Mr Mike Rosholt, said in Port Elizabeth last night.

Addressing a dinner for business leaders in the city, he gave two examples of the issues he had in mind — "the multitude of controls and regulations which impede all businessmen, white and especially black, and the socio-economic aspects of influx control"

Businessmen could also not avoid "the fact of life" that if blacks were to obtain fairer participation in the free enterprise system they would have to be given a political dispensation acceptable to them.

"History tells us that without a participation in the political decision-making process, people cannot secure satisfactory economic rights," he said.

"What form this should take, and how it will come about, is the quandary to which we do not yet have the answer. But what I do know is that the answer will be easier to find if we businessmen are allowed to develop this country to its full potential, and if we face up to all the implications that that will involve," said Mr Rosholt.

He warned that though businessmen recognised the superiority of the free enterprise system as the one under which all population groups would prosper best, it would be a grave mistake for businessmen to work on the assumption that it would be automatically and irrevocably in operation for all time.

"There is, in my view, a very grave danger that it will in fact be rejected by the majority group in this country — unless it

perceives itself, over a reasonable period of time, to be enjoying its fair share of the fruits of the system"

Mr Rosholt pointed to the "ominous warning" from last month's meeting of the newly-founded National Forum at Hammanskraal, which passed "a very chilling resolution which in effect embraced socialism"

Very few blacks did not have a completely different perception from whites of the free enterprise system. For various reasons, it was seen as an adjunct to a political system which they did not accept.

A critical problem lay in the fact that starting opportunities were not equal.

Even if discriminatory laws and regulations were drastically changed, it would take a long time to achieve practical as opposed to theoretical equality of opportunity, but it was essential that businessmen showed a commitment to that process.

Mr Rosholt suggested

- The adoption of a plan and timetable aimed at the eventual elimination of all discriminatory regulations and practices.

- Much more effort in education and training

- Absolute equality of opportunity and treatment in labour practices and pay.

- Promotion on merit without regard to sex or colour

- Major reforms in influx control and its methods of administration

for signing Naas

cies of the South African Government'

"Mr Botha does not represent the South African Government. He came to the United States to compete as an individual athlete the same as thousands of South African citizens who live and work in the United States"

In a letter to one of the groups, the Washington Office on Africa, Mr Landry said that Botha "is no different from

South African golfers such as Garv Player or South African tennis players such as Johan Kriek and Kevin Curren, who have competed for many years in the US"

He also pointed out that scores of black South Africans, such as the track star Sydney Maree and the soccer star Jomo Sono of the New York Cosmos, had enjoyed success as students and athletes in the US in the past 20 years

Arms of SA labour 'tied' — Relly

Staff Reporter

FREE market forces could not be expected to work effectively if labour had its arms tied behind its back, according to the chairman of the Anglo American Corporation, Mr Gavin Relly

In his annual statement Mr Relly said it would be "self-destructive" to throw open South African industry to international competition while the productivity of our own labour force continued to be impaired by a wide range of restrictions and a failure to provide adequate support and incentive

"The South African economy is at a stage of evolution where the growth of black earnings is not only not at the expense of white, but where there can be little real growth in white earnings without further material gains in black

"The essential point is that the rates at which both move up is partly a function of productivity — in other words the wise and proper development of our human resources"

Deleterious

Mr Relly said formal restrictions on the mobility of black labour were deleterious to productivity

So too were the informal restrictions on the mobility of Indian and coloured workers where lack of housing made it impossible for them to

offer their skills in the best market

"Thus the Group Areas Act becomes, in effect a form of influx control further restricting labour mobility, individual advancement and economic growth"

Shrank

The Government had taken some steps towards allowing black people to compete in industrial society but it shrank from allowing them to enjoy the fruits of their labour and improve their life-styles

"Increasing opportunity for personal industrial success must be accompanied by demonstrable social success within the totality of South African society, unencumbered by the restrictions of the Group Areas Act and the inhibiting psychology which flows from it"

"If we can get on with this task, difficult and complex though it is, I see no reason why South Africa should not be capable of competing effectively with international industry both at home and abroad," Mr Relly said

'Avoid strife' — warning by NGK

Religion Reporter

THE Ned Geref Kerk leadership has deplored "the sin of fraternal strife bitterness and possible schism among Afrikaners

The NGK executive committee referred specifically to the Government's constitutional proposals as the subject of Afrikaner division

The church whose propagation of the apartheid doctrine resulted in its suspension from the World Alliance of Reformed Churches last year has not referred to divisions in other population groups

ACT

But it has called on its members to act against divisions within Afrikanerdom

Die Kerkbode, official organ of the NGK, today carried a front page report headed Vermyn Broedertwis en Bitterheid (Avoid Fraternal Strife and Bitterness), containing the text of a statement by the NGK national executive

"The executive committee of the General Moderamen notes with concern the serious problems and divisions in the ranks of the Afrikaner people about the Government's Constitution Bill

CAMPS

"Although the church may not be directly involved in the conflict, which is taking place at the political level, it is

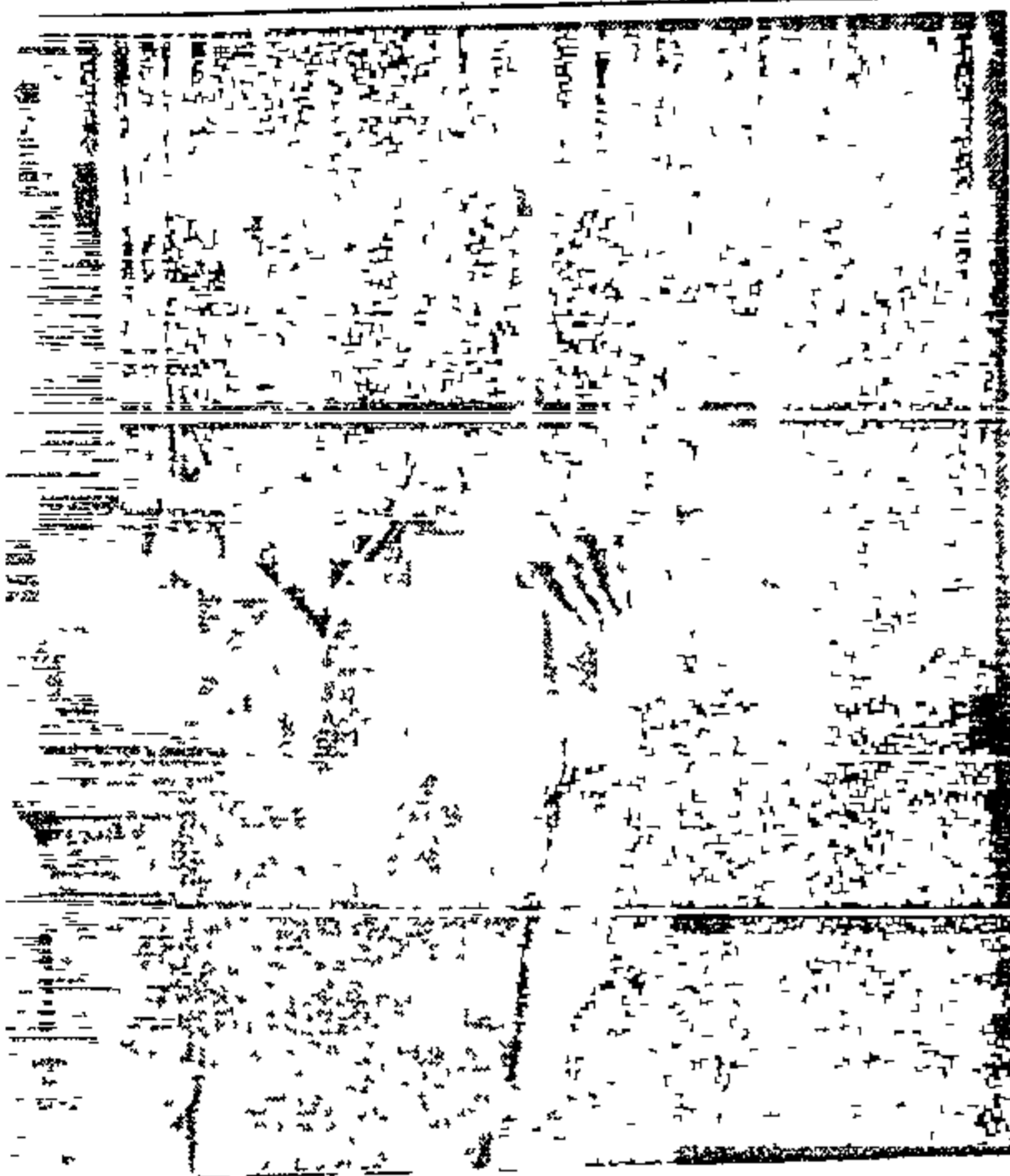

... into Mexican attorney Victor Luna as his new wife Sally Hay, right, in Taylor's attire in New York after a performance by ... twice married to Miss Taylor, was married to Sally Hay on July 2.

.. 714 verses to go

raise funds for a group which promises "more exciting music" at its autumn arts festival

Concert-goers were sponsored by the hour to listen to the monotony

Wearing a 19th century frock coat with a button-hole carnation Mr Fish said "I'm finding it impossible to learn by heart I still keep having

to look at the music all the time"

Supporters cheered quietly as he clocked the 100th repeat

"Originally, I thought I could play the whole work myself, but I chickened out Dawn is a good musician and I hope this doesn't put her off her studies," he said — Sapa-AP

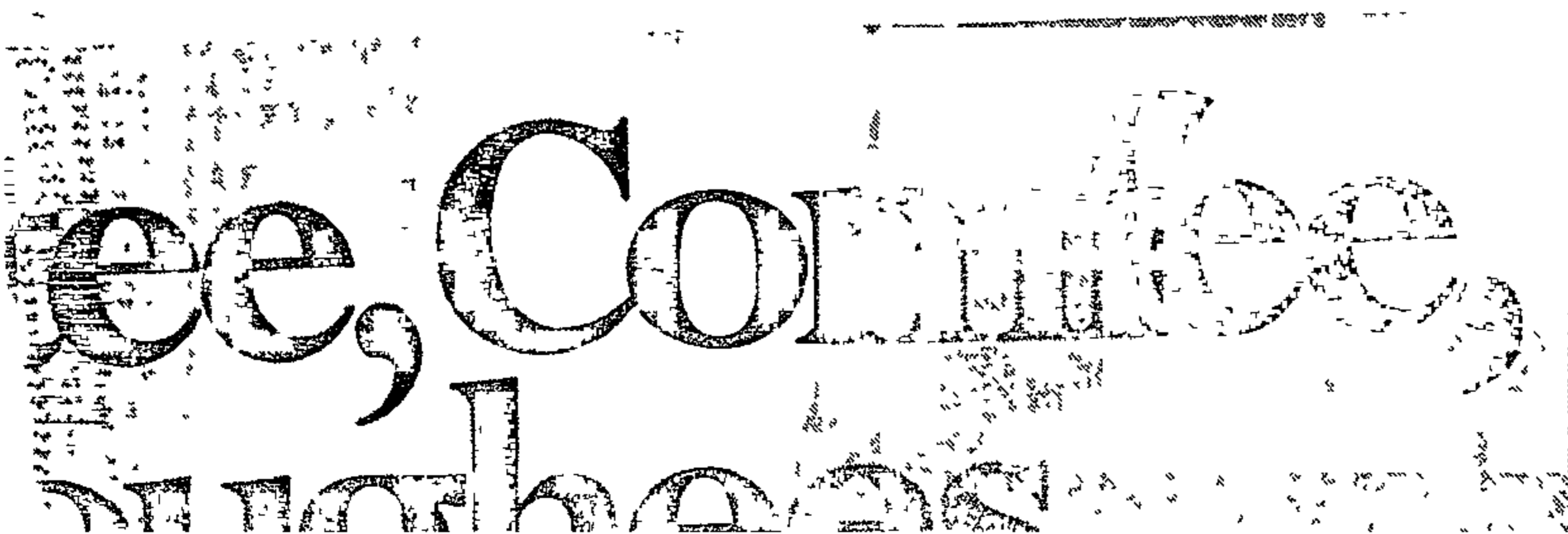

23/7/83 (133)
R250 000 donation
for disabled miners RUSH

MASERU — The South African Chamber of Mines has donated R250 000 to the Lesotho Government towards the establishment of a rehabilitation centre for disabled Basotho mine workers and other disabled people in the country

A cheque was presented to the Minister of Information and Broadcasting Mr Desmond Sixishe, at a ceremony in Maseru on Thursday, reports Sapa

The donation was handed over by Mr J A P Fitzsimmons, manager in Lesotho of the Employment Bureau of Africa (Eba), which recruits Lesotho mineworkers for the

South African gold mines

MIKE PITSO

reports that Mr Fitzsimmons expressed appreciation for the good co-operation between the Lesotho Government and the mines and said this co-operation had lasted over the past 80 years, during which time over one-million Basotho had worked in the mines

The centre will also help mine workers who are paid disability in the South African mines

There are at present more than 140 000 Basotho working in South Africa, of which more than 80 000 work in the mines

(133) E. Post 23/7/83

MCI now represents 275 firms

Business Editor

THE Midland Chamber of Industries — established 66 years ago as the Midland Manufacturers' Association — has today grown to an organisation representing 275 manufacturing companies

Addressing the MCI's mid-year general meeting this week, Mr Wally Life, president for 1983, analysed its membership composition

and the demands this placed on its management

Mr Life, chairman and managing director of Good-year (SA) Pty Ltd, isolated the following major features of the MCI's membership

- The multi-national companies in the chamber employ some 40% of the workforce of 74 000

- 101 companies — just over one third of the member companies, employ

only 2% of that total workforce

- At the other end of the scale just three companies employ 25% of that 74 000

- Only 15 member companies employed in excess of 1 000 workers each, and together they accounted for 48% of total employee strength

The implication for the chamber of this diverse membership, said Mr Life, was that the future of a vast majority of the smaller companies "was directly linked with the success of failure of the group of 15 companies employing 48% of the workforce"

"As a significant portion of those 15 companies are multinationals, we can conclude that management style, product quality standards, international attitudes and legislation established by the multinational companies here in Port Elizabeth/Uitenhage will ultimately affect the entrepreneur who employs 10 or 12 people," observed Mr Life

Mr Life said a few years

ago the MCI had embarked on a programme of introducing modern management methods into its administration

"This was later expanded and incorporated into a five-year business plan, details of which the chamber staff has nearly completed. This means that very soon the direction that the chamber will follow over the next five years will be clearly defined

"In other words each of the three major groups I mentioned earlier will easily be able to determine which services meet their specific needs"

Mr Life said the chamber promoted "with the zeal of a missionary" the free enterprise system, one which it believed "best rewards any individual or group of individuals for their own effort and ingenuity in converting an opportunity into a success

"The fact that the chamber's membership contains a very large percentage of small manufacturers shows that the industrial environment of Port Elizabeth/Uitenhage provides the opportunity for the individual with the ability and spirit to venture into business for his own account and to succeed."

Forum on recognition agreements organised by committee of MCI

133 E Post
4/8/83

THE implications of entering into a recognition agreement with a trade union are very broad, and a number of disputes resulting from such agreements have already been referred to the Industrial Court which have resulted in some rather interesting, if not controversial judgments

With this in mind, the Human Resources and Social Services Committee of the Midland Chamber of Industries has organised a forum on the legal consequences of entering into a recognition agreement and its implications for industry

The objectives the forum

will be setting out to achieve are

- To define a recognition agreement in the South African context

- To determine the consequences of entering into recognition agreements with a registered trade union or an unregistered trade union

- To establish the legal status of recognition agreements and to look at the channels of redress for breaches of recognition agreements in terms of common law and the Labour Relations Act

- To establish the consequences of entering into a

recognition agreement where an industrial council agreement is already in force

- To isolate what factors should be taken into account when negotiating a recognition agreement

The format the forum will take will be an introduction to recognition agreements by Prof Roux van der Merwe, Chair of Industrial Relations, University of Port Elizabeth

A case study will then be presented by an industrialist who has already entered into a recognition agreement

This will be followed by a discussion by Prof Johan

Piron, School of Business Leadership at Unisa, on the legal consequences of entering into a recognition agreement and its implications for industry

The forum will be held in the main sale room, PE Wool and Mohair Exchange, Grahamstown Road, Port Elizabeth on Thursday, August 25, starting at 10 15am

The cost of the forum will be R20 per head, or where a company sends more than one delegate the cost will be R15 per head and reservations can be made by contacting either Mr Max Hoppe or Mrs Rina Bell at ☎ 544430

MCI backs private transport services

~~219~~

~~212~~

133

E. Post 24/8/83

THE Midland Chamber of Industries in its latest newsletter staunchly defends increased competition for private transport

Opposing recommendations to phase out "Kombi-type" taxi services, the MCI says such ventures provide "an effective channel for drawing black businessmen into the free enterprise system"

In its commentary the MCI echoes concern expressed on the issue earlier by its parent body the Federated Chamber of Industries (FCI), which has expressed concern at the "potential for unrest and industrial disturbance that could result from this action"

"Government has often voiced its commitment to the free enterprise system

and has in many instances placed its faith in that system to be the vehicle for raising living standards," says the MCI

"As always the private sector has responded positively to these challenges to the free enterprise system as evidenced by its actions in the field of housing

"Government has also stressed the need for attracting the small would-be-entrepreneur into this "free enterprise" economy, and took steps in this regard when it opened the way with the establishment of the Small Business Development Corporation"

It is against this background, continues the MCI comment, that the contents of the Welgemoed Commission report and its recom-

mendations ought to be reviewed

The FCI in its comment, observed that it was notable that the Welgemoed Commission approved the privatisation of bus services. And to this end it opposes the establishment of a National Bus Transportation Corporation and favours the sale to the private sector of the bus services operated under the Corporation of Economic Development

"Notwithstanding this, the recommendations of the Welgemoed Commission basically favour more centralised control, greater regulation and the curtailment of competition over established services, whether publicly or privately owned

"Furthermore, to the ex-

tent that inefficiencies in the transport system give rise to the need for subsidisation of passenger services in excess of R800 million a year, the commission does no more than recommend that new sources of tax be raised (mostly from employers) in order to cover these (growing) losses

"It is thus a matter for regret that the Welgemoed Commission did not see fit to move towards a more open competitive transport structure"

The MCI concludes with the observation that the Government should not accept recommendations "that will inhibit the entry of the small black entrepreneur into the economic system that everyone purports to support"

Tucsa is fighting for its life

ARGUS 3/10/83

Inter-union tensions come to head at PE congress

By PIPPA GREEN, Labour Reporter

THE 29th annual conference of the Trade Union Council of South Africa has ended on a low note, amid strong predictions that it is in the throes of a slow death.

Held at the plushest hotel in Port Elizabeth last week, the four-day conference saw tensions within the 57-member body come to a head with one of its largest affiliates, the SA Boilermakers' Society, threatening to consider withdrawing.

The Boilermakers' Society, along with a handful of other dissenters, indicated that some unions saw the greatest threat to Tucsa's existence as coming not from employers, but from the independent trade union movement.

Strong feature

And, indeed, the frequent attacks on the mainly black independent unions were a strong feature of the conference. Delegate after delegate accused the "emerging unions" of causing chaos by organising members in factories where Tucsa affiliates had been operating for years.

Mr Robbie Botha of the Mines Surface Officials' Association went so far as to describe unregistered unions as an "infant Frankenstein".

A resolution calling for a ban on unregistered unions was adopted by an overwhelming majority of delegates.

Bad Press image

It is well known in labour circles that many workers have been won over from Tucsa unions by the independent unions. Also, an increasing number of employers are saying they would prefer to deal with

"representative" unions, rather than those which for years have relied on closed shop agreements to keep their members.

Delegates also voted for an increase in affiliation fees to the council, to enable it to provide "more dynamic" services for members and so improve its "consistently bad Press image".

However, the 56 000-strong Boilermakers' Society said Tucsa's bad image was the result of a lack of commitment to unity in the labour movement.

Speaking against the fees increase proposal, Boilermakers' secretary Mr Ike van der Walt said he had dealt with several unions outside Tucsa and had found "unionists just as good if not better than in the Council".

"What we are dealing with is an inter-union war, and it would appear that, for some delegates, the main motivation for supporting the proposal is that they think that for Tucsa to survive it must destroy other unions."

Meanwhile, the Boilermakers Society has returned to its members to "seriously review" its association with the council after almost every motion proposed by the society — including one asking Tucsa to meet next year to examine its future relevance — was defeated.

"Part of a campaign"

Several delegates responded angrily to the motion, some saying it was part of a "campaign being waged against Tucsa".

One delegate, Mr Freddie Swartz, who broke ranks with his own Leather Workers' Union to support the Boilermakers, said many Tucsa leaders had lost contact with the workers they claimed to represent.

Those who defended Tucsa recalled its "glorious past".

Mr Louis Petersen of the Western Province Garment Workers' Union, said Tucsa deserved "bouquets" and not criticism.

"Tucsa is responsible for legislation which has been to the good of workers in South Africa, and other people are now enjoying the privileges," he said.

Principles sacrificed

However, critics of the body claim that in its early years Tucsa "sacrificed every trade union principle by agreeing to exclude Africans from its unions when it was originally formed".

Tucsa's bar on African unions was lifted in 1962, but imposed again in 1969 after pressure from the Government and white unions. In 1974 Africans once again entered the fold.

In the past few years, a number of strong all-white unions have joined Tucsa and the body has lost two powerful unions in the catering and distributive trade — unions which criticised the body's move to the right.

The Boilermakers' Society, with its increasing black membership, is now being pushed farther and farther away from Tucsa. Several motions proposed by the society, including one calling for workers to have the right to belong to the union of their choice and another calling for a Government investigation

into escalating housing costs, were resoundingly defeated.

Commenting on the conference, UCT industrial sociology lecturer Mr Johan Maree said much of Tucsa's 470 000 membership had been "built on the uncertain foundation of closed shop agreements and employer goodwill".

"If those elements were pulled from under their feet much of their membership would collapse."

Mr Maree said many Tucsa affiliates were out of touch with their members.

"Research on some unions has shown that they do not have any representative structures on the factory floor," he said.

Some employers, who have Tucsa unions operating in their plants, have said that often the workers' only contact with their unions is through a monthly magazine and subscription deductions from their wages.

Call for independent Industrial Court

Sowetan

5/10/83

133

THE harassment and detention without trial of trade unionists has been a "constant worry" in South Africa, the South African Federated Chamber of Industries (FCI) says in its annual report.

The report to be presented at the chamber's conference next week, says it has continued to have discussions with the authorities about "this important issue" since the activities of unions, particularly black unions, have increased.

Referring to development of dispute settling mechanisms the chamber suggested that lack of compliance with the basic requirements hampered unregistered unions in making use of the available machinery

It has recommended to the government that the Industrial Court be part of the independent judicial system of South Africa and that it be open with its judgments and decisions.

The report says that the court, arising from the Wiehahn Report and created in 1979, has begun to make a major impact on industrial relations in South Africa.

"A wide range of disputes are increasingly being referred to it by union parties in particular. The most important question is whether the court should create new rights or merely interpret and clarify existing rights.

"A prime example of

the creation of new rights, is the increasingly implied obligations contained in several judgments that employers should bargain with representative unions. The collective bargaining system has always been voluntary.

"The court's action has the effect of imposing a type of "public good" obligation in this previously free and voluntary relationship, the report says.

The chamber also says that the only way to prevent the court from creating new rights will be to remove the open-ended definition of unfair labour practices and to replace this with specific definitions clearly specified in the statutes.

Workers' new say on funds

Labour Reporter
 (133) Star 5/10/83
 The struggle by the emergent unions to bring pension funds under the control of the workers has been partly successful in the metal industry

There are now four unions, one unregistered, on the board of the Metal Industries Group Pension Fund

A full list of unions represented on the fund, constituted in June this year, was given for the first time yesterday in a union newsletter

The decision to admit union representatives to the board, based on membership size, was taken after pressure from the unions, foremost among them the Metal and Allied Workers Union

The unions argued that several unions with seats on the board did not represent the majority of the workers in the fund

After discussions with the Steel and Engineering Industries Federation of South Africa (Seifsa) it was agreed that only the 10 unions with majority membership in the fund would have seats

An audited certificate check was carried out and the four unions to gain seats on the board were MAWU, the Steel Engineering and Allied Workers Union, the Engineering and Allied Workers Union and the unregistered General Workers Union

This is the first time representation on the fund has been dictated by membership size and not membership of the Industrial Council

It is also the first time that unions with a largely black membership have been put in a position to push for social benefits for workers outside the strict parameters of the pension fund

100 SETS FOR ONLY SINGLE CENT EACH

At Russells 100 lucky people could win a Telefunken 51cm TV sets for only one cent. The numbers have already been called and locked in the safe at Tek Elektron. Anyone who buys a set with one of the computer selected numbers between September 1st and 25th November will have their money refunded in full (less the cost of the set). The winning serial numbers will be published in all Russells stores on December 1st. Remember to keep your purchase receipt and the serial number which is on your instruction booklet, so that you can claim your prize.

45

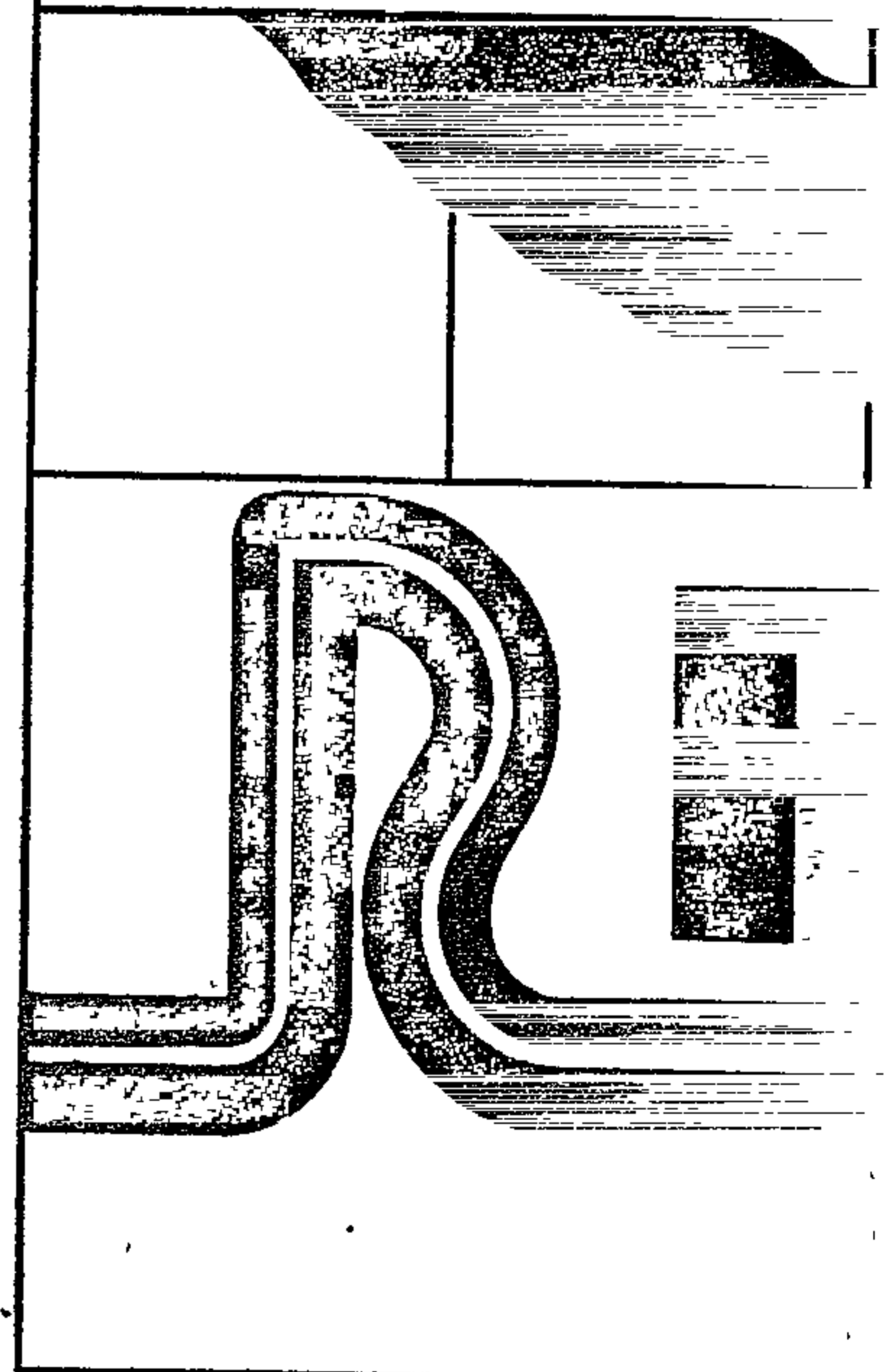

Citizens
 arrest

A second special court was arranged yesterday to accommodate all the accused
 Mr E P H Olivier presided over this court and

of 125

Worried Seifsa wants decision on metal industry unemployment

By PRISCILLA WHYTE

EMPLOYMENT in the hard-pressed metal industries sector has fallen sharply in spite of overtime cuts and short-time working.

The situation is so grave that Seifsa — the Steel and Engineering Industries Federation of SA — wants an early decision on revamped unemployment allowances

Mr John W Nelson, Seifsa president, welcomes the decision to review the Unemployment Insurance Fund.

"Given the likelihood of continuing recession

for some time ahead, it is important that this review is completed as a matter of urgency," he says in the employer organisation's annual report

Metal industry employment declined by 15% — 70 000 jobs — between November 1981 and May 1983. Total workforce in this sector remains, however, at more than 400 000

Output in metal industries has also fallen sharply from the 1981 peak, but revenue continues to exceed R10bn a year

Mr Nelson accuses the Government of succumbing to pressures to "move away from its long-held

policy of promoting secondary industry in SA through moderate and selective tariff protection and export promotion".

It is essential for the Government to continue this policy because of growth potential in secondary industries. The focus should be on inhibiting factors which adversely affect secondary industries' ability to compete with overseas producers

He singles out inflation and the shortage of skilled manpower as the key culprits

A much lower target of 4 500 apprentices was set for 1983 because of the recession

The downturn in the metal industries is the worst since the Great Depression of the 1930s. In the first half of 1982 there was a decline in the production of the major iron and steel basic industries of 30% from the mid-year peak of 1981

output of 546 000 tons in 1982 was the lowest in 10 years. The 1982 output of steel ingots, 8,1-million tons, was down 8,1% on the peak year of 1981

Iron production last year at 6,8-million tons was 7,7% down on 1981 and that of the export-intensive ferroalloy industries at 1,2-million tons was 16,7% below the 1981 level.

Mr Nelson says Seifsa is concerned that the investigation by the National Manpower Commission into registration procedures for employer organisations and trade unions "has not yet borne fruit and that no change in legislation can be expected before 1985"

There is an urgent need to remove the decision-making on representation from the authority of the State if the official industrial relations system is to succeed.

133

RD M

11/10/83



The political line-up for Assocom (from the left): Minister for Constitutional Development and Planning Mr Chris Heunis, Leader of the Opposition Dr F van Zyl Slabbert, the Conservative Party's Mr Frank le Roux and New Republic Party leader Mr Vause Raw.

Politics a key feature of Assocom's 81st congress

STAR

12/10/83 (133)

By Malcolm Fothergill

Politics will feature prominently at Assocom's 81st annual congress in Pretoria next week, from October 18 to 20. Several motions up for debate have strongly political overtones

One of the final items on the agenda is directly political — a series of pre-referendum addresses from leaders of the country's four main white political parties

The subject of the addresses will be the business community's stake in the constitutional debate and in the outcome of the referendum.

Putting the National Party's case will be Mr Chris Heunis, Minister of Constitutional Development and Planning. Dr F van Zyl Slabbert, Leader of the Opposition, will put the Progressive Federal Party's point of view. Mr Frank le Roux will speak for the Conservative Party. Mr Vause Raw will speak for the New Republic Party.

Among the more "political" of the motions down for discussion is a proposal by the Port Elizabeth Chamber that South Africa's central business districts be opened immediately to businessmen of all races.

The motion calls for the repeal of laws which prevent

blacks, coloureds and Asians from being employed as managers in white businesses in white urban areas.

Another motion, from the Johannesburg Chamber, calls for the Government to face squarely the socio-economic problems affecting South Africa and to find "realistic solutions" to them by developing a "vigorous and imaginative urbanisation policy".

ROAD TRANSPORT

Road transport features in two motions

One, from the Johannesburg Chamber, says the system of collecting and allocating funds for roads should be reviewed to (among other things) reduce red tape and require road users to contribute according to how much they use and damage roads.

It says insufficient funds are being devoted at the moment to building and maintaining roads, the machinery for allocating funds is too complex and the introduction of toll roads offers a limited solution.

The Pretoria Chamber wants the Government to study the social and economic effect of "the proposed prohibition of the use of mini-buses as taxis" before it

considers the recommendations of the Welgemoed commission of inquiry into bus passenger transport.

The Cape Town Chamber wants to take Minister of Finance Mr Owen Horwood up on comments he made in his 1983 Budget speech, saying the private sector should obtain an interest in public sector corporations.

It wants the Government to consult the private sector as soon as possible on "the best manner in which Government can divest itself of part of its interests in certain state corporations".

Three papers will be delivered at a symposium on the first full day of the congress, October 19.

Dr Chris Stals, senior deputy governor of the SA Reserve Bank, will speak on the world economy.

Mr Marius de Waal, managing director of the Industrial Development Corporation of SA Ltd, will speak on the outlook for the South African economy.

Professor Jan Lombard of the department of economics at the University of Pretoria will speak on the economic and business implications of constitutional reform.

The FCI urges new policy on blacks

(133)

Star
17/10/83

Own Correspondent

CAPE TOWN — Attainment of South Africa's formidable growth and employment targets in the decades ahead will depend largely on the extent and nature of reform, said the president of the Federated Chamber of Industries

Mr Rod Ironside was speaking at an FCI banquet in Cape Town, after being elected president of the organisation for a second term

In the immediate future, the transfer of skills to more people demanded attention.

Black education, and housing in urban areas were also vitally important.

Social Policy

"In its submissions to the select committee on the constitution, the Chamber urged that a co-ordinated social policy for urban blacks should be introduced.

"This policy should help people to lead a proper family life, to acquire a home, vertical and horizontal mobility in employment, and to attain personal goals through education and training

"People should have an environment free of fear of persecution, intimidation and harassment," said Mr Ironside

Vice-presidents

The FCI vice-presidents are Mr J R Wilson of Shell SA, Cape, Dr H Snyckers of Noristan Laboratories, Northern Transvaal, Mr N E Duncan of Tongaat-Hulett's, Natal, and Mr J H Viljoen of Coca-Cola, Transvaal

Mr Duncan and Mr Viljoen are newly elected, while Mr Wilson and Dr Snyckers were re-elected

Mr Ironside, of the Midlands Chamber, is deputy managing director of General Motors SA

2/11/82 (133) Star 19/10/82

FTA will 'right wrongs' against furniture buyers

By Joe Openshaw, Star Line

Consumers shopping at dealers who are members of the Furniture Traders' Association are guaranteed protection against raw deals and shady trading practices

This was the pledge given Star Line and the public by Mr S F Redelinguys, director of the FTA, who promised disciplinary action and even the imposition of fines on members failing to right wrong the association by the public and which the association, on investigation, felt were justified

"We would like to assure the public a thing like consumer protection is alive and well and kicking, but it must be based on thorough investigation and not be at the expense of the trader," he said

He urges the public to deal with stores displaying FTA emblems and which subscribe to the association's code of ethics

This code and constructive suggestions to would-be purchasers drawn up by the as-

sociation on how to approach buying furniture are published below

Mr Redelinguys stressed many problems and complaints arising out of consumer/trader relationships were often due to a breakdown in communication between them

GUARANTEE

Inviting any who felt they had been given a raw deal by traders to bring their complaints to the FTA, Mr Redelinguys assured buyers the likelihood of any problems they may encounter not being solved was "remote indeed" if they shopped at stores displaying the association's emblem

"We guarantee to the public who shop at FTA if they pick up problems they will be thoroughly investigated and solved," Mr Redelinguys said.

In the past two weeks Star Line has referred a number of thorny complaints to the FTA and they were unravelled and settled promptly and satisfactorily

"There is no room for fly-by-night or dishonest furniture dealers in the FTA

"We don't mind exposing any member as long as we are sure the investigation has been fair to all concerned, the consumer and trader Our ideal is the moment a new customer enters the shop he is met by staff trained to explain the financial implications of cash, lay-by and hire-purchase agreement transactions

"As the customer leaves the store he should be stopped by an assistant whose job it is to discover how much the customer understands of the type of transaction entered into," said Mr Redelinguys

Direct complaints to the association can be sent to Furniture Trader's Association, PO Box 5492, Johannesburg 2000



Mr Sieg Redelinguys . consumer protection is alive and well in the furniture trade.

Code of ethics designed for overall cover

By Joe Openshaw, Star Line

The Furniture Traders' Association of South Africa was established in 1931 and represents 90 percent of furniture retailers.

The FTA was one of the first trade associations which agreed to subscribe to a code of business ethics.

The FTA is recognised by consumer bodies as well as the Government and while protecting the interests of its members is aware of the needs of the public and invites consumers to come to it with problems.

Its code of conduct was adopted with the blessing of the Department of Commerce and Industries in 1975, and stipulates the following clauses considered important to maintain high stan-

dards in the industry and guard against bad business practice:

● The phrase "No Deposit" shall not be used in public advertisements.

● The cash price of all goods must be stated on the items, in advertisements, catalogues or publications.

● Once the order for an article has been received there cannot be an increase in price.

● A buyer purchasing on credit has the right to cancel an order within 48 hours of signing it or before delivery and all monies must be refunded to him except where the order was for goods cut or made to the customer's specifications.

● There must be a record of goods sold on lay-by and the price of these goods cannot be altered before delivery.



● Credit standing of customers must be properly established to find out whether they can afford to pay for goods they want to buy.

● Voluntary repossession will be carried out only as a last resort and such a request must be confirmed in writing, allowing the buyer 21 days from date of repossession to meet his obligations.

● If a complaint is lodged with the offices of the association against a member, the dealer undertakes to honour his obligation under the code and consents to corrective action by the association's disciplinary committee.

The public is advised to look to the FTA emblem or the code of conduct on display as solid guarantees of protection.

Cash shoppers score . . . credit buyers must be wary of pitfalls

By Jennifer Tennant, Star Line

Become a knowledgeable shopper be aware of the intricacies of buying goods and know your rights

This is the exhortation made by the Furniture Traders' Association which welcomes reasonable complaints the public may have in regard to deal with members or the furniture trade generally

Star Line has a list of suggestions drawn up by the FTA and designed to help the consumer

Buying goods can be done in three ways

- by cash payments,
- by lay-byes, and
- on hire purchase or credit

Paying cash for goods is obviously the best way to shop Funds are available and the goods become yours as soon as payment is made.

Often people making cash purchases are able to get discount offers that are not available to other shoppers.

Buying goods by lay-by is when an agreement is signed between the shopper and the shopkeeper Here a deposit is put down for goods immediately and an undertaking is made to pay a certain amount of money every month until the full amount has been paid.

Only then can the goods be collected from the store and become legally the shopper's

The agreement may not, by law, extend for more than six months

If the full payment has not been made by this time then 10 percent of the money paid is forfeited to the store concerned

Hire purchase (HP) agreements, which can extend for any period between six months and two years,

have certain rules which have to be adhered to in terms of the Credit Agreements Act

A written agreement must be signed by both parties if goods are bought on credit for a period that extends over more than six months, and no credit agreement is allowed to extend for longer than 24 months

When buying goods on HP a minimum deposit of 10 percent has to be made, although some stores charge more than 10 percent on the initial deposit Goods can be bought on credit, on an open account, without paying a deposit or signing an agreement

A minimum sum is set down for the repaying for goods bought on HP

Goods bought on HP belong to the shop until the entire debt has been paid Therefore the store has to be told in writing of any change of address and has to give permission for the removal of the goods.

If payments are not met goods can be repossessed, or reclaimed by the store These cannot, however, simply be removed from the purchaser's custody

The goods can be taken back by the shop if

- a voluntary repossession order is signed, cancelling the agreement and allowing the store to collect the goods, or
- a court order is received The store sends a written warning notice by registered mail that action will be taken A second notice is sent 30 days later if the initial letter is ignored Two weeks after this move a court order can be issued for the repossession of the goods, which are then collected

Advice to shoppers

- Shop around for the lowest prices
- Work out a budget before shopping
- Insist on an agreement form being completed before signing it Never sign a blank document

'Rural migration can't be halted'

(33) The migration of people from the rural areas is an ongoing, historical process which cannot be halted, according to the Association of Chambers of Commerce of South Africa (Assocom)

"Laws and regulations, penalties and punishments might slow it down but the social and economic forces which impel this inexorable movement of people cannot be stayed," says an article in the "Assocom Review"

Cities were seen as centres of opportunity for people to better themselves

(229) 87/20/10/83
"That very urge which is the motivating force behind private enterprise drives them to seek a better life than their present lot

"The creation of slums, squatters' camps and shanty towns is proof of the hollow illusion that many find at the end of the rainbow trail to the cities

"But this does not daunt the migrants, it never has," the article states

A developing, expanding society must adapt to the process

There were two courses of action which

could be adopted

- Accepting the process of social change by providing facilities which "give a feeling of permanence and a stake in society"
- Providing an attraction for quasi-rural areas

"The Government appears to be realising this, not only by its change in attitude towards permanent residence in established urban areas, but also by the policy of regionalisation which will create new towns where there were none before the article states

200 133 189 0171
WOM 20/10/83 335 11/10A

Union opposes 1-day notice contract

Labour Correspondent

THE giant Steel and Engineering Industries Federation, Seifsa, has been given the green light by the Government to introduce a contract for migrant workers which will allow employers to retrench them at a day's notice

This move has been slammed by Fosatu's Metal and Allied Workers Union, which has successfully threatened legal action against employers for retrenching migrants without due notice

Seifsa members employ about 400 000 workers, most of them black

At present, migrant contracts run for 12 months, but

new contracts will allow employers to dismiss workers with only one day's notice

Seifsa advised members to consider changing contracts to avoid "any possible problems with retrenchment during the contract period"

The journal quotes MAWU as charging that it has called for the scrapping of the contract system but that "this had been ignored by Seifsa"

Seifsa had met the department to establish the legalities of retrenching migrants

Seifsa's director, Mr Sam van Coller, said one set of conditions applied to retrenching migrants and another to other workers

143 (100) 177 (189) 133 (333)
RAY 21/10/83

Employer plan slammed

By STEVEN FRIEDMAN
Labour Correspondent

THE Council of Unions of SA, which represents more than 100 000 workers, has criticised moves by the Steel and Engineering Industries Federation (Seifsa) to introduce new contracts for migrant workers which would allow employers to retrench them with one day's notice

In a statement yesterday, CUSA warned that, if SEIFSA planned that the new contracts were to become a trend throughout the country, "they will encounter resistance from CUSA unions in all major industries"

The statement also implies the new contracts give migrants less job secur-

ity than other workers, who must be given notice in terms of common law

SEIFSA argues that it was forced to ask the Government for the change because the law did not allow employers to retrench migrants in the middle of their contracts

It says this put employers in an "impossible position", because they were forced to "discriminate" against other workers by retrenching them first

CUSA was asked to investigate SEIFSA's decision by its affiliate, the Steel, Engineering and Allied Workers Union

It said its understanding of the common law was that, if workers were paid weekly, they must be given a week's notice, and if monthly, a month's notice

This would apply unless their contracts specified differently

It said it also believed that "a case could be made" that a worker's contract could only be cancelled immediately if the worker or employer had "substantially" breached the contract

This would be changed by the new contract system

SEIFSA had taken its step after consulting attorneys and "even a Cabinet Minister", but had not consulted metal workers

"SEIFSA has attempted to jeopardise normal employment conditions and destabilise the industry by this action. This is a responsibility they will need to face in the future"

BUSINESS AND POLITICS

Time for some perspective

133

Whenever businessmen in this country get together, government invariably comes in for criticism. This is hardly surprising. Most contact that business has had with government over the past 30 years has been over the latter's increasing power and interference in the market economy

This week at Assocom's annual conference in Pretoria, however, businessmen are being asked to view government and the rules by which it governs from a different standpoint. And, indeed, after the excesses of the politicians, perhaps it is time for some perspective on the constitution-

Financial Mail October 21 1983

MIGRANTS: UNIONS WARN IRON BOSSES

200 333 444 23/10/83
CP Reporter Glynis Press
LABOUR PEACE

LABOUR PEACE in the metal and engineering industries is under severe strain following the disclosure that bosses have devised a new contract which will enable them to dismiss migrant workers at a day's notice

Trade unionists have warned that "havoc" could result if the new contracts are applied to the estimated 200 000 migrant workers in these two industries

Current migrant workers' contracts run for 12 months, but the new contract, which the powerful Steel and Engineering Industries Federation (Seifsa) has advised its members to use, will enable bosses to dismiss or retrench workers with only one day's notice

The Seifsa move comes when many workers in these two industries have been hit by retrenchments

Until now, legal opinion has been that it is a breach of the law for an employer to retrench a

migrant worker before his contract has ended Metal and Allied Workers' Union (Mawu) Transvaal secretary Moses Mayekiso says his union will "fight any measure which harms our contract workers"

General secretary of the Steel, Engineering and Allied Workers Union, Jane Hlongwane, called for immediate talks with Seifsa If the employers went ahead with the new contracts, they would have to "cope with the consequences," she said

Seifsa director Sam van Collier confirmed yesterday that the new contract had been devised after talks with the Government

Seifsa's door was "always open" to discussions with these unions, he said The new contracts were necessary because of the recession and in order to bring migrant workers contracts into line with dismissal and retrenchment provisions applied to workers with urban rights, he said

... on the other side... lovely dressed up in the latest disco gear... Mardian. So next time you look up... side...

Shootout that never was

TEMPLETON Makanda, 27, was found guilty in the Peddie Magistrates' Court this week of committing perjury - after claiming he was shot at near the Fish River border post last week.

Appearing before Mr A L Conza, Makanda admitted to making conflicting statements to two commissioners on oath on October 18.

In his first statement, Makanda had claimed he was shot at at the Fish River border post.

FINAL

league game, and could well add to the string of upsets they have caused this season

But most of the excitement and tension should be reserved for Orlando Stadium, where AmaZulu will test Moroka Swallows.

Swallows had enough respect for the hot promotion candidates and their uninhibited, vociferous supporters to move the game from their "home" ground George Goch, to Orlando

It is a game of endlessly exciting possibilities, and Swallows must hope that midfielders Chippa Molatedi and Sullie Bhamjee are fit enough for this game

At Glebelands, Bush Bucks will "entertain" respected Hellenic, and at Mamelodi, lowly Sundown will play even more lowly African Wanderers - shock victors over Kaizer Chiefs this week.

The chances of a "down under" final don't look bad at all

The caped councillor

IS IT a bird? Is it a plane? No, it's Supermayor!

The Government has made mini-gods of the mayors due to be elected in next month's local authority elections - allowing them, among other things, to silence other councillors at any time and have unquestionable say in council meetings

They can order speakers to stop speaking and even throw them out if they "persistently disregard the mayor's authority"

The new regulations state that "whenever the mayor speaks, any member speaking or offering to speak shall sit down, and members shall be silent so that the mayor can be heard without

interruption"

The supermayors have absolute control over meetings and their decisions "shall not be open to appeal and shall not be reviewed by the council" or be open to discussion

They can also "call the attention of members to irrelevance, tedious repetition, unbecoming language or any breach

... WITH THE PRESS ...
... 2000 ...
... THE PRESS ...

Growing need for industrial relations

By OWEN PARKER
Proprietor & Editor

THE building industry today faces many problems arising from the current recession, from the drought and, probably most challenging of all, from emerging pressures in the industrial relations field

This statement was made today by Mr Jed Bramwell, chief executive of Murray and Roberts Holding Ltd, in his opening address at the Bifsa congress in Port Elizabeth

"There is no doubt in my mind that the Government's efforts to broaden the processes of negotiation with workers and to liberalise our labour legislation will lead to a more stable and productive labour force in the longer term," he said

"The process of achieving this state of affairs, however, is certainly going to be painful and, in some cases, traumatic, for employers"

Management in the future would have to devote very much more time to the problems of industrial rela-

tions than it had done in the past

In this regard, it had to recognise the implications of the rulings of the industrial court

Recent court proceedings had clearly revealed that, in many instances, employer reaction under pressure from organised employees was hasty and ill-conceived

The tendency for the means of production within our economy to be progressively absorbed into fewer and fewer major companies through the payment of large sums of money to the previous owners, entrepreneurs and shareholders had not led to any increase in the means of production, Mr Bramwell said

Nor had it led to the creation of a greater number of job opportunities or increased efficiency within the country's economy as a whole

As far as the construction industry was concerned, it had also led to the undesirable practice of in-house trading in an industry which had always prided

itself on the fact that it represented the very essence of the free enterprise system

"Today, many of the major construction companies are owned by mining and financial groups which tend to give special preferences to their own companies," he said

As the economy expanded and as larger numbers of people became economically active, pension funds, insurance companies and other financial institutions generated money at an increasing rate and were constantly seeking new investment opportunities

"Without opportunities for South African institutions to invest these pent-up funds outside of the Republic, this has become a contributory factor in the tendency towards the concentration of economic power in fewer and fewer hands"

The good news was that funds were channelled into the acquisition of existing buildings and the construction of new projects, Mr Bramwell said

E. Post
24/10/83

N

"

Structural changes can make financial management crucial

Cape Town 25/10/83

133

Labour relations — key area for building industry

PORT ELIZABETH — The building industry today faced many problems arising from the current recession, from the drought and, probably most challenging of all, from emerging pressures in the industrial relations field, Mr Jed Bramwell, chief executive of Murray & Roberts said

Addressing the opening of the Building Industry Federation of South Africa's congress in Port Elizabeth, he said "There is no doubt in my mind that the government's efforts to broaden the processes of negotiation with workers and to liberalize our labour legislation will lead to a more stable and productive labour force in the longer term"

Problems

He said the process of achieving this state of affairs would be painful and, in some cases, traumatic, for employers

In the future, management would have to de-

vote more time to the problems of industrial relations than it had done in the past, and in this regard, it had to recognize the implications of the rulings of the industrial court

"Recent court proceedings had clearly revealed that in many instances employer reaction under pressure from organized employees was hasty and ill-conceived"

Mr Bramwell said the tendency towards the means of production being absorbed by fewer and fewer major companies had not led to any increase in the means of production, the creation of a greater number of job opportunities or increased efficiency within the country's economy as a whole

As far as the construc-

tion industry was concerned, it had also led to the undesirable practice of in-house trading in an industry which had always prided itself on the fact that it represented the very essence of the free enterprise system

Preferences

"Today many of the major construction companies are owned by mining and financial groups which tend to give special preferences to their own companies

"This unhappy state of affairs has led to many contractors becoming increasingly frustrated by the tendency of these major groups to seek tenders apparently only to check prices and maintain a level of honesty in the pricing of their own in-house companies," he said — Sapa

133

143

ROOM 25/19/83

Federation says contract isn't discriminatory

By STEVEN FRIEDMAN
Labour Correspondent

THE Steel and Engineering Industries Federation (SEIFSA) has rejected claims that a new form of migrant worker contract it has suggested metal firms should sign, gives migrants less job security than other metal workers

The new contracts, which allow employers to fire migrants at one day's notice, have been recommended to metal employers by SEIFSA after talks with the Department of Co-operation and Development

The move comes after SEIFSA's lawyers told it that employers who retrenched migrants in mid-contract could be sued and is in an attempt to prevent legal action against employers who wish to retrench migrants

Last week the Council of Unions of SA charged that this gave migrants less job security than other workers who are covered by the common law, which stipulates that weekly-paid workers must receive a week's notice

Yesterday, SEIFSA's director, Mr Sam van Coller, said in a statement that the new move would place migrants in the metal industries "on exactly the same basis as white, coloured and Asian

workers, and black workers with Section 10 (1) (a) and (b) rights"

The reason for this, he said, was that these workers were subject to the main agreement negotiated by the industry's national industrial council. This agreement takes precedence over common law

He said the industrial council agreement provided for "notice of termination of one day on either side"

It also, he added, "supercedes any common law provision relating to notice being linked to the frequency of payment"

Meanwhile, it is understood that the Metal and Allied Workers Union (MAWU) is contemplating legal action against a major SEIFSA company, Anglo American's Highveld Steel, for retrenching workers in mid-contract

A union spokesman refused to comment yesterday, but it is understood that the Highveld workers were retrenched some time ago and therefore would have been subject to traditional migrant worker contracts, rather than the contracts SEIFSA has now recommended

MAWU has successfully threatened legal action against Dunswart Iron and Steel over the retrenchment of migrants

Tribune Reporter

The Federated Chamber of Industries has rejected claims that it has had a long standing alliance with the Government

The executive director of the FCI, Dr Julian van Zyl said that a front page Sunday Tribune report last week about 'The Secret Businessbond' created needless suspicion about a perfectly normal relation between business leaders and government as well as containing a number of factual inaccuracies

He said that it was suggested that the Corporate Forum operating under the aegis of the FCI had been the platform to secure massive business and industrial support for the Prime Minister's constitutional proposals

This is simply incorrect. The forum has never been used for this purpose. On the contrary, on the constitutional issue the FCI has assumed a public stance openly critical of a number of limitations perceived in the Bill a position which in fact went further than any of the

FCI denies having secret alliance w/

views expressed by other national employer organisations in South Africa.

He also rejected claims that South Africa's biggest corporations had been secretly meeting the Prime Minister and his most senior Cabinet ministers

"While meetings are confidential, they are not secret insofar as regular reports have been given to FCI executive council meetings, which are completely open to the public. In addition, the Prime Minister does not attend regularly and in fact only Mr Vorster attended a meeting on one occasion. So far Mr Botha's timetable has clashed with Corporate Forum dates and he has not as yet addressed members. It is therefore quite inappropriate to regard the activities of the forum as 'Mr Botha's clandestine affair with businessmen'.

Neither does the forum have lunch with the entire Cabinet. While the members of

the forum are always delighted to have Cabinet ministers to lunch, only half a dozen or so can usually find time to attend.

The Sunday Tribune also claims that division in the Cabinet about how far the proposals should go were frankly discussed at the forum. Again this is simply incorrect. The forum has never been requested to present its views on the constitutional proposals.

"In fact ever since its inception on a national basis in the early 70s, the Corporate Forum has filled a real need in promoting discussion and a frank exchange of views between business and government on a wide spectrum of issues affecting the business community.

This is in accordance with the forum's major objectives currently stated as to provide a representative forum for intrac-

tion between the government and the private sector on major policy issues' and 'to act as catalyst for co-operation rather than confrontation between government, the private sector and labour in South Africa'.

As indicated above, confidentiality is respected at meetings but no secrecy is involved. Reports of activities have and are regularly given to FCI executive council.

A further major function of the Corporate Forum is to provide specialist business expertise for many ongoing activities of the FCI. Much high-level manpower for standing and specialist sub-committees of FCI is drawn from members. Without these resources the FCI would be much the poorer.

I trust that the foregoing information will enable you to see this matter in the correct perspective and to retract the in-

accuracies, since some unnecessary embarrassment has already been caused," Dr van Zyl said.

William Sanderson-Meyer replies. Dr van Zyl's complaint confirms the very thrust of the report by saying that the major objectives of the Corporate Forum were to interact with the Government on "major policy issues" and to act as "a catalyst for co-operation".

The report indicated that this relationship has created the climate for massive business and industrial support for the constitutional proposals. Although members of the forum may not be able to appreciate the disquiet with which such "confidentiality" is viewed by outsiders, a "confidential" relationship which has existed unpublicised for twelve years is viewed by many with suspicion and not as a "perfectly normal" business relationship.

(133) S Tribune 30/10/83

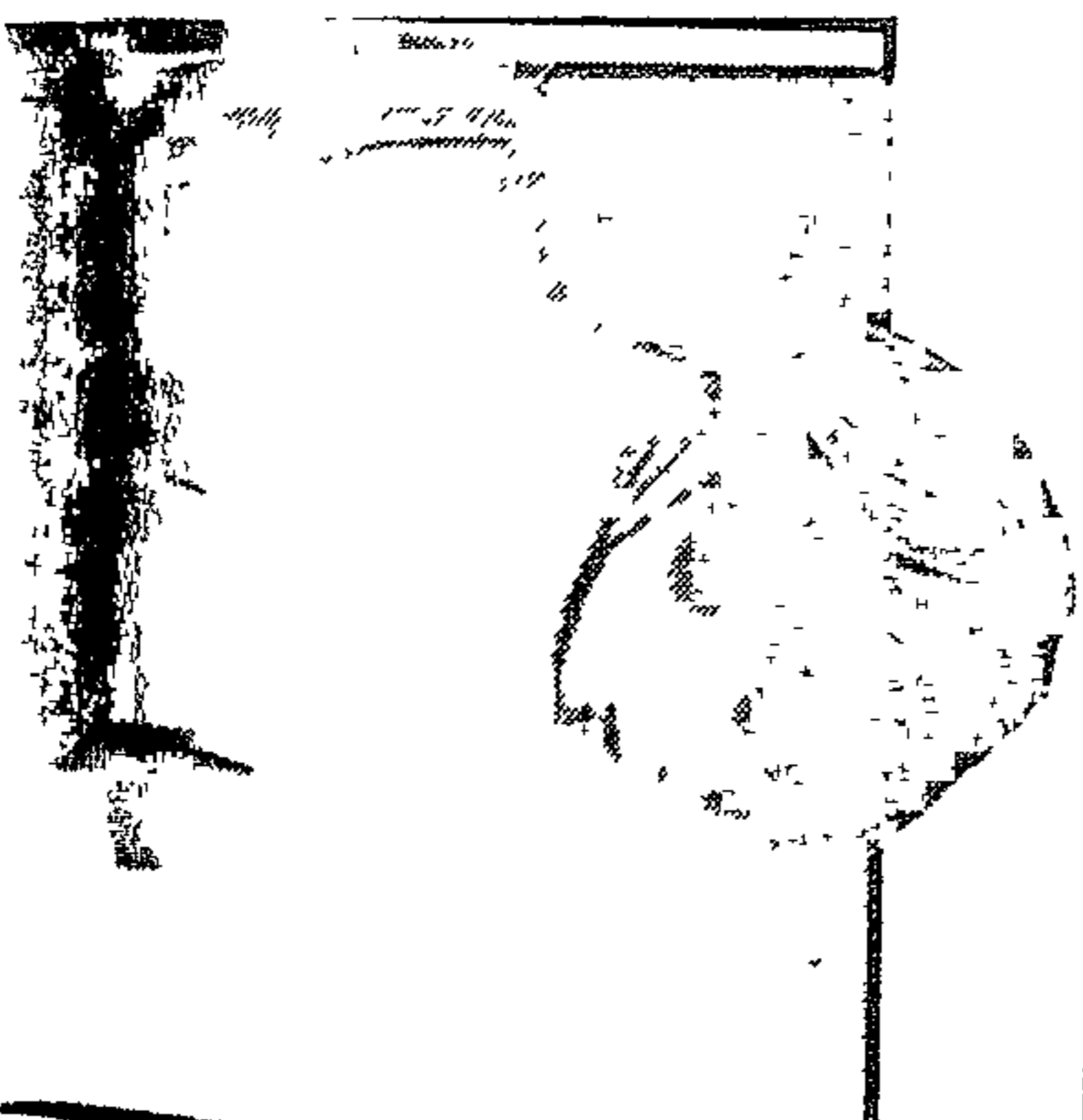

DDUITJODAM'S AIR STI

Shock claim that pollution safety levels are beir

By Ric Turner

SULPHUR dioxide air pollution in some areas of Durban is claimed to be 10 to

1982/83 averaged 62 micrograms per cubic metre of air — two micrograms more than the 60 micrograms a cubic metre safety level set by WHO.

"WHO figures are one of many guides available and although there is a build-up of sulphur dioxide in Durban's southern areas I do not believe the

air was the maximum pollution level acceptable according to WHO standards, placing the Congella area "just above the level by two parts".

Dr Mulholland said that sulphur dioxide fumes could be smelt when concentrations reached 1 000 micrograms per cubic

acceptable smoke pollution level was 75 micrograms per cubic metre in the US



(133) S Tribune 30/1/83

ICI denies having secret alliance with Govt

was expressed by other national employ- organisations in South Africa.

He also rejected claims that South Africa's biggest corporations had been secret- meeting the Prime Minister and his cabinet ministers.

"While meetings are confidential, they are not secret insofar as regular reports have been given to FCI executive council meetings, which are completely open to the public. In addition, the Prime Minister does not attend regularly and in fact only Vorster attended a meeting on one occasion. So far Mr Botha's timetable has been shared with Corporate Forum dates and has not as yet addressed members. It is therefore quite inappropriate to regard the activities of the forum as 'Mr Botha's clandestine affair with businessmen'.

Neither does the forum have lunch with the entire Cabinet. While the members of the forum are always delighted to have Cabinet ministers to lunch, only half-a dozen or so can usually find time to attend.

"The Sunday Tribune also claims that division in the Cabinet about how far the proposals should go were frankly discussed at the forum. Again this is simply incorrect. The forum has never been requested to present its views on the constitutional proposals.

"In fact, ever since its inception on a national basis in the early 70s, the Corporate Forum has filled a real need in promoting discussion and a frank exchange of views between business and government on a wide spectrum of issues affecting the business community.

"This is in accordance with the forum's major objectives currently stated as to provide a representative forum for intrac- tion between the government and the private sector on major policy issues' and 'to act as catalyst for co-operation rather than confrontation between government, the private sector and labour in South Africa'.

As indicated above, confidentiality is respected at meetings but no secrecy is involved. Reports of activities have and are regularly given to FCI executive council.

"A further major function of the Corporate Forum is to provide specialist business expertise for many ongoing activities of the FCI. Much high-level manpower for standing and specialist sub-committees of FCI is drawn from members. Without these resources the FCI would be much the poorer.

"I trust that the foregoing information will enable you to see this matter in the correct perspective and to retract the in- accuracies, since some unnecessary embarrassment has already been caused." Dr van Zyl said.

William Saunders-Meyer replies Dr van Zyl's complaint confirms the very thrust of the report by saying that the major objectives of the Corporate Forum were to interact with the Government on "major policy issues" and to act as "a catalyst for co-operation".

The report indicated that this relationship has created the climate for massive business and industrial support for the constitutional proposals. Although members of the forum may not be able to appreciate the disquiet with which such "confidentiality" is viewed by outsiders, a "confidential" relationship which has existed unpublicised for twelve years is viewed by many with suspicion and not as a "perfectly normal" business relationship.

While Dr van Zyl may not regard "confidential" as meaning "secret", the twelve year existence of the Corporate Forum was unknown to senior Opposition politicians and businessmen from whom I sought comment.

And FCI reports, far from shedding light on the Corporate Forum merely state it continued its "closed session" meetings with Government ministers.

We accept Dr van Zyl's assertion that the PM has not yet attended the meetings and that former Premier John Vorster attended only on one occasion.

Dr van Zyl's statement that the constitution and division within the Cabinet were never discussed at the Corporate Forum meetings contradicts information we have been given by a senior FCI source.

See Editorial Comment, Page 52

DURBAN'S AIR STINKS

Shock claim that pollution safety levels are being exceeded

By Ric Turner

SULPHUR dioxide air pollution in some areas of Durban is claimed to be 10 to 100 times higher than the maximum safe exposure levels recommended by the World Health Organisation.

Dr Mike Mulholland, senior lecturer in the Department of Chemical Engineering at the University of Natal and a researcher in atmospheric dispersion, said readings disclosed by the Durban City Engineers Department meant that

1982/83 averaged 62 micrograms per cubic metre of air — two micrograms more than the 60 micrograms a cubic metre safety level set by WHO.

Dr Mulholland said 30 minutes exposure to a 600 micrograms per cubic metre of air concentration of sulphur dioxide was the accepted international maximum.

Sulphur dioxide is emitted when fossil fuels containing sulphur, such as oil or coal, are burnt.

Prolonged or excessive exposure to sulphur dioxide can cause breathing difficulties, induce chro-

nic bronchitis, and the private sector on major policy issues' and 'to act as catalyst for co-operation rather than confrontation between government, the private sector and labour in South Africa'.

As indicated above, confidentiality is respected at meetings but no secrecy is involved. Reports of activities have and are regularly given to FCI executive council.

"A further major function of the Corporate Forum is to provide specialist business expertise for many ongoing activities of the FCI. Much high-level manpower for standing and specialist sub-committees of FCI is drawn from members. Without these resources the FCI would be much the poorer.

"I trust that the foregoing information will enable you to see this matter in the correct perspective and to retract the in-

WHO figures are one of many guides available and although there is a build-up of sulphur dioxide in Durban's southern areas I do not believe the situation has been reached where there was any hazard to health."

Dr Richter also said no monitoring was carried out for carcinogenic substances from industrial areas.

"We know what is going out, but we don't believe it is in any dangerous concentration.

"I don't believe you can take figures for one concentration per day."

Dr Mulholland said that sulphur dioxide fumes could be smelt when concentrations reached 1 000 micrograms per cubic metre of air, and people in affected areas in Durban had complained of the smell.

"If the smell is acute at any time then the problem needs dealing with but the nose tends to adjust and you don't notice it anymore," he said.

"Sulphur dioxide has no known carcinogenic effects but at those concentrations people not normally subject to bronchial or asthma should be alert to acceptable levels for smoke pollution, but said 75 micrograms per cubic metre was considered safe in the USA and 100 micrograms per cubic metre was the standard set in Japan.

Dr Etel Kemény of the Atmospheric Sciences Division of the Council for Scientific and Industrial Research's National Physical Research Laboratory said that although the sulphur dioxide levels in Durban were only slightly above WHO recommendations and concentrations were technically low, authorities should be alert to

burg were said to be "well below the accepted recommended maximums by international standards" and "well below the levels liable to cause harm."

Acting Medical Officer for Health in Pietermaritzburg, Dr Thomas Heatherington, said sulphur dioxide levels averaged 22 micrograms per cubic metre for 1981 and 24 micrograms per cubic metre for 1982, an increase he said was caused by the drought because there had been insufficient rain to dampen the air down.

Figures for 1983 were

Referendum brings a tentative step into the political arena

Business out of the funkhole

BY BERNARD SIMON

A REFRESHING feature of the referendum campaign has been the eagerness of many business leaders to tell others how they will vote on Wednesday and to encourage others to follow suit.

To a public accustomed to being told that chairmen and managing directors do not comment on political matters, it is a welcome change

to know that such prominent South Africans as Mr Harry Oppenheimer, Mr Tony Bloom and Mr Max Borkum will be voting no, and Mr Chris Saunders and 185 others are publicly urging a yes vote.

South African businessmen normally shy away from public pronouncements on issues which they consider to be political. In the heated and polarised context of politics, they are scared of offending colleagues, customers, suppliers and the Government. Political loyalties are more rigid in SA than in many other countries and the danger of losing business through expressing political views is thus greater.

Even in the run-up to the referendum, there are some notable names who have stayed on the sidelines — only two Barlow Rand directors — Mr George Bulterman and Mr Derek Cooper — signed the yes advertisements. The company's chairman, Mr Mike Rosholt, thought by some acquaintances to be a closet yes, apparently believes that his position as Chancellor of the University of the Witwatersrand and head of a large, diverse company precludes him from speaking his mind.

Mr Oppenheimer, who is Chancellor of the University of Cape Town, has no such qualms. The American Chamber of Commerce decided after lengthy debate not to take a stand on the grounds that many of its members do not have the right to vote.

The outspokenness of many businessmen on the constitution issue raises some important questions.

Why are they publicising their stance on the Constitution Act of 1983 when they normally insist that their political views are nobody else's business?

To put it differently, why has Asisocorn not invited political leaders to address its congresses during normal election campaigns, as it did two weeks ago?

Dare we hope that the referendum will be a turning point in South African business's reluctance to speak out on political issues?

The business community has given its own explanations for taking a stand on the constitution. Mr P W Botha's initiative, the captains of commerce and industry are saying, has a vital bearing on South Africa's future business and investment climate.

Ironically however, there is no agreement on what the bearing is. The yes voters insist that rejection of the new system will flash a warning of instability to foreign investors, the no section says that outsiders will snuff instability until blacks are brought into the machinery of government.

But it is questionable whether the importance to companies' bottom lines of the Constitution Act is the only reason why businessmen are making their voices heard. Perhaps the referendum debate is a sign that South African businessmen are losing their inhibitions about arguing over political issues in public?

Since Mr Oppenheimer and later Mr Rosholt began speaking out on labour issues in the mid- and late-

1970s, the stigma of voicing one's political views in public has slowly been fading. Even such touchy issues as detentions without trial are no longer altogether taboo.

Mr Fred Ferreira, Ford's industrial relations director, has several times protested in public against bannings. The Border Chamber of Industries has strongly criticised Ciskei's handling of the East London bus boycott, and the Midland Chamber of Commerce in Port Elizabeth took a stand on the labour dispute in the docks last year, urging SA Transport Services to talk to the General Workers Union.

Mr Gavin Relly and Mr Rosholt broke new ground recently by pointing to the costs of the pass laws.

These examples are still exceptions. Mr Ferreira works for a big US-owned company, and can thus arguably afford to be more outspoken than other SA businessmen. Criticising Ciskei is unlikely to make one enemies at the moment.

Even the referendum debate has not entirely swept away businessmen's coyness. FCI president Mr Rod Ironside — who is also a General Motors executive — is said to have made himself unpopular with some members for making a public stand for industry on some aspects of the constitution.

Even in the referendum campaign there is some evidence of a reluctance among businessmen to suffer the perceived commercial consequences of voting the "wrong" way. The number of declared yes

votes far exceeds the noes, and none of the noes has been willing to put a name to an advertisement.

That may be because most businessmen intend voting yes, but there is little doubt that opponents of the new constitution hoping to win Government contracts are hesitant about publicising their vote. It is still easier for a businessman to say yes in public than no, although — in a neat twist — rumours abound that several Afrikaner supporters of the Botha plan declined to sign last week's advertisement for fear of upsetting their ultra-conservative business contacts.

Nonetheless, the referendum debate has been marked by an unusual openness and tolerance of opposing viewpoints. One reason may be that views on the new constitution cut sharply across party lines and even through office and family loyalties, allowing business colleagues and acquaintances to disagree without drawing their swords.

Furthermore, with the referendum being a one-off event, differences on this issue will almost certainly be forgotten far more quickly after November 2 than deep-rooted party splits.

But, who knows, perhaps the lively debate on the new constitution has whetted business appetites for political controversy. One legacy of the recent campaign may be a heightened awareness among businessmen leaders that their views on political issues carry a good deal of weight.



MR STRONG

BCI, Fosatu met on boycott

EAST LONDON — The vice president of the Border Chamber of Industries (BCI), Mr Mike Strong, confirmed yesterday that members of the chamber had had a meeting with officials of the Federation of South Africa Trade Unions (Fosatu) here recently

Mr Strong confirmed they had discussed the current situation here in relation to the bus boycott

The BCI was represented by the president, Mr Dave Saunders, Mr Strong, Mr E Ashdowne and Mr G Uys

Fosatu was represented by the president, Mr Chris Dlamini, the general secretary, Mr Joe Foster and six other officials

In his presidential address to the annual meeting of the BCI last week, the outgoing president, Mr Dave Saunders referred to the meeting and said that, regrettably, the union delegates did not have any specific solution for ending the bus boycott

The BCI had urged them to do all in their power, in conjunction with other unions, to persuade their membership to end the boycott. — DDR

Handwritten notes:
BCI, Fosatu met on boycott
21/11/83
b. D. Saunders
21/11/83

Handwritten note:
measured in appropriate unit
→

BORDER BOSS SLAMS SEBE

133

~~133~~

~~133~~

4/12/83

OUTGOING Border Chamber of Industries boss Dave Saunders has challenged President Lennox Sebe to explain how they caused "the Mdantsane troubles".

By BENITO PHILLIPS

In an angry response to a speech last week by the Ciskei homeland president — delivered in the Sisa Dukashe "Ar-

ena of Horror" Stadium — Saunders said the BCI took "strong exception" to President Sebe's statement.

"Judging from reports, President Sebe singled out a personal

attack at a respected member of this chamber, Mr. Leo Borman. This chamber utterly refutes the alleged remarks of President Sebe.

"I want to emphasise the fact that in

addition to their own in-house training facilities, organised industry in this area has promoted, supported and helped to equip many of the industrial training facilities which now exist in Ciskei.

"In view of the fact that the South African Government and tax-

payers are contributing much towards the promotion of industrial development in both the Ciskei and Border regions, the President's remark will only frustrate those who are so genuinely involved in the promotion of industrial growth," Mr Saunders said

Code ensures equal job opportunities

5/12/83

C. Tines
N.A.A.

133

IN 1976, recognizing that there was much to be done on a local level in South Africa in the creation of equal job opportunities for all races and opportunity on merit, the Cape Town Chamber of Commerce issued a manifesto

This called on all subscribing firms to commit themselves to a policy of "total and genuine non-discrimination"

In the manifesto, the Chamber asked member companies to

- Select, employ, train and promote staff without regard to race or colour

- Determine salaries and wages in accordance with the principle of equal pay for equal work.

- Grant employment benefits for all members of the staff, without regard to their race or colour

- Do all such things as may lie within their power to promote understanding and harmonious relations between it and its employees and between its individual employees, irrespective of race, colour or employment status

Mr Brian MacLeod, director of the Cape Town Chamber of Commerce, said the manifesto was unique in that the Chamber could control the its meaningful application and see that signatories would maintain the code effectively

"It is unique in that we monitor application to ensure that members are complying with its terms We also expect them to display the

manifesto so that employees are aware that their company is a signatory," Mr MacLeod said

If the chamber receives a complaint from an employee of a signatory company, it is immediately investigated and both sides of the story are heard

Should the complaint be valid, the signatory company is told that failure to correct the situation would lead to the removal of its name from the list of subscribing companies

The Chamber requires a signed undertaking rather than a verbal one from companies and this must be by the managing director or proprietor

Mr MacLeod said "This manifesto has been used overseas to show how keen employers here are to remove discrimination from the workplace

Not all members of the Chamber are signatories It is preferred that signatory companies are able to apply fully the terms of the manifesto, and if they are unable to for reasons of financial inability to supply, for instance, pension schemes and canteen facilities for all races, the Chamber would rather they did not subscribe

"New members of the Chamber are expected to sign the code, and the majority of our members have now signed"

DIANE CASSERE

133

10/12/83

Nafcoc explains boycott call on black company

By HARRY MASHABELA

THE NATIONAL African Federated Chamber of Commerce (Nafcoc) yesterday explained why it was calling for a boycott of a black company with two wholesale outlets in Reef townships.

Nafcoc's president, Mr Sam Motsuenyane, told journalists in Johannesburg that the black company, Afrimet Limited, should be boycotted because it was "dominated" by a white company, Metro Cash and Carry.

Mr Motsuenyane said he called the Press conference to make Nafcoc's reasons clear because the two companies were trying to confuse the public.

"The power in Afrimet rests in the hands of Metro Cash & Carry and not in the black directors, despite the 49-51% shareholding, because the 51% shares supposedly black are dispersed among several individuals and not one black man or company," he said.

Other unacceptable elements of the Metcash/Afrimet arrangement, according to Mr Motsuenyane, are:

- The appointment or dis-

missal of Afrimet staff is the responsibility of Metcash, not Afrimet's black directors

- Metcash is the only group allowed to purchase and provide supplies for Afrimet, irrespective of prices,

- Afrimet will pay Metcash R20 000 or 10% of the company's annual net profits, whichever is greater, as remuneration before tax,

- Metcash is the sole manager, secretary and account for Afrimet, and,

- Metcash will manage Afrimet for 20 years

"Only after 20 years can Afrimet give 12 months notice of termination of the contract. But Metcash can withdraw at any time it ceases to be a shareholder in the company, on three months notice. We believe 20 years is too long by any standard. It is some sort of neocolonialism," he said.

Afrimet's three black directors — Mr Vela Kraai, Mr Richard Maponya and Mr David Pooe — were "clearly powerless", he said. The three have already been expelled from Nafcoc. Afrimet has two outlets — one in Soweto and the other in Katlehong on the East Rand.

New contracts for migrant workers upset unions

Star 3/12/83

Own Correspondent

CAPE TOWN — The Federation of South African Trade Unions (Fosatu) is angry about a move by the metal industry's employer association to introduce a new contract for migrant workers

The Steel and Engineering Industries Federation (Seifsa) has recommended to employers that they enter into new contracts with migrant workers which will provide for one day's notice of dismissal.

The Metal and Allied Workers' Union (Mawu), a Fosatu affiliate, has already criticised the new measure, as have the Council of Unions of South Africa and the Black Sash.

The latest issue of Fosatu Worker News reports that some workers are already being given contracts specifying that, after an initial period of one month, workers will be employed on a daily basis

A Seifsa spokesman defended the move, saying that the recommendation was to ensure that "all employees are on an

identical basis as far as the termination of a contract is concerned".

The spokesman said that, prior to the move, only workers with permanent urban rights were employed on a daily basis, while migrant workers were on a fixed term contract

But, in its newsletter, Fosatu said Seifsa had forgotten that migrant workers "do not enjoy the same privileges as urban workers

"Losing a job for a migrant worker means being shipped to the homelands where both poverty and drought reign supreme"

Mawu, Cusa and the Black Sash have criticized Seifsa for introducing the measure without consulting the workers.

Fosatu Worker News also reports that "Mawu and other independent unions are gearing themselves up to resist the introduction of the new contract".

The Seifsa spokesman said the federation had not monitored the extent to which the recommendation had been taken up by various employers.

Business 'blind to political truths'

Own Correspondent

CAPE TOWN — The white referendum on the constitution had proved that the Nationalist Government and business "march side by side", according to the Federation of South African Trade Unions (Fosatu)

Fosatu, the largest national independent trade-union federation with more than 100 000 members, was commenting in its latest newsletter on the recent referendum

"A few lone business voices said 'no' but the rest marched to the government tune. Or is it not a case of the government marching to the tune of business?" said Fosatu.

"When Fosatu shop stewards went to management to find out whether their company supported the proposals they were usually told that management did not comment on political matters. But these companies are members of the Federated Chamber of Industries which supported a 'yes' vote."

Fosatu said that businessmen supported the constitution because it kept power with the present government, thus offering "security for profit-making", deepened racial divisions among workers, and ensured continuation of foreign investment and trade.

However, businessmen were "blind to some political truths"

"Since they have now openly tied themselves to this racist regime, they will have to stand or fall with it in the future."

The nonracial union movement had shown that it was possible to fight and overcome racial division, said Fosatu.

(110A) (133) ROM 14/12/83

'Meddling' upsets union with majority support

By STEVEN FRIEDMAN
Labour Correspondent

CLAIMS by the Metal and Allied Workers' Union (Mawu) that Transvaal companies are trying to force it to bargain in their plants in the same forum as "minority" unions — usually representing skilled workers — are becoming an issue in the metal industries

Mawu sources say the union's resistance to this may become the key source of conflict between it and metal employers in the months ahead

It claims that the Steel and Engineering Industries Federation (Seifsa) is behind the employer attitude Seifsa denies this

In common with other unions affiliated to the Federation of SA Trade Unions (Fosatu), Mawu argues that, where a union has majority support in a factory, it should

have the sole right to bargain with the employer

It says four Transvaal plants where it represents most workers have insisted that, if the union wants to negotiate directly with them in their factories, it must do so with other unions with members in the plants

These are generally white-led unions with skilled worker members, although in some plants rival unions organising black workers also have members

The latest issue of Fosatu's newspaper, Fosatu Worker News, charges that employers have tried to get Mawu shop stewards to take part in company works councils which include all unions with members in their plant

It says this means that, in some plants, Mawu has more than 90% membership, but must bargain jointly with unions who represent "as

little as 2%" of workers

Mawu sources say the union has vowed to fight the employer stance and predict this will prompt conflict in metal plants

They claim that Seifsa has urged employers to adopt this stance and accuse it of "meddling with companies which want to negotiate with representative unions"

A Seifsa spokesman yesterday denied that his organisation had urged employers to adopt this stance

"Our general attitude is to oppose bargaining in the factories because this undermines the industrial council system," he said

However, "where employers negotiate with unions in their factories on issues not covered by the industrial council agreement, we have not advised them on what form this should take — no guideline has been issued by Seifsa on this issue", he said

Industry gives warning on call-up Bill

By STEVEN FRIEDMAN
Labour Correspondent

THE Federated Chamber of Industries, which represents organised industry throughout the country, says the Government's planned Bill forcing young immigrants and aliens to do military training could deprive the economy of skilled manpower

In a statement released yesterday, the FCI says the rationale behind the Government's move is "correct", but it calls on it to consider the need for "various specific skills" which immigrants could provide

Its statement follows a warning by the Opposition defence spokesman Mr Phillip Myburgh that the Bill could prompt skilled immigrants to leave the country, or influence foreigners against immigration

The FCI says a clause in the Bill depriving immigrants who do not want to take out South African citizenship of their right to work in the country could have "a negative effect"

It says it believes that it is correct "that persons who share in the benefits and earn a living in the country should also share in the obligation to meet defence requirements"

But it adds that "the constant shortage of various specific skills in the local labour market should always be taken into consideration

when introducing regulations which could make the country less attractive for acquiring these skills elsewhere in the world"

In a reference to a 1978 law which first opened the way for immigrants to be compelled to undergo military training, the FCI says it welcomes the "apparent relaxation of the age limit under which immigrants will be required to undergo military training"

The age limit in the new Bill will be 25, whereas in the 1978 law it is the same as that for white South Africans

It adds that the clause in the Bill which would deny immigrants their permanent residence rights if they refuse to undergo military training differs only slightly from the terms of the 1978 law, but could have a "negative effect"

On Thursday the Conservative Party welcomed the proposed legislation but was critical that coloureds and Indians were still excluded from army duty, reports Sapa

"The comprehensive measures to ensure immigrants do military service are welcome and in line with the principle that all citizens must defend the country," said the party's defence spokesman, Mr Koos van der Merwe

But to compel whites and immigrants to do military service, and to exclude Indians and coloureds, "is an outrage against the white and the immigrant"

INDUSTRIAL RELATIONS -
Employers' Organisation

1984 - 1985

Call to end SA business apartheid

Financial Reporter

RACIAL discrimination should be eliminated from South African business says the Association of Chambers of Commerce (Assocom) in its submission to the President's Council on the provision of amenities for all races.

It says South Africa should have a single, integrated economy based on private enterprise and should not be restricted on the grounds of race or sex.

Assocom points out that the effects of discriminatory practices are most evident in the transportation and tourism industries

It recommends that transport, national museums, parks and theatres should be open to all races and that this should include all facilities connected to such amenities

Amenities such as hotels and restaurants, sport and entertainment facilities open to the public, but pri-

vately owned, should be subject to certain minimum levels of control

"The permit system, in whatever legislative guise, should be eliminated and it should be left to the discretion of the individual to decide to whom they will make their facilities available," Assocom says.

"Restrictions imposed on the use of certain amenities, together with the inadequacy of similar amenities for other race groups, may result initially in overcrowding and subsequent friction.

"For this reason, Assocom realises that all restrictions should not be lifted simultaneously and recommends that their removal should be phased in to allow for orderly change."

Alternatively or in addition to this, the association recommends that owners of facilities should be encouraged to charge for their usage

133 ROM 19/1/84

'83 was a watershed year, says MCI chief

133 E-Post 7/1/84

DEVELOPMENTS in the year ahead will show that 1983 was a watershed year for South Africa in general — and the Port Elizabeth/Uitenhage area in particular — according to outgoing president of the Midland Chamber of Industries, Mr Wally Life

Mr Life reflected on his tenure of office just ended, and ventured some thoughts on the year ahead in an interview with BUSINESS POST

Question: How would you sum up the year 1983?

Answer. I think 1983 was a watershed year in South Africa

Most multi-national companies with a substantial investment in South Africa, as well as the large private capital South African companies, see the result of the referendum as an opportunity for the South African Government to bring about effective changes that will provide structures for the drawing of all people in South Africa, irrespective of race, into both the economic and the political system

If this task is accomplished, then I believe the peace and prosperity of South Africa is assured

However, these changes will have to be meaningful, and will require progressive attitudinal changes. In this regard some of these moves will have to be effectively implemented in 1984

I also believe 1983 to be a watershed year for the PE/Uitenhage area in its bid to expand as a major market and industrial manufacturing area in the South African economic structure

The Government's regional development policy has provided this area with the opportunity to stake its claim for a new deal and Gabdec [Greater Algoa Bay Development Committee] is an important catalyst to promote industrial growth of the PE/Uitenhage metropole

This was exemplified in the Region D symposium held in Johannesburg in



By Louis Beckerling
Business Editor

November when its delegates presented a formidably motivated case to government to justify concessions being granted to the PE/Uitenhage area to enable its well-established and historic industry to compete effectively with like manufacturers established elsewhere in the country

What is needed now is to sustain an aggressive policy to drive home our needs and opportunities for industrialists in this area

In 1983 the automobile manufacturing industry located in the PE/Uitenhage area announced large capital investments for new and expanded plant and equipment to produce new vehicle models based on modern technology

The success of these models and those that will follow is important to regaining a large share of the growing national vehicle market

Q How do you see the PE/Uitenhage area obtaining a new deal from the Government?

A The whole concept of regional development is to ensure that each region in South Africa enjoys sound, sustained economic growth

The PE/Uitenhage area is part of Region D and, in fact, is the economic heart of that region if one compares gross manufacturing output

Decentralisation is only one component of regional development. It is a futile and costly exercise if jobs are created in decentralised area, while a corresponding loss of jobs occurs in a metropolitan area based in that same region

It is, therefore, essential that the economic progress of the region as a whole be measured and not simply the decentralised points

Further, decentralisation refers to establishing new industry or expansion projects of existing industry from areas where there is over-concentration

The object of decentralisation can never be to attract industry from under-concentrated metropolitan areas, therefore regional development policy must be geared not only at new industry, but at the continued development of existing industries based in the regions

This last point justifies concessions to permit industry that has historically been located in the PE/Uitenhage area to operate on a more competitive base and to encourage its future growth

It should be remembered that many of our major industries were located here a long time ago when assembly operations were their main functions, and long before the introduction of local content programmes

The "latecomers" were able to establish their plants after taking into consideration the rules that apply to local manufacture programmes

Q What is the potential for new industry for PE/Uitenhage?

A The economic "motor" of the PE/Uitenhage area will continue to be the automobile manufacturing industry and what we have to ensure is that these manufacturers once again obtain a dominant share of the market

If this region's share returns to the 45% mark it will again be the magnet that will attract the devel-



Handing over the chain of office to the incoming president of the Midland Chamber of Industries, Mr HENRY WHITTAKER, is outgoing president Mr WALLY LIFE, whose comments on prospects for 1984 appear in today's main article. On the right is Mr LOU WILKING, new deputy president of the MCI.

opment and expansion of satellite industries as it did back in the '60s

There is a threshold level below which a sector fails to attract satellite industries. This threshold level in the automobile manufacturing industry is around the 45%-to-50% mark

Another major challenge to area industry is the necessity to develop and expand education and training facilities to prepare a progressively more qualified cadre of artisans and skilled workers as well as supervisory and managerial personnel

This will not only require additional in-house facilities but also budgetary provision for educational bursaries

Several manufacturers have built this into their long-term business plans and assiduously devote themselves to achieving challenging goals, which is laudable. They will be the winners in that they will produce more efficiently and prosper

However, at the other end of the spectrum, I am struck by the continued attitude of complacency by some companies who are not planning ahead in the development of manpower

They will have a rude awakening, and will have no one to blame but themselves. Every industrial concern in the area, large and small, has a personal responsibility here

In this regard, the MCI is

embarking on a major project in 1984 to assist members to co-ordinate training courses for the growing number of matriculants who will be seeking employment in area companies

Q If the automobile industry is to be the economic driving force for PE/Uitenhage, what predictions are you making for 1984?

A I see a passenger vehicle market of 290 000 to 292 000 units, a light commercial vehicle market of 115 000 units, and a heavy commercial vehicle market of 19 000 units

And I'm hoping that the PE/Uitenhage's share of the passenger car market will be 40%

Security firms rapped for exploiting labour

Rogue security firms, in a bid for bigger profits, are flagrantly and illegally exploiting part of the 80 000 contract labour force of watchmen and security guards in South Africa

That is the allegation by the Transvaal chief of the South African National Security Employers' Association (Sansea), who accused some employers of "highly illegal" practices

"It is not unusual for some firms to work a man for 60 hours without a break," said Mr John McBrearty, chairman of the Transvaal division of Sansea and national secretary of the association

"Not only is this highly illegal, it is also a disgrace. It is of course more profitable for an employer to force a guard to work long hours — they are only wearing out one uniform and there's a reduction in transport costs"

A security guard normally worked a 12-hour shift and legislation prevented him from being forced to work much longer, he said

The law was being flouted and security was slipping. "Obviously a man working for 60 hours has to sleep"

The plight of security guards was particularly bad for those involved in guarding homes. "People going on holiday contact a security firm to arrange for a guard on the house. But the guards are often forced to work long hours and this renders security ineffective"

Mr McBrearty said his association was able to take action only against its members.

guards grade two receive at least R9,25 and security guards grade one a minimum of R12,08. Overtime is paid at a higher rate

"It is common now for guards to be paid more," said Mr McBrearty

Security firms charged their clients between R20 and R30 a shift for a guard

Mr E P Ehlers, director of conditions of employment and legislation at the Department of Manpower, said complaints from guards should be lodged with one of the nine divisional inspectors, who would then investigate the matter. A guard should be aware of his rights and protest if employment codes were being breached, he said

The maximum penalty employers faced was a R2 000 fine and/or imprisonment

"Illegal overtime is a criminal, not civil, offence," he said

A Johannesburg lawyer said there were "grey areas of law" regarding contract workers

"For example, a worker need not accept dismissal at the end of his contract. I don't think such dismissal is legal, but the courts have not said it is illegal. It strikes me as unfair labour practice"

On overtime, he said that, according to legislation, guards working six days a week could work up to 12 hours a day and those working five days could work up to 14½ hours a day for four days and 14 hours on the fifth. Casual employees could work up to 14 hours a day on any day.

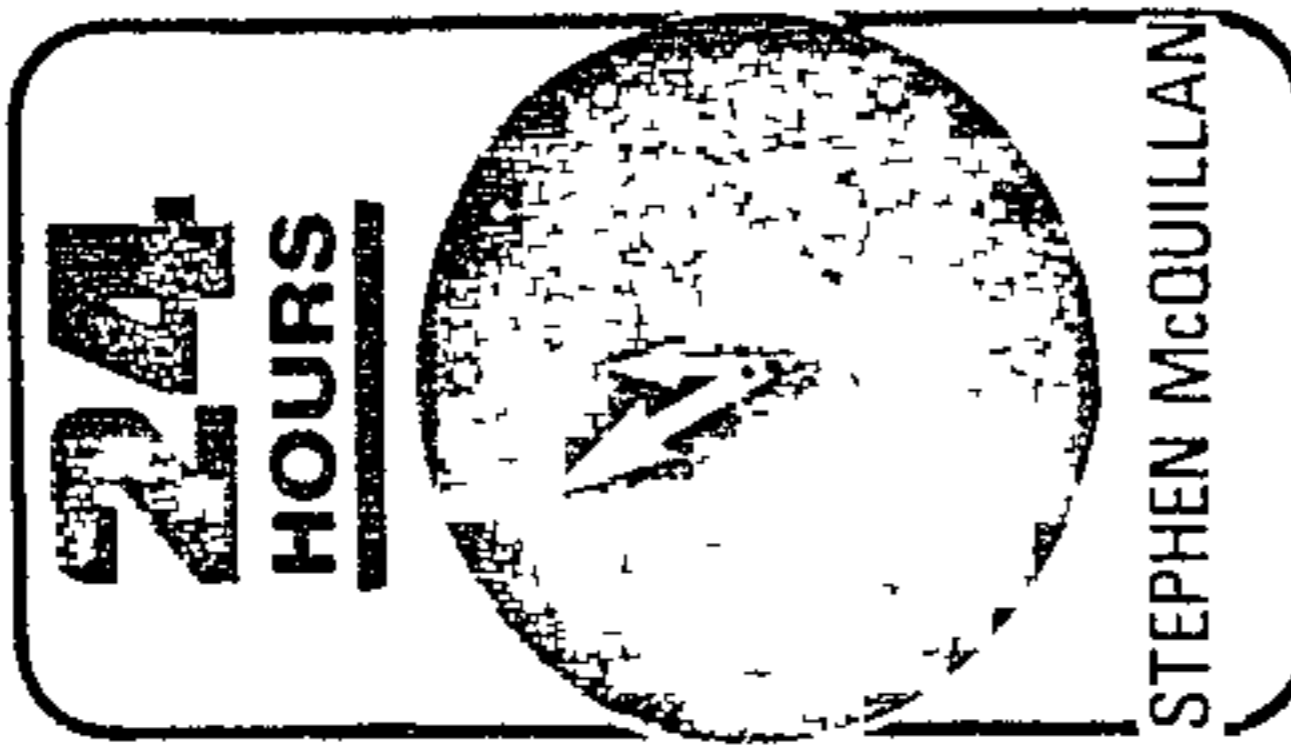

"Although most of the larger firms are members of our association, we have only about 60 members against a national total of about 350 security firms"

Efforts to encourage other employers to join had met with angry responses from rogue security firms, he said

Mr McBrearty called on organisations employing security guard firms to dismiss the firms if they felt guards were being exploited

New security guard wages were introduced last October and represented a 43 percent increase on previous salaries

"I appreciate the wages are still low, but they are as high as the Wage Board could afford to make them without destroying the security guard industry," he said, adding that rates would be increased next October

Under the current rates, watchmen have to be paid a minimum of R8 an hour for 26 12-hour shifts a month, security

On the beat some security guards are forced by unscrupulous employers to do as much as 60 hours' continuous duty.

State have had a record of the mean over January. Other Bureau spokesmen say so far this month Pietersburg has had 48mm of rain, 62mm last January of which fell short of the term average of 111mm.

There has been serious flooding — against a rain record of 126mm last January, which has been recorded this month while Pietersburg has had a top of 41.5mm and 11mm. Three dams in the north — the Rustfontein, the Kalkfontein Dam and the Vaal Dam — have dropped on Tuesday, while the Vaal Dam in the north has dropped from 60.34% to 48.31%, the Spitskop Dam from 4.63% to 4.31%. The Vaal Dam in the eastern Transvaal has risen from 50.34% to 51.11%.



HUPARTHIA KEKANA
On her way to doctor

Police shots kill girl, 7

Pretoria Bureau

A SCHOOLGIRL, aged seven, on her way to see a doctor, was shot dead by police when the taxi she was travelling in raced away when it was flagged down by police. Huparthia Kekana, of Sekwinya Street, Saulsville, died shortly after being admitted to the Kalafong Hospital with a bullet wound in the head on Tuesday night. Her mother, Miss Poppie Kekana, who works in Pretoria as a confectioner, said she sent Huparthia to the doctor when she arrived home after work. "I found out she had been vomiting and was not feeling well. It was the last time I saw my only child."

Two riot squad policemen fired a total of eight shots into the car when it failed to stop after they flagged it down on the corner of Maunde and Sekhu streets in Atteridgeville. The driver and a passenger ran away, while another passenger was wounded in the side. He was admitted to Kalafong Hospital, and was in satisfactory condition yesterday. Police later found that the car, a Valiant, had false number plates. Police investigations into the incident are continuing.

133 320 247 1201
26/1/82

Commerce to probe dropping GST on basics

By GERALD REILLY
Pretoria Bureau

THE Association of Chambers of Commerce — which has been a supporter of GST with no exemptions — is to investigate the merits and demerits of dropping the tax for basic necessities.

Assocom has argued at low rates of tax, the administrative cost of exemptions would outweigh the benefits. The study will be conducted by Assocoms taxing committee, with possible assistance from academics.

The study will look into the reasons for the persistent increases in GST, the scope of exemptions for certain commodities, the cost of administering GST in the event of exemptions and the implications for State revenue.

Assocom's investigation comes at a time of mounting pressure on the Government to remove GST on basic foods and other necessities.

The urgent need for scrapping GST on basics like bread

and milk has been made repeatedly by the Housewives League, the Trade Union Council of South Africa and the Progressive Federal Party.

So far the Minister of Finance Mr Owen Horwood has rejected the pleas on the grounds of "administrative difficulties".

But the issue has become more urgent since Tuesday's announcement that GST is to be raised by another 1% to 7% from February 1.

Economists pointed out yesterday that an extra 7% on basic foods was a heavy burden for lower income earners.

Poverty in South Africa had spread since the start of the recession nearly two years ago. The scrapping of the 7% tax on basics would bring real relief to thousands of black families and pensioners of all races, it was argued.

● See Page 4

Shamir gets a 'yes' vote

YITZHAK SHAMIR — Prime Minister — won a government majority yesterday in a parliamentary vote over Israel's political troubles, after a last-minute coalition with a key coalition partner.

Shamir won a 62-56 vote, following an hour debate among coalition partners. The very last minute unclear if Mr Shamir have the support of the Tami party, which is to leave the coalition. Mr Shamir agreed to write its demands reaching benefits to paid Israelis.

Mr Shamir could defeated the no-confidence challenge without Tamir's votes, the defectors would have seriously weakened the coalition and have forced early elections. A last-minute hitch was demands by Tamir. Mr Aharon Abuhattahat that Mr Shamir committed in writing to the new coalition. He reached an agreement with a letter, with the approval of the Prime Minister, a beaming Mr Abuhattahat told reporters as he emerged from Mr Shamir's in the Knesset building. A no-confidence vote —

Farewell to Parliament

TV Correspondent

SABC-TV cameras will be on hand in Cape Town tomorrow to record the historic last opening of Parliament in its present form.

The fourth session of the seventh Parliament will be the last before the tricameral system under the new constitutional dispensation is introduced.

TV1 opens at 10 15am for coverage of the ceremony.

● The R150 000 Wild Coast-Pan Am Golf tournament at Casino Beach will be screened from 5 11pm today.

Breakfast Quip

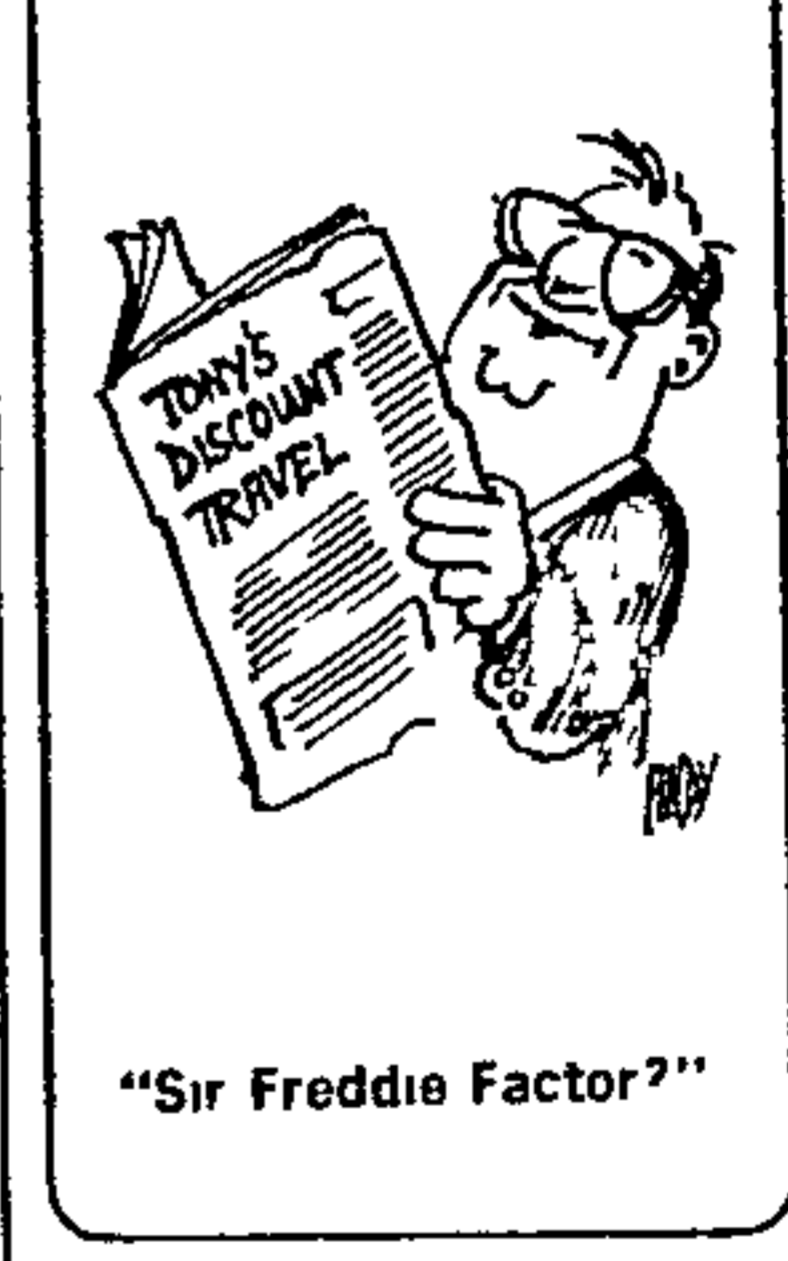

"Sir Freddie Factor?"

Woman strangled in her empty

By EMILIA JAROSCHEK
Crime Reporter

A 73-YEAR-OLD Randburg woman was found strangled to death in the servant's quarters of her home yesterday when friends came to her house to pick her up for a club meeting for the aged.

Mrs Cornelia van der Spek, of Hill Street, Ferndale, the widow of a building contractor, who lived on her own, was discovered by a friend, Mr Thomas Skinstad of Ferndale, when he and three

women arrived at the house to pick her up at 9 45am.

Brixton Murder and Robbery Squad detectives said later that they were investigating the possibility that the house had been looted by her attacker or attackers. A shocked Mr Skinstad said yesterday that Mrs Van der Spek had been repeatedly warned about living alone in the large desolated house.

"She had bought a flat in November last year but was a bit

slow about moving into it because the flat did not have a telephone.

Mr Skinstad then recalled how his morning's "routine trip for the past four years" turned into a horror ordeal.

"My wife and I and two other women friends drove up to the house as usual but Corrie was not waiting for us. I walked up to the house and found the front door open.

"I called her repeatedly as I

went through the door and barked at her to reply. He then I noticed her servant. I looked up and saw she was murdered. "We in the nearby built police and anything could be too late. Police said she had been murdered."

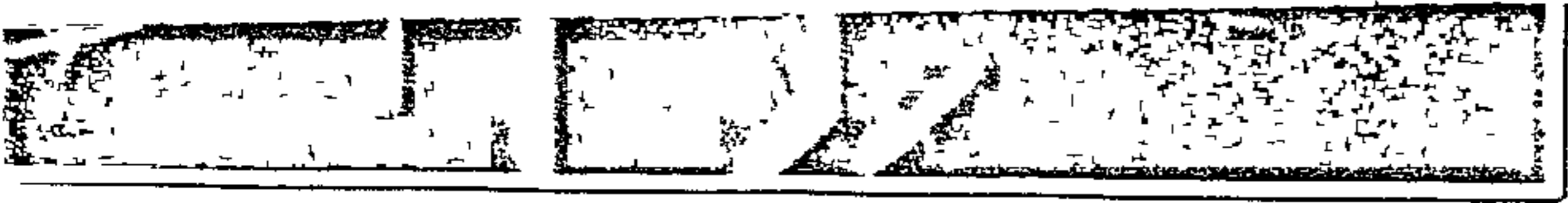

Defector
254
10/1/82

ASSOCOM in call to scrap colour bars

By Michael Chester
and Jon Qwelane

Faster moves by the Government to dismantle hurdles in the development of black business will be urged by Mr Bill Yeowart, president of the Association of Chambers of Commerce (Assocom), in behind-the-scenes talks with Cabinet Ministers and senior advisers in Cape Town next week.

Mr Yeowart will head an Assocom team that will press for high priority to be given to measures to scrap colour bars in the way of black entrepreneurs.

"The development of black business has become critically important", Mr Yeowart said yesterday.

"There are now significant co-operative ventures between the Government and the private sector — such as the creation of the Small Business Development Corporation and the Development Bank of Southern Africa.

"But much more and much faster action is vital.

"If one cannot employ a black manager in a store in a so-called white area, it shows a pathetic aberration that casts a credibility shadow on all the good that has been done and is still being done.

"The same goes for the refusal to permit blacks to own businesses in central business districts

THE
NEW
EGOLI



"Credibility and confidence are tested not only in the business community as a whole — more seriously it is questioned in the sector of the black community wishing to participate in and develop, an economy on capitalist lines.

"Too many feet are being dragged. Often it does not need a whole set of new laws — much can be done by a simple stroke of the pen to change senseless regulations."

The treasurer of the National African Federated Chambers of Commerce (Nafcoc), Mr Sy Kutumela, said black businessmen had, over the years, called on the Government to scrap the colour bar in relation to business.

"It is futile for us to operate under the permit system as we do at present. At any rate whites in this country are too few to provide jobs for all the black people.

"As black businessmen we want to provide those jobs and we don't want to be spectators in the game of free enterprise simply because we are ham-

pered by legislation."

Mr Kutumela said that because of the permit system free enterprise was a joke.

The president of the Soweto Chamber of Commerce and Industries, Mr Vera Kraai, welcomed the initiatives of Assocom.

"Everybody is aware that the business community has long been preparing to scrap discrimination where enterprise is concerned but it is Government red tape and interference that have stood in the way."

Referring to the permit system he said it was easier for white businessmen to enter the townships and do business while blacks found it difficult to do the same in white areas.

● The silent social revolution that is creating bigger and bigger black economic muscle — and the frustrations caused by socio-political attitudes — is the subject of a special series of articles entitled 'The New Egoli', being run by The Star.

The next article in the five-part series appears on Monday.

ASSOCOM REGIONAL CONGRESS

BY TOM LOUW
Business Editor

Make inter-state travel easier plea

EAST LONDON — The Assocom regional congress in East London passed a resolution yesterday urging the Department of Foreign Affairs to take all possible steps to ease the present restrictions on travelling between South Africa, Ciskei and Transkei, in order to facilitate business relations between the three countries

The mover of the motion, Mr Martin Goldswain, of the East London Chamber of Commerce, made the point that tourism suffered and every businessman travelling from one country to another was also a tourist

He said the objective of the resolution was to ease the whole situation on the borders, for the good of all — the people of Ciskei, Transkei and South Africa

In an explanatory background note it was stated that police from all three countries were stopping travellers and demanding passports or identity documents, with the risk of prosecution if they could not be produced. Fines were accepted in cash only and offenders might be held in custody until the fines were paid

An earlier resolution called on Escom, in the interests of promoting regional economic development in the north-eastern Cape, to upgrade

the transmission lines between Barkly East and Elliott as a matter of urgency. The mover, Mr Ian Thompson of Elliott, said the development of the town was being inhibited because Escom could not cater for an increased maximum loading, and there were problems of voltage fluctuations and interruptions of supply

An Escom representative, Mr Opperman, made the point that Escom must look to the area concerned to meet the cost

The Mayor of East London, Mr Errol Spring, speaking as president of the Border Regional Development Association, said the cost and supply of electricity was one of the major reasons for the depopulation of the platteland. There was a particular problem in the Eastern Cape with its long transmission lines and high cost

He said "We cannot accept that the cost must be borne by the area getting the supply. We are not allowed by the government to generate our own electricity and surely it is time to rationalise and have a standard tariff throughout the country"

The chief executive of

Assocom, Mr Raymond Parsons, pointed out that a commission is at present examining the workings and policies of Escom. He suggested that the resolution should be brought to the attention of the Region D Advisory Committee

The congress also passed, without dissent, a motion from the Kaffrarian Chamber, calling on the government not to proceed with its intended law restricting the right of individuals to institute legal proceedings against any government of the independent states

The white corridor, in whatever political framework it might find itself, would remain for a century or more the agricultural, industrial, organisational and infrastructural springboard and engine room for the Ciskei, Transkei and white corridor economic entity, said Mr Max Phillips during an investment symposium at the conference

Mr Phillips said "We and the government, our partners in this venture, must seek to create an infrastructure and climate in which the personal effort will prosper"

There must be clear

definition of boundaries to ensure security of the present land tenure system. There must be investment in better farming practice, better water use, better energy use and at reasonable cost, and very much better skills training

His third priority was to provide infrastructure and housing and job opportunity for a vastly increased population. The alternative was to cut down population growth drastically to manageable proportions

Next he put the need to develop a sensitivity and a code of conduct and standard of behaviour. His fifth investment priority was the nurturing of the rural economy as the foundation of the rest

Mr Phillips emphasised the need to develop small businesses and the informal sector

The white corridor would not thrive in isolation, he said. It depended for its prosperity on four basic issues. These were its position as the region's economic engine room, its own security, the prosperity of its neighbours and the security of those neighbours

Brand: prospects better

By SALLY FLETCHER

EAST LONDON — The implications of recent political developments in Southern Africa augured well for the long term economic outlook, Dr Simon Brand said here yesterday

Dr Brand, who is chief executive of the Southern Africa Development Bank, was making the opening address at the regional congress of Assocom in East London

Dr Brand said that although the short-term prospects of economic recovery, anticipated in early 1984, had not materialised, there were encouraging signs for 1985-86

The trend towards increased internal stability and the growing detente between Southern African nations fostered an optimism at home and greater confidence abroad, Dr Brand said

"Problems we may yet have to face are political developments arising from constitutional advance. There will be an increase in the demand for economic advance, goods and services in the main. This will place a strain on the economy and could aggravate the inflation rate," Dr Brand said

To provide equal economic opportunities, groups which have been used to a high measure of state aid would have

to stand on their own feet to a larger degree

He believed that the sooner South Africa harnessed its human resource potential the better, because periods of rapid economic growth could not be sustained by domestic reserves and the attraction of foreign capital was essential

"The regional development policy is a positive response to the decentralisation of industry and the exploitation of our human resources

"There is every reason to expect that when economic recovery sets in, the decentralisation policy will make a significant impact on the dis-

tribution of economic development," Dr Brand said

"However, the interests of single states may have to be submerged in the regional interest — the success of regional policy lies in the broad aspect"

Dr Brand said that private investors and to some extent foreign aid agencies felt prohibited from investing in Southern Africa either on political grounds or because of a belief that certain countries would be unable to adequately exploit aid

"It is our duty to remove these misgivings and give foreign investors every confidence that this is a stable region in which to invest"

Investment scope outlined

BY TOM LOUW
Business Editor

EAST LONDON — In any developing country there must be the correct climate for investment, Mr Sonny Tarr, managing director of the Transkei Development Corporation, told the Assocom symposium on investment in the eighties here yesterday

Transkei had been fortunate in being able to attract people with the sense of purpose and the expertise needed so vitally in a developing country

The generous incentives which became effective in April 1982 had made Transkei a land of unparalleled opportunity for the investor

With the financial strength of his corporation, the commitment of the government and its stability, the total commitment of the worker and also the commitment of industrialists industrial development was a very automatic result

Between April 1982 and December 1983, 34 new industries were approved with a total investment of R47 million. This represented 5 954 new jobs

Since December, 15 new industries were under investigation, offering more than 5 000 new jobs

The new growth point at eZibeleni, near Queenstown, had the potential of becoming Southern Africa's greatest industrial development area

One of the most significant and exciting forms of investment was that being undertaken in the small industry and informal sector. Mr Tarr said "We believe that this form of investment can play a major role in the development of Transkei." A special body, the Transkei Small Industries Development Organisation, had been set up to concentrate on this sector

Timber, said Mr Tarr, was Transkei's most important natural re-

source, and a disciplined and farsighted policy had been set by the Department of Forestry. There was a vital need to plan the industrial or processing aspect, and the TDC was determined to exploit this possibility to the full

The managing director of the Ciskei People's Development Bank, Mr Frans Meisenholl, praised the Ciskei Government for its open hearted commitment to free enterprise

He said "The motivation for all investment is profit. A profitable balance sheet is only possible in a free market society where capitalism is allowed to go its natural course"

Mr Meisenholl is in the United States, and his paper was read for him by Mr Wessel van Wyk of his staff

Mr Meisenholl said in Ciskei the concept of free enterprise did not remain an optimistic promise but was put into

practice. The government had even gone so far as legalising freehold title to property for foreigners in Ciskei

The report of the Swart Commission, which was aimed at maximum exploitation of the benefits of free enterprise had been accepted in full. A target date of two years had been set for its implementation, and members of the commission had been given the task of implementing their recommendations

Mr Meisenholl listed the factors he saw as making up the potential of the region

- An abundance of cheap industrial land.
- A well-established infrastructure,
- A large, cost-effective and easily trained labour force, with the highest literacy rate (57 per cent) of all the black peoples of Southern Africa.
- The best concessions for industrial establishment one could hope for

Bus dispute goes on in spite of plea

ARC45 18/4/84

133

Staff Reporter

THE Cape Town Chamber of Commerce has appealed to City Tramways and the Tramway and Omnibus Workers' Union to settle their dispute on overtime and restore full services

However, at an emergency meeting today, the busmen decided to continue the overtime ban

The dispute over a long-standing demand for more wages and other grievances has disrupted bus services in the Peninsula since Monday. Thousands of workers have been up to an hour late for work, many of them more than once

"It is incumbent on the two parties to settle their dispute as quickly as possible," the director of the chamber, Mr Brian MacLeod, said today

"I know it is sometimes very difficult to do so, but the parties must endeavour to settle the dispute"

Emergency

The union's executive committee decided at an emergency meeting today to continue the ban on drivers working overtime. This was in accordance with a unanimous decision taken at a general meeting of the union at the weekend

"Our chaps are in an ugly frame of mind because of the ridiculous offer made by the company," said Mr D C Benade, secretary of the Tramway and Omnibus Workers' Union

Contingency measures by City Tramways to beat the ban on overtime could not cope with queues in some Peninsula areas today and thousands of commuters were again late for work

Delays

Services were running close to normal on many routes, but passengers in some Cape Flats areas particularly Hanover Park and Nyanga, were delayed by as much as an hour. Queues were up to three times as long as usual

In some areas the scheduled service was replaced by a controlled system of diverting buses to routes where the demand was greatest

A bus company official at Hanover Park said today that the disruption was "definitely worse than Monday. Today we don't even have spare buses"

Unfair labour practices: Tighter definition mooted

Political Staff

HOUSE OF ASSEMBLY.

The National Manpower Commission has recommended a tighter definition of unfair labour practices including the outlawing of consumer boycotts by workers during disputes.

At present an unfair labour practice, a concept introduced after the report of the Wiehahn Commission of Inquiry in 1979, is undefined and this has caused some problems as it has been left to the Industrial Court to define it.

The National Manpower Commission, whose reports into levels of collective bargaining and



National Manpower Commission report

works councils, the registration of trade unions and the Industrial Court was tabled in Parliament yesterday, said the definition of an unfair labour practice should create new rights.

However, some flexibility should be incorporated and the final authoritative interpretation of the concept should rest with the Industrial Court.

It said unfair labour practices should be designed to protect individuals as well as organizations and that there should be direct access to the court in cases of disputes involving unfair labour practices. It also said that al-

though a list of unfair practices should be given in the definition "this list must be capable of amendment as circumstances change".

It said the following practices should be included in the definition:

- "Employer interference in union affairs and union interference with employer supporting, aiding or interfering in the establishment, management or administration of a union, or a union refusing to negotiate with management until a particular member of management is dismissed."
- "The victimization

of the members, officials and office-bearers of trade unions, works councils or other similar organizations of workers."

● "The use of unconstitutional, unfair and misleading recruiting methods and arguments by a union or employers' organization."

● "The unjustifiable dismissal or termination of employment of workers and the replacement of employees with workers of another race group where the "ostensible purpose" is to provide less favourable terms and conditions of employment."

● "The unjustifiable refusal by a union or em-

ployers' organization to grant membership to a person who satisfies the criteria for membership of the organization concerned."

● "Secondary product boycotts by a trade union or employees resulting from a labour dispute."

● "The abuse of organizational or negotiating power by a trade union or a group of employees to the detriment of other groups or individuals, for example a union using its bargaining power to compel an employer to deal only with it and not to negotiate with a minority."

● "The black-listing of employees and employ-

News 11/5/84 133

CITY

Seminar on wage negotiation

Labour Reporter

PREPARING businessmen for wage negotiations with trade unions is the theme of a seminar to be held in Cape Town next week.

The seminar, which will be addressed by Professor Blackie Swart of the University of Stellenbosch's graduate school of business, and industrial relations consultants Mr Steuart Pennington and Mr J Myburgh, hopes to attract chief executives, senior managers and industrial relations managers

A spokesman for the industrial relations consultancy Steuart Pennington and Associates, which is hosting the seminar, said that wage practices in companies were "increasingly being challenged by the trade union movement".

"Management should be aware of the likely union stance on these issues and be in a position to reduce expectations, while at the same time ensuring the continuity of acceptable wage practices which are geared towards rewarding for skill and job worth."

A subsequent seminar, hosted by the same consultancy, will focus on new industrial safety and health legislation.

Trade unionists have attacked the new legislation for not allowing enough worker control of safety practices.

Speakers will include Mr J Baard, industrial relations adviser to the Cape Chamber of Industries, and Dr Jonny Myers, an industrial health expert from the University of Cape Town.

The two seminars will be held on May 15 and 16 at the Arthur's Seat Hotel, Sea Point.

f
A
ti
n
ll
S
g

Commerce attack on govt policies

CAPE TIMES 25/5/84

133
~~270~~ ~~270~~

By ROBIN PARKER

THE Cape Town Chamber of Commerce, one of the senior members of Assocom, has attacked the government for overspending, for its tax plans under the new dispensation and for the mood of uncertainty it has created among City blacks over removal proposals.

In his presidential address at the organization's 123rd annual general meeting in the City yesterday, the president, Mr R W Stern, said the government's record of overspending and its inability to impose on itself what it wanted to impose on others was unacceptable.

"Unless the financial discipline, preached but not practised, is apparent, we will continue to have a credibility gap between the business sector and government.

'Hard year'

"The year under review has been hard and depressing," he told members attending the meeting in a Gardens hotel. "The prognosis for next year is that it is likely to be just as hard and depressing."

Inflation had come down, but not to an acceptable level, and was headed upwards with the latest increase in general sales tax. The gold price continued its downward trend, the rand had weakened sub-

stantially, interest rates had soared, as had the corporate tax burden, the money supply had expanded at an unhealthy rate and unemployment was at a record high.

Also, individuals were deeper in debt than ever before. Commercial bank overdrafts to individuals had overtaken overdrafts to companies.

Mr Stern voiced the Chamber's opposition to the proposed taxing powers to be given to local authorities under the new political dispensation, which was going to result in a large increase in government spending.

Taxing powers

He said the government had accepted in principle that local authorities would be given taxing powers. While the government had endorsed the principle of open consultation with the private sector, to date there had been only limited consultation on these new forms of taxes.

"We in the Cape Town Chamber of Commerce are against these proposals because in our view they will place a severe administrative burden on both the private and public sectors and will have an impact on costs and affect the creation of jobs and new investments."

'Uncertainty'

Pointing a finger at the government for its handling of the Cape's black residents, Mr Stern said residents of the existing black townships were "entitled to no less rights than those to which we are entitled when it comes to owning and improving property."

"They are permanent, respected and productive communities, and the uncertainty under which they are presently labouring is contrary to the interests of everyone who lives in Cape Town."

Mr Stern said he was concerned about the possible "persuasion" that might be used on residents of the Penn-

sula's black townships to move to the new Khayelitsha development.

The new area would probably "only just" be able to accommodate the natural increase and influx into the Western Cape and house those who were already in the area but had no suitable accommodation.

Mr Stern also urged employers to shoulder some responsibility for the housing crisis.

Housing

He said estimates of housing needs between now and the end of the century stood in excess of three million units — two million of which were for black people.

Without some action by employers, either through direct assistance by way of company loans or subsidies on building society bonds, "there is little likelihood of resolving this problem."

• Longer trading hours urged, page 2



Not Medusa, but M-demonstrates a new Design for Living Exhibit Cape Town, are made heat principle —

CAPE UNION MART
Winter Campers & Holiday Makers
 Enjoy warmth and comfort
 • ALL BAGS FULLY HOME

Bike pierced car like 'arrow'

Own Correspondent
 LONDON — Two young brothers died in a horror crash when a motorcycle "travelling like a bat out of hell" at about 180km/h pierced a car like an "arrow" an inquest heard yesterday.

Mr Hipwell said "It pierced the car like an arrow, crucifying the children and finished up in a mangled mess". A police reconstruction had shown that the motorcycle must have been travelling at 180km/h.

crack of dawn

"It had to come — Piet Promises, Piet"

Ill-fed children: No valid estimates

HOUSE OF ASSEMBLY
— The government has no "general and valid" estimate of the number of children in South Africa suffering from malnutrition, the Minister of Health and Welfare, Dr Nak van der Merwe, has said in a written reply to a parliamentary question.

Dr Van der Merwe told Dr Marius Barnard (PFP Parktown) that because the term "malnutrition" was ill-defined, and the standards used to assess it were not "universally applicable", there were "no general and valid estimates of the number of children suffering from malnutrition per population group" in South Africa — Sapa

Political Staff
HOUSE OF ASSEMBLY.
— Apart from two minor amendments, a controversial new labour law has been left basically unchanged by a parliamentary select committee.

The Labour Relations Amendment Bill will make most agreements between unions and employers unenforceable in courts, including the industrial court, and it will make it a criminal offence for employers not to submit particulars of agreements to the Department of Manpower.

The bill was attacked by a number of unregistered unions when it was first introduced.

Yesterday, the Progressive Federal Party spokesman on manpower, Dr Alex Boraine, MP for Pinelands, said the decision to go ahead with the bill was "cynical in the extreme".

One of the changes proposed by the select committee is that "particulars" of agreements will have to be provided

to Department of Manpower inspectors instead of copies of agreements, as originally proposed.

The other change is that employers or employer groups will be responsible for forwarding these particulars and they will have 90 days to do so, instead of 30 days. In the original draft "parties" to the agree

continually states it believes in freedom of association in labour matters."

He did, however, welcome the changes that had been proposed by the select committee.

In future, agreements, unless they complied with the regulations, would not be enforceable in any court, including

interests of employers or employees or in the public or national interest".

Dr Boraine said this gave the minister new powers, which were essentially political, and the select committee had refused to change this.

In general, the big stick is still in the proposed law instead of the carrot.

"They are taking a strange step to deal with a small part of the labour movement, and it seems to me they are merely trying to please the right-wing trade unions."

"A large number of bodies, including the Federated Chamber of Industries, sent memoranda to the select committee, asking the government not to proceed with the measure."

"If the government is committed to industrial peace they are going about it in a very funny way and if they are to continue the enlightened approach of Wiehahn, they have a very remarkable way of showing it," Dr Boraine said.



ment had to forward copies of the agreements.

Dr Boraine said the government action was "bad planning" and a "stupid way" to deal with labour legislation.

"This can only antagonise workers, who will see it as an attack on them and as an attempt to control them, although the government

the industrial court

"I think that is pathetic and a cause of trouble," Dr Boraine said.

He was also strongly opposed to a provision in the bill which will enable the minister to order all or any of the provisions of agreements to be inoperative if he considers it to be "in the

con.

CAPL Tron's 8/6/84. ~~133~~ 133

Go-ahead for 'half-baked' bill

Political Staff

HOUSE OF ASSEMBLY
—The government yesterday pushed ahead with the controversial Labour Relations Amendment Bill, in spite of calls from two opposition parties and the Federated Chamber of Industries for it to delay the measure

The chief Opposition spokesman on manpower, Dr Alex Boraine (PFP Pinelands), said during the second reading debate of the bill that it was not only "premature and illogical" but also "potentially disruptive"

He also said it was "half-baked and quite out of step with the spirit of legislation which has been introduced into this House since the appointment of the Wiehahn Commission"

Dr Boraine called on the government to postpone consideration of the proposed legislation until after it had received representations on the 400-page National Manpower Commission report on trade union affairs

In his speech, he quoted telegrams from the Federated Chamber of Industries and the Transvaal Chamber of Industries also calling on the government to

defer the bill until after comments had been received on the Manpower Commission report

The FCI had said it was "unwise" to proceed with the measure, particularly in view of the need to maintain labour peace in South Africa and the TCI had said it was "illogical" to proceed with a measure which could be changed

who said there was tangible evidence that it was premature to proceed with the bill until the commission report had been considered

Replying, the Minister of Manpower, Mr Pietie du Plessis, said one of the basic issues was whether one wanted orderly coexistence in South Africa or not

The vast majority of

must we comply with the regulations but you allow these unions to do what they want"

Mr Du Plessis accused Dr Boraine of pleading for organizations "which do not want to do anything at all to comply with the requirements of the law"

These unions wanted to sign agreements and enjoy the benefit of the law but they did not want to comply with the requirements of the law

The government did not prohibit anyone from signing agreements but these agreements should be in accordance with the provisions of the law

Asked by Mr Miller what would happen if the new law led to illegal strikes, Mr Du Plessis replied "If they take part in illegal action they know they are heading for trouble"

He also said the cornerstone of the measure was that it was reasonable and in keeping with the feelings of the majority of people who wanted peace in the labour field. In particular, the bill was welcomed by established unions, Mr Du Plessis said

"If we just let this matter die, we are going to get chaos in the labour field"



after representations on the Manpower Commission report had been considered

Dr Boraine accused the government of using "the big stick of compulsion" instead of the "carrot of encouragement"

He was supported by the New Republic Party spokesman on manpower, Mr Ron Miller, MP

unions in South Africa complied with the minimum requirements of the law but there were about six unions who refused to do so, Mr Du Plessis said

The government did not want to perpetuate permissiveness in the labour field and it wanted to establish order

The established unions had asked "why

Strike: Cusa hits out at chamber

Labour Reporter

After the country's first legal strike by black mineworkers, the Council of Unions of South Africa (Cusa) has expressed its abhorrence of the strategy used by the Chamber of Mines in the 1984 wage negotiations

The National Union of Mineworkers, an affiliate of Cusa, was pushed to the brink of strike action before the chamber capitulated, said the council today

"If the chamber wanted to see leadership, it has seen the NUM leader-

ship. If the chamber wanted to observe union discipline, control and logistical capacity, it now has a clear picture"

Once the chamber and its member companies had assessed the toll of the past few days — the loss of workers and damage to property, the mistrust created between union members and employers — they would need to ask themselves whether the exercise had been worth it, said Cusa

Attempts by employers to enforce a settlement had been noticeable in negotiations, Cusa added

133

and Shipping

Seifsa head calls for clarity on labour law

JOHANNESBURG — Uncertainty arising out of the current legal definition of an unfair labour practice is inhibiting employers in the conduct of their industrial relations

This was stated today by the president of the Steel and Engineering Industries Federation of SA (Seifsa), Mr J W Nelson, at the federation's annual meeting here

Delivering his presidential address, he said intention of the revised industrial council dispute procedure introduced last year was to encourage parties to resolve their differences through agreed procedures rather than through strike action

"This appears to have happened. The industrial council has handled over 150 disputes in the past 12 months and it is encouraging to report that approximately a third of these have been resolved at industrial council level," he said

"The increased use of official procedures by trade unions to take up matters on behalf of their members has also meant that the Industrial Court had to play a far more prominent role in the industrial relations arena. Over 300 cases have been referred to it since the start of 1983

"This has led to a widespread debate on the role of the court and, during the course of the year, the Department of Manpower invited comment on the National Manpower Commission report in this regard

"The uncertainty arising out of the current definition of an unfair labour practice is inhibiting employers in the conduct of their industrial relations and it is important that a formula be found whereby the court can assist in ensuring fair employment practices without becoming directly involved in both the structure and practice of collective bargaining"

The past year had also seen increasing fragmentation of the trade union movement in the industry

"Some of the traditional alliances in the trade union movement appear to be changing and inter-union rivalry has continued at a high level

"This makes it difficult for employers to maintain stable collective bargaining and joint consultation arrangements"

The federation had continued to encourage maximum participation in the National Industrial Council on a voluntary basis by both employers and trade unions

"The National Manpower Commission has continued its investigation into collective bargaining by inviting comment on a working document dealing with levels of collective bargaining and the extension of agreements to cover non-parties

Seifsa has responded to this invitation with a detailed submission and it is hoped that the National Manpower Commission will complete its investigation as speedily as possible so as to bring to an end the damaging speculation that continues to take place regarding some of the key provisions of the Labour Relations Act

"The continuing imbalance in the supply and demand for artisans constituted a serious limitation both in the development of the industry and in the wage structure

"In view of this a plan to increase the intake and improve the training of apprentices has been formulated

"The plan seeks to encourage 'off-the-job' training in the industry by allocating a fixed proportion of income from the training levy to the establishment of industry apprentice training centres and by adapting the grant system so as to provide higher payments to companies in respect of apprentices who qualify by trade test"

Mr Nelson said activity in the engineering industry continued at a depressed level though the steep decline in production levels during 1982 up to mid-year '83 appears to have been halted — Sapa

Property

Davis slams divisive reports as false

133
E-Post 13/10/84

ALLEGATIONS that the Building Industries Federation of South Africa (Bifsa) is actively expelling building companies from the industry are blatantly untrue and bear little relevance to the activities of Bifsa, according to its executive director, Mr Lou Davis

Responding to a recent article published in the Financial Mail, Mr Davis pointed out several inaccuracies which, he said, distorted the true picture. These were

- There was no major contractors' division within Bifsa although an advisory sub-committee was being formed
- Master builders associations were responsible for imposing fines against member companies — Bifsa was not responsible
- The federation did not have the power to expel building companies from the industry

It could debar them from the federation but could not exclude them from the industry or even threaten their livelihood

"It is necessary to bring an element of organisation and unity into the building industry and the purpose of the federation is to unite companies — big or small — and not fragment them," he said

"We most certainly do not operate as a cartel, do not fix prices and have never attempted to interfere with the free enterprise principles that are inherent in our economy

"On the contrary, we support and encourage fierce competition between our members," he said

Mr Davis said Bifsa did not act in the manner of an irresponsible trade union but was a federation whose aims were directed towards the benefit of its members and the general public

"We have, over the years, maintained close ties with the trade unions in the building industry and are determined to keep these sound relationships on an even keel in a spirit of mutual trust

"Industrial relations are crucial for worker stability and, as the representative employer body, it is in the interests of the building industry to maintain industrial peace through the accepted industrial council system"

Mr Davis contends that South Africa's building industry needs some uniformity to maintain equitable contractual conditions free from duress or any form of intimidation

But he does not see this leading to abuses, unfair conditions or disruptive controls being imposed on builders or clients around the country

The federation brings some sanity to a potentially chaotic environment by organising this important industrial sector for the benefit of the national economy

"Experience overseas has amply illustrated the disastrous results of fragmentation in the building industry

"By uniting this industry, we will help to stabilise a commercial sector which is traditionally subjected to extreme peaks and valleys

"This in turn means that the man in the street does not suffer from higher costs when conditions improve or face delays as a result of supply and demand factors

"There is a real need to protect, most importantly, the general public from high price rises

"By bringing order to the building industry we are going a long way towards achieving this," he added

Employers 'Need common strategy on unions'

~~1330~~ S. S. Far
28/10/84

EMPLOYERS should get together to thrash out a common strategy against unions, industrial relations expert Andre Jacobs of Sapoia told a recent conference in Johannesburg. "Employers would do well to remind themselves that while it is acceptable and good to compete in the commercial market it spells disaster to sabotage each other in the labour field . . .

"Employers have to get together *en masse*"

Those who decided on how to deal with unions in isola-

tion "will find the current union tactics of 'leapfrogging' or indirect negotiations impossible to contend with".

Unions would increasingly gain concessions from individual employers and demand similar concessions from others through indirect negotiation tactics

Current labour relations suggested employers would increasingly face disputes and industrial action over issues that did not fall under their direct control or influence, Mr Jacobs said.

Business joins in detainee outcry

STAR 15/11/84

133

[Handwritten signatures and scribbles]

Unions and political groups have protested strongly over yesterday's Security Police swoop in which six activists were held and the number presently in detention topped 230 — the highest for years.

And, as the row over the detentions continued, seven students and ex-students at the University of Natal and three women students in Grahamstown were arrested after demonstrations against the moves.

Big business has added its voice to the outcry. In a significant move the Association of Chambers of Commerce and the Afrikaanse Handelsinstituut have supported the Federated Chamber of Industries statement that the detention of unionists is a serious setback to talks between the private sector and major union federations.

They have called on the Government to meet key industrial, commercial and labour organisations as a matter of urgency.

The largest trade union federation, the 460 000-member Trade Union Council of South Africa (Tucsa), has declared the detentions of the general secretary of the Council of Unions of South Africa, Mr Piroshaw Camay, and Mr Chris Dlamini, of the Federation of South African Trade Unions (Fosatu), harmful to community and industrial relations.

Fundamental

"Tucsa believes that the current and tragic unrest in various troubled black urban areas cannot be resolved by violence, from whatever quarter, or by detentions and bannings but only by addressing the fundamental problems facing our society."

Mr Camay was one of those held yesterday under section 29 of the Internal Security Act. Others were National Union of South African Students president Miss Kate Philip, Mr Guy Berger, of Media and Research Services, Mr Jethro Dlalisa, a branch chairman of the Transport and General Workers' Union, Mr John Campbell, of the

Staff Reporters

Screen Training Project, and Congress of South African Students member Mr Victor Kgobe.

Professor Karl Tober, vice-chancellor and principal of the University of the Witwatersrand, and Professor Alf Stadler, chairman of the Senate Academic Freedom Committee, reiterated the university's grave concern about detention without trial.

Yesterday's detentions have been linked to others since the stayaway last week. In this period there have been 17 confirmed detentions which have crippled the Transvaal Regional stayaway committee and taken away leaders of unions and community groups which spearheaded the protest.

The Azanian Students' Organisation said students could not sit back and "silently watch the removal from society of fellow South Africans whose only crime is their thirst for democracy and justice."

The Release Mandela Committee reiterated its commitment to mass-based action in the face of detentions. It asserted that detaining leaders would not remove the present conflict which sprang not from the detained leaders but from the Government's refusal to address popular grievances.

Wits SRC president Mr Grant Rex said last night: "We see the detention of Kate Philip as part of the ever-increasing State repression of legitimate opposition to apartheid. Mass detention without trial clearly illustrates the myth of reform."

Employer bodies and Govt at loggerheads

Business to meet Minister on arrests

STAR 16/11/84

By Michael Chester

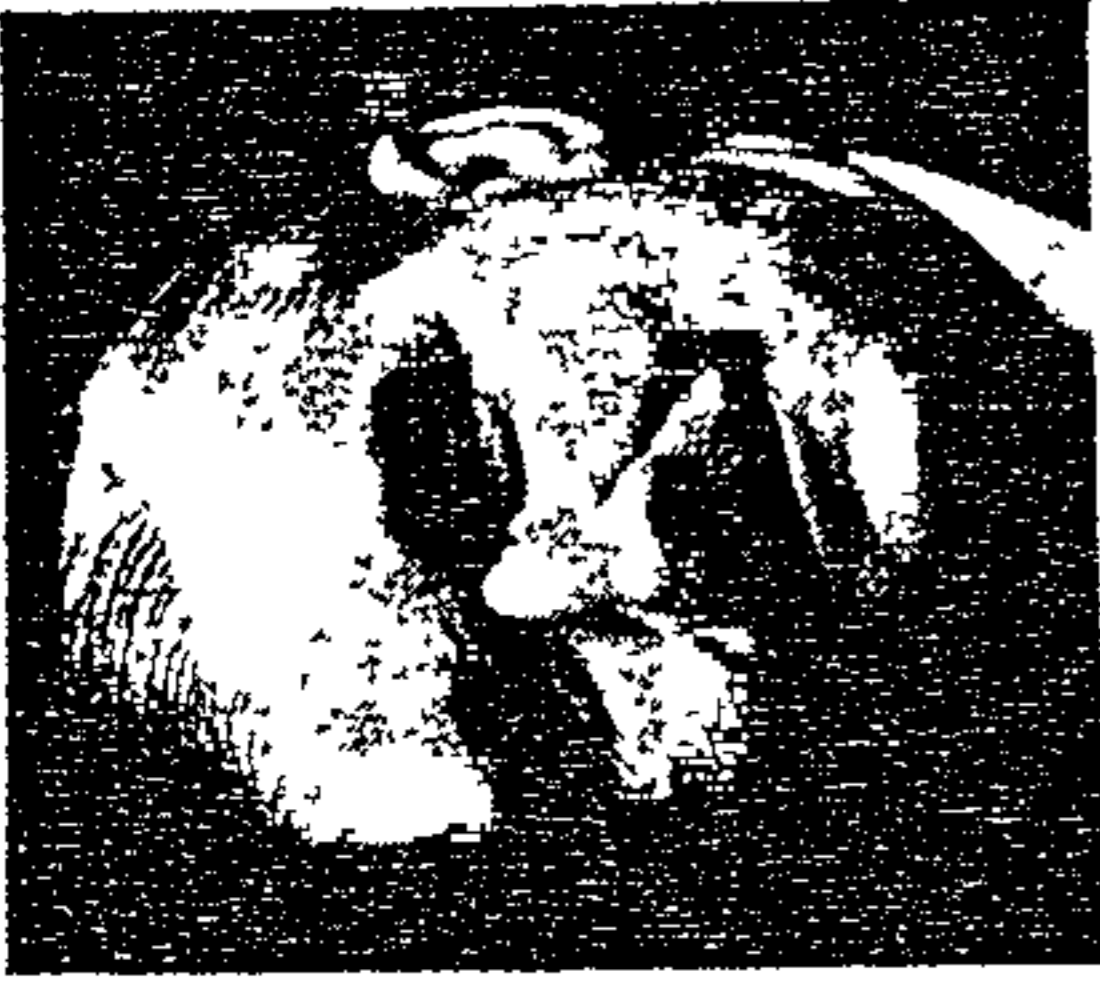

Mr Louis le Grange

Big business today confirmed that talks would begin in the next few days with Mr Louis le Grange, Minister of Law and Order, about the wave of detentions that has followed the recent nationwide black stayaways.

The Minister and the three main employer organisations are at loggerheads in the heated controversy.

Tension was heightened in Virginia, Orange Free State, last night when the Minister used a public political platform to counter-attack the organisations over the combined protests they lodged about the detentions

The row is expected to reach a peak when the Association of Chambers of Commerce, which claims to represent more than 20 000 companies, meets the Minister for talks on the handling of the stayaways

Neither Assocom, the Afrikaanse Handelsinstituut nor the Federated Chamber of Industries, who joined forces to send a telex to the Minister warning that the detentions could endanger labour peace, made any move to soften their protests today

'Government saddened'

Mr le Grange told the Virginia meeting that the combined statement issued by the three organisations was an "extremely serious matter which had left the Government disappointed and saddened"

He said that when he had asked them for clarification of their stand they had replied that the motive was "to reconfirm their credibility" with two trade unions that had been named

The Minister argued that if the three organisations had issued their protest without the backing of all their members, there had been abuse of the name of each organisation

Mr Raymond Parsons, chief executive of Assocom, today issued a brief statement following a hurried telephone conversation with Dr Johan van Zyl, executive director of the FCI "The employer organisations do not wish to respond further on this matter to the Minister of Law and Order publicly.

"Assocom has an interview with Mr le Grange in Pretoria next week to discuss the whole question of the stayaways, intimidation and the role of the trade unionists"

CAPE TOWN
17/11/84

**Police
minister
to meet
business**

Own Correspondent

JOHANNESBURG — Organized business will meet Mr Louis le Grange, the Minister of Law and Order, on Wednesday to discuss several "sensitive" issues related to the recent unrest and the motive behind its condemnation of the latest wave of detentions

At a political meeting in the Free State on Thursday night, the minister launched a public attack on three major business organizations who warned that the detention of trade union leaders was exacerbating a "very delicate labour situation"

Assocom

The Association of South African Chambers of Commerce (Assocom), the Federated Chamber of Industries (FCI) and the Afrikaanse Handelssinstuut (AHI) sent a joint telex to Mr Le Grange on Wednesday warning that the wave of detentions of trade union leaders could endanger labour peace

Assocom confirmed yesterday that it would meet Mr Le Grange on Wednesday and would probably be joined by the FCI

An FCI spokesman said Dr Johan van Zyl, executive director of FCI, had met Mr Raymond Parsons, chief executive of Assocom, to discuss Wednesday's meeting in Pretoria

Issues that will be discussed at Wednesday's meeting will be stayaways, intimidation, violence in the townships and the role of the trade unionists

'Disappointed'

Yesterday, however, the president of the AHI, Mr Leon Bartel, said he did not think there was a possibility that the AHI would participate in the talks with the minister

And Mr Parsons was yesterday not prepared to respond to Mr Le Grange's statement, which said the statement issued by the three organizations was an "extremely serious matter which had left the government disappointed and saddened"

Assocom, however, issued a brief statement saying "Organized business does not propose to respond further publicly to the Minister of Law and Order on this matter

"Assocom will meet with Mr Le Grange in Pretoria next week. We hope this meeting will clear up any misunderstanding about the private sector's view"

All three organizations yesterday declined to discuss the row

No pay if employees are absent, says JCC

STAR
20/11/84 Labour Reporter

In a brief to its members, the Johannesburg Chamber of Commerce has advised that in the event of any possible future stayaways employers should embrace the policy of no work, no pay.

Other guidelines which the JCC has offered to its members in the light of the successful stayaway by some 500 000 black Transvaal workers on November 5 and 6 are:

- In the interests of both workers and employers there should be no disruption of business
- Members should formulate their own policy with regard to dismissals and communicate this to employees — as well as the company policy on absenteeism
- In the event of a stayaway, employers should examine individual circumstances before taking action
- It should be clearly explained to employees that there could be no remuneration for work not performed

The brief went out amid widespread rumours of a call for another stayaway within the next couple of weeks. The rumours are unfounded, and the organisations who lent their support to the November 5/6 action have declared themselves opposed to another stayaway.

STAR 27/4/84 (133)

Business united on detentions

By Michael Chester
Big business has taken a united stand in urging the Government either to release or to lay specific charges against trade union leaders detained in the recent wave of black unrest and mass stayaways

The strategy is aimed at separating detainees who merely pursued their ardent trade unionism from those who may have had the ulterior motive of economic sabotage and subversion

The business mood was improved yesterday when the Minister of Law

and Order, Mr Louis le Grange, gave an assurance that the Government was in no way seeking to act against individuals or organisations because of their trade union activities — nor because of their political views

ASSURANCE

The assurance, given to a delegation from the Federated Chamber of Industries (FCI), came in response to criticism from the business sector that detentions without trial were a threat to industrial peace

Dr Johan van Zyl, executive director of the FCI, said last night following talks in Pretoria that the Minister had added that the Government acted only where individuals were involved in actions which threatened the security of the State

The FCI commented in a statement "For this approach to be demonstrably clear, both inside and outside the borders of South Africa and especially the workplace, the FCI urged that detained individuals should be charged in court as

quickly as possible"

The statement added that the meeting had been a constructive exchange of views and had helped to clarify lines of communication

It went on "The FCI and Government agreed that stayaways are destructive and potentially dangerous ways of pursuing grievances

"The chamber confirmed its view that direct negotiations between employers and unions are the best way of resolving workplace-related grievances and maintaining labour stability"

Industry fears stayaway show trial

By Carolyn Dempster, Labour Reporter

Apprehension is mounting in industry and union circles over a possible "show trial" of trade unionists detained after the recent two-day stayaway.

Several East Rand and Vaal Triangle companies have been approached by the police to disclose details of financial losses suffered as a result of the two-day stayaway earlier this month.

Other information which the companies have been asked to reveal includes the number of workers at the factory, the union to which they belong, the names of the shop stewards, and how many of the employees participated in the stayaway.

The Police Directorate of Public Relations in Pretoria told *The Star* that it could not comment on routine investigations

Concern in industry

Most of the company spokesmen approached said they would have preferred to have handled the stayaway issue as a labour matter without the interference of the authorities

Mr Bobby Godsell, industrial relations adviser to the Anglo American Corporation, confirmed that one of the corporation's subsidiaries had received "a casual request" from the police for information

He said he believed the request was part of an investigation by the police prior to charging detained union leaders under section 54 of the Internal Security Act

Spokesmen, who did not wish their companies to be identified, said they were worried about the implications of a show trial of detained union leaders under section 54

A spokesman for the 115 000-member Federation of South African Trade Unions (Fosatu) said the federation intended to take definite action in response to the events.

Fosatu's president, Mr Chris Dlamini, was one of the union leaders detained after the stayaway

Mr Piroshaw Camay, general secretary of the Council of Unions of South Africa (Cusa), which also supported the stayaway, was one of the other union leaders detained

A Cusa spokesman said the council was aware of the approaches being made by police.

"If companies assist by giving evidence, of whatever kind, it will nullify all of their discussions with the Minister of Law and Order," he said

Assocom: ^{Sent 11/12/84} ~~133~~ 133

talk to black trade unions

By Michael Chester

Big business today urged moves to ensure that all lines of communication stay open with black trade unions to allow a flow of grievances — “imagined and real, political and economic”.

But the Association of Chambers of Commerce (Assocom) warned that the attitude of “tolerance and understanding” shown by most employers in the recent wave of black unrest would be ended if there was a repeat of the mass stayaways

In a quarterly review released today, Assocom said: “One accepts without hesitation that there are grounds for restlessness among urban blacks. They are excluded from any meaningful participation in the new constitution and were not consulted about the form of representation they have been given

“A groundswell of unhappiness and dissatisfaction is engulfing the townships. There are limited channels for blacks to express their feelings and their views and the stayaway was in part, as it were, a voting with the feet, a silent protest.

“For this, one has un-

derstanding. But there can be no understanding for the senseless violence and the brutal hooliganism which swept through the townships

“Nothing can justify the burning of homes and facilities, the looting of shops, the killing and the destruction.

“This was mob rule, senseless and without motive — a development which antagonises instead of winning and understanding

“It is necessary, however, to distinguish between the youth-led violence and the stayaway which followed, although there is a link — that of intimidation and the fear of further violence if the call for a stayaway were ignored

“There is a case to be made for the steps which the authorities took to stem the hooliganism. There is no time for talk and debate when a mob runs amok. That is the time for action”

But it was imperative that lines of communication were kept open, at least in the economic field. “If a society is to progress”, says the review, “people should speak to each other, frankly and freely. They should not be silenced”

Bosses welcome detainees' release

Mercury Correspondent

JOHANNESBURG—The Association of Chambers of Commerce and the Afrikaanse Handelsinstuut have welcomed the release from detention of trade union leaders late last week.

Assocom represents

organised commerce countrywide, while the AHI represents Afrikaans-speaking businessmen and is close to the Government on political issues

Both bodies, together with the Federated Chamber of Industries,

originally criticised the detention of unionists in the wake of the recent Transvaal stay-away. This was the first time the AHI had joined with other employer bodies to criticise police action against labour leaders

However, after meet-

ings with the Minister of Law and Order, Mr Louis le Grange, the AHI endorsed the Government's action while Assocom called for detainees to be brought to court as soon as possible or released

Last week at least four unionists, including the president of the Federation of S A Trade Unions, Mr Chris Dlamini, and the general secretary of the Council of Unions of S A, Mr Phiroshaw Camay, were released.

Two others were charged with 'subversion' and released on bail.

The AHI's president, Mr Leon Bartel, said in a statement to Sapa in Pretoria that the release of the unionists would 'contribute greatly to stabilising international and domestic relations'.

'The AHI wants to compliment and thank the Government for the high-level initiative taken, under very difficult circumstances, with the release of certain trade union leaders,' Mr Bartel said.

Assocom's statement was issued by its president, Mr Michael Weir.

He urged that 'whenever possible, workplace disputes should be settled by negotiation and full and continuous consultation should be established between all concerned parties'.

11/12/84

Govt spending must be cut — Assocom

By Stan Kennedy

The Budget in March and the additional expenditure after its presentation will be major determinants of South Africa's fortunes in the year ahead, says Assocom in its quarterly review.

If Government spending remains high, tax will be high — and might even increase, unless the Minister of Finance, Mr Barend du Plessis, with the backing of the President, reins in ministerial demands for more spending money, the review says.

It says Mr du Plessis is committed to a policy of reducing government expenditure, which is the first priority if the economy is to be nursed back to health.

"It is current expenditure which must be cut — or at least reduced to a rate of increase below the growth of real GDP. Capital expenditure on infra-structural development should not be cut so that underlying facilities are available once the economy starts to move again into an expansionary phase.

Assocom says that if tax is kept within reasonable bounds, business will have the resources for self-financing expenditure and the private taxpayer might have the margin either to increase his savings or spend without excessive borrowing.

It warns that any increase in tax at this stage of the business cycle could be damaging.

It says "We hope that the Margo Commission will make some early examinations. Later on in the year when, hopefully, the balance of payments

on the current account has swung to its expected surplus, we would like to see demand picking up again.

"Higher taxes and, particularly, further increases in GST will inhibit the recovery of demand and will put a brake on future growth, so necessary if employment opportunities are to be created to match the frightening population explosion."

Much, however, depends on fiscal policy. If it is applied with real, and not just with intended, discipline then monetary policy can be relaxed with downward adjustments in the cost and availability of finance.

INFLATION SPIRAL

Assuming a reasonable surplus on the current account of the balance of payments, the foreign exchange value of the rand will not have to bear the brunt of the imbalance between monetary and fiscal policy.

A 50 US cents rand is a drag on the economy. And while it might be advantageous to exporters, the high cost of imports adds a sharp twist to the inflationary spiral to the detriment of the domestic economy.

There is only one policy which everyone in business must apply — that of survival.

Debtors must be kept on a tight rein and stock must be rigidly controlled. There should be consolidation not expansion because the cost of money could impair not only future but current profitability.

'Rescue package' is not enough

By Stan Kennedy

South Africa's structural problems are deep-seated and intractable says Professor D J J Botha, head of the Department of Economics, University of the Witwatersrand.

The problems include general skills shortage, low industrial productivity, high state expenditure on homeland development, industrial decentralisation, defence and the need to provide education and employment.

"Although government spokesmen profess to be aware of the nature and dimensions of these problems, this awareness

is not always reflected in official policies," he says in a supplement to the Barclays Bank *Economic Review*.

Untoward developments have taken pace on so many fronts

that no single, particular policy measure can be expected to put the economy back on to a more normal course. Worse still, it is not even clear what particular package will begin to do so.

The immediate problems, such as the low gold price, the drought, the strong US dollar and the drastic drop of the rand are largely of an extraneous nature and outside the control of the monetary authorities.

MONETARY MEASURES

Inflation has been almost entirely home-made, yet the authorities, over the years, have shown an inexplicable reluctance to take it seriously and introduce measures, not only to contain it but bring it to more acceptable levels.

The concatenation of circumstances had resulted in a crisis, which called for crisis mea-

asures, and the small package of monetary measures introduced in August could no way be described as crisis measures.

The Radcliffe Commission, he says, found the central bank should not restrict itself to considering trends in the money supply but, rather, the whole liquidity position, and that direct control of credit availability was more effectual than control of its price.

The Reserve Bank controlled consumer credit and raised the price of credit all round.

"The Bank should have resorted to a quantitative control of credit with its price unchanged. Such a control is not easy in the SA market, but the Bank should have devised an efficient system of quantitative credit control, which is long overdue as part of the official armoury to fight inflation," says Professor Botha.

Rm 11/12/84

133

Assocom cautions against stayaways

By PAUL BELL

ASSOCOM, while condemning the recent detentions of trade union leaders, surmises that further stayaways may cause employers to lose their tolerance.

In its fourth quarter review, Assocom said the recent township disturbances were of deep concern to business and it was accepted there were grounds for restlessness. "They were excluded from any meaningful participation in the new constitution and were not consulted about the form of representation they have been given. "They have no understanding of

the causes of the present deep recession; they only experience the results of the downturn, which have left many without jobs in an overcrowded labour market and with others working on short time.

"All the necessities of life are costing more — food, clothing, fuel and transport. Even the cost of accommodation.

"A groundswell of unhappiness and dissatisfaction is mounting in the townships and there are limited channels for expressing their feelings and their views.

"The stayaway was in part, as it were, a voting with the feet, a silent protest."

This was understandable, but the "senseless violence and brutal hoodliganism" was not and the Govern-

ment was justified in acting against the mobs

Assocom reiterated its concern over the detention of trade union leaders, saying freedom to associate was a fundamental democratic principle. During this recession, however, it was more important than ever to keep lines of communication open — to explain that the slump was neither the fault of business, nor simply that of Government.

"If this message could be got through to trade union leadership, sooner or later it would seep through to the rank and file movement."

It was accepted that industrial disputes often had little to do with actual working conditions, but were

influenced by wider — often nakedly political — considerations.

But business was hostage to a system which discouraged communication between races.

Businessmen often bore the brunt of black unrest because of the lack of other contact, but accepted this because they realised everybody would suffer if production and the flow of goods were not kept rolling.

"It is for this reason that most employers have shown a tolerance and an understanding that would not be present in a more open society in which there would be lines of communication through which grievances would flow.

"However, this is not likely to continue if further stayaways occur"

A GROUNDSWELL of unhappiness and dissatisfaction is mounting in the townships and there are limited channels for blacks to express their feelings and views, says Assocom.

Bosses welcome detainees' release

Mercury Correspondent

JOHANNESBURG—The Association of Chambers of Commerce and the Afrikaanse Handelsinstuut have welcomed the release from detention of trade union leaders late last week.

Assocom represents

organised commerce countrywide, while the AHI represents Afrikaans speaking businessmen and is close to the Government on political issues.

Both bodies, together with the Federated Chamber of Industries

originally criticised the detention of unionists in the wake of the recent Transvaal stay-away. This was the first time the AHI had joined with other employer bodies to criticise police action against labour leaders.

However after meet-

ings with the Minister of Law and Order, Mr Louis le Grange, the AHI endorsed the Government's action while Assocom called for detainees to be brought to court as soon as possible or released.

Last week at least four unionists, including the president of the Federation of S A Trade Unions, Mr Chris Dlamini, and the general secretary of the Council of Unions of S A, Mr Phiroshaw Camay, were released.

Two others were charged with 'subversion' and released on bail.

The AHI's president, Mr Leon Bartel, said in a statement to Sapa in Pretoria that the release of the unionists would 'contribute greatly to stabilising international and domestic relations'.

'The AHI wants to compliment and thank the Government for the high-level initiative taken, under very difficult circumstances, with the release of certain trade union leaders,' Mr Bartel said.

Assocom's statement was issued by its president, Mr Michael Weir.

He urged that 'whenever possible', workplace disputes 'should be settled by negotiation and full and continuous consultation should be established between all concerned parties'.

Sawyer 18/12/84

NUM at odds with Chamber

By JOSHUA
RABOROKO

THE CONTROVERSY concerning the safety working and living conditions of South African black mineworkers gained momentum yesterday when the Chamber of Mines and the National Union of Mineworkers gave conflicting views of the situation.

The Chamber of Mines contends that the South African mining industry is one of the most open industries in the world, while NUM maintains that the conditions are appalling and could not be tolerated anywhere in the world.

The controversy started when a member of the British National Union of Mineworkers, Mr Roy Jones, who visited the country recently, said that living conditions in some of the South African mines were reminiscent of Nazi concentration camps in Germany.

Mr Jones, who was a guest of the local NUM, also said the high mortality rate in SA mines was caused by poor safety precautions.

He said if the same conditions prevailed in Britain, then the mines would be closed, adding that local conditions were the worst in the world.

Riots

NUM's assistant general secretary, Mr Mokheseng Maloka, has come out in full support of Mr Jones' claims, and said that most of the riots at the mines were caused because mine bosses divide workers according to their ethnic groups.

Accommodation, safety and harsh recruiting methods were highlighted by Mr Maloka as the issues which cause concern among black mine workers in the country.

However, the Chamber has refuted Mr Jones' disclosures and said "anyone who has ever visited gold mines will recognise how grossly untrue — to put it mildly — the claims are."

McGarry 7/1/85

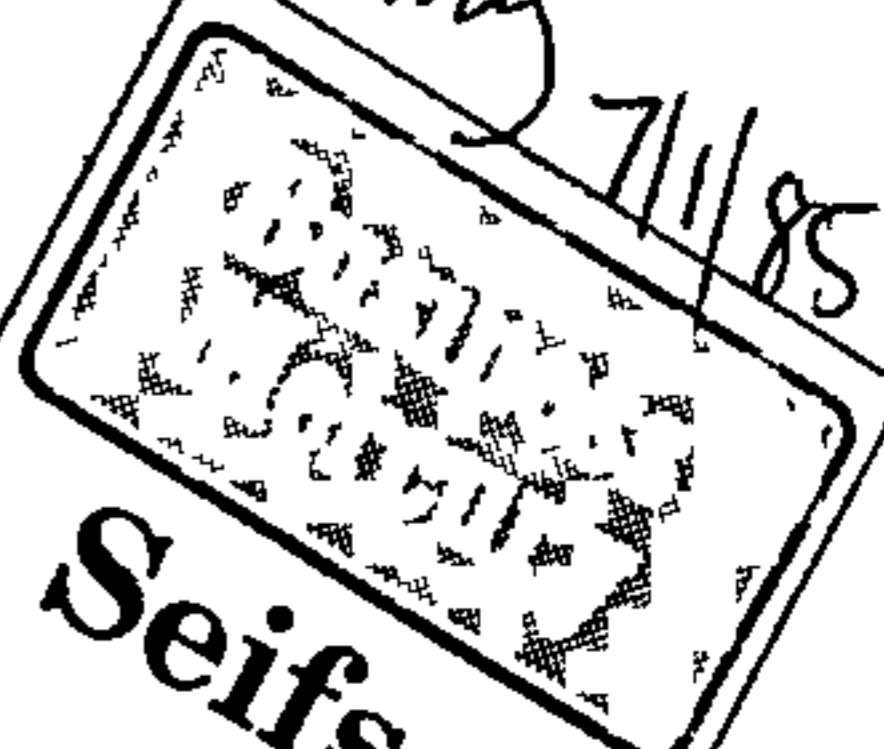

Seifsa sees gloomy 1985

133

JOHANNESBURG—South Africa's steel and engineering industries have been hit hard by the recession and do not expect any 'meaningful turnaround' in their fortunes until early 1986.

A report issued at the weekend by the economics division of the Steel and Engineering Industries Federation of S A (Seifsa) presents a depressing review for 1984 and a gloomy outlook for 1985.

'At best, 1985 is seen as a period of consolidation with some expectation that the low value of the rand will offer opportunity for import replacement and some stimulus to Seifsa's export sectors,' the report says.

Prices

'Present indications are that recessionary conditions continue firmly entrenched in Seifsa's manufacturing sectors.

'Concern continues to be expressed, particularly by the machinery sector, at the inability of a number of production-efficient industries to compete successfully on a price basis with relatively low-priced imports in the domestic market and, internationally, in the markets of South Africa's trading partners.

'Competitiveness is also expected to weaken further during 1985, aggravated by relatively high input costs.'

But the report points out that despite the severely depressed levels of activity during 1984 the Seifsa group of industries continued to contribute significantly to the economy — (Sapa)

Forewarning on disinvestment

133
2. Post 8/11/75

JOHANNESBURG — The disinvestment debate has caught up with Senator Edward Kennedy as he prepared for his first major address to about 400 local businessmen today.

Six major employer organisations, all of which will be strongly represented at today's meeting, last night issued a memorandum rejecting disinvestment, economic boycotts and other restrictive measures as being counter-productive.

The Association of Chambers of Commerce, Afrikaanse Handelsinstituut, Chamber of Mines, SA Federated

Chamber of Industries, the National African Federation of Chambers of Commerce and the Steel and Engineering Industries Federation, who jointly represent 80% of the country's employment muscle, said negative economic action against South Africa would obstruct the country's growth, which was a "powerful catalyst in the process of peaceful, social and political reform".

In their memorandum they said they had been successful in urging the Government to make meaningful political changes especially in the field of labour relations,

private ownership in black housing, easing restrictions on small and informal black businessmen and restructuring education and training to match industrial needs.

The private sector had effectively used its own resources to improve living conditions and social amenities for coloured, Indian and black employees outside the workplace.

"While much remains to be done, this record of corporate responsibility stands for itself," the memorandum says.

Yesterday Senator Kennedy raised the issue of dis-

investment with the Minister of Foreign Affairs, Mr Pik Botha, who said after their hour-long meeting the Senator had not directly expressed support for it, but had explained why it was popular on Capitol Hill in Washington.

The Senator is the guest of the SA Council of Churches and particularly its outgoing secretary-general, the Anglican Bishop designate of Johannesburg, Bishop Desmond Tutu, who has himself been caught up in a debate on disinvestment.

On the first day of his eight-day Southern African tour, Senator Kennedy

went on a hand-shaking tour of several Soweto streets and entered three private homes where he questioned the families closely on their employment situation.

It is almost certain that Senator Kennedy will speak about disinvestment in his keynote address today, but observers do not expect him to take any specific stand on the issue while in South Africa.

This afternoon's address will be Senator Kennedy's last major engagement in Johannesburg before he returns at the weekend for a farewell address at Soweto's Regina Mundi Cathedral on Sunday — Sapa.

Call for

Weather

Mercury 29/1/85 (133)

Probe launched into building labour training

Labour Reporter

THE Building Industries Federation of South Africa (Bifsa) has launched an intensive investigation into the labour structure of the building industry

Mr Lou Davis, executive director of Bifsa, told the Mercury yesterday that since the introduction of the Apprenticeship Act of 1922, there had been no drastic adjustments or fundamental changes to the system of training artisans

'Several factors, including new technology, methods of manufacture

and materials, have demanded that we, as an industry, adopt new methods of artisanship and training of artisans

'But it is also of vital importance that we take a critical, objective look at the total labour structure of the building industry as represented by the existing designation of all trades,' he said, adding that it would be pointless to revise methods of training while leaving the total structure of skilled labour activities unchanged

The Bifsa probe follows an investigation by the National Training

Board through the Human Sciences Research Council into methods of training artisans in the building industry

The board's investigation, conducted under the chairmanship of Mr Alan Pittendrigh, was completed last year, but the findings are expected to be published later this year

Appealing to all members of the building industry to help, Mr Davis said the in-depth investigation would identify and evaluate all skills required to meet present and future needs of the industry

When business leaders speak up

133 (133) 12/85

By Inga Molzen

South Africa's most striking recent phenomenon has been the way business leaders have publicly committed themselves by talking out on political issues beyond the factory floor, said Institute of Race Relations director Mr John Kane-Berman last night.

He added that this had been a particular trend of the last six years where industry and commerce, represented by the Afrikaanse Handelsinstituut, the Federated Chamber of Industries, the Association of Chambers of Commerce and similar organisations, had expressed disapproval and concern on

- Influx control, which was neither practical nor morally justified
- Forced removals
- Opening Central Business Districts to all races
- Lifting the ban on all banned organisations and political prisoners
- Releasing all political prisoners
- Detaining political leaders after the stayaway in November last year

There had been an admission of what Mr Kane-Berman called a crisis of confidence in the Government, expressed by the Afrikaanse Handelsinstituut, not previously considered a particularly loud critic of the Government.

Mr R Ironside, past president of the South African Federated Chamber of Industries and chairman of the Automobile Manufacturers Employers Association, said the Government should not take offence that they were being criticised.

After all, he added, organised commerce and industry, the paymasters of the system, should have a say in the management of it.

Mr R Godsell, head of the Industrial Relations Department of Anglo-American, said businesses were being called in to reform structures of political power.

He added "Economic growth is not possible without reform and vice versa, and businesses define the agenda for reform."

"Businesses have started to talk to government and to trade unions but not as consistently and frequently as will be needed."

APPE Times 2/12/85 (133)

Motor trade chief takes govt to task

Own Correspondent

PORT ELIZABETH — The government must do away with the Mixed Marriage Act, the Immorality Act, the Group Areas Act and detention without trial to lay the spectre of disinvestment to rest

This was the message delivered here last night by Mr Lou Wilking, managing director of General Motors, in an address to the Institute of Cost and Management Accountants

Warning about the growing movement calling for disinvestment in South Africa, he said business was being urged to tell the world about changes in the country, and was doing so

"But when is the government going to assist the telling of the story by doing away with the Mixed Marriage Act, the Immorality Act, the Group Areas Act and detention without trial?"

"If this can take place, the disinvestment issue can be laid to rest and I will hazard an educated guess that the economy will begin to come right"

General Motors did not support disinvestment legislation affecting firms in South Africa because this would penalize companies which were contributing to the achievement of social justice and racial reform

He said an emotional tone typified arguments in favour of disinvestment which were based on abstract moral values that failed to take into account the harm disinvestment would bring to black people who would be the first to lose their jobs

Mr Wilking asked those present what their assessment as businessmen would be of a country which had

- Double-digit inflation for over a decade
- Interest rates rising from 7 percent to 25 percent in four years
- Its currency devalued by more than 60 percent in a little over two years
- A government employing nearly 62 percent of all whites and increasing their salaries by 30 percent in the year of a major recession
- Raised general sales tax from 6 percent to 10 percent in less than six months and looked set to raise it by a further two to five percentage points in March

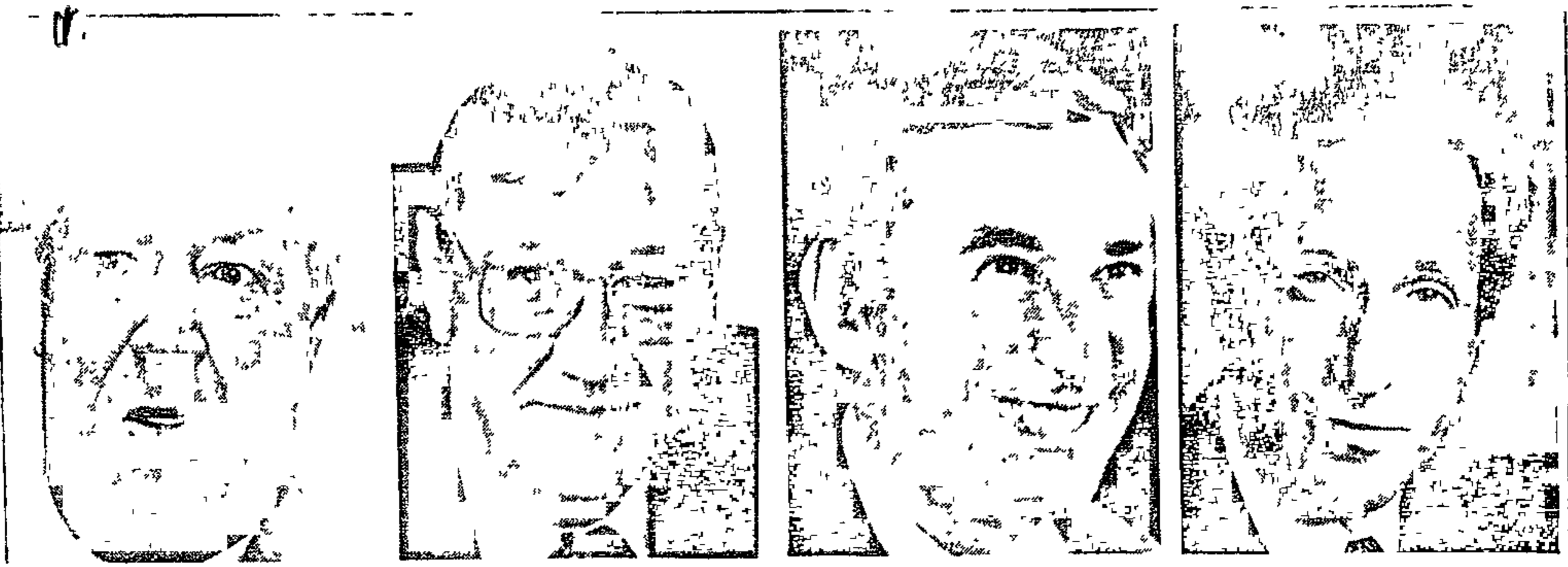

Mr Edward Heath

Mr Jan Steyn

Mr Basil Hersov

Mr Tony Bloom

Revised Sullivan Code may buy valuable time for SA

CAPE TOWN 8/3/85

state legislatures
133

JOHN BATTERSBY reports from LONDON

A CONFERENCE held in the Leeds Castle in Kent this week might have been the last chance for the South African business community to defuse the growing disinvestment campaign

The conference — described by the organizers as "private" — was remarkable in several respects

For the first time it brought together the Reverend Leon Sullivan, leading South African businessmen, United States company executives and executives of leading British companies who have firmly rejected disinvestment as a means of accelerating reform in South Africa

Mr Sullivan wrote the code of conduct for US firms operating in South Africa



Leeds Castle in Kent — venue for SA's last chance

Revised principles

Acting as chairman and organizer of the conference was Mr Edward Heath, a former British prime minister. He gave a tough warning when he visited South Africa in 1981 that failure to grant blacks political rights would lead to revolution

The conference, set up by Mr Sullivan with General Motors' backing and with Mr Heath's assistance, was a follow-up to an earlier meeting with British executives in 1983. At that meeting Mr Sullivan sought British support for his revised Sullivan principles

The revised code requires signatories to apply direct pressure on the government to dismantle apartheid

It is believed that British companies are less than enthusiastic about the new Sullivan proposals in their present form because they would amount to direct interference in South Africa's domestic affairs

Strong reservations

coming involved in what amounts to direct interference in South Africa's domestic affairs

Political intervention through multinationals operating in South Africa also raises for many US businessmen a series of moral questions about their operations in other countries with poor human rights records, particularly communist countries

However, given the tide of disinvestment sentiment in the US, they realize that the choice is no longer between backing the Sullivan principles or rejecting them, but between continuing their South African operations under the protection of the Sullivan umbrella or not operating in SA at all

In this way some firms not prepared to follow Mr Sullivan into the political arena might reluctantly sell to local interests, as Ford decided to do when they sold a 60 percent stake in a merger with Anglo-American in January

Ford was recognized as the most progressive and highest-paying foreign employer of

results of this week's meeting are known, but the meeting could be a turning point in the disinvestment campaign

The Urban Foundation's Mr Steyn will be able to chronicle an impressive list of achievements since it began its work nine years ago, particularly in paving the way for leasehold and freehold rights for blacks

But he will counter any moves by US business to dictate the pace of reform in South Africa

The South African business contingent has been asked to co-operate in a Sullivan monitoring committee which would include business leaders, trade unionists, church representatives under the chairmanship of Mr Herman Nickel, American ambassador to South Africa and an outspoken advocate of constructive engagement

This does not rule out the possibility of a deal whereby South African business would agree to such a role in return for a toning down of the proposals

In short, the Sullivan strategy presents possibly the last

New York city has already begun withdrawing R1,2 billion in pension money from South African-linked companies and Citibank has agreed to liquidate its loans to South Africa by the end of this month

More than 20 other US cities are moving in the same direction and about 40 colleges and many churches in the US have decided on various forms of disengagement from South Africa

A "consensus Bill" in the US to agree on a joint Democrat-Republican approach to disinvestment is only being delayed because of South African reservations about the inconsistency of continued investment in various communist countries

However, even the most committed proponents of disinvestment concede privately that even total US disinvestment in South Africa — if it could be achieved (which is doubtful) — would have, at best, a limited effect on accelerating the pace of internal reform

But both opponents and advocates of disinvestment fear that the current crusade in the US has already assumed its own momentum and could result in disinvestment measures being adopted regardless of the wishes of those who initiated the campaign

Peaceful option

US opponents of outright disinvestment fear that it could be counter-productive and even diminish the prospect of evolutionary change by hitting the blacks hardest and driving whites back into the laager

But, at the same time, there is a growing realization in the US and the West generally that the use of economic pressure is the only peaceful option for countries which stridently condemn apartheid but continue to trade with South Africa

Leeds Castle in Kent this week might have been the last chance for the South African business community to defuse the growing disinvestment campaign

The conference — described by the organizers as "private" — was remarkable in several respects

For the first time it brought together the Reverend Leon Sullivan, leading South African businessmen, United States company executives and executives of leading British companies who have firmly rejected disinvestment as a means of accelerating reform in South Africa

Mr Sullivan wrote the code of conduct for US firms operating in South Africa

Revised principles

Acting as chairman and organizer of the conference was Mr Edward Heath, a former British prime minister. He gave a tough warning when he visited South Africa in 1981 that failure to grant blacks political rights would lead to revolution.

The conference, set up by Mr Sullivan with General Motors' backing and with Mr Heath's assistance, was a follow-up to an earlier meeting with British executives in 1983. At that meeting Mr Sullivan sought British support for his revised Sullivan principles.

The revised code requires signatories to apply direct pressure on the government to dismantle apartheid.

It is believed that British companies are less than enthusiastic about the new Sullivan proposals in their present form because they would amount to direct interference in South Africa's domestic affairs.

Strong reservations

Most British companies with operations in South Africa subscribe to the voluntary and milder EEC Code of Conduct.

South African representatives at the Leeds Castle meeting, including Urban Foundation director, Mr Jan Steyn, have strong reservations about the revised Sullivan proposals.

But the possibility of a deal whereby the proposals would be toned down in return for an input and monitoring role for the South African business community has not been ruled out by sources close to the meeting.

Signatories would be required to campaign actively on issues such as influx control, forced removals, family housing for black workers and an official "hands-off" approach to black trade unions.

They would also be required to urge other companies in South Africa to follow the principles.

While 119 of the 126 US Sullivan signatories have already given provisional backing to the proposals, many are uneasy about the implications of be-



Leeds Castle in Kent — venue for SA's last chance

coming involved in what amounts to direct interference in South Africa's domestic affairs.

Political intervention through multinationals operating in South Africa also raises for many US businessmen a series of moral questions about their operations in other countries with poor human rights records, particularly communist countries.

However, given the tide of disinvestment sentiment in the US, they realize that the choice is no longer between backing the Sullivan principles or rejecting them, but between continuing their South African operations under the protection of the Sullivan umbrella or not operating in SA at all.

In this way some firms not prepared to follow Mr Sullivan into the political arena might reluctantly sell to local interests, as Ford decided to do when they sold a 60 percent stake in a merger with Anglo-American in January.

Ford was recognized as the most progressive and highest-paying foreign employer of black labour in South Africa.

Mr Sullivan's efforts to broaden the base of his principles to include British companies operating in South Africa — and his attempt to seek the quiet co-operation of South African business — is the most far-reaching development on the disinvestment scene in recent months.

The move also shows a concern by Mr Sullivan and his General Motors backers that American business should not be the only ones to bear the economic consequences of disinvestment.

If successful, the Sullivan strategy, which amounts to a manifesto for continued foreign investment in South Africa, would undermine the growing campaign for disinvestment. It would buy time for evolutionary change in South Africa.

It would also fit in with Bishop Desmond Tutu's two-year deadline for advocating economic sanctions if apartheid has not been dismantled by then.

It will take time before the

results of this week's meeting are known, but the meeting could be a turning point in the disinvestment campaign.

The Urban Foundation's Mr Steyn will be able to chronicle an impressive list of achievements since it began its work nine years ago, particularly in paving the way for leasehold and freehold rights for blacks.

But he will counter any moves by US business to dictate the pace of reform in South Africa.

The South African business contingent has been asked to co-operate in a Sullivan monitoring committee which would include business leaders, trade unionists, church representatives under the chairmanship of Mr Herman Nickel, American ambassador to South Africa and an outspoken advocate of constructive engagement.

This does not rule out the possibility of a deal whereby South African business would agree to such a role in return for a toning down of the proposals.

In short, the Sullivan strategy presents possibly the last chance for the Reagan administration to rescue its policy of constructive engagement with Pretoria, although in a modified form.

It might also present the last chance for the South African business community, which has embarked on a campaign to promote reforms, to play a role in undermining the US campaign for disinvestment.

By their presence at the conference, South African businessmen like the chairman of Premier Milling, Mr Tony Bloom, and the chairman of Anglo Vaal, Mr Basil Hersov, could make a major contribution to staving off disinvestment in some form.

The South Africa debate in the US, which has taken on the proportions of a national moral crusade, is no longer whether US companies should disinvest in South Africa, but what form that disinvestment should take.

Already five states in the US have enacted laws preventing the investment of public funds in South African-linked companies and disinvestment measures are pending in 27 other

New York City has already begun withdrawing \$1.2 billion in pension money from South African-linked companies and Citibank has agreed to liquidate its loans to South Africa by the end of this month.

More than 20 other US cities are moving in the same direction and about 40 colleges and many churches in the US have decided on various forms of disengagement from South Africa.

A "consensus Bill" in the US to agree on a joint Democrat-Republican approach to disinvestment is only being delayed because of South African reservations about the inconsistency of continued investment in various communist countries.

However, even the most committed proponents of disinvestment concede privately that even total US disinvestment in South Africa — if it could be achieved (which is doubtful) — would have, at best, a limited effect on accelerating the pace of internal reform.

But both opponents and advocates of disinvestment fear that the current crusade in the US has already assumed its own momentum and could result in disinvestment measures being adopted regardless of the wishes of those who initiated the campaign.

Peaceful option

US opponents of outright disinvestment fear that it could be counter-productive and even diminish the prospect of evolutionary change by hitting the blacks hardest and driving whites back into the laager.

But, at the same time, there is a growing realization in the US and the West generally that the use of economic pressure is the only peaceful option for countries which stridently condemn apartheid but continue to trade with South Africa.

For anti-apartheid activists who reject violence as an option, economic sanctions — or some form of economic pressure — is the only avenue left.

It is this realization which the British government — weary of constant domestic and international pressure over its collaboration with Pretoria — is having to come to terms with.

Sanctions ineffective

On the one hand Britain welcomes the award of the 1984 Nobel peace prize to Bishop Tutu and fully endorses his campaign of peaceful opposition to apartheid.

But in the same breath it rejects economic sanctions or disinvestment as an ineffective and counter-productive strategy for internal change.

British executives realize that they will not be able to rely on British Foreign Office protection indefinitely.

Leeds Castle could prove a watershed for the South African business community.

Row 11/3/85 (133)

Bifsa: Probe by board welcome

BIFSA executive director, Mr Lou Davis, has welcomed a Competitions Board inquiry into tendering restrictions, embargoes and alleged restrictive practices by the federation

In a statement issued in Johannesburg at the weekend, Mr Davis said he believed the allegations levelled against Bifsa would not stand up to the "spotlight of independent inquiry".

"It is patently clear, too, that the need for equitable and fair tendering conditions are of vital concern to builders in this industry and, without such conditions, the industry would face a morass of confusion when bids were opened"

It was essential for developers and builders to start any contract on a basis of mutual understanding.

"These conditions do increase that understanding and cut through the mass of potential red-tape and legalese."

Mr Davis discounted allegations that Bifsa was imposing unfair restrictions on its members

Equitable tendering conditions formed a vital basis for members and the conditions acted as a bench-mark on which to compare prices. — Sapa

Assocom urges action

By ANDREW DUNCAN

BUSINESSMEN must take immediate action to counter the threat of disinvestment, says the Association of Chambers of Commerce.

Assocom added in its latest quarterly review that everyone in business should act before irrevocable machinery was set in motion in the US.

People should urge their American contacts to lobby congressmen and senators to vote against any form of US disinvestment

The publication said anti-SA sentiment had reached far beyond arms embargoes and original concepts of the Sullivan Code. Bankers were being forced to reconsider and, perhaps stop, loans to this country (Citibank has already stated that it will not grant new loans after March)

American trust and investment companies were being urged to shed holdings in US companies with trading links in this country

The next step, said Assocom, would be to apply as much pressure as legally possible to force companies with interests in this country to sever all ties

Assocom said businessmen dared not be indifferent to what was happening in the US nor should they regard pickets in Washington and legislative moves as being the actions of a crankish minority.

They were all sections of a lobby gaining strength and which could do tremendous damage to this country.

Assocom said the country's economic potential and political stability could not be ensured without a stable, secure and prosperous workforce

Employer organisations had had some success in urging the SA Government to make policy changes in widening labour relations and in opening up equal opportunities for all, in advancing black home-ownership rights, educating and training people of all races, and in encouraging black entrepreneurship, especially in the informal sector

It said employer organisations were still working towards further reforms in the structure of society.

These included more political participation for blacks, full participation in a private enterprise economy, full SA citizenship and a free and independent trade union movement

Assocom said that time was, however, running out fast. Events were moving against SA and once decisions to disinvest or apply sanctions had been made they would be almost impossible to reverse

The political juggernaut in this country often moved at a frighteningly slow pace, said Assocom, and action would have to come from the private sector

SA big six demand sweeping reform

133
14/3/85
The private business sector today increased pressure on the Government to accelerate sweeping reforms to remove apartheid and defuse the overseas disinvestment campaign.

In a significant show of unity, all six of the main business organisations, whose member firms provide 80 percent of the entire national labour force, have linked forces to ensure full clout to the demands.

The signatories to a joint statement pledged support to initiatives to speed up "an ongoing process of economic and political reform".

The signatories are Association of Chambers of Commerce; SA Federated Chamber of Industries; Afrikaanse Handelsinstituut; Chamber of Mines; Steel and Engineering Industries Federation; and National African Federation of Chambers of Commerce.

PROGRESS

The announcement of their stand follows warnings issued to the Government yesterday by the South African Foundation that impatience and anger was growing inside big business over the slow pace of reforms.

A joint statement said: "Realism dictates that economic and political reforms must be pursued on their own merits.

"Nevertheless the organisations are keenly aware of the positive impact which visible progress along this road is likely to have on overseas opinion, and especially on the current disinvestment debate in the United States"

Initiatives taken so far have had the full support of the American Chamber of Commerce in South Africa.

The six organisations listed five main targets:

- Full participation by all South Africans in a private enterprise economy and in the political dispensation of the country
- A common loyalty to the country as expressed through citizenship for all.
- Ending forced removals.
- Safeguards for the administration of justice by the courts.
- Further development of a free and independent trade union movement.

Business warned on disinvestment

133
SIVAP
60

MAGUS 15/3/85

Staff Reporter

BUSINESSMEN were told today that unless they did something about issues such as detention without trial, forced removals and discrimination, South Africa would be doomed under disinvestment pressure.

Professor James Leatt, professor of business administration at the UCT Graduate School of Business, said if the problems of civil and political rights in South Africa were not solved the country's economic structure would fail.

He was addressing a Cape Town Chamber of Commerce seminar on corporate social responsibility, which he described as "voluntary expenditure of resources to do something not

required by law and without immediate economic benefits". He said the survival of the country depended on this.

Mr Raymond Ackerman, chairman of Pick 'n Pay, told the meeting businessmen had to stand up to government and lobby for reform. He said businessmen could also play an important role by promoting South Africa overseas.

"A group of overseas bankers visited South Africa and were given a whitewash by the Government and the bad news by the Progs and they were switched off South Africa.

"Nobody told them that businessmen had negotiated the changes in the housing system which led to 99-year leases. When overseas people hear this they acknowledge we are worth fighting for."

A policy of corporate social responsibility could lead to economic growth

"Don't avoid competition, don't maximise profits and don't fix prices. Break cartels and boards which export food at a loss and fight government to keep subsidies on basic foodstuffs," Mr Ackerman said.

"You can play a role in your community. No businessman can afford to ignore how much the consumer can help his business. This is just as important as buying and marketing."

Sowetan 28/3/85

Bosses demand reform

By JOSHUA RABOROKO

SIX major employer groups have urged the South African Government to make meaningful policy changes, especially widening labour relations, relaxing restrictions on small businesses, revising education and opening home ownership to blacks.

The organisations believe that without a stable, secure and prosperous workforce the country's economic potential and political stability cannot be ensured in future.

In its latest newsletter the Chamber of Mines says the private sector is using its own resources to integrate facilities and to remove discrimination in the work place.

The groups — Die Afrikaanse Handelsinstituut, the Association of Chambers of Commerce, the Chamber of Mines of SA, The SA Federated Chamber of Industries, National African Federated Chamber of Commerce and the Steel Engineering Industries Federation — represents more than 80 per cent of the employment strength of the country

The organisations are strongly committed to furthering an on-going process of economic and political reform in the country

"The business community is in the frontline in developing and maintaining harmonious relations between black and white, especially on the shop floor

Goals

They believe in the following goals

- Meaningful political participation by blacks
- Full participation in private enterprise economy for all South Africans regardless of race, colour, sex or creed
- Common loyalty to the country in all South Africans through a universal citizenship.
- The development of a free and independent trade union movement
- The administration of justice as safeguarded by the courts.
- An end to the forced removal of people

These goals, the chamber says, will only be attained in the context of strong economic growth. The employers are therefore opposed to a ban on US investment in South Africa, trade restrictions affecting US and South African products, prohibition of bank loans for South Africa and procurement boycotts against corporations doing business in South Africa

Sowetan 10/4/85

Black and white workers unite in wage talks

(133)

COLOUR will take the back seat when black and white trade unions representing over 320 000 metal workers present a united front in demanding pay rises and better working conditions at the industrial council meeting which resumes in Johannesburg today.

The united front, the International Metal Workers Federation (IMF) which represents black and white trade unions had presented a proposal for wage increases which deadlocked last week.

The IMF has declared a dispute with 45 employers who belong to the Steel Engineering Industries Federation of SA (Seifsa). The dispute means that over 320 000 workers will be affected when it is not resolved.

The wage talks between employers and unions takes place amid a strike by over 400 workers at Siemens Cable Company, Pretoria — which is part of the Industrial Council — over wages and the company's refusal to allow Mawu members to travel to the hearing in Johannesburg.

A company spokesman said that the workers have been dismissed. "We cannot allow workers to stop work at any time, just because we are a multinational company," Siemens' director, Mr J Krostkie, said yesterday.

The employers have called for a wage freeze in an attempt to preserve jobs. They argue that in the past three years more than 80 000 workers have been laid off in this sector. If they are forced to meet the unions' demands they will be forced to retrench more workers.

The steel and engineering sector is one of the hardest hit by the present economic recession.

The unions are demanding a minimum wage of R3,50 an hour which would mean doubling the remuneration received by less skilled workers. Artisans want their minimum to be raised by 36 percent to R6,53 an hour.

Other demands include request that employers increase workers' contribution to the pension fund to 12 percent and that this money be invested in family housing.

Because of retrenchments, the unions have demanded that the severance benefits be increased to one month's pay for every year of service.

Also party to the negotiations, but acting independently of the other bodies, is the right-wing Confederation of Metal and Building Unions (CMBU) made up of about 10 unions. It is demanding increases of between 10 and 45 percent.

Sowetan 12/6/85

Seifsa 'aims to uplift blacks'

THE Steel Engineering Industries Federation of SA (Seifsa) was committed to raising the standard of living of lower paid employees in the metal and engineering industry, especially blacks.

In his presidential address, Seifa's Mr J W Nelson says that he believed that this could be achieved over a "reasonable period of time within the parameters of prevailing economic circumstances and through increased effectiveness in industry."

He said the years 1975 and 1983 — a period encompassing two economic downturns and one upturn — the starting wage for an unskilled employee in the industry increased by 29 percent after allowing for inflation.

Dispute

Seifsa, an employer organisation, has released its 1984 annual report at a time when several emerging unions have declared a dispute over wages, at the industrial council.

In the report, Mr Nelson says that employers face a "serious dilemma" in that wage increases would lead to further reduction in employment levels at a time when unemployment was already high.

Disinvestment war:

Ackerman calls for SA 'Sullivan code'

CAPE TOWN 13/4/85 (133)

opposed to the United States Sullivan code, Mr Ackerman says the depth of monitoring and progress made has been impressive

"I used to criticize the US companies but have recognized that the Sullivan companies have actually forced us all into many of the changes made over the last 8 to 10 years. We can actually thank the US groups."

The adoption of a local code would show overseas critics what was being achieved by South African businessmen

"Our business sector needs to be rated in the same way

"The United States signatories to the Sullivan code are doing an excellent job of constructive engagement

"We South Africans are following in their wake and performing well but are not being measured"

Mr Ackerman disclosed that he has been engaged in a series of top-level meetings with South

African black leaders explaining what was being done by business to oppose discrimination

"We have found black leaders quite unaware of the progress being made

"But the significant result is that dialogue is underway"

Black leaders have been asked to propose a programme which could be adopted by the private sector

'Simplistic'

"Important as we think areas such as non-discrimination, housing and job opportunities are black leaders are asking what we are doing in lobbying government on citizenship, influx control and forced removals. They have viewed business as being very much in the same camp as government and not talking to Government on these issues

Mr Ackerman said the meetings with black leaders — which are continuing — had given him hope

"There is a real chance of black and white living together — we don't just require this very simplistic one-man-one-vote

"Obviously group areas, forced removals and influx controls are important but without doubt the key area is citizenship

"A way has to be found for everyone to be a citizen of this country without creating fear among whites of one-man-one-vote"

Mr Ackerman called for three-cornered negotiations between Government, business and black leaders

"Government must involve business more not as partners but as part of a negotiating triangle"

Rand's drop

"To my mind the disinvestment problem is more serious than people like to make out

"It is not merely the US banks saying we are not going to invest in South Africa and the concomitant prob-

lems of job creation

"It is a very wide problem linked to the rand/dollar rate and the recession

"There is no question that disinvestment has been helped by the rand's sharp drop

"The profitability of many of the American companies here has been affected and their assets have fallen in value"

With profits falling, US companies have clearly found difficulty in opposing disinvestment

"We are looking at a so-called moral issue and a hard business issue

Take stand

"A number of people have told me that if business was good in South Africa there would be little question of disinvestment"

Mr Ackerman who believes businessmen and not politicians will blunt the disinvestment campaign, says businessmen must accept the challenge

"We have to show

ourselves and our people that business is leading the way. We have to clearly stand up in areas such as citizen rights and forced removals

"Business must lobby overseas groups here and abroad and get the message across"

Apart from the high level talks Mr Ackerman is active on several fronts

Steps being taken to counter the disinvestment drive include media briefings in Europe and the United States

Fleet Street

In June Mr Ackerman will be briefing Fleet Street journalists on why investment should continue and will be addressing a London conference

He is also negotiating for a UK Nightline-type television series on what South African businessmen are doing

In addition press supplements are planned in both the London Financial Times and leading New York newspapers

Pick 'n Pay and six other companies are sponsoring a film on the business role in black advancement which will be screened on US television

A book dealing with the "real facts of the disinvestment issue" which will be distributed abroad is also being sponsored

The role of business in society

Staff Reporter

THE social responsibility of business is the theme of a top-level conference organised by the Public Relations Institute of South Africa for Cape Town next month

The president of Prisa, Mr Bob Krause, said yesterday that it was becoming imperative that business considered ways of involving itself more fully with raising the quality of life in society

"This follows the realisation that successful corporate performance relies heavily on the well-being of the community of which business is an integral part, on whose goodwill it depends and from which it draws its basic requirements," he added

"This conference aims to provide company managements with planning guidelines to ensure that involvement results in optimal spin-off

for both company and community"

Keynote speaker at the conference, which is intended for business leaders involved in formulating policy and developing strategy, will be US Ambassador Mr Herman Nickel.

The two-day conference will focus on emerging issues in South Africa and the mechanics of involvement

Speakers on the first day include Dr Sam Motsuenyane, president of the National African Federated Chambers of Commerce, Professor J P de Lange, rector of Rand Afrikaans University, and Mr Tony van Ryneveld of the Urban Foundation

On the second day Mr John Wilson of Shell South Africa will address the implications of social responsibility for a company and Mr Arnold Zulman of Beacon Sweets will show how to involve employees in the social responsibility exercise

Crucial talks at SABS' meeting

Soweta
18/4/85

133

~~133~~

THE South African Boilermakers Society is to discuss various crucial issues, including retrenchments, disinvestment, multiracialism and restrictive labour laws, at its triennial council meeting next Monday.

The union's public relations officer, Mr Tjaart Coetzee, said that the areas where urgent Government action is needed according to the society include:

- The scrapping of the last vestiges of job reservation by implementing the white paper on Part 6 of the Wiehahn Commission report;
- A national and realistic policy of urbanisation which will ensure the growth of a settled labour force and the mobility of workers who would be able to sell their labour on the best market, and
- The need to review strike laws so that the right to strike legally without fear of dismissal can be entrenched in labour law.

The society has also expressed its opposition to forced removals and resettlement of workers at inconvenient distances from their place of employment.

Mr Tjaart also said that there were several items scheduled for discussion which reflect the deep concern of most labour organisations about retrenchment in these times of high inflation and recession.

The general council will also debate a resolution which rejects all forms of disinvestment on the grounds that it will cause economic stagnation, loss of jobs and political chaos which it believes, would be irreversible.

The society also notes that overseas workers extend their contracts over three years but that locally-recruited contract workers are restricted to one-year terms and are subject to immediate termination of their contracts.

Other matters will include a discussion on black education, participation in public affairs and housing needs.

The society draws its members from gold, diamond and coal mining sectors and is multiracial in character. It has a membership of skilled, blue-collar workers made up of 35 percent whites, and the rest are coloured people, blacks and Indians. It disaffiliated from the Trade Union Council of SA (Tucsa) and is a member of the South African Co-ordinating International Metal Workers' Federation.

133

Chambers of Commerce urge meeting on unrest

PORT ELIZABETH — The Port Elizabeth, Grahamstown and Uitenhage Chambers of Commerce have requested an urgent meeting with the Minister of Co-operation and Development, Dr Gerrit Viljoen, and the Minister of Law and Order, Mr Louis le Grange, to discuss civil unrest in the region.

The three chambers have also sent a memorandum to the government, in which they outlined their views on the unrest and made recommendations on how the situation could be defused, said Mr Frank Wightman, president of the Port Elizabeth Chamber of Commerce

The prolonged unrest in Uitenhage's black townships has had a devastating effect on the town's economy, said Mr

Graham Hamilton, president of the Uitenhage Chamber of Commerce

Mr Wightman yesterday listed some of the reasons that the chambers saw as the core causes of unrest in the area — and that were also listed in the memorandum

- Inferior education for blacks
- The question of ownership of property for blacks
- Increases in service charges and the effects of the petrol price increase

Mr Wightman declined to detail the chambers' recommendations until the respective cabinet ministers had a chance to read them

He added that he expected the ministers to reply shortly and the meeting to take place in

Cape Town in the near future

Meanwhile Mr Hamilton said yesterday he had been contacted by a number of businesses in Uitenhage about a drastic drop in trade

"Shops that were once full of customers are nearly always deserted these days. It is imperative that to save the economy of the town, something is done to stop the unrest problem and return trading to normal"

● The Methodist Church in the Eastern Cape has called on the government to "declare its intention to renounce the use of institutionalised violence to enforce its political policy"

The church also says the government must lift bannings on prescribed political organisations to enable them to participate in legitimate

negotiation. These resolutions were adopted at a special synod of the Methodist Church in Uitenhage at the weekend

According to the Reverend George Irvine, chairman of the Grahamstown District of the Methodist Church, the synod was attended by about 150 members of the church

Messages of support were received from the British Methodist Church, the United Methodist Church in the United States of America and the Methodist Church in Ireland, Mr Irvine said

Mr Irvine said the synod also resolved to make representations to the government, "to encourage the complete dismantling of apartheid in South Africa" — DDC

(133) stew 25/4/85

Cape chamber opens its doors

Own Correspondent

PORT ELIZABETH — White businessmen in Fort Beaufort have invited black people to join their chamber of commerce and are to try to motivate the authorities to upgrade the black township.

This follows a month-long boycott of white traders by black residents and a visit to the township by white businessmen who say they are shocked by conditions there.

Mr Richard Roy, chairman of the Fort Beaufort Chamber of Commerce, said today his members

would take up the problems of the townships "to get movement from the authorities"

He said that while the boycott had cost white businesses thousands of rands, businessmen had developed "a new understanding of the conditions under which their black customers live" and were pressing for improvements.

SHORTAGE

Problems in the township included overcrowding, roads in bad condition and a shortage of basic facilities such as water.

Mr Roy said that at a meeting with six leading black businessmen the invitation to join the chamber had been received enthusiastically and was being considered.

Black leaders in Fort Beaufort have apparently told residents to buy only from traders in the township and there have been incidents of youths confiscating or destroying goods obviously bought from shops in the white area.

One businessman is said to be down by R30 000 in monthly takings while others have lost up to 30 per cent of their trade.

Part of Elizabeth tour
By DIRK VAN ZYL
Political Correspondent
CAPE TOWN — A top-level delegation from Assocom and Chambers of Commerce in the Eastern Cape today met the Minister of Co-operation, Development and Education, Dr Gerrit Viljoen, and the Deputy Minister of Education and Co-operation, Mr Sam de Beer, to discuss the unrest in the Eastern Cape

The Eastern Cape delegation consisted of Mr Rocky Ridgway, vice-president of Assocom, Mr Frank Wightman, president of the Port Elizabeth Chamber of Commerce, Mr Tony Gilson, director of the PE Chamber (who was also representing the Uitenhage Chamber), Mr Denis Creighton, regional vice-president of Assocom, and Mr Steve Birt, president of the Grahamstown Chamber

Also present were the Director-General of Co-operation and Development, Mr G van de Wall, and the Director-General of Education and Training, Dr A B Fourie

In a Press statement after the meeting of almost two hours, the chambers urged all leaders to come forward with "concrete suggestions" which could either be implemented by the chambers or conveyed to the Government.

Mr Gilson said in an interview the delegation had been "well received" by Dr Viljoen and his col-

Chambers talk to Minister

133 3074/85

leagues and had had in-depth discussions "and an exchange of ideas" on the Eastern Cape's "complex problems".

This included the political aspirations of blacks "and other sensitive political issues".

Specific matters included black education, housing and the creation of job opportunities

Mr Gilson said the memorandum sent to the Government earlier had formed the basis of the discussions and he was pleased "that a channel has been opened to us"

The delegation had stressed the importance of proper communications between leaders of sections of the community

Dr Viljoen had been "extremely sympathetic to our points of view" and had given the delegation an assurance of the Government's concern at the gravity of the situation

Dr Viljoen had said the Government would continue to take the action deemed necessary

In the statement, the delegation says it "recognises the Government has already taken specific action in connection with some of the issues which were raised and it stressed the importance of communications and bridge-building between leaders of sections of the community"

Mr Gilson said businessmen were "obviously extremely perturbed" at

the effect of the continuing unrest on the economy — turn-over was, for instance, depressed and deliveries were upset

"But more than that we are seriously concerned at what is being done to the fabric of society in the Eastern Cape"

He declined to elaborate on specific proposals made at today's meeting, but said it had to be borne in mind that unemployment was worse in the Eastern Cape than in any other part of South Africa, and "housing is also obviously an aspect about which something needs to be done"

(Report by Dirk van Zyl, Press Gallery, Parliament, Cape Town)

om the

JOHANNESBURG

Argus 30/4/85

133

Labour unrest spurred by political impotence

SHERYL RAINE of The Argus bureau in Johannesburg spoke to Anglo American's Bobby Godsell, head of the group's industrial relations department

BOBBY GODSELL is one of those bright young consultant/executives whose job category in the corporate scheme of things didn't feature prominently 10 years ago

He and other consultants like him have come into their own in the hurly burly of labour relations in South Africa in the 1980s

His job is to advise and assist the executives of Anglo American on the vital issues of industrial relations

This year he is talking about the economics of survival as the recession lingers on, the importance of ending job reservation on the mines, the Industrial Court, the role of management in the broader social scene in South Africa and the nature of trade unions

Times are tough and he insists that the words "economics of survival" are not over-dramatic. Things will get worse before they get better. He would like to see the issue of wage demands versus unemployment higher up on the agenda of labour issues. But he believes there is another side to the recession which could have a positive spin off

"In 1985, there is so little money in the kitty (for wage increases) that the battle of white skilled workers and black industrial workers is going to be to try to preserve their purchasing power or have it eroded as little as possible," he says

There are already examples of this greater coincidence of interests — for instance, in the current metal industry wage negotiations where previously incongruous union groups

Although there are obvious areas of conflict between skilled whites and blue collar blacks, he believes

the recession will tend to remind both of their common interests. Unions are striving together to get their members the best deal possible

There are still hurdles to leap in the black-white labour forum, the most important of which is statutory job reservation on the mines. He is confident that job reservation will go and that a new industrial relations structure for the industry as a whole will be forged — but says the exact time frame of both developments is hard to predict

His concern about the Industrial Court is shared by others in the field. As an essential and widely-used institution he believes it has had an encouraging start to its life. But the role of the court in relation to the rest of the judiciary and its role in collective bargaining urgently need to be clarified

"There are three judgments from the Supreme Court which have cast doubt on the Industrial Court. Is it a court or an administrative agency? It should be integrated into the judicial process

"Clearly you can't expect a new institution to be perfect. On the other hand both unions and management need help from the state now to rectify these two problems"

The broader social conflicts of South African society, trade unions and management's role in the present

era are things about which he has thought long and hard

In his opinion trade unions are not revolutionary in nature but reformist. Modern history has failed to reveal a successful revolution where trade unions have played a central role

In South Africa the unions have been a major vehicle for leadership emergence in black communities

So far management has been pulled into a transitional role of mediation not only with workers but with the broader black community involving a range of social issues

In modern industrial countries private enterprise inevitably becomes involved in public policy debates and contributes expertise to government. This, he believes, is growing in South Africa

But he says "There is no way that employers (in South Africa) can act as a substitute for political participation for black people. There is no doubt that the unrest we see in the townships now and other conflicts in society both have their origins in and can only be resolved within the political structures"

He believes that the country's labour dispensation is in advance of the constitutional dispensation for blacks and what industry now desperately needs is successful socio-political reform outside of the factory gate

133 ~~2/5/85~~ D. Dispatch

EP commerce acts on unrest

involving crack police and railway police units supported by the army was held in the Peninsula yesterday

The operation was a sequel to a recent exercise in which the Peninsula was sealed off by various security forces"

It is understood that several hundred members of the police reaction unit the railway police task force and the army were involved. More than 50 vehicles, including Caspirs and Buffels, were also used

A helicopter stationed at Ysterplaat was used in a communications role

The exercise started at 8 am and finished at about 3 pm — DDC

PORT ELIZABETH — Acting on a suggestion by the Minister of Co-operation, Dr Gerrit Viljoen, the Port Elizabeth, Uitenhage and Grahamstown Chambers of Commerce have agreed to act as a liaison between members of the region's community and the government, on matters of unrest

ted to finding a solution to end the unrest in the Eastern Cape

representative organisations

He said however, the chambers were hoping for a positive response from all sectors of the community, regardless of race, regarding the chambers' liaison function

Earlier this week a delegation from Assocom and the three chambers met Dr Viljoen and other representatives of the government, to exchange views on unrest in the Eastern Cape

According to a statement issued by the three chambers after the meeting the delegation held an in-depth discussion on the complex problems of the Eastern Cape, including the political aspirations of sections of the community and other sensitive political issues

Specific matters which were discussed included black education, housing and the creation of employment opportunities, the statement said

- A large-scale exercise

Mr Wightman said the chambers had not yet received any feedback regarding their liaison offer

Mr Wightman said among the groups the chambers would endeavour to contact would be members of the black community councils, leaders of black civic organisations and other black repre-

And in an attempt to reach as many people as possible, the chambers will make a concerted effort to contact leaders representing all sections of the community to establish their view of problems in the area, according to Mr Frank Wightman, president of the Port Elizabeth Chamber of Commerce

He said yesterday the chambers were commit-

Rises face clothing industry

NM 17/5/85

133

CAPE TOWN — The July wage increases come as the president of the National Clothing Federation, Mr Mike Getz, has warned about the 'serious dimension' of cost increases facing the clothing industry.

In a statement he warned that the industry would be 'under extreme pressure' to continue to keep price increases down and claimed that retail margins were being maintained while manufacturers' were dropping

He said 'Cost increases now facing the clothing industry are assuming serious dimensions in the face of still declining market trends

'Raw materials in particular have moved sharply upwards. Fabrics of locally produced cotton and wool have risen in price by 25 percent and 35 percent, respectively. Prices of polyester/cotton fabrics are increasing at an annual rate of between 15 percent and 25

percent.

'Wage bills nationally will grow by some 16 percent. The industry will be under extreme pressure to maintain its historic performance of keeping its price increases below those of the consumer price index

'Additionally the consumer index for clothing, at present increasing at a rate of some 14 percent, is now exceeding the clothing production index in a worrying way

'Prices at retail are rising faster than at wholesale,' Mr Getz said

Spokesmen for leading retailers said that retail margins were under pressure — (Sapa)

370 000 workers in deadlock

Seifsa strained as metal unions consider ballot

THE two major trade union blocs on the Metal Industrial Council, representing about 370 000 workers, will decide this week whether to proceed with a strike ballot following a deadlock in pay talks

Deadlock was reached seven weeks after a dispute with the Steel and Engineering Industries Federation (Seifsa) was declared by the entire spectrum of unions on the council, the largest bargaining forum in the country

It raises the possibility of widespread industrial unrest in the industry and the likelihood of stepped-up demands for plant-level bargaining, undermining the industrial council

After earlier proposing an effective wage freeze, Seifsa last week offered a 17c, or 8%, increase on the minimum rates, a guaranteed 24c rise for artisans and 14c for unskilled workers

In a plea to the unions on Thursday, executive director of Seifsa Sam van Coller said the industrial council was experiencing its most difficult period in 40 years

He said that in the current economic climate there was no way the industry could accommodate the union demands, which would lead

Own Correspondent

to massive unemployment, further shutdowns and more rapid mechanisation

The Confederation of Metal and Building Unions (CMBU), representing mainly skilled and semi-skilled workers, will caucus today with the all-white SA Yster en Staal

CMBU director Ben Nicholson said they were considering three options further informal negotiations, arbitration, or holding a strike ballot

At this stage the CMBU is more likely to look for ways of reaching settlement than the other major bloc, the local co-ordinating committee of the International Metalworkers' Federation, representing mainly unskilled workers

The four IMF unions — the SA Boilermakers' Society, the Metal and Allied Workers' Union (Mawu), the Engineering Industrial Workers' Union and the Steel, Engineering and Allied Workers' Union — will be meeting tomorrow.

IMF spokesman Brian Fredericks said there was no way the IMF could accept Seifsa's offer and that they would obviously be considering some form of industrial action

Mixed feelings over laws

By JOSHUA
RABOROKO

At Sowetan

28/5/85

133

TRADE unions and employers' organisations have mixed feelings about the Government's intentions to scrap the laws which keep blacks out of the best jobs in the mining industry — the Job Reservation Act.

The unions have called on the Government to abolish all racially discriminatory laws in the country, while the employers' or-

ganisation contend that they welcome the Government's intentions to change the law — the last of the racial provisions in South Africa's labour laws

The Minister of Mineral and Energy Affairs, Mr Dame Steyn, announced last week that the Government intended introducing legislation next year which will scrap job reservations on the mines

At present only

whites and some categories of coloureds can get blasting certificates

A section of the 1956 Mines and Works Act defining as "scheduled person" the racial categories entitled to skilled jobs, is the only statutory item of racial discrimination remaining in South Africa's employment legislation

The term "scheduled person" will be replaced with the non-racial term "competent person" in

the new law

The National Union of Mineworkers, the only black union that has a recognition agreement in the mines, said its members were impatient with the scrapping of the law. They felt that the time the Minister has put for the changing of the law — next year — was too far because there could be conflict before that

The union has presented proposals to the Chamber of Mines including the demand that job reservation be scrapped on the mines failing which the union has threatened industrial action

The Black Allied Mining and Construction Workers' Union's publicity secretary, Mr Motsumi Mokhni, said "We are not impressed by the announcement because the Government has refused to listen to calls from various quarters in the past. We want higher wages, health and occupational health for our members. Black miners get a pittance on the mines

United Mining, Metal and Allied Workers' Union's secretary Mr Enoch Godogwana said the Government should scrap all racial laws in the country. "We see this announcement as "paper work" because our people will still not earn enough and not receive training because of the migrant labour system," he said.

The Afrikaanse Handelsinstituut Congress '85 in PE

Collective bargaining system

'under attack'

S. Pot 28/5/85

133

"THE established and proven system of collective bargaining is under attack and these attacks have shaken the established trade unions"

This message was delivered to delegates attending an opening session in Port Elizabeth today of the Afrikaanse Handelsinstituut's 40th annual congress

Delivering a cautionary analysis of latest developments in the trade union movement — with specific reference to the motor trade — was Mr Piet Pretorius director of the Motor Industry Employees Union of South Africa (MIEU)

Mieu, together with the Motor Industries Staff Association, and the Motor Industry Combined Workers Union (recently disaffiliated from Tucsa) comprise the employee parties to the National Industrial Council for the Motor Industry Employer parties are the SA Motor Industry Employers Association and the SA Vehicle Body Builders and Repairers Association

The council is primarily concerned with the motor repair and vehicle body-building sector of the market and is quite separate from the Industrial Council for the Automobile Manufacturing Industry (Eastern Province), on which are represented Ford, General Motors and Volkswagen as employer parties, and Naawu — the National Automobile and Allied Workers Union — and the SA Iron, Steel and Allied Industries Union, as employee parties

Addressing delegates attending the AHI's motor trade sectoral congress at the Hotel Edward, Mr Pretorius said emergent unaffiliated trade unions



were blossoming in South Africa — with a penchant for striking up ad hoc shopfloor agreements as opposed to industry-wide settlements negotiated via long-established Industrial Councils

This development, said Mr Pretorius, could lead to 'serious problems'

Whereas workers in the sector covered by the National Industrial Council for the Motor Industry were represented by only three unions prior to 1979, an additional four registered unions had been established in the wake of the Wiehan Commission and "a further two unions periodically pop up

"These unions focus their attention on concentrations of black or brown workers but also on factories employing small numbers of black or brown workers

" they endorse shop-floor as opposed to centralised agreements and ironically employers have in many cases bowed to the pressure and this has lead to the creation of a large number of recognition agreements

"The established and proven system of collective bargaining is under attack and these attacks have shaken the established trade unions to their foundations in all industries," said Mr Pretorius

As a result the established unions lagged in the creation of benefits for members, who were increasingly questioning the ability of their representatives

"It is thus clear that the established trade unions will have to revise their ideas and attitudes

Manu wage talks are adjourned

May 1985

THE Industrial Council wage talks for the metal industry, which began on Tuesday against the backdrop of the arrest of unionists outside the negotiating hall, have been adjourned until May 15 without agreement being reached on union demands.

Before the talks began about 40 unionists, members of the Metal and Allied Workers' Union, were arrested after marching to the Johannesburg City Hall where the talks were held.

The adjournment is the second since the talks began between trade unions and the Steel Engineering Industries Federation at the beginning of April.

The negotiations resumed after

unions had declared a dispute with employers when employers suggested a pay freeze for a year.

According to a union source, the unions rejected an employer offer of an hourly pay rise of between 17c for artisans and 8c for unskilled workers. This was later raised to 20c and 10c respectively, but unionists still felt it would not meet the high cost of living.

The source said after the arrest of unionists outside the City Hall, a leading SEIFSA official suggested the talks be halted while efforts were made to try and secure their release. But unionists decided the talks should continue so they would be able to report back to their members.

133

AHI turns harsh light on Govt policy

133
E. Post
1/6/85

SOME 600 Afrikaans-speaking businessmen packed the city's hotels this week for a four-day "mdaba" that cast a harsh spotlight on the failings of the country's economy.

Resolutions tabled at the 40th congress of the Afrikaanse Handelsinstituut urged speedy and effective solutions across a wide front, and several speakers were unusually blunt in their criticism of economic and political issues.

"Policies aimed at rescuing the economy had jeopardised the survival of small business and such a disaster should never again be allowed," said Professor J A Lombard, head of the University of Pretoria's Department of Economics.

Roughly half the country's population lived in poverty and this had serious political and economic

implications, said Mr Johan de Bruyn.

While demand for skilled workers grew annually by some 2.3%, supply grew at 0.6% and the question must be asked whether the motor industry is making a meaningful contribution to the development of the skills which the country will one day in any event require, asked Dr J H Visser.

Ever retiring AHI president Mr Leon Bartel criticised Government policy, and strongly defended the AHI's endorsement of a joint private sector declaration.

Among the principles in the declaration (issued during the visit to South Africa in January by Senator Edward Kennedy) were:

1. "Meaningful political participation by blacks"
2. "The creation of a

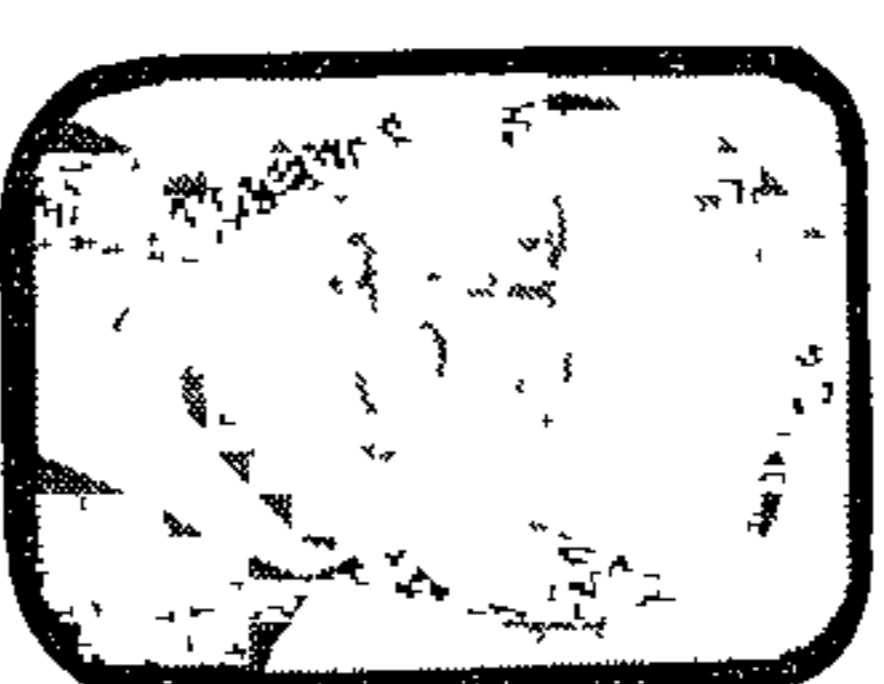

By Louis Beckerling
Business Editor

common loyalty to the country by all South Africans by way of universal citizenship

3. "An end to forced re-novals"

"These three points were considered at the time to depart from the AHI policy," said Mr Bartel.

However, they had since been addressed by the State President, among other political functionaries, and "thus what might have appeared strange in January, is now freely discussed and is being given urgent attention".

Mr Bartel also defended — in his presidential address — the AHI's appeal to the Government in November last year to release detained trade union leaders and warned that among the issues still to be considered by the AHI in the future was the question of detention without trial.

And in a final and highly significant debate, concern was expressed over the deteriorating image of South Africa presented to foreign investors.

Since domestic savings alone were inadequate to maintain an economic growth rate adequate to sustain high levels of employment, the country was dependant on foreign capital, argued Mr G Z Liebenberg.

Even were the economy to grow at an optimistic

employed in the informal sector or engaged in subsistence farming.

Only high levels of investment would create the necessary social and economic infrastructure required to sustain employment at adequate levels, and "South Africa is a capital-impooverished country".

Personal savings as a percentage of gross domestic savings fell from 29.8% to 8.2% over the period 1965 to '84 and taxation was a major culprit in this regard.

Apart from the obvious need for capital, foreign investment was allied with the provision of technology and skills, and financed the periodic deficits on the current account of the balance of payments.

Features of foreign investments in South Africa, said Mr Liebenberg, were that

● The country's total foreign liabilities had risen from R2 746 million at the end of 1965, to R45 545 million at the end of '83 — "reflecting favourable investment opportunities".

● However, whereas the ratio of foreign investments involving a controlling shareholding in a South African subsidiary to total foreign investment had grown virtually constantly from 49.6% in 1956 to 61% in '69, it had since fallen significantly to 42% at the end of '83.

● As a component of long-term foreign liabilities, foreign share capital

rate of 4.6% a year, by the year 2000 one in three economically active people — out of an estimated total population of 45 million — would be either jobless,

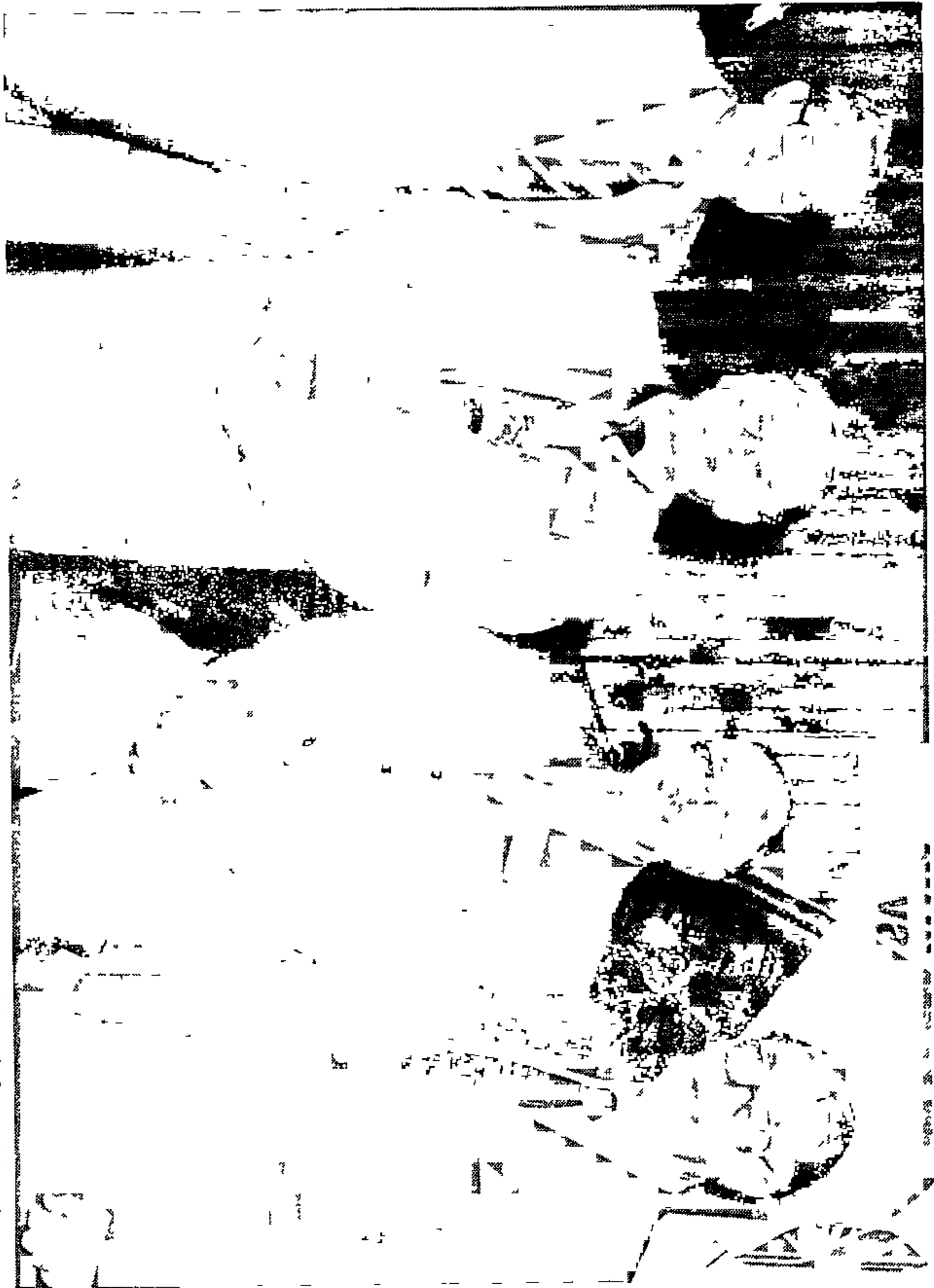

Photographed at this week's meeting in Port Elizabeth of the Afrikaanse Handelsinstituut were (from the left) vice-president Mr PIERRE STEYN, retiring president Mr LEON BARTEL, chairman Mr CHRIS KUUN and executive director Mr F F DE W STOCKENSTRÖM.

has shrunk substantially from 25% at the end of 1956, to 7% at the end of '83.

Reasons for the change include the lifting of controls over foreign exchange, the increasing need for foreign loan capital, and political developments, argued Mr Liebenberg.

On the credit side of SA's foreign-investment balance sheet was a history of political stability ("the current unrest in the Eastern Cape and elsewhere, as was the case with Sharpeville in 1961, is partially the consequence

of an economic depression and associated unemployment").

Furthermore the country enjoyed good relationships with its neighbours and economic stability as expressed in an annual average growth rate in the real gross domestic product from 1961 to '84 of 3.93%.

"However projections for the next five years are less rosy".

In addition could be mentioned mineral wealth, managerial expertise, a substantial infrastructure, a high level of international trade, and a

high return on investments

"Although concern about the future political stability of South Africa has negatively influenced the inflow of foreign capital, South Africa nonetheless remains a relatively attractive area for investments," said Mr Liebenberg.

The annual average rate of return on investments was measured in SA over the period 1972 to 1981 at 15.8% compared with Australia (14.5%), Canada (10.9%), New Zealand (10%), and Spain (9.9%), he said — "however this high-

er return may be required merely to compensate for the greater political and exchange rate risks."

On the debit of the balance sheet was a growing incidence of strikes "and the time might have arisen for allowing the current approach to labour affairs to follow the same path as the Westminster system, and devising a uniquely South African system". Further negative influences on foreign investment arose from the domestic shortage of skills, inflation, and the tax structure in the country, added Mr Liebenberg.

Industry faces row with unions

Some of the 28/5/55
SOUTH Africa's metal industries are faced with industrial action following a deadlock between employers and trade unions over pay increases covering over 370 000 employees.

The unions representing the workers are to meet today to decide what steps to take after their dispute with the

Steel Engineering Industries' Federation of South Africa (Seifsa) — the metal industries industrial council (IC)

The four International Metalworkers Federation unions in South Africa — the SA Boilermakers' Society, the Metal and Allied Workers' Union, the Engineering Industrial

Workers' Union and the Steel Engineering and Allied Workers' Union — have rejected Seifsa's wage offer

Seifsa offered a 17c or 18 percent increase on the minimum rates, a guaranteed 24c for arti-

sans and 14c for unskilled workers

IMF's spokesman Mr Brian Fredericks has charged that there was no way in which the IMF could accept Seifsa's offer which fell well below the standard of living



Many SA companies have their own version of Sullivan code of US

CAR-TINTS
13/k/88

133

MAJOR South African companies have similar codes for fair employment as the Sullivan signatories and differences which exist between them are rapidly diminishing.

Industrial relations experts stated this in response to news that Video Vision Enterprises — distributors of motion pictures — was becoming the first South African-owned company to sign the Sullivan code. The US-based Sullivan code aims at eliminating apartheid in the workplace.

Companies
Pastor Leon Sullivan, whose guidelines have helped shape Washington's South African policy for eight years, said recently that the US

should impose a total economic embargo on the country in 1987 if apartheid was still in force.

Professor Blackie Swart, head of industrial relations at the University of Stellenbosch, said some major local companies had subscribed to the Urban Foundation and Saccola (SA Coordinating Council on Labour Affairs) codes of intent at the same time as the Sullivan code was published in 1977.

Implementing
Many had adopted their own codes from these, but these practices weren't monitored and publicized like those of Sullivan signatories.

Thus some major South African com-



Seductive
Martha Greenwood (Ingrid Boulting) embraces detective Sam Black (Brent Huff) in the film 'Deadly Passion' which was distributed by a signatory of the Sullivan code, Video Vision Enterprises.

panies were sometimes a bit behind in implementing them. A few smaller companies didn't even know the employer federations they belonged to were committed to these codes.

Legislation
Mr Fred Ferreira, executive director of

Samcoi and president of the nine task groups co-ordinating the Sullivan code, said there were few differences left between Sullivan signatories and major South African companies.

He attributed this change to greater legislation applied to employment practices

and greater enlightenment with regard to fair employment.

Consulting
But he said a South African-owned signatory to the Sullivan code would not be answerable to anybody.

Only American signatories submitted an annual audit to a con-

sulting organization in the United States which was briefed by Sullivan. "I believe the code has had an impact on South African companies, also changing the perception of employers about the kind of relations they should maintain with employees."

Recession hits blacks worst

By JOSHUA RABOROKO

MORE than 10 000 workers, mostly blacks, have been laid off in the metal industry this year alone because of the recession.

The latest quarterly survey of the Steel Engineering Industries Federation of South Africa (Seifsa) says metal industry employment opportunities have declined by more than 20 percent in the past five years.

It says an estimated 360 000 people were employed in the metal production process at the end of March compared to 454 000 at the end of 1981.

"Employment statistics, based on a comparison between 1984 year-end and first quarter 1985 wage surveys, reflect a loss of some 10 000 jobs during the period, highlighting the strong recessionary conditions which now characterise the Seifsa group of industries," says the report.

Concern

These latest statistics have caused concern among trade unions operation in the metal industries, especially the Metal and Allied Workers' Union, the South Africa Boilermakers' Society and the Steel Engineering and Allied Workers' Union.

The three unions, which are affiliated to the International Metalworkers' Federation (IMF) have said that they will lose a vast majority of members.

Mawu's Transvaal secretary, Mr Moses Mayekiso, said the retrenchments come in the wake of a deadlock reached between the unions and Seifsa over wages and working conditions. Mawu will meet its members at the weekend to discuss the issue.

W/ARGW 22/10/82

Keeping the union wolf from the door

LABOUR
AFFAIRS
DICK
USHER

AFTER Professor Nic Wiehahn took a hand, labour relations in South Africa could never be the same

The most significant change was that black workers were included in the definition of employee and suddenly for management, it was a whole new ball game

There was an Industrial Court with the power to rule on unfair labour practices and order the reinstatement of workers it considered had been unfairly dismissed

Trade unions looking after the interests of black workers emerged at a rapid rate and the Department of Labour (as it had been) took a fairly sharp step out of involvement in industrial relations

Managers, accustomed to a situation where they could call in the department and too often, the police to mediate in disputes, floundered

The situation was, in accordance with good, capitalist, free enterprise principles, open to exploitation by people more understanding of the role of trade unions and the needs and aspirations of black workers

They had skills and insights to sell, and a new group of professionals — the industrial relations consultant — appeared

Their role, to mediate between managements who were very often completely antagonistic to the emergent trade unions and the economically disadvantaged, politically powerless black workers the unions represented

One such Steve Woods had his first exposure to industrial relations with a major engineering group in the pre-Wiehahn days and was still with the company when it negotiated one of the first recognition agreements with a "black" trade union

"It caused quite a controversy and we came in for a lot of criticism from other employers

MONEY TO BE MADE

"But, as events progressed I started getting tired of former critics phoning and asking how we had managed to develop a relationship with the unions that did not result in massive industrial unrest

"I realised that there was money to be made out of helping companies analyse their industrial relations problems and the practical training of factory level supervisors in dispute and grievance procedures

"The problem is that many companies do not have their industrial relations house in order which makes it inevitable that the union wolf will come knocking at their door" he says

"And the company that says it will never deal with a union is nine times out of 10, practising a style of management that makes it a sucker for the unions

"Then often when it's too late they call in an industrial relations consultant to help sort out the mess

"You arrive to find the workers have been organised management is very confused about it all and if nobody tells them they are wrong they will carry on thinking they are right

"We come in as outsiders with a different perspective and try to bring some objectivity to an often very subjective situation in which management allows personal political attitudes and feelings about unions to cloud their judgment

"They don't treat dealing with a union as a business problem in the same way say as they would deal with an increase in GST

"So they make short-sighted decisions where they are always looking for an out rather than accepting the union as a long-term fixture

"In the main our role is important because we're independent of the company and the company's survival. We all tell management that they're acting like idiots because we're hired by the company not employed by it"

Learn to listen, managers told

Labour Reporter

SOUTH African managers had to learn to move beyond mechanistic systems for dealing with conflict in the market place and understand the human factors involved

Professor D de Villiers, director of Unisa's Institute of Labour Relations, said today at a Cape Chamber of Industries Conference on industrial relations that up to very recently the focus of attention in resolving conflict had been on the systems

Although the labour relations system as it had developed in

South Africa had evolved to meet our own needs and the demands of our time — a well-developed system which put South Africa ahead of much of the rest of the world — it remained a human control system

Conflict was an inherent part of the human being and it was therefore inevitable that there would be conflict wherever people rubbed shoulders at a machine or across a desk, said Professor de Villiers

But these conflicts could not be resolved only through the systems. Most strikes in South

Africa were caused by interpersonal problems, as it was on this level that management had to start dealing with conflict

It should also be remembered that any conflict created a supporting surge of emotions on both sides. But emotion continued over a period and unless this aftermath was dealt with the scene was being set for future conflict, said Professor de Villiers

Management had to learn to listen and put itself in the position of the other party to the dispute

'Optimism' in industrial relations

Staff Reporter

THE industrial relations situation in South Africa looked optimistic in spite of the economic climate, Dr P G van der Merwe, director-general of the Department of Manpower, said in Cape Town today

He was addressing an industrial relations seminar of the Cape Chamber of Industries

Dr van der Merwe said one of the factors contributing to optimism was that the department's attitude had changed from a paternalistic one to one

that recognised individual economic freedom and responsibility, and minimum State interference

Last year 181 000 workers were involved in strikes. This showed that trade unions were exercising their muscle and that the movement was alive and well

There was a balance of power between employers and unions. If there were no strikes it would demonstrate an imbalance

However, on average strikes in South Africa lasted only two

days and 50 percent were resolved in one day. In most countries these would not be counted as strikes

He also said conciliation machinery was being used more and more

There might be criticisms of the industrial court system, but it was being used, he said. It had dealt with 15 cases in 1980, 169 in 1983 and 399 last year

The growth of the trade union movement and collective bargaining were positive factors. Care must be taken not to let this progress be lost

GROWING discontent among members of two major employer organisations, Seifsa and the Chamber of Mines, over wages and working conditions could lead to national industrial actions — within weeks.

Disagreement among metal unions over bargaining, which precludes plant-level negotiations, could cause strike actions, union sources disclosed to The SOWETAN yesterday.

The National Union of Mineworkers, which held strike ballots at 18 goldmines and 11 collieries, is dissatisfied about centralised bargaining with the Chamber of Mines which it claims is "deeply divided".

However, the Chamber has rejected claims that it is divided and asserted that the results of the ballots will not bring any change in wage negotiations.

The 55 000-strong Metal and Allied Union (Mawu) has threatened to stage a national strike because of escalating dissatisfaction over employers' opposition to negotiations outside the Industrial Council.

Mawu has refused to sign a wage agreement

Industrial action imminent

with employers at the council — the second time in two years. The union maintains that it will seek plant-level bargaining and if employers refused them "we shall be forced to take strike action," a spokesman said.

A NUM spokesman yesterday said the results of the strike ballot have not been released yet. They will probably be known late in the week.

It has emerged that some mine companies were prepared to offer its black mine workers more than the chamber was offering, but because of centralised bargaining it ended up proposing less.

The chamber's spokesman said it will

not alter its final offer even if workers strike. However, there are rumours that some companies hold different views.

The spokesman was certain that the mining industry's unity will be preserved.

Seifsa has indicated that it will not change its offer to suit Mawu's demands, although some members have shown willingness to negotiate with Mawu at plant-level.

Mawu has argued that the policy of centralised bargaining, which precludes plant-level negotiations, was aimed at protecting highly profitable companies from meeting workers' demands.

FCI queries the cost of creating employment

5/7/85 B. Day 133

THE Federated Chamber of Industries believes it is time the decentralisation scheme was thoroughly reviewed to determine just how cost effective it has been in creating employment

The FCI, like leading businessmen and economists, supports any project aimed at job creation — but not at any price

Earlier this week the chairman of the Decentralisation Board, Duggie de Beer, claimed the policy was working and attaining its major aims of job creation and a wider spread of industry FCI director Johan van Zyl says FCI agrees that some of the major aims, especially in the employment field, are being achieved

When the policy was first announced at the Good Hope Conference, however, it was made clear it was not possible beforehand to determine final details of the incentive structure

Van Zyl says it was also clear that this type of programme involved a trial-and-error approach, and that it was impossible to develop the right incentive structure in the first round "Any scheme aimed at creating

By GERALD REILLY

employment is to be welcomed and supported, but the question is whether the cost of creating new jobs is not too high"

The question could be asked whether it was possible to create even more jobs more cheaply Van Zyl says it would seem reasonable after the scheme had been in operation for several years to review progress in detail and especially to determine exactly how much the new jobs were costing

"The job-creating aspects of the de-concentration policy is to be applauded, but it would be a mistake to go blithely on with the scheme if it is not, in fact, cost effective"

The FCI has no intention of rocking the boat, but the case was strong for a review of the achievements and the cost invoiced so far

Chief executive of the Afrikaanse Handelsinstituut (AHI), Fritz Stockenstroom, says measurable progress has been made in the past 18 months on implementing the decentralisation plans and the policy has the wholehearted support of the AHI

The phasing-out of incentives for location-bound industries is welcome "This scheme is working well under efficient management"

Stockenstroom emphasises the vital need to keep momentum going until at least the end of the century The need for development and job creation in the decentralisation regions is great, and the record shows this is happening "However, it has to keep on happening"

The policy also has a vital role to play in orderly urbanisation The two policies are closely linked Decentralisation is aimed at creating greater employment in the rural areas and self-governing states, and in this way it relieves urbanisation pressures

An Associated Chambers of Commerce spokesman says "We know steps have been taken to ensure the policy will work" The incentive scheme has been modified to eliminate abuses and to place restrictions on the type of business eligible for incentives

"Assocom has no reason to believe that decentralisation plans are not on their way to attaining their major objectives"

Free Mandela, SA businessmen urge

BONN — A group of South African businessmen has called on government to negotiate with black leaders and free ANC leader Nelson Mandela

But the group has spoken out against sanctions against Pretoria and urged West European countries not to apply them

The delegation, representing many leading companies in the Republic, is touring Europe after giving evidence last week at a United Nations hearing in New York on multinational corporations in South Africa

Sapa reports that delegation member, Professor Nic Wiehahn, an expert on labour affairs, told a news conference the consensus in business circles was that Mandela, serving a life sentence for sabotage and plotting to overthrow government, should be freed

Johan van Zyl, chief executive of the Federated Chamber of Industries, said he hoped blacks would come forward with their own leaders to negotiate with government on the country's future

He said an unstoppable process of change was taking place in South Africa

The question was whether change would be peaceful or violent, Van Zyl said

Peaceful change would be better because "most of our members feel businesses and the free enterprise way of life are at stake," he said

Economic sanctions could be counter-productive in South Africa, creating "not

only a siege economy but also a siege society", he said

Van Zyl said the organisations represented by the delegation favoured universal suffrage in South Africa within a federalist system to protect minorities

Prof Wiehahn said they were against a future unitary system of government as that could lead to what he called "a new form of apartheid"

Meanwhile one of the businessmen told a news conference in London on Tuesday that Minister of Law and Order, Lous le Grange, was "seriously ill"

Arthur Hammond-Tooke, foreign trade secretary of the Federated Chamber of Industries (FCI), said when questioned about Le Grange "We are dealing with a seriously ill man, a man who would prefer not to carry on with a job which is particularly onerous"

John Battersby reports that Johan van Zyl told the London news conference that recent talks between South African businessmen and ANC leaders had been "very useful"

Asked whether organised business backed the efforts of business leaders to open channels of communication with the banned ANC, Van Zyl said at this stage it had been thought appropriate that the talks should remain "a personal initiative by a number of our members"

"At some stage organised business will get involved in building confidence and mutual respect between the negotiating partners," he said — Sapa-Reuter

Industrial Court rulings not automatically

12/9/85

By Sheryl Rame
 The Industrial Court yesterday made one of its most significant rulings to date on labour matters concerning the issue of plant-level bargaining, but because of a secrecy law no details of the ruling may be made known until the parties involved agree.

The *Star* is in possession of a copy of the ruling in the matter between the Metal and Allied Workers' Union (Mawu) and Hart Limited, a member of the Steel Engineering Industries Federation of South Africa (Seifsa). Seifsa, according to its lawyers, has decided not to release the judgment until next Monday. A Durban spokesman for Mawu said that while the union was not placing an embargo on the ruling, the union was

not prepared to comment on the ruling until Friday. The union would not release copies of the judgment. Mr M A E Bulbulia of the Industrial Court, who signed the judgment yesterday, said it was not the court's responsibility to publicise its findings.

A secrecy clause in the Labour Relations Act pertaining to the court had been introduced to protect companies required to disclose sensitive material in evidence before the court. All judgments had to be cleared by both parties to a dispute before any judgment could be published.

In other South African courts sensitive material may be ruled unpubhshable but judgments are always made public.

Dion's Low Price

at the new
DION WESTGATE SUPERSTORE!
 Opening Thursday 26th
 September at 7.00 am.

- COMBINATIONS
 Model CS 210
- Versatile 4-band radio
 - Light and compact cassette mechanism
 - Universal mains voltage.

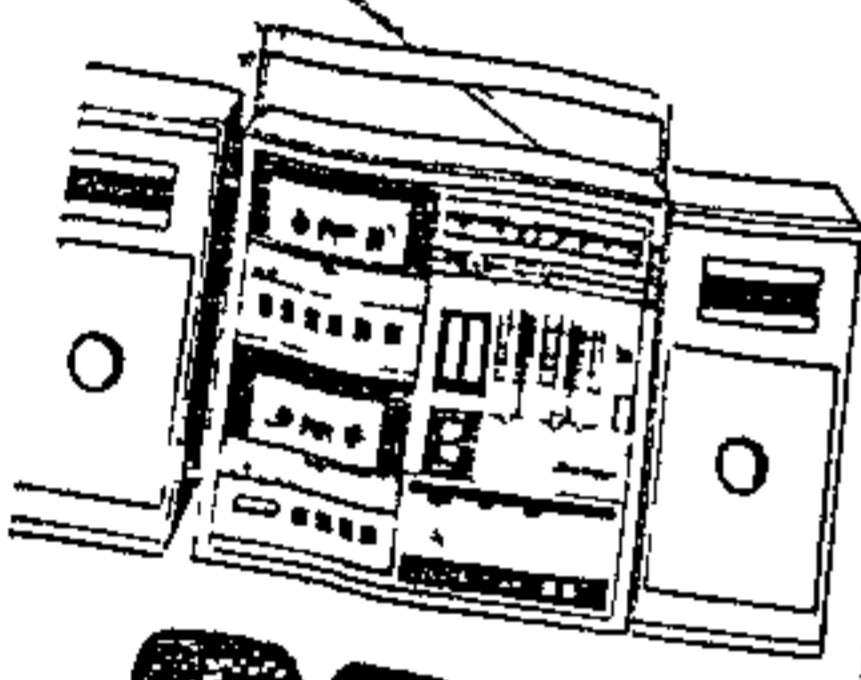

AIWA
 SLIMLINE
 RADIO/
 CASSETTE
 COMBOS
 Model CSW 330

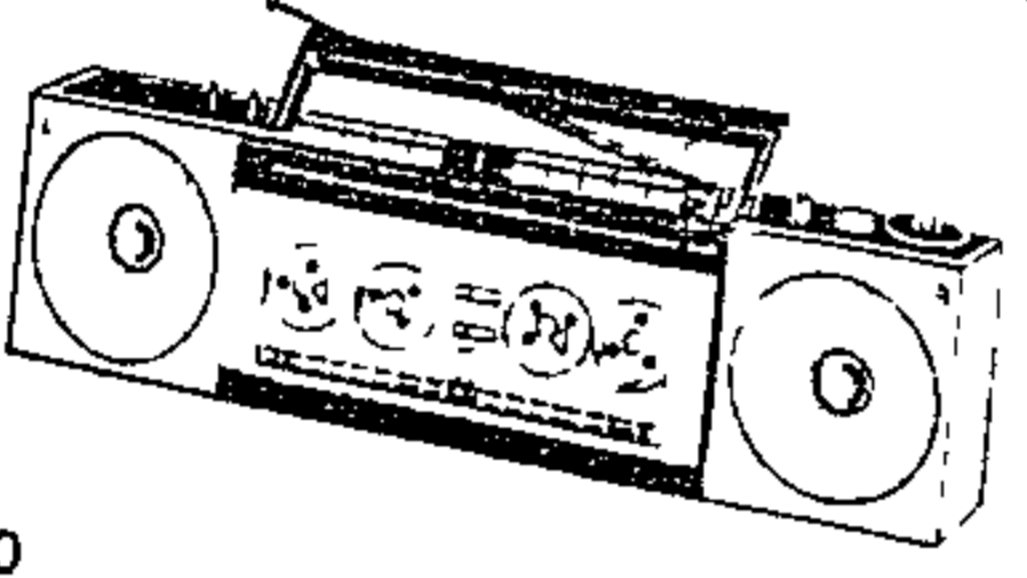

- Sensitive 4 band radio — FM/MW SW1 SW2
- Cassette player with double speed dubbing facility
- Cue and review

398⁸⁸
 Dion's Low Price

449⁸⁸
 Dion's Low Price

299⁸⁸

BUSINESS DAY, Thursday, September 12, 1985

Plant-level demands legitimate

Expert slams Seifsa's stance on bargaining

OPPOSITION by the Steel Engineering Industries Federation (Seifsa) to plant-level bargaining was an example of the inflexibility that had caused SA's current crisis, a labour expert said yesterday.

Industrial relations consultant Andrew Levy said at a Johannesburg conference Seifsa's opposition to plant-level bargaining was a refusal to recognise legitimate aspirations and legitimate power.

He said debate about the level of collective bargaining was ultimately political and would have a major influence on the outcome of SA's political balance of power.

"In seeking to negotiate wages with their employers though their trade unions at plant level, blacks are exercising the very participation in the sort of dialogue that all reasonable people in SA must support

"By denying them this opportunity, employers are demonstrating just the

CLAIRE PICKARD-CAMBRIDGE

sort of thinking that has led to the current crisis," he said

Seifsa argues that similar issues cannot be bargained effectively at two levels (when there is already an Industrial Council) and that shop-floor bargaining will lead to disorder

But Levy said a failure to realise that a judicious blend of plant bargaining and national regulation was appropriate and to set an industry on a path likely to result in greater conflict did not seem worth the price it might exact.

About 1 000 companies, including some of the most influential employers, already bargained at plant level and Levy believed the dispute about the level of collective bargaining would also pass.

Industrial conflict in the metal industry, which employed over 400 000 workers, would have an economic and political impact, he said

EEC's trade code for SA likely to be mandatory

ARGUS 9/9/85 133

Argus Foreign Service

LONDON — A stricter and mandatory EEC code of conduct for companies trading in South Africa will be under discussion when the EEC Council of Ministers meets in Luxembourg tomorrow

The Foreign Ministers of the 10 EEC countries are expected to have an acrimonious debate on whether to apply sanctions against South Africa, with Britain and France squaring up against each other

TROIKA VISIT

But that row was largely defused by the visit to South Africa of the "troika" of EEC foreign ministers from Luxembourg, Italy and the Netherlands

When they left South Africa, to everyone's surprise, they declared there would be no immediate sanctions. Now the focus is on beefing up the code

An indication of the more relaxed atmosphere expected at the meeting is that British Foreign Secretary Sir Geoffrey Howe will not attend as he is visiting Nigeria.

He will be represented by Mr Malcolm Rifkind, the Foreign Office's specialist on South Africa. Had a full-scale diplomatic row between Britain and France been expected, Sir Geoffrey would have attended the meeting.

British sources confirmed that changes to the EEC code of conduct would be under con-

sideration

The code is similar to but less stringent than the Sullivan Code subscribed to by United States firms in South Africa.

It is voluntary and participating firms report to their governments annually on their business operations.

Officially, the EEC will consider "adapting and strengthening" the code

An exploratory meeting of officials has already been held to discuss changes and another meeting is planned after the meeting of the Council of Ministers.

The most obvious change would be to make the code mandatory

TO: Captains of Industry and Commerce, Employers, Political and Trade Union Leaders.

OCT 9 1985: NATIONAL DAY OF PRAYER AND FASTING

We write to you as a person of influence to seek your understanding and that of the organization you serve, in interpreting the call for a Day of Prayer on October 9th 1985. This emerged from the National Initiative for Reconciliation held in Pietermaritzburg from 10-12 September 1985.

A copy of the full Statement of Affirmation supported by all but a few of the 400 leaders of 48 Church denominations and organizations is enclosed, and we know that you will read it with care. But even more important is the need to explain the quite remarkable - perhaps miraculous - process which gave birth to this statement. This is something that has not been conveyed in the shorthand of press reporting but must be understood if we are to receive from you the co-operation we covet.

I. A Sign of Hope

South Africa desperately needs signs of hope, and we believe that the National Initiative for Reconciliation is such a sign. In Pietermaritzburg where the Initiative was launched this was demonstrated by

- 1 The widest cross section of Christian leaders ever gathered in South Africa - all searching for a new way for our land
- 2 A willingness on all sides to acknowledge and confess our different complicities in creating and tolerating the cruel injustices of apartheid
- 3 A common desire to move beyond political point-scoring to a genuine listening to God and each other.
- 4 The painful emergence of a pledge to work across traditional political and denominational barriers for a changed and totally nonracial South Africa

The National Initiative for Reconciliation was in the words of a black leader "A miracle which took my breath away and gave me hope again." A Dutch Reformed minister put it this way "I have been converted four times since I came here!"

II. The Day of Prayer

1. The call for all Christians to give one working day - if necessary sacrificing their pay - to acts of repentance, mourning and prayer, was reached through a process of deep struggle, with everyone anxious to find a non-violent way to demonstrate to South Africa the depth of our caring for the intolerable suffering surrounding South Africans, especially those in the townships
2. The calling of this day is not a cheap political act, and should not be seen in terms of a "stayaway" or "strike". It is intended to be an opportunity to express in a spiritual and Christlike way our repentance for past wrongs and our commitment to the removal of injustices
3. It is not linked to any political grouping or organization, but is a call to Christians to identify with the pain of their fellow South Africans
4. It is not a threat but an act of penitence

III. Our Appeal

1. Accordingly we will be calling on all Christians responsibly to observe this day by seeking a day's leave on October 9th. It would be left to the individual to decide whether to request the day as paid or unpaid leave. It is also recognised that in many cases this will obviously involve sacrificing one day of their annual paid leave. All participants in the Day of Prayer would then be free to observe the day privately at home or join in services of prayer and fasting to be arranged in as many

churches as possible

2 We wish to appeal to all employers in commerce and industry to respect this call by granting requests from their employees who wish to observe the Day of Prayer. We are grateful for the guidelines already circulated by the Federated Chamber of Industries, because these guidelines reflect the spirit which we have sought to express

3 We appeal to Trade Unions and political organizations neither to oppose the call nor seek to enforce it in any way. As a Christian act we believe that any response to the call must be absolutely voluntary and devoid of any coercion

4 We call on those involved in any essential services, as well as those affecting the health, education or well-being of anyone, particularly the young, aged or sick, to continue prayerfully with their work, and to consider donating one day's pay to any organization which eases the suffering of the victims of injustice

5 We have no right, of course, to speak into any constituency but our own, but would nevertheless want people of other faiths to feel welcome should they wish to stand in solidarity with this witness to a hope in God and a desire for repentance and healing in our land

IV. Our Expectation and Prayer

Our Biblical heritage demonstrates that there are times when God calls on His people to pause, to reflect, to seek His guidance, and to change their ways. We believe this Day of Prayer is such a moment, and that out of this moment there could flow new hope and unity for our divided and beloved land

This is our confident expectation and prayer and we seek your understanding, and if possible your support

STATEMENT BY THE FEDERATED CHAMBER OF INDUSTRIES TO ALL ITS MEMBERS

DAY OF PRAYER: 9th OCTOBER 1985

The Federated Chamber of Industries is not unsympathetic to the cause but is in no position to prescribe to members how the call for the day of prayers should be approached

In terms of its Constitution, the Chamber supports freedom of religion and conscience

The Federated Chamber of Industries wishes to clarify an apparent misinterpretation. The Christian leaders have called for a day of repentance, mourning and prayer and not for a stay away in the accepted sense of the word. The authentic statement was published on page 10 in the Sunday Times dated 15th September (please advise should you require a copy). As a general guideline the Federated Chamber of Industries suggests that if it is a day of prayer and workers wish to observe or attend a Church service during midday or late afternoon (similar to days of prayer for rain in the past) employers could be expected to consider it sympathetically. However, should workers not attend work at all without permission the following approaches by individual employers have already been identified -

- should workers take the day off from work it will be considered as paid leave
- no work, no pay!!

NATIONAL INITIATIVE FOR RECONCILIATION

133

Business sets out its reform

1) THE object of this statement, made on behalf of leading employer organisations in South Africa, representing the majority of black and white enterprise in commerce and industry, is to outline the positive and effective role being played by organised business to promote and accelerate the progress of change in the country in order to realise the legitimate aspirations of all black South Africans and to effect the removal of discrimination based on race, colour, creed or sex

The organisations take pride in attesting to the good work and valuable contribution by the trans-national corporations (TNCs) for the furtherance of these objectives individually or collectively

The TNCs should be included in the term "leading employer organisations" by virtue of their membership and participation in the work of these organisations

There is a need for international businesses to continue their positive contribution to SA's development efforts and particularly in the area of black advancement where they have played a significant role

The employer organisations believe they are a powerful force for change and have the motivation, sincerity of purpose and credibility to achieve the universally-approved outlined objectives

2) The leading SA employer organisations have on various occasions during the past year committed themselves publicly to an on-going process of economic and political reform

For example, in a joint Press statement issued on January 7, 1985 a number of critical issues were explicitly identified

□ Full participation by all South Africans in a private enterprise economy and in the political dispensation of the country

□ A common loyalty to the country as expressed through citizenship for all

□ Ending forced removals

□ The administration of justice to be safeguarded by the courts.

□ Further development of a free and independent trade union movement

3) Since then the co-operative and public effort of organised business has gone further in a number of directions

The organisations are now in a position to influence significantly the social, political and economic course of events in SA.

4) It is clear the SA business community has deliberately chosen for itself a role as a positive agent of change. By international standards this is an unusual position for business to take. Hence the issue of motivation needs to be addressed

(a) Business is deeply concerned that increasingly-violent internal conflict between black and white may become institutionalised in SA.

Because of the strength and the numbers on both sides violence cannot resolve this confrontation. Only death, bloodshed and poverty can emerge as ultimate victors

SOUTH Africa's major employer bodies, black and white, English and Afrikaans, this week joined forces to deliver a comprehensive statement to the United Nations hearings on trans-national corporations in SA. Signatories to the statement were Die Afrikaanse Handelsinstituut (AHI), the Association of Chambers of Commerce (Assocom), the National African Federation of Chambers of Commerce (Nafcoc), the Federated Chamber of Industries (FCI) and the Urban Foundation. The statement, printed here in full, outlines the role of business in the reform process in SA

(b) The traditional "business way of life" — the private enterprise system itself — is fundamentally at stake. It is the perception of business that if SA's people lose control over the process of change either white- or black-dominated authoritarianism will result in which there will be little room for a substantially market-orientated economic system

(c) If effective channels of political expression for blacks up to the highest level are not developed, they will be increasingly forced to employ industrial relations mechanisms to voice grievances

Such a development is unsound and would put the business community in an invidious position

(d) It is now simply a fact of life that the SA economy has become much too large to be managed by whites alone. In their own self-interest business must get involved with black advancement in the broad sense and particularly in the area of promoting the rapid development of black managerial talent

It is essentially both self-interest and social responsibility which are driving the business community towards active promotion of reform

5) The pressure of economic forces, whether diffused through the marketplace or articulated through business groups, has promoted the progress of black advancement, the rapid growth of black spending power, the emergence of black unions and the development of a black business class

It has laid the economic foundation for the current debate about black political participation

6) In dynamic terms an unstoppable process of transformation is currently occurring in SA which is mainly driven by black aspirations and discontent generating in its wake powerful internal pressures for reform

This demand for change is being supported by the SA business community both in its own enlightened self-interest and for reasons of broader social responsibility

Collectively these internal pressures are now sufficiently powerful to sustain the process whether or not overseas interests engage or disengage from SA. Thus the real issue is whether this process will be violent or relatively peaceful

7) Since the declaration of the partial state of emergency, organised business has played and even stronger role.

(a) Accepting the need to restore law and order in parts of SA, business

made it clear publicly that security action alone will not resolve the serious conflict in black townships

Such action must also be backed by a package of substantial reforms to recognise black aspirations and to redress legitimate grievances

Real negotiations in the political and industrial relations spheres are the key to a return to an orderly SA and to stability in our townships

(b) A number of meetings were held with senior Cabinet members and the State President to exchange views and to discuss alternative courses of action

(c) In an official reaction to the financial crisis of confidence which led to the closing of the forex markets and the stock exchange, organised commerce and industry reaffirmed their strong support for a process of peaceful accommodation of the political, social and economic aspirations of all South Africans regardless of race, colour or creed

They again stressed the vital importance of negotiation with all accepted black leaders "even if some of these are currently in detention" and offered to government their negotiating experience and expertise gained in the formative years since 1980, during which the new labour dispensation (to accommodate legalised black trade unions) had to be established.

They also indicated their willingness to mediate between and among various leaders and groups in the country, both black and white, in order to get a serious negotiation process going which will involve a new constitutional dispensation for all

8) Against this background, organised business in SA is engaged in orchestrating an even more active strategy for the private sector to contain a number of inter-related elements

(a) There is a need for establishing an "SA business charter" outlining, against the backdrop of a number of public statements in this regard, the full set of objectives and principles for power-sharing and black advancement to which the business community is committed in pursuing its own action programme

(b) Serious direct negotiation between black leaders and government needs to be preceded by an important pre-negotiation phase during which the emphasis should fall on confidence building through mediation and conciliation

Rushing through this pre-negotiation phase could seriously jeopardise

the effective round-table

This is what could play a role in the scenes typically at promotion in order parties closer

Agenda-setting and basic assumptions established necessary before can begin

(c) An effective strategy employment at the short and urgent necessity

This will involve a phasis towards a promoting order involving action on issues such as privatisation, the removal of the pass laws, the informal sector, and a more cost-orientation policy

Such a policy with a broad support economic reconstruction economic growth competitiveness of stimulating inflation

(d) Further improvement that need to be regionally-oriented upgrade the quality of towns, and a non-vocation-orientation which will open black advancement constraints on competitiveness

The overall programme is to reposition SA as a country to regain its place in the democracies of the world

9) In the view of an effective role for business to play in our country and support constitutional processes which are moving under their own impetus of real reform.

Effective disengagement abroad will make the reform process more difficult, mainly because of domestic polarisation and the result from international

Disassociation of organisations from a constructive role, the stake in SA is too high

But there is no doubt that it would make it more difficult to achieve the objectives outlined in this

While these indications continue, overseas business indeed actively support aggressive engagement total disengagement of the country, on condition that at least some of the interests of blacks are safeguarded as progress is being made.

133 (304A)

Business sets out its reform role

statement, made by employer organisations, representing black and white enterprises in industry, is to play an effective role in business to ensure the progress of the country in order to meet the aspirations of the people and to effect a transformation based on race or sex

take pride in their work and valuable contribution to the trans-national business for the further development of the country individually

included in the membership work of these organisations

international development efforts in the area of where they have role

organisations be a force for motivation, since credibility to fully-approved

organisations on occasions during the ongoing process of reform

Press statement 7, 1985 a number were explicitly

all South African business economy dispensation of the

the country as a membership for all goals of justice to be

of a free and movement

operative and business member of direc-

are now in a po- significantly the economic course

business community for itself a of change By this is an un- business to take motivation needs

ly concerned about internal and white may in SA. length and the violence can- tentation Only poverty can factors

SOUTH Africa's major employer bodies, black and white, English and Afrikaans, this week joined forces to deliver a comprehensive statement to the United Nations hearings on trans-national corporations in SA. Signatories to the statement were Die Afrikaanse Handelsinstituut (AHI), the Association of Chambers of Commerce (Assocom), the National African Federation of Chambers of Commerce (Nafcoc), the Federated Chamber of Industries (FCI) and the Urban Foundation.

The statement, printed here in full, outlines the role of business in the reform process in SA

(b) The traditional "business way of life" — the private enterprise system itself — is fundamentally at stake. It is the perception of business that if SA's people lose control over the process of change either white- or black-dominated authoritarianism will result in which there will be little room for a substantially market-orientated economic system

(c) If effective channels of political expression for blacks up to the highest level are not developed, they will be increasingly forced to employ industrial relations mechanisms to voice grievances

Such a development is unsound and would put the business community in an invidious position

(d) It is now simply a fact of life that the SA economy has become much too large to be managed by whites alone. In their own self-interest business must get involved with black advancement in the broad sense and particularly in the area of promoting the rapid development of black managerial talent

It is essentially both self-interest and social responsibility which are driving the business community towards active promotion of reform

5) The pressure of economic forces, whether diffused through the marketplace or articulated through business groups, has promoted the progress of black advancement, the rapid growth of black spending power, the emergence of black unions and the development of a black business class

It has laid the economic foundation for the current debate about black political participation

6) In dynamic terms an unstoppable process of transformation is currently occurring in SA which is mainly driven by black aspirations and discontent generating in its wake powerful internal pressures for reform

This demand for change is being supported by the SA business community both in its own enlightened self-interest and for reasons of broader social responsibility

Collectively these internal pressures are now sufficiently powerful to sustain the process whether or not overseas interests engage or disengage from SA. Thus the real issue is whether this process will be violent or relatively peaceful

7) Since the declaration of the partial state of emergency, organised business has played an even stronger role.

(a) Accepting the need to restore law and order in parts of SA, business

made it clear publicly that security action alone will not resolve the serious conflict in black townships

Such action must also be backed by a package of substantial reforms to recognise black aspirations and to redress legitimate grievances

Real negotiations in the political and industrial relations spheres are the key to a return to an orderly SA and to stability in our townships

(b) A number of meetings were held with senior Cabinet members and the State President to exchange views and to discuss alternative courses of action

(c) In an official reaction to the financial crisis of confidence which led to the closing of the forex markets and the stock exchange, organised commerce and industry reaffirmed their strong support for a process of peaceful accommodation of the political, social and economic aspirations of all South Africans regardless of race, colour or creed

They again stressed the vital importance of negotiation with all accepted black leaders "even if some of these are currently in detention" and offered to government their negotiating experience and expertise gained in the formative years since 1980, during which the new labour dispensation (to accommodate legalised black trade unions) had to be established

They also indicated their willingness to mediate between and among various leaders and groups in the country, both black and white, in order to get a serious negotiation process going which will involve a new constitutional dispensation for all

8) Against this background, organised business in SA is engaged in orchestrating an even more active strategy for the private sector to contain a number of inter-related elements

(a) There is a need for establishing an "SA business charter" outlining, against the backdrop of a number of public statements in this regard, the full set of objectives and principles for power-sharing and black advancement to which the business community is committed in pursuing its own action programme

(b) Serious direct negotiation between black leaders and government needs to be preceded by an important pre-negotiation phase during which the emphasis should fall on confidence building through mediation and conciliation

Rushing through this pre-negotiation phase could seriously jeopardise

the effectiveness of subsequent round-table bargaining

This is where organised business could play a crucial role in behind-the-scenes mediation aimed essentially at promoting greater realisation in order to bring the various parties closer together

Agenda-setting needs to be done and basic assurances and/or conditions established which may well be necessary before serious negotiation can begin

(c) An effective economic development strategy aimed at maximum employment and wealth creation in the short and medium term is an urgent necessity

This will involve a change in emphasis towards a policy of positively promoting orderly urbanisation involving action across a wide range of issues such as privatisation deregulation, the removal of influx control and the pass laws, developing the urban informal sector, rural development and a more cost-effective decentralisation policy

Such a policy should be integrated with a broad supply-side approach to economic reconstruction to promote economic growth without eroding the competitiveness of industry or unduly stimulating inflation

(d) Further important elements that need to be co-ordinated are a regionally-orientated programme to upgrade the quality of life in black towns, and a non-discriminatory and vocation-orientated education policy which will open opportunities for black advancement and remove the constraints on productivity and competitiveness

The overall aim of this action programme is to restore confidence in SA as a country and to permit it to regain its place among the great democracies of the world

9) In the view of business, the most effective role for foreign interests to play in our country is to latch on to and support constructively the internal processes and developments which are moving irreversibly, and under their own power, in the direction of real reform

Effective disassociation from abroad will make our contribution to the reform process more problematic, mainly because of the increasing domestic polarisation which will result from international isolation

Disassociation will not stop the organisations from pursuing their constructive role, since what is at stake in SA is too important

But there is no doubt such actions would make it more difficult for business to achieve the universal objectives outlined in this statement

While these indigenous processes continue, overseas interests should indeed actively support selective but aggressive engagement rather than total disengagement from the country, on condition that at least a majority of blacks are satisfied real progress is being made

Assocom lays it down in

no uncertain terms to PW

Get rid of apartheid!

133 S. Times 20/10/85

SCRAP apartheid and all racial discrimination.

This was the urgent call to the Government from the Associated Chambers of Commerce (Assocom) 1985 congress in Cape Town this week.

Speaker after speaker at the congress castigated discrimination and the slow pace of reform. Political criticism reached a peak during discussion on reform, but was prominent even where economic and business matters were discussed.

Proposing a motion urging accelerated reform, Denis Creighton, of the Port Elizabeth Chamber of Commerce, said: "Let us remove from the statutes the Group Areas Act, influx control and all other legislation discriminating on grounds of race."

Shooting

Mr Creighton said reform must not improve discriminatory laws. It must remove them.

Phillip Krawitz, of the Cape Town chamber, urged the "total illegality of any vestige of apartheid. Ban discrimination. Make it illegal".

Andrew Plele, also of the Cape Town chamber, criticised "excessive force" being used by the police and asked: "How can our Government be serious about reform while it condones the shooting of our school children?"

"Within 10 minutes of this hotel the police have been using Trojan-horse tactics and live ammunition to try to control stone-throwing youths."

By David Carte

Kunene, mayor of Soweto, said the ANC wished only to destroy South Africa. That was why it condemned black moderates as puppets.

R A Joseph, of Krugersdorp, advised Bishop Tutu to confine his comments to "the holy book". He said there was a place for people such as him — on an island just off Cape Town. Delegates were outraged by Mr Joseph's remarks and he later withdrew them.

This week's harangue from Assocom members followed a year of hectic political activity, some of which has not endeared organised business to the Government.

All employer organisations were excluded from the reconstituted State President's Economic Advisory Council. The Deputy Minister of Finance, Mr Kent Durr, was the only Cabinet member seen at the congress, and he was present only at the official opening.

After urging a "yes" vote in the referendum on the new constitution, Assocom, which represents 23 000 businesses large and small all over South Africa and whose members employ up to two million, has swung hard left in the past year.

This is because it is not satisfied with the pace of re-



ROCKY RIDGWAY
"Action is coming"

form in a deteriorating political and economic environment.

It is concerned about the increasingly imminent threat of sanctions, and that business is seen by blacks as being in league with the Government on apartheid.

It also fears that, as blacks assume more political power, they will reject free enterprise in favour of socialism.

Assocom is expected to follow up this week's words with action. A "task force" to push along reform and an outreach to businessmen of other races right across the eco-

nomy are some practical possibilities.

The new president, Rocky Ridgway, said there could be an announcement in the next two weeks.

Before this week's slings and arrows, Assocom, together with other employer organisations, told the Government to charge or release detained union leaders. They also told the State President that reform was going too slowly.

Having urged reform in the past, Assocom felt obliged to state what it meant by reform. For Assocom, Professors Jan Lombard and J du Pisanie, of the University of Pretoria Bureau for Economic Analysis, prepared a 120-page report recommending that blacks be brought into political and economic participation in a federal structure.

In the past year, Assocom has also hammered the Government over its excessive participation in the economy, excessive taxation and State control over business and personal life.

On the other hand, together with other employer organisations, it made representations, first to Senator Edward Kennedy and later to the United Nations, against sanctions and the political and economic isolation of South Africa.

Appeal for halt

One delegate asked: "Why are we governed by incompetent men while Nelson Mandela is in prison and Oliver Tambo is banned?"

At this Harold Groom, who was elected deputy president, had to appeal for a halt to "strong and intemperate rhetoric".

He warned that this "may stir the gut and entertain but does not facilitate solutions".

He said emotional attacks would aid in the process of polarisation and play into the hands of those who did not want peaceful reform. "We need cool heads," he said.

There were only two reactions from the right. Edward

See Page 4

BUSINESSMEN in the Eastern Cape's 'Boycott Belt' are demanding that the Government transfer control of the townships from the Eastern Cape Development Board to the various white local authorities.

Port Elizabeth, East London, Queenstown and Grahamstown businessmen say that if the local authorities control the townships they would have a greater say in improving them.

Other demands by business leaders include:

- * Negotiations with recognised black leader.
- * Clarity on exactly where the political and socio-economic future of black South Africans lie.

- * A single and equal education system for all.

- * Free trading rights for all with no strings attached.

- * The Government to note the business sector's concern as to the presence of the SA Defence Force in the townships.

- * The Government to state the emergency situation as possible.

- * The improvement of the townships to be substantial and improved.

Business leader and speaker about the need for political decisions to be

**Back
Cape
Losses
Get
Govt**

released from detention do have no formulated ones in terms of demands because they need to be said. Port Elizabeth businessmen said there is no chance of a change being released.

The Federation of SA Trade Unions has called off the consumer boycott in Matieland because the profits had achieved the aim of bringing it over to the BTP side. The plan is to have

15 000 metalworkers lose jobs as industry reels

By Mike Simona

More than 15 000 metal industry employees lost their jobs in the first half of 1985 as the industry continued to reel under the recession.

The drop in employment has been accompanied by a reduction in output of as much as 32 percent in some sectors, according to the Steel and Engineering Industries' Federation of South Africa (Seifsa).

In its review of the first six months of 1985, Seifsa said the decline in the number of employees from 454 000 at the end of 1981 to 355 000 this year confirmed the continuing downturn in the metal industries.

Despite some improved export performance in the steel and secondary steel industries and ferrochrome being able to maintain 1984 export levels, output statistics had generally confirmed a further slowdown, with capacity utilizations below the average levels for 1984.

Sectors recording major drops in output were the automotive component industry (32 percent), electrical machinery (21 percent), and machinery — including farm machinery and machine tool industries — (18 percent), said Seifsa.

In contrast, the major sectors of iron and steel industries were supported by increased export volumes and showed gains in production levels.

While there was a sharp drop in the demand for domestic steel products, some recovery was expected towards the end of the year.

The engineering and metal fabricating industries continued to face difficulties in securing adequate volumes of short-term work to utilise production facilities satisfactorily.

Also reported to be critically affected is the shipbuilding industry, which has faced the recession and a worldwide slow growth in shipping activity.

Despite South Africa's underlying economic situation appearing sounder than a year ago, activity levels were expected to remain low throughout the remainder of the year, Seifsa said.

Dealing with labour costs, Seifsa said the 1985 industrial council agreement for the industry — which guaranteed increases ranging from 14c/hour at the bottom to 24c at the top — represented an average rise of about 7 percent.

AREA B: Bellville
pe, Uitenhage, a
Durban, (excluding t
Inanda and Pinet
Newcastle, Alber
Germiston, Johanne
Nigel, Oberholzer,
Springs, Vanderbijl

POLITICAL COMMENTARY

By DAVID BRAUN



How the industrialists plan to help

own, The
Strand;
ca Ltd),
ick and
Delmas,
ersdorp,
depoort,
erboom.

133
2/1/85

Industrialists big and small this week emerged as a loud voice in the domestic political debate.

At the annual executive council meeting of the Federated Chamber of Industries in Durban, businessmen were not pulling their punches.

Quite simply, in their view, the Government had made a muck of its management of the country, and what was needed was a multi-pronged approach by the business sector to create the right conditions in which to set things right.

"Business is the business of business and not politics. Yet the business community now realises that there is an enormous threat to its very existence, which can only be removed if fundamental political reforms are made in the structure of South Africa," said FCI president Mr John Wilson.

In the first instance, the FCI, expressing its doubts that the Government had yet comprehended the enormity of the economic problems facing the country, proposed a sweeping action plan to put the economy back on its feet.

This involved, among other things, substantial tax cuts and the privatisation of state assets.

MORE SIGNIFICANT

Even more significant though, was its venture on to political ground — a top-level thrust toward getting the entire business community to endorse a plan to get the political talks off the ground. This would start with the subscription to a business charter, a kind of bill of rights which would clearly establish the bona fides of the private sector in the role of mediator in the negotiation process.

Before looking at how the FCI proposes to go about this, it is of interest to note how important it is.

The industrial sector, which the FCI claims to represent almost entirely, contributes 25 percent of the country's total GDP.

The FCI itself is made up of about 10 000 members, including on its corporate forum the biggest company names in South Africa, such as Anglo American Industrial Corporation, Rembrandt, Barlow Rand, Barclays, Nedbank, Standard, Tiger Oats and the major oil companies.

The men who lead it are themselves people of considerable business standing. Mr Wilson, for example, is executive chairman of Shell South Africa.

His three deputy presidents are Mr Lance Japhet, public affairs director of the Premier Group, Mr R G Nicholson, deputy chairman of General Tire and Rubber Company, and Dr Hugo Snyckers, managing director of the Noristan group.

Mr Norman Duncan, the chairman of the FCI board of management, is deputy managing director of the Tongaat-Hu-

At the FCI banquet on Wednesday night, Mr Wilson outlined the role that all businessmen could play.

Essentially, he said, the function of the business community was catalytic. Business was not one of the parties which would take its place at the negotiating table. Its role was to help identify and to get the various negotiators to the table.

This involved building consensus, a definition of the rules which would ensure the integrity of the negotiation process itself, and agreement that the various parties would abide by the outcome of the negotiations.

The business community, as an independent but vitally interested agent, could help define these terms, which would then have to be agreed to by all parties entering the negotiation process.

"We in business have had considerable experience in negotiating the establishment of the new industrial relations structures, proposed by the Wiehahn Commission, with very much the same kind of people as will ultimately be around the political negotiating table that we are talking about," Mr Wilson said.

The major role of the business community was to ensure that the feet of the all the country's political leaders were placed firmly on the bottom rung of the ladder of negotiation, he said.

OBSTACLES

The business action plan in this regard entails the identification and circumvention of obstacles in the way of serious black/white negotiation on power sharing at all levels, developing a business charter, acceptable to the major private sector organisations which sets out their view of a just and equitable society, strategies to remove the remaining statutory cornerstones of apartheid, restore the right of orderly protest and address the grievances of black pupils, and a plan for economic reconstruction to address both the present crisis as well as provide greater access for blacks and more prospects for black advancement.

These very ambitious goals still have to be agreed upon by the FCI's sister organisations, Handelsinstituut, Nafcoc and Assocom.

There will be intensive behind-the-scenes lobbying over the next few weeks to at least get them to contribute to and agree upon the business charter.

Once that hurdle is cleared business will have the difficult task of persuading the various protagonists that it can be trusted, let alone heeded.

But then, in the words of one FCI conference delegate this week, "if not us, who, and if not now, when? And if we don't concern ourselves about these things, soon we may have no business to worry about at all!"

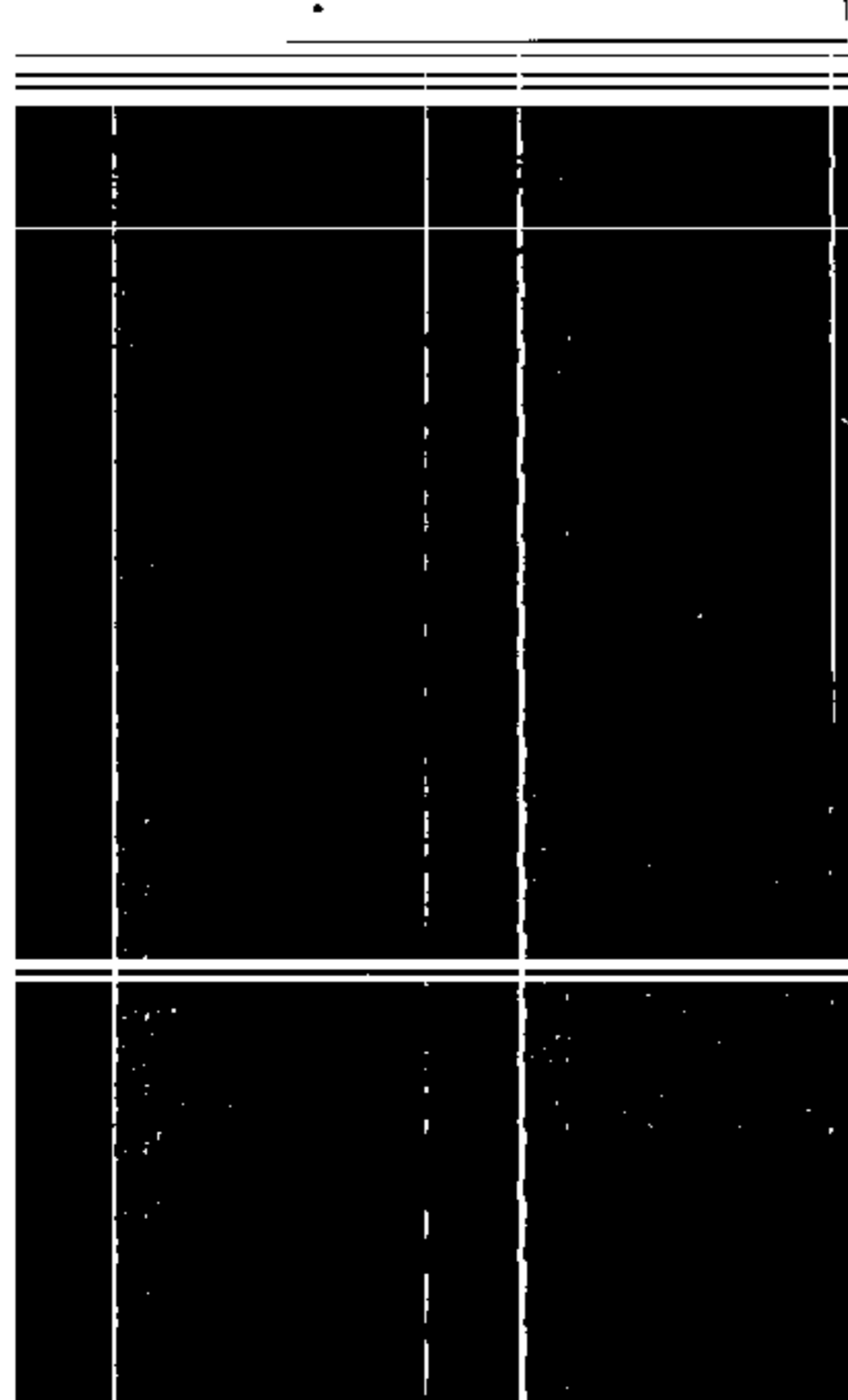

'Siege economy' not South Africa's solution

Motlana slams business for not speaking out sooner

FCI calls for urgent action

133
Slaw
30/10/85

By David Braun,
Political Correspondent

DURBAN — One of the country's most powerful private sector organisations yesterday called for an urgent and sweeping economic action programme to put the country back on its feet

At its annual executive council meeting here, the Federated Chamber of Industries called for substantial tax cuts and a re-evaluation of the country's infrastructural requirements as well as privatisation of State assets as part of its plan.

It said there was a lack of confidence in South Africa's ability to find acceptable solutions to its political and economic problems

The partial standstill of foreign

debt repayments had precipitated a credit crisis which meant that the country had to make major capital transfers to pay off foreign debts which would have a negative effect on growth and employment

Seriousness

It was also doubtful as to whether the Government fully understood the seriousness of the problems which South Africa faced

The Government could not address these problems without a convincing plan for economic reconstruction backed by credible political reforms, the FCI resolutely

South Africa was going to be locked into a regime of low growth, stagnating employment,

balance-of-payment problems and inflation

A "siege economy" and growing isolationism was not a solution to the country's problems

The FCI had, therefore proposed the following economic action programme

- South Africa must remain publicly committed to market related policies in an essentially open economy
- In order to initiate a supply-side recovery, a high-impact tax cut is required to stimulate consumption and to initiate economic activity through the removal of the taxation surcharge on individuals, with the eventual substantial reduction of marginal rates on income tax, and an immediate substantial cut in the company tax rate

Inflation

- A removal of the 10 percent surcharge on imports which was causing major cost inflation.
- Firm control over current Government expenditure
- A suspension of the tax proposals to fund the Regional Services Councils until after the Margo Commission into taxation had reported
- A commitment to a fundamentally open exchange rate policy
- A firm directive to control escalation in administrative prices by requiring parastatals to re-evaluate their financing, expansion and tariff policies in terms of normal accounting principles
- The privatisation of State assets to raise additional revenue

Political Correspondent
DURBAN — Soweto civic leader Dr Nthato Motlana delivered a stinging attack on the business sector here today for failing to speak out and act timeously on behalf of the country's blacks.

Dr Motlana told the annual executive council meeting of the Federated Chamber of Industries that big business should start and support new businesses owned by blacks, so as to make the economic pie bigger

"Big business felt comfortable at the Carlton conference when it met with the then Prime Minister — and no blacks were invited there," he said

"Again at the Good Hope conference, big business felt even cosier with the Prime Minister. Some blacks were invited, but perhaps as an after-thought"

TRUE COLOURS

He said the business sector chowed its true colours when most of it voted "yes" in the referendum on a constitution which excluded blacks

When the state of emergency was declared organised commerce and industry welcomed it — "yet since then blacks had been beaten, their children detained and their daughters raped"

Dr Motlana said "You re-trench thousands of people. Yet in some cases, the managing director gets the latest Mercedes or the directors go off to company game farms or on trips overseas"

"Suddenly because of the unrest, and because your business confidence is sagging generally, you panic

"It is only now that you come running to us. Some even start running to Lusaka and some run to the media"

Business threatened

Political Correspondent

DURBAN — "The business of business is business and not politics. Yet the business community now realises that there is an enormous threat to its very existence, which can only be removed if fundamental political reforms are made in the structure of South Africa."

It would be difficult to sum up more succinctly than that the urgency which has of late galvanised the business community

The words were spoken this week by the president of the Federated Chamber of Industries (FCI), Mr John Wilson, during his presidential speech at the organisation's banquet here

Mr Wilson summed up the mood of this important business group's confer-

FCI president

ence by making a hard-hitting speech in place of a traditional review of the year's activities

The three-day conference of the FCI's executive council was characterised throughout by the same tough business-like sentiment and language

"To be honest," one delegate said privately during a tea break, "the political and economic situation is affecting our self-interest, and when self-interest is being hurt you stiffen your attitude and become militant"

In an interview, Mr Wilson said the conference was marked more by an atmosphere of restlessness than militancy

"This organisation is apolitical, we are not going to back any political

horse But we are trying to tell people that everyone is going to have to pull together if we are to get our country out of the hole it is in. We are not in a rut, but in a very deep hole

"That is why we have presented the country with an economic and a political package, strategies which call for a national effort to solve our problems," he said

The FCI voted for an economic action plan which called for substantial tax cuts and the scrapping of the 10 percent import surcharge. It further called for an adherence to an open economy, firm control over Government spending, effective privatisation and a careful evaluation of the infrastructural requirements of the country.

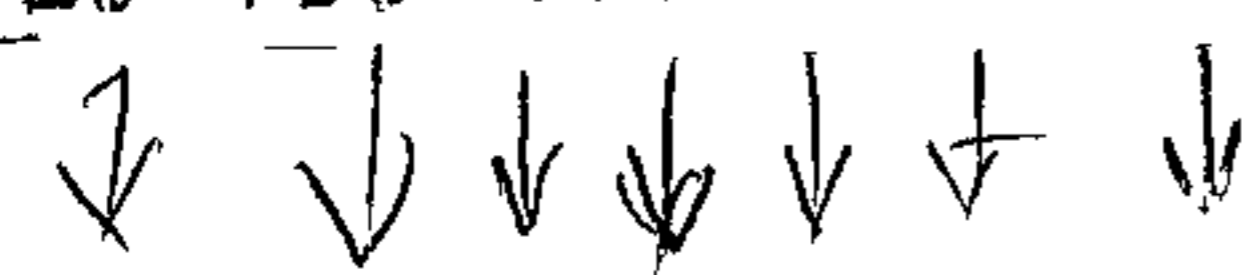

U C 11/25/11/18 23/11/18

Balance vital for industrial councils

LABOUR AFFAIRS
DICK USHER

BALANCE is the key word in the Department of Manpower's initiative to re-examine the industrial council system, according to Dr Piet van der Merwe, director-general of the department.

That balance must fall between protection and opportunity and would ideally be found by employer and employee parties within industries without government interference.

The department has invited comment and representation on the industrial council system and has been holding meetings round South Africa with councils to test views. At the same time there has been criticism suggesting that the initiative poses a threat to the system.

Dr van der Merwe said it was not the intention to destroy but to improve.

"Industrial council agreements can be and often are extended to non-parties if the Minister deems it necessary," he said.

"But the problem is whether agreements should be extended to people who had no part in negotiating them. Often these employers are black or coloured who argue that it is impossible for them to get started under the conditions the industrial council imposes.

"Although there is provision for exemption, they argue that councils often refuse to grant it and the Minister has asked whether voluntary tenancy agreements without representation and whether the industrial councils should not decide what criteria should be used to decide on exemptions.

"We get situations where the industrial council for an industry comprises of only 10 percent of employers. Is it fair that their decisions should be made binding on the other 90 percent?"

But employers could not be allowed to exploit workers.

The industrial councils besides setting minimum wages, often administered provident pension and medical aid schemes all of which protected and benefited workers.

"But we must also find ways of encouraging small entrepreneurs and so we have to find a balance between protecting workers without destroying job creation," said Dr van der Merwe.

"We believe that balance must be found by the people within the industry. Conditions differ from industry to industry and from time to time within a particular industry and the people who know their business best should be the people regulating conditions.

"But at the same time there must be an avenue for appeal to an impartial arbitrator for exemption from agreements.

Dr van der Merwe said the deadline for comment had been extended to December 15 to get as broad a spectrum of comment as possible.

"The decision on what will be done rests largely with the balance of opinion we receive."

Secret apartheid talks

or reduced South African business links in the past year, says Holman

About 300 US companies operate in South Africa and have an investment of more than R7,000 million

According to Holman's informant, the London talks were attended by the chief executives of four of the largest US corporations Mr Roger Smith of General Motors, Mr Michael Blumenthal of Burroughs, Mr Raleigh Warner of Mobil and Mr John Reed of Citibank

The South African delegation included Mr Gavin Rely of Anglo American and Mr Mike Rosholt of Barlow Rand

Mr Rosholt is reported as saying in Johannesburg that the meeting was part of the continuing efforts by business leaders of both countries to work out a positive business contribution to solving South Africa's problems

Greater business role

The discussions were organised by the US Corporate Council on South Africa, which was formed in September and consists of executives of companies with interests in South Africa

Officials of the US companies have refused to discuss the London meeting, though General Motors described it as "productive"

The broad purpose, according to businessmen close to the talks, was to continue efforts to draw up an alternative strategy to economic sanctions and disinvestment, and to discuss a greater business role in efforts to bring about change in South Africa

Though not directly linked, the initiative coincides with efforts by the Urban Foundation to win financial support from US and British companies

Chief executives of South African, US and British companies are increasingly concerned at the growth of the sanctions and disinvestment lobby

US bankers warn SA to speed up reform or else...

Wall Street sources say US banks have informed Pretoria privately that the Government must move more rapidly towards reform before they can agree to any re-scheduling of South Africa's short term debt, estimated at about R30 billion

"The banks are being very firm, but they don't want to go public with their stand because this is essentially a political issue and the publicity could run any chances of a compromise," one Wall Street broker said

The urgent telex sent to Mr Botha last week by representatives of the 186 top American companies in South Africa was the first direct move in what is expected to be a greater involvement by US corporations in pressures on Pretoria for reform.

Signatories to the Sullivan Code of practice — representing the largest and most influential US companies — telexed Mr Botha on Friday calling

for steps to "lower tensions" in the education crisis and reduce the likelihood of continued schools boycotts

Mr Pat O'Malley, chairman of the Sullivan group's Education Task Force and a member of its executive committee, told reporters conciliatory gestures were essential if further school boycotts and other actions were to be avoided.

The telex sent on behalf of the Sullivan signatories expressed concern about the effects on "thousands of young lives" and the accompanying threat of unemployment

Mr Franklin Sonn, president of the Cape Teachers Professional Association and rector of the Cape Peninsula Technikon, yesterday welcomed the action by the Sullivan signatories, adding he hoped the Government saw their involvement as one of "compassionate interest" responded positively

Sapa

Top SA and US businessmen draft a strategy to aid blacks

The Star Bureau

Executives of leading South African and United States companies held a secret meeting in London last week to draw up a joint strategy to challenge apartheid.

The strategy includes paying for a range of educational, housing and small business projects for blacks.

Details of the secret meeting have leaked out in Washington

Michael Holman, writing in the *Financial Times*, says the talks are being seen in the American capital as part of "a major effort to present a constructive alternative to the growing move towards disinvestment from South Africa by US companies"

Coca-Cola, International Harvester and Phibro-Salomon are among 18 companies which have ende

1333
5 Feb 18/11/85

INDUSTRIAL REL. → GENERAL

132

1986

JAN — OCT → -

Improved labour relations predicted

Mercury
132
9/1/86

Labour Reporter

INDUSTRIAL action and production time losses through strikes should decrease during 1986, according to a leading labour expert in South Africa.

This expected significant about-turn in industrial relations comes after an increase of 700 percent in the number of man days lost through strikes over the past seven years.

Labour consultant Andrew Levy made these predictions in his annual report on labour relations

However, he is cautious and qualifies his optimism saying the levelling off in the number of man days lost is likely with the possible exception of mining.

Conservative estimates put the number of man days lost through strikes on mines during 1985 at about 250 000. The motor industry also recorded the highest number of strikes for many years, 50 percent of which were linked to wage demands.

Wage demands contin-

ued to be made forcibly notwithstanding the loss of 22 percent of jobs in the motor industry since 1982.

The swing towards wages as a strike trigger noticed last year would continue as would the swing away from dismissals, he predicts

The report credits employers with greater maturity in handling disputes

January 1986

132

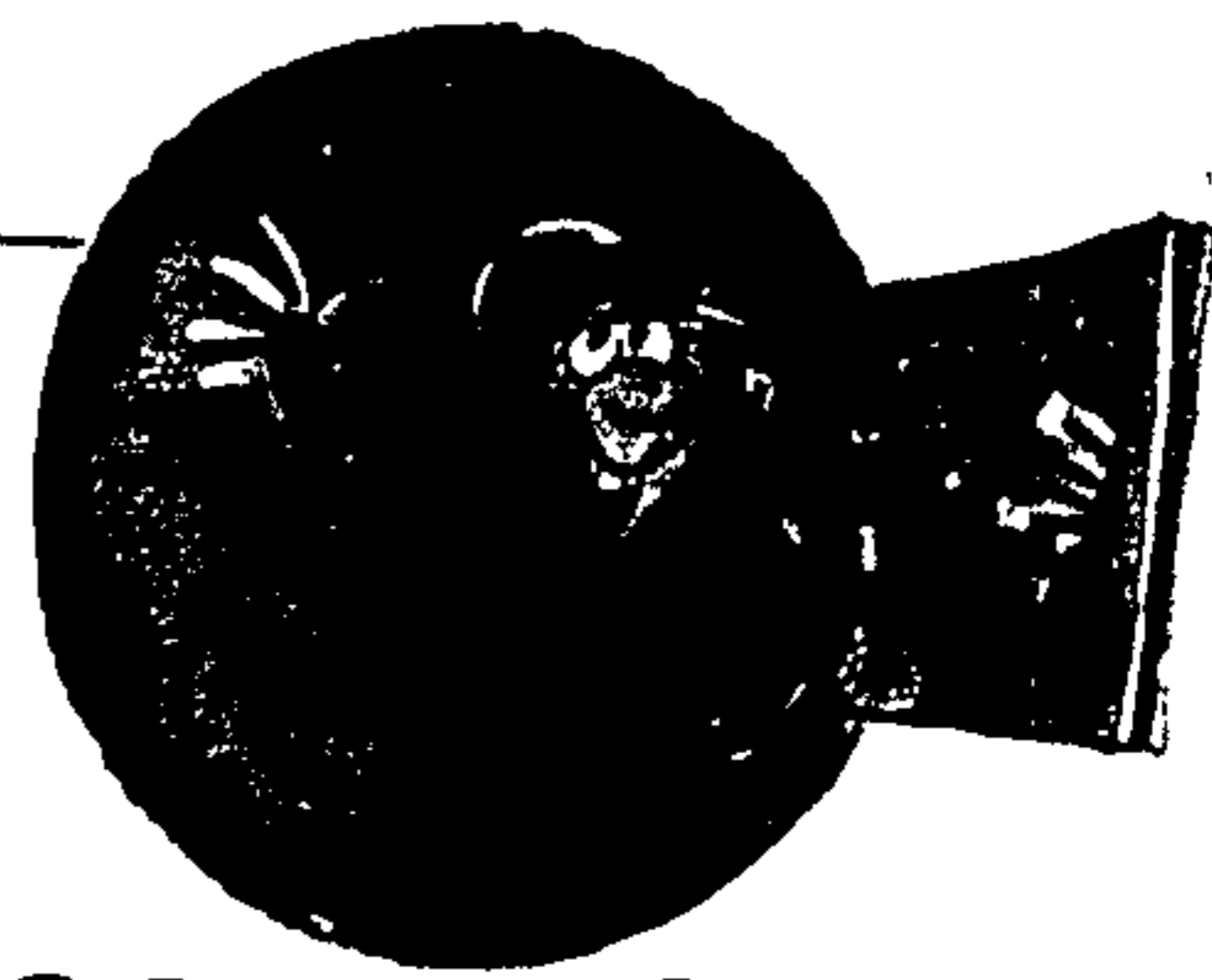

BRUSSELS - An alternative teaching method was introduced in Belgium on 16 July 1985 in an attempt to bridge the gap between theoretical knowledge as acquired through conventional schooling and the practical knowledge needed in industry

The new part-time teaching method (education with a limited syllabus), as opposed to the rich traditional education system - based on a system formulated and adapted through the course of history - must still be considered as experimental as it is only through time that problem areas will be identified and correspondingly rectified

When the "experimental secondary education with a limited syllabus" was first announced 48 centres throughout the country were opened to accommodate it, but after only a year of experimentation it was found that only 38 of these centres received satisfactory results as far as students' registrations were concerned. Considering that the new education method is aimed at educating the middle-class between ages 15 and 18 in order to comply with the Flemish law requiring all school-leavers to be not younger than 18 years, the experiment cannot as yet be considered successful.

Limited syllabus education's main aim is to merge labour with education. The objective is that theoretical learning at school should be part-time while the rest of the time is spent in the labour market. This is also a requirement which is directly supported by the industrial training contract of Belgium.

But those who institutionalised the new system said that the most important thing to be taught resides on a sociological basis and that any educational system should therefore aim at developing independence within the adolescent. Thus seven hours a week are spent on general education - to prepare the youngster for the complex society awaiting him - while eight

Belgium merges its labour and its education

hours a week are set aside for trade training - aimed at directly preparing the scholar for a professional career. Apart from this the scholar is also available on the labour market and it is expected of him to hold a part-time job while receiving part-time education

After a year of part-time system, a press conference was held at Brugge during which it became apparent that although some scholars performed well at school they still experienced difficulties in coping with practical work in the industrial sector.

It was also discovered that the law of supply and demand overrules the ideological conciliation of labour and theory. Due to an already high unemployment figure, it was estimated at the conference that about 70 percent of the part-time students were

unemployed

In view of this it seems almost senseless to continue with a system which will supply an oversaturated labour market with even more labourers when there is no way of accommodating them. Supporters of traditional education methods now argue that full-time studies of employees already working in the industrial sector will be more beneficial. The feeling is that full-time training should be included in an initiative plan within the industry.

But despite the gloomy prospects of unemployment, it is still believed that the new educational system can greatly benefit Belgian society by reconciling theory with practice. And the way to do this, it is said, is to clarify the form the new system will take

Redundant buildings given lease of life

LONDON - A new industrial revolution is quietly taking place in Britain's countryside as hundreds of redundant old buildings, which would otherwise fall into disrepair and become a liability to their owners, are renovated for rurally-based industries.

In the past year alone, over 1000 buildings have been restored in conjunction with the Council for Small Industries in Rural Areas (CoSIRA).

Disused buildings ranging from former military establishments and farm buildings to country mansions have been converted to house groups of small businesses

One typical example is North Street Farm Workshops in the village of Stoke-sub-Hamdon in western England. The workshops were formerly old farm buildings no longer required by their owner, the Prince of Wales' →

MORE black trade unions are resorting to the Industrial Court (IC) to resolve industrial relations disputes and labour unrest.

• An application for the reinstatement of 500 strikers dismissed from Metal Box in Rosslyn, Pretoria, is to be heard in the Pretoria Industrial Court on January 31
• The Pretoria Industrial Court will today hear an application for the reinstatement of 18 workers dismissed after a sit-in at the Brits Modern Supply company

WORKERS' DIARY — By JOSHUA RABOROKO

• The Media Workers' Association of SA (Mwasa) is to face the management of Drum Publications at the Industrial Court in Pretoria this week over the dismissal of its members
• Mwasa is also preparing papers to be served on the South African Broadcasting Corporation after its members were allegedly re-trenched

Gawusa

• An unusual Industrial Court application has been filed by a fired receptionist, who is suing her former employers (36 advocates) for allegedly committing an unfair labour practice
• Several labour lawyers believe that recent court decisions show workers the collective protection they can get as union members
• The General and Allied Workers' Union of SA (Gawusa) intends asking the Industrial Court to reinstate several members fired from a Johannesburg clothing shop after their white boss had allegedly asked

NUM

• The Bophuthatswana Manpower Ministry has established an Industrial Board to make recommendations about conditions of service in the homeland's mines
• This is a sequel to the sacking of about 20 000

Ccawusa

• A Johannesburg director, Mr Taco Kuiper, has appeared in a Johannesburg Magistrate's Court for failing to reinstate or pay dismissed Mwasa members after the Industrial Court ruled in their favour He

More black unions turn to ICs to settle disputes

will appear again on February 27
• The Ford assembly plant in Strandale, Port Elizabeth, is to be closed in the second half of this year. The move will affect 950 salaried and hourly paid workers
Managing director of the Samcor Group, Mr Spencer Sterling, announced this week that production of the Sierra range will be transferred to Samcor's plant in Silvertown, Pretoria

Cosatu

• The Commercial, Catering and Allied Workers' Union (Ccawusa) is holding discussions with managements of three OK Bazaar stores in Pretoria, Woolworths in Roodepoort and Checkers in Groblersdal over strikes which took place last week
• This year companies will retrain more workers than before, trade union sources have predicted. The forecast is supported by the Institute for Industrial Relations which says 20 000 workers were retrained last

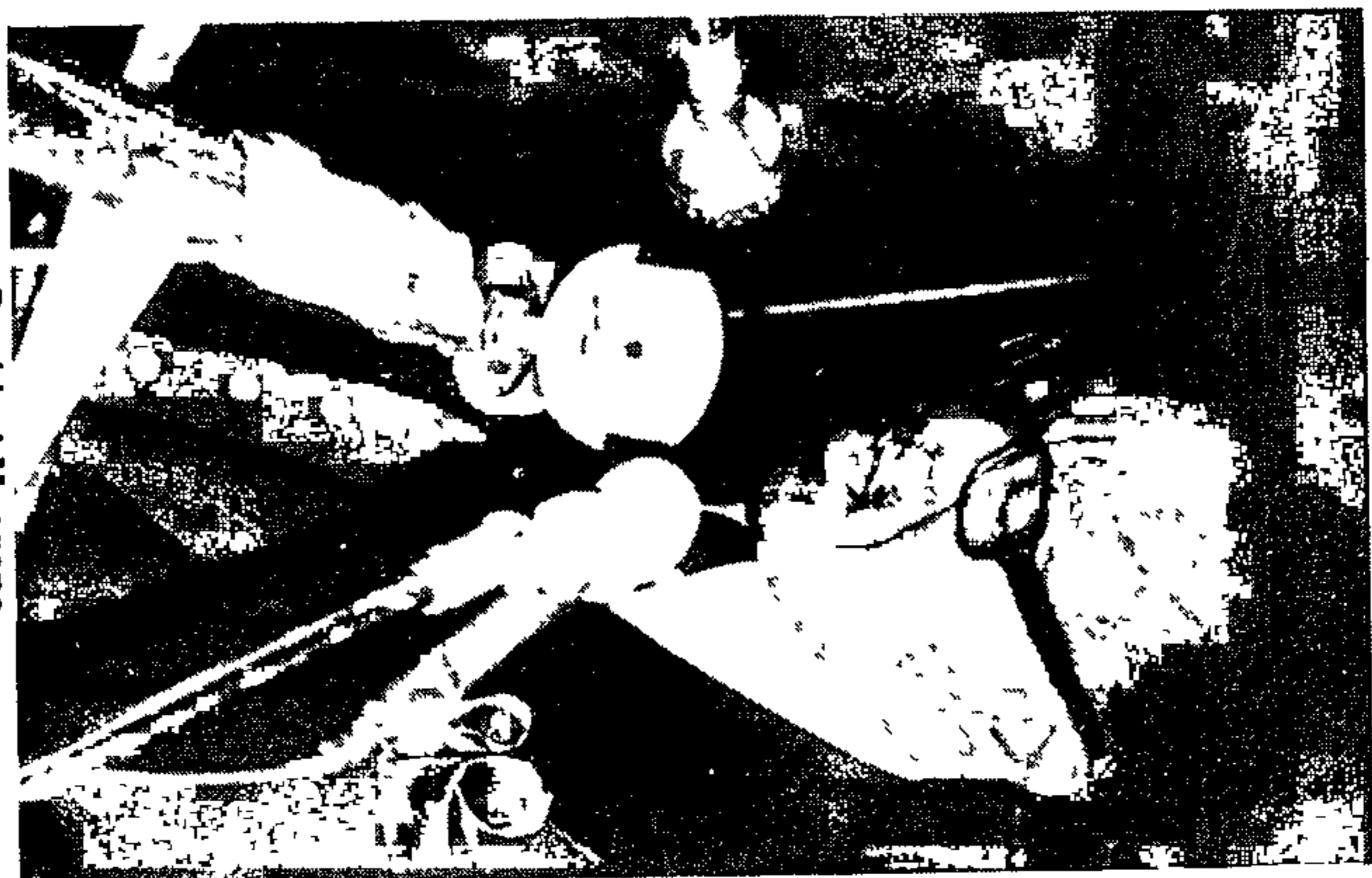

President Mangope

But, it adds, the true figure may be greater as some re-trenchments were not reported
Estimates by the SA Labour Bulletin, an independent trade union publication, are much higher. It reports in a

survey that in the engineering and metal industries, 2 000 workers were being retrained each month — 24 000 in these sectors alone last year
• The Transvaal region of the Congress of South African Trade Unions (Cosatu) has resolved to launch a boycott of Sun City International Hotel in Bophuthatswana. The resolution was taken because the hotel supported President Lucas Mangope's government which has barred SA trade unions from operating in the territory, the union said
The resolution was also taken because President Mangope's government supported Gencor in firing workers at the Impala Platinum Mine recently. Members still have to discuss the resolution
• The Cosatu central committee meets in Johannesburg on February 7 to discuss various issues, including proposed action against Gencor
• The Cosatu Transvaal region will hold another meeting in Germiston tomorrow.

FCI presents major reform package to Govt

27/1/86
132
Mercury

JOHANNESBURG—Far-reaching political and economic reform proposals have been presented to the Government by the Federated Chamber of Industries (FCI).

The proposals, which have also been circulated to other national employer bodies and foreign embassies, are contained in a charter of social, economic and political rights prepared by the FCI and in a comprehensive action programme for reform at all levels.

The FCI says there are problems in obtaining agreement on the basic pre-conditions required before real constitutional negotiations can begin, as well as on the issue of which parties should sit

around the negotiating table.

It says such pre-conditions could include

An undertaking by Government to abolish statutory race discrimination in all legislation,

Power sharing at central level in a single institution,

The abolition of influx control and the Group Areas Act,

Housing sites

A return to the basic norms of the South African common law, thus reaffirming the rule of law, and

The release of political prisoners from detention.

The FCI says a major prerequisite for effective business mediation is for

the Government substantially to increase its 'currently low domestic and international credibility'

It says among the most significant short-term steps that need to be taken are the provision of affordable serviced housing sites for urban blacks on a substantial scale, the immediate implementation of freehold title, elimination of forced removals and the rapid opening of central business districts to all races.

The business community's mediatory role would include organising conferences, sponsoring research programmes and assisting overseas government emissaries.

'As regards constitution-making, business can assume the role of promoter and propagator of those constitutional models which in the Western democratic tradition of open, free enterprise societies have proved to provide the most solid guarantees for individual rights and freedoms and protection against State authoritarianism,' the FCI says.

Stimulate

Discussing what it sees as the economic initiatives which are needed to put the country back on its feet, the chamber says a national economic strategy providing greater clarity about the future pattern of economic development is needed.

'A clear and explicit policy framework would do much to stimulate business confidence and new investment in the country,' it says.

It says the major priorities which need to be addressed are the future pattern of industrial and economic development, employment, creation, inflation, and

economic opportunity and living standards of all the population groups.

Other economic-related issues which it focuses on in its action programme are the need for a 'new positive urbanisation strategy' and, going hand-in-hand with that, privatisation and deregulation.

'Government has already accepted this policy approach and business will assist in its effective implementation by marshalling whatever resources are required to support this important initiative.'

Emphasis

It believes 'entrepreneurship by anyone should be allowed in all business areas and all legal restrictions pertaining to race should be removed when licences, permits and other dispensations are considered. Movement of all people should be free and unrestricted in order to allow them to seek job opportunities and to create work mobility.'

Regarding the Government's short-term economic policy of moderate stimulation of the economy, the chamber agrees with this approach but says the emphasis should fall on lower interest rates interlinked with a cut in direct taxation.

To achieve this, the FCI believes South Africa must publicly remain committed to market-related policies in an open economy and must remove the 10 percent surcharge on imports.

It says a firm directive is needed to control escalation in administered prices by requiring parastatals to re-evaluate their financing, expansion and tariff policies.

(Sapa)

● See Editorial Opinion

e
a

Boarder in industry backlogs

22/1/82

DISPATCH

(132)

Dispatch Reporter

EAST LONDON

Members of the Boarder Chamber of Industries will be urged to uphold the principles contained in the Federated Chamber of Industries' charter which calls for equal social, economic and political rights.

This was announced yesterday by the president of the BCI, Mr John Rich

The FCI charter which has been presented to the government, calls for far-reaching changes in South African society and commits the organisation to a mediatory role in bringing about negotiations for power sharing in South Africa

It supports principles of individual freedom, land tenure, property and residential rights for all in a system of free enterprise which is open to all races. It calls for the release of political detainees, mobility of labour and the removal of statutory discrimination, including laws like the Group Areas Act.

The document also calls for universal suffrage and devolution of state powers to place the government close to the will of the people and commits the FCI to a "watchdog" role in scrutinising discriminatory practices

Mr Rich said yesterday the charter was a sincere attempt by South African industry to outline what it believed should be basic human rights in society and to promote these ideas among other sectors of the economy

"To this end, the charter is being circulated locally to all members of the BCI and they are being urged to uphold the principles in their everyday business," Mr Rich said. "It is also being sent to the local chamber of commerce and Afrikaanse Sakekamer

"We hope the charter will also act as a catalyst within government circles to speed up the process of reform

"After all, industry took action in the past to dissolve certain restrictive barriers such as separate facilities and job reservation on the factory floor long before these aspects of legislation were abolished

"We cannot change the laws. We can only, as an organised body, do everything possible to convince those who can change the laws to do so with minimal delay and for the betterment of the country as a whole," Mr Rich said

Business Charter of Rights

Commitment to equality

23/1/86 (132) DISPATCH

EAST LONDON — The Federated Chamber of Industries has undertaken to assume a "watchdog" role in scrutinising discriminatory practices and working for equal rights for all in South Africa

This is one of several undertakings given in a "business charter of social, economic and political rights" which the FCI has presented to the government following consultations which the FCI said had included the ANC and the United Nations

In the far-reaching document the FCI the major representative of industry in South Africa commits itself to the principles of equal political, legal, social and property rights for all and calls for an overhaul of the economy based on growth stimulated by a "supply side" policy of tax reductions and free access by businessmen and workers of all races

Principles spelt out in the charter are

- Equal dignity and rights for all, equality before the law and rejection of discrimination based on sex, race, descent language, origin or religious beliefs

- Protection by law of everyone's right to life

- Rejection of arbitrary

arrest detention of exile and the right of all to fair trial

- Respect for private life and protection and assistance for the family "the natural and fundamental group unit of society"

- Freedom of opinion and expression

- Advocating of national, racial or religious hatred to be banned by law.

- Freedom of movement and residence and the right to travel abroad

- Freedom of thought conscience and religion

- The right to equal educational opportunities and the right of parents to ensure such teaching conforms with their own religious and philosophical convictions.

- Equal rights for all national groups within the community with regard to cultural and language practices

- Equal rights to own property and protection of these rights

- The right to work and free choice of employment.

- Equal pay for equal work and fair remuneration.

- Freedom of association and the right of workers to join trade

unions of their choice

- The right of all to employ people freely and to manage a business in accordance with the rights and principles set out in the charter

- Citizenship for all

- The right of everyone to take part in the government either directly or through elected representatives

- Equal access to public services

- The will of the people to be expressed by universal suffrage in periodic and genuine elections with due regard being given to the protection of minority rights in a multi-ethnic society

- The separation of state powers the independence of the judiciary the supremacy of the legal system the freedom of the press and free formation of political parties

- Government must not be above the law and, through decentralisation and devolution of power, it must be close to the people and their needs

The charter commits the FCI to promoting and implementing these principles by urging industry and commerce to uphold them and by influencing government

and political parties to abide by them

It undertakes to assume "an active role through watchdog bodies and other mechanisms, to scrutinise all discriminatory laws measures and practices"

The FCI also says it will

- Work towards ending turmoil and emergency conditions

- Strive for the release of political prisoners

- Support training and social welfare programmes

- Take measures to abolish racial discrimination

- Work towards peace and stability in the Southern African region and seek international understanding and co-operation

Six years after the introduction of the "W" hour dispensation the author of the reference is blazing trails into areas where reform has not yet to penetrate. Professor Nic Wiehahn has a clear message for employers and is determined that his message gets through. SHERYL RAINE reports

STAR 27/1/86

Wiehahn spells out warning to employers

At a seminar last week on conflict management arranged by the Afrikaanse Handelsinstituut in Vanderbijlpark, Professor Nic Wiehahn, director of the Unisa School of Business Leadership, kept an audience of businessmen spellbound for more than four hours.

The key to his success was the urgency and salience of his message, a high-energy delivery, a terrific sense of humour and an approach which would soften the mind of the most die-hard anti-unionist.

He has the added advantage when talking to the Afrikaner business establishment of being an Afrikaner himself. Using this vantage point, he deftly sketches the history of his people, their trek to the cities and the evolution of their dogmatic management style.

He believes that for more than three centuries we have lived in a "confrontational dimension" in South Africa and that this dimension is beginning to change. The first shock waves of a "dialogue dimension" have now been felt and it's time South Africans really got to know each other.

He believes South Africa has embarked on its own type of space race towards an era of negotiation. It is management's job to learn the skills required in the new era. It is not enough that the labour laws have changed. A new psychology of management is required.

Conflict management and the ability to manage change are essential tools of the businessman of the '80s if he is to acquire the type of mind set needed for success.

According to Professor Wiehahn,

the successful manager also has in his repertoire a thorough knowledge of his workforce, an effective communication system between management and workers, an effective grievance procedure, a just and fair disciplinary system and a good understanding of the principles of negotiation.

The time has past for State intervention in the relationship between employers and workers. The race to establish a true understanding of mutual interests in the labour field is on.

Professor Wiehahn invites employers to carefully examine their aversion to trade unions and to decide whether employers are not, in fact, acting in their own worst interests by refusing to negotiate. His motto is "Never refuse to negotiate."

The face of labour relations has changed drastically since 1977 when there were only 27 black trade unions with a total membership of 75 000.

Apart from the phenomenal growth in the number of trade unions in recent years, there has also been an important change in the character of labour unrest in recent months, he notes.

The recession and its consequent loss of jobs has spurred even greater politicisation of trade unions. The birth of the Congress of Trade Unions of South Africa has added a new dimension to labour.

Despite this, many employers are still living in a fool's paradise and are ill-equipped to deal with the realities of the times. Using real examples of labour disasters, Professor Wiehahn gently signals to his audience that paradise is closing down.

smaller investors... have neither decided... effects on the balance of payments... beneficial... sharing

31/1/88

BUD DAY

7/6/88

Wiehahn urges whites to confront change

132

THE "dynamics" of the South African situation were leading the country to a catastrophe, says Professor Nic Wiehahn, director of the School for Business Management at Unisa

Addressing a Pretoria Junior Afrikaanse Sakekamer function in Pretoria this week, he said

"We are living in a dream world and change is necessary"

The white people of South Africa, Wiehahn said, were afraid of the social, economic and political future that was awaiting them.

He said changes needed to be



WIEHAHN: 'We are living in a dream world and change is necessary.'

introduced on the labour front to give workers more rights. These included

- The right to work,
- Freedom of association — to be able to belong voluntarily to any trade union,

- Negotiation or bargaining rights with regard to grievances,
- The right to withhold labour,
- The right to protection,
- The right to development

Wiehahn said that whites should emphasise the importance of education and self-development

Vocational guidance was of prime importance, he said, to ensure that the right man was placed in the right job

"We in South Africa are reactive — we react only when something happens

"The time has come for us to be pro-active," Wiehahn said — Sapa

linked unit are indivisibly linked

fully evaluated

Certain industries poised for clashes

By Sheryl Raine

132

Crystal-ball gazing in the field of industrial relations is a hazardous business but there are certain sectors in 1986 which may prove interesting to watch

In some industries battles will focus on traditional issues and conditions of service. In other areas, the battles are likely to centre more on political ideology, with important implications for industry and the country as a whole.

Certain sectors seem more poised for turbulence than others.

The mining industry seems set for an action-packed year.

Rich from rand/dollar exchange imbalances, the mines are likely to face a year of tough wage negotiations. Both the Chamber of Mines — which split last year in offering increases to black miners, the growing National Union of Mineworkers (NUM) and white miners' unions, have points to prove.

While the Chamber would prefer to present a united front to the NUM at the bargaining table this year, the varying industrial relations styles of the mining houses and significant variations in NUM membership on the mines, may make unity an elusive dream.

News is that the NUM's membership has increased significantly since last year's strike, particularly on mines where the

union was not well represented. What makes the news even more interesting is that it comes from mining houses which monitor stop orders, and not union braggards.

Armed with various industrial and Supreme Court rulings, in particular the Marivale judgment, the NUM has at least some precedents to argue with, if it launches a legal strike and then sees its members dismissed en masse.

A showdown with white mine unions is also on the cards.

APPROACH

For the past year the Chamber of Mines and Mr Arrie Paulus's Council of Mining Unions have been trying to approach one another on the issue of scrapping the scheduled persons clause in the Mines and Works Act, and at the same time, offer white miners job security.

So far they've not come near to reaching agreement on how to ditch this last vestige of statutory job reservation.

Enshrined in the Mines and Works Act is the machinery which keeps black miners out of 13 job categories and denies them the prized blasting ticket.

Impatient, the Government is reported to have begun drafting new legislation but delays are expected in its implementation.

If the Congress of SA Trade Unions (Cosatu) starts implementing its policy of one

industry, one union in earnest, amalgamations of emergent unions could also have an impact on certain industries this year. Competition for union members is likely to be fiercer than ever.

The food industry, for instance is getting ready for the effects of the marriage of the Sweet Food and Allied Workers' Union and the Food and Canning Workers' Union.

Not part of the wedding is the Food Beverage Workers' Union, a Council of Unions of SA affiliate.

Economic hardship and retrenchment are expected to remain swearwords in industrial relations vocabulary this year.

Plunging membership figures are still worrying unions, as factories continue to close.

But the biggest confrontations this year could take place in the ideological arena.

Although the Council of Unions of SA and the Azanian Confederation of Trade Unions have grown closer in recent months it remains to be seen what will emerge from their on-going talks.

And on another front all the ingredients are available for a monstrous clash of interests in Natal between Cosatu and Chief Mangosuthu Buthelezi's Inkatha.

With Inkatha threatening to enter the trade union field in a big way, cut-throat inter-union competition and fierce political battles inside and outside the factories cannot be ruled out.

132
SOWETAN 5/2/86 (11/16)

THE Government has announced that the long-awaited legislation on domestic and farm workers is unlikely to be introduced at the current session of Parliament

Dr Piet van der Merwe, director-general of the Department of Manpower, said a report from the National Manpower Commission (NMC) had been completed and was under consideration but "we do not envisage legislation this year"

The news has disappointed the Domestic Workers Association, the Black Domestic Workers Association, the South African Domestic Workers Union and the Domestic Workers Employment Project. The organisations have been pressing for years to get legal provisions covering employment of domestic workers

The NMC was instructed in 1982 to begin an inquiry into employment conditions for the two groups and the long delay in proclaiming legislation has been strongly criticised and several questions have been asked in Parliament

Strike Ballot

• The Black Allied Mining and Construction Workers Union (Bamcwu) is to hold strike ballot at Samcor plants following the failure by the Minister to appoint a conciliation board to resolve the wage dispute with the company. The ballot is to be held today

• Changes to unemployment insurance

Legislation on domestics not on the cards

legislation are expected to be introduced before Parliament early in the session, Dr van der Merwe announced this week

Trade unions and other labour experts have been lobbying for changes to the fund for sometime

• Negotiations between Matthey Rustenburg Refiners in Wadeville and the Chemical Workers Industrial Union (CWIU) are continuing in an effort to solve a wage dispute

Agreement

• The Transport and General Workers' Union (TGWU) and the General Workers Union (GWU) have signed an agreement with the Renfreight group which will raise the group's wage bill by more than 12 percent

This was confirmed by the unions and management

• The Trade Union Council of SA (Tucsa) has appointed eight specialists to deal with various interests of the federation and its members. Unions are urged to contact them about matters which concern them

Any information, evidence, or suggestion that unions may wish to have taken up may be sent to the secretariat of Tucsa for submission to the committee concerned

WORKERS' DIARY — By JOSHUA RABOROKO

• A new trade union, the National Union of Forestry and Allied Workers which has won increasing support in the Eastern Transvaal, has joined Tucsa

• The most authoritative and complete annual trade union directory is now available. The 1985-86 edition of Tucsa's trade union directory is being sent to all affiliated unions. All interested parties may contact Tucsa at (011) 838-3424

• Hard Labour — a pictorial survey of labour relations in SA since 1979, by Gavin Brown, has been published. The book concentrates exclusively on newer emerging unions and does not cover the activities of Tucsa or unaffiliated unions

It is published by IR. Date Publication of Box 52711, Saxonwold, 2132

• A spokesman of the Oranje-Vaal Development Board indicated the existence of a misconception among employers in its area, to the effect that the Act of contributions in respect of Black Labour (Act 29 of 1972) has been abolished

• The process of bringing to justice those responsible for

the murder of two white policemen in Bekkersdal township is underway, while from the industrial relations viewpoint, the focus now centres on the dismissal of over 500 workers from Randfontein Estates Gold Mine

• The Black Allied Mining and Construction Workers Union holds its annual national council in Soweto on March 7/8/9 in Soweto

• The Bamcwu has applied for a conciliation board and an industrial court action against Tritung Plant Rentals and Stocks and Stocks Construction respectively over unfair dismissal of workers

• The Congress of South African Trade Unions is to hold a meeting on Friday to discuss various issues, including the action which will be taken against Gencor for firing over 20 000 miners at Impala Platinum mines in Bophuthatswana

• Moves are afoot to decriminalise strike action in South Africa. The National Manpower Commission hopes to release a report containing suggested changes to the strike laws within the next few weeks

Mr Joel Founé, director of Labour Relations in the Department of Manpower, said the NMC was investigating the changes to Section 65 of the Labour Relations Act which makes strike action under certain circumstances a criminal offence

• The Black Domestic Workers Association is going ahead with plans to take over 100 employers to court following their unfair dismissal of domestics. The first of these will face prosecution next week

• The South African Allied Workers Union (Saaawu) has applied for a conciliation board to resolve their dispute with Metal Box, Rosslyn plant, near Pretoria

The union is fighting the retrenchment of 25 workers and the employment of three whites at the plant. It contends that management was acting in a discriminatory fashion by retrenching blacks and hiring whites

The dispute resulted in a strike by about 500 workers who were later dismissed. Workers have since launched a boycott of the company's products in an attempt to have their colleagues reinstated. However, the company has sort an urgent Supreme Court action restraining the workers from continuing the boycott

• The Azanian Confederation of Trade Unions (Azactu) and

the Council of Unions of South Africa (Cusa) held an urgent meeting in Johannesburg last week to discuss various ways and means of working together

The talks have been going on for a long time after the two pulled out of the trade union unity talks aimed at forming Cosatu last December. Sources close to the unions said another giant federation might be formed by the two federations

Another meeting of the two unions will take place late this month

• The Media Workers Association of SA (Mwasa) is to hold a meeting with management of Perskor in Johannesburg on Friday to explore various means of having a recognition agreement with the newspaper company

• South Africa faces a future of escalating unrest with business and labour becoming more hardline in their dealings with each other, says Prof P L Bonner, Professor of African History at Wits University

Professor Bonner predicts an increased strike action and demands for greater say in management by trade unions. This tougher trade union action will come about as a result of threats to neutralise the industrial court's powers and a hardening of big business attitude towards labour

Employer-union pact suggested

STAR 10/2/88
(132)

Two leading industrial relations experts have suggested that employers and employer associations could launch far more effective political initiatives if they involved organised labour in making joint representations to the Government.

In recent years and particularly in the past year, South Africa's business community has begun to play an assertive role in lobbying the Government to actively pursue a more equitable system of power and resource sharing.

In the University of Natal's most recent issue of *Indicator SA*, two industrial relations experts, senior lecturer of the Wits Graduate School of Business Administration Mr Loet Douwes-Dekker and I-R manager of AECI Chlor Alkali and Plastics Ltd Mr Frank Horwitz, focused on the employer lobby and the role of employers in developing countries.

Both stressed that employer organisations had important functions to perform at all levels of society from the shop-floor to the national political level.

They argued that employer associations were not only able to channel industrial conflict through engaging in collective bargaining at several levels, but could also help develop a common value system within organised capital and labour through instituting democratic practices and procedures.

One of the most important suggestions put forward by Mr Douwes-Dekker was the formation of a national pact between labour organisations and employer bodies to jointly influence government policy and legislation.

Both experts warned that in future employer associations should avoid making unilateral representations to the Government on sensitive socio-political and industrial relations issues.

According to Mr Douwes-Dekker, the traditional notion of the "private sector" comprising just business needed to be fundamentally changed to include a

The bargaining forums established in the labour field in recent years offer exciting opportunities for expansion. SHERYL RAINE reports.



Some industrial relations commentators believe that the political initiatives of employer associations would have more forceful impact if organised labour were involved in making joint representations to government. The cartoon comes from *Indicator SA*.

bilateral partnership between organised capital and organised labour.

He suggested employers first aim to negotiate with representative labour organisations. Once both groups had jointly agreed on a plan of action, a united private sector would be able to wield far more effective political clout.

"In the current debate as to how to solve South Africa's crisis, there is too great an emphasis on the Government taking the initiative to bring about power-sharing," said Mr Douwes-Dekker.

The time was now ripe for forging new and effective lobbying links.

"There is nothing to prevent employer associations and union federations from agreeing on certain socio-econom-

ic objectives and establishing forums to set priorities for the allocation of the country's resources.

"The sense of power balance necessary to move towards a degree of shared values is already reflected in the commitment to collective bargaining over wages and working conditions.

"Now that this process is being institutionalised to a relative degree, it becomes possible to formulate guidelines for some form of basic national agreement on labour-management relations."

While plant, corporate and industry level bargaining relationships were comparatively well-established, bargaining relationships at national level between employer associations and union federations were still non-existent.

It was on this level that there was great potential for organised labour and capital to apply their collective power in identifying and agreeing on manageable issues outside the immediate arena of industrial relations.

Although numerous socio-economic issues were being raised in black communities through power strategies, the State as the power holder, protecting the status quo, refused to provide the necessary machinery for addressing those issues.

South Africa not only had a State bureaucracy which tried to prevent black social issues from emerging but also emphasised white privilege, preventing basic black needs from being recognised or endorsed as legitimate.

"Unattended social issues have at least accrued legitimacy in South Africa through international condemnation of apartheid and some measure of domestic recognition," said Mr Douwes-Dekker.

"At this late stage, it is crucial for organised labour and business to facilitate the collective definition of social problems to ensure that they are no longer ignored."

day

20/2/86 SOWETAN

132

Disputes will go on - expert

STRIKES and labour disputes will continue to rage in most South African industries as long as managements are not prepared to negotiate in good faith with black trade unions.

This was said by a spokesman for industrial relations consultants Andrew Levy and Associates. The spokesman said unions were prepared to flex their muscles and fight for workers' protection.

The following strikes and disputes had been reported yesterday

- More than 40 members of the Black Health and Allied Workers Union employed at E Merck, a German multinational, yesterday entered their third day of strike in protest against the retrenchment of their colleagues.

Negotiations are continuing

- Workers at Plascon Parthenon in Cape Town were still on strike over wages, according to a spokesman of the South African Chemical Union

SOWETAN Reporter

- More than 900 workers at four plants of Asea Electric Cable company in Pretoria are expected to return to work this week after management had undertaken to negotiate wages and working conditions with the Metal and Allied Workers' Union (Mawu)

A spokesman for Mawu said they were prepared to negotiate with management at all levels

- More than 1 000 workers at Pick 'n Pay outlets yesterday returned to work after a strike. They returned following negotiations between the Retail and Allied Workers Union which ended with the signing of an agreement

g
t
A
D
r
h
A
p
t
(
n
o

fr
h
r
u
er
an
fe

Je
pi
th
de
co
t
e
ba
ts
a

jo
ta
wi
w
ge
si

S
m
ar
gr
m
br

THELMA TUCH

BLACKS view the free-enterprise system as based on the denial of their political rights and dispossession of their land, Congress of South African Trade Unions general secretary Jay Naidoo told of businessmen yesterday.

He was addressing the FSA Management Consultants seminar in Johannesburg on industrial relations. He challenged the business sector — and in particular mining corpora-

Union chief challenges business

tions — to account for its use of what he termed dehumanising migrant labour and compound systems to facilitate profitability.

He also questioned why business had not condemned government's bankrupt economic and political policies — which he described as the root cause of the violence.

"Why has business not unequivocal-

ly supported the call by millions of South Africans for a democratic government based on one person, one vote?"

The paid-up membership of the independent trade union movement had increased from 20 000 in 1976 to 500 000 this year, he said.

Unions, he added, could not "stand back from the state of war" in many

townships as their members looked to them for support.

Cosatu, he said, had from its inception called for the lifting of the state of emergency, the release of Nelson Mandela and all political prisoners and the unbanning of the ANC, PAC and Cosas

Professor Nic Wilehahn, director of

the School of Business Leadership at the University of South Africa, said companies must be able to accommodate the increasing politicisation of trade unions.

Management would face increased pressure to become involved in areas outside work, such as social upliftment, education, housing and medical care

Multinational companies would have to adopt a more anti-apartheid stance to justify their presence here in the face of overseas pressures

Feb. 19 86

26/2/86 BUS DAY

"THE VITAL VIEWPOINT"

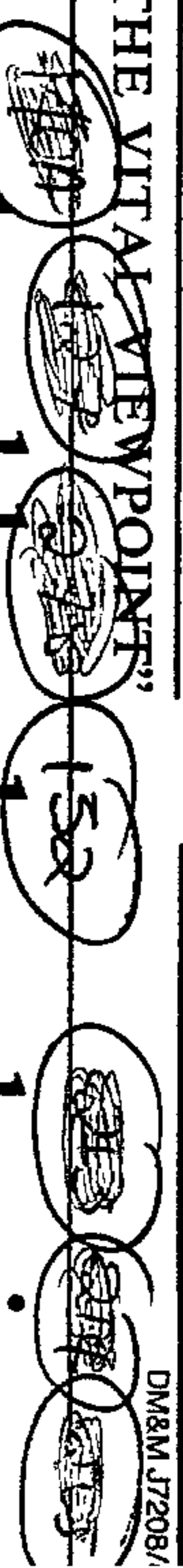

DM&M J7208/

Thousands of workers on strike at gold and coal mines

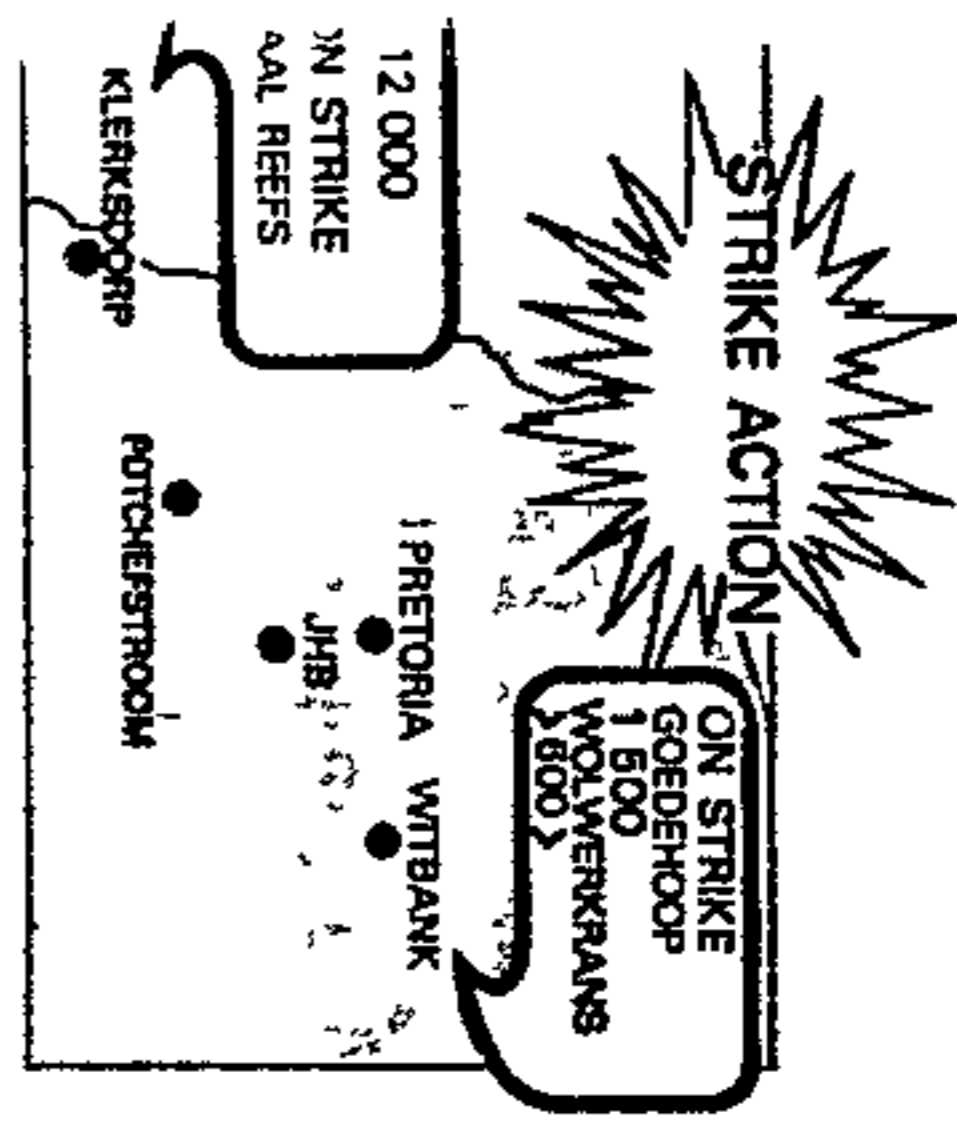

THOUSANDS of miners at Anglo American's Vaal Reefs gold mine near Klerksdorp started a wildcat strike yesterday. The action resulted after police detained eight workers in connection with the slaying of four team leaders at one of the mine hostels recently.

In separate developments near Witbank yesterday, about 1 500 workers at Anglo's Goedehoop colliery and more than 600 at Rand Mines' Wolwekrans colliery also went on strike.

All three strikes were illegal because the disputes had not been brought before

PETER HONEY

a conciliation board, mines spokesmen said yesterday.

The situation at Vaal Reefs was tense after more than 12 000 workers at three of the nine shafts, a gold plant and engineering workshops refused to work yesterday, a spokesman for the National Union of Mineworkers (NUM) said.

Negotiations were under way between Vaal Reefs management and NUM representatives yesterday, but the possibility of the rest of the mine's 40 000 labour

force joining the strike could not be ruled out, the NUM said.

An Anglo spokesman confirmed that detention of the eight workers was the apparent cause of the strike. He said they were being held for questioning in connection with the murder of four team leaders and serious injury of four others.

"Management is talking to the workers and the NUM to bring about a return to work," he said.

The NUM said more than 1 500 workers at Anglo's Goedehoop Colliery near

Witbank were involved in a work stoppage over management's dismissal of four shaft stewards.

It said an undisclosed number of workers at Wolwekrans Colliery, owned by Rand Mines, had also refused to work yesterday. The reasons were not known.

A Rand Mines spokesman said the total Wolwekrans workforce — 400 in the morning shift and 200 in the afternoon shift — had refused to work. The company was waiting yesterday to see if the night shift, of between 100 and 200 workers, would follow suit.

Industrial relations offer hope for future

By Sheryl Raine

Speakers who addressed a labour conference in Johannesburg yesterday would almost certainly have been accused of heresy a decade ago.

But this week their words outlined a promising future for negotiation. The conference was attended by 370 delegates from the field of industrial relations

Mr Tertius Myburgh, editor of the *Sunday Times*, opened the two-day conference entitled "Negotiation - A Way of Life", organised by FSA Pty Ltd

He said industrial relations (IR) had demonstrated the power of negotiation in South Africa and IR experts were often way ahead of the politicians in their ability to resolve conflict through talking. Pretoria and Lusaka would do well to take a few tips from the IR community

EUPHEMISM

Examining the country's present political scenario, he said the Government's mix of reform and repression had created a highly-combustible cocktail of unrest. However, he did not believe South Africa had been plunged into revolution

Although the original principles of apartheid had collapsed, reform had yet to penetrate the black townships. To blame for this, were the Government's penchant for euphemism, black distrust and the repeated incarceration of black leaders

Although the State President had promised an open agenda for negotiating reform, even moderate black leaders could not be seen to be going towards the negotiating table

This state of affairs could not last forever, he believed

LIST OF REFORMS

White South Africans were ready to ensure their survival by means other than apartheid and were aware the political debate had shifted away from apartheid and now centred on power and who was to wield it. A list of far more explicit reforms was beginning to emerge which would compel the Government to reach heights as yet undreamed of.

Mr Moses Maubane, chief executive and managing director of the African Bank, explained to businessmen why they could no longer separate business from politics, stand on the sidelines of black community issues and ignore their wider social responsibilities

He warned that the philosophy of business in South Africa had to accommodate new ideas to meet the demands of blacks

Despite the abolition of statutory job reservation many companies' commitment to "non-racialism and equal opportunity" remained a facade for traditional discriminatory labour practices which perpetuated the subservience of blacks

ASPIRATIONS

Professor Nic Wiehahn, director of the Unisa School of Business Leadership sketched the future of IR. He believed there would be a growing emphasis on politics in the labour field

"Trade unions are important and convenient vehicles for political energy and aspirations. Trade unions and politics are moving closer but there is no cause for alarm. We must just be able to handle it," he said.

Pressure on management to become involved in the social upliftment of black communities beyond the factory gates would increase. He predicted that codes of labour practice would be extended and multinationals would be pressured into introducing some form of affirmative action or quota system to guarantee black advancement

He urged companies to spend more time and money on building better human relationships wherever they could

Business meeting reflects anxiety of changing times

STAR 27/1/86

132

Businessmen who attended a two-day conference in Johannesburg entitled "Negotiation — a Way of Life", were taken on a journey through political and social problems which left them in no doubt that South Africa is in serious trouble and cannot do without their help.

A selection of quotes from conference speakers reflected the substance of what was said

● "We are a flexible society and we can take change, despite the noises of resistance we make in the beginning," Professor Nic Wiehahn, director of the Unisa School of Business Leadership (SBL)

● "We seem to have a shoot now, pay later policy," Professor Jan Hupkes, (economics) Unisa SBL, talking about escalating defence demands.

● "Only one thing is certain today. The genie of change has been let out of the bottle and can never be pushed back," Mr Tertius Myburgh, Editor of the Sunday Times

● "Affirmative action is a dirty phrase in South Africa but it

A two-day conference on negotiation ended in Johannesburg yesterday. It reflected the response of the South African business community to a country in crisis. SHERYL RAINE reports.

has to become the order of the day," Mr Moses Maubane, chief executive and MD of the African Bank.

● "We have to come to terms with the three R's — riots, responsibility and restraint," Mr Loet Douwes-Dekker, senior lecturer, Wits Graduate School of Business Administration

● "Have we got a sense of urgency or are our backs not sufficiently against the wall?" Mr Douwes-Dekker

● "We should not try to squeeze one another until the pips squeak," Mr Benjamin Trisk, Premier Group

● "Those with whom we (businessmen) negotiate are not only the representatives of labour. They are also the dispossessed in South African society. Our labour negotiates from an

extreme position in which it has received little and there is little to encourage its view of the future," Mr Trisk

● "We can't afford NOT to have the Industrial Court. Employers should not try to find ways of lessening the powers of the court but should increase its influence. If you destroy the court we may find ourselves back in the trenches," Professor Peter le Roux, Unisa Dept of Mercantile Law

● "If your kids had been out of school for a year, you would bring those anxieties into the workplace," Mr Bobby Godsell, chairman of the Manpower Committee of the Federated Chamber of Industries

● "The workplace has become the laboratory of the future," Mr Godsell

● "In South Africa violence is claiming 2,3 lives every day," Mr John Kane-Berman, director of SA Institute of Race Relations

● "Unfortunately, violence is the language whites listen to best," Mr Kane-Berman

Management must talk to unions ^{STAR} expert

132 By Michael Chester 13386

A dramatic increase in the size of trade unions has been forecast and employers have been advised, by Professor P L Bonner of the History Department at Wits, to widen dialogue with them to embrace social and political issues.

While addressing a Sandton convention on new industrial strategies he predicted the Congress of SA Trade Unions (Cosatu), already half-a-million strong, would grow "by leaps and bounds" in the next few months. It was forming a nationwide network of affiliate unions and would next turn to construction and farm workers.

"We can expect Cosatu in particular to forge a firm and powerful structure over the next several months."

He expected the unions to become even more deeply enmeshed in politics and advised business to follow suit rather than stand back and wait to be forced to do so on local encounters over

community issues that led to stayaways and consumer boycotts.

"The unions have already seen organised business use its muscle to find mutually acceptable solutions to local political issues," he said. "Business, in turn, has discovered how community problems can creep into the factories."

"There is room for a lot more dialogue — perhaps to everyone's advantage."

"Labour is likely to remain highly suspicious of business talk about the free-market system and items such as deregulation of business activities until there are signs of more open discussion and negotiation on industrial affairs."

"There are also suspicions about profit motives and long-term management planning that need to be cleared by dialogue."

Professor Bonner, asked later for his views on growing conflict between Cosatu and Inkatha, said he saw little prospect of a settlement in the short term.

"A direct confrontation looks inevitable," he said.

Sit-ins prove successful

SPAR 15/3/86

By Mike Siluma

132



This week's underground sit-in by about 1 200 black miners at Blyvooruitzicht highlighted the increasing use of sit-in tactics for black workers' demands

Sit-ins, although a relatively new tactic used by South African trade unions, have in the past few months emerged as a popular weapon for workers locked in disputes with managements

While three sit-ins were reported for 1985, there have been no fewer than six so far this year, involving nearly 5 000 workers.

Most of the sit-ins ended in victory for the workers

The longest — which lasted for two-and-a-half weeks in October — involved about 90 members of the Paper, Wood and Allied Workers Union employed by Printpak Gravure in Industria, Johannesburg

The workers were demanding the reinstatement of a colleague who had been unfairly dismissed. They held out until an arbitrator ruled that the company take back the fired worker

Another recent successful sit-in was at Cheseborough-Ponds, Wadeville, where workers occupied the factory for two days and three nights over better wages. It ended when the Chemical Workers' Industrial Union, reached agreement with management

Less successful was last July's Durban bakery sit-in by 2 100 workers. They resumed work after a week with the employers sticking to their offer

HUGE POOL OF UNEMPLOYED

Two features of the South African labour relations scene appear to have created a need for such a tactic — the huge pool of unemployed which can easily be called in by managements to replace fired strikers, and the possibility of police intervention

Examples of these are the arrest last November of about 700 strikers during the Baragwanath Hospital strike and the detention of scores more picketing a clothing retailer with which they had a dispute

From the workers' point of view, staging a sit-in would simultaneously address both problems

It would obviously be more difficult for police to act against workers occupying a factory and replacement workers would not be able to start work with the strikers still occupying the factory

Employers can either tolerate the presence of strikers in their factories and negotiate with unions until settlement is reached or ask the courts for an eviction order

Only one company, Asea Electric, has taken the second option. About 850 Metal and Allied Workers' Union strikers were forced to leave the company's plants in Pretoria after an eviction order.

Other firms, such as G B Engineering on the East Rand, have obtained such interdicts but have shown restraint in effecting them

This week 3 000 workers were involved in sit-ins at Blyvoor, Haggie Rand and two East Rand companies, G B Engineering and Pan African Shopfitters

ted
tar
ns-
ow.
its
la-
di-
en-
nd
rk-
na-

ST JOHN AMBULANCE
COMPETITION No 9
NEW DAIHATSU
WORTH R10 000
PERFECT ENTRY, DRAWN WINS
PETROL SAVER
EVERY OF PRIZE
CAPE TOWN.



DAIHATSU CHARADE

you wish.
 ills on the attached coupon (or facsimile)
 anied by a donation of R1
 ompetition No 9, PO Box 2012,
 Wednesday 26 March 1986.
 ord
 ord No 551.
 een trained in First Aid and Allied subjects by

Special Prize FREE R500
 entirely free. Just return this form
 entries.

BE THE LUCKY WINNER

CAR COMPETITION No 9
12, CAPE TOWN 8000.

ersons have been trained by St John in
 South Africa?

.....

 TELEPHONE NUMBER

THE STAR

Breakthrough in labour relations

VOLKSWAGEN of South Africa (VWSA) has broken new ground in the field of labour relations in South Africa. The company was among the first to recognise black trade unions long before the Wiehahn Commission's recommendations which led to the legislation of black unions in South Africa.

Boasting one of the most efficient communications structures between labour and management in South Africa, the company had by 1978 established a factory committee in which senior management and union representatives met once a month to discuss issues relating to all hourly-paid employees.

In 1981 the company also became the first and is probably still the only one in South Africa to have full-time shop stewards, who are paid by the company while holding union office.

Full pay

Each of the two trade unions organising in the company, the National Automobile and Allied Workers Union (Naawu) and the exclusively white South African Iron, Steel and Allied Industries Union (SAISAIU) elect a full time shop steward for every 750 workers and a part-time shop steward for every 250 workers.

Part-time shop stewards are allowed to spend five hours a week, on full pay, to attend to union matters. So far, Naawu has five full-time and 23 part-time shop stewards, while SAISAIU has two full-time and five part-time. Full-time stewards re-

Full-time shop stewards at Volkswagen

FOCUS

By SAM MABE

tain their positions in the company and are also entitled to all wage increases given to other employees.

According to Mr Brian Smith, manpower manager of the company, many other companies have expressed reservations about the system of full-time shop stewards.

"The company and the unions we recognise agreed on the introduction of this system, which is in line with what is happening in America and West Germany. The system has been working quite well and we're all happy with it," said Mr Smith.

At the time of going to the Press last night, officials of Naawu had not commented on the *Sowetan's* questions on their relations with VWSA.

In the late 1970's

when it was still illegal for blacks to be artisans, the company took the bull by the horns and started training blacks at the VWSA Apprentice Centre in Uitenhage.

The first three coloured die-and-press toolmakers were also trained by VWSA and all qualified in 1981.

"We knew that what we were doing was not in line with Government policy, but we were convinced that there was a need for all our employees, irrespective of their race, to be given the same type of training. For that reason we just went ahead and trained blacks as well," said Mr Peter Searle, managing director.

Today the company claims to have by far the biggest apprentice facility in the car manufacturing industry in South Africa and approximately 36 percent of all apprentices in the industry are trained by VWSA.

Strikes

VWSA stands out as the most highly unionised company in the industry in South Africa.

It employs about 6 000 people and of its 4 000 black workers, who include coloureds, about 90 percent are members of the National Automobile and Allied Workers Union (Naawu). The company has lost millions of rands in numerous strikes in the historically volatile eastern Cape area, because of its highly politicised labour force.

According to one union member who would not be named,



Mr PETER SEARLE, managing director of VWSA

the issue of whether or not to go on strike in the eastern Cape is seldom a subject for debate.

"We are like one family here and when we say an injury to one is an injury to all we mean it. If there is a feeling among a section of the work force that we must down tools, we do so without asking too many questions and we rarely have dissenters," he said.

Many companies in the eastern Cape have chosen to close shop and move to other parts of the country rather than face the emergent black trade unions in the area.

Invest

VWSA chose to remain and continues to invest heavily in the Uitenhage plant.

The company's communications manager, Mr Graham Hardy, shrugs off the labour instability his company has gone through as a passing phase which every company that is being unionised has to go through at one stage or another.

He said "We do not subscribe to the view that the eastern Cape is a troublesome area as far as labour is concerned. There is no statistical evidence to support that."

"Our high profile labour image was because we were the first to encounter the problems of unionisation. You will always go through a period of strife when deal-

ing with emerging trade unions.

"But the experience gained in the process will lead to far greater stability, and that is the stage we are reaching now," said Mr Hardy.

He said socio-political and economic considerations have influenced VWSA's decision not to heed calls for disinvestment.

"Our parent company believes that by staying in South Africa and continuing to press and act for change, we are serving the interests of all South Africans better than if we withdrew and criticised from a distance."

"In economic terms, the factory is a sizeable investment that will not easily be discarded and also represents a tremendous potential once the situation in this country improves. We also believe that most of the growth will come in the black market," he said.

Disaster

On the company's choice to stay on in the trouble-torn eastern Cape region, Mr Hardy said the rate of unemployment in the area is estimated at more than 50 percent and the departure of VWSA, which is the largest employer in the area, could spell disaster for many people.

"We also have a pool of highly-skilled automobile workers who have grown up with the motor industry and who understand the industry better than other people elsewhere in the country."

"We have also invested heavily in the eastern Cape over the past five years and have one of the most sophisticated plants in South Africa. It is simply not feasible to relocate," said Mr Hardy.



Political comment in this issue by J Latakomo and A Klaaste. Sub-editing, headlines and posters by S Mathaku. All of 61 Com-mando Road, Industria West, Johannesburg.

The reproduction or broadcast without permission of articles published in this newspaper on any current economic, political or religious topic, is forbidden and expressly reserved to The Argus Printing and Publishing Company Ltd under Section 12(7) of the Copyright Act 1978.

• Write to the Editor at P O Box 6663, Johannesburg, 2000. Non-de-plumes can be used, but full names and addresses should be supplied or the letter will not be published.

Bill 'threatens' worker rights

By ANTHONY JOHNSON
Political Correspondent

2/3/86
132

FEARS have been raised in trade-union and civil-rights circles over proposed legislation to grant President P W Botha vast discretionary powers to "undermine" trade unions and scrap employees' rights and benefits

Concern reached a peak yesterday as groups opposing the Temporary Removal of the Restriction on Economic Activities Bill learned that today is the deadline for submission of representations to the parliamentary standing committee on home affairs which is considering the legislation

The president of the Black Sash, Mrs Mary Burton, yesterday appealed for an extension of the deadline for presenting evidence as many interested parties were unaware of the impending legislation

She said the proposed law could lead to the removal of workers' rights and "create opportunities for tremendous exploitation"

'Red tape'

Cosatu, apparently caught off guard by the early cut-off date for submissions on the bill, is to send an urgent telex to Cape Town today to detail its objections to the proposed legislation which empowers President Botha to bypass Parliament and suspend measures restricting

"entrepreneurial activity" by slashing "red tape"

Cosatu will argue that the new measure allows the rights and protections workers have won over the years to be whittled away in the name of promoting small business

Strongest criticism of the proposed measure yesterday came from the National Committee Against Removals (NCAR)

A spokesman for the NCAR said: "If this bill becomes law the State President will be granted vast discretionary powers to undermine the trade union movement and introduce 'sweatshop' conditions wherever and whenever he may wish"

Standards

The NCAR said it saw the bill as part of the move towards implementing "orderly urbanization" as outlined by the President's Council report on urbanization

"This report clearly recommends the lowering of standards with regard to housing, health and safety for workers It urged the government to recognize South Africa as a 'Third World' country and then to scrap controls which inhibit the free enterprise system"

The NCAR said it viewed the possible scrapping of health and safety protections, of en-

forcement of contributions to UIF and workmen's compensation funds, and of provisions such as the supervision and use of machines "as irresponsible in any society"

"South Africa has evolved a system of commendable labour legislation over the past six years Is this all to be scrapped in the name of providing employment or extension of benefits of the free enterprise system to the black entrepreneur?"

'Bantustans'

The NCAR said that while the provision of employment was clearly necessary, "this country cannot afford extending the appalling lack of protection and widespread exploitation of black workers in the bantustans to the rest of the country"

The NCAR pointed out that in the homelands unions were not allowed to organize, there were no minimum wages or maximum hours, no protection from injury or disability during working hours

It was not uncommon for workers to be earning as little as R12 a week in factories located on the edge of relocation areas such as Ezakheni in KwaZulu, Onverwacht near Bloemfontein, Phatutshaba in QuaQua or Itsoseng in Bophuthatswana, the NCAR said

Appeal affects future of Industrial Court

By Sheryl Rame

The powers of the Industrial Court are expected to come under the spotlight in an important appeal to the Appellate Division in Bloemfontein today.

The outcome is being eagerly awaited by employers and trade unions and could have far-reaching effects on Industrial Court cases in future.

The ruling of the Appeal Court could overturn or confirm precedent-setting decisions made by the Industrial Court.

Labour lawyers are hoping that the Appellate Division's ruling will clarify the ambit of the unfair labour practice definition in the Labour Relations Act, the power of the Industrial Court, and strike law.

Certain questions of law were reserved in the Industrial Court last December in a dispute between the National Union of Mineworkers (NUM) and Anglovaal's, Hartebeestfontein Gold Mining Company Ltd.

The dispute arose out of the dismissal of Harties workers during a legal wage strike last September.

The questions were referred

to the Appeal Court as a matter of urgency on February 14 and include

- Whether the Industrial Court has the power to reinstate an employee, notwithstanding the valid termination of the employee's common-law contract of employment.

There have been cases recently in which the Supreme Court has ruled that an employer's dismissal of workers is lawful while the Industrial Court has ruled that these lawful dismissals were nevertheless unfair and the workers concerned should be reinstated.

DISSATISFACTION

These Industrial Court rulings have caused much dissatisfaction among employers.

- Can the single act of an employer, consisting of the dismissal of workers engaged in a strike, constitute an unfair labour practice?

- Can an employer's dismissal of employees engaged in a strike, or his failure or refusal, consequent on dismissal, to continue to employ them constitute an unfair labour practice, or a change in labour practice as de-

defined in the Labour Relations Act?

- Whether the dismissal of certain NUM members from Hartebeestfontein gold mine during a legal wage strike in September last year, constitutes an unfair labour practice.

In the original case before the Industrial Court, Hartebeestfontein disputed that the workers were dismissed for taking part in a legal strike.

The company contended that they had been dismissed for other reasons, including resignation, desertion or gross misconduct arising from intimidation.

The appeal is important because up until now it has been accepted that the Industrial Court has the power to reinstate dismissed workers and that a dismissal can constitute an unfair labour practice.

These basic assumptions are now being challenged. If they are confirmed by the Appellate Division, the position of the Industrial Court will be significantly strengthened, ensuring that it has the power to make final reinstatements and play a decisive role in settling future labour disputes.

EL firm yes to May 1st holiday

132

28/3/8

Dispatch Reporter
EAST LONDON — A
company here has agreed
to give its workers a paid
holiday on May 1, inter-
nationally known as the
May Day workers' holi-
day

DISPATCH

Chloride in East Lon-
don is the only company
yet to offer May 1 as a
paid holiday to workers.
The holiday was nego-
tiated with the South
African Allied Workers'
Union (Saawu).

A statement from
Saawu stated that the
agreement between the
company and themselves
was entered into on
March 24. It said it was
hoped that more factories
would follow suit.

The personnel man-
ager at Chloride's Johan-
nesburg office, Mr Allan
McGuire, said it was Saa-
wu's prerogative to an-
nounce any agreement.

However, any agree-
ment or contract between
the company and the
union was treated as a
private matter, Mr Mc-
Guire said. He declined
to comment further.

Cosatu decides on May rallies

JOHANNESBURG — South Africa's biggest labour federation, the 650 000-strong Congress of South African Trade Unions (Cosatu), said yesterday its members would stay away from work on May 1 to attend mass "May Day rallies" around the country.

This decision was taken at the federation's second central executive committee meeting at the weekend.

Cosatu's general secretary M r Jay Naidoo said at a press conference here yesterday the May Day campaign would "mobilise our members and the broad community around the following demands"

The right to observe May Day as a paid public holiday, a 40 hour week and a living wage for all, the right of all workers to join democratic trade unions, democratic students representative councils for all students and "an alternative system of people's education", the release of all political prisoners and the unbanning of all organisations, an end to the pass laws and influx control

The weekend meeting also agreed to observe June 16 as a public holiday, in line with the recent call by the National Education Crisis Committee's (NECC) call for a three-day stayaway around the day

Cosatu Vice-President Mr Chris Dlamini said, however, that union members were still discussing whether to go to work on June 17 and 18

The federation also announced plans to oppose the KwaNatal Indaba and the formation of the rival United Workers Union of South Africa (Uwusa)

Cosatu claimed there was a "press campaign to suppress all criticism of the KwaNatal proposal" — Sapa

30 000 ~~workers~~ workers in one-hour ^{WEEKLY} ¹³² stoppage ^{18/1/85}

By PHILLIP VAN NIEKERK

UP to 30 000 metalworkers at plants throughout the country downed tools for an hour yesterday in protest against wage increases offered to workers when the annual industrial council pay talks began on Tuesday

Employers confirmed that the one hour stoppage, from 7 am to 8 am, had attracted widespread support while a representative for the Metal and Allied Workers Union (Mawu) said most of their members had responded to the call.

The industrial council sets the pay and working conditions for some 300 000 white and black, skilled and unskilled, workers in the South African metal industry.

The Steel and Engineering Industries Federation's (Seifsa's) offer on the opening day of a 26c per hour increase on the minimum wage is almost 14 percent

It will take the lowest wage in the country's chief manufacturing industry to above the R2,00 an hour mark for the first time and is regarded as relatively good in the current economic climate

But after three years of wage increases below the inflation rate, unions such as Mawu will be loath to accept an increase which is below the current inflation rate of more than 18 percent.

A Mawu representative said they had been receiving inadequate offers for years and yesterday's stoppage was a demonstration of workers' rejection of Seifsa's offer.

The political mood in the union, seen in the mass rallies which Mawu has held in the townships preceding this year's pay talks, and aggravated by the death of a worker who was shot by police at Katlehong last weekend, has made agreement even more difficult to reach.

Nor have employers reacted favourably to some of Mawu's non-pay demands, which include a demand that metal bosses not sell products to the South African Security Forces.

Mawu at this stage has few allies in the industrial council following the failure of the local co-ordinating committee of the International Metalworkers Federation to set common wage demands

Its most encouraging ally has been the Electrical and Allied Workers Union.

Unionists out on R200 bail

THE president of the Council of Unions of South Africa and seven shop stewards of the Food and Beverage Workers Union were released on R200 bail each on Friday after they were arrested during a demonstration at Unilever on Thursday.

2/14/86.
After their arrest hundreds of workers had a sleep-in and sit-in at the premises of Unilever. The workers were protesting at the arrest of Mr Mndaweni.

The demonstration at Unilever called for May 1 to be recognised as a paid public holiday. According to an official of the union the workers insist that May Day be a public holiday as in other countries of the world.

Meanwhile, the Chamber of Mines said yesterday it was given an undertaking by the National Union of Mineworkers (NUM) that it would not call for a strike prior to a Supreme Court hearing relating to the union's demand for May 1 to be declared a paid holiday.

The undertaking —

(128) (143) (132) (131)
described by the chamber as acceptable — was subsequently recorded by a court, the employers' body said in a statement.

SOWETAN
This follows an urgent application by the chamber on April 17 seeking an interdict from the Supreme Court restraining the NUM from "instigating, calling for, supporting or organising" a strike over the May Day issue.

Meanwhile, the union has been given until April 22 to file an answering affidavit to the chamber's application, which also seeks a Supreme Court order setting aside a conciliation board established by the Minister of Manpower to deal with the matter.

The chamber has objected to the terms of reference of the board on the basis that it does not correctly reflect the dispute between the parties.

The NUM undertaking will expire on April 24 when the chamber's application will be heard by the Supreme Court.

BUS DAY 22/4/86 (L.P. B. M.) 132

Rainbow MD scotches rumours of takeover



● GEOGHEGAN

NEW MD John Geoghegan yesterday scotched rumours that Rainbow Chicken Farms is about to be taken over.

Speculation on the future of the company, which controls 40% of the Rbn-a-year market, began after Stanley Methven, founder and MD of Rainbow, died in a motor accident in Monaco in February.

MICK COLLINS

Industry analysts predicted his family would sell out, and speculated on a takeover battle between Tiger Oats, Premier Foods, Fed-food and I&J

However, former financial director Geoghegan insisted yesterday that any deal with other food

giants was "definitely, absolutely not on".

He said Rainbow had no plans to alter its priorities.

"We are going to push to increase our market share still further and there will be no slackening in our expansion plans I will have the same management team and it's all systems go from here."

CAPE TOWN 23/4/86

Job opportunities needed Relly

JOHANNESBURG — A trade union leadership is in the workplace that the multiracial reality of SA has become tangibly evident — and it is here that a productive and equitable post-apartheid society is being forged

This is the view of Anglo American Corporation's chairman, Gavin Relly, who addressed the official opening of the 55th Annual Conference of the Artisan Staff Association in East London yesterday

Pleading for the power of free market enterprise to take over, Mr Relly also stressed the importance of SA having strong and powerful

rather than a weak and vacillating union decision-making process

"The remarkable changes already achieved in labour relations lead me to believe that it is the most vital and promising laboratory for the future

"For it is here, where different groups of South Africans are discovering their interdependence, as well as learning the skills of constructive conflict resolution"

He said the freeing of SA society — both politically and economically — would go a long way to providing job opportunities for the country's burgeoning population

"Between 1974 and 1984 the American economy created 24m jobs, while Europe lost 3m. America reduced controls while Europe, by and large, did not"

Opportunities

He said the only way in which SA could hope to provide sufficient opportunities for the 80 000 black matriculants entering the job market annually was to open the political and economic system — to allow the invisible hand of the free market to operate

Relly said it was vital that continued efforts be made to train all black South Africans, so that the country would need to rely less on expatriate skills, referring to migratory labour from SA's neighbouring countries. — Sapa



Dr P R Morkel, executive vice-chairman of Voikskas Ltd, has been elected president of the Clearing Bankers' Association of SA.

CENTURY

..and 82 years of it in South Africa

CITY P. 2748
132

WORKERS' Day in South Africa has a long history – the struggle for May Day first began in 1904 when a group of socialists met in Johannesburg's Market Square, sporting red badges and ribbons and carrying red banners.

About 2 000 workers marched to the square to hear speakers urge solidarity with workers in other countries. But it was only in 1917 that May Day was marked as a yearly day of celebration in South Africa, thanks to the International Socialist League.

Formed in 1916, the ISL was the forerunner of the Communist Party of South Africa, and opposed the First World War – as did many other progressive organisations around the world.

The ISL also broke away from the idea that May Day celebrations in South Africa should be exclusively white.

The 1917 May Day celebrations included a black speaker for the first time – Horatio Mbele, a Transvaal activist in the African National Congress.

But, in what was to become a regular occurrence at May Day rallies, the meeting was broken up by soldiers – backed by civilians, enraged by the ISL's non-racial position.

However, the ISL was undaunted and continued to move slowly towards full acceptance of non-racialism.

This was not without problems. In 1920, for example, coloured workers refused to participate in May Day celebrations on the Reef because of white workers who had scabbed during a dockworkers' strike in Cape Town.

The dockworkers said they would not celebrate alongside whites – but apart from this, the May Day celebrations were successful, with many white workers taking the day off.

In 1921 the ISL dissolved to form the Communist Party of South Africa.

Under its leadership, worker protests were again strengthened by the participation of black and coloured workers – particularly in Durban, where a strong contingent attended a mass rally.

The events of 1922, however, changed the nature of May Day in South Africa forever.

Bosses – particularly on the mines – started replacing skilled, expensive white labour with cheap, unskilled black labour.

White workers, threatened by this, revolted against mine owners – and demanded that the Government introduce laws to protect their position.

Although the white miners' revolt was crushed, job reservation was introduced – and the chance of non-racial unity among workers was set back years.

The pressure for May Day continued, however, and became so intense in 1926 that a Bill was introduced in Parliament proposing a public holiday.

But instead of May 1, the Bill proposed the first Monday in May. Workers protested, arguing that May 1 had become an international symbol of the workers and worker solidarity.

When the Government refused to concede to this, the Bill was dropped.

Another milestone was the 1931 celebration, when the United May Day Committee rejected the participation of coloured workers.

White unions had developed a tradition of holding Workers' Day celebrations under the UMDC, which was formed each year.

But, when the UMDC rejected coloured workers, the non-racial African May Day Committee was formed.

On the morning of May 1, 1931, the AMDC gathered its members, backed by black and white unemployed workers, at Newtown Market Square in Johannesburg.

Up to 3 000 black workers and 1 500 whites marched together as workers, carrying banners and booning as they passed the Native Affairs Department, police headquarters and Corner House, the headquarters of mine owners.

The meeting was disrupted by cops, who baton-charged the crowd – but the workers fought back.

After a struggle, cops arrested a group of workers, eventually charging six white workers and one black worker.



for Wages"

But political developments in 1948 – when the Nationalist Government came to power – smashed what remained of the unity between black and white workers.

The year 1950 saw the most important event in South African history until then: progressive organisations like CNETU, the ANC and Natal Indian Congress declared May 1, 1950 as Freedom Day.

Meetings to fight the Suppression of Communism Bill and to support demands for higher wages and better working conditions were held throughout the country as a build-up to the Freedom Day strike.

The Government banned meetings and army units patrolled the streets demanding that people go to work. But despite this, more than 80% of Reef workers stayed away from their factories.

OF STRUGGLE

A battle that's as old as time itself

THE struggle for worker rights is as old as time itself – but a special workers' day has only been marked since 1886.

May Day comes courtesy of a group of pioneering American workers, who declared on May 1 of that year that a working day should only be eight hours long – and that all workers should strive for this.

Although they were only following the example of a group of Australian workers – who held a work stoppage in April of 1856 over the same issue, and declared the day International Workers' Day – it was the Americans who put May Day on the map.

Hundreds of thousands of workers took up their campaign and supported it with huge demonstrations and strikes.

On that very first May Day, 350 000 workers in 11 562 factories throughout North America downed tools. 185 000 workers were immediately granted an eight hour working day. Elsewhere, bosses conceded a nine or ten hour day (but still a six day week) to a further 2-million workers.

But the birth of May Day was not without cost. In Chicago, cops fired on locked-out workers on May 3, killing six. The next day – in what started as a peaceful protest against the police killings – a bomb was thrown by an unknown person.

As a result four workers were framed on conspiracy charges and hanged. Many others were sentenced to life imprisonment.

On May 1, 1890 was accepted as an international day of solidarity for all workers throughout the world. Meetings were held in Australia, Austria, Hungary, Denmark, Germany, Spain, Poland, Italy, Norway, Belgium, Sweden, Poland, Britain and Portugal.

Labour Day was born. Since then, May 1 has continued to be celebrated as Workers' Day around the world.

It has become a prominent feature in the constant struggle of workers for both a better deal and the fundamental transformation of society.

In socialist countries like China, Cuba, Nicaragua and the Soviet Union, May Day is a public holiday – all factories, shops and schools are closed and governments organise mass rallies and displays.

May Day is also a recognised holiday in Zimbabwe.

In some countries, workers have used May Day to organise strikes and protests against their governments.

In 1974, Portuguese trade unions organised a march through the streets of their capital, Lisbon – after they overthrew the fascist government that ruled for 45 years.

In Brazil, 100 000 workers went on strike on May Day of 1980, marching in protest against the harsh labour laws the Brazilian Government used to try and weaken their trade unions.

In Uruguay, 150 000 workers demonstrated on May 1, 1983 in protest against the military dictatorship that rules their country.

The final death toll was 19, with 30 injured.

In Cape Town, 6 000 people marched down Adderley Street shouting "Down with apartheid" and "We want freedom".

In Durban 10 000 demonstrated against the Suppression of Communism Act.

After the freedom strike, May Day activity declined in the face of growing state repression.

The 1960's was a decade of silence. By 1961 the Government had acted against Workers' Day, enforcing its exclusion from wage determinations, and industrial council agreements, and by 1965 it was no longer celebrated by South African workers.

May Day was only revived by South African workers in 1982 and 1983, climaxed in the observance of

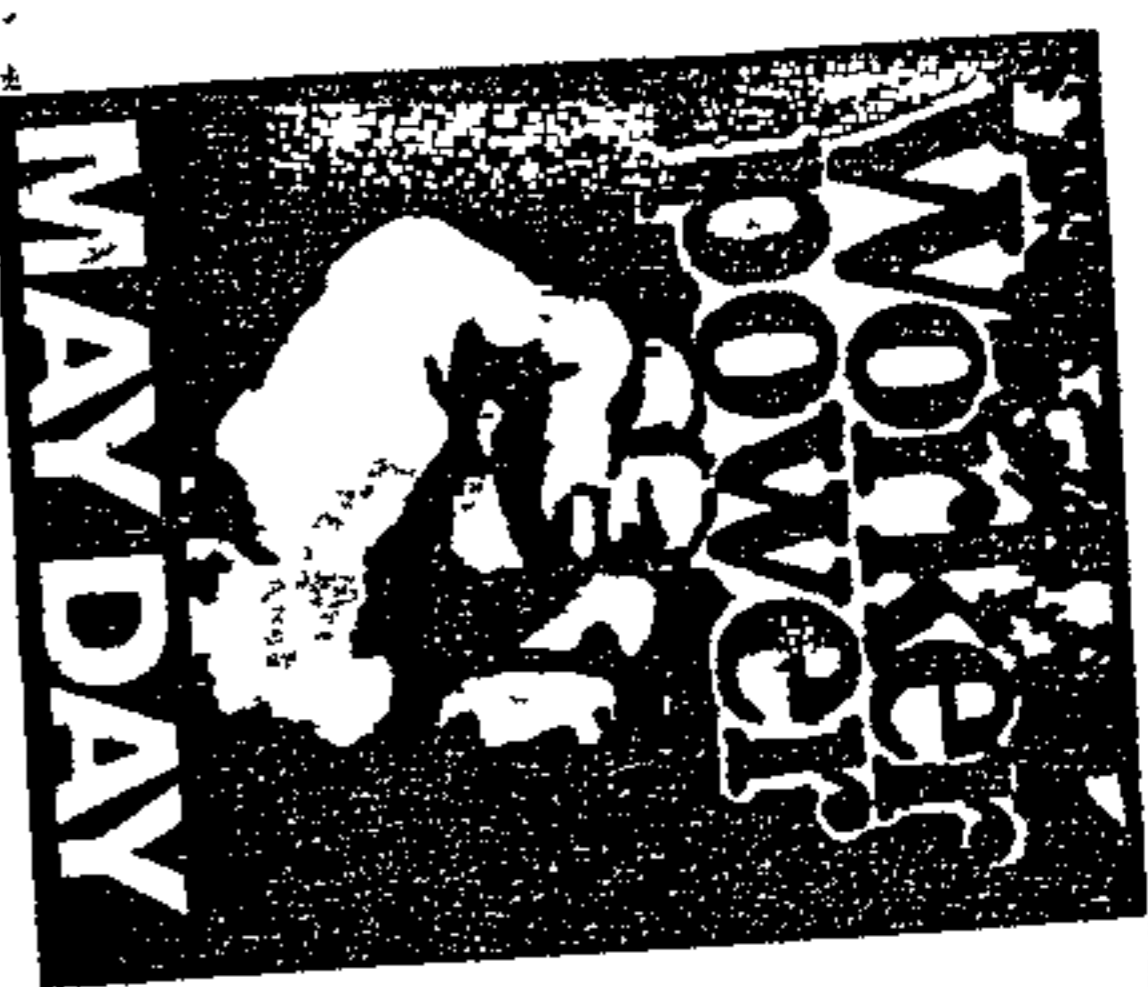

Workers close the factories - and go to rallies instead

MORE than a million workers yesterday made May Day 1986 the biggest worker celebration in South Africa's history.

- A nationwide stayaway left factories deserted - with much of the country's workforce flocking to May Day rallies called to mark the 100th anniversary of international labour day
- The main focus was on Durban, where the Congress of SA Trade Unions and the Inkatha-backed United Workers Union of SA held two different rallies
- An almost total stayaway was reported in Johannesburg, Pretoria, Cape Town, the Western Transvaal, East London - and Port Elizabeth, where May Day rallies were banned by the local magistrate
- A massive rally was held at Orlando Stadium where 15 000 workers waved the Cosatu flag under the eye of a mini-army of police and troops
- Ten miners were injured - one of them seriously - in clashes with security officials at Lbaqon gold mine on the eve of May Day
- A massive stayaway was reported on some of the country's mines
- Pitches reported an "almost 100% stayaway" by its drivers and staff - and no buses ran scheduled routes in the Transvaal
- Schools throughout the country were empty as students virtually turned May Day into a second June 16
- May Day was also marked by a limpet mine blast in Cape Town - which wrecked a toilet - and the petrobombing of trains running from Soweto to Johannesburg

All eyes were on Durban, though, where Inkatha lauded Uxusa at a rally attended by more than 50 000 people - and at least 10 000 workers flocked to a Cosatu May Day rally at Curries Fountain just three kilometres away.

MAY DAY MARCH

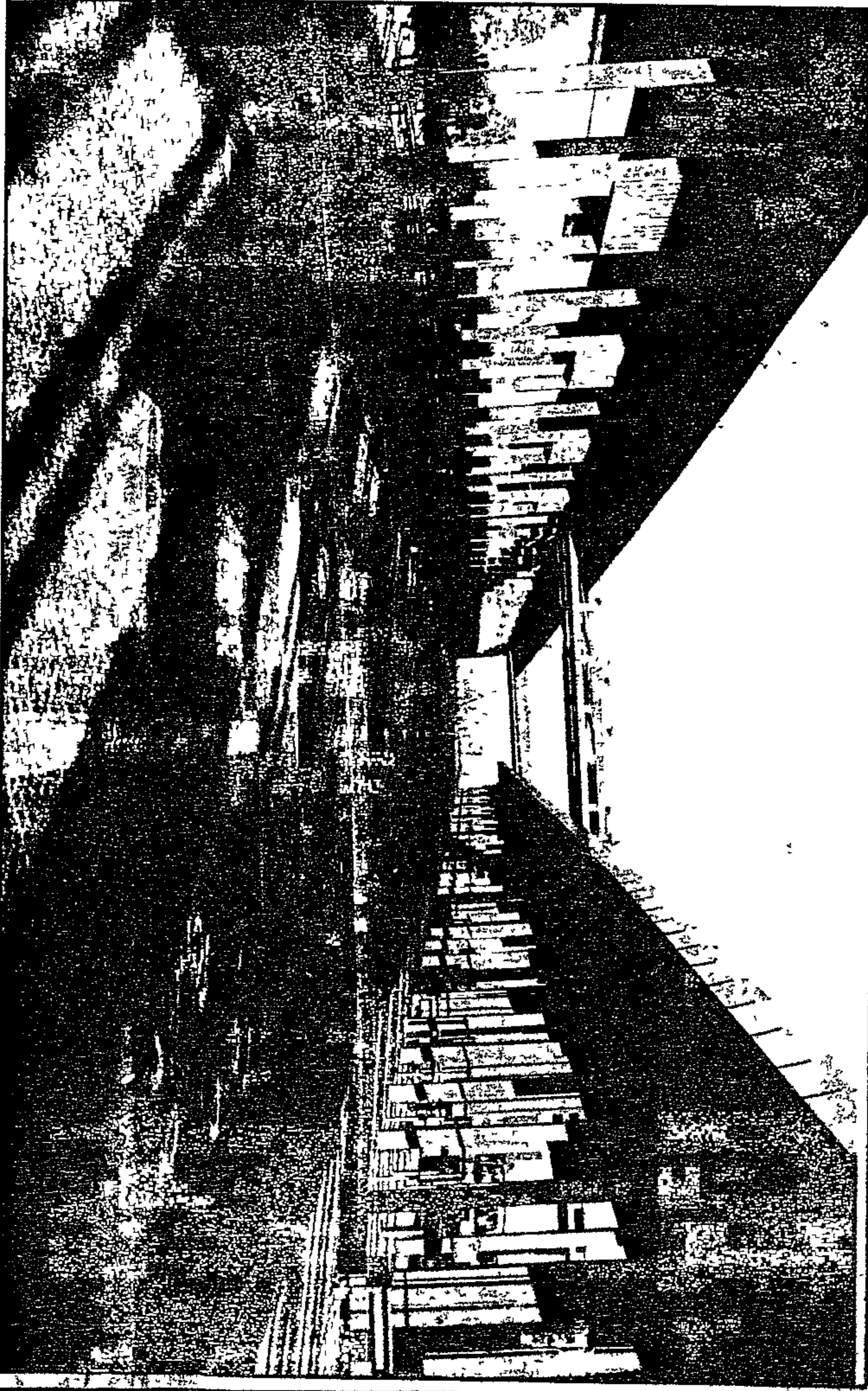

Soweto's Baragwanath eerily empty bus terminus yesterday - indicative of the situation through the country
 Pic: MIKE MZILENI

ADOLF
 back with his real MATTERS

Born again Highlands Park buys out Pretoria Calles

SUPERMAN'S
 bonbed Bishop Mkoome!

Soweto's Baragwanath eerily empty bus terminus yesterday — indicative of the situation through the city. **FILE: MIKE AZIZANI**



STAYAWAY extended after ban on rally

Port Elizabeth

PORT Elizabeth workers are planning to shut down the city until Monday — because their indoor May Day rally was banned at the last minute by the city's acting chief magistrate.

And their May Day celebrations — scheduled for 10am yesterday and banned by acting chief magistrate DFM Smith in terms of Section 40 (1) (b) of the Internal Security Act — will now be held at the Active Transport Hall in Korsten at 10am on Monday.

The banning notice — from yesterday at 5pm — was addressed to Congress of SA Trade Unions PE chairman and May Day Coordinating Committee chairman A Mkalipi on Wednesday.

The decision to extend the stayaway was announced in thousands of pamphlets distributed in the black townships by the area and street committees last night.

The pamphlets — issued by the co-ordinating committee which represents the Cosatu, the United Democratic Front and the Council of Unions of SA — said: "Bannings won't stop us. The banning is a clear indication that the State

does not respect and serve the interests of the people who are producing the wealth of the country, and community at large." It read:

At a meeting on Wednesday night the co-ordinating committee also decided that:

- Workers would stage a total stayaway on Friday
- This action would be reinforced by the State

peated until workers were allowed to hold their May Day rally. Because the indoor rally has been banned until Saturday workers are now forced to stay away on Monday.

- Workers will collect their wages today between 12 and 3pm
- Shops in the townships will be open today

Supra

All May Day reports by Mene Bende, Dan Dierini, Shmeh Kunene, Herman Latsie, Derrick Luthy, Sibuso Mngodi, ZB Molele, Benito Phillips, CP correspondents and Supra

Schools were completely deserted and there were more police vehicles on the streets than private cars.

Trams on the city, as in Pretoria and Cape Town, were empty or had very few passengers as the stayaway bit.

Nurses, exempted from the stayaway, struggled to get to work in the few taxis operating.

The Greatest Name in Cigarettes

Rothmans

100th YEAR

City Press cartoonist **Abu Berry** pays tribute to workers on the 100th anniversary of May Day

But pupils were told they could stay at home if they chose.

The exception was Kwa-Zulu, where classes were held "as normal" after a directive from KwaZulu Education Minister Oscar Dhlomo.

South Africa's mines were the only area where clashes had been reported with police at the time of the stayaway call.

According to a National Union of Mineworkers spokesman, armed mine security police and white mine officials broke up a meeting at Liberton gold mine just before night-shift workers were due to leave a May Day meeting.

"When they saw the miners weren't prepared to go underground, they fired tear gas and tried to force them out," the spokesman said.

A mine security spokesman said police were "preventing the intimidation of mineworkers who wanted to work."

Most Western Transvaal miners were reported to have observed the call for no work, following the NUM's successful court battle over the right to strike on May Day.

Stayaway extended after ban on rally

ON RALLY

Wentworth ignores cop call

THOUSANDS of Ikageng residents stayed away on May Day ignoring Patches town police using loudhailers and the SADF troops distributing pamphlets which promised protection and urging workers to shun the stay away.

Ikageng ignores cop call

THOUSANDS of workers gathered at Soweto's Orlando Stadium yesterday to commemorate May Day.

By midday more than 15 000 workers wearing colorful T-shirts had assembled for what promised to be a big rally.

But by the time they arrived cops and soldiers had already taken positions outside the stadium.

They came in three Caspers, six Buffels, trucks and three Mellow Yellow buses — with a water-tanker in tow.

The workers — men and women wearing T-shirts representing trade unions at the rally — danced and sang around the arena chanting

Port Elizabeth

Port Elizabeth workers are planning to shut down the city until Monday — because their indoor May Day rally was banned at the last minute by the city's acting chief magistrate.

And their May Day celebrations — scheduled for 10am yesterday and banned by acting chief magistrate DFM Smith in terms of Section 40 (1) (b) of the Internal Security Act — will now be held at the Active Transport Hall in Korsten at 10am on Monday.

The banning notice — from yesterday at 5pm — was addressed to Congress of SA Trade Unions PE chairman and May Day Coordinating Committee chairman A Mkalipi on Wednesday.

The decision to extend the stayaway was announced in thousands of pamphlets distributed in the black townships by the area and street committees last night.

The pamphlets — issued by the co-ordinating committee which represents the Cosatu, the United Democratic Front and the Council of Unions of SA — said: "Bannings won't stop us. The banning is a clear indication that the State

Johannesburg

THOUSANDS of workers gathered at Soweto's Orlando Stadium yesterday to commemorate May Day.

By midday more than 15 000 workers wearing colorful T-shirts had assembled for what promised to be a big rally.

But by the time they arrived cops and soldiers had already taken positions outside the stadium.

They came in three Caspers, six Buffels, trucks and three Mellow Yellow buses — with a water-tanker in tow.

The workers — men and women wearing T-shirts representing trade unions at the rally — danced and sang around the arena chanting

A rainbow of T-shirts for freedom

Planeloads of cops look the registration numbers of all vehicles entering the stadium.

Speakers at the rally included Cosatu president Elijah Buraya, NUM secretary general Cyril Ramaphosa and Soweto Civic Association organising secretary Amos Masondo.

Other speakers included

Wentworth ignores cop call

THOUSANDS of Ikageng residents stayed away on May Day ignoring Patches town police using loudhailers and the SADF troops distributing pamphlets which promised protection and urging workers to shun the stay away.

Wentworth ignores cop call

THOUSANDS of workers gathered at Soweto's Orlando Stadium yesterday to commemorate May Day.

By midday more than 15 000 workers wearing colorful T-shirts had assembled for what promised to be a big rally.

But by the time they arrived cops and soldiers had already taken positions outside the stadium.

They came in three Caspers, six Buffels, trucks and three Mellow Yellow buses — with a water-tanker in tow.

The workers — men and women wearing T-shirts representing trade unions at the rally — danced and sang around the arena chanting

Wentworth ignores cop call

THOUSANDS of Ikageng residents stayed away on May Day ignoring Patches town police using loudhailers and the SADF troops distributing pamphlets which promised protection and urging workers to shun the stay away.

Wentworth ignores cop call

THOUSANDS of workers gathered at Soweto's Orlando Stadium yesterday to commemorate May Day.

By midday more than 15 000 workers wearing colorful T-shirts had assembled for what promised to be a big rally.

But by the time they arrived cops and soldiers had already taken positions outside the stadium.

They came in three Caspers, six Buffels, trucks and three Mellow Yellow buses — with a water-tanker in tow.

The workers — men and women wearing T-shirts representing trade unions at the rally — danced and sang around the arena chanting

Wentworth ignores cop call

THOUSANDS of Ikageng residents stayed away on May Day ignoring Patches town police using loudhailers and the SADF troops distributing pamphlets which promised protection and urging workers to shun the stay away.

Wentworth ignores cop call

THOUSANDS of workers gathered at Soweto's Orlando Stadium yesterday to commemorate May Day.

By midday more than 15 000 workers wearing colorful T-shirts had assembled for what promised to be a big rally.

But by the time they arrived cops and soldiers had already taken positions outside the stadium.

They came in three Caspers, six Buffels, trucks and three Mellow Yellow buses — with a water-tanker in tow.

The workers — men and women wearing T-shirts representing trade unions at the rally — danced and sang around the arena chanting

Wentworth ignores cop call

THOUSANDS of Ikageng residents stayed away on May Day ignoring Patches town police using loudhailers and the SADF troops distributing pamphlets which promised protection and urging workers to shun the stay away.

Wentworth ignores cop call

THOUSANDS of workers gathered at Soweto's Orlando Stadium yesterday to commemorate May Day.

By midday more than 15 000 workers wearing colorful T-shirts had assembled for what promised to be a big rally.

But by the time they arrived cops and soldiers had already taken positions outside the stadium.

They came in three Caspers, six Buffels, trucks and three Mellow Yellow buses — with a water-tanker in tow.

The workers — men and women wearing T-shirts representing trade unions at the rally — danced and sang around the arena chanting

Wentworth ignores cop call

THOUSANDS of Ikageng residents stayed away on May Day ignoring Patches town police using loudhailers and the SADF troops distributing pamphlets which promised protection and urging workers to shun the stay away.

Wentworth ignores cop call

THOUSANDS of workers gathered at Soweto's Orlando Stadium yesterday to commemorate May Day.

By midday more than 15 000 workers wearing colorful T-shirts had assembled for what promised to be a big rally.

But by the time they arrived cops and soldiers had already taken positions outside the stadium.

They came in three Caspers, six Buffels, trucks and three Mellow Yellow buses — with a water-tanker in tow.

The workers — men and women wearing T-shirts representing trade unions at the rally — danced and sang around the arena chanting

Wentworth ignores cop call

THOUSANDS of Ikageng residents stayed away on May Day ignoring Patches town police using loudhailers and the SADF troops distributing pamphlets which promised protection and urging workers to shun the stay away.

Wentworth ignores cop call

THOUSANDS of workers gathered at Soweto's Orlando Stadium yesterday to commemorate May Day.

By midday more than 15 000 workers wearing colorful T-shirts had assembled for what promised to be a big rally.

But by the time they arrived cops and soldiers had already taken positions outside the stadium.

They came in three Caspers, six Buffels, trucks and three Mellow Yellow buses — with a water-tanker in tow.

The workers — men and women wearing T-shirts representing trade unions at the rally — danced and sang around the arena chanting

Wentworth ignores cop call

THOUSANDS of Ikageng residents stayed away on May Day ignoring Patches town police using loudhailers and the SADF troops distributing pamphlets which promised protection and urging workers to shun the stay away.

Wentworth ignores cop call

THOUSANDS of workers gathered at Soweto's Orlando Stadium yesterday to commemorate May Day.

By midday more than 15 000 workers wearing colorful T-shirts had assembled for what promised to be a big rally.

But by the time they arrived cops and soldiers had already taken positions outside the stadium.

They came in three Caspers, six Buffels, trucks and three Mellow Yellow buses — with a water-tanker in tow.

The workers — men and women wearing T-shirts representing trade unions at the rally — danced and sang around the arena chanting

Wentworth ignores cop call

THOUSANDS of Ikageng residents stayed away on May Day ignoring Patches town police using loudhailers and the SADF troops distributing pamphlets which promised protection and urging workers to shun the stay away.

Wentworth ignores cop call

THOUSANDS of workers gathered at Soweto's Orlando Stadium yesterday to commemorate May Day.

By midday more than 15 000 workers wearing colorful T-shirts had assembled for what promised to be a big rally.

But by the time they arrived cops and soldiers had already taken positions outside the stadium.

They came in three Caspers, six Buffels, trucks and three Mellow Yellow buses — with a water-tanker in tow.

The workers — men and women wearing T-shirts representing trade unions at the rally — danced and sang around the arena chanting

Wentworth ignores cop call

THOUSANDS of Ikageng residents stayed away on May Day ignoring Patches town police using loudhailers and the SADF troops distributing pamphlets which promised protection and urging workers to shun the stay away.

Wentworth ignores cop call

THOUSANDS of workers gathered at Soweto's Orlando Stadium yesterday to commemorate May Day.

By midday more than 15 000 workers wearing colorful T-shirts had assembled for what promised to be a big rally.

But by the time they arrived cops and soldiers had already taken positions outside the stadium.

They came in three Caspers, six Buffels, trucks and three Mellow Yellow buses — with a water-tanker in tow.

The workers — men and women wearing T-shirts representing trade unions at the rally — danced and sang around the arena chanting

Wentworth ignores cop call

THOUSANDS of Ikageng residents stayed away on May Day ignoring Patches town police using loudhailers and the SADF troops distributing pamphlets which promised protection and urging workers to shun the stay away.

Wentworth ignores cop call

THOUSANDS of workers gathered at Soweto's Orlando Stadium yesterday to commemorate May Day.

By midday more than 15 000 workers wearing colorful T-shirts had assembled for what promised to be a big rally.

But by the time they arrived cops and soldiers had already taken positions outside the stadium.

They came in three Caspers, six Buffels, trucks and three Mellow Yellow buses — with a water-tanker in tow.

The workers — men and women wearing T-shirts representing trade unions at the rally — danced and sang around the arena chanting

East London

Cosatu warns against sackings

FACTORIES and businesses in the border area came to a halt yesterday as thousands of workers responded to the May Day call.

And while many organisations were preparing to attend rallies yesterday morning, the UDF and Cosatu called on bosses to recognise May Day as a public holiday.

They warned that dismissals at De Gama Textiles, Trace Industries, SA Transport Services and in the Fort Jackson industrial area would not go unchallenged.

Schools in black, coloured and Indian areas were closed as pupils stayed away, despite the heavy presence of security forces in Duncan Village and its surrounding areas.

Meanwhile, Captain H Koegelenberg of East London's security police said police warned Sasu on Tuesday night that it was a crime to disrupt the city's essential services and to encourage workers to stay away.

● A ballot to gauge the response of traders to the May Day stayaway call by unions and the UDF was conducted by security cops, a spokesman for the East London Oriental Plaza Traders Association said.

Port Elizabeth

Port Elizabeth workers are planning to shut down the city until Monday — because their indoor May Day rally was banned at the last minute by the city's acting chief magistrate.

And their May Day celebrations — scheduled for 10am yesterday and banned by acting chief magistrate DFM Smith in terms of Section 40 (1) (b) of the Internal Security Act — will now be held at the Active Transport Hall in Korsten at 10am on Monday.

The banning notice — from yesterday at 5pm — was addressed to Congress of SA Trade Unions PE chairman and May Day Coordinating Committee chairman A Mkalipi on Wednesday.

The decision to extend the stayaway was announced in thousands of pamphlets distributed in the black townships by the area and street committees last night.

The pamphlets — issued by the co-ordinating committee which represents the Cosatu, the United Democratic Front and the Council of Unions of SA — said: "Bannings won't stop us. The banning is a clear indication that the State

Johannesburg

THOUSANDS of workers gathered at Soweto's Orlando Stadium yesterday to commemorate May Day.

By midday more than 15 000 workers wearing colorful T-shirts had assembled for what promised to be a big rally.

But by the time they arrived cops and soldiers had already taken positions outside the stadium.

They came in three Caspers, six Buffels, trucks and three Mellow Yellow buses — with a water-tanker in tow.

The workers — men and women wearing T-shirts representing trade unions at the rally — danced and sang around the arena chanting

Wentworth ignores cop call

THOUSANDS of Ikageng residents stayed away on May Day ignoring Patches town police using loudhailers and the SADF troops distributing pamphlets which promised protection and urging workers to shun the stay away.

Wentworth ignores cop call

THOUSANDS of workers gathered at Soweto's Orlando Stadium yesterday to commemorate May Day.

By midday more than 15 000 workers wearing colorful T-shirts had assembled for what promised to be a big rally.

But by the time they arrived cops and soldiers had already taken positions outside the stadium.

They came in three Caspers, six Buffels, trucks and three Mellow Yellow buses — with a water-tanker in tow.

The workers — men and women wearing T-shirts representing trade unions at the rally — danced and sang around the arena chanting

Workers enact struggle

IN April 1985 1 000 workers at the British Tyre Rubber Company in Howick, near Pietermaritzburg, went on a legal strike for 11 months over the company's refusal to negotiate a recognition agreement with their union, Mawu.

Spreading from Mphophomeni Township in Howick to Pietermaritzburg and Durban, the strike soon became a community affair. A co-operative was started to print union T-shirts and raise relief funds.

A play telling the story of the strike was also performed in churches and halls in Natal. The show is now in Johannesburg for a series of performances.

Performances are being co-ordinated by professional actor Ramolao Makhene. The *Long March*, as the play is

titled, has been getting "excellent" response from workers and audiences at performances in Lenasia, Witbank and Dobsonville, says Makhene.

"It inspires and motivates workers", he says.

Further performances include a one week run at the Wits Box Theatre starting on May 14 at 12 30 in the afternoons and 7 30 in the evenings. Groups and organisations are invited to make block bookings for the Wits shows.

Other performance dates are D H Williams Hall, Natalspruit, May 24, 2 pm, Saint Francis Anglican Church, Moroka, June 1, 2 pm.

Other performances at Saint Paul's and Saint Matthew's Anglican churches in White City and Emdeni, Soweto are still to be confirmed.

132

170

Sawyer 1/1/86

653 276 people in SA unemployed in 1985

132
15/5/86
Parliamentary Staff

UNREST and measures taken by foreign countries, including disinvestment and high interest rates, have cost jobs in South Africa.

Unemployment was growing and because of these influences was likely to increase further, the latest annual report of the Department of Manpower says

And despite the substantial reforms in labour laws and relations, South Africa continued to be isolated in international labour organisations

The report says international action was directed towards political and governmental reform rather than changes in labour relations

Last year saw the formation of the Congress of South African Trade Union Unions (Cosatu) which also marked political targets among its objectives

Employment declined in all non-agricultural sectors with blacks being the hardest hit while real earnings dropped by 3,2 percent with whites being the worst affected

- Registered unemployment (which does not reflect the real position, particularly of blacks) showed a an overall increase of 73 percent between November last year and November 1984 with a total of 125 325 unemployed people

Far worse

However the position according to the current population census was far worse with an estimated 515 000 blacks, 88 000 coloured, 22 505 Indians and 27 771 whites unemployed in September 1985

- The number of strikes dropped last year to 389 from 469 the previous year but the duration increased from 2,1 days on average to 2,8

The most common cause of strikes continued to be wage related while the number of strikes related to the dismissal of redundant workers had decreased as a result of bargaining procedures becoming "generally accepted practice"

- The Sullivan Code which is intended to protect black workers appears to protect more whites than blacks.

The 178 signatory companies employ about 100 000 people of whom 60 percent are whites

NT

15/5/86 - BUS DAY -

ILO attitude to SA is 'negative'

THE attitude of the International Labour Organisation (ILO) toward SA remains "negative", despite reforms in the labour field, says the National Manpower Commission.

In its annual report for 1985, tabled yesterday, the commission said the ILO's attitude could be seen in its updated "Declaration on Apartheid" and in anti-SA actions by countries and employer and employee federations.

These included boycotts, the discouraging of investment, the withdrawal of capital and the discouraging of political, diplomatic, structural and other relations with SA.

An ILO publication had stated that employment and social security conditions remained "much the same" for blacks.

It said that they continued to be adversely affected by apartheid, homeland development and racial discrimination, despite the repeal of certain racial provisions in legislation.

The report said that, during 1985, the International Confederation of Trade Unions, to which some of the country's newer unions were affiliated, continued support for the "independent" union movement in SA.

It also indicated support for labour codes like the European Economic Community code and the Sullivan Principles.

The commission said the most recent survey showed that 178 SA signatories to the Sullivan Code employed about 100 000 people, 60% of whom were white.

Further progress in applying the code had been achieved in 1985, it said.

132

Test case for union politics

THE town of Brits north west of Pretoria has been in the headlines recently because of the ill-fated visit by Deputy Minister of Information, Mr Louis Nel, who was booed off the stage by members of the Afrikaner-Weerstandsbeweging

Less well known is that an event of deep political significance is unfolding in Brits's old black location, where the community is resisting what it sees as a forced removal to the new township of Lethlabile, 17 km from Brits

Brits is an example of the politics of unions and employers — which has been the cutting edge of black-white relations in this country for more than seven years — spilling over into the communities, rather than vice versa.

The Brits location is a union town and opposition to the removal has been spearheaded by union leaders, who have brought to the battle a pragmatic style of politics born of more than a decade of gradually acquiring power on the shop-floor.

More remarkable is the response of Brits employers and the national employer federations who have intervened to try to stop the removal

With the anti-removals Brits Action Committee supplanting the community council as the township's representatives, Brits is emerging as a test case of whether an unofficial body can pose as a local authority and oversee the upgrading of a township

This is particularly significant in the alleged post-influx-control era — with infrastructure, housing and amenities becoming a desperate priority — but which coincides with the near-collapse of the government's black local authorities system

Against removal

he old location — known to residents as "Oukasie" — is right next to a white suburb and has been earmarked for removal for 25 years, though removals of families to Lethlabile only started at the end of last year

Some 5 000 out of 15 000 original residents of the old location were moved out — some because of the handsome financial compensation on offer, others because they were lodgers and had nowhere to stay when their landlords' homes were demolished, and others because they were government employees or policemen

The rest of the community is dead set against removal from the place they have lived in for 55 years because of the long distances they will have to travel to work and because of fears that Lethlabile, which borders Bophuthatswana, is to be incorporated into the homeland

What makes Brits unusual is that many of the leaders are shop stewards from the two leading unions in the area — the National Automobile and Allied Workers' Union (NAAWU) and the Metal and Allied Workers' Union (MAWU).

They have brought to the location a form of politics — working squarely within mandates towards achievable goals through pressure as well as negotiation — which they have learnt on the shop-floor

It is a style which has seldom been extended into the struggles in the townships, though unions are increasingly becoming a factor in the townships

Thus the Brits Action Committee first negotiated the departure of the army and the police from the township. They then managed, through negotiation, to secure facilities for meetings and, through Supreme Court action, got the development board to stop demolishing houses evacuated by people moving to Lethlabile, allocating them to people on the housing waiting list instead

Their next target is to get the township reprieved by the government and, finally, they aim to get employers to finance the upgrading of the township by providing drainage, sewage, tarred roads, electricity and improved housing

Reasoned settlement

Mr Taffy Adler, the Transvaal secretary of NAAWU, says the key difference between the unions and other organizations in the township is that the unions are used to playing the politics of power and not simply of protest.

"The unions are able to say 'These are our immediate goals,' and to use their access to pressure to reach a reasoned settlement. I doubt whether the removal could have been stopped if it hadn't been for the involvement and pressure of the unions on the employers"

The involvement of employers is also indicative of a new-found willingness to act against what they perceive as injustice. This was seen, for instance, in the employer-initiated appeal against the bannings of Eastern Cape activists Mr Henry Fazzie and Mr Mkhusele Jack.

The Federated Chamber of Industries (FCI) has arranged a meeting between the BAC and the MP for Brits, Dr Jan Grobler, and the Steel and Engineering Industries Federation of South Africa (Seifsa) has put pressure on the government to suspend the removal

Mr Arthur Hammond-Tooke of the FCI says the FCI is attempting to play the role of "principled mediation" because it feels that "while we have credibility with the government, we have some insight into the other side. We're using our influence to give the Brits community a hearing".

Mr Hammond-Tooke is aware of the importance of the issue "It's a test case for the whole country," he says

Sacked workers take case to court

Hospital workers who were dismissed from the Welkom Provincial Hospital for staging a work stoppage have applied to the Industrial Court for reinstatement

A spokesman for the Orange Vaal General Workers' Union, Mr Stanley Tyelentombi, said the union had applied for the reinstatement of 164 black workers dismissed in April.

The application was made in terms of Section 43 of the Labour Relations Act.

He said papers had been served on the superintendent of the hospital as well as the Administrator of the Orange Free State.

About 200 workers staged a two-day work stoppage over wages, recognition of the union and lack of communication with hospital authorities. They were all dismissed but some were selectively re-hired.

"We believe the dismissals were unfair. No effective channels of communication existed between workers and hospital authorities," said Mr Tyelentombi.

Provincial authorities are expected to file papers in response to the union application.

Gastrow warns on labour problems

By FRANS ESTERHUYSE
Parliamentary Staff

A WARNING has been given in Parliament that a delay in constitutional change could result in serious labour problems.

Mr Peter Gastrow (PFP Durban Central) said there was a real danger that the evolutionary development of the collective bargaining process would disintegrate

Speaking in yesterday's House of Assembly debate on the manpower budget vote, Mr Gastrow said the labour arena

was today one of the few forums where blacks and whites negotiated and bargained from fairly equal power bases

He added his warning that this could not last in the absence of early constitutional change

Mr Gastrow also said that consumer boycotts and stay-aways were "here to stay" for as long as freedom of political association was restricted and for as long as blacks had no effective say in government

It was to the credit of the

collective bargaining machinery that against this background an increasing number of industrial disputes had been resolved by institutional methods

Mr Gastrow said the last six months saw the creation of two labour movements, Cosatu and Uwusa, which would have an impact on the labour scene

"Clearly these and other labour movements are not going to confine their interests and activities to conflicts of interest between management and labour."

1799 PER M

FOR THE FIRST YE

THIS IS A GENUINE OPPORTUNITY TO MAKE
INVESTMENT BY PURCHASING THIS SUPERB H
FROM THE DEVELOPER

PHONE RICHARD JACKSON AT 415-1630 (ALL
MAKE AN APPOINTMENT TO VIE

ON SHOW THIS SUNDAY 2

Supervisors ^{29/5/81} need new skills, ^{STAR} says Godsell 132

By Sheryl Raine

Supervisors who continue to exercise control on the basis of racial authority are playing Russian roulette in the workplace, according to Mr Bobby Godsell, head of the Anglo American group's industrial relations department

In Kempton Park yesterday, at an SA Institute of Supervisors seminar on the role of the supervisor in a changing South Africa, Mr Godsell said changing racial norms and attitudes in the country demanded new skills from supervisors

The institute has launched an aggressive campaign to upgrade the status of supervisors. As first line managers they have considerable impact on labour relations and productivity levels. But it has been found that the role and skills of the supervisor have been largely neglected in industry even though the supervisor is a key salesman of management policy to employees

AUTOMATICALLY OBEYED

"In the past, white supervisors had authority because they were white," said Mr Godsell. "They gave instructions and expected to be automatically obeyed because they were the baas as well as the boss."

"Social norms have changed. The inherent authority of the white supervisor is disintegrating. People who supervise on the basis of racial authority are playing Russian roulette. These days on the mines if you call a black worker a kaffir you are taking your life in your hands."

"The predominant white supervisory style is like a parking meter which has expired."

At present there were about 500 000 supervisors of all races in the country, and Mr Godsell estimated that only about five percent had the necessary training to do their jobs effectively

He urged management to give black and white supervisors the skills and the authority to supervise, to define their task clearly and to increase their status and reward for performing a key function in industry

June 16 and May 1 as holidays

By Mike Siluma

The Textile Workers' Industrial Union of S A (TWIU), which dis-affiliated from the Trade Unions Council of S A (Tucsa) at the weekend, has called for the recognition of May 1 and June 16 as paid holidays.

The union, at a congress in Cape Town, also called for the immediate withdrawal of the army and police from townships and schools, saying the security force presence was "highly intolerable and aggravates the problems our members are facing"

It demanded the total scrapping of apartheid, which, it said, could not be reformed.

While reiterating its political non-affiliation, the TWIU said matters affecting the lives of its members could not be ignored

The union condemned the "senseless killing of people and the burning of homes and possessions", in particular the violence which broke out in the Crossroads squatter camp recently.

TWIU secretary Mr Norman Daniels said this week it had decided to leave Tucsa because of "the irrelevance of Tucsa in our members' fight against apartheid"

It also called for a 40-hour working week for the workers

Firms will face tougher demands

By Sheryl Raine
Companies will face tough demands for salary increases this year due to the high rate of inflation and to militant trade unions, according to a leading industrial relations consultant

Mr Stuart Pennington of Stuart Pennington and Associates noted in the company's May 1986 wage negotiations pack that the relative sluggishness of the economy had been reflected in lower pay increases granted to salary and wage earners

at the end of last year and beginning of this year

Salary increases had lagged significantly behind the consumer price index of 18,8 percent for the 12-month period from February 1985 to February 1986

INCREASES

Overall salary increases amounted to 11,1 percent, artisan wages rose by 9,2 percent and non-white hourly-paid wages by 12 percent

Predicted pay increases for this year included 11 to 12 percent for general staff, 12,5 to 14 percent for black hourly-paid staff and 12 to 13 percent for specialist or middle management

The inflation rate for February was 18,1 percent and economic predictions indicated that it was unlikely to drop significantly. Companies would therefore be hard pressed to keep pace with increasing pay demands

Information about the economy, wages, salaries, and cost of living factors would play a vital role in the bargaining process this year

The wage pack is designed to assist management with wage negotiations



Offers valid while stocks last



Premier Food, Anglo American lead in new June 16, May 1 hol

By Sheryl Raine

Premier Food Industries, a wholly-owned subsidiary of the Premier Group, has become the first major employer to declare June 16 and May 1 paid company holidays for 24 000 employees of all races

At the same time Anglo American is to close its head office at midday on June 16

The move by Premier is likely to prompt other major employers, faced with growing demands from emergent trade unions, to recognise May Day and June 16

Up until now, only a handful of employers have recognised May Day. Even fewer have recognised June 16, the date of the Soweto riots and a day regarded with hostility by many white employers

In a statement released by Premier's human resources director, Mr Rob Childs, the company said "These two days, together with New Year's Day, Good Friday, Ascension Day, Republic Day, Day of The Vow and Christmas Day (the existing statutory paid holidays in terms of the Basic Conditions of Employment Act) will now constitute paid holidays for all factory employees

Not views of all

"It has become manifestly clear that the existing public holidays do not appropriately reflect the views of all sections of South African society"

The Premier decision is a dramatic departure from the Federated Chamber of Industries (FCI) guideline that employers adopt a policy of "no work, no pay, no disciplinary action," towards workers who did not report for work on May Day and for those who do not report on June 16

The Premier decision is also a breakthrough for major union federations, including the Council of Unions of SA (Cusa) and the Congress of SA Trade Unions (Cosatu) which this year made May 1 and June 16 priority demands

May 1 was celebrated with the biggest nationwide stayaway ever recorded in South Africa — between 70 and 100 percent absenteeism June 16, which falls on a Monday this year, and marks the 10th anniversary of the Soweto riots, is also expected to be a major event

Anglo American's decision was announced in a statement last night by Anglo chairman Mr Gavin Relly, who said it was becoming increasingly evident South Africa's calendar of public holidays no longer reflected "the full spectrum of national sentiment"

"Each year since 1976 groups of South Africans have wished to commemorate the tragic events which occurred on June 16 in that year. Many now accept that this day has special significance," the statement said

The statement also urged the government to "continue on its path of change, and in particular to facilitate the emergence of national political leadership for black South Africans"

"This will require the unbanning of certain organisations, as well as the release from prison of key black leaders", it said

● See also Page 4.



A Wits student, believed to be a former SRC president, blasts policemen with a spray of tear gas yesterday.



Students hail Mr Ronney Makgosi (left), released by police yesterday after being arrested on Thursday and (right) a police officer draws his gun at the Jan Smuts Avenue entrance of the University of the Witwatersrand after a stone was thrown at a vehicle.

● Photographs: Herbert Mah

30 000 expected

'Commonwealth group has no option left but sanctions'

SADF raids destroyed EPG effort, says ANC

STAR 3/5/86
132
133



Mr Oliver Tambo

By Peter Sullivan

The Commonwealth Eminent Persons Group's hopes of initiating dialogue were shattered by the SADF's triple strike, and the only alternative left to the EPG was to recommend sanctions against South Africa, according to African National Congress headquarters in Lusaka.

But ANC negotiators are still willing to talk to the EPG should the group return to Lusaka.

These ANC positions emerged after interviews in the Zambian capital with the banned organisation's president, Mr Oliver Tambo, ANC external affairs advisor Mr Johnny Makatini, and the number three in its military wing, Mr Joe Slovo.

balking at promised ANC acceptance of a suspension of violence, insisting on the ANC totally renouncing violence

The ANC view is that it cannot decide on a firm policy until its jailed leaders have been unconditionally released so that the party can take a joint decision binding on all its members

HURDLE

The difference between "suspend" and "abandon" appears to the EPG to be the single major obstacle left to hurdle before negotiations can get going.

X Report restricted

Mr Tambo, Mr Makatini and Mr Slovo may not be quoted in South Africa

June 16 general strike could 'get out of hand'

LUSAKA — A general strike called by the ANC to mark the 10th anniversary of the Soweto uprising on June 16 could get "out of hand" and continue indefinitely, according to an African National Congress spokesman.

He said: "June 16 is an explosive day at the best of times. We have called a general strike. We will appeal to our people to make it one of the biggest strikes we have had."

"Once it starts the momentum could carry it beyond June 16. If that is so, we wouldn't complain," the spokesman said.

In a series of interviews at ANC headquarters it became apparent a major fear of the banned organisation is losing the support of the aggressive township youth.

'NOT PEOPLE'S PUPPETS'

There was a feeling that the youth might find the ANC too mild or old-fashioned and be unwilling to obey ANC leadership.

One spokesman said: "We are not the people's puppets. They follow us because they believe we are showing them the right path to democracy."

"If, in their view, we abandon the right path, they will abandon us and follow whomever they consider to be the true leaders."

Mr Joe Slovo, Chief of Staff of the banned military wing of the ANC, Umkhonto we Sizwe, expressed fears of the organisation being hijacked by extremists to the Left of the communist party.

X Report restricted

MOMENTUM

All three — none of whom may be quoted in South Africa — feel the EPG initiative is doomed. All believe the Commonwealth group has no option but to impose sanctions on South Africa when the six-month mandate given to the EPG ends in two weeks

The major fear in the ANC is that the EPG will turn into some sort of Namibian Contact group, thereby derailing the momentum already achieved towards imposing Commonwealth sanctions on South Africa.

In Namibia the Western Five contact group was appointed to find an internationally-accepted solution. The appointment of the group temporarily halted a planned campaign for sanctions.

VIOLENCE

"The EPG is beginning to sound like a rerun of the Contact Group in Namibia where the whole process was deliberately protracted over a period of time so that the regime could be left free to deal with domestic matters on the pretext that international negotiations were taking place," an ANC spokesman said.

Meanwhile the South African Government is still apparently

Love is jus

NEW YORK — People aged 60 and over in a relationship as their children fall in love in much the same way, a

According to an article in the Journal of Gerontology older people get all the physiological ailments of teenagers when they fall in

These include a heightened sensitivity of awkwardness, inability to control emotions from the loved one and heart palpitations. The study by two University of Minnesota researchers

The researchers interviewed 45 people aged 60 to 92, all of whom live in a Midwestern city and are actively dating.

The article quotes a 71-year-old woman: "You can talk about candlelight dinners and a fireplace, but I still think the most romantic thing is to go to bed with her."

Sackings and the law: video

132

w/EP post 3/15/86

INDUSTRIAL relations in the Eastern Cape has pioneered another breakthrough — the launch of a comprehensive video programme on the complicated question of Industrial Courts and unfair labour practices.

It will be the first programme of its type produced in South Africa and is the result of thousands of hours of work in script-writing, rehearsal and filming with a professional and semi-professional cast of more than 60

The concept of producing the R90 000 series of three videos — with a total viewing time of 105 minutes — is that of University of Port Elizabeth industrial training consultant Bruce Bishop

Production has taken place on location at factories and offices in the

Eastern Cape and at Port Elizabeth's Emthonjeni Training Centre, under the direction of the training centre's audio-visual manager Bata Paschier

Financial backing has been provided by local industry and the project has the full support of UPE

"Over the years since the Wiehahn Commission [on industrial relations], much theoretical training has been directed at senior management," said the head of the university's Industrial Relations Unit, Prof Roux van der Merwe

"But the vital areas of middle management — and especially shopfloor training — has received very little appropriate attention"

Prof Van der Merwe said the training programme had been researched and

developed to address these shortcomings and to switch the emphasis to a straightforward and practical approach to that "crucial interface where the majority of disciplinary problems arise"

"That's the shopfloor," said Mr Bishop, who first realised the shortcomings of current training three years ago while himself working in industry

"What we want to do is to make it as easy as possible for line management — who have lots of other things to do — to understand the law and regulations covering dismissals and to prevent time and money being wasted"

Mr Bishop added that the course would also be available to trade unions

"After thinking about it and discussing it, I thought the best method would be to

produce an 'action drama' on video as a service to industry throughout South Africa"

Turning the idea into action produced an immediate shock for Mr Bishop — the initial quote for filming by a Transvaal company was R250 000

But Emthonjeni — which has full professional-level equipment and staff — was anxious to undertake the project at a reduced cost and filming began late last year

Borrowing props from local shops and companies and using their premises — "The level of co-operation was fantastic," said Mr Bishop — filming often took place after hours and over weekends

"There were many times when we worked into the early hours of the morning

to get everything just right as it was essential the programmes were totally realistic," said Mr Bishop

Result of the months of work is the series, which is broken into three parts

The first deals with 10 key aspects of unfair dismissal actually dealt with by the Industrial Court and contained in five dramatically produced case studies

The second deals with the "real life" consequences of these, from the highly emotional reaction of management through to large amounts of time, production and cost being lost through preparing for and appearing before the Industrial Court

The final part shows how the cases should have been handled properly and fairly

Number of strikers has increased 10-fold in 10 years, says annual report

STAR
3/6/86
132
533

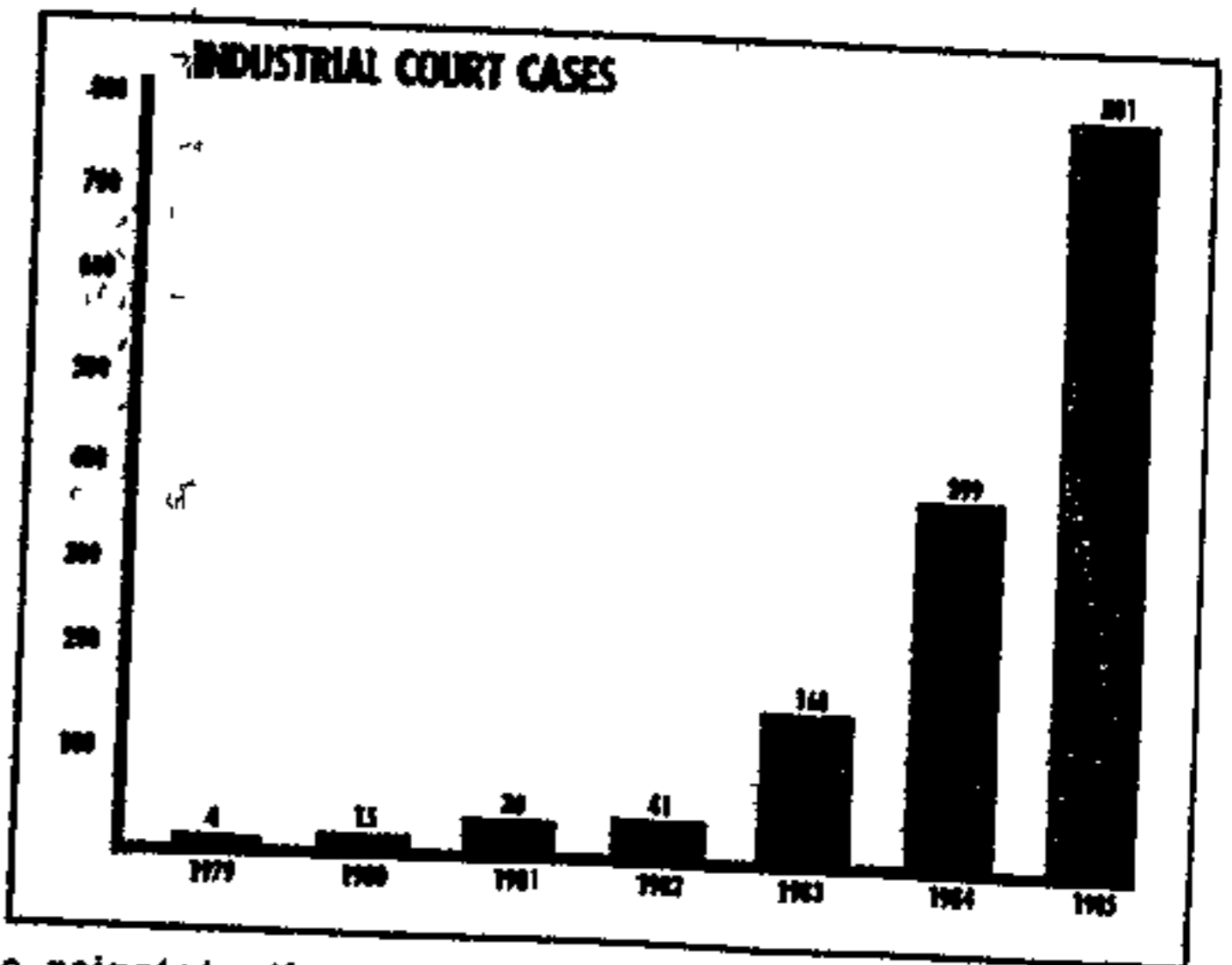
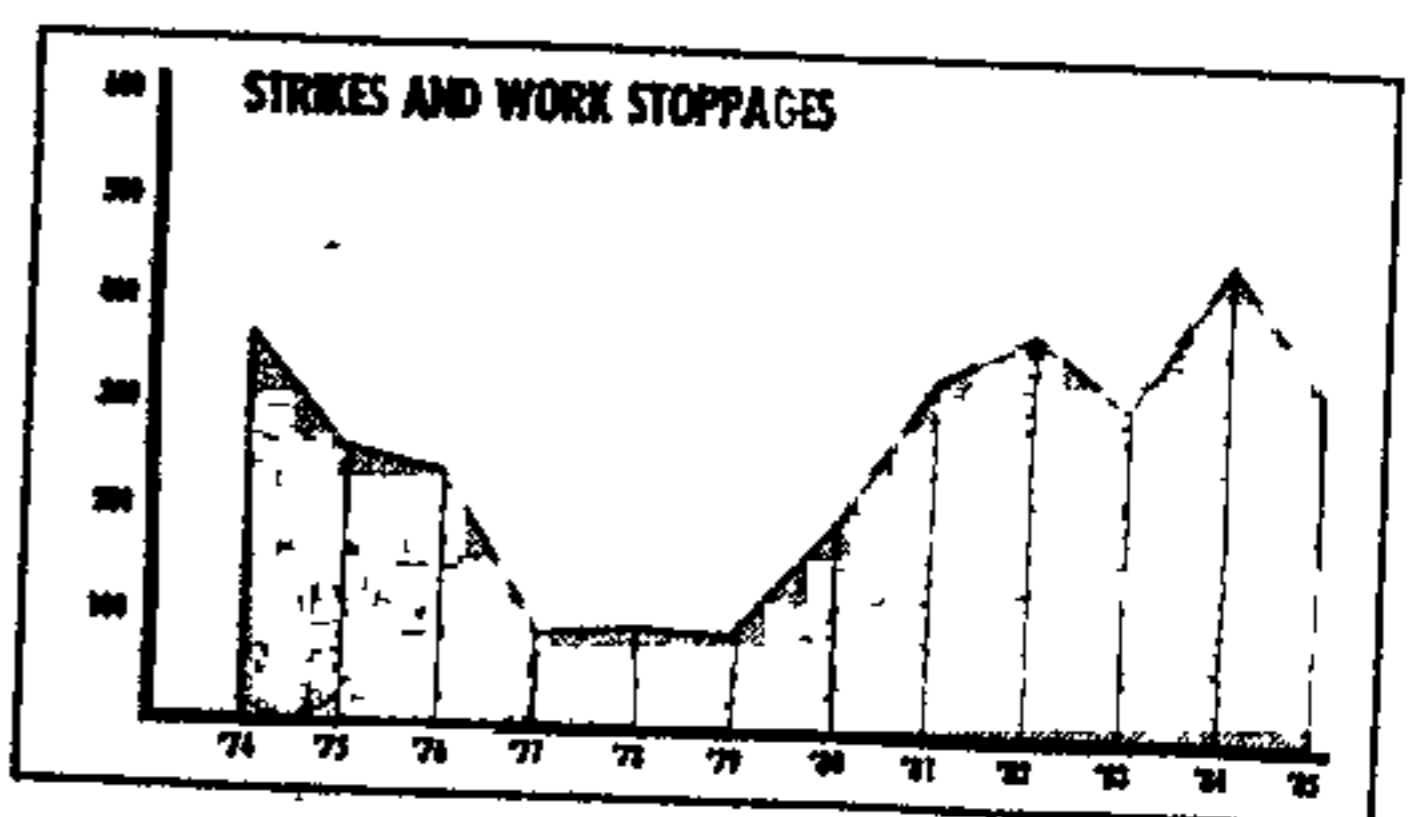
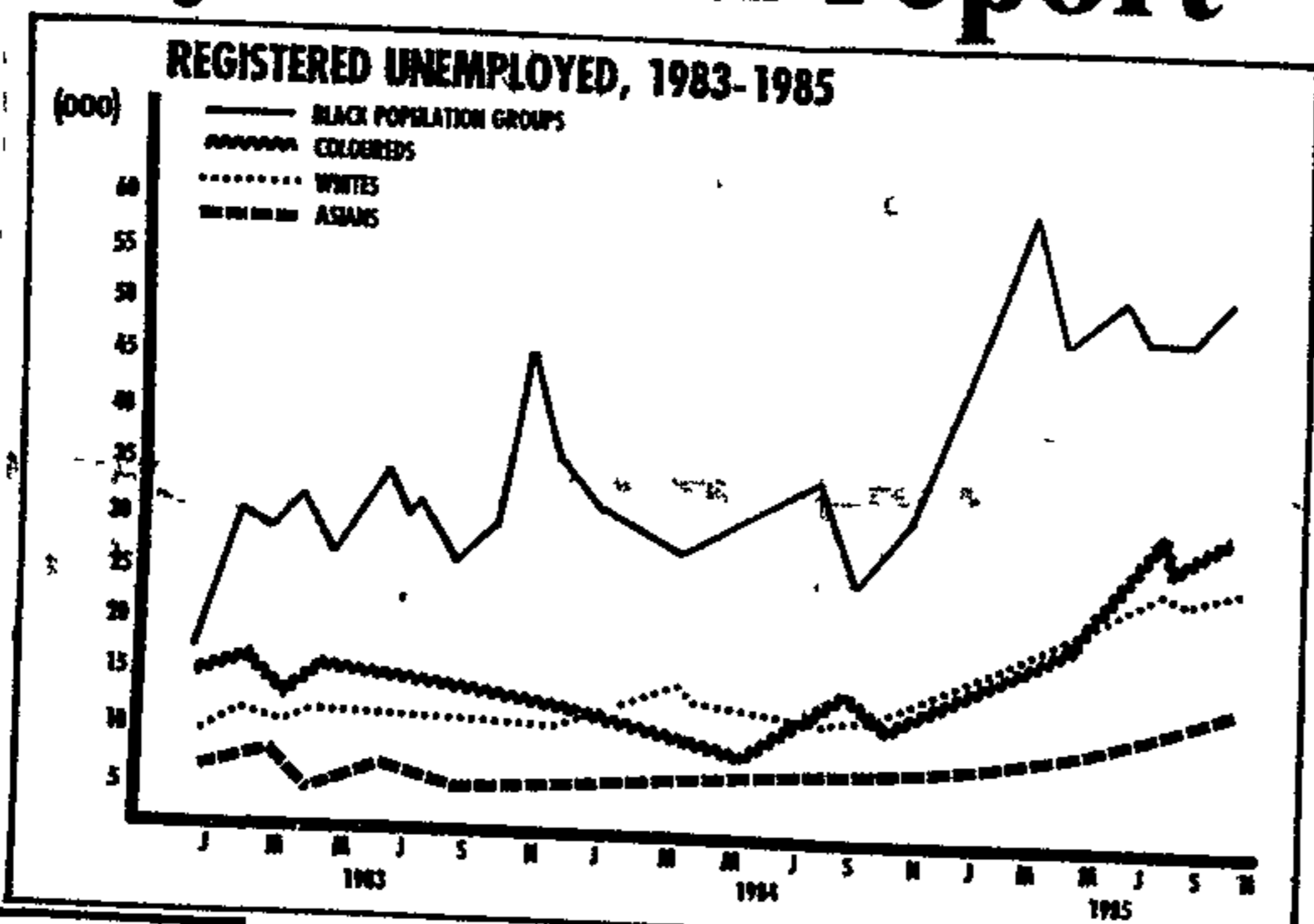
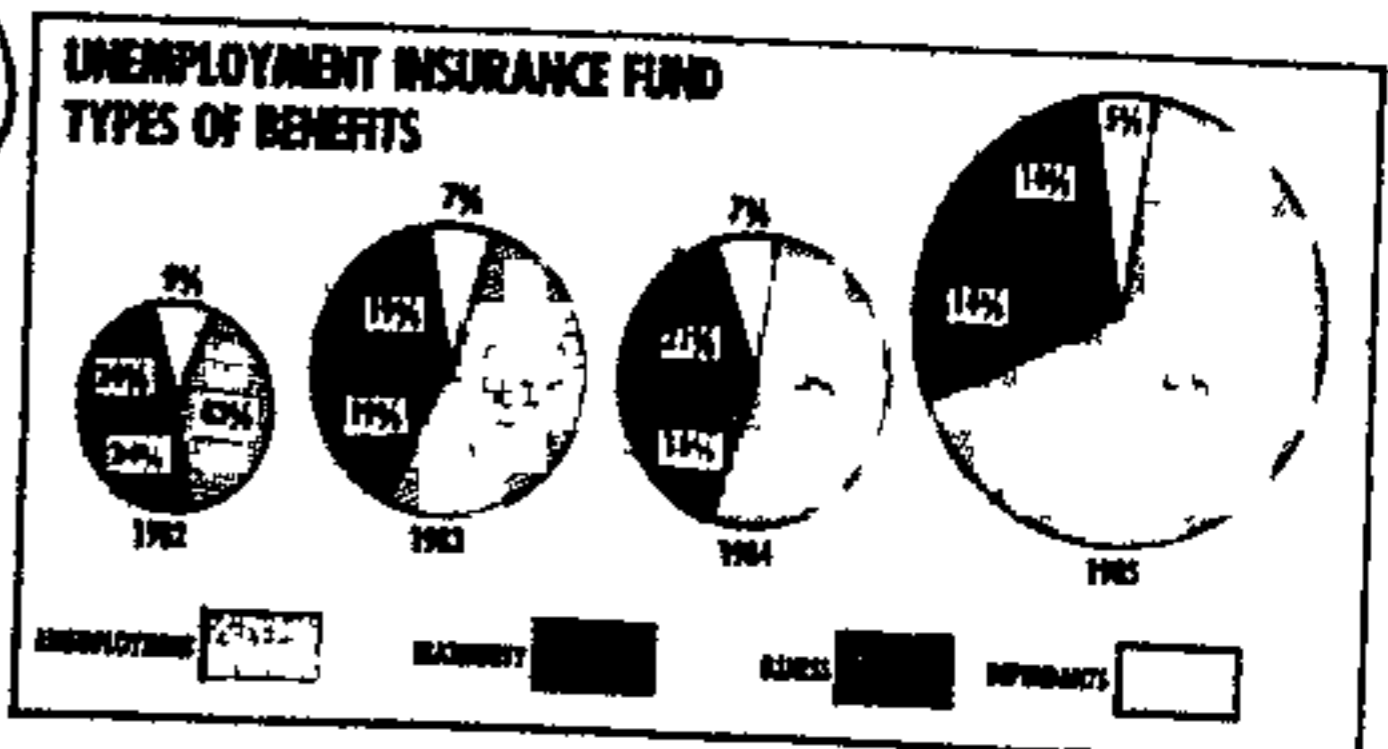

By Sheryl Raine
Wages and pay-related issues were the major causes of strikes last year, the director-general of the Department of Manpower has disclosed.

'Unemployment led to increased unrest' as 200 000 jobs in industry vanish

In his annual report Dr Piet van der Merwe noted that although there were fewer strikes and work stoppages in 1985 (389) than in 1984 (469), more people were involved in strikes last year than ever before.

Last year, 239 816 people went on strike compared with 23 323 a decade ago. The average number of employees per strike increased from 388 during 1984 to 616 during 1985. While only 26 strikes involving more than 1 000 employees took place during 1984, 40 such strikes occurred during 1985.

Disciplinary

Most strikes last year lasted for only a day or less and involved less than 100 workers. Only six strikes lasted for longer than 14 days and only 21 involved 2 000 workers or more.

Apart from wages and allied matters, disciplin-

ary measures by employers were also an important cause of strikes last year.

Worst hit by industrial action was the manufacturing sector. The mining sector, which was less affected by the economic recession than any other sector, was also hard hit.

Unemployment increased dramatically last year and heavy demands were made on the Unemployment Insurance Fund. More than 200 000 jobs disappeared, the iron and steel industry accounting for the loss of 23 000 and the civil construction industry for 40 000. Many other industries like the motor manufacturing sector and allied industries were also affected by poor economic conditions.

Dr van der Merwe noted that the large number of unemployed had possibly contributed to the unrest in the country.

The nature and extent of strikes last year has led to a re-examination of the dispute-settling procedures laid down in the law.

The National Manpower Commission is investigating the following with a view to improving the dispute-settling system.

- Decriminalising strikes.
- Workers' rights to stage sympathy strikes and the consequences of such strikes.
- The rights of an employer legally entitled to dismiss an employee who strikes illegally while, at the same time, the Industrial Court has the power

to reinstate the employee.

Rivalry growing

Dr van der Merwe noted there had been a marked increase in the membership of trade unions. The largest increase occurred among blacks who had joined unregistered trade unions. There had also been an increase in the number of trade unions which had opened their membership to all population groups.

There were now about 1.9 million trade union members, constituting about 21 percent of the economically-active population. Trade union rivalry was growing.

The number of trade unions using the statutory dispute-settling machinery has also increased. There were 514 applications for conciliation boards last year compared with 279 in 1984 and just 29 in 1979.

Joint call for June 16 stayaway

CAPL 7/23 4/6/86

OWN Correspondent

JOHANNESBURG — Calls for massive anti-government demonstrations on June 16 gathered momentum yesterday when the Congress of South African Trade Unions, the United Democratic Front and the National Education Crisis Committee (NECC) joined forces to issue a call for a one-day work stayaway.

Their joint statement calls on all freedom-loving South Africans, black and white, "to attend with a deep sense of belonging all mass rallies and activities to be conducted on and around June 16, which we regard as a public holiday"

The co-operation on the issue follows "an elaborate and unprecedented process of consultation"

The NECC resolved at its Easter conference to call for a three-day stayaway, but has now opted for solidarity with the two major anti-apartheid organizations in the country

The joint one-day call falls into line with the position of the African National Congress on June 16, but is at odds with the call by affiliates of the Azanian Peoples' Organization and the Council of South African Unions for a two-day stayaway

The statement said "We must remember all our gallant sons and daughters who took to the streets of Soweto and elsewhere to demonstrate their abhorrence of the inferior Bantu education system

"On June 16, like on May Day, all freedom-loving South Africans (except doctors, nurses and journalists) will abstain from any form of work to participate in June 16 activities in all areas"

132

204

M/M
5/6/26

Paid public holiday bid

Pietermaritzburg Bureau

THE Pietermaritzburg City Council's Management and Finance Committee yesterday decided not to act on a recommendation by the City Engineer's Department that May 1 be observed by the council as a paid holiday

Deputy Town Clerk Mr D

Wicks said the committee had recommended that no action be taken on the City Engineer's recommendation that May 1 be declared a paid public holiday, subject to an existing public holiday being dropped.

He said the council could not make any ad hoc decision on the matter and did not wish to deal with it in isolation

Assocom's June 16 guideline

6/6/86 BUS DAY
132
412

THE Associated Chambers of Commerce (Assocom) is recommending that its 23 000 members treat worker absenteeism on June 16 on the basis of "no work, no pay, no penalty".

Assocom said many companies would nevertheless negotiate or agree on some other arrangement with employees beforehand.

Meanwhile, both Metro Cash and Carry and Hodder & Stoughton have agreed to give Commercial, Catering and Allied Workers' Union of SA (Ccawusa) members a

CLAIRE PICKARD, CAMBRIDGE

paid holiday on May 1 and June 16.

Premier Food Industries has also declared June 16 a paid holiday for its 24 000 employees and Anglo American will close its corporate head office at noon on that day.

Most employers, including the Steel, Engineering Industries Federation of SA (Seifsa) intend treating June 16 as a normal working day.

W. K. M. C. S. 7/1/86

Boesak to speak at June 16 service

Weekend Argus Reporter
DR Allan Boesak, president of the World Alliance of Reformed Churches, will be one of the guest speakers at a Western Province Council of Churches service on June 16

The council decided yesterday to go ahead with the service and pray for an end to unjust laws. The service will be held at the AME Church, Hazendal.

Meanwhile, the Western Cape Traders' Association has called on its 3 000 members and other traders not to open for business on June 16 but to attend prayer meetings

In a statement, in which it emphasised that it was part of the oppressed people, the association supported calls for June 16 to be declared a public holiday

The statement said. "We call on all members to close their businesses on June 16 as a mark of respect for all the deaths in 1976 and the thousands who died for us in Sharpeville, Langa, Alexandra, the Cape Flats and now Crossroads"

Flowers

The association demanded the lifting of the ban on protest meetings, the shelving of apartheid and security legislation, the unbanning of the African National Congress and other organisations and the release of political prisoners so that people could decide democratically the future of South Africa as one people and one country

● Meanwhile, the Weekend Argus Correspondent in Durban reports that whites who are saddened and shamed by the violence of the last 10 years are being asked to place cut-out yellow flowers in their car windows and send flowers to Soweto on June 16.

The gestures are the brain-child of a group of concerned whites in Johannesburg who do not want individual publicity. The scheme was thought out before the ban on June meetings.

They have the backing of some of the country's major churches and have received cash from some of the country's leading businesses to advertise the "Soweto garland" campaign in newspapers.

132

Unionists plan to set up labour forum

A GROUP of unionists plans to set up a labour forum which unions can use in seeking co-operation on key issues and to monitor matters of concern to SA labour

President of the independent SA Boilermakers' Society Ike van der Watt is chairing the steering committee which proposed the forum

The forum is expected to research opinion on pertinent labour issues, including public holidays, hours of work

CLAIRE PICKARD-CAMBRIDGE

and labour legislation. It will also try to build understanding between the unions

Van der Watt says the committee is not proposing a new federation

"The motivation behind this is to operate outside any trade union grouping, on an independent basis. We hope the forum will communicate with all groups, including the Congress of SA Trade Unions and the

Council of Unions of SA, as well as with international labour bodies"

Eleven unions — most of them independent — are prepared to sponsor the forum. The committee hopes to have as many as 20 or 30 divergent unions

The committee is recommending that the forum be a loose and informal organisation and plans to set up an office soon, with one or two staff to man it

Report sets out road to reform

~~SECRET~~ 132 12/E 1/05T 9/6/86

BUSINESSMEN, academics and workers joined forces today to call for dramatic political and economic reforms to set South Africa on a new path to prosperity and equal opportunity

The call is contained in a report by the School of Business Leadership at the University of South Africa (Unisa) and consolidates the thinking of management from 103 of South Africa's leading business organisations

The report — entitled "Economic Participation in South Africa Strategy for Survival and Growth" — also contains the result of a survey reflecting the views of three million workers

Professor Martin Nasser, chairman of the project and professor at Unisa's School of Business Leadership, said more than 620 managers had spent a total of more than 2 000 man-days in formulating its contents, described as "a strategy for a stable and prosperous free market economy in South Africa"

It warned that in order to break the country out of its "cycle of political polarisation and economic stagnation", reforms had to go beyond the Government's objective of dismantling apartheid

"If the solution to South Africa's problems were that simple, then the countries to the north of our borders would not have encountered major economic problems and major resistance to the free enterprise system after the removal of discriminatory practices and legislation," it said

Businessmen had to realise that it was also imperative for them to initiate changes in the workplace that would encourage workers to believe in the system of free enterprise

The report urged the immediate implementation of a coherent strategy of reform to break the "pattern of instability" being experienced by the country

In the short term it saw immediate negotiation with recognised black leaders as necessary to prevent a "Muzorewa option" — where moderate black leaders will lose credibility by the time they achieve power — from taking place in South Africa

At the same time as these talks took place, a statement of intent should be produced to outline a "guide plan of what South

Africa should be like in the near future"

The urgency of the situation necessitated that such a situation be achieved by next January

The report called for a strategy made up of two main components — one dealing with the "macro" changes needed at a political level and the other with "micro" changes that businessmen should implement within their organisations

It stressed that only an integrated implementation of both sets of reform would rescue free enterprise from South Africa's current crisis

The report noted that many political factors hampered "the individual's (especially black) ability, right and motivation to participate in the free market system" and recommended the following political reforms to correct this

- Introduction of genuine freehold for all and equal access to property

for all individuals

- Direct political representation and participation by blacks in central, regional and local government to be achieved by negotiation with recognised black leaders and the eventual holding of a referendum based on universal franchise

- The creation of a single Ministry of Education

- The removal of the Group Areas Act and the opening of central business districts to people of all races

- The removal of influx control

- The development of small businesses to promote black entrepreneurship

The report recommended the following "micro" strategies to ensure that the "workforce perceives business as being a process which offers substantial benefits to the worker"

- The implementation of schemes that promote full participation of work-

ers in the production process in order to promote efficiency and a commitment to free enterprise amongst workers

- An intensified effort to promote black advancement, especially to top levels of management. This involves implementation of education schemes and the promotion of workers within the plant rather than employing skilled personnel from outside the workforce

- The need to devise systems whereby workers who display a concern for quality and efficiency during production receive incentive rewards

In order for its programme to be successful, the report stressed that "each of these elements must be viewed as interdependent facets of one holistic strategy"

"The instability in South Africa emphasises that it is not possible to address economic issues without addressing political issues," it said

CMT Tink 12/6/86 (141)

5. White Peninsula pupils to

6. Sick

Cov 137

Wor

Emg

Anr

Anr

join stayaway?

ers
ers
ers

Education Reporter

SOME 200 white pupils may stay away from Peninsula schools on Monday — the 10th anniversary of the June 1976 Soweto uprising — in support of a call for a national stayaway.

The white stayaway has been called by the Pupils Awareness and Action Group (PAAG), formed in September last year to protest police against brutality and demand a single, non-racial education system.

The acting chairman of PAAG, Mr Paul Stober, said there were about 200 registered members of PAAG scattered throughout the Peninsula "We feel each PAAG member should be free to

consider the call and do whatever satisfies his or her conscience," he told the Cape Times yesterday.

Awareness programmes, at a venue to be decided, would be arranged for pupils who stayed away, he said.

Mr Stober said principals would be informed of the plans by letter

The executive director of Indian education, Mr A K Singh, said yesterday that his decision not to close schools on June 16 had not changed. He confirmed that he had received a letter from the Teachers' Association of South Africa (Tasa) requesting their closure, as they felt Indian schools should not be seen by blacks as not observing the event.

Black and coloured schools are not affected, as the anniversary this year falls during their winter holidays.

A spokesman for the University of the Western Cape said the university would close tomorrow for the June vacation and would reopen on July 14

At UCT, the traditional study week has been split in two to allow students to observe the anniversary. Students were granted study leave last Thursday and Friday, and the remaining three study days will fall on June 16, 17 and 18. Exams will restart next Friday and continue till the end of term on June 27.

In Johannesburg, the Catholic Educa-

tion Council recommended at its annual general meeting at the weekend that Catholic school authorities mark the anniversary by appropriate means as an expression of solidarity with "all who have suffered, and still suffer, injustice".

The council said it associated itself with all other bodies working for justice in South Africa, and in particular, with those striving for non-racial education.

"It was well-known the tragic events of June 16 10 years ago were brought about by dissatisfaction with the education system. Since then many have suffered and died for the same cause," the council said.

The council reaffirmed its commitment to strive for non-racial and equal education.

Examinations at the University of Witwatersrand between June 16 and 18 have been rescheduled to allow for a national stayaway, the vice-chancellor, Professor Karl Tober, announced on Monday.

The National Education Crisis Committee has called for a June 16 stayaway to commemorate Soweto.

"Many staff members and students are sympathetic to the call for a stayaway," Professor Tober said.

The university itself would not close on those days, he said.

Cape Times 12/6/82 253 (197) 132

No 'Witness' on June 16

MARITZBURG. — The Natal Witness will not be published on Monday, June 16, as a "gesture of reconciliation" on the 10th anniversary of the Soweto riots, the newspaper's managing director said yesterday.

"After deep consideration of the requests made to us by the trade unions with which we deal, we have decided to close on June 16 and to grant our employees a paid holiday to mark the 10th anniversary of those events which erupted in Soweto, so decisively changing our national life," Mr Stuart Craib said in a statement.

The Natal Witness will be published

again on Tuesday, June 17.

Mr Craib said: "We are doing this as a gesture of reconciliation in this tragic period through which our country is passing and as a demonstration of our sympathy with, and understanding of, the feelings of our fellow countrymen.

"The sheer cost of our decision makes it impossible to undertake to repeat this holiday, but we hope the government will act quickly to reschedule South Africa's calendar of public holidays so that consideration is given to the feelings of all our people," he said — Sapa

13/1/86 BUS DAY

BP joins others to give staff a June 16 holiday

BP SOUTHERN AFRICA has joined an increasing number of companies in announcing that it will close on June 16, 10th anniversary of the 1976 Soweto uprising.

BP chairman Ian Simms announced that BP would close its offices, installations and depots. It is understood that employees will not lose their pay on June 16.

Simms said: "In certain areas many of our staff will face problems if they attempt to go to work and I do not wish to risk the safety of human lives, nor penalise people financially if the circumstances are beyond their control."

This did not constitute a permanent departure from present absenteeism policy, he said

□ Cashbuild — a building company — will be closing all its branches in SA on Monday in recognition of June 16 as a national holiday. Black and white staff at the various branches have been informed that Monday will be regarded as a paid holiday. Cashbuild branches in Bophuthatswana and Botswana will remain open.

□ Sandton Town Council offices will be closed on June 16 as a day marked for sober reflection and prayer to symbolise the turmoil in the country, council chair-

Business Day Reporters

man Ricky Valente said yesterday.

"We believe that this date is a day which should be seen by all South Africans as a day of reconciliation, sober reflection and prayer for all, irrespective of race, colour, creed or religion," Valente said.

However, all essential services will be maintained on the day.

□ Institute for Industrial Relations director Mark Anstey has appealed to all employers to respond to workers' actions over the next weeks with as much understanding and restraint as possible.

"Employer responses are an important statement to workers in our extraordinarily stressful and transitional society," he said.

"Events over the next week have every chance of polarising us further. All of us — authorities, employers, workers and communities assume responsibility to see our actions do not destroy any small hope that may remain for a non-violent, negotiated change process," Anstey said.

□ Millews Fashions, which is based in Johannesburg and Randburg, has said its 53 staff members will have June 16 as a paid holiday this year and next. It also grants May 1 as a paid holiday.

CAPE TOWN 14/6/66
**Labour
bill
changed**

PARLIAMENT. — The bill which will allow the State President to temporarily suspend regulations governing economic activity has been amended following complaints from trade unions that the measure would interfere with "sound labour practices and relations"

The amended bill, published here yesterday, requires that the Minister of Manpower be consulted before the issue of any proclamations that affect conditions of service and working hours, the registration of employees, the supervision and use of machines and the health and safety of employees

The amendment was proposed by the Standing Committee on Home Affairs

Unofficial list of public holidays emerging

By Sheryl Raine,
Labour Reporter

132
19/6/88

The consistent demands made by emergent trade unions this year for June 16 to be declared a paid company holiday is an indication of a calendar of unofficial public holidays busy developing in South Africa

This year could see the biggest worker stayaway yet recorded in the country's history

Most employers will follow the Federated Chamber of Industries, the Afrikaanse Handelinstituut and Association of Chambers of Commerce guidelines of no work, no pay, no penalty.

A few major employers have adopted different policies

Premier Food Industries agreed to give 24 000 workers of all races a paid holiday

The Coca Cola Bottling Company in Johannesburg and Boksburg, Colgate Palmolive and Davis Gelatine Industries, also agreed to a holiday

Kodak (SA), BP, Mobil, Shell, Jazz Stores and Blackchain will close on Monday

Anglo American will close its head office at noon to allow workers to attend commemorative services

The Sandton Town Council offices will also be closed

The National African Federated Chambers of Commerce has asked black businesses to observe the day and appealed to black employers not to dock workers' wages

Despite the "no pay" stand taken by most employers, a massive stayaway is expected

It is no mistake that this year's union demands for a June 16 holiday come at a time when emergent unions have achieved greater unity than ever before

The Congress of SA Trade Unions (Cosatu) as well as the Council of Unions of SA and the Azanian Confederation of Trade Unions may be separate federa-

tions, but their demand for recognition of the importance of June 16 to the black community has been unanimous

The Inkatha-backed United Workers Union of SA (Uwusa) has also announced that its members will observe June 16.

In a significant move the United Democratic Front (UDF), the National Education Crisis Committee (NECC) and the Congress of SA Trade Unions jointly decided that the day be commemorated through a one-day national stayaway.

It added that nurses, doctors and journalists were exempted from the call

STAR 16/6/86

Mass stayaway marks June 16

132

~~STAR 16/6/86~~

A handful of black commuters trickled to work on the Witwatersrand and in Pretoria today in the face of a mass stayaway to mark the 10th anniversary of the June 16 Soweto riots

Bus and taxi services failed in many areas

Companies reported high absenteeism despite assurances from the Government that workers who wished to work would be protected

The greatest absenteeism was recorded in the Transvaal. Companies in Natal reported the best attendance figures

Johannesburg city streets were quiet during the morning rush-hour, with an almost total absence of black commuters

WORKERS

The Johannesburg Chamber of Commerce (JCC) reported a 95 to 100 percent stayaway by black workers in the greater Johannesburg area

Pick 'n Pay reported a 100 percent stayaway nationwide but said all stores were open and services were being maintained by casual labour

Johannesburg's municipal services were barely affected and the staff department reported that only about 15 percent of

the nearly 15 000 black workforce was absent

Worst hit was the cleansing department where about 700 of the 2 000 staff were away. Most of these were women.

ABSENTEES

The traffic department reported only 216 out of 1 500 away and the electricity department's work force was almost at full strength with only 30 absentees

AECI reported that its plants in the Vaal Triangle, on the Reef and throughout the Transvaal were experiencing an almost total stayaway

Mines reported near

normal attendance but some were closed due to total stayaways

Anglo American reported that less than one percent of its 180 000 black mineworkers were absent.

Putco bus services in the Transvaal were paralysed by a total driver stayaway Putco services in Natal operated normally but experienced a fall-off in passengers

A spokesman for the South African Transport Services said trains ran according to schedule countrywide But many of them ran nearly empty

Many white school pupils stayed away from

school in Pretoria but a spokesman for the Transvaal Education Department said today was regarded by the department as a normal school day

The stayaway affected Johannesburg's Alexandra and Soweto townships, Pretoria townships, Kagiso near Krugersdorp, Tembisa on the East Rand and all Vaal Triangle townships

By midday there had been no reports of violence.

NO INCIDENTS

There was a complete stayaway in the East Rand townships of Katlehong, Thokoza and Vosloorus.

A general stayaway was evident in Pietersburg and other Northern Transvaal towns, but no serious incidents were reported, according to police sources

● About 80 percent of the Cape Peninsula's black workforce has stayed at home today, said the director of the Cape Chamber of Industries, Mr Colin McCarthy But hospitals reported few absentees and said all services were operating normally

Several major stores in the town centre displayed posters saying they would be closed today.

Phone blackout hits four Tvl townships

Large areas in townships on the Witwatersrand and near Pretoria were hit by a telephone blackout today.

Numbers in Mamelodi near Pretoria, Soweto, Kagiso on the West Rand and Katlehong on the East Rand could not be reached by reporters from *The Star*.

Mr Sarel van Rensburg, post office public relations officer for the Pretoria area, said there were "technical problems in some areas", but was unable to say where

He said no notification had been received to discontinue any services

In Johannesburg, Mr Jimmy Taylor, deputy postmaster-general for Telecommunications, said "We are trying to rectify the problems, but for some time now, we have been unable to go into certain areas because our safety cannot be guaranteed"



Bus. DAY

16/6/85

132

SA

US companies differ in their approach

PETER WALLINGTON

AMERICAN companies operating in SA have adopted different strategies for observing Soweto Day (June 16), despite a call by the Rev Leon Sullivan for it to be recognised as a paid holiday.

Sullivan, originator of the Sullivan code of business ethics, said last week black staff and white should be given a paid holiday today.

He said the task group that monitored compliance with the code regarded it as an "act of corporate and civic responsibility and a demonstration of the desire of US Sullivan signatories to stand with the black community on this important day".

Coca Cola Bottling Company and Colgate-Palmolive have declared June 16 a paid holiday, while General Motors has followed employer associations and adopted a "no work, no pay" policy.

IBM and Eli Lilly said they would be open but would not penalise staff who did not work.

Full trains, buses and taxis restore life to yesterday's 'ghost' towns

Stayaway workers roll back

STAR 17/6/86

132

Staff Reporters

Black workers in the PWV area streamed back to their jobs in their thousands today after the massive stayaway to mark the 10th anniversary of the June 16 riots in Soweto.

But some black commuter routes on the Reef seemed to be quieter than usual. Putco carried 80 percent of normal capacity in Soweto early this morning, said Mr B Pelsler, the divisional manager for the township.

The Star is unable to report in this edition whether there was any violence yesterday because, under the emergency regulations, information is released only by the Bureau for Information at a Press conference held once a day.

At yesterday's conference, the director of internal media liaison, Mr Leon Mellet, said violence planned for yesterday had not happened between dawn and lunchtime.

Mr Pat Rogers, public relations executive for Putco, said passenger volumes appeared generally to be back to normal today.

All drivers have reported for work.

A spokesman for SA Transport Services said trains in the Transvaal were full this morning.

"It seems like a normal working day."

He added that only 30 percent of normal passenger loads were carried yesterday.

The streets of Johannesburg — which resembled a ghost town yesterday — were restored to life this morning when black bus and taxi services resumed.

Black townships on the East and West Rand were also bustling with commuters on their way to work.

Shops which closed yesterday in Johannesburg and surrounding black townships are open again.

Black workers have also returned to factories, shops and offices in Pretoria. Employers reported attendances of almost 100 percent.

Black residents of the townships of Atteridgeville and Mamelodi near Pretoria, Mokoleng near Randfontein, Kagiso near Krugersdorp, Dobsonville west of Soweto, Sebokeng near Vanderbijlpark, kwaThema near Springs, Wattville near Benoni, and Tembisa near Kempton Park, said workers were going to work in their droves.

Life was back to normal, with buses and taxis providing normal services, they added. But in Duduza, near Nigel, residents are continuing with the consumer and bus boycott launched about four weeks ago.

17/6/88 (132) SPM

Nationwide stayaway hits hardest in Eastern Cape and PWV area

By Sheryl Raine

The greater PWV area and the Eastern Cape were most affected by yesterday's worker stayaway, according to two independent assessments.

The independent Labour Monitoring Group (LMG) and the Association of Chambers of Commerce (Assocom) both analysed the nationwide stayaway and found varying levels of absenteeism in major economic zones.

The LMG, a group of academics from local universities, estimated that the number of workers involved in yesterday's stayaway was at least equal to the 1,5 million who took the day off on May 1 but that yesterday's absenteeism was distributed differently around the country.

After a telephone survey of about 450 employers, the LMG, found:

● In the PWV area: Manufacturing sector: average stayaway by black workers 84 percent, 32 percent by coloured and Indian workers.

Retail sector: black worker stayaway 90 percent, coloured and Indian workers 25 percent
Transport sector: average stayaway among all blacks 87 percent.

Municipal sector: average stayaway among all blacks 37 percent.

Mining sector: very low absenteeism estimated by the LMG at less than 10 percent.

An Anglo American spokesman reported that fewer than 10 000 black employees, out of a total of 231 000 on Anglo gold, coal and diamond mines, stayed away from work

Other mining houses reported minimal stayaways.

● In the Eastern Cape: Port Elizabeth and Uitenhage reported an effective 100 percent stayaway by black workers in all sectors. In un-

ionised firms organised by the Congress of SA Trade Unions, there was a 40 percent stayaway by coloured employees. At other firms coloured workers reported for duty as usual.

● In the Western Cape: Manufacturing sector: average stayaway by black workers 82 percent and among coloured workers 24 percent — overall average of 34 percent.

Retail sector: 50 percent among blacks, 39 percent among coloured workers, overall average 39 percent.

Construction sector: 71 percent stayaway by blacks, 35 percent stayaway among coloured workers with an overall average of 64 percent.

The stayaway in the Western Cape amounted to 78 percent of

black workers and 26 percent of coloured workers making an overall total of 37 percent.

In the Western Cape there was a distinct difference between absenteeism among unionised and non-unionised workers, according to the LMG. Among unionised black workers there was an 84 percent stayaway while, among non-unionised black workers, 53 percent took the day off.

Among unionised coloured employees, 27 percent stayed away while, of the non-unionised coloured workers, only five percent stayed away.

Assocom said that reports received from various chambers of commerce reflected a mixed pattern of absenteeism. "The Transvaal area appears to have experienced the highest level of stayaways followed by

the Eastern Cape, Border and Maritzburg. Regions such as the Free State, Zululand and Natal South Coast showed virtually full attendances by black workers. Slightly below average attendances were experienced in the Cape Peninsula and Durban," said an Assocom spokesman.

"It is not possible for Assocom to give a dogmatic assessment of the overall effect of the call for the stayaway as many large corporations, including Sullivan Code signatories, had decided either to close for the day or to grant leave in lieu of time worked in advance in respect of June 16.

"A number of smaller concerns simply did not open for business, whereas other businesses functioned normally by having made contingency plans in advance. Furthermore, a number of large and small transport operators did not run their normal services which could have led to higher absenteeism than would otherwise have been the case."

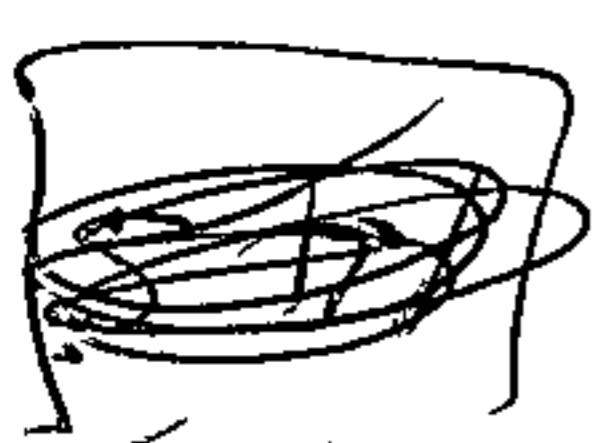

Workers return after stayaway

Cape Times 18/6/89 Staff Reporter (132) (135)

WORKERS who stayed away from work on Monday to observe Soweto Day returned to their jobs yesterday and employers reported "normal staff attendance".

An estimated 80 percent of black and 20 percent of coloured workers in the Western Cape responded to the call for a one-day stayaway on Monday.

Fears that the stayaway might be extended appear to have been unfounded.

A member of the Congress of South African Trade Unions (Cosatu), which represents more than 50 000 workers in the Western Cape, said workers had voted against a longer stayaway.

Spokesmen for City Tramways and South African Transport Services said the passenger flow on buses and trains was back to normal yesterday.

Major chain stores reported that employees who observed the stayaway had returned to work yesterday and that services had "normalized completely".

Mr Robert Kaplan, president of the Cape Town Chamber of Industries, which surveyed absenteeism at 40 companies in the Peninsula on Monday, said there was no indication that the stayaway had been prolonged.

● A spokesperson for the Cape Education Department said he had "no knowledge" of white pupils at government schools observing the stayaway.

A number of private schools in Cape Town, including Christian Brothers College in Green Point and Springfield Senior School in Wynberg, remained closed on Monday, while St Joseph's College (Marist Brothers) in Rondebosch conducted a special awareness programme

Voting with their feet

118 119 122
124
Cape Times
19/6/86

IF MONDAY'S general strike proved nothing else, it dispelled the long-held notion that work stayaways in South Africa are successful largely because of "intimidation" in the townships

Given the huge security presence in and around most townships on June 16, there was no way that people wanting to go to work could have been hindered on the way in or out by intimidators

One is left with the inescapable conclusion that several million workers voted with their feet on Monday

But they voted unevenly, both regionally and sectorally. And in some areas — a large section of the retail sector on the Reef in particular — they voted more than once, and were still voting yesterday

The Johannesburg-based Labour Monitoring Group (LMG), which surveyed all the main centres except Durban, estimated that at least one-and-a-half million workers participated in the strike — at least as many as took part in the May Day strike

It is important to make this comparison because Labour Day was more specifically a worker day than June 16

Natal an exception

One could not deduce from the extent of the strikes on both days that there is a huge dichotomy in the labour movement between "workerists" concerned primarily with worker issues and "populists" concerned primarily with high-profile political issues

Unionized workers supported both strikes evenly around the country with the exception of Natal and the mines, where there was a negligible stayaway on Monday

According to the LMG figures, the strike in the Pretoria-Witwatersrand-Vereeniging (PWV) area was slightly higher than May 1. This was not unexpected, given that it included Soweto, the emotional centre of June 16

Cape Town, too, was higher than May 1, while Port Elizabeth, probably the country's most politicized city, had virtually a 100 percent stayaway on both days

The general strike was not limited to the main centres and stayaways were high in both the Transvaal and Eastern Cape hinterland, creating the possibility that a further half-a-million workers over and above the LMG figures commemorated June 16

For instance, not a single bus was reported to have left the troubled homeland of KwaNdebele to take people to work on Monday

In Natal the factionalized battle between Inkatha and the United Democratic Front (UDF) and the Congress of South African Trade Unions (Cosatu) and the United Workers' Union of South Africa (Uwusa) probably had a role in restricting the strike

Natal increasingly appears as an anomaly on the South African political scene, particularly since the May 1 launch of Uwusa

Conflict between Cosatu and Uwusa reached a new pitch two weeks ago with a clash at the Hlobane colliery which left 11 miners dead, and violent clashes are on the increase, diverting attention away from other issues

The failure of the stayaway on the mines suggests that, despite indications to the contrary earlier this year, most black miners are isolated from the political currents in the townships

Willing to strike

Miners live in hostels largely insulated from the townships, nearly 40 percent of them are foreign nationals from countries such as Lesotho and Mozambique, and even the South African nationals are migrant workers with limited emotional ties to Soweto

The fact that they were willing to strike on May 1 but not on June 16 suggests a stronger willingness to take action over strictly worker issues, and an indication that they could be saving themselves for a battle over wages later this year

The one proven exception was the collieries of the Eastern Transvaal where the stayaway was more successful and where miners have already participated in township campaigns

On the other side of the spectrum are retail workers on the Reef, many of whom started striking on Friday. At last count yesterday 11 branches of Woolworths, 15 branches of Checkers, eight branches of OK Bazaars, and four CNA stores were on strike

This is more indicative of the overall militancy of the unionized workforce — and their potential strength, which was displayed on Monday

It is a not insignificant fact that twice within seven weeks more than one-and-a-half workers have taken organized, coherent and peaceful political action

And the fact that the union movement in the form of Cosatu has become a full-fledged member of the black political opposition was recognized by the state last week when, for the first time, unionists were as hard hit as other political organizations by detentions

Philip van Nieuwerk is a former labour correspondent for the Cape Times and the Rand Daily Mail and now writes for the Boston Globe, the Weekly Mail and other publications

CALC Times 26/6/86

132/134

'Industrial relations upset by detentions'

JOHANNESBURG — More than 170 trade unionists are known to be in detention and scores of others have gone to ground after the declaration of the state of emergency, the Labour Monitoring Group (LMG) said in a report released yesterday.

The detentions and emergency regulations have been so disruptive that the industrial relations system built up in the post-Wiehahn period has been called into question, the LMG said.

The LMG adds "In sharp contrast to the high-sounding claims in support of civil rights in the FCI Business Charter, employers have been largely silent on the state of emergency. Two important exceptions are AECI and the Premier Group."

According to figures contained in the report, the Congress of South African Trade Unions (Cosatu) was hardest hit with 146 leaders known to be in detention.

The Council of Unions of South Africa (Cusa) has 21 unionists in detention while the Azanian Council of Trade

Unions (Azactu) has reported one detention.

Of the Cosatu unions, the Metal and Allied Workers Union (Mawu) has been hardest hit with 36 worker leaders in detention (21 percent of the total) followed by the Commercial Catering and Allied Workers Union (Cawwusa) with 16 (nine percent).

Field open

The National Union of Textile Workers (NUTW) and the South African Allied Workers Union (Saawu) each have 11 leaders in detention (six percent).

Annual negotiations in three big sectors of the economy — metal, mining and chemical — have been disrupted, postponed or have ground to a halt because of the absence of key union negotiators.

Lawyers say workers have been telephoning their offices to ask if they would be breaking emergency regulations if they met to discuss wage claims.

"At first appearance trade union detentions have been haphazard, but in certain areas the

logic is all too apparent.

"Trade unionists in Northern Natal believe the large-scale detentions of Cosatu leaders now leaves the field open for its recently formed rival, the Inkatha-backed Uwusa," said the report.

In their conclusion, the group adds that while the detention of unionists has temporarily disrupted trade union organization, their deep roots in the workplaces is likely to mean that it will continue.

● The Commissioner of Police, General Johan Coetzee, last night said the SAP wished to reiterate its assurance that "no member of trade union movements in South Africa is being detained under the emergency regulations because of purely trade union activities."

He said the SAP was "eager to promote industrial peace and stability" and that trade union leaders and other members would not be detained unless they were "prolonging the state of emergency by their activities" — Sapa and Own Correspondent.

PC urged
to act on
industrial
ISSUES

Pietermaritzburg
Bureau

THE President of the Pietermaritzburg Chamber of Industries has called on the Government to take action on politically-linked industrial issues which are affecting business and productivity.

Speaking at the Chamber of Industries banquet this week attended by Dr Piet Koornhof, chairman of the President's Council, Mr Louis Sennett said he believed the time had come when the President's Council should 'as a matter of urgency, grasp the nettle, and do something to make life easier for all concerned'

He called on the council to 'identify, investigate and make recommendations on minor industrial issues which take up so much of our time'

These included the question of public holidays, the Industrial Council system, labour relations law and the effectiveness of the Industrial Court

Other issues were the long delay in getting issues to the Industrial Court, recognition agreements with trade unions, non-functioning of community councils, intimidation of township people and whether police protection in townships should be increased to safeguard peace-loving citizens.

'Many of these issues should not be our responsibility,' he said.

Mr Sennett said today business enterprises had to be managed against an ever-changing background of political reform which was too fast for some and too slow for others; there were disinvestment pressures, trade sanctions or talks of sanctions, and violence, massive intimidation, strikes, business and school boycotts and rampant inflation

y
id
e
al
et
y.
e-
er
b.
d
il
-
a
e
n

NdMer
(132)
28/6/86

Get involved in talks, Anglo tells employers

1/7/86 (132) By Sheryl Raine

The Anglo American Corporation has urged employers to play an increasing role in negotiations to resolve political conflict which spills over into the work place.

In their annual report released today, Anglo's directors said several companies had taken the initiative in such conflicts, mediating directly between the police and local authorities on the one hand and company employees on the other.

The corporation was deeply concerned about the recent outbreaks of violence on several mines and the social unrest spilling over from nearby communities.

Referring to the traumatic economic year last year, Anglo said recessionary conditions spread to many sectors of the economy with disastrous effects.

Declining real incomes and rising unemployment contributed to

the rising tide of political unrest. This had reinforced growing sentiment overseas in favour of disinvestment.

Looking at the country's socio-political needs, the corporation said that until fair access for all to employment opportunities, land, housing and capital were addressed, the major problems facing South Africa would prevent the achievement of sustained real economic growth and eventual political stability.

Anglo urged the Government to press on with a housing programme, with substantial private-sector involvement, and the proclamation of land close to places of work as a prerequisite for stability.

The corporation also urged the speedy removal of the last vestiges of racial discrimination from the Mines and Works Act.

"Removal of this provision is of great importance to the industry and it is hoped that the Minister of Mineral and Energy Affairs will act quickly to give it legislative support.

"It is essential that once the scheduled person clause is removed, remaining obstacles to the achievement of merit-based selection and advancement on the mines are removed."

Unions' clash

disrupts milk supply

Pietermaritzburg
Bureau

MILK deliveries throughout the capital have been disrupted since Friday because of an internal dispute between members of two rival union bodies at the National Co-op Dairies Ltd plant here

Mr E W Hornby, district general manager for Clover Dairies, said the company would take 'whatever steps necessary' to keep the business running

The dispute, apparently between members of the Congress of South African Trade Unions (Cosatu) affiliated Sweet, Food and Allied Workers' Union of South Africa and the United Workers' Union of South Africa (Uwusa), began on Friday

Deliveries were halted over the weekend, and were hampered yesterday morning when a number of workers 'simply failed to turn up for work', according to Mr Hornby

A similar situation arose early last month when SFAWUSA members objected to attempts to establish Uwusa on the shop floor, with deliveries in Durban and Pietermaritzburg being halted for a number of days

Mr Hornby said the company would try to get deliveries back to normal as soon as possible, 'with or without' the workers who did not report for duty on Monday

'We will take the necessary steps to ensure that we stay in business,' Mr Hornby said

'We cannot tolerate two factions fighting like this all the time'

Mr Hornby said workers had been told to return to work, and should such a move be necessary, 'we will have to get workers who will run the business'

He added that the company was 'neutral' as to union membership among its employees

He said the matter was now in the hands of the union members, who had been notified of the company's stand on the matter, and that Clover would 'see the thing through in the correct manner'

'We do not get involved in internal union disputes and believe in freedom of association,' Mr Hornby said

He said that the strike had not spread to Durban, and no workers had as yet been dismissed

No respite for fired dairy staff

NATAL HERALD
132
2/7/86

Pietermaritzburg Bureau

THE 200 Clover Dairies employees who were dismissed here on Monday afternoon definitely would not be re-employed, Mr Andrew Lynch, Clover Dairies Industrial Relations Manager, said yesterday.

He said the workers, whom he felt had 'dismissed themselves' by refusing to report for duty on their normal shifts on Monday morning and taking part in an 'illegal strike', would not be reinstated in their positions.

'As far as we are concerned, they have dismissed themselves,' Mr Lynch said.

All the dismissed workers had been paid R150 in backpay which was owed to them.

Workers stopped work on Friday after two members of the Food and Allied Workers' Union (Fawu) were dismissed for alleged misconduct during a previous work stoppage which occurred on June 6.

Mr Lynch denied that this was the cause of the stoppage, and blamed it on rivalry between Fawu and the United Workers Union of South Africa (Uwusa).

He said the company had been considering its manpower requirements and would employ an unknown number of new workers to replace the strikers.

He said deliveries yesterday had been disrupted only in the retail or door-to-door field, and wholesale deliveries to shops were normal.

Mr Petros Ngcobo, secretary of the Midlands branch of Fawu, said the workers had stopped work for four

reasons

These were the dismissal of the two Fawu members, one of whom was chairman of the shop stewards' council, Mr Jethro Ndlovu, the reinstatement of three Uwusa members who had been suspended from work, the changing of Mr Ndlovu's daily 'round' to Imbali, where he had received death threats, allegedly from Uwusa members, and 'slowness' on the company's part in paying a back-pay sum of R150 a worker.

Problems

He criticised the company's attitude towards Fawu, and said should negotiations with the management fail, the union would use all means at its disposal through its membership at all Clover and National Co-op Dairies plants throughout Natal.

He said the union had not decided whether its members would stop work at other Clover and NCD plants.

He questioned the fact that Fawu had had 'many problems' with Clover's management while they enjoyed a better relationship with the management of other concerns.

'Why do we not have similar problems in other factories?' Mr Ngcobo asked.

He added that he had received a report that five women Fawu members at the Clover Port Shepstone plant, including the factory's shop steward, had been dismissed yesterday afternoon.

The management was unable to confirm the allegation.

8/7/86

305
BISHOP

Edited by Tony Koenderman

132

IN THE present harsh economic climate it would seem a near impossible task to persuade companies to dip into their pockets to sponsor a movie — especially in the Eastern Cape where the recession is biting harder than in other regions

But last year, when companies were approached with precisely this suggestion by Bruce Bishop, an industrial and commercial training consultant attached to the Centre for Continuing Education at the University of Port Elizabeth (UPE), he had little trouble convincing them. For Bishop had an eminently saleable idea: a training film aimed at teaching line managers the “ins” and “outs” of dismissal

Since the advent of the Wiehahn labour reforms and the establishment of the Industrial Court, many companies have discovered to their cost that dismissal is no longer a matter of simply firing workers who, for whatever reason, they do not wish to carry on employing. Indeed, in numerous judgments, the Industrial Court has been unequivocal that certain principles have to be respected. Above all, dismissals must be accomplished in a fair manner and workers must have the opportunity to state their side of the case.

Although this message has generally sunk in among top managers, many companies experience difficulties in passing it down to the level where it

Not to be lightly dismissed

LABOUR RELATIONS

RABYN RAFEL

really counts the shopfloor.

Bishop's plan was to tackle the issue head on in the most realistic way possible by drawing material from Industrial Court cases. It was an idea he became inspired with while discussing the problem of educating line managers with colleagues when he was working in industry. Later, when he joined the university, he received enthusiastic backing for it from Professor Roux van der Merwe, the widely respected head of UPE's Industrial Relations Unit

To their credit, 20 Eastern Cape companies also saw merit in the idea and together provided the R120 000 needed for the venture. Last Thursday, they saw the fruits of Bishop's work when the movie, entitled “The Unfair Dismissal”, was screened at a private showing. On Friday it had its first public showing at the Midlands Chamber of Industries. The response, says Bishop, was “most gratifying.”

“The Unfair Dismissal”, which runs for 90 minutes and is accompanied by training manual, is divided into three sections. All the material has been taken from actual case histories, although names have been changed.

In the first section, viewers are presented with five cases of unfair dismissal. In each, two unfair labour practices are identified. The second section focuses on the fifth unfair dismissal and deals with the consequences it had for the company involved: legal proceedings in the Industrial Court, lawyers' costs, and loss of productivity because managers were tied up with the case. The third section shows how the matter should have been handled. Significantly, dismissal does not occur.

Based on responses so far, Bishop is confident that many companies will purchase the movie, which sells for about R1 800. Buyers will be instructed on how to use it for training and will, in addition, receive a course on labour law from qualified lawyer.

Because the movie is registered as a training scheme with the Department of Manpower, tax concessions are available

ADOLPH LANDMAN

Defining what's unfair

FIN MAIL

IN MY OPINION

132
11/7/86



Adolph Landman, who has presided over numerous Industrial Court cases, is an associate professor of mercantile law at Unisa.

It is no secret that there is no small measure of dissatisfaction in certain sectors of the labour community concerning the concept of the unfair labour practice as it appears in the Labour Relations Act (LRA)

In simple terms, the LRA defines an unfair labour practice as any labour practice or change in labour practice (other than a strike or a lockout) which has the effect that

- Employees are unfairly affected, or that their employment opportunities, job security, physical, economic, moral or social welfare is prejudiced,
- An employer's business is unfairly affected or disrupted,
- Labour unrest is promoted,
- The employer/employee relationship is unfairly affected, or
- Any other labour practice, or change to a labour practice, which has a similar effect to the above

The cause of the complaint about the definition seems to be twofold. The perceived limitlessness of the concept, and the competence of the Industrial Court to determine whether a given event, or circumstance, amounts to an unfair labour practice and to provide relief where necessary

There are no easy solutions to the problem. However, on TV some time ago, Bobby Godsell, Anglo American's industrial relations

adviser, suggested that organised labour and employer groups could themselves give content to the concept of an unfair labour practice. There is a great deal of merit in this proposal

At present employer and employee parties have a limited ability to give expression to an unfair labour practice because it is a statutory concept. In theory, they are unable to agree in advance on what constitutes an unfair labour practice, or for that matter, what does not constitute an unfair labour practice. However, they can define certain practices as undesirable and have them proscribed, say, in an industrial council agreement

The remedy for the breach of an industrial council agreement lies in a criminal prosecution. The same conduct which results in the breach of an industrial council agreement could give rise to an alleged unfair labour practice. In determining the matter the Industrial Court will pay attention to the provisions of the industrial council agreement, but only as a relevant — and not necessarily decisive — factor

Although the parties are unable to agree in advance on what constitutes an unfair labour practice as a matter of law, they do have a say in the matter after the offending act has been committed. Both industrial councils and conciliation boards (in cases where one is appointed) are given the opportunity to settle disputes involving an alleged unfair labour practice and, if they fail to do so, the Industrial Court will finally determine the matter

There can be no fundamental objection to giving the parties the right to decide upon what is an unfair labour practice before a dispute arises if they already have the com-

petence to do so after a dispute has arisen. The tentative solution which is proposed here gives such competence to the parties in advance.

The proposal would require an amendment to the LRA to give employer and employee parties a statutory competence at some level of collective bargaining to define in advance the content of an unfair labour practice. It is envisaged that the parties would make use of collective bargaining to give body to the concept. They could then define what conduct will amount to an unfair labour practice and possibly what conduct will not. In doing so, they will arrive at an acceptable definition of an unfair labour practice in so far as their particular situation and relationship is concerned. It may be left for debate as to whether non-parties should be bound by certain such agreements.

The Industrial Court should be competent, on application, to interpret the agreed definition of an unfair labour practice and to decide whether the conduct complained of constitutes an unfair labour practice. It is debatable whether the parties should be permitted to decide in advance upon the appropriate remedy. It is suggested that this should be left to the Industrial Court.

In as much as the parties to a dispute have failed, or were unable, to give content to the concept, a residual competence should be retained by the Industrial Court to adjudicate on the question whether an unfair labour practice has been committed and to provide, and, if necessary, enforce, a suitable remedy.

It is suggested that the proposal could go some way to removing the present dissatisfaction with the content and determination of alleged unfair labour practices

discussed, he said

Next 21/10/06
Goodwill pact in the platteland

Mercury Reporter

AN INDABA-TYPE pact between black workers and white farmers and town-folk in the Ngotshe district of Northern Natal is to be signed in Louwsberg next week

The pact, to be known as the Ngotshe Co-operation Agreement, is aimed at promoting goodwill between the predominantly Afrikaans-speaking white population and black people in the area

Among the objectives are an improvement in labour relations, the safeguarding of the traditional Zulu way of life and improving security in the district

The pact was conceived by Mr David Masuka, a former union worker, who approached Mr Tjaart van Rensburg, chairman of the Louwsburg Farmers' Association

Skinner better

PRETORIA

RUMPSTEAK

4,99

kg (C1 upwards)

STEWING BEEF & BRISKET

2,99

kg (Super, A1)

VENISON CURRY PIECES

4,38

kg

MUTTON SAUSAGE

Sanctions will bring no peace to the work-place

THE REALITY and effect of economic sanctions and disinvestment would hit all South Africans and there would be no peace in the work-place, an industrial relations seminar in Durban was told last week.

Mrs Sebolelo Mohajane, a director of Careers Centre, told the Institute of Personnel Management-organised seminar attended by more than 150 top managers that it would have been too late for negotiations

She said that in the years between 1996 and 2000 the workers would be a black majority that would be highly politicised and revolutionary, and the violence in the townships would make a shift to the labour front

'The reality, effect and result of sanctions and disinvestment will only be real then on all races This time whites as well Negotiations will not even be thought of — it will be too late'

All victims

'The most painful issue is that all South Africans will be victims, the active as well as the passive The effects will be hard-hitting and no peace in the work-place,' she said in a paper *Township Youth Today's Children, Tomorrow's Workers*

She said the present discontent among blacks, especially schoolchildren, appeared to stem from apartheid education and the pillars of apartheid — the Group Areas Act, the homelands concept and separate voters' roll

'Unless all these are done away with there will be no peace,' she said, adding that there was, however, still hope for peaceful change

She appealed to business leaders to take a positive stand in abolishing apartheid and all its pillars They could also help improve education by helping create more vocational educational programmes to provide students with strong academic and real job-related skills

She said black schools had virtual-

Mariah Vengtas
Labour Reporter

ly become major battle-grounds in the struggle for fundamental social change, and what initially started as a protest over education grievances had now been extended to embrace wider community and political issues

Education had virtually come to a standstill, and there were hundreds of thousands of children out of school in many parts of the country

The 1976 students' revolt marked the beginning of a new phase in the educational situation 'Bantu Education' as a policy had failed And just as the black students in schools and universities continued to challenge the State's educational system so, too, in the wider South African context the black communities challenged the State's policies

The 1970s had seen a shift in application of the policy of 'Bantu Education'

The boom in the economy, the move into more advanced industrial technology, the rapid forward mobility for the privileged whites, and the State's attempt to co-opt more blacks into its politics strategy, created a greater need for more skilled and semi-skilled black labour

Mrs Mohajane said that although the growth of the black school population in the late 1970s was vast, this growth was accompanied by a number of factors that only served to heighten the failure of the State's educational policy, the emergence of the independent black trade-union movement, the spread of the black-consciousness ideology, the significant downturn in the economy, the growing and high rate of unemployment and the liberation of Angola and Mozambique

The cumulative effect of all these factors was to spill over to the schools

The student revolts of 1976 and the

school boycotts of 1980 heightened certain characteristics of student action that were to become an integral part in the 1980s students' rejection of the State's education system

'The inadequacies of the State's racist educational system were seen as short-term demands, while the national struggle for liberation — and therefore the linkage to broader community and political issues — became an important part of the students' educational struggle

'The events of 1980 reinforced the depth and extent of the educational crisis in South Africa It also significantly re-emphasised the failure of the State's educational system to realise its political objective

'The heightened political consciousness of the students, their strengthened organisational abilities and their long-term perspectives regarding the need for a fundamentally changed educational system underlined this failure,' she added

Labour arena

Although the schools were quiet in 1981 and 1982, the labour arena was intensively active during this period

In 1981 and 1982 Fosatu-affiliated unions were involved in 183 strikes and its signed membership nearly doubled, increasing from 59 460 to 105 690 in 1982, Mrs Mohajane said, adding that this appeared to have had an effect on student organisation At the Congress of South African Students' second annual congress in Cape Town the theme was worker student action

Then 1984 saw an intensification of the educational crisis in South Africa 'The poor Department of Education and Training results of November, 1983, evoked considerable anger, and by the end of that year it was estimated that more than 500 000 students had been in protests against the State's educational system'

19/8/86 Eve Post

132

Politics seen as integral part of labour relations

CAPE TOWN — The overwhelming majority of companies in South Africa have accepted politics as an integral part of labour relations, and "almost no management" believes it can remain aloof from political issues if it hopes to survive, according to the findings of a nationwide survey on manpower development

The survey of 100 major businesses by FSA (Pty) Ltd Management Consultants found that 24% of employers were prepared to become actively and directly involved in promoting political change

Although the majority said they preferred to put pressure on the Government through employer bodies like chambers of commerce and industry, only 11% said they would not get involved at all

Companies reported coming under increasing pressure from employees and trade unions to help secure the release of detainees and to stop supplying the South African Defence Force and the South African Police

Most companies rated communications with trade unions as more important than contact with the Government, although they believed both were essential to improving the political situation

One of the most disturbing trends to emerge from the survey was the "low-key but widespread" backlash from white workers against companies' equal opportunities policies and liberal political stance.

White workers objected to making up for production lost due to black stayaways and accused companies of doing too much for black employees and too little for whites

The result had been a swing by white workers towards right-wing trade unions

132 DD 20/8/86 (188) LONDON - Five there had been

Manufacturer denies withholding benefits

Dispatch Reporter

EAST LONDON — The Border Industrial Council for the Furniture Manufacturing Industry has denied claims by employees at a Greenfields furniture manufacturer that they would only receive their benefits pay during December following the closure of the company two weeks ago

A representative of the 58 employees at Totem Design, Mr Themba Patrick Sinobola, said yesterday that all employees in the company had been informed by management on Thursday, August 7, that the company would close down the following day.

Mr Sinobola, who had been working at Totem Design for two years, said the employees had been given no reason for the closure and had been told they could collect their benefits pay from the local offices of the Border Industrial Council for the Furniture Manufacturing Industry

The employees claimed that they

were subsequently told by the council that they would only get their benefits pay in December

The chairman of the Border Industrial Council for the Furniture Manufacturing Industry, Mr P W Mackie, said yesterday that, according to the agreement regulated by the council, the employees would be entitled to be paid out their entitlement under the Provident Fund three months after leaving the furniture manufacturing industry

"In the case of Totem Design though, special arrangements have been made to advance money against the Provident Fund entitlement to assist the employees who have suddenly lost income," Mr Mackie said

The employees holiday pay was normally paid out during December of each year, he added

The manager of Totem Design, Mr N G. Terblanche, could not be contacted for comment yesterday

Suburbs

had vowed not to take the Azanian National Youth Unity threatened

132 DD 20/8/86

Manufacturer denies withholding benefits

Dispatch Reporter

EAST LONDON — The Border Industrial Council for the Furniture Manufacturing Industry has denied claims by employees at a Greenfields furniture manufacturer that they would only receive their benefits pay during December following the closure of the company two weeks ago

A representative of the 58 employees at Totem Design, Mr Themba Patrick Sinobola, said yesterday that all employees in the company had been informed by management on Thursday, August 7, that the company would close down the following day

Mr Sinobola, who had been working at Totem Design for two years, said the employees had been given no reason for the closure and had been told they could collect their benefits pay from the local offices of the Border Industrial Council for the Furniture Manufacturing Industry

The employees claimed that they

were subsequently told by the council that they would only get their benefits pay in December

The chairman of the Border Industrial Council for the Furniture Manufacturing Industry, Mr P W Mackie, said yesterday that, according to the agreement regulated by the council, the employees would be entitled to be paid out their entitlement under the Provident Fund three months after leaving the furniture manufacturing industry

"In the case of Totem Design though, special arrangements have been made to advance money against the Provident Fund entitlement to assist the employees who have suddenly lost income," Mr Mackie said

The employees holiday pay was normally paid out during December of each year, he added

The manager of Totem Design, Mr N G Terblanche, could not be contacted for comment yesterday

No. R. 1753 22 Augustus 1986

WET OP ARBEIDSVERHOUDINGE, 1956
BOUNYWERHEID, WESTELIKE PROVINSIE - WY-
SIGING VAN DIE OORENKOMS VIR DIE KAPSE
SKIEREILAND

Ek, Pieter Theunus Christiaan du Plessis, Minister van
Mannetrag, verklaar hierby—

(a) kragens artikel 48 (1) (a) van die Wet op Arbeidsver-
houdinge, 1956, dat die bepalings van die Ooreen-
koms (hierna die Wysigingsooreenkoms genoem) wat
in die Bylae hiervan verskyn en betrekking het op die
Onderneming, Nywerheid, Bedryf of Beroep in die
Opkorf by hierdie kennisgewing verniel, met ingang
van die tweede Maandag na die datum van publikasie
van hierdie kennisgewing en vir die tydperk wat op 31
Maart 1989 eindig, bindend is vir die werkgewers-
ooreenkoms aangegaan het en vir die werkgewers en
werknemers wat lede van genoemde organisasies of
verenigings is, en

(b) kragens artikel 48 (1) (b) van genoemde Wet, dat die
bepalings van die Wysigingsooreenkoms, uitgeson-
derd dié vervat in klousules 1 (1) (a) en (3), met
ingang van die tweede Maandag na die datum van
publikasie van hierdie kennisgewing en vir die tyd-
perk wat op 31 Maart 1989 eindig, bindend is vir alle
ander werkgewers en werknemers as dié genoem in
paragraaf (a) van hierdie kennisgewing wat betrokke
is by of in diens is in genoemde Onderneming, Ny-
werheid, Bedryf of Beroep in die gebiede in klousule
1 van die Wysigingsooreenkoms gespesifiseer

P T C DU PLESSIS,
Minister van Mannetrag

BYLAE

NYWERHEIDSRAD VIR DIE BOUNYWERHEID
(WESTELIKE PROVINSIE)

OORENKOMS

ooreenkomsing die Wet op Arbeidsverhoudinge 1956 gesluit deur en
aangegaan tussen die

Master Builders' and Allied Trades Association (Cape Peninsula)
Master Masons' and Quarry Owners' Association (South Africa) wat
sy lede in die Monumentklippeslywerheid verteenwoordig
(hierna die werkgewers of die werkgewersorganisasies genoem),
aan die een kant en die

Amalgamated Society of Woodworkers of South Africa
Amalgamated Union of Building Trade Workers of South Africa
South African Operative Masons' Society
South African Woodworkers' Union
Building Workers' Union

(hierna die werknemers of die vakverenigings' genoem), aan die
ander kant
wat die partye is by die Nywerheidsraad vir die Bounywerheid (Westelike
Provinsie)

HOOFSTUK I

1 TOEPASSINGSBESTEK

(1) Hierdie Ooreenkoms moet in die Bou- en die Monumentklippes-
nywerheids nagekom word—
(a) deur alle werkgewers wat lede van die werkgewersorganisasies is
en deur alle werknemers wat lede van die vakverenigings is.

No. R. 1753 22 Augustus 1986

LABOUR RELATIONS ACT, 1956
BUILDING INDUSTRY, WESTERN PROVINCE -
AMENDMENT OF THE AGREEMENT FOR THE CAPE
PENINSULA

I, Pieter Theunus Christiaan du Plessis, Minister of Man-
power, hereby—

(a) in terms of section 48 (1) (a) of the Labour Relations
Act, 1956, declare that the provisions of the Agree-
ment (hereinafter referred to as the Amending
Agreement) which appears in the Schedule hereto and
which relates to the Undertaking, Industry, Trade or
Occupation referred to in the heading to this notice,
shall be binding, with effect from the second Monday
after the date of publication of this notice and for the
period ending 31 March 1989 upon the employers'
organisations and the trade unions which entered into
the Amending Agreement and upon the employers
and employees who are members of the said organisa-
tions or unions, and

(b) in terms of section 48 (1) (b) of the said Act, declare
that the provisions of the Amending Agreement, ex-
cluding those contained in clauses 1 (1) (a) and 3,
shall be binding, with effect from the second Monday
after the date of publication of this notice and for the
period ending 31 March 1989, upon all employers
and employees, other than those referred to in para-
graph (a) of this notice, who are engaged or employ-
ed in the said Undertaking, Industry, Trade or Occupa-
tion in the areas specified in clause 1 of the Amending
Agreement

P T C DU PLESSIS,
Minister of Manpower

SCHEDULE

INDUSTRIAL COUNCIL FOR THE BUILDING INDUSTRY
(WESTERN PROVINCE)

AGREEMENT

in accordance with the provisions of the Labour Relations Act 1956 made
and entered into by and between the

Master Builders' and Allied Trades Association (Cape Peninsula)
Master Masons' and Quarry Owners' Association (South Africa)
representing its members in the Monumental Masonry Industry
(hereinafter referred to as the employers or the employers' organisa-
tions) of the one part, and the
Amalgamated Society of Woodworkers of South Africa
Amalgamated Union of Building Trade Workers of South Africa
South African Operative Masons' Society
South African Woodworkers' Union
Building Workers' Union

(hereinafter referred to as the employees or the trade unions), of the
other part
being the parties to the Industrial Council for the Building Industry (West-
ern Province)

CHAPTER I

1 SCOPE OF APPLICATION

(1) The terms of the Agreement shall be observed in the Building and
Monumental Masonry Industries—
(a) by all employers who are members of the employers' organisations
and by all employees who are members of the trade unions

(b) in die landdrosdistrik Die Kaap Wynberg faai lobe-grip van daer-
die gedeelte van die landdrosdistrik Somerset-Wes wat voor 9
Maart 1973 (Goewernementskennisgewing 173 van 9 Februarie 1973)
binne die landdrosdistrik Wynberg geval het, Simonstad, Good-
wood en Bellville in daardie gedeeltes van die landdrosdistrikte
Malmesbury en Stellenbosch wat voor die publikasie van
ondersteunende Goewernementskennisgewings 171 van 8 Februarie
1957 en 283 van 2 Maart 1962 binne die landdrosdistrik Bellville
geval het en in daardie gedeelte van die landdrosdistrik Koolswiwer
wat voor die publikasie van Goewernementskennisgewing 661 van 19
April 1974 binne die landdrosdistrik Stellenbosch geval het maar
wat voor 2 Maart 1962 (Goewernementskennisgewing 283 van 2
Maart 1962) binne die landdrosdistrik Bellville geval het

(2) Ondanks subklousule (1) is hierdie Ooreenkoms—
(a) van toepassing op vakleerlinge slegs vir sover dit nie onbestaanbaar
is met die Wet op Mannetragopleiding 1981 of met 'n kontrak
wat daarvolgens aangegaan of met voorwaardes wat daartrekgens
gestel is nie

(b) van toepassing op kwelinge wat opgesel word ooreenkomsing die
Wet op Mannetragopleiding 1981 slegs vir sover dit nie onbe-
staanbaar is met daardie Wet of met voorwaardes wat daartrekgens
gestel is nie

(c) van toepassing op slegs-arbeid, konstruksie, werkende vermoete
en werkende direkteurs prinsipale en aannemers

(3) Ondanks subklousule (1) (a) is hierdie Ooreenkoms—
(a) nie van toepassing op klein- en administratiewe personeel nie
(b) nie van toepassing nie op universiteitsstudente en gegradueerdes in
die bouwetenskap en op konstruksie- en konstruksie-ople-
meters en ander persone wat besig is met praktiese werk ter voltoo-
ing van hul akademiese opleiding

2 KLOUSULE 16 - LONE-BASISS

Vervang subklousule (1) deur die volgende
Behoudens die ander bepalings van hierdie klousule mag geen loon
wat laer is as die volgende deur 'n werkgewer betaal en deur 'n werknemer
aangeneem word nie

Werknemerkategorie

Minimum
loon
per uur

(a) Algemene werkers 163

(b) Met dien verstande dat werknemers wat ongeskoolde
werk verrig en benevens sy gewone werk die pligte van
n wag uitvoer R5 per week ekstra betaal moet word

(c) Slaomakers 114

(d) Plafon en afskrotingswerkers, waterdruingswerkers
vervaardigingswerkers en leerling-masjienbedieners ge-
durende die eerste jaar van leerlingstap 194

(e) Waterdruingspanneleiers, skryfwerkmoniteurs, leerling-
masjienbedieners gedurende die tweede jaar leerlingstap
en leerling blokkleers gedurende die jaar leerlingstap 237

(f) Ambagsman se assistente blokkleers, mampassers assis-
tent vloerleers, masjienbedieners 329

(g) Leerling-ambagsmanne en leerling-malers asook pla-
fon- en/of afskrotingsoprigters vloerleers, dakwerkers en
wandregters wat leerlingstapkontrakte uitdien van by die
Raad geregistreer is

Eerste jaar 176
Tweede jaar 204
Derde jaar 204
Vierde jaar 245

(h) Kweklingmalers en kwekling-assistent vloerleers wat
kweklingkontrakte uitdien wat by die Raad geregistreer
is

Eerste jaar 176
Tweede jaar 204
Derde jaar 204
Vierde jaar 245

(i) Ambagsmanne wat geskoolde werk verrig in alle
ambagte met inbegrip van malers, plafon- en/of
afskrotingsoprigters, ruitwerkers, dakwerkers,
vloerleers, wandregters motor- en masjienwerk-
tuigkundiges en passers en draers

(ii) Vakmanne 445
(iii) Meestervakmanne 500
(iv) Voormanne 555
555

(v) Voormanne 555

(vi) Voormanne 555

(vii) Voormanne 555

(viii) Voormanne 555

(ix) Voormanne 555

(x) Voormanne 555

(xi) Voormanne 555

(xii) Voormanne 555

(xiii) Voormanne 555

(xiv) Voormanne 555

(xv) Voormanne 555

(xvi) Voormanne 555

(xvii) Voormanne 555

(b) in die Magisterial Districts of The Cape, Wynberg (includng that
portion of the Magisterial District of Somerset West which, prior to
9 March 1973 (Government Notice 173 of 9 February 1973), fell
within the Magisterial District of Wynberg), Simon's Town, Good-
wood and Bellville, in those portions of the Magisterial Districts of
Malmesbury and Stellenbosch which prior to the publication of
Government Notices 171 of 8 February 1957 and 283 of 2 March
1962, respectively, fell within the Magisterial District of Bellville
and in that portion of the Magisterial District of Koolswiwer which
prior to the publication of Government Notice 661 of 19 April
1974 fell within the Magisterial District of Stellenbosch but which
prior to 2 March 1962 (Government Notice 283 of 2 March 1962)
fell within the Magisterial District of Bellville

(2) Notwithstanding the provisions of subclause (1), the terms of this
Agreement shall apply to—
(a) apprentices only in so far as they are not inconsistent with the
provisions of the Manpower Training Act 1981, or any contract
entered into or any conditions fixed thereunder

(b) trainees under the Manpower Training Act, 1981, only in so far as
they are not inconsistent with the provisions of that Act or any
conditions fixed thereunder

(c) labour-only contractors, working partners and working direc-
tors, principals and contractors

(3) Notwithstanding the provisions of subclause (1) (a) the terms of this
Agreement shall—
(a) not apply to clerical employees and administrative staff
(b) not apply to university students and graduates in building science
and to construction supervisors, construction surveyors and other
persons doing practical work in the completion of their academic
training

2 CLAUSE 16 - WAGES - BASIC

Substitute the following for subclause (1)
Subject to the remaining provisions of this clause, no employer shall
pay and no employee shall accept wages at rates lower than the following

Category of employee

Minimum
wage
per hour

(a) General workers 163

(b) Provided that any employee engaged in unskilled work
who in addition to his ordinary work performs the duties
of a watchman shall be paid R5 per week extra

(c) Cleaners 114

(d) Ceiling and partition workers, waterproofing workers
manufacturing workers and trainee machine operators
during first year of traineeship 194

(e) Waterproofing team leaders, joinery assemblers, trainee
machine operators during second year of traineeship and
trainee block layers during year of traineeship 237

(f) Artisan's assistants, block layers, carpet fitters, assistant
floor layers, machine operators 329

(g) Learner artisans and learner carpet layers, ceiling and/or
partition erectors, floor layers, roofers and waterproofers
serving under contracts of learnership with the Council

First year 176
Second year 204
Third year 204
Fourth year 245

(h) Trainee carpet fitters and trainee assistant floor layers
serving under contract of traineeship registered with the
Council

First year 176
Second year 204
Third year 204
Fourth year 245

(i) Artisans engaged in the performance of skilled work
in all trades, including carpet layers, ceiling and/or
partition erectors, glaziers, roofers, floor layers, wa-
terproofers, motor and plant mechanics, and fitters
and turners

(ii) Craftsmen 445
(iii) Master craftsmen 500
(iv) Foremen 555
555

(v) Foremen 555

(vi) Foremen 555

(vii) Foremen 555

(viii) Foremen 555

(ix) Foremen 555

(x) Foremen 555

(xi) Foremen 555

(xii) Foremen 555

(xiii) Foremen 555

(xiv) Foremen 555

(xv) Foremen 555

(xvi) Foremen 555

(xvii) Foremen 555

(k) Dryers/Masjienbedieners

- (i) Dryers van motorvoertuie of bedieners van krag-aangedrewe masjienre waarvoor die drywer of bediener in besit moet wees van 'n Kode 10-lisensie (6 500 kg en meer) of 'n Kode 11-lisensie (voor-baker en sleepwa) 263
- (ii) Dryers van motorvoertuie of bedieners van krag-aangedrewe masjienre waarvoor die drywer of bediener in besit moet wees van 'n Kode 9-lisensie (3 000 kg tot 6 500 kg) 224
- (iii) Dryers van alle ander motorvoertuie (Kode 8-lisensie) en bedieners van 'n byset of drywers van stortwagens 184

3 KLOUSULE 34 — NATIONALE ONTWIKKELINGSFONDS VIR DIE BOUWYWERHEID

In subklousule (2), verang die syfer 15c deur die syfer 30c. Namens al die partye by die Raad op hede die 5de dag van Mei 1986 in Kaapstad onderteken

H McCARTHY,
Voorzitter

R. G. SIMMONS,
Ondervoorzitter

J J KITSHOFF,
Sekretaris

No. R. 1754 22 Augustus 1986

WET OP ARBEIDSVORHOUDINGE, 1956
BOUWYWERHEID WESTELIKE PROVINSIE — WYSIGING VAN DIE OOREENKOMS VIR DIE BOLAND

Ek, Pieter Theunus Christiaan du Plessis, Minister van Maanekrag, verklaar hierby—

- (a) kragens artikel 48 (1) (a) van die Wet op Arbeidsvorhoudinge, 1956, dat die bepalings van die Ooreenkoms (hierna die Wysigingsooreenkoms genoem) wat in die Bylae hiervan verskyn en betrekking het op die Onderneming, Nywerheid, Bedryf of Beroep in die opskrif by hierdie kennisgewing vermeld, met ingang van die tweede Maandag na die datum van publikasie van hierdie kennisgewing en vir die tydperk wat op 31 Oktober 1987 eindig, bindend is vir die werkgewers-organisasie en die vakverenigings wat die Wysigingsooreenkoms aangegaan het en vir die werkgewers en werknemers wat lede van genoemde organisasie of verenigings is, en
- (b) kragens artikel 48 (1) (b) van genoemde Wet, dat die bepalings van die Wysigingsooreenkoms, uitgesonderd dié vervat in klousules 1 (1) (a) en 3, met ingang van die tweede Maandag na die datum van publikasie van hierdie kennisgewing en vir die tydperk wat op 31 Oktober 1987 eindig, bindend is vir alle ander werkgewers en werknemers as dié genoem in paragraaf (a) van hierdie kennisgewing wat betrokke is by of in diens is in genoemde Onderneming, Nywerheid, Bedryf of Beroep in die gebiede in klousule 1 van die Wysigingsooreenkoms gespesifiseer

P T C DU PLESSIS,
Minister van Maanekrag

BYLAE
NYWERHEIDSKRAAD VIR DIE BOUWYWERHEID
(WESTELIKE PROVINSIE)

OOREENKOMS

Ooreenkomsing die Wet op Arbeidsvorhoudinge, 1956, gesluit deur en aangegaan tussen die

Boland Master Builders' Assosiation
(hierna die werkgewers of die "werkgewersorganisasie" genoem) aan die een kant en die
Amalgamated Society of Woodworkers

(k) Drivers/Plan operators

- (i) Drivers of motor vehicles or operators of power-driven plant which require the driver or operator to be in possession of a Code 10 Licence (6 500 kg and over) or a Code 11 Licence (horse and trailer) 263
- (ii) Drivers of motor vehicles or operators of power-driven plant which require the operator to be in possession of a Code 9 Licence (3 000 kg to 6 500 kg) 224
- (iii) Drivers of all other motor vehicles (Code 8 Licence) and operators of a hoist or drivers of dumpers 184

3 CLAUSE 34 — NATIONAL DEVELOPMENT FUND FOR THE BUILDING INDUSTRY

In subclause (2), substitute the figure 30c for the figure 15c. Signed at Cape Town on behalf of all the parties to the Council this 5th day of May 1986

H McCARTHY,
Chairman

R. G. SIMMONS,
Vice-Chairman

J J KITSHOFF,
Secretary

No. R. 1754 22 August 1986

LABOUR RELATIONS ACT, 1956
BUILDING INDUSTRY, WESTERN PROVINCE — AMENDMENT OF THE AGREEMENT FOR THE BOLAND

I, Pieter Theunus Christiaan du Plessis, Minister of Manpower, hereby—

- (a) in terms of section 48 (1) (a) of the Labour Relations Act, 1956, declare that the provisions of the Agreement (hereinafter referred to as the Amending Agreement) which appears in the Schedule hereto and which relates to the Undertaking, Industry, Trade or Occupation referred to in the heading to this notice, shall be binding, with effect from the second Monday after the date of publication of this notice and for the period ending 31 October 1987, upon the employers' organisation and the trade unions which entered into the Amending Agreement and upon the employers and employees who are members of the said organisation or unions, and
- (b) in terms of section 48 (1) (b) of the said Act, declare that the provisions of the Amending Agreement, excluding those contained in clauses 1 (1) (a) and 3, shall be binding, with effect from the second Monday after the date of publication of this notice and for the period ending 31 October 1987, upon all employers and employees, other than those referred to in paragraph (a) of this notice, who are engaged or employed in the said Undertaking, Industry, Trade or Occupation in the areas specified in clause 1 of the Amending Agreement

P T C DU PLESSIS,
Minister of Manpower

SCHEDULE
INDUSTRIAL COUNCIL FOR THE BUILDING INDUSTRY
(WESTERN PROVINCE)

AGREEMENT

In accordance with the provisions of the Labour Relations Act, 1956, made and entered into by and between the

Boland Master Builders' Assosiation
(hereinafter referred to as the employers or the employers organisation), of the one part, and the
Amalgamated Society of Woodworkers

Amalgamated Union of Building Trade Workers of South Africa
Building Workers' Union
South African Operative Masons' Society
South African Woodworkers' Union

(hierna die werknemers of die vakverenigings ' genoem), aan die ander kant,

Wat die partye is by die Nywerheidsraad vir die Bouwywerheid (Westelike Provinsie)
om die Ooreenkoms gepubliseer by Goewermentskennisgewing R 2465 van 9 November 1984, soos wysigings by Goewermentskennisgewings R 2866 van 28 Desember 1984 en R 335 van 28 Februarie 1986, te wysig

1 TOEPASSINGSBESTEK

- (1) Hierdie Ooreenkoms moet in die Bouwywerheid nagekom word—
- (a) deur alle werkgewers wat lede van die vakverenigings is deur alle werknemers wat lede van die vakverenigings is
- (b) in die landdrosdistrikte Paarl, Wellington, Stellenbosch, Kuitersvier (uitgesonderd die gedeeltes van laasgenoemde twee distrikte wat voor die publikasie van Goewermentskennisgewing 283 van 2 Maart 1982 binne die landdrosdistrikte Bellville geval het) Somerset West (uitgesonderd daardie gedeelte wat voor 9 Maart 1973 (Goewermentskennisgewing 173 van 9 Februarie 1973) binne die landdrosdistrik Wynberg geval het) en Strand
- (2) Ondanks subklousule (1) (a) is hierdie Ooreenkoms—
- (a) van toepassing op stigs die klasse werknemers vir wie lone in hierdie Ooreenkoms voorgeskryf word en op leiding-ambagsmannes
- (b) van toepassing op vakleerlinge stigs in dié mate waarin dit nie onbestaanbaar is met die Wet op Maanekragopleiding, 1981, of met 'n kontrak daartrekkens aangegaan of voorwaardes daartrekkens voorgeskryf nie
- (c) van toepassing op kwelinge stigs in dié mate waarin dit nie onbestaanbaar is met die Wet op Maanekragopleiding, 1981 of voorwaardes daartrekkens voorgeskryf nie,
- (d) van toepassing op stigs arbeid-kontrakteurs, werkende vennote en verkende direkteurs
- (e) nie van toepassing nie op universiteitsstudente en gegradueerdes in die bouwetenskap en konstruksietegniese en ander persone wat praktiese werk doen ter verhooring van hul akademiese opleiding,
- (f) van toepassing op voormanne,
- (g) nie van toepassing op werknemers in die elektrotegniese ambagte en op administratiewe personeel nie

2 KLOUSULE 16 — LONE

Verang subklousule (1) deur die volgende—

"(1) Behouders die ander bepalings van hierdie klousule mag geen loon wat hier is as die volgende deur 'n werkgewer betaal en deur 'n werknemer aangeneem word nie

	Scans per uur
(a) Algemene werker	145
(b) Hysendruier	154
(c) Kraghysstrandrywer	161
(d) Klippolierder en terrazzowerker	161
(e) Klippolierder	161
(f) Leerling ambagsman	158
(g) Eerste jaar	183
(h) Tweede jaar	222
(i) Derde jaar	222
(j) Vierde jaar	298
(k) Ambagsman se assistent	298
(l) Ambagsman	400
(m) Vakman	450
(n) Meester-vakman	500
(o) Drywers	Per week
(p) Meer as 6 metrieke ton	R84,43
(q) 3-6 metrieke ton	R71,84
(r) Ander voertuie	R62,43
(s) Nagweg	R60,92
(t) Skoornaker	101
(u) Vakleerlinge:	
(v) Eerste jaar	183
(w) Tweede jaar	222
(x) Derde jaar	298
(y) Voorman	450

Amalgamated Union of Building Trade Workers of South Africa
Building Workers' Union
South African Operative Masons' Society
South African Woodworkers' Union

(hierna referer as die werknemers of die trade unions), of die ander part

being the parties to the Industrial Council for the Building Industry (Western Province),
to amend the Agreement published under Government Notice R 2465 of 9 November 1984 as amended by Government Notices R 2866 of 28 December 1984 and R 335 of 28 February 1986

1 SCOPE OF APPLICATION

- (1) The terms of the Agreement shall be observed in the Building Industry—
- (a) by all employers who are members of the employers organisation and by all employees who are members of the trade unions
- (b) in the Magisterial Districts of Paarl, Wellington, Stellenbosch, Kuiters River (excluding any portions of the last-mentioned two districts which, prior to the publication of Government Notice 283 of 2 March 1982, fell within the Magisterial District of Bellville) Somerset West (excluding that portion which prior to 9 March 1973 (Government Notice 173 of 9 February 1973) fell within the Magisterial District of Wynberg) and Strand
- (2) Notwithstanding the provisions of subclause (1) (a) in terms of this Agreement shall—
- (a) apply only to those classes of employees for whom wages are prescribed in this Agreement and to learner artisans,
- (b) apply to apprentices only in so far as they are not inconsistent with the provisions of the Manpower Training Act 1981 or any contract entered into or any conditions fixed thereunder
- (c) apply to trainees only in so far as they are not inconsistent with the provisions of the Manpower Training Act, 1981 or any conditions fixed hereunder
- (d) apply to labour only contractors working partners and working directors,
- (e) not apply to university students and graduates in building science and construction supervisors and other such persons doing practical work in the completion of their academic training
- (f) apply to foremen
- (g) not apply to employees in the electrical trades and administrative staff

2 CLAUSE 16 — WAGES

Substitute the following for subclause (1)

"(1) Subject to the remaining provisions of this clause no employer shall pay and no employee shall accept wages at rates lower than the following—

	Cents per hour
(a) General Worker	145
(b) Hoist Operator	154
(c) Power crane driver	161
(d) Floor sander	161
(e) Stone polisher and terrazzo worker	161
(f) Learner Artisan	158
(g) First year	183
(h) Second year	222
(i) Third year	222
(j) Fourth year	298
(k) Artisan s Assistant	298
(l) Artisan	400
(m) Craftsman	450
(n) Master Craftsman	500
(o) Drivers	Per week
(p) Over 6 metric tons	R84,43
(q) 3-6 metric tons	R71,84
(r) Other vehicles	R62,43
(s) Night watchman	R60,92
(t) Cleaner	101
(u) Apprentices:	
(v) First year	183
(w) Second year	222
(x) Third year	298
(y) Foreman	450

DEPARTEMENT VAN MANNEKRAG

No R. 1743 22 Augustus 1986

WET OP ARBEIDSVERTHOUDINGE, 1956

YSTER, STAAL-, INGENIEURS- EN METALLUR- GIESE NYWERHEID - WYSIGING VAN REGISTRA- SIE- EN ADMINISTRASIEFONDSOORENKOMS

Ek, Pieter Theunus Christiaan du Plessis, Minister van Mannekrag, verklaar hierby -

(a) kragens artikel 48 (1) (a) van die Wet op Arbeidsver- houdinge, 1956, dat die bepalings van die Ooreen- koms (hierna die Wysigingsooreenkoms genoem) wat in die Bylae hiervan verskyn en betrekking het op die Onderneming, Nywerheid, Bedryf of Bercep in die opskrif by hierdie kennisgewing vermeld, met ingang van die tweede Maandag na die datum van publikasie van hierdie kennisgewing en vir die tydperk wat op 31 Maart 1989 eindig, bindend is vir die werkgevers- ooreenkoms aangegaan het en vir die werkgewers en werknemers wat lede van genoemde organisasies of verenigings is, en

(b) kragens artikel 48 (1) (b) van genoemde Wet, dat die bepalings van die Wysigingsooreenkoms, uitgeson- derd die vervat in klousule 1 (1) (b), met ingang van die tweede Maandag na die datum van publikasie van hierdie kennisgewing en vir die tydperk wat op 31 Maart 1989 eindig, bindend is vir alle ander werk- gewers en werknemers as die genoem in paragraaf (a) van hierdie kennisgewing wat betrokke is by of in diens is in genoemde Onderneming, Nywerheid, Bedryf of Bercep in die gebiede in klousule 1 van die Wysigingsooreenkoms gespesifiseer

P T C DU PLESSIS, Minister van Mannekrag

BYLAE

NASIONALE NYWERHEIDSRaad VIR DIE YSTER-, STAAL-, INGENIEURS- EN METALLURGIESE NYWERHEID

REGISTRASIE- EN ADMINISTRASIEFONDS OOREENKOMS

ooreenkomsing die Wet op Arbeidsverthoudinge 1956, gesluit deur en aangegaan tussen die

- Association of Electric Cable Manufacturers of South Africa
Automotive Parts Production Engineers' Association
Border Engineering Industries Association
Bright Bar Association
Cape Engineers' and Founders' Association
Constructional Engineering Association
Covered Conductor Manufacturers' Association
Domestic Appliance Manufacturers' Association
Edge Hand and Small Tool Manufacturers' Association
Electrical Engineering and Allied Industries Association
Electronics and Telecommunications Industries Association
Engineers' and Founders' Association (Transvaal, Orange Free State and Northern Cape)
Ferro Alloy Producers' Association
Fire Protection Industries Association of South Africa
Forging Association of Southern Africa
Gate and Fence Manufacturers' Association of the Transvaal
Heavy Engineering Manufacturers' Association
Iron and Steel Producers' Association of South Africa
Light Engineering Industries Association of South Africa
Light Engineering Industries Association of South Africa
Materials Handling Association
Natal Engineering Industries Association
Non-Ferrous Metal Industries Association of South Africa
Plastics Manufacturers' Association of South Africa
Plumbers and Engineers Brassware Manufacturers' Association
Port Elizabeth Engineers' Association
Precision Manufacturing Engineers' Association
Precision Vessel Manufacturers' Association of South Africa
Radio, Appliance and Television Association of South Africa
Refrigeration and Air Conditioning Manufacturers' and Suppliers' Association

DEPARTMENT OF MANPOWER

No R. 1743 22 August 1986

LABOUR RELATIONS ACT, 1956

IRON, STEEL, ENGINEERING AND METALLURGI- CAL INDUSTRY - AMENDMENT OF REGISTRA- TION AND ADMINISTRATION EXPENSES AGREE- MENT

I, Pieter Theunus Christiaan du Plessis, Minister of Man- power, hereby -

(a) in terms of section 48 (1) (a) of the Labour Relations Act, 1956, declare that the provisions of the Agree- ment (hereinafter referred to as the Amending Agree- ment) which appears in the Schedule hereto and which relates to the Undertaking, Industry, Trade or Occupation referred to in the heading to this notice, shall be binding, with effect from the second Monday after the date of publication of this notice and for the period ending 31 March 1989, upon the employers' organisations and the trade unions which entered into the Amending Agreement and upon the employers and employees who are members of the said organisa- tions or unions, and

(b) in terms of section 48 (1) (b) of the said Act, declare that the provisions of the Amending Agreement, excluding those contained in clause 1 (1) (b), shall be binding, with effect from the second Monday after the date of publication of this notice and for the period ending 31 March 1989, upon all employers and employees, other than those referred to in paragraph (a) of this notice, who are engaged or employed in the said Undertaking, Industry, Trade or Occupation in the areas specified in clause 1 of the Amending Agreement

P T C DU PLESSIS, Minister of Manpower

SCHEDULE

NATIONAL INDUSTRIAL COUNCIL FOR THE IRON, STEEL, ENGINEERING AND METALLURGICAL INDUSTRY

REGISTRATION AND ADMINISTRATION EXPENSES AGREEMENT

in accordance with the provisions of the Labour Relations Act 1956 made and entered into by and between the

- Association of Electric Cable Manufacturers of South Africa
Automotive Parts Production Engineers' Association
Border Engineering Industries Association
Bright Bar Association
Cape Engineers' and Founders' Association
Constructional Engineering Association
Covered Conductor Manufacturers' Association
Domestic Appliance Manufacturers' Association
Edge Hand and Small Tool Manufacturers' Association
Electrical Engineering and Allied Industries Association
Electronics and Telecommunications Industries Association
Engineers' and Founders' Association (Transvaal, Orange Free State and Northern Cape)
Ferro Alloy Producers' Association
Fire Protection Industries Association of South Africa
Forging Association of Southern Africa
Gate and Fence Manufacturers' Association of the Transvaal
Heavy Engineering Manufacturers' Association
Iron and Steel Producers' Association of South Africa
Light Engineering Industries Association of South Africa
Light Engineering Industries Association of South Africa
Materials Handling Association
Natal Engineering Industries Association
Non-Ferrous Metal Industries Association of South Africa
Plastics Manufacturers' Association of South Africa
Plumbers and Engineers Brassware Manufacturers' Association
Port Elizabeth Engineers' Association
Precision Manufacturing Engineers' Association
Precision Vessel Manufacturers' Association of South Africa
Radio, Appliance and Television Association of South Africa
Refrigeration and Air Conditioning Manufacturers' and Suppliers' Association

Sheetmetal Industries Association of South Africa
S A Agricultural and Irrigation Machinery Manufacturers' Association
S A Association of Shipbuilders and Repairers
S A Electro Plating Industries Association
S A Fasteners Manufacturers Association
S A Foundry Association
S A Industrial Refrigeration and Air Conditioning Contractors' Association

S A Machine Tool Manufacturers' Association
S A Pump Manufacturers' Association
S A Radio and Television Manufacturers' Association
S A Reinforced Concrete Engineers' Association
S A Tube Makers' Association
S A Valve Manufacturers' Association
S A Wire and Wire Rope Manufacturers' Association

Amalgamated Engineering Union of South Africa
Amalgamated Society of Woodworkers of South Africa
Electrical and Allied Workers' Trade Union of South Africa
Electrical and Allied Workers' Union of South Africa
Engineering Industrial Workers' Union of South Africa
Iron Moulders' Society of South Africa
Mine Workers' Union
Radio Television, Electronic and Allied Workers' Union
S A Boilermakers', Iron and Steel Workers', Shipbuilders' and Welders' Society
S A Electrical Workers' Association
S A Engine Drivers', Firemen's and Operators' Association
S A Yster-, Staal- en Verrante Nywerheide-Unie

DEEL I ALGEMEEN

1 TOEPASSINGSBESTEK VAN OOREENKOMS

- (1) Hierdie Ooreenkoms moet nagekom word -
(a) deur alle werkgewers en werknemers in die Yster, Staal, Inge- nieurs en Metallurgiese Nywerheide wat lede is van onderskeidelik die werkgewersorganisasies en die vakverenigings nie
(2) Ondanks subklousule (1) is hierdie Ooreenkoms nie van toepassing nie op -
(a) die vervaardiging, vir verkoop van standaard snelsny gereedskap gemaak van steelestaal deur middel van masjiene en/of uitru- ting en/of metodes wat spesiaal aangeleg is en/of ontwerp is vir pro- duksie deur herhalingsprosesse in die landdroststrikte Johannes- burg Boksburg Vereniging en Pietermaritzburg,
(b) die installering, onderhoud en herstel van elektriese uitrusting soos bedoel in paragraaf (b) van die omskrywing van Elektriese Inge- nieursnywerheid in klousule 3 van Deel I van die Ooreen- koms gepubliseer by Goewernementskennisgewing R 1329 van 27 Junie 1980 in die provinsies die Kaap die Goete Hoop en die Orange Vrystaat
(c) die monter, versiening, installering, onderhoud en/of herstel van toestelle uitrusting masjiene, werktuie en apparat of di van hand- fotografiese meganiese, elektriese, elektrosistansie- of elek- troniese beginsels, of n kombinasie van sodanige beginsels gebruik maak wat in die eerste plek bedoel is vir gebruik in rekeningskonde- en/of sake en/of betekenis- en/of kantoer- en/of opvoedkundige prosedures,
(d) die Vervaardigingsnywerheid vir Hortuiesblinders en Verwante Produkte in die provinsie Transvaal
(e) die installering en/of herstel van dief- en/of ander soortgelyke alarmsistels in die provinsies die Kaap die Goete Hoop en die Orange Vrystaat
(f) die Stoornis- en/of die janddroststrikte Benoni Boksburg, Die Kaap Durban, Germiston Johannesburg, Knysendorp, Lower Unifolzi, Pinetown, Port Elizabeth, Pretoria, Randburg, Rood- poort en Springs
(g) die produksie, vir verkoop van swisielektrodes deur middel van masjiene en/of uitrusting en/of metodes wat spesiaal aangepas en/of ontwerp is vir produksie deur herhalingsprosesse in die hand- droststrikte Brits, Germiston, Kempton Park en Pretoria.

Sheetmetal Industries Association of South Africa
S A Agricultural and Irrigation Machinery Manufacturers' Association
S A Association of Shipbuilders and Repairers
S A Electro Plating Industries Association
S A Fasteners Manufacturers Association
S A Foundry Association
S A Industrial Refrigeration and Air Conditioning Contractors' Association

S A Machine Tool Manufacturers' Association
S A Pump Manufacturers' Association
S A Radio and Television Manufacturers' Association
S A Reinforced Concrete Engineers' Association
S A Tube Makers' Association
S A Valve Manufacturers' Association
S A Wire and Wire Rope Manufacturers' Association

Amalgamated Engineering Union of South Africa
Amalgamated Society of Woodworkers of South Africa
Electrical and Allied Workers' Trade Union of South Africa
Electrical and Allied Workers' Union of South Africa
Engineering Industrial Workers' Union of South Africa
Iron Moulders' Society of South Africa
Mine Workers' Union
Radio Television, Electronic and Allied Workers' Union
S A Boilermakers', Iron and Steel Workers', Shipbuilders' and Welders' Society
S A Electrical Workers' Association
S A Engine Drivers', Firemen's and Operators' Association
S A Yster-, Staal- en Verrante Nywerheide-Unie

PART I GENERAL

1 SCOPE OF APPLICATION OF AGREEMENT

- (1) The terms of this Agreement shall be observed -
(a) throughout the Republic of South Africa and
(b) by all employers and employees in the Iron Steel Engineering and Metallurgical Industries who are members of the employers organ- isations and the trade unions respectively
(2) Notwithstanding the provisions of subsection (1) the terms of this Agreement shall not apply to -
(a) the manufacture for sale of standard high-speed cutting tools made from high speed steel by means of plant and/or equipment and/or methods specifically adapted and/or designed for production by repetitive processes in the Magisterial Districts of Johannes- burg Boksburg Vereniging and Pietermaritzburg
(b) the installation, maintenance and repair of electrical equipment referred to in paragraph (b) of the definition, Electrical Engineering Industry, in section 3 of Part I of the Agreement published under Government Notice R 1329 of 27 June 1980, in the Provinces of the Cape of Good Hope and the Orange Free State
(c) assembling, servicing, installation, maintenance and/or repair of appliances, equipment, machines, devices and apparatus whether utilizing manual photographic, mechanical, electrical, electrostatic or electronic principles or any combination of such principles that are primarily intended for use in accounting and/or business and/or calculating and/or office and/or educational procedures,
(d) the Venetian Blind and Allied Products Manufacturing Industry in the Province of the Transvaal
(e) the installation and/or repair of burglar and/or other similar alarm systems in the Provinces of the Cape of Good Hope and the Orange Free State
(f) the Locksmithing trade in the Magisterial Districts of Benoni Boksburg, Durban, Germiston, Johannesburg, Knysendorp, Lower Unifolzi, Pinetown, Port Elizabeth, Pretoria, Randburg, Rood- poort, Springs and The Cape
(g) the production for sale of welding electrodes by means of plant and/or equipment and/or methods specifically adapted and/or designed for production by repetitive processes in the Magisterial Districts of Brits, Germiston, Kempton Park and Pretoria.

(b) die installering en/of herstel en/of versiening van radio's en/of koelkassies en/of huishoudelike elektriese toestelle in die provinsies die Kaap die Oos- en die Oranje-Vrystaat.

(1) die verandering deur middel van massaproduktiesmetodes van—

- (aa) kommersiële, gewone of gelithografeerde houers vir die verpakking van algemene handelsware, maar nie die verpakking van sodanige houers deur iemand vir die verpakking van sy eie produkte nie,
- (ab) deksels vir bottels, flesses en ander houers,
- (ac) gewone of gelithografeerde metaalbeslagings,
- (ad) gewone of gelithografeerde verbindingskabels.

(u) die verandering van gewone of gelithografeerde vaste en/of vloeibare buise uit nie-ysterhoudende metaalkompositiese verpakking van hierdie subparagraaf betelste vaste buise n houers.

Vir die toepassing van subparagraaf (1) en (u) betelste 'n houer 'n gewone of gelithografeerde artikel wat ontwerp is vir die verpakking van produkte wat vervoer of verkoop moet word en wat met 'n deksel of doppe of ander soort prop toegemaak kan word.

(v) die verandering uit tynplaat van hoogstens 0,416 mm van koefers en ander houers wat ontwerp is om persoonlike besittings sportuusting, gereedskap en dokumente te bevat, en van ander ware wat hoogsaalik uit sodanige tynplaat vervaardig is.

(3) Ondanks subklousule (1) is hierdie Ooreenkoms van toepassing op—

- (a) vabekleefde siegels vir sover dit nie onbestaanbaar is met die Wet op Mannekragsopleiding 1981 of met 'n kontrak daartrekkende aangegeen of voorwaardes daartrekkende vasgestel nie en
- (b) kwekkelinge wat opgedeel word kragtens artikel 30 van die Wet op Mannekragsopleiding 1981 siegels vir sover dit nie onbestaanbaar is met daardie Wet of met voorwaardes daartrekkende vasgestel nie.

2 ALGEMENE BEPALINGS

Verwag klousule 4 van die Herbekeuringsooreenkoms deur die volgende.

Klousules 3 en 4 van Deel I, Deel II (soos gewysig by klousule 3 heronder) Deel III (soos gewysig by klousule 4 heronder) en klousule 1 en 3 van Deel IV van die Voorge Ooreenkoms is van toepassing op werkgewers en werknemers.

DEEL II

3 KLOUSULE 1—BYDRABS

(a) In subklousule (2) (a) (i) vervang die syfer '5c' deur die syfer 6c.

(b) In subklousule (2) (a) (u) vervang die syfer '10c' deur die syfer 12c.

(c) In subklousule (3) vervang die syfer R10 deur die syfer R12.

DEEL III

4 KLOUSULE 1—REGISTRASIE

(a) In subklousule (1) (a), voeg die volgende in na die uitdrukking 'die volle name en adresse van die direkteur en die sekretaris',

'en indien die werkgewer 'n beslore korporasie is, die volle name en adresse van die lede en die sekretaris,

(b) In subklousule (1) (b) voeg die uitdrukking 'of beslore korporasie in na die woord 'maatskappy' waar dit ook al voorkom.

Vir en namens die partye op beide die 21ste dag van April 1986 te Johannesburg onderteken

C J M PRINSLOO, Voorzitter
B NICHOLSON, Ondervoorsitter
A O DE JAGER, Hoofsekretaris

No. R. 1744 **22 Augustus 1986**

WET OP ARBEIDSVERRHOUDINGE, 1956

YSTER-, STAAL-, INGENIEURS EN METALLURGIESE NYWERHEID—HERBEKRAGTING VAN HOOFOOREENKOMS

Ek, Pieter Theuns Christiaan du Plessis, Minister van Mannekrag, verklaar hierby—

(a) kragtens artikel 48 (1) (a) van die Wet op Arbeidsverrhoudings, 1956, dat die bepalinge van die Ooreenkoms wat in die Bylae hiervan verskyn en betrekking

(b) the installation and/or repair and/or servicing of radios and/or refrigerators and/or domestic electrical appliances in the Provinces of the Cape of Good Hope and the Orange Free State.

(1) the manufacture by mass production methods from sheet-metal of a gauge not heavier than 2 108 mm of—

- (aa) commercial plan or lithographed containers for packaging of general merchandise but excluding the manufacture of such containers by any person for the packaging of his own products
- (ab) bottle jar and other container closures,
- (ac) plan or lithographed metal toys,
- (ad) plan or lithographed display cabinets,
- (u) manufacture of plan or lithographed rigid and/or collapsible tubes from non-ferrous metal slugs. For the purposes of this sub-paragraph "rigid tube" shall mean a container

For the purposes of sub-paragraph (1) and (u), a container shall mean a plan or lithographed article designed for the packaging for transport or sale, of products and capable of being closed by means of a lid or cap or any other type of closure.

(v) the manufacture from tinplate not exceeding 0.416 mm of tins and other containers designed to hold personal effects sporting kits tools and documents and other lines manufactured principally from such tinplate.

(3) Notwithstanding the provisions of subsection (1) the terms of this Agreement shall apply to—

- (a) apprentices only in so far as they are not inconsistent with the provisions of the Manpower Training Act 1981 or any contract entered into or any conditions fixed thereunder, and
- (b) trainees under training in terms of section 30 of the Manpower Training Act 1981, only in so far as they are not inconsistent with the provisions of that Act or any conditions fixed thereunder.

2. GENERAL PROVISIONS

Substitute the following for section 4 of the Re-enacting Agreement.

"The provisions contained in sections 3 and 4 of Part I Part II (as amended by section 3 hereunder) Part III (as amended by section 4 hereunder) and sections 1 and 3 of Part IV of the Former Agreement shall apply to employers and employees

PART II

3 SECTION 1—CONTRIBUTIONS

(a) In subsection (2) (a) (i), substitute the figure '6c' for the figure 5c.

(b) In subsection 2 (a) (u), substitute the figure '12c' for the figure 10c.

(c) In subsection (3), substitute the figure R12 for the figure R10.

PART III

4 SECTION 1—REGISTRATION

(a) In subsection (1) (a), insert the following after the expression 'the full names and addresses of the directors and secretary',

and, if the employer is a close corporation the full names and addresses of the members and secretary,

(b) In subsection (1) (b) insert the expression 'or close corporation after the word 'company' wherever it occurs.

Signed at Johannesburg for and on behalf of the parties this 21st day of April 1986

C J M PRINSLOO, Chairman
B NICHOLSON, Vice-Chairman
A O DE JAGER, General Secretary

No. R. 1744 **22 August 1986**

LABOUR RELATIONS ACT, 1956

IRON, STEEL, ENGINEERING AND METALLURGICAL INDUSTRY—RE-ENACTMENT OF MAIN AGREEMENT

I, Pieter Theuns Christiaan du Plessis, Minister of Manpower, hereby—

(a) in terms of section 48 (1) (a) of the Labour Relations Act, 1956, declare that the provisions of the Agreement which appears in the Schedule hereto and which

bet op die Onderneming, Nywerheid, Bedryf of Beroep in die opskrif by hierdie kennisgewing vermeld, met ingang van die eerste Maandag na die datum van publikasie van hierdie kennisgewing en vir die tydperk wat op 30 Junie 1987 eindig, bindend is vir die werkgewersorganisasies en die vakverenigings wat genoemde Ooreenkoms aangegaan het en vir die werkgewers en werknemers wat lede van genoemde organisasies of verenigings is, en

(b) kragtens artikel 48 (1) (b) van genoemde Wet, dat die bepalinge van genoemde Ooreenkoms, uitgesonderd die vervat in klousules 1 (1) (d), 2, 3 en 8 van Deel I, met ingang van die eerste Maandag na die datum van publikasie van hierdie kennisgewing en vir die tydperk wat op 30 Junie 1987 eindig, bindend is vir alle ander werkgewers en werknemers as die genoem in paragraaf (a) van hierdie kennisgewing wat betrokke is by of in diens is in genoemde Onderneming, Nywerheid, Bedryf of Beroep in die gebiede in klousule 1 van genoemde Ooreenkoms gespesifiseer

P T C DU PLESSIS,
 Minister van Mannekrag

BYLAE

NASIONALE NYWERHEIDSRaad VIR DIE YSTER-, STAAL-, INGENIEURS- EN METALLURGIESE NYWERHEID HOOFOOREENKOMS

konsekkonsting die Wet op Arbeidsverrhoudings, 1956, gesluit deur en aangegaan tussen die

- Association of electrical Cable Manufacturers of South Africa
- Automotive Parts Production Engineers' Association
- Border Engineering Industries' Association
- Bright Bar Association
- Cape Engineers' and Founders' Association
- Constructional Engineering Association
- Covered Conductor Manufacturers' Association
- Domestic Appliances Manufacturers' Association of South Africa
- Edge Hand and Small Tool Manufacturers' Association
- Electrical Engineering and Allied Industries Association
- Electronics and Telecommunications Industries Association
- Engineers' and Founders' Association (Transvaal, Orange Free State and Northern Cape)
- Fire Protection Industries Association of South Africa
- Forging Association of Southern Africa
- Gale and Fence Manufacturers' Association
- Heavy Engineering Manufacturers' Association
- Lift Engineering Association of South Africa
- Light Engineering Industries Association of South Africa
- Materials Handling Association
- Natal Engineering Industries Association
- Non-Ferrous Metal Industries Association of South Africa
- Plastics Manufacturers' Association of South Africa
- Port Elizabeth Engineers' Association
- Precision Manufacturing Engineers' Association
- Pressure Vessel Manufacturers' Association of South Africa
- Radio, Applience and Television Association of South Africa
- Sheetmetal Industries Association of South Africa
- S A Agricultural and Irrigation Machinery Manufacturers' Association
- S A Association of Shipbuilders and Repairers
- S A Electro-Plating Industries Association
- S A Fasteners Manufacturers' Association
- S A Foundry Association
- S A Industrial Refrigeration and Air-Conditioning Contractors' Association
- S A Machine Tool Manufacturers' Association
- S A Pump Manufacturers' Association
- S A Radio and Television Manufacturers' Association
- S A Reinforced Concrete Engineers' Association
- S A Tube Makers' Association
- S A Valve Manufacturers' Association
- S A Wire and Wire Rope Manufacturers' Association
- Amalgamated Engineering Union of South Africa

in accordance with the provisions of the Labour Relations Act 1956 made and entered into by and between the

Association of Electrical Cable Manufacturers of South Africa
 Automotive Parts Production Engineers' Association
 Border Engineering Industries Association
 Bright Bar Association
 Cape Engineers and Founders' Association
 Constructional Engineering Association
 Covered Conductor Manufacturers' Association
 Domestic Appliances Manufacturers' Association of South Africa
 Edge Hand and Small Tool Manufacturers' Association
 Electrical Engineering and Allied Industries Association
 Electronics and Telecommunications Industries Association
 Engineers' and Founders' Association (Transvaal, Orange Free State and Northern Cape)
 Fire Protection Industries Association of South Africa
 Forging Association of Southern Africa
 Gale and Fence Manufacturers' Association
 Heavy Engineering Manufacturers' Association
 Lift Engineering Association of South Africa
 Light Engineering Industries Association of South Africa
 Materials Handling Association
 Natal Engineering Industries Association
 Non-Ferrous Metal Industries Association of South Africa
 Plastics Manufacturers' Association of South Africa
 Port Elizabeth Engineers' Association
 Precision Manufacturing Engineers' Association
 Pressure Vessel Manufacturers' Association of South Africa
 Radio, Applience and Television Association of South Africa
 Sheetmetal Industries Association of South Africa
 S A Agricultural and Irrigation Machinery Manufacturers' Association
 S A Association of Shipbuilders and Repairers
 S A Electro-Plating Industries Association
 S A Fasteners Manufacturers' Association
 S A Foundry Association
 S A Industrial Refrigeration and Air-Conditioning Contractors' Association
 S A Machine Tool Manufacturers' Association
 S A Pump Manufacturers' Association
 S A Radio and Television Manufacturers' Association
 S A Reinforced Concrete Engineers' Association
 S A Tube Makers' Association
 S A Valve Manufacturers' Association
 S A Wire and Wire Rope Manufacturers' Association
 Amalgamated Engineering Union of South Africa

relates to the Undertaking, Industry, Trade or Occupation referred to in the heading to this notice, shall be binding, with effect from the first Monday after the date of publication of this notice and for the period ending 30 June 1987, upon the employers organisations and the trade unions which entered into the said Agreement and upon the employers and employees who are members of the said organisations or unions, and

(b) in terms of section 48 (1) (b) of the said Act, declare that the provisions of the said Agreement, excluding those contained in clauses 1 (1) (d), 2, 3 and 8 of Part I, shall be binding, with effect from the first Monday after the date of publication of this notice and for the period ending 30 June 1987 upon all employers and employees, other than those referred to in paragraph (a) of this notice, who are engaged or employed in the said Undertaking, Industry, Trade or Occupation in the areas specified in clause 1 of the said Agreement

P T C DU PLESSIS,
 Minister of Manpower

SCHEDULE

NATIONAL INDUSTRIAL COUNCIL FOR THE IRON, STEEL, ENGINEERING AND METALLURGICAL INDUSTRY MAIN AGREEMENT

- Association of Electrical Cable Manufacturers of South Africa
- Automotive Parts Production Engineers' Association
- Border Engineering Industries Association
- Bright Bar Association
- Cape Engineers and Founders' Association
- Constructional Engineering Association
- Covered Conductor Manufacturers' Association
- Domestic Appliances Manufacturers' Association of South Africa
- Edge Hand and Small Tool Manufacturers' Association
- Electrical Engineering and Allied Industries Association
- Electronics and Telecommunications Industries Association
- Engineers' and Founders' Association (Transvaal, Orange Free State and Northern Cape)
- Fire Protection Industries Association of South Africa
- Forging Association of Southern Africa
- Gale and Fence Manufacturers' Association
- Heavy Engineering Manufacturers' Association
- Lift Engineering Association of South Africa
- Light Engineering Industries Association of South Africa
- Materials Handling Association
- Natal Engineering Industries Association
- Non-Ferrous Metal Industries Association of South Africa
- Plastics Manufacturers' Association of South Africa
- Port Elizabeth Engineers' Association
- Precision Manufacturing Engineers' Association
- Pressure Vessel Manufacturers' Association of South Africa
- Radio, Applience and Television Association of South Africa
- Sheetmetal Industries Association of South Africa
- S A Agricultural and Irrigation Machinery Manufacturers' Association
- S A Association of Shipbuilders and Repairers
- S A Electro-Plating Industries Association
- S A Fasteners Manufacturers' Association
- S A Foundry Association
- S A Industrial Refrigeration and Air-Conditioning Contractors' Association
- S A Machine Tool Manufacturers' Association
- S A Pump Manufacturers' Association
- S A Radio and Television Manufacturers' Association
- S A Reinforced Concrete Engineers' Association
- S A Tube Makers' Association
- S A Valve Manufacturers' Association
- S A Wire and Wire Rope Manufacturers' Association
- Amalgamated Engineering Union of South Africa

(hereinafter referred to as the employers or the employers organisations"), of the one part, and the

- Amalgamated Society of Woodworkers of South Africa
 - Electrical and Allied Workers' Union of South Africa
 - Engineering Industrial Workers' Union of South Africa
 - Iron Moulders' Society of South Africa
 - Mynwerkersunie
 - Radio, Television, Electronics and Allied Workers' Union
 - S A Boilermakers', Iron and Steel Workers', Shipbuilders' and Welders' Society
 - S A Electrical Workers' Association
 - S A Engine Drivers', Firemen's and Operators' Association
 - S A Yster-, Staal- en Verwante Nywerheids-Unie
- (them) die verklarende of die vakverenigings gesoem aan die ander kant
- die partne is by die Nasionale Nvwerheidsraad vir die Yster- Staal Ingenieurs en Metallurgiese Nywerheid

DEEL I

1 TOEPASSINGSBESTEK VAN OOREENKOMIS

- Hierdie Ooreenkoms moet nagekom word—
- (a) In die Yster- Staal Ingenieurs en Metallurgiese Nywerheid oral in die Republiek van Suid-Afrika uitgesonderd die hawe en oerterre van Walvisbaai
 - (b) in die provinsies Transvaal en Natal deur die sektor van die Nywerheid by die installering van Nasionale Toestelbedryf
 - (c) in die landroosdistrikte Durban Oos-Londen Johannesburg Pieterburg Pinetown en Die Kaap deur die sektor van die Nywerheid by die vervaardiging van Radio's bedryf
 - (d) deur alle werkgewers en werknemers wat onderskeidelik lde van die werkgewers-ersorgsinstansies en die vakverenigings is
 - (2) Oordanks subklousule (1) is hierdie Ooreenkoms nie van toepassing nie op—
 - (a) die installering herstel en versiering van radio's en huishoudelike elektriese toestelle in die provinsies die Kaap die Goere Hoop en die Orange Vrystaat
 - (b) die vervaardiging vir verkoop van standaardreëlsgereedskap gemaak van selfdruisende deur middel van installasies en/of uitruiting en/of metodes wat spesiaal aangepas is vir produksie deur herhalingsprosesse in die landroosdistrikte Johannesburg Boksburg Vereniging en Pietermaritzburg
 - (c) die vervaardiging van aluminiumplaat en/of foelie en werkzaam hede wat in verband daarmee staan
 - (d) die installering en/of herstel en/of onderhoud van elektriese lysers en volbrange
 - (e) die produksie van yster en/of staal en/of versetlegrings
 - (f) die installering onderhoud en herstel van elektriese uitrusting soos bedoel in paragraaf (b) van die omskrywing van Elektriese Ingenieursnywerheid in klousule 3 van Deel I van hierdie Ooreenkoms in die provinsies die Kaap die Goere Hoop en die Orange Vrystaat
 - (g) die vervaardiging van wolframcarbied (hard metaal)
 - (h) die moniteer versiering installering onderhoud en/of herstel van toestelle uitrusting masjien toestelle en apparat of dit van handdoorgeskrewe meganiese elektriese elektrostatiese of elektroniese masjien toestelle en/of kombinasie van sodanige beginsels gebruik maak, wat in die eerste plek bedoel is vir gebruik in rekeninghouder- en/of sake en/of betrekkinge en/of kantoor en/of opvoedkundige prosedures
 - (i) die vervaardiging van Horntjeshinders en Verwante Produkte in die provinsie Transvaal
 - (j) die installering en/of herstel van dief- en/of ander soorgelyke alarmstelsels in die provinsies die Kaap die Goere Hoop die Orange-Vrystaat en Natal
 - (k) die vervaardiging van loodgaters- en/of ingenieursgevolpoperare deur middel van swaartelagvervoering en/of drukvoering en/of waaier- en/of masjien en/of masjien
 - (l) die ondernemings van die firma Union Steel Corporation of South Africa (Pty) Limited in die landroosdistrikte Vereniging Transvaal
 - (m) die Slomakerijbedryf in die landroosdistrikte Bona Boksburg, Die Kaap Durban Germiston Johannesburg Krugersdorp Lower Umfolozi Pinetown Port Elizabeth Pretoria Randburg Roodepoort en Springs
 - (n) die produksie vir verkoop van swaartelagtoestel deur middel van masjien en/of uitrusting en/of metodes wat spesifiek aangepas is vir produksie deur middel van herhalingsprosesse in die landroosdistrikte Brits Germiston Kempton Park en Pretoria.

PART I

1 SCOPE OF APPLICATION OF AGREEMENT

- The terms of this Agreement shall be observed—
- (a) in the Iron, Steel Engineering and Metallurgical Industry throughout the Republic of South Africa excluding the port and settlement of Walvis Bay
 - (b) in the Provinces of Transvaal and Natal by the sector of the Industry concerned with the installation repair and servicing of Radios, Refrigerators and Domestic Electrical Appliances
 - (c) in the magisterial districts of Durban East London Johannesburg Pieterburg Pinetown and The Cape by the sector of the Industry concerned with Radio Manufacturing.
 - (d) by all employers and employees being members of the employers organisations and trade unions respectively
 - (2) Notwithstanding the provisions of subsection (1) the terms of this Agreement shall not apply to—
 - (a) installation, repair and servicing of radios and domestic electrical appliances in the Provinces of the Cape of Good Hope and the Orange Free State
 - (b) the manufacture for sale of standard high speed cutting tools made from high speed steel by means of plant and/or equipment and/or methods specifically adapted and/or designed for production by repetitive processes in the Magisterial Districts of Johannesburg Boksburg Vereniging and Pietermaritzburg
 - (c) the manufacture of aluminium sheet and/or foil and inter-related operations
 - (d) the installation and/or repair and/or maintenance of electrical lifts and escalators
 - (e) the production of iron and/or steel and/or ferro-alloys
 - (f) the installation maintenance and repair of electrical equipment referred to in paragraph (b) of the definition Electrical Engineering Industry in section 3 of Part I of this Agreement in the Provinces of the Cape of Good Hope and the Orange Free State.
 - (g) the manufacture of tungsten carbide (hard metal).
 - (h) assembling servicing installation maintenance and/or repair of appliances equipment, machines, devices and apparatus whether utilising manual photographic mechanical, electrical, electrostatic or electronic principles, or any combination of such principles that are primarily intended for use in accounting and/or business and/or calculating and/or office and/or educational procedures
 - (i) the Venetian Blind and Allied Products Manufacturing Industry in the Province of the Transvaal.
 - (j) the installation and/or repair of burglar and/or other similar alarm systems in the Provinces of the Cape of Good Hope and the Orange Free State.
 - (k) the manufacture of plumbers and/or engineers brassware by means of gravity die-casting and/or pressure die-casting and/or hot pressing and/or machining
 - (l) the undertaking of Union Steel Corporation of South Africa (Pty) Limited, in the Magisterial District of Vereniging Transvaal.
 - (m) the Locksmithing trade in the Magisterial Districts of Bona Boksburg, Durban Germiston Johannesburg Krugersdorp Lower Umfolozi Pinetown Port Elizabeth, Pretoria, Randburg, Roodepoort, Springs and The Cape.
 - (n) the production for sale of welding electrodes by means of plant and/or equipment and/or methods specifically adapted and/or designed for production by repetitive processes, in the Magisterial Districts of Brits Germiston Kempton Park and Pretoria.

- (o) die ondernemings van Alusaf (Pty) Ltd in die landroosdistrikte Lower Umfolozi
- (p) (1) die vervaardiging deur middel van massaproduksiemetodes uit plaametaal met 'n dikte nie swaarder as 2 108 mm nie van—
 - (aa) kommersiële gewone of gelithografeerde houers vir die verpakking van algemene handelsware maar nie die verpakking van sodanige houers deur iemand vir die verpakking van sy eie produkte nie
 - (ab) deksels vir bottels, flesse en ander houers
 - (ac) gewone of gelithografeerde metaalpeelgoed
 - (ad) gewone of gelithografeerde verpakkingsmateriaal
- (ii) die vervaardiging van gewone of gelithografeerde en/of voubare buise uit nie-ysterhoudende metaalblokke Vir die toepassing van hierdie subparagraaf betrekken vaste buise en houers

Vir die toepassing van subparagraaf (i) en (ii) betrekken n houers n gewone of gelithografeerde artikel wat ontwerp is vir die verpakking van produkte wat vervoer of verkoop moet word en wat met 'n deksel of doppe of ander soort prop toegesluit kan word.

- (q) die vervaardiging uit plaat van hoogstens 0 416 mm van loffers en ander houers wat ontwerp is om persoonlike besittings sport-uitrusting gereedskap en dokumente te bevat en van ander ware wat hoofsaaklik uit sodanige plaat vervaardig is
- (3) Oordanks subklousule (1) is hierdie Ooreenkoms van toepassing op—
- (a) vakleerlinge slegs in die mate waarin die onbestaanbaar is nie met die Wet op Mannekeropleiding 1981 of met 'n kontrak daartrekkende aangesien of voorwaarde daartrekkende vasgestel en kwelklinge wat oopgelei word kragtens klousule 30 van die Wet op Mannekeropleiding 1981 slegs vir sover dit die onbestaanbaar is nie met die Wet op met voorwaarde daartrekkende vasgestel
- (4) Oordanks die beperking van die Ooreenkoms tot die werksaamhede daarin gelys is—
- (a) die bepaling van die Klousules aangaande Verlofbesoldiging, Addisionele Verlofbesoldiging en Verlofbonus in Deel I van hierdie Ooreenkoms van toepassing op alle werknemers wat operatiewe prosesse verrig en 'n loon ontvang wat gelyk of meer is as die wat in hierdie Ooreenkoms van tyd tot tyd voorgekryf word vir Loon D werknemers hetsy weekliks of maandeliks besoldig, ongesondheid betaling vir oortydwerk
- (b) geen persoon regstreeks werkzaam in 'n vervaardigings- of produksieproses sal 'n loon ontvang minder as die loon soos in Deel II van hierdie Ooreenkoms van tyd tot tyd voorgekryf vir 'n Loon I werknemer
- (c) die doeleindes van hierdie klousule sal werkzaam in 'n vervaardigings- of produksieproses van toepassing wees op werknemers wie se loonstelsel nie in hierdie Ooreenkoms gelys word maar wie se aktiwiteite direk verband staan aan die skepping van ingesourde of dienste soos in die toepassingsbestek van hierdie Ooreenkoms omskryf Die bepaling hiervan sal nie van toepassing wees op werk verrig deur administratiewe personeel en/of persone werkzaam op nie-produktiewe werksaamhede
- (5) Die diensvoortwaardes van 'n wag word ooreenkomsing die bepaling van hierdie Ooreenkoms gelyk behalwe ten opsigte van werksuur wat hoogstens 48 uur per week is

2 GELDIGHEIDSDUUR VAN OOREENKOMIS

Hierdie Ooreenkoms tree in werking op 'n datum wat die Minister van Mannekrag kragtens artikel 48 van die Wet op Arbeidsverhouding 1956 vassel en by van krag tot 30 Junie 1987 of vir die tydperk wat die Minister bepaal

3 SPESIALE BEPALINGS

Die bepalinge verval in klousule 8 (3) (e) 8bis 23 (soos gewysig by Klousule 8 hieronder) en 28 van Deel I van die Ooreenkoms gepubliseer by Goewernementskennisgewing R 1329 van 27 Junie 1980 soos gewysig en herbevestiging by Goewernementskennisgewings R 295 van 20 Februarie 1981, R 880 van 1 Mei 1981, R 1201 van 25 Junie 1982, R 45 van 14 Januarie 1983, R 1293 van 24 Junie 1983, R 1376 van 1 Julie 1983, R 2191 van 7 Oktober 1983, R 922 van 11 Mei 1984, R 1329 van 29 Junie 1984, R 2092 van 21 September 1984, R 222 van 8 Februarie 1985, R 1577 van 19 Julie 1985 en R 997 van 23 Mei 1986 (hierna na verwys as die Vorige Ooreenkoms) is van toepassing op werkgewers en werknemers

4 ALGEMENE BEPALINGS

Die bepalinge verval in klousule 3 (soos gewysig by Klousule 5 hieronder), 4, 5 (soos gewysig by Klousule 6 hieronder), 6 tot 8 (3) (d), 8 (3) (f) tot 8 (4), 9 tot 14 (soos gewysig by Klousule 7 hieronder), 14bis tot 22, 24 tot 27 en 29 tot 35 (soos gewysig by Klousule 9 hieronder) en 36 van Deel I, en Deel II (soos gewysig by Klousule 10 hieronder) van die Vorige Ooreenkoms en klousule 11 tot 13 hieronder is van toepassing op werkgewers en werknemers

- (o) die ondernemings van Alusaf (Pty) Ltd in die Magisterial District of Lower Umfolozi.
- (p) (1) die vervaardiging deur middel van massaproduksiemetodes uit plaametaal met 'n dikte nie swaarder as 2 108 mm of—
 - (aa) kommersiële gewone of gelithografeerde houers vir die verpakking van algemene handelsware maar nie die verpakking van sodanige houers deur iemand vir die verpakking van sy eie produkte nie
 - (ab) deksels vir bottels, flesse en ander houers
 - (ac) gewone of gelithografeerde metaalpeelgoed
 - (ad) gewone of gelithografeerde verpakkingsmateriaal
- (ii) die vervaardiging van gewone of gelithografeerde en/of voubare buise uit nie-ysterhoudende metaalblokke Vir die toepassing van hierdie subparagraaf betrekken vaste buise en houers

For the purposes of subparagraphs (i) and (ii) a container shall mean a plain or lithographed article designed for the packing for transport or sale of products and capable of being closed by means of a lid or cap or any other type of closure

- (q) the manufacture of plain or lithographed rigid and/or collapsible tubes from non ferrous metal sheets For the purposes of this subparagraph rigid tube shall mean a container
 - (3) Notwithstanding the provisions of subsection (1) the terms of this Agreement shall apply to—
 - (a) apprentices only to the extent to which they are not inconsistent with the provisions of the Manpower Training Act 1981 or any contract entered into or any conditions fixed thereunder and
 - (b) trainees under training in terms of section 30 of the Manpower Training Act 1981 only in so far as they are not inconsistent with the provisions of the Act or any conditions fixed thereunder
 - (4) Notwithstanding the limitation of the Agreement to the operations therein scheduled—
 - (a) the provisions of the sections relating to Leave Pay Additional Leave Pay and Leave Bonus of Part I of this Agreement shall apply to all employees employed in operative processes receiving a rate of pay equivalent to or more than that prescribed from time to time in this Agreement for Rate D employees whether paid weekly or monthly but excluding payment for overtime
 - (b) no person directly employed in a manufacturing or production process shall be paid a wage less than Rate I as prescribed from time to time in Part II of this Agreement
- For the purpose of this section employed in a manufacturing or production process shall apply to those employees whose rate of pay is not scheduled in this Agreement but whose activities are directly concerned with the creation of the engineering goods and/or services as covered by the scope of this Agreement This provision shall not apply to the work carried out by administrative personnel and/or those employees employed on non-production operations
- (5) The conditions of employment of watchmen shall be regulated by the provisions of this Agreement except in respect of working hours which shall be a maximum of 48 hours per week

2 PERIOD OF OPERATION OF AGREEMENT

This Agreement shall come into operation on such date as may be fixed by the Minister of Manpower in terms of section 48 of the Labour Relations Act 1956, and shall remain in force until 30 June 1987 or for such period as the Minister may determine

3 SPECIAL PROVISIONS

The provisions contained in sections 8 (3) (e) 8bis 23 (as amended by clause 8 hereunder) and 28 of Part I of the Agreement published under Government Notice R 1329 of 27 June 1980 as amended and re-enacted by Government Notices R 295 of 20 February 1981, R 880 of 1 May 1981, R 1201 of 25 June 1982, R 45 of 14 January 1983, R 1293 of 24 June 1983, R 1376 of 1 July 1983, R 2191 of 7 October 1983, R 922 of 11 May 1984, R 1329 of 29 June 1984, R 2092 of 21 September 1984, R 222 of 8 February 1985, R 1577 of 19 July 1985 and R 997 of 23 May 1986 (hereinafter referred to as the Former Agreement) shall apply to employers and employees

4 GENERAL PROVISIONS

The provisions contained in sections 3 (as amended by clause 5 hereunder), 4, 5 (as amended by clause 6 hereunder), 6 to 8 (3) (d), 8 (3) (f) to 8 (4), 9 to 14 (as amended by clause 7 hereunder), 14bis to 22, 24 to 27 and 29 to 35 (as amended by clause 9 hereunder) and 36 of Part I and Part II (as amended by clause 10 hereunder) of the Former Agreement and clauses 11 to 13 hereunder shall apply to employers and employees

5 KLOUSULE 3 — WOORDOMSKRYPING

Vervang die omskrywing van openbare vakansiedag deur die volgende:

** openbare vakansiedag enige van die openbare vakansiedae soos gespesifiseer in die Wet op Openbare Feesdae 1952 (Wet 5 van 1952).

6 KLOUSULE 5 — OORTYDWERK EN BESOLDIGING VIR WERK OP SONDAE

In subklausules (3) en (6) vervang die uitdrukking "een en twee derde die uurloon" deur die uitdrukking "dubbel die uurloon" waar dit oral voorkom.

7 KLOUSULE 14 — VERLOFBONUS

(1) Vervang die tabelle in subklausule (1) deur die volgende:

(i)	Loon	Eerste verlof-siklus	Tweede verlof-siklus	Derde verlof-siklus	Vierde of laater verlof-siklus
A en A1	R	544	612	748	816
AA Eerste 6 maande	463	527	591	658	684
DAarna	463	527	627	684	684
AB	463	527	591	658	658
B	463	527	591	658	658
C	463	527	591	658	658
D	461	526	589	655	655
DD	311	355	422	461	461
DDD	287	328	367	411	411
E	251	282	345	376	376
F	228	257	314	343	343
G	214	241	295	322	322
H en I	208	234	286	312	312

(ii)	Bylae F loon kategorie	Eerste verlof-siklus	Tweede verlof-siklus	Derde verlof-siklus	Vierde of laater verlof-siklus
Z	R	544	612	748	816
Y	463	527	591	658	658
YX	434	492	550	608	608
VIII	346	390	476	520	520
VII	329	370	452	493	493
VI	313	358	429	468	468
V	294	331	404	441	441
IV	287	327	380	414	414
III	259	292	357	389	389
II	243	274	335	365	365
I	227	256	313	341	341

5 SECTION 3 — DEFINITIONS

Substitute the following for the definition of public holiday —
public holiday means any of the public holidays specified in the Public Holidays Act 1952 (Act 5 of 1952).

6 SECTION 5 — OVERTIME AND PAYMENT FOR WORK ON SUNDAYS

In subsections (3) and (6) substitute the expression "double the hourly rate for the expression" one and two third times the hourly rate "where it occurs".

7 SECTION 14 — LEAVE BONUS

(1) Substitute the following for the tables in subsection.

(i)	A to J wage categories	First leave cycle	Second leave cycle	Third leave cycle	Fourth or more leave cycle
A and A1	R	544	612	748	816
AA First 6 months	463	527	591	658	658
Thereafter	463	527	627	684	684
AB	463	527	591	658	658
B	463	527	591	658	658
C	463	527	591	658	658
D	461	526	589	655	655
DD	311	355	422	461	461
DDD	287	328	367	411	411
E	251	282	345	376	376
F	228	257	314	343	343
G	214	241	295	322	322
H and I	208	234	286	312	312

(ii)	Schedule F wage categories	First leave cycle	Second leave cycle	Third leave cycle	Fourth or more leave cycle
Z	R	544	612	748	816
Y	463	527	591	658	658
YX	434	492	550	608	608
VIII	346	390	476	520	520
VII	329	370	452	493	493
VI	313	358	429	468	468
V	294	331	404	441	441
IV	287	327	380	414	414
III	259	292	357	389	389
II	243	274	335	365	365
I	227	256	313	341	341

(iii) Werknemers wat operatiewe prosesse verrig en n loon ontvang wat gelyk is aan die wat in hierdie Ooreenkoms voorgeskryf word vir Loon D-werknemers of wat besoldig word teen minstens R785 85 per maand uitgesonderd betaling vir oortydwerk.

Waar die werknemer se loonskaal 580 5 sent per uur nie oorskry nie	Waar die werknemer se loonskaal 581 sent per uur oorskry	Eerste verlof-siklus	Tweede verlof-siklus	Derde verlof-siklus	Vierde of laater verlof-siklus
R	R	463	527	591	658
463	612	680	748	816	816

(2) In subklausule (2) (a) vervang die bestaande tabel deur die volgende:

Eerste verlofsiklus	Tweede verlofsiklus	Derde verlofsiklus	Vierde verlofsiklus
R	212	257	374
212	257	374	476

(3) In subklausule (2) (b) vervang die bestaande tabel deur die volgende:

Tot en met 1 000 kg	Meer as 1 000 kg en tot en met 3 000 kg	Meer as 3 000 kg en tot en met 4 500 kg	Meer as 4 500 kg en tot en met 6 500 kg	Meer as 6 500 kg
R	234	263	322	531
234	263	322	364	531
242	273	333	364	531
289	325	398	434	434
289	325	398	434	434
361	361	429	468	468
362	362	436	476	476

8 KLOUSULE 23 — INDIENSMENING VAN VAKVERENIGING-ARBIED

In subklausule (5) an die woorde "Bylae F" voeg die volgende in: of op die vervaardiging van radio's in Afdeling D/32 van hierdie Ooreenkoms.

9 KLOUSULE 35 — WERKSEKURITEIT

Voeg die volgende voorrede in voor subklausule (1):
Vir die toepassing van hierdie klausule nie-teenssaande die omskrywing van werknemer in klausule 3 sluit werknemer persone in wat werk produksie of vervaardigings prosesse verrig wat nie in hierdie Ooreenkoms gelys is nie.

DEEL II

10 KLOUSULE 1 — LONE EN/OF VERDIENSTE

Vervang die bestaande subklausule (1) deur die volgende:
(1) (a) n Werknemer wat op die datum van inwerkingtreed van hierdie Ooreenkoms n hoer loon ontvang het as die wat in die Ooreenkoms voorgeskryf word vir die klas werk waarvoor hy in diens geneem is moet nog minstens as sodanige hoer loon ontvang terwyl hy by dieselfde werk geter in diens is en terwyl hy dieselfde werk of ander werk waarvoor n hier loon voorgeskryf word verrig.
(b) n Werknemer wat op die datum van inwerkingtreed van hierdie Ooreenkoms by n werkgewer in diens is vir die verrigting van werk wat in die Ooreenkoms ingedeel is moet terwyl hy in diens van dieselfde werkgewer is en algeen daarvan of sy werklike loon onmiddellik voor gesnoerd datum hoer was as die loon wat vir sy klas werk in hierdie Ooreenkoms gespesifiseer is minstens die werklike loon betaal word wat by

(iii) Employees employed in operative processes receiving a rate of pay equivalent to that prescribed in this Agreement of Rate Demands or paid at a rate of not less than R785 85 per month excluding payment for overtime.

Where the employee's wage rate does not exceed 580 5 c p h	Where the employee's wage rate exceeds 581 c p h	First leave cycle	Second leave cycle	Third leave cycle	Fourth or more leave cycle
R	R	463	527	591	658
463	612	680	748	816	816

(2) Substitute the following for the existing table in subsection (2) (a):

First leave cycle	Second leave cycle	Third leave cycle	Fourth leave cycle
R	212	257	374
212	257	374	476

(3) Substitute the following for the existing table in subsection (2) (b):

Upto 1 000 kg	Over 1 000 kg and up to 3 000 kg	Over 3 000 kg and up to 4 500 kg	Over 4 500 kg and up to 6 500 kg	Over 6 500 kg
R	234	263	322	531
234	263	322	351	531
242	273	333	364	531
289	325	398	434	434
289	325	398	434	434
361	361	429	468	468
362	362	436	476	476

8 SECTION 23 — EMPLOYMENT OF TRADE UNION LABOUR

Insert the following in subsection (1) after the words "Schedule F":
or to the manufacture of radios in Division D/32 of this Agreement.

9 SECTION 35 — SECURITY OF EMPLOYMENT

Insert the following preamble before subsection (1):
For the purposes of this section notwithstanding the definition of employee in section 3 employee shall include persons employed in operative, production or manufacturing processes not scheduled in this Agreement.

PART II

10 SECTION 1 — WAGES AND/OR EARNINGS

Substitute the following for subsection (1):
(1) (a) Any employee who at the date of coming into operation of this Agreement was in receipt of a higher rate than that prescribed in the Agreement for the class of work upon which he is employed shall continue to receive not less than such higher rate while he is employed by the same employer on the same work or any other work for which a lower rate is prescribed.
(b) Every employer who on the date of coming into operation of this Agreement is employed by an employer on work classified in the Agreement shall, whilst in the employ of the same employer and whether or not his actual rate of pay immediately prior to the said date was in excess of the rate specified for his class of work in this Agreement be paid not

onmiddellik voor genoemde datum ontvang het, plus, as a guaranteed personal minimum verhoging die volgende addisionele bedrag vir sy persoonlike minimum verhoging die volgende addisionele bedrag vir sy klas werk.

Klas werk	Bedrag per uur
Loon A en A1	60
Loon AA.	
Werknemers in hul eerste ses maande ononderbroke diens op bosepoende datum	45
Daarna	48
Loon AB	46
Loon B	45
Loon C	44
Loon D	43
Loon DD	40
Loon DDD	37
Loon E	35
Loon F	34
Loon G	34
Loon H en I	32
Voertuie dryf	
Binnevervoer (d w s wat nie op openbare paase gedryf word)	
(a) Voertuie wat indien hulle op openbare paase gedryf word n rybewys vir n ligte motorvoertuig sal vereis	34
(b) Voertuie wat indien hulle op openbare paase gedryf word n rybewys vir n swaar motorvoertuig sal vereis	35
(c) Voertuie wat indien hulle op openbare paase gedryf word n rybewys vir n eksras swaar motorvoertuig sal vereis	38
Bruto massa van voertuig oort 13 600 kg	
Bruto massa van voertuig tot en met 3 000 kg	34
Meer as 3 000 kg tot en met 4 500 kg	35
Meer as 4 500 kg tot en met 6 500 kg	38
Meer as 6 500 kg	41

BYLAEF

Enige ander voertuig dryf wat gelyksaam is om n loonvang tot en met die volgende priske te verveer

Tot 1 000 kg 34
 Meer as 1 000 kg tot en met 3 000 kg 35
 Meer as 3 000 kg tot en met 4 500 kg 38
 Meer as 4 500 kg tot en met 6 500 kg 40
 Meer as 6 500 kg 41

Meer dien versande dat—

(i) die addisionele bedrag aangevulde hierdie subklousule betaalbaar aan n werknemer vir sy klas werk vermeerder kan word met die bedrag van n verhoging wat op of na 1 Julie 1986 aan sodanige werknemer toegestaan is.

(ii) n werknemer wat na 1 Julie 1986 in diens geneem is teen n tarief van besoldiging van munisipal diens wat vir sy klas werk voorskryf is op die datum van inwerkingsreding van hierdie Ooreenkoms nie geregtig is op die ontvangs van die addisionele bedrag wat in hierdie subklousule vir sy klas werk gespesifiseer is nie

(iii) geen werkgewer die tarief van besoldiging van n werknemer aan wie n verhoging op of na 1 Julie 1986 toegestaan is wat hoer is as die addisionele bedrag in hierdie subklousule vir sy klas werk gespesifiseer mag vermeerder nie en aan geen werknemer lone teen n tarief laer as die tarief vir sy klas werk in hierdie Ooreenkoms gespesifiseer betaal mag word nie

(iv) vir die uitvoering van hierdie Ooreenkoms is die loon wat uitgevolg hierdie subklousule van toepassing is *mutatis mutandis* van toepassing op werknemers wat aansporingsbonuswerk ooreenkomstig klousule 10 van Deel I van die Voorge Ooreenkoms vertig

(v) n werkgewer van voornemens om algemene verhogings aan alle werknemers of alle werknemers in n spesifieke kategorie werknemers toe te staan hoer as die gewaarborgde persoonlike minimum verhogings voorsien in hierdie Ooreenkoms, sal met die vakverenigings voorsien van die spesifieke betrokke werknemers lede is konsulteer

Waar n werkgewer na sodanige konsultasie verhogings toestaan hoer dan die voorsien in die Ooreenkoms sal die Nywerheidsraad van sodanige verhogings verwittig word

less than the actual rate he was receiving immediately prior to the said date plus, as a guaranteed personal minimum increase an additional amount for his class of work as follows

Class of work	Amount per hour
Rate A and A1	60
Rate AA.	
Employees in their first six months on continuous service on the above date	45
Thereafter	48
Rate AB	46
Rate B	45
Rate C	44
Rate D	43
Rate DD	40
Rate DDD	37
Rate E	35
Rate F	34
Rate G	34
Rate H and I	32
Vehicle driving	
Internal transport i.e. not driven on public roads	
(a) Vehicles which would, if driven on public roads require a light motor vehicle driving licence	34
(b) Vehicles which would if driven on public roads require a heavy vehicle driving licence	35
(c) Vehicles which would if driven on public roads require an extra heavy motor vehicle driving licence	38
External transport	
Driving of any other vehicle authorised to carry a pay-load	34
Up to including 1 000 kg	35
Over 1 000 kg and up to 3 000 kg	38
Over 3 000 kg and up to 4 500 kg	40
Over 4 500 kg and up to 6 500 kg	41

SCHEDULE F

Group 2 60
 Group 1 45
 Group IX 45
 Group VIII 44
 Group VII 43
 Group VI 41
 Group V 39
 Group IV 37
 Group III 36
 Group II 34
 Group I 34

Provided that—

(i) the additional amount payable in terms of this subsection to an employee for his class of work may be reduced by the amount of any increase or increases granted to such employee on or subsequent to 1 July 1986

(ii) any employee who was engaged after 1 July 1986 at a rate of pay not less than the rate of pay prescribed for his class of work as at the date of coming into operation of this Agreement shall not be entitled to be paid the additional amount specified in this subsection for his class of work.

(iii) no employer shall reduce the rate of pay of any employee to whom an increase in excess of the additional amount specified in this subsection for his class of work has been awarded on or subsequent to 1 July 1986 and no employer shall be paid wages at a rate less than the rate for his class of work specified in this Agreement.

(iv) for the purposes of this Agreement the rate applicable in terms of this subsection shall *mutatis mutandis* apply to employees employed on Incentive Bonus Work in terms of section 10 of Part I of the Former Agreement

(v) an employer who intends to grant general increases to all employees or all employees in a particular category of employees in excess of the guaranteed personal minimum increases provided for in this Agreement shall consult the trade unions of which the particular employees concerned are members

Where an employer following such consultation grants such increases over and above that provided for in this Agreement, the Industrial Council shall be notified of the increases granted

(2) BYLAEF G

Vervang die volgende Bylaef G

(a) In item 155—die syfers 317 en '339' deur onderskeidelik die syfers 359 en '382

(b) In item 165—die syfers 210, 224 en 256 deur onderskeidelik die syfers 244, 259 en 294

(c) In item 166—die syfers 216, 224, 271, 293 en 298 deur onderskeidelik die syfers 250, 259, 309, '333' en 339

(d) In item 191 (a)—die syfers 378 en '383' deur onderskeidelik die syfers 423 en 428

(e) In item 191 (b)—die syfers 320 en '360' deur onderskeidelik die syfers 362 en 403

(3) BYLAEF D

(a) In Afdeling D/4 vervang die syfers 205, 261, 312 en '331' deur onderskeidelik die syfers 238, '299', 354 en 375 in item 1

(b) In Afdeling D/12 onder die opskrif 'Proefrydperke en lone daarvoor' vervang die syfer 305 deur die syfer 346 waar dit voorkom

(c) In Afdeling D/19—

(i) in item 32 vervang die syfers '439' en 466 deur onderskeidelik die syfers 487 en 518

(ii) in items 34 en 35 vervang die syfer 194 deur die syfer 227

(d) In Afdeling D/22—

(i) in items 71 en 101 tot en met 105 vervang die syfer '328' deur die syfer 370

(ii) in items 106 tot en met 198, vervang die syfer 250 deur die syfer 287

(iii) in items 109 tot en met 121 vervang die syfer 198 deur die syfer 231

(iv) in items 122 tot en met 133, vervang die syfer 191 deur die syfer 223

(e) In Afdeling D/23 onder die opskrif 'Proefrydperke en lone daarvoor' vervang die syfers 205 en 188 deur onderskeidelik die syfers 238 en 220

(f) In Afdeling D/24 vervang die syfer 334 deur die syfer 376 in item 5

(g) In Afdeling E/2 vervang die syfers 384, 402, 415 en 429 deur die syfers 472 en 487 in item 21

(h) In Bylaef F—

(i) in Groep Z vervang die syfer 5 21 deur die syfer 5 81

(ii) in Groep Y vervang die syfer 3 80 deur die syfer 4 25

(iii) in Groep IX vervang die syfer 3 43 deur die syfer 3 89

(iv) in Groep VI vervang die syfer 2 90 deur die syfer 3 33

(v) in Groep V vervang die syfer 2 73 deur die syfer 3 14

(vi) in Groep IV vervang die syfer 2 56 deur die syfer 2 95

(vii) in Groep III vervang die syfer 2 40 deur die syfer 2 77

(viii) in Groep II vervang die syfer 2 24 deur die syfer 2 60

(ix) in Groep I vervang die syfer 2 09 deur die syfer 2 43

(2) SCHEDULE G

In Schedule G substitute the following:

(a) In Job 155—the figures 359 and 382 for the figures '317' and 339 respectively

(b) In Job 165—the figures 244, 259 and 294 for the figures 210, 224 and 256 respectively

(c) In Job 166—the figures '250', 259, 309, 333' and '339' for the figures 216, 224, '271', 293 and 298 respectively

(d) In Job 191 (a)—the figures 423 and 428 for the figures 378 and 383 respectively

(e) In Job 191 (b)—the figures 362 and 403 for the figures 320 and 360 respectively

(3) SCHEDULE D

(a) In Division D/4 substitute the figures 238, 299, 354 and 375 for the figures 205, 261, 312 and 331 respectively in Job 1

(b) In Division D/12 substitute the figure '346' for the figure 305 where it appears under the heading 'Probationary periods and rates of pay' therefor

(c) In Division D/19—

(i) in Job 32 substitute the figures '487' and 518 for the figures 439 and '466' respectively

(ii) in Jobs 34 and 35 substitute the figure 227 for the figure 194

(d) In Division D/22—

(i) in Jobs 71 and 101 to 105 inclusive, substitute the figure 370 for the figure '328'

(ii) in Jobs 106 to 108 inclusive substitute the figure 287 for the figure 250

(iii) in Jobs 109 to 121 inclusive substitute the figure 231 for the figure 198

(iv) in Jobs 122 to 133 inclusive, substitute the figure '223' for the figure 191

(e) In Division D/23 substitute the figures 238 and '220' for the figures 205 and 188 respectively under the heading 'Probationary periods and rates of pay' therefor

(f) In Division D/24 substitute the figure 376 for the figure '334' in Job 5

(g) In Division E/2 substitute the figures 429, 447, 460, 472 and 487 for the figures 384, 402, 415 and 439 respectively in Job 21

(h) In Schedule F—

(i) in Groep Z substitute the figure 5 81 for the figure 5 21

(ii) in Groep Y substitute the figure 4 25 for the figure 3 80

(iii) in Groep IX substitute the figure 3 89 for the figure 3 43

(iv) in Groep VI substitute the figure '3 33' for the figure 2 90

(v) in Groep V substitute the figure '3 14' for the figure 2 73

(vi) in Groep IV substitute the figure '2 95' for the figure 2 56

(vii) in Groep III substitute the figure '2 77' for the figure 2 40

(viii) in Groep II substitute the figure '2 60' for the figure 2 24

(ix) in Groep I substitute the figure 2 43 for the figure 2 09

Group	Rate per hour	Group	Rate per hour
Groep VIII	3 70	Group VIII	3 70
Groep VII	3 51	Group VII	3 51

11 BYLAE G

(1) In Bylae G, Loon A (n e v) verang die bestaande werksambede tot 51 deur die volgende werksambede 1 tot 61

- 1 Hoeksvaer en plaasruudswerk
- 2 Bou en/of sieraalwark
- 3 Akerwieling
- 4 Motorvoertuigmassjinerie en paswerk
- 5 Grootmasjinerie
- 6 Messerwerk en/of messel met vuurvasse stene en/of klipmesselwerk
- 7 Timmerwerk en/of skryfwerk (uitgesondend die beredding van verpakkingsmateriaal en nwe krakerwerk)
- 8 Staalkonstruksie ketelmakerswerk
- 9 Staalkonstruksie-pypasserswerk
- 10 Bousaaiwerk
- 11 Kopermasjinerie
- 12 Stempels en/of setmate en/of gereedskap en/of meiers maak en/of herstel
- 13 Stempels en/of setmate en/of graafwerk
- 14 Dieselmotortuig
- 15 Werk van n verbruikskundige vir huishoudelike toestelle
- 16 Elektroniese werk
- 17 Elektriese onderhouidswerk en/of installering en/of herstelwerk
- 18 Elektriese se werk
- 19 Elektropianering
- 20 Oprigting en/of montering (loesigwerk op per seel)
- 21 Elektronika-meganikus se werk
- 22 Pas en draaiwerk
- 23 Paswerk (met inbegrip van masjinerie)
- 24 Inspeksie van vliegtuie en/of getuie word deur inspektors met vakmanskap-voegdelid
- 25 Inspeksie van vliegtuie en/of herstel
- 26 Instrumensmeganikus se werk (industriële instrumensmeganikus se werk (prosesseer))
- 27 Hysers en/of roltrapwarkkundige se werk
- 28 Sloot maak
- 29 Masjinerie-reparasie en/of gereedskap
- 30 Uitrwerk en/of afneem
- 31 Masjinerie-ontwerp (elektro-meganikus)
- 32 Motorvoertuie herstel
- 33 Gere om- en/of kermakery
- 34 Bediening van boeg en/of gasse masjinerie aan die draaihoek
- 35 Modelmakery
- 36 Plaatwerk en/of ketelmakery
- 37 Loofdeleerswark
- 38 Werk van n diensman vir radiokommunikasies
- 39 Radioherstellerswerk
- 40 Radio- en televisiemeganikus se werk
- 41 Radiotruie se werk
- 42 Verkoelingswarkkundige (kommersieel en industriële)
- 43 Touwerk en/of splislaswerk
- 44 Drukhoekers klank en/of kalfater
- 45 Walsreedskap- en patroonmakery
- 46 Walswark
- 47 Skale maak en/of herstel
- 48 Plaasruudwark
- 49 Sakebouwerk en bootbou
- 50 Bunt- Binneloodwarkkundige
- 51 *Skroefloofdeleerswerk
- * Skroefloofdeleerswerk beteken werk op skepe vir alle santele doeleendes en/of water-voorsiening en/of huishoudelike verwarmling- was- of drinkdoeleendes
- 52 Letterkundewerk
- 53 Telekommunikasie elektriese se werk
- 54 Telefoonskommunikasie-elektriese se werk
- 55 Patroon maak
- 56 Drukhoekers toets
- 57 Draaiwerk (met inbegrip van masjinerie)
- 58 Uniersel- freeswerk en/of uniersel slypwerk en/of uniersel masjinerie
- 59 Voertuiepakhou en/of -herstellerswerk, saamgestel en/of metaal
- 60 Sweis en/of sweissoldeer
- 61 Houmasjinerie en/of houtwerk (uitgesondend die beredding van verpakkingsmateriaal en nwe krakerwerk)

(2) In Bylae G, Sekse (a)—Algemeen, skrap subloosule (x) Indiensname van persone onder die leeftyd van 21 jaar op werk ingedeel onder Looe E tot en Met 1

11 SCHEDULE G

(1) In Schedule G, Rate A (n e s) substitute the following operations 1 to 61 for the existing operations 1 to 51

- 1 Angle and plate sturlung
- 2 Architectural and/or ornamental metal work
- 3 Armature winding
- 4 Automobile machine and fitting
- 5 Blacksmithing
- 6 Bricklaying and/or refractory bricklaying and/or masonry work
- 7 Carpenter and/or joinery (excluding the preparation of packaging and rough crating)
- 8 Constructional boilermaking
- 9 Constructional pipe fitting
- 10 Constructional steelworking
- 11 Copperstudding
- 12 Die and/or jig and/or tool and/or gauge making and/or repairing
- 13 Die-sinking and/or engraving
- 14 Diesel fitting
- 15 Domestic Appliance Mechanic's work
- 16 Electrical fitting
- 17 Electrical maintenance work and/or installation and/or repair work
- 18 Electrician's work
- 19 Electropainting
- 20 Erecting and/or assembling (supervisory work on site)
- 21 Electronics mechanic's work
- 22 Fitting and turning
- 23 Fitting (including machining)
- 24 Inspecting when performed by inspectors having journeyman qualifications
- 25 Instrument making and/or repairing
- 26 Instruments mechanic's work (industrial instrumentation and process control)
- 27 Lift and/or escalator mechanic's work
- 28 Locksmithing
- 29 Machine tool setting up and/or toolsetting
- 30 Marking out and/or marking off
- 31 Millwrighting (electro-mechanical)
- 32 Motor vehicle repairing
- 33 Moulding and/or coremaking
- 34 Operating air and/or gas welding machines on pressure vessels
- 35 Patternmaking
- 36 Plating and/or boilermaking
- 37 Plumbing
- 38 Radio communications serviceman's work
- 39 Radio repairer's work
- 40 Radio and television mechanic's work
- 41 Radiotronian's work
- 42 Refrigeration mechanic (commercial and industrial)
- 43 Rigging and/or splicing
- 44 Riveting and/or caulking pressure vessels
- 45 Roll tool and temper making
- 46 Roll turning
- 47 Scale making and/or repairing
- 48 Sheetmetal working
- 49 Shipwrighting and boatbuilding
- 50 Outboard/Inboard Engine Mechanic
- 51 *Ship's plumbing means work on ships for all sanitary purposes and/or water services and/or domestic heating washing or drinking purposes
- 52 Signwriting
- 53 Telecommunications electrician's work
- 54 Telephone communications electrician's work
- 55 Templet making
- 56 Testing (pressure vessels)
- 57 Turning (including machining)
- 58 Universal milling and/or universal grinding and/or universal machining
- 59 Vehicle body building and/or repairing composite and/or metal
- 60 Welding and/or brazing
- 61 Woodmachining and/or woodworking (excluding the preparation of packaging and rough crating)

(2) In Schedule G, Section (a)—General, delete subsection (x) Employment of persons under 21 years of age on work classified at Rates E to I inclusive

(3) In Bylae G, Sekse (a)—Algemeen, bemoemmer die bestaande subloosules (x) tot (xvi) as subloosules (ix) tot (xv)

(4) In Bylae G, voeg die volgende in as Sekse (i), na Sekse (h)

- 1 Werk van n werktuigkundige vir huishoudelike toestelle
- 2 Werk van n diensman vir radiokommunikasies
- 3 Radioherstellerswerk
- 4 Werk van n koekkasw-erktuigkundige (kommersieel en industriële)
- 5 Werk van n werktuigassistent
- 6 Installering van antennes op gebouke se persele
- 7 Insulering van tydelike openbare ontmoetselsels maar uitgesondend finale toetsing, onder toetsing van n Tarief A-werknemer
- 8 Werktuigkundige en elektromeganiese installering van radio's en soortgelyke uitrusing uitgesondend finale toetsing
- 9 Herstel en/of vervanging van verwarmings-elemene aan toestelle
- 10 Herstel en/of vervanging van keramiek- of ander isoleringsmateriaal en/of -vormers wat gebruik word vir verwarmlings-elemene insluitende die vassil daarvan
- 11 Herstel en/of hermontering van verwarmings-elemenehoekers
- 12 Vervanging en/of vervanging van motore van hoogsistens 750 wat op las van n Tarief A werknemer uitgesondend die finale toetsing
- 13 Urnrekaarhaal en skoonmaak van toestelle onder toetsing van n Tarief A- of Tarief AA-werknemer
- 14 Vervanging uit en/of aanbring in kabinete van gemonteerde gramradio en/of radionomteeprtaal

(3) In Schedule G, Section (a)—General, re-number the existing subsections (x) to (xvi) as subsections (ix) to (xv)

(4) In Schedule G, insert the following as Section (i) after Section (h)

- 1 Domestic appliance mechanic's work
- 2 Radio communications serviceman's work
- 3 Radio repairer's work
- 4 Refrigerator mechanic's work (Commercial and Industrial)
- 5 Workshop assistant's work
- 6 Installation of aerial on user's premises—first six months of experience thereafter
- 7 Installation of temporary public address systems but excluding final testing, under supervision of a Rate A employee
- 8 Mechanical and electrical installation of radios and similar equipment excluding final testing
- 9 Repair and/or replacement of heating elements on appliances
- 10 Repair and/or replacement of ceramic or other insulating spacers and/or formers used for heating elements including fixing
- 11 Repair and/or re-assembly of heating element containers
- 12 Removing and/or replacing of motors not exceeding 750 watts at the direction of a Rate A employee, excluding final testing
- 13 Stripping and cleaning of appliances under supervision of a Rate A or AA employee
- 14 Removal from and/or fitting into cabinets of assembled radiogram and/or radio chassis

5/1/85 132

Management talks on black influences

A group of leading political, labour and other experts will meet in Sandton next week to discuss the growing impact of forces within the black community on the workplace

Among those who will address an Institute of Personnel Management (IPM) conference on August 27 are Dr Tom Lodge, a senior politics lecturer at the University of the Witwatersrand, Mrs Sheena Duncan, past-president of the Black Sash, and Mr Tony Gilson, chairman of the Port Elizabeth Chamber of Commerce, who has considerable experience in how outside forces impinge on business

Speakers from the private sector will focus attention on how to manage the workplace of the future.

SABOTAGE AND INTIMIDATION

Mr Andre Lamprecht, group industrial relations manager of Barlow Rand, will examine sit-ins and how these can be managed, and Mr Bruce Evans, chief executive of Gencor's Gold and Uranium Division, will discuss sabotage and intimidation.

"Our aim is to expose the people who will have to manage labour relations in the workplace to ideas of our time and the future," said Mr Graham Shaw, chairman of the industrial relations committee of the Johannesburg branch of the IPM

Further information about the conference can be obtained from Miss Lesley Tanner at 482-1930 or Miss Dianne Kassel at 833-7676

Pace of reform to blame

No end seen to labour unrest

(Handwritten scribble)

132

LINDA ENSOR

STAYAWAYS and political strikes could continue to be a feature of the industrial relations scene, a Johannesburg seminar on industrial relations was told yesterday.

Jon Lewis, managing editor of the *SA Labour Bulletin*, said this was because of the slow pace of political reform.

Managers, he added, would have to be more flexible in coming to terms with a radicalised workforce. Dismissals were unreasonable and ineffective and there was room for negotiation on matters like public holidays and compensation for days lost.

Bruce Evans, CE of Gencor's gold and uranium division, voiced concern "that political forces may overflow into, and prevent moves towards more constructive pragmatic and mature management-labour relations".

He expected intimidation on the mines to continue diminishing, but he was far less hopeful about intimidation in the political arena.

A centralised union influence with an overt message to workers to desist from violence had frequently had a salutary effect, he said.

NO HEADS IN THE SAND

Oudtshoorn, already the international ostrich feather capital, is to build the biggest ostrich abattoir in the world to cater for the growing demand for ostrich meat.

Commissioned by the Klein Karoo Landboukorporasie, it will be able to process an average of 700 birds a day. Capital cost is said to be in the order of R9m.

Dave Marais, MD of Grinaker Projects (GP), says design is well under way and construction should start early in 1987. GP, he adds, negotiated the contract on a design-and-construct offer, but the building contract will be put out to tender. "If we award the tender to any Grinaker company," promises Marais, "it will have been won in open competition."

Lack of technology was a major problem. There are no ostrich abattoirs in the world, apart from the small one in Oudtshoorn which is also probably the only town in the world where ostriches are slaughtered on a commercial basis. And the Oudtshoorn example which the new one will replace is hardly hi-tech.

The need for the new facility, Marais explains, came from a growing demand for ostrich meat at home and abroad which the existing facility could not fully service.

"Ostriches are well known for feathers and leather, but their meat is becoming increasingly important," says Marais.

"Being red meat and coming from poultry, which is what ostriches are, it offers red meat lovers the best of both worlds, in that it has the flavour of red meat, but very little cellular fat. Health food people prize it all over the world."

neurial advice. Second where Retco does its own thing on adventurous developments. And third, a far more conservative, asset management operation intended to serve essentially as a pension fund to provide a backup for the higher-risk activities.

Two key projects are under consideration for the first option.

One is a proposed resort development on the shores of the Langebaan lagoon just south of the Panorama hotel. Rabinowitz says Retco has an option, with a partner, on 250 ha which could be subdivided into about 1 500 plots, now in the course of proclamation.

Eventually he foresees Langebaan becoming hotter property than Hermanus, reasoning that for the young at least it is definitely more user-friendly.

Another project is still in the formative stages, but Rabinowitz maintains it involves a stake in the biggest land assembly ever undertaken in the Transvaal, only seven minutes from Johannesburg City Hall.

Just in case neither proves fulfilling enough, or they don't come off, he is also

looking at prospects in black areas of the Cape peninsula and up-country.

Yet another possibility would be the utilisation of Retco's substantial unissued capital to acquire further assets which, together with the group's Poyntons Building in Pretoria and Salmon Grove in Durban, could be used to form the basis of a new property trust.

FINANCIAL MAIL

INDUSTRIAL AGREEMENTS

End of the line?

The Bloemfontein Master Builders Association (MBA) has got the best of three falls in a tussle with the all-white Building Workers' Union (BWU) over the employers' withdrawal from the industrial council agreement (*Property* June 27).

With the MBA's position now vindicated, pressure is mounting for changes to the agreements in other areas. The *FM* understands there is similar dissatisfaction in Maritzburg and northern Natal — although it seems the parties favour negotiated changes rather than drastic Bloemfontein-style walkout action.

Industrial council agreements in the building industry have long been a source of contention. Employers claim the closed shop arrangements operated by some unions and minimum wage structures do not serve the interests of the industry — in particular, black artisans who are excluded.

Matters came to a head in April this year when the Bloemfontein MBA summarily withdrew from the agreement, claiming it was outdated.

Incensed, the BWU applied to the Supreme Court for an interdict to force the MBA back in. But the court found that the Labour Relations Act conferred on the MBA the right to withdraw and dismissed the union's application with costs.

Next the BWU appealed to the Industrial Court on the grounds that the MBA's action constituted an unfair labour practice. Again the court ruled that the MBA had not acted unfairly by pulling out of the agreement.

It did, however, find that its refusal to attend industrial council meetings was unfair and it appealed to the MBA to reconsider its position — though it issued no binding order.

MBA director Barney Bester says the Department of Manpower has agreed that no new agreement will come into being after February next year. The Basic Conditions of Employment Act will govern employment in the industry and market forces will determine wage rates. Meanwhile the department will stand ready to act in cases of exploitation and employers will lay down basic minimum wages merely as a guide.

Commenting on the outcome, Bester says it is clear unions will in future have to adopt a softer line. "It's no good them adhering to principles that are completely outdated if they are not prepared to adapt, more agree-



Bloem revolution ... starting to spread

ments will fold."

Long term, however, he says employees will find the new arrangement fairer all round. The labour force, he adds, is the industry's most productive resource and employers would not willingly do anything to jeopardise the existing relationship.

GUIDELINES

Old Mutual Properties (OMP) has bought the 10-year-old Nedbank Gardens building in Rosebank from Bath Avenue Properties, a Nedbank subsidiary, for R13m. This boosts OMP's investment in Rosebank to R70m.

The building, on a 1,39 ha site, between Bath and Sturdee avenues, has a total rentable area of 10 726 m² — a ground floor banking hall and eight floors of offices. There are also 441 parking bays on the site, 240 of which are under cover.

Mike Raggett, OMP's property investment manager, says yield will be 11% if the entire building is let at R8,77/m² net.

OMP has also leased 4 230 m² to Calvert Removals in its 4th Street, Wynberg, complex for five years at R4/m² net, escalating at 10%/year.

Diners Club has renewed its lease in Sanlam Properties' (SP) Sanlam Centre, Johannesburg, for five years. It has also taken an extra quarter-floor of 543 m² and now occupies 2 493 m², for which it will pay R2,8m over the period of the lease.

SP has also let a 670 m² factory in Roodepoort's Robertville to RSK Industrial for 2½ years, for a total of R87 600. The going rate in the complex is R3,50/m²-R4/m².

In another deal worth a total of R33 000 it has let a 265 m² factory to Aura CE in its Wadeville Industrial Park for three years. The going rate for space in that complex is R3/m².

Landmark has let 300 m² of office space in Palm Grove, the Toich Group development in Randburg, to Unicorn Lines at R9/m² net for three years escalating at 9% a year.

this regard, (b) how have officials determined the names of the original residents and (c) where are these persons residing at present,

(3) whether any restrictions will be placed on the construction of new dwellings in these areas, if so, (a) what restrictions, (b) why and (c) how will they be enforced,

(4) whether the barbed-wire surrounding these sites has been removed, if not, (a) why not and (b) when will it be removed, if so, when?

†THE DEPUTY MINISTER OF CONSTITUTIONAL DEVELOPMENT AND PLANNING

(1) No

(a) Until peace is restored between the factions, more faction fighting could erupt at any moment and the Government cannot guarantee their safety under these conditions

(b) Services are being and will be provided on the vacated land as part of upgrading

(c) A final decision has not yet been taken but it is anticipated that any of the residents will be allowed on a priority basis

(d) Falls away

(1) As soon as the upgrading action has been completed

(ii) None, as this is a function of the Provincial Administration

(2) Yes

(a) Fighting groups have been identified and during the course of discussions held between officials of the Department of Community Services of the Cape Provincial Administration and

the leaders, the leaders undertook to identify the original residents

(b) As this is a slow process, the identification is still taking place

(c) Khayelitsha, scattered in the Peninsula, and some even in Transkei and Ciskei

(3) Yes

(a) Buildings will have to comply with minimum health standards

(b) To prevent slum conditions

(c) By the respective local authorities

(4) Barbed wire surrounds only the vacated area of Crossroads

(a) It serves to demarcate the construction area

(b) As soon as circumstances allow

*8 Mr E K MOORCROFT—Manpower [Reply standing over]

Alexandra Township

*9 Prof N J J OLIVIER asked the Minister of Law and Order

(1) Whether a certain person, whose name has been furnished to the South African Police for the purpose of the Minister's reply, was arrested by the police in Alexandra Township, Johannesburg, on or about 11 July 1985, if so, (a) for what alleged offence, (b) what was his age at the time of his arrest, (c) where was he held and (d) what is his name;

(2) whether this person appeared in court, if so, (a) on what date and (b) on what charges,

(3) whether he was legally represented; if not, why not,

(4) whether he was released on bail, if not, why not, if so, (a) on what date and (b) how many applications for bail had been made in respect of this person prior to that date,

(5) whether this person made any allegations that he had been assaulted while in police detention; if so, (a) when, (b) what were the circumstances surrounding these allegations and (c) what action has been taken in this regard?

†THE MINISTER OF LAW AND ORDER

(1) Yes

(a) Public violence

(b) 11 years

(c) Alexandra police station

(d) Fame Gaduka

(2) Yes

(a) On 12, 15, 23 and 29 July 1985, on 12, 14 and 16 August 1985, on 17 September 1985, on 16 October 1985, on 21 November 1985 and on 13 January 1986

(b) Public violence

(3) Yes

(4) No he was released into the care of his mother on 6 September 1986

(a) and (b) Fall away

(5) Yes

(a) 14 January 1986

(b) He alleged that he was assaulted by a member of the Force who is known to him

(c) An allegation of assault was investigated and handed to the Attorney-General for decision

Brochures

*10 Mr L F STOFBERG asked the Minister of Environment Affairs and Tourism †

(1) Whether his Department makes available publicity brochures in overseas countries with the object of promoting tourism in South Africa, if so,

(2) whether it is stated in any of these brochures that separate amenities in South Africa are being replaced by mixed amenities at an accelerated rate, if so

(3) whether it is the official policy of his Department to promote tourism in this manner?

THE MINISTER OF AGRICULTURE AND WATER SUPPLY (for the Minister of Environment Affairs and Tourism)

The South African Tourism Board forms part of my portfolio but is a statutory body which is not integrated with the Department of Environment Affairs. The word "Department" in the question should therefore be substituted by "South African Tourism Board".
Against this background the reply to the question is as follows

(1) Yes

(2) No

(3) Falls away

†11 Mr L F STOFBERG asked the Minister of Defence †
Brits: visit to motor car factory
HANN SWAN

(1) Whether at the end of their period of service on or about 17 June 1986 Defence Force members of the Personnel Service Corps paid an organised visit to a certain motor car factory at Brits, the name of which has been furnished to the South African Defence Force for the purposes of the Minister's reply, if so, by whom was this visit arranged,

(2) whether Black workers at the factory raised objections to this visit with their employers, if so,

The MINISTER OF LAW AND ORDER

(3) whether the management of the factory requested the Defence Force members to terminate the visit and to leave the premises, if so, with what result,

Yes, the case docket was submitted to the Senior Public Prosecutor, for a decision, who declined to prosecute

(4) whether the Defence Force subsequently contacted the management of the factory about this matter, if not, why not, if so, with what result,

†Mr F J LE ROUX Mr Chairman, arising out of the reply of the hon the Minister, I would like to know whether he intends leaving the matter there

(5) whether he will make a statement on the matter?

†The DEPUTY MINISTER OF DEFENCE

(1) Yes by a member of the Staff of the Personnel Service School

†The MINISTER Mr Chairman, I am not the one to do something more about this matter. It is the obligation of the SA Police to investigate a complaint lodged with them and to submit the dossier to the Attorney-General. In such a case the decision of the Attorney-General is totally objective and independent. No one can apply any further pressure on him or force him, and it also ought not happen. Therefore I have no obligation whatsoever to do anything else concerning the matter. If the hon member for Lichtenburg feels unhappy about the circumstances he is free to submit representations in this regard to the Minister of Justice or the Attorney-General concerned

(2) and (3) On the arrival of the group at the factory they were informed by the production manager that the visit had been cancelled as he feared that Black workers would object to the presence of members in uniform at the factory. The group was invited to visit the factory later in civilian dress

†Mr J H VAN DER MERWE Mr Chairman, further arising out of the reply of the hon the Minister, I would like to ask him whether he is aware of any pressure being applied by his Department or the Department of Justice or Attorney-Generals and/or prosecutors not to institute prosecutions in terms of the Group Areas Act?

(4) Yes to advise the management that the invitation to visit the factory in civilian dress could not be accepted due to a lack of time

†The CHAIRMAN OF THE HOUSE Order! The hon member is actually providing information now and not asking a question

(5) No

†Mr J H VAN DER MERWE Mr Chairman, with respect, I am asking him a pertinent question, namely whether he is aware of any instructions or guidelines to Attorney-Generals and/or prosecutors not to prosecute people in terms of the Group Areas Act? Is he aware of something like that?

Whether, with reference to his reply to Question No 1 on 18 March 1986, the investigation into the alleged illegal occupation by an Indian married couple of a portion of a certain erf in the residential area of Zeerust has been completed, if not, why not, if so, what is the result of the investigation?

*13 Dr F HARTZENBERG asked the Minister of Law and Order †

Zeerust: occupation of erf

(1) Whether the South African Police recently received (a) complaints and/or

handed to the Senior State Prosecutor for decision

(b) representations about certain persons in connection with the occupation of certain properties in the residential area of Zeerust, particulars of which have been furnished to the South African Police for the purposes of the Minister's reply, if so, what are the particulars of the properties concerned,

(b) 20 March 1986 in respect of all three complaints

(2) whether these complaints and/or representations relate to alleged contraventions of the provisions of the Group Areas Act, No 36 of 1966, if so, what is the nature of the (a) complaints, (b) representations and (c) alleged contraventions,

(3) whether the South African Police has taken or will take any action in this connection, if not, why not, if so, (a) what action and (b) when,

†Mr F J LE ROUX Mr Chairman, arising out of the hon the Minister's reply, may I ask him whether he is aware of the fact that the Attorney-General refused to prosecute in this case as well?

(4) whether he will make a statement on the matter?

†The MINISTER Mr Chairman, I have answered the hon member on that in paragraph 3(a) where I expressly stated that case dossiers have been opened. Each case was investigated and was handed over to the senior public prosecutor on 20 March 1986 already. A ruling has not yet been given in the case, and that is why I cannot take the answer to the question any further than what I have already told the House

†Mr J H HOON The holy cow has target!

†The MINISTER OF LAW AND ORDER

Zeerust: occupation of erf

(1) (a) Yes in respect of houses situated at
1 Jan Rossouw Street
16A Kruger Street
14 President Street

*14 Dr F HARTZENBERG asked the Minister of Constitutional Development and Planning †

(b) No

(2) Yes

(a) That other racial groups than Whites occupy the houses, situated in a White residential area

(b) Falls away

(c) Section 26(1) of the Group Areas Act, 1966 (Act 36 of 1966)—illegal occupation

(3) Yes

(a) Case dockets were opened and each case was investigated and

(3) whether his Department has consulted the town council of Zeerust in



Mr PETROS Mlamba.

Mr SAMUEL Ndaba

We were hit with iron bar, then fired — workers

132

4/9/86 80467878

TWO workers employed by a furniture manufacturer yesterday described how a white supervisor allegedly assaulted them with an iron bar "for no apparent reason" and later dismissed them.

One of the workers, Mr Petros Mlamba (22), a member of the African Allied Workers' Union (Aawu), said that another white worker held his hands "behind my back" as the supervisor bludgeoned him almost senseless at Streamline Furniture's premises on Monday this week.

Mr Mlamba said that with blood gushing from head wounds he was told to leave the company's premises. He had been staying on the company's

premises since 1983 when he was employed as a casual worker. He comes from Natal.

Mr Mlamba's colleague, Mr Samuel Ndaba (23), said he was assaulted by the same supervisor the following day for allegedly belonging to a union. He said he managed to escape with minor injuries to the body. He was also dismissed.

The two were due to lay a charge of assault yesterday afternoon.

Streamline managing director, Mr Fransie de Klerk, said he was unaware of the incidents and advised the workers to lay a charge with the police.

Aawu is investigating the matter.

Unions urged to be realistic on wages

DURBAN — Organised labour must realise that unrealistic wage demands and strike action can lead to increased mechanisation at the expense of job opportu-

nities, the executive director of the National Productivity Institute, Dr Jan Visser, said

Dr Visser told a productivity seminar that workers must accept

that they could not demand more than their actual contribution to production was worth. The only sound basis for higher remuneration without unemployment was higher productivity, yet in South Africa real wages were rising despite a poor productivity performance. This was a sure recipe for a rise in unemployment.

"Steadily rising unit labour cost increases have been putting increasing pressure on South Africa's international competitiveness, which contributed to the decline in the value of the rand," he said.

Should the tendency of little correlation between wage rates and productivity performance continue, it would threaten the already shaken rand.

The attitude of labour unions should become less aggressive. In particular, perception of productivity growth should be improved, for many of them had an adverse understanding of the concept of productivity.

132
8/9/86

Workers allege they were assaulted after being fired

16/9/86
By Sheryl Raine

Two black workers employed by a Johannesburg furniture manufacturer claim they were fired, beaten with an iron rod and prevented from collecting their belongings at the factory premises.

Mr Petrus Mlaba (22) allegedly suffered head, face and arm injuries while Mr Simon Ndaba (23) suffered bruises and welts on his body and face

Both men, members of the African Allied Workers Union, are considering laying charges of assault against a white employee of Streamline Metal Furniture Manufacturers in Marshalltown

Mr Mlaba, a spray painter, who had been with the company for more than three years claimed he was dismissed last week when his employer told him he was incompetent. He went to collect his pay on Tuesday this week and was paid R280 which was supposed to include notice pay. As he earned R90 a week, he queried the amount

ASSAULTED HIM

While in his room on the premises collecting his belongings two white men burst in, he said. One held his arms and the other assaulted him with an iron rod. He fled and has not been able to collect his belongings

Mr Ndaba, who is also a spray painter, claimed he was fired for joining the union on Tuesday. He said he was also beaten with an iron rod by the same man who beat Mr Mlaba

Union national vice president, Mr Malusi Mpondo, said a third case of assault at the same factory was being investigated

Mr Frans de Klerk of Streamline said he was not aware that anyone had been assaulted on his premises

"I know nothing about any assaults which took place on my premises on Tuesday. I was at the factory until 9.30 pm and am not aware of any incidents

"These guys go and get themselves assaulted in the townships and blame it on their employer

"Both these men resigned voluntarily. They were not fired but they came back to the factory with the union and claimed they had not resigned. My other black employees will testify that they resigned"

He said he had paid Mr Mlaba his final wages calculated according to a formula laid down by the furniture industry and his books could be inspected at any time.

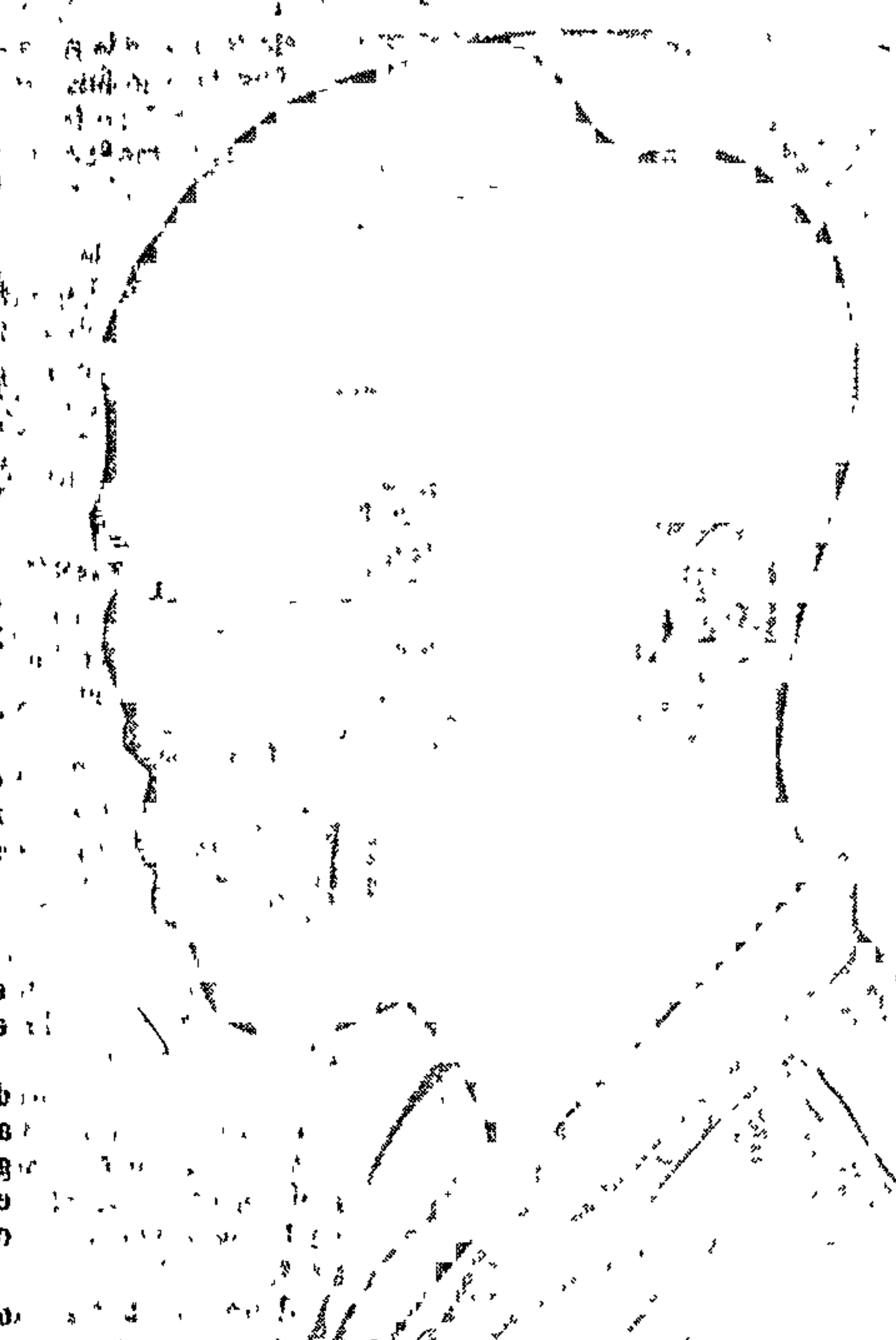

Mr Petrus Mlaba (22) says he was assaulted at his place of work. He suffered head, facial and arm injuries after being beaten with an iron rod.

Klas werksnemer	Vr die tydperk eindende 31 Desember 1986	Vanaf 1 Januarie 1987	Vanaf 1 Julie 1987	Vanaf 1 Januarie 1988
Hoofkelder/ Hoofwinkelier	R 355	R 380	R 407	R 435
Kelder/ Winkelier	R 309	R 331	R 354	R 379
Kwelyngkelder/ Kwelyngwinkelier	R 287	R 307	R 329	R 352
Hoofkroegman	R 817	R 875	R 936	R 1 001
Kroegman	R 436	R 466	R 499	R 534
gedurende derde jaar ondervinding	R 564	R 604	R 646	R 691
gedurende vierde jaar ondervinding	R 651	R 697	R 746	R 798
diarna				
Kwelyngkroegman	R 309	R 331	R 354	R 379
gedurende eerste jaar ondervinding	R 363	R 388	R 416	R 445
gedurende tweede jaar ondervinding				
Butler/verkoopassistent	R 345	R 370	R 395	R 423
gedurende eerste jaar ondervinding	R 410	R 439	R 470	R 503
gedurende tweede jaar ondervinding	R 475	R 508	R 544	R 582
gedurende derde jaar ondervinding	R 494	R 528	R 565	R 605
gedurende vierde jaar ondervinding	R 541	R 579	R 620	R 663
diarna	R 541	R 579	R 620	R 663
Motorvoertuigdrywer	R 355	R 380	R 407	R 435
Besteller	R 270	R 288	R 309	R 330
Klerk	R 355	R 380	R 407	R 435
gedurende eerste jaar ondervinding	R 409	R 438	R 468	R 501
diarna	R 309	R 331	R 354	R 379
Portier	R 254	R 272	R 291	R 311
Hotellojier	R 325	R 350	R 377	R 405
Shakelbordoperateur	R 325	R 347	R 372	R 398
Faktoon	R 270	R 288	R 309	R 330
Algemene dienste/ erksnemer graad I	R 285	R 305	R 326	R 349
gedurende eerste jaar ondervinding	R 254	R 272	R 291	R 311
diarna	R 262	R 280	R 300	R 321

WAGES PER MONTH

Class of employee	For the period ending 31 December 1986	From 1 January 1987	From 1 July 1987	From 1 January 1988
Manager	R 1 078	R 1 153	R 1 234	R 1 321
Assistant manager	R 978	R 991	R 1 060	R 1 135
Departmental manager	R 818	R 876	R 937	R 1 003
Assistant departmental manager	R 740	R 792	R 848	R 907
Traine manager	R 330	R 353	R 378	R 404
first year of experience	R 386	R 413	R 442	R 473
second year of experience	R 440	R 471	R 504	R 539
third year of experience	R 377	R 404	R 432	R 462
Housekeeper/Kitchen supervisor	R 295	R 313	R 335	R 358
Chief	R 417	R 446	R 477	R 511
Cook	R 355	R 380	R 407	R 435
Kitchen assistant	R 254	R 272	R 291	R 311
Cook trainee	R 277	R 297	R 317	R 340
first year of experience	R 293	R 313	R 335	R 358
second year of experience	R 333	R 353	R 380	R 405
Head waiter/Head steward	R 309	R 331	R 354	R 379
Waiter/Steward	R 287	R 307	R 329	R 352
Head barman	R 817	R 875	R 936	R 1 001
Barman	R 436	R 466	R 499	R 534
third year of experience	R 564	R 604	R 646	R 691
fourth year of experience	R 651	R 697	R 746	R 798
hereafter				
Traine barman	R 309	R 331	R 354	R 379
first year of experience	R 363	R 388	R 416	R 445
second year of experience	R 345	R 370	R 395	R 423
Off-sales assistant	R 410	R 439	R 470	R 503
first year of experience	R 475	R 508	R 544	R 582
second year of experience	R 494	R 528	R 565	R 605
third year of experience	R 541	R 579	R 620	R 663
fourth year of experience	R 541	R 579	R 620	R 663
hereafter	R 270	R 288	R 309	R 330
Motor vehicle driver	R 355	R 380	R 407	R 435
Delivery employee	R 270	R 288	R 309	R 330
first year of experience	R 355	R 380	R 407	R 435
hereafter	R 409	R 438	R 468	R 501

Class of employee	For the period ending 31 December 1986	From 1 January 1987	From 1 July 1987	From 1 January 1988
Portier	R 309	R 331	R 354	R 379
Switchboard operator	R 254	R 272	R 291	R 311
Handyman	R 325	R 347	R 372	R 398
General services employee Grade I—				
first year of experience	R 270	R 288	R 309	R 330
hereafter	R 285	R 305	R 326	R 349
General services employee Grade II—				
first year of experience	R 254	R 272	R 291	R 311
hereafter	R 262	R 280	R 300	R 321

4 KLOUSULE 5 — BETALING VAN BESOLDIGING

1. Verwag die inleidende gedeelte van subklausule (5) deur die volgende:

Wanneer daar ingevolge enige wet van 'n werksnemer (uitgesonderd 'n los werksnemer) vereis word of wanneer hy daartoe instem om kos en/of inwoning van sy werksnemer aan te neem, kan 'n bedrag van hoogstens die bedrag hieronder uiteengesit van sy besoldiging afgetrek word (A.V.B. in gesluis).

Aftekings per maand vir alle werksnemers

(a) Kos

(i) Indien die werksnemer nie op die perseel inwoning nie R30,00 per maand

(ii) Indien die werksnemer op die perseel inwoning R50,00 per maand

(b) Inwoning R30,00 per maand

5 KLOUSULE 7 — GETALVERHOUDING VAN WERKSNEMERS

Verwag klausule 7 (2) deur die volgende:

(2) Waar daar in hierdie klausule melding gemaak word van ongekwalifiseerde werksnemers, mag niks in hierdie klausule die indiensneming verband van gekwalifiseerde werksnemer in plaas van ongekwalifiseerde werksnemer nie.

6 KLOUSULE 12 — SIEKTEVERLOF

In die Engelse teks klausule 12 (1) voeg die syfer 36 in tussen die woorde during each cycle of en consecutive months of employment.

7 KLOUSULE 13 — BEÏNDIGING VAN DIENSKONTRAK

Voeg die volgende subklausule (8) in na subklausule (7):

(8) Hierdie klausule is nie op los werksnemers van toepassing nie.

8 KLOUSULE 14 — VRYSTELLING

In die Engelse teks in klausule 14 (3) vervang die woord in tussen die woorde of this clause en licence of exemption deur die woord a.

9 KLOUSULE 15 — UITGAWES VAN DIE RAAD

In klausule 15 vervang die syfer 50c deur die syfer 70c.

10 KLOUSULE 19 — VAKVERENIGINGARBREID

In subklausule (3)—

(1) in die Engelse teks in paragraaf (c) vervang die woord assisting deur die woord assisting.

(2) voeg die volgende nuwe paragraaf (d) in na paragraaf (c)

(d) besonderde verkry wat nodig is vir die tekenansoek van die register van lede.

11 KLOUSULE 24 — PENSIOENFONDS

(1) In klausule 24 (1) vervang die woorde Hotelpensioenfonds wat deur die Hotelraad ingestel is deur die woord FEDHASA-pensioenfonds.

(2) In klausule 24 (6) vervang die woorde Hotelpensioenfonds deur die woord FEDHASA-pensioenfonds.

(3) In klausule 24 (7) vervang die woorde Suid-Afrikaanse Nasionale Lewenssurvivaansmaatskappy deur die woorde Price Forbes Federale Employee Benefits Consultants (Proprietary) Limited.

12 Voeg die volgende nuwe klausule in na klausule 26

27 GEDRAGSKODE

Werknemers en werksnemers moet voldoen aan die Gedragskode, soos deur die party by die Ooreenkoms aanvaar 'n Kopie van hierdie Gedragskode soos van tyd tot tyd gewysig moet gehou word by die kantoor van die Sekretaris van die Nywerheidsraad.

Namens die party op hede die 17de dag van Junie 1986 te Pretoria onderteken

P J DU PRE LE ROUX,
Voorsitter van die Raad

L E ETCHHELLS,
Ondervoorsitter van die Raad

M J BROWN,
vir Ernst & Whitney, Sekretaris van die Raad

4 CLAUSE 5 — PAYMENT OF REMUNERATION

1. Substitute the introductory portion of subclause (5) with the following:

Whenever an employee (other than a casual employee) is required in terms of any law or agrees to accept board and/or lodging from his employer, a deduction may be made from his remuneration not exceeding the amounts specified hereunder (GST included).

Deductions per month for all employees

(a) Board

(i) If employee does not reside on premises R30,00 per month

(ii) If employee resides on premises R50,00 per month

(b) Lodging R30,00 per month

5 CLAUSE 7 — PROPORTION AND RATIO OF EMPLOYEES

Substitute the following for clause 7 (2):

(2) Whenever reference is made in this clause to unqualified employees, nothing in this clause shall be deemed to prohibit the employment of a qualified employee in the place of an unqualified employee.

6 CLAUSE 12 — SICK LEAVE

In clause 12 (1) insert the figure 36 between the words during each cycle of and consecutive months of employment.

7 CLAUSE 13 — TERMINATION OF CONTRACT OF EMPLOYMENT

Insert the following subclause (8) after subclause (7):

(8) The provisions of this clause shall not apply to a casual employee.

8 CLAUSE 14 — EXEMPTIONS

In clause 14 (3) substitute the word a for the word in between the words of this clause and licence of exemption.

9 CLAUSE 15 — EXPENSES OF THE COUNCIL

In clause 15 substitute the figure 70c for the figure 50c.

10 CLAUSE 19 — TRADE UNION LABOUR

In subclause (3)—

(1) in paragraph (c) substitute the word assisting for the word assisting.

(2) insert the following new paragraph (d)

(d) obtaining details required for computerising the register of members.

11 CLAUSE 24 — PENSION FUND

(1) In clause 24 (1) substitute the words FEDHASA Pension Fund for the words Hotel Pension Fund inaugurated by the Hotel Board.

(2) In clause 24 (6) substitute the words FEDHASA Pension Fund for the words Hotel Pension Fund.

(3) In clause 24 (7) substitute the words Price Forbes Federale (Employee Benefits Consultants) (Proprietary) Limited for the words South African National Life Assurance Society.

12 Insert the following new clause after clause 26

27 CODE OF CONDUCT

Employers and employees shall conform to the terms of the Code of Conduct agreed to by the parties to the Agreement. A copy of this Code of Conduct as amended from time to time shall be kept at the office of the Secretary of the Industrial Council.

Signed at Pretoria on behalf of the parties this 17th day of June 1986

P J DU PRE LE ROUX,
Chairman of the Council

L E ETCHHELLS,
Vice-Chairman of the Council

M J BROWN,
for Ernst & Whitney, Secretary for the Council

Court ruling hailed as major breakthrough

CAPE TOWN — A Supreme Court ruling that the Industrial Court has the discretion to permit a party in a dispute to have legal representation even if another party objects, has been hailed as a major breakthrough for workers involved in a dispute.

Mr Justice H Berman, with Mr Justice Nel, yesterday upheld an application by Mr Vincent Mrali for an Industrial Court decision refusing him permission to be represented by an attorney in a dispute to be set aside.

The judge ruled that the matter should be referred back to the Industrial Court for question of legal representation to be determined afresh.

According to papers before the court, Mr Mrali applied to the Industrial Court for relief after being dismissed in March from his position as truck driver for Town Talk Furnishers, owned by Ellerines Holdings.

LIKE DAVID WITHOUT A SLINGSHOT

The Industrial Court refused him permission to be represented by an attorney during the hearing on September 26, on the grounds that if one party in a dispute objects to another having representation, permission must be refused.

The judge said it was regrettable that the respondents, Ellerine Holdings, and the president and additional member of the Industrial Court had not opposed the application because the court was deprived of argument.

He said the Industrial Court erred in adopting the approach that if one party objected to another being represented by an advocate or attorney, the court did not have the discretion to permit representation.

Mr Mrali, who had a 'Std 8' education, was challenging a company represented by a director who had legal experience.

It could not have been intended that illiterate workers should have to challenge multinational conglomerates without legal representation "like David without a slingshot against a well-armed Goliath" — Sapa

N/M 132
26/9/86

Govt **plans to** **get tough** **on aliens**

Mercury Correspondent

JOHANNESBURG—The Department of Home Affairs intends to step up measures against the estimated 1 300 000 aliens and employers contravening the Aliens Act, but this does not apply to TBVC blacks.

Director-General of Home Affairs Mr B G S van Zyl said yesterday that increased action was being taken to determine the location of aliens. The department, he said, was also considering conducting more employer inspections which might result in the increased prosecution of employers.

The Aliens Act provides for fines of up to R5 000 or two years' imprisonment for a first conviction.

The department, Mr van Zyl said, might have to increase its staff to conduct these measures. It also intends providing employers with guidance as to how to identify people illegally seeking employment, he said.

'They are taking up jobs of millions of South Africans who may have to be paid unemployment insurance,' he said.

However, Mr van Zyl emphasised that Home Affairs Minister Stoffel Botha had exempted citizens of the TBVC states of certain requirement under the Aliens Act.

He said they did not require a work permit in terms of the Aliens Act but appealed to employers to comply with certain requirements stipulated in a labour agreement signed at the time of the independence of the TBVC states.

Govt to crack down on illegal employees

JOHANNESBURG — The Department of Home Affairs intends to step up measures against an estimated 1 300 000 aliens and employers contravening the Aliens Act

However, this does not apply to blacks from Transkei, Bophuthatswana, Venda and Ciskei (the TBVC states)

The Director-General of Home Affairs, Mr B G S van Zyl, said yesterday increased action was being taken to determine the location of aliens

The department was also considering conducting more employer inspections which might result in the increased prosecution of employers, he said

The Aliens Act provides for fines of up to R5 000 or two years imprisonment for a first conviction

The department also intended providing employers with guidance on how to identify people illegally seeking employment

"They are taking up the jobs of millions of South Africans who may have to be paid unemployment insurance," Mr Van Zyl said — DDR

Handwritten: 26/9/86 (32)

You'll be satisfied with classified!



people read classified

Class: Adver

Phone 32:

Trade Unions Council of persistent wet and cold. The 10ns
 the president of the IAST LONDON — the 10ns

Housewives Black with its strongest
 in Mrs Gail Mea

CLAN



FOCUS

LIBERATIVE Government subsidies to lure industries to the homelands are losing urban workers thousands of jobs as companies fall over one another to cut costs and increase profits

Companies were slow to take advantage of the programme, designed by the Government to bring industries and work opportunities to the impoverished homelands, until the recession induced increasing numbers to move

Trade union sources are concerned at the number of urban factories that are closing down and moving to the homelands, leaving their workforces in the lurch

There are not any legal requirements or set procedures for the severance pay to be given workers when a company moves

The scheme has become a useful avenue for some employers confronted with a militant labour force or union they simply close their operations and move to the homelands where wages are low and workers are pliable and have not been organised into union movements

As one union leader put it, the homelands are "union-free zones"

Severance pay

One union, the Garment Workers' Industrial Union, which is confined to Natal, estimates that since January, 1985, its membership has dropped by more than 13 000 as a result of employers' moving to the homelands. In the same period, more than 56 000 clothing-industry jobs have been created in the homelands

Earlier this month, about 250 clothing workers at Scotford Mills, Durban, were fired after a strike over the severance pay offered by the company, which was moving to another border industrial area, Ezakheni, outside Ladysmith

The GWIU's assistant general secretary, Yu-

Workers left in the lurch as companies relocate

SOWETAN CORRESPONDENT



WORK-SEEKERS in Johannesburg Is this the future for urban workers as firms pull out to the homelands.

nus Shaik, said the severance pay was R8 for each year of service, up to a maximum of R50

"The company said we could take it or leave it, and when we refused they unilaterally closed negotiations. All the workers were fired after going on strike and all they got was a week's wages. It was as simple

as that," Mr Shaik said. "We have nothing against people in the homelands getting jobs, but we're against the exploitation of workers. Capital is exploiting workers with the assistance of the State. Workers are losing all the rights they fought very hard for"

Union leaders in the leather, textile and clothing industries met in Cape Town on Friday to discuss the problem

Mr Shaik said unions' bargaining power was being eroded because urban-based companies had to compete with those in the homelands, where goods could be produced cheaply. This meant employers were less likely to agree to higher wages since this might affect their competitiveness

The Chemical Workers Industrial Union (CWIU), an affiliate of the Congress of South African Trade Unions, is to meet the management of a factory in Wadeville, on the East Rand, which is to move

to Bophuthatswana, costing about 400 workers. 220 of them CWIU members, their jobs

According to the CWIU's national general secretary, Rod Crompton, the company, Matthey Rustenburg Refiners (MRR), intends closing its plants in Wadeville, near Germiston and at Royston, in England and moving all its operations to Bophuthatswana, where South African-based unions are banned

The CWIU is liaising with its counterpart in Britain, where MRR has already retrenched about 100 workers

An MRR spokesman has declined to discuss the move. "That's not something we wish to comment about"

Mr Crompton says the Government's decentralisation scheme encourages exploitation

"The point we want to make is that workers overseas are told it is wrong to push for sanctions and disinvestment because that would put a lot of workers here out of their jobs. But if they don't push for the removal of apartheid, workers will continue to lose their jobs because companies will move to the homelands to make super-profits"

The homelands are attractive because their wage structures are low and they are hostile to the labour movement

Benefits

"The Government's policy is to encourage factories to move to these decentralisation areas, that is the homelands," Mr Crompton says

"There are also tax and wage incentives for companies to move to places like the Ciskei"

"This programme, far from creating new jobs, is encouraging industries to move to new areas. The only ones who benefit are those capitalists who get tax incentives"

"The working class are the losers because they have to pay more taxes"

Dougie de Beer, chairman of the Decentralisation Board, said last year that the Government had paid nearly R307 million in decentralisation benefits to companies from February, 1984, to January, 1985. It is expected the figure for 1985/86 will exceed R500 million. These figures exclude the Government's payment of 50 percent of the decentralisation costs incurred in the independent homelands

It is thought that during 1985/86, more than R90 million was paid in decentralisation benefits to industrialists who moved to Ciskei

The Media Council

THE South African Media Council is an independent body established to deal with various matters affecting media reporting and comment

One of the council's functions is to receive and act upon complaints from members of the public who have not been able to get satisfaction by approaching a newspaper or other news



Saawu hails agreement

DD 3/1/86
132

Dispatch Reporter
EAST LONDON — A recognition and procedural agreement was signed between the South African Allied Workers' Union (Saawu) and Barlows Commercial Refrigeration last week, Saawu's local secretary, Mr Boyce Melitafa, said in a statement

The general manager of the company, Mr O E Sellers, said the objective of the procedural agreement was to maintain sound and fair labour relations in the

factory
Mr Melitafa said the signing of the agreement was a "victory" for South African workers

Negotiations between Saawu and the company in Wilsonia had started in June this year. The company's workforce totalled 220, and Saawu membership stood at 204

Turning to what he described as harassment of the general membership and leadership of the union, Mr Melitafa said Saawu had sur-

vived the "onslaught over the past six years and will continue to survive in the future

"This agreement together with others already in existence will add strength to the Congress of South African Trade Unions (Cosatu) to which Saawu is affiliated"

He added Saawu was engaged in merger talks with some unions affiliated to Cosatu. Saawu was a founder member of Cosatu

Big business in the dock

0176 21 34
2841 21 1
515 24 1
795P 27 1E
131 28 0 1
JUN 01 1
194 74

Despite recent efforts by sections of big business to distance themselves from the Government and its apartheid policies, organised black workers remain unconvinced of their employers' bona fides in the struggle for a more equitable South Africa.

With the heightening of the conflict between the Government and its unwilling black subjects, big business, especially the liberal component, has increased its public criticism of State policy.

Simultaneously, business has called for the abolition of discriminatory legislation, the unbanning of groups such as the ANC and an end to violence.

It has in some instances, criticised the authorities for resorting to more force in dealing with black rebellion suggesting instead that talks should be held with legitimate black leaders — some of whom are in jail or in exile.

Attitudes

Eminent businessmen — including Anglo American chairman Mr Gavin Rilly and Premier Group chairman Mr Tony Bloom — have even met the ANC in Lusaka.

However according to Mr Christo Nel assistant to the chief executive of the Federated Chamber of Industries and Project Free Enterprise (PFE) chairman, such actions would not have changed workers' attitudes towards big business.

In fact, said Mr Nel, black workers' negative perceptions of big business — spotlighted by PFE research in 1984 — had worsened. This was borne out by, among other things, the fact that South Africa was experiencing labour unrest in the middle of a recession.

The 1984 survey found that South African workers saw few opportunities for personal gain under a free enterprise system and were ready to accept the concept of socialism.

"Black workers see apartheid and free enterprise as one and the same thing. Reforms that have taken place have not altered the environment significantly enough to change black workers' perceptions," Mr Nel said.

This interpretation seems to be borne out by demands by the country's emergent unions for the aboli-



Dr Zac de Beer

tion of both the present economic and political systems.

Speaking in Johannesburg recently, the secretary general of the largest black union (the National Union of Mineworkers), Mr Cyril Ramaphosa declared "It is too late for free enterprise to save South Africa. Workers are now demanding a socialist system."

"Despite efforts of big business to distance itself from the (apartheid) regime workers have learnt (that) the root and fruit of profit lay in the exploitation of workers," submitted Mr Ramaphosa.

Because of this, he warned, attempts by business to salvage capitalism were doomed to fail.

This standpoint is shared by Dr Bernie Fanaroff, national organiser of the Metal and Allied Workers' Union (Mawu), perhaps the most militant union in the crucial metal industry.

"We believe that apartheid and capitalism have always been inter-related. Both business and the present political rulers would like to maintain the present system where a small minority is extremely wealthy while the rest of the people are extremely poor," charged Dr Fanaroff.

"A significant fraction of big business," he pointed out, "welcomed the state of emergency as necessary

The relationship that has developed between black workers and employers since 1979 has been held up as a model for the resolution of South Africa's political problems. But while there is agreement between the two camps on the need to banish apartheid, the real debate on a replacement political and economic system is yet to begin, writes MIKE SILUMA.

MIKE SILUMA
(32)

to create economic stability.

"Our members believe that it would be pointless to remove apartheid without eliminating exploitation."

Dr Fanaroff would not be drawn into the specifics of the envisaged replacement economic system, saying the type of socialist society would have to be decided democratically by the majority of South Africans.

Understood

He also declined to suggest what business should do to be perceived as an ally in the struggle for a more equitable society. But demands made by Mawu on metal industry employers have included that they cease business with the police and the army.

On the other hand, Anglo American director Dr Zac de Beer holds the view that "capitalism, properly understood, demands the rejection of apartheid."

Acknowledging a tendency towards socialism in the black union movement, Dr de Beer attributed this more to "a generalised resentment of a system which has oppressed black people" than to "an objective evaluation of the merits of socialism and free enterprise."

South African history, he said,



Mr Cyril Ramaphosa

had led many people to link capitalism with apartheid, with "Marxist thinkers" doing all they could to encourage the confusion.

Dr de Beer agreed that big business had yet to demonstrate to workers that they had much to gain from free enterprise. This could be achieved through black advancement in commerce and industry, a fair wage policy and the provision of decent conditions for workers — both in the workplace and outside.

But he rejected as "unrealistic" suggestions that big business could put pressure on the Government to change by, for instance, withholding taxes.

"If this were tried, it would simply lead to the confiscation by the authorities of assets belonging to business and/or the seizure by the Government of the businesses themselves."

"Either of these would lead to a serious deterioration in the performance of business — with consequent job losses. Business cannot force the Government to do what it does not want to do," said Dr de Beer.

Mr Nel suggested that to change black workers' current perceptions of the free enterprise system, business would have to represent the interests of its labour force in a much more substantial manner.

Calling for a "major redistribution of benefits", he said that "the gap between the haves and the have-nots in South Africa is unacceptably high".

A view held in some employer circles and labour relations circles is that much of what black union leaders are saying consists of rhetoric. It is pointed out that while publicly making radical demands on the ground, black unionists are in fact continually involved in negotiations to resolve shopfloor differences with employers.

Tried to this is the feeling that once the benefits of the free enterprise system are extended to black workers the workers would intuitively want to preserve the proverbial goose that lays the golden eggs.

However, Dr Duncan Innes, a senior lecturer in industrial sociology at the University of the Witwatersrand, cautions against such complacency.

Differences

He warns that while there is agreement between business and labour on the removal of laws such as influx control and the Group Areas Act, there remained crucial differences on issues such as the political and economic systems to replace the existing ones.

Dr Innes said big business wanted a free enterprise system with less State control. The majority union view on the other hand, was that only more Government controls on business in a post-apartheid society would bring about equal distribution of wealth — with workers having a greater say in State decisions on matters such as education, health services and housing.

He added that the possibility of co-operation between black workers and business in bringing about fundamental change remained minimal because most business people were relying on the Government "to sort things out" for them.

All examples of employer behaviour show that about 90 per cent of business sides with the Government against the unions. For instance, employers have not paid proper wages to detained workers, but they are paying conscripts,

said Dr Innes.

(27) BUS DAY (132)
16/01/86
THELMA TUCH

Business asked to set pace

THE SA business community could set the pace for change by putting their own houses in order,



● RELLY

Anglo American chairman Gavin Relly said last night.

He was addressing a function at which he was awarded the Harvard Business School Club of SA's Statesman of the Year Award.

Relly said employers should review the ways in which their employees were remunerated and the stakes they had in their businesses, and also look at their training and advancement programmes.

"By introducing policies and structures in our own companies, which will provide the cutting edge to a new society, we will hopefully give encouragement to other companies and departments of State to follow suit," he said.

It was necessary to develop a strong, all-race management group in order to solve SA's problems.

It had not been easy, Relly said, to develop managerial and director skills among blacks, coloureds and Indians. This was not due to incompetence but to a hostile environment, both in-house and socially.

"Much of this can be traced to apartheid but a good deal can be traced to our own shortcomings"

Bosses worried as Way Day holiday is still unofficial

Own Correspondent

CAPE TOWN — Government foot-dragging on the emotive May Day holiday issue is causing increasing concern among employers who want to avoid future disruptions to business and the community.

They can see only increasing pressure from labour for an official May Day holiday and forecast that this year's mass stayaways — forcing a de facto holiday — would be repeated next year and accused the Government of being "stiff-necked".

"They claim to be willing to negotiate with representative organisations on issues of common concern

"And who more representative than trade unions and employer bodies?"

"What greater issue of concern than maintaining industrial peace?" asked one employer.

Major employer bodies, including the Steel and Engineering Industries Federation (Self-sa), the Federated Chamber of Industries (FCI) and the Associated Chambers of Commerce (Assocom), have voiced concern about the lack of Government action.

RECIPE FOR DISASTER

Although many employers and unions have agreements giving some form of recognition to the day, employers have called this informal situation "a recipe for disaster" in the absence of a clear commitment from Government.

May Day this year was marked by a stayaway of about 2.5 million workers and pupils at a cost of millions to industry and commerce.

A spokesman for the Congress of South African Trade Unions (Cosatu) — a leader in the call for a May Day holiday — said decisions on public holidays had become a mass issue.

"A momentum has been created by previous stayaways so May Day has become accepted as a public holiday by organised workers," he said.

"But Government delays are forcing it to become a political issue which the employers would rather have avoided," he added.

Many killed on this tragic day in PE's history

THE Eastern Cape has long been at the forefront of black political activity and worker mobilisation.

The first known strike in South Africa's history was by Fingo beach labourers at Port Elizabeth in 1846

Although strike action was used by black workers throughout the 19th century, probably the first example of a trade

On October 23, 1920, a big crowd gathered outside the Baakens Street police station demanding the release of a labour leader who had been arrested in a bid to avert a strike. Attempts to disperse the crowd failed, there was shooting, and 23 people were killed and 50 injured.

GARY BAINES, who is researching the history of labour relations in the Eastern Cape for an MA thesis at Rhodes University, writes about the tragic, all-but-forgotten day.

He would welcome any response from readers who might have personal knowledge of the events he describes. He can be contacted at Vista University in Port Elizabeth.

Threat to free labour leader led to 1920 shootings

This historic photograph, published for the first time in a newspaper is in the SAP Museum in Pretoria. Armed men can be seen on the balcony of the old Baakens Street police station on Saturday, October 23, 1920, while a crowd milled about in the street, demanding the release of a union leader. Shortly afterwards shots rang out.

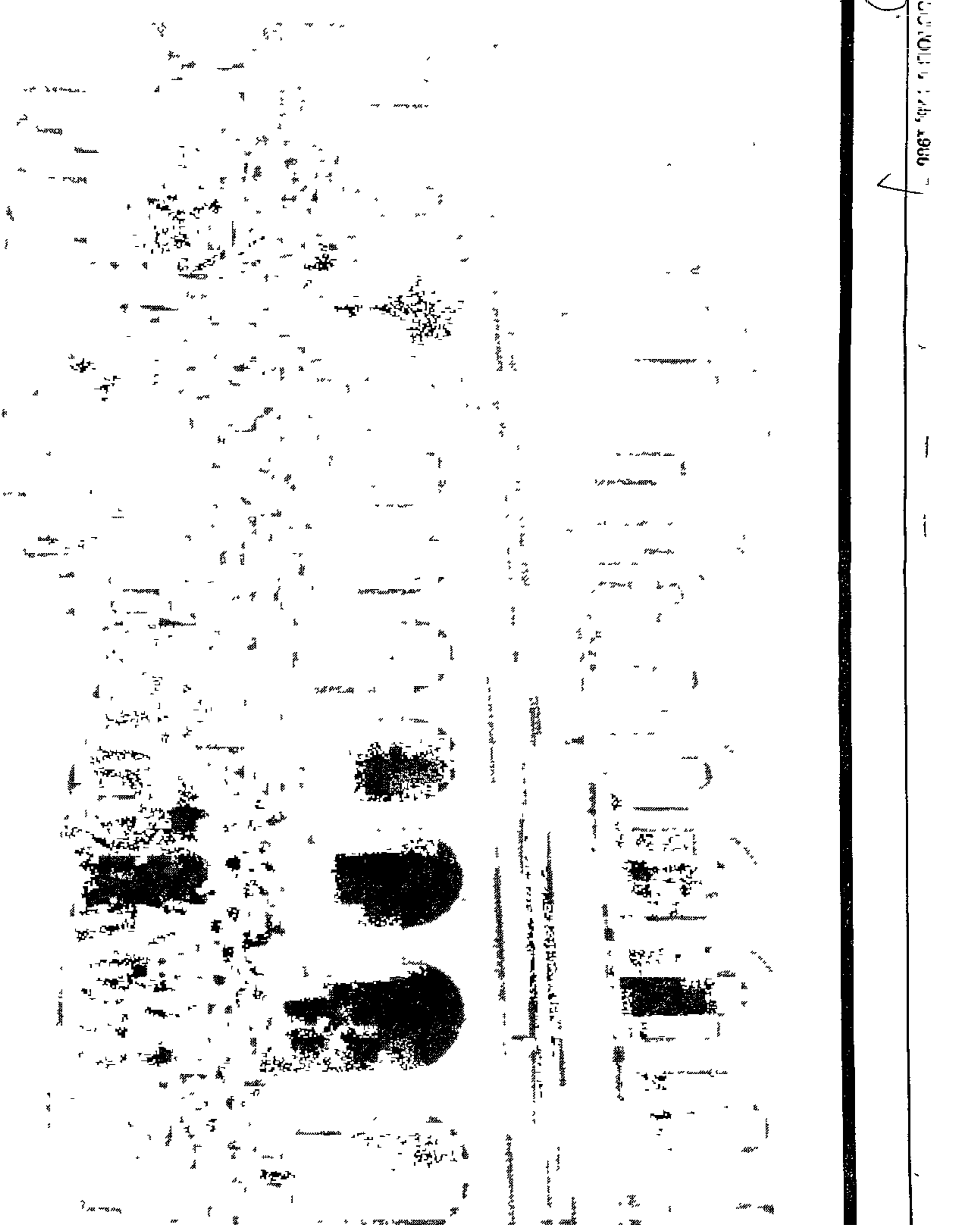

25/10/84 [182]

was the formation of the Port Elizabeth Industrial and Commercial Amalgamated and Coloured and Native Workers' Union

It emerged as an independent organisation during the First World War, but by 1920 had forged links with the nation-wide Industrial and Commercial Workers' Union of Africa (ICU)

Port Elizabeth's black working classes had been particularly hard hit by the spiralling inflation of the war years

Wages had not kept pace with the cost of living, which had soared by more than 100% while the 1914 level of 2s 6d (about 25c in today's currency terms) a day minimum wage for unskilled labour had increased to only 3s by 1919 - about 20%

Employers justified the wage levels on the grounds that a new minimum wage, which would entail across the board increases, would necessitate the retrenchment of a proportion of the work force

On account of the surfeit of unskilled labour in PE, employers were in a position to resist demands for wage increases unless wholesale mobilisation of the work force could be effected
The PE union, under the

leadership of Samuel Masabalala, claimed a membership of more than 4 000 and the support of most of the city's unskilled workers.

In January, 1920, it began a campaign for a minimum daily wage of 10s which was rejected out of hand by employers. An interim increase of 6d a day was accepted by the union, but negotiations were continued on the employers' terms with a delegation from which Masabalala was excluded.

The snub of a recognised popular leader, whom the Press and the authorities regarded as a demagogue, made the resolution of differences between the employers and the work force increasingly unlikely

At a mass meeting held at Korsten on October 17, Masabalala called for a general strike on November 3

At the same meeting Dr W B Rubusana, an East London Congregational minister and vice-president of the South African Native National Congress, was allegedly assaulted by followers of Masabalala

Rubusana, at the request of the authorities, had addressed meetings at which he appealed for moderation

The failure of this strategy prompted the arrest of Masabalala in the hope of preventing the strike, and on the morning of Saturday, October 23, he was taken to the Baakens Street Police Station where he was held in custody pending his being charged with incitement to public violence

Shortly after 1pm a delegation from the union requested the release of Masabalala on bail, but this was refused by the District Commandant of Police on the advice of the acting magistrate

During the afternoon further representations for Masabalala's release also failed and an ultimatum was made demanding his release by 5.15pm, failing which his supporters said they would free him by force

By late afternoon a crowd of several hundred, consisting of Masabalala's supporters and bystanders, had gathered outside the police station

After 5pm a section of the crowd became increasingly restless and pressed hard on the policemen who had taken up positions to guard the steps

Two futile attempts - one by a mounted charge and the other by use of a

firehose - were made to disperse the crowd, and they served only to incite further hostility

The barricaded police station had been reinforced by a number of Railway Police and civilian volunteers, who were armed with rifles and had taken up positions on the balcony.

Shortly afterwards firing erupted and 23 people were killed - 20 blacks and three whites - and more than 50 others were injured.

News of the shootings spread panic and fear among PE's white population as a "black peril" scare took hold.

The tense situation was fuelled by rumours that blacks had threatened the lives of white employers

Whites took steps to defend themselves. Armed vigilantes, mainly ex-serVICEMEN, augmented police patrols, and an appeal was made for reinforcements

Attempts at arson and the sabotage of a petrol storage depot and power station seemed to confirm that the fears of whites were not groundless

The flight of a considerable number of blacks from the city suggested that they also feared repercussions from the

shootings

However, by the following Monday it was reported that a tense calm had returned to the Bay. Meanwhile, Masabalala had been removed to Grahamstown where he was later to stand trial. All charges against him were eventually withdrawn

In his absence, the union called in Selby Msimang, a founder of the ICU, from Bloemfontein, to continue negotiations with employers.

It was decided to call off the strike, but a deadlock resulted when the union rejected a minor wage increase offered by employers

The tragic loss of life did nothing to ameliorate the lot of the black worker, for the repressive apparatus of the State put its weight behind the employers in the name of law and order

A commission of inquiry which was headed by Mr C A Schweitzer, former MP for Alwal, and including Dr A W Roberts, of Lovedale, and Dr A Abdurahman, leader of the African People's Organisation, was appointed to investigate the shootings

The terms of the mandate gave implicit recognition to the fact that the

disturbances were directly related to the socio-economic conditions of PE's black population

Yet statements by the local Press and institutions such as the PE Chamber of Commerce attributed the disturbances to agitation and lost sight of the underlying causes

Public attention focused on whether or not the shootings could be justified, and the commission's findings proved both equivocal and controversial

On one hand, it condemned the "behaviour of the natives in assembling in force before the police station with the avowed determination of forcibly effecting the release of Masabalala". On the other, it censured the police inspector for refusing bail and not maintaining discipline among the volunteers on the balcony who had fired without orders to do so

The commission stated that it had been unable to determine with any accuracy whether the first shots had been fired from the crowd, the balcony or the steps of the police station

While it was common cause that many in the crowd had been carrying

knives, no conclusive evidence was forthcoming that any blacks had firearms in their possession

Furthermore, its conclusion that "all the firing which took place after the mob broke away was directed against fugitives, that it was unnecessary, indiscriminate, and moreover brutal in its callousness, resulting in a terrible toll of killed and wounded without any sufficient reason or justification" was a strongly worded indictment of police actions.

While the commission's findings provoked justifications from certain quarters and recrimination from others, the Government itself impugned the integrity of the commission by allowing the publication of police statements exonerating themselves to be appended to the report tabled in Parliament.

At the second national conference of the ICU held in Cape Town in July, 1921, the delegates called on the Smuts Government to allow workers to commemorate October 23 as a national holiday

The request went unheeded and now, 66 years later, the events of that terrible day are all but forgotten

(132) 00 39/10/86
**Workers refused
passports by govt**

Dispatch Correspondent

PIETERMARITZBURG — Six BTR Sarmcol shop stewards' hopes of attending an international conference on labour in Brussels next week have been dashed following the refusal by the government to grant them passports

A spokesman for the Metal and Allied Workers Union (Mawu) said yesterday the shop stewards had planned to go to Europe to meet fellow trade unionists and BTR workers to discuss matters of mutual interest

"The tour included their giving evidence at a crucial international hearing under the European Economic Community's (EEC) auspices in Brussels on November 3 and November 4

"The hearing is being convened especially to evaluate the operations of BTR and Noordeutsche Affinerie in South Africa in relation to the EEC code of conduct and international law," the spokesman said

"Letters addressed to all six shop stewards from the Department of Home Affairs simply say 'I wish to advise that after consideration of the particulars furnished on your application I do not see my way clear to authorise the issue of a passport to you' "

The international hearings arise out of the mass dismissals of striking workers from BTR Sarmcol last year and Transvaal Alloys in 1984 and alleged "gross breaches" of the EEC code

Unions a fine example — manpower chief

DD 12/11/86

132

JOHANNESBURG — The labour scene is an area of relative peace and stability in a sea of unrest and turmoil because of the creation of union structures by, for and of the workers

So said the Manpower Department Director-General, Mr Piet van der Merwe, yesterday to a meeting of the South African-German Chamber of Commerce

Mr Van der Merwe said that what had been achieved in labour should serve as an example of what needed to be done in other fields

The union structures that had emerged were credible among workers because they were based on the principle

of freedom of association, he said. They also permitted the emergence of leaders who were credible because they were chosen by the workers. And those leaders have clout, so have succeeded in achieving important improvements in the working conditions of their members, Mr Van der Merwe said.

At the same time, employers could be thanked for their part in facilitating the expeditious establishment of effective channels of communication. And while industrial conflict was inevitable, they had largely succeeded in managing and resolving it

Further, the official dispute-resolving machinery had gained credibility and was used extensively

Another vital reason for the relative stability was that there had been a minimum amount of government interference in the employer-employee relationship, he said

However, Mr Van der Merwe identified some danger signs. The first was the increasing politicisation of the union movement. This trend would continue for as long as there was an absence of credible political organisations

Other problems included intimidation by

the minority on the majority during times of conflict, and the unemployment situation

Mr Van der Merwe also outlined the contents of the Labour Relations Amendment Bill due to be published for comment soon

They include enhancing the status and broadening the functions of the Industrial Court and the right of appeal decisions to the Supreme Court, a more precise definition of an unfair labour practice and guidelines of what constitutes an unfair dismissal, and removing ministerial discretion for the appointment of conciliation boards

20/1/68

Employers too kind to working addicts?

DD
(32)

Heavy drinkers and drug addicts cost employers huge sums through absenteeism, accidents and low productivity, but too few managers and trade unions face up to the problem, the International Labour Organisation says

Alcoholism tended to be high among seamen, lawyers, domestic servants, business executives, military men and police officers, an article by the ILO Information Service said.

Drug abuse was prevalent among long-distance lorry drivers, airline pilots, workers on mass production lines and also doctors and nurses who often had easy access to drugs, it added.

Estimates of the cost of lost production and damage due to alcoholism in the United States ranged from \$49 billion to \$120 billion, the ILO said

Yearly losses in industry in Canada were approximately \$7 600

million, and in Britain around \$1,5 billion. In Switzerland they were estimated at five million Swiss francs daily

"In far too many enterprises, however, management and unions still tend to adopt an ostrich approach concerning alcohol and drug abuse, and no organised or official attempt is made to acknowledge that the problem exists."

"The addict is eventually dismissed when he or she has become too great a liability, creating hardships for the individual, the family and society," the ILO said

Other employers in Europe and North America were finding that it was more beneficial to retain workers with drink or drug problems and try to overcome their addictions through prevention, counselling or rehabilitation programmes, it added —Sapa-RNS

132
WEEKLY NEWS
21/11/86

Memories fade fast as business turns cheerful

JUDGING from the Financial Mail's Investment Conference, coming as it does a week after the same community met the State President and his cabinet, South Africa's business community has a conveniently short memory.

Certainly the general mood as local business prepares for the good times seems completely inappropriate. Unfortunately for them such fickleness is not going to be to their advantage as many others, not least of all their workers, are unlikely to share such short memories.

Consider, as but one example, the address by General Motors (SA) MD Bob White, whose company this week had police remove strikers trying to prevent scabs from taking jobs, and then dismissed 219 workers who failed to respond to an ultimatum to return to work.

He made it clear, lest anyone be disturbed from their optimistic delusion that his discussion of business and social responsibility issues "must be restricted to the premise of business operating in a democratic society with a free-market economy." He added: "Yes, I do include South Africa in the democratic, free market economy category."

Worse still, White is considered one of the more enlightened members of our business community!

It is therefore not surprising that last week's economic summit was described by most participants as a success.

Reserve Bank Governor Gerhard de Kock set the optimistic tone at the Carlton Centre when he provided further evidence that the economy has started moving off its low base and should continue doing so in 1987. He estimates real gross domestic product (GDP) to grow around three percent for next year.

In the third quarter, it is now clear,

By ALEXANDER CAMARGUE

real GDP increased at an annual seasonally adjusted 3,5 percent, real gross domestic expenditure (GDE) increased by a massive 26 percent, real private consumption expenditure (PCE) was up 4,5 percent, real gross domestic fixed investment (GDFI) increased marginally and the annualised current account surplus dropped marginally to R5,8-billion from R6-billion in the second quarter.

The most "encouraging" figure is the marginal rise in GDFI — which is the type of structural investment the country desperately needs. But it must be emphasised that this is off an extremely low base and comes after four years of persistent decline.

It is far too early to assess whether this is a trend change. Certainly, judging from the latest money supply figures — which provisionally grew by a mere 9,5 percent in October (still way short of the bottom end of the official 16-20 percent target range) — and latest bank returns — BA9 forms submitted by banks to the Registrar of Banks show that in the third quarter total funds committed to HP were nearly five percent down from a year ago and total deposits were more than six percent higher — the rush to spend is far from on.

The huge rise in GDE should also be read with caution as it is historically a very volatile indicator.

One reason for the increase is the reversal of drawing down inventories (another factor was the 4,5 percent increase in PCE) which probably indicates a stockpiling of imports ahead of sanctions, thus exaggerating the sudden upsurge (imports increased 32 percent in the third quarter).

Next year's expected growth is based on an anticipated increase in government and consumption expenditure, restocking, a slowdown in the decline of investment, a better agricultural performance and a higher gold price.

While it is generally agreed that the economy will grow by some three percent next year, this does not mean that significantly more jobs will be generated.

A growth rate of four to five percent is needed to merely absorb those coming onto the labour market. With unemployment estimates running higher than six million and the living standards of those with jobs badly eroded, three percent real GDP off a low base becomes virtually meaningless.

Then it must be asked how long this upturn will last. There are plenty of problems ahead — severe inflation and balance of payment constraints, the country still suffers from a "paradox of thrift" (despite low interest rates, savings are increasing while badly needed investment is hardly taking place) and consumers' willingness to spend on a sustained basis is still to be proved. This is not to mention the increasing pressure that local companies face in international markets nor the domestic socio-political mess.

While business confidence picks up, most people will not even be aware the economy is improving. It is making precious little difference to their daily lives — nor is next year's anticipated growth likely to.

Such an exercise in self-deception would not be so serious were it not that many lives are affected by such gross ignorance and insensitivity.

These workers commute for 5 hours each day

By MIKE MABUSELA

ALICEDALE commuters to Port Elizabeth spend nearly five hours in trains every day, travelling a total of 226 kilometres

Most workers wake at about 2 30am and catch the 3 30am train at Alicedale station after a walk of about 20 minutes

They have little time to eat, but early morning tea and sandwiches are available on the train, as I discovered when I did the trip last Monday

The afternoon train passing through Alicedale to Johannesburg leaves PE station at 5pm and arrives at Alicedale at 6 40pm

I spent the night with a friend in Alicedale, to be on time for the 3 30am train used by commuters, which arrives at the PE station at 6 30am

Alicedale commuters interviewed in the train refused to be photographed for reasons they did not disclose

Mr Mtiwandile Ndoda, 40 — the only man who gave his name — said he supported his wife and seven children. His salary is R800 a month and he travels on a R148 monthly train ticket — the cheapest way to reach his place of employment

He said he preferred to live with his family in Alicedale, his home town, and work in PE because there were no good paying jobs in the village

Commuters said they preferred to live in Alicedale because it was a quiet country town "with no riots and no stayaways"

They were a small community living like a big family and their children were able to attend school

Those with cars chose not to use them as the train was cheaper. They said the R148 cost of a monthly ticket was much cheaper than the R30 people spent on petrol for each return trip.

SATS employees received concessions which gave them a fair discount, they said

Although commuters can travel in the first, second or third class carriages, they preferred the economy class (third class), which was cheaper

I found the water fresh when I sipped a glass, although the train had started its journey in Johannesburg

There was no problem of any kind when I sat down in the dining saloon to have a cup of tea

I was told that the saloon, which has a bar, is open to all races and orders are also taken from all the compartments

The compartments needed sweeping, but then of course it was the last leg of the long run from the Rand

A spokesman for SATS in PE said its employees in the Cape Midlands, as in all other regions, obviously had a free choice of residence

Those who preferred to live in the rural areas had to organise their own transport

If they chose to use the local train service, a choice open to any member of the public, they qualified for a reasonable concessionary travel allowance. The did not to give figures

Keeping industry governable



Grinaker group manpower consultant Theo Heffer is one of SA's most respected industrial relations practitioners. He argues that businessmen can have a positive influence on social change

by entering into negotiations with trade unions on social as well as workplace issues.

" unless industry is to be paralysed by recurrent revolts on the part of outraged human nature, it must satisfy criteria which are not purely economic " — R H Tawney, 1926

Developments in industrial relations are never divorced from society at large. For this reason, changes in labour policy and legislation introduced since 1979 have provided commerce and industry with the opportunity to make a real contribution to SA's socio-political future.

This opportunity — and the accompanying great responsibility — rests mainly with management, the dominant party in employment relations in South Africa, which are characterised by an unhealthy imbalance in power and influence.

Of course, interaction between industrial society and the wider society works both ways. So, for example, absence of any effective political means of institutionalising social conflict must inevitably lead to increased political activity on the part of organised labour. This has been clearly evident in SA in recent years.

My concern is that employers are at present not influencing change in the wider society as much as they are being influenced by the lack of real change in the socio-political arena. If there is to be a voluntary transition to a new South African society — as opposed to the overthrow or collapse of the regime — it must be initiated by those who dominate the power relationship and be accompanied by real negotiation. It is here that business can show the way as agents of change and exert a constructive influence in the wider society.

The real negotiation I speak of presup-

poses that *people must be allowed to choose freely which organisations they wish to join or form, and to whom or what they will show allegiance*. Such freedom is far from established in the political arena, and recent developments only indicate its increasing denial. This denial of freedom leads to its only alternative — a vicious circle of coercion and co-option.

The key question now facing decision-makers in business is whether this pattern of coercion and co-option will be reflected in industrial relations, or whether they will encourage and take part in real negotiation. It is important to remember that agreement to negotiate is not the same as agreement to agree, lest confusion about the consequences leads us to make the wrong choice at the outset.

It is necessary to briefly examine how the vicious circle of coercion and co-option arises. When free and independent choice, representation and expression is denied — or even limited — the dominant party in the relationship must resort to a measure of force, or coercion, to preserve the status quo, or at best to allow only the changes it chooses. Power is used to impose values on people which they do not freely accept, and in true paternalistic fashion this is said to be for their benefit. An attempt is made to justify coercion, but the justification itself is based on a lie.

Then, in order to rationalise the coercion, the coercer moves to co-option so as to display a semblance of free choice and expression. This is accompanied by all sorts of rhetorical noises and doublespeak.

Inevitably, however, the co-opted are seen to be facilitating the continued denial of free and independent choice and are labelled "sellouts" (Soweto's Ntatho Motlana defined "sellout" on these lines when giving evidence in the Supreme Court last year). This leads to violence and the further use of force, as "law and order must be maintained". This process can occur in business as well as in the wider society.

Only real negotiation between free and independent parties can break the vicious circle of coercion and co-option. When authority is legitimised by free and independent parties, it need not be maintained by

coercion.

This has been the experience of companies which have institutionalised industrial conflict through fully recognising the legitimacy of the other party and entering into recognition agreements with representative trade unions. Such agreements have been especially valuable in introducing democratic processes where the *independence* of the parties has been given equal standing with their *interdependence*. The process involves willingness to consider and be influenced by the other party's views and arguments, commitment to compromise in spite of seemingly irreconcilable differences, and disclosure of any information relevant to the issues being negotiated.

National level

Employers need to work towards extending this bilateral self-governance above the plant and company level to group or corporate level and, through their organisations, to industry and national level. Statements by businessmen on socio-political issues are unlikely to rise above the level of rhetorical noise while they remain unilateral statements unrelated to real negotiation. For quite clearly the private sector consists of both organised labour and employers.

Unilateral social responsibility efforts by management remain paternalistic and are ineffectual in contributing to progress. Management efforts to impose values on workers unilaterally will not only fail, but will prove counter-productive — especially where they are aimed at preserving without change our present economic system.

Management must create opportunities and structures for organised labour to meet with organised business to identify the nature of the issues at stake, to clarify and debate them, and to formulate joint values to govern their relationship and make joint proposals or recommendations to government. There is nothing to prevent the parties at employer association and trade union federation level from voluntarily entering into negotiation on socio-political as well as economic issues. How else will industry remain governable? How else will we find solutions which go beyond the next balance sheet to the next generation?

INDUST. REL. Employers' Organisations

1986

JAN - DEC

much as R17/t.

RBCT exports will stay at around 40 Mt this year, although users had hoped the Brownfields phase would be completed by 1994. This suggests export growth of around 6% a year. This plan may, however, have been brought into question by the uncertain outlook for coal exports because of the chilly political climate (*Business* December 6). The reduced export capacity means that Phase 4 users will have to recalculate their tonnages.

A final settlement is still to be reached, admits Tew, but negotiators appear to be in no hurry. ■

SHIP REPAIR

Staying afloat

The weak rand has provided local ship repair yards with an unexpected fillip. Last year, for instance, three Durban ship repairers collectively turned over R30m — making it one of their busiest periods in recent history.

The exchange rate benefits come in two main forms. Firstly, foreign ship owners are finding it cheaper to have their layovers and repairs done in South African ports, and, secondly, the export boom has seen port tonnages rise dramatically, ensuring a con-

stant turnaround in vessels.

Typically, though, business at SA ports is patchy. Durban, where export tonnages have risen about 25% in the past 12 months, has a full order book while business in Cape Town and Port Elizabeth, which are more import/repair-orientated ports, is flat.

There are other factors assisting the flow of work to Durban repairers. Yards in Singapore, SA's principal competitor, are feeling the full blast of the recession in the shipping industry. Some have lost 39% of their foreign business and others have closed. One yard, Keppel, has negotiated a wage freeze with its workforce in return for keeping employment

RAYMOND PARSONS

Keeping up with the changes

IN MY
OPINION



As CE of the Association of Chambers of Commerce of SA, Raymond Parsons is in close touch with a wide cross-section of South African business. He gives his opinion of the local scene on the eve of what promises to be a critical session of Parliament.

Businessmen in SA have never felt that they have been looking at a static political situation. They are naturally and vitally interested in all issues that affect stability since this is important to the environment within which they have to take decisions. In the South African situation, business has always been opposed to racial discrimination and has frequently urged the need for reform.

The business sector, for example, played a key role in the implementation of the new labour dispensation in SA towards the end of the Seventies which gave black workers formal collective bargaining rights, removed the colour bar from industry and commerce, and generally strengthened the power of blacks on the labour market. Quite clearly, though, this was only one important stage in an evolutionary process of change.

The present State President, P W Botha, committed himself, on taking office in 1978, to further economic and political change. A great deal has happened in SA since then, and it is only fair to list some of the changes which have taken place while he has been at the head of affairs. These include

- The development of full black trade union rights,
- The recognition of the permanence of urban blacks,
- The introduction of freehold title for blacks in urban areas,
- The evolution of black business rights,
- The modification of influx control,
- The scrapping of the Prohibition of Political Interference Act, the Mixed Marriages

Act, and the relevant provisions of the Immorality Act,

- The concept of a universal franchise and common citizenship, and
- A commitment to negotiate black political participation up to the highest level to widen and deepen democracy.

There may well still be much to criticise in SA. But one thing must be said: there has been more change in SA in the past five years than in the previous 50. It has acquired a dynamic of its own. There is a jocular saying: "To improve is to change, to be perfect is to have changed often." It is hard to believe that one is living in the same SA of five or 10 years ago.

And so one could go on. All this has added up to a groundswell of calls for further peaceful change which far exceeds the forces of violence demanding change, and in which South African business — white and black, English-speaking and Afrikaans-speaking, local and foreign — have been playing a very important part. Economic realities, after all, have also been dictating the pace of reform in SA. What business in SA is currently trying to do is to expand and hasten the reform process.

Economic growth would also more readily accommodate an expanding provision of services such as education, health and housing, which are necessary to correct the historical deprivation of black communities. Those who advocate economic sanctions against SA seek to weaken the reform process in ways which harm the very people who ought to be helped. I believe they support economic sanctions because they realise that rapid economic growth does possess the greatest non-revolutionary potential for eliminating racial income inequalities in SA.

And very little thought has been given to the implications for southern Africa if economic sanction against SA were to be successfully applied.

Other countries in southern Africa should be under no misapprehension as to the consequences for them of successful economic

sanctions against SA. What would be a pinprick to SA would be a whiplash for them. And I did not gain the impression in official circles overseas that the US or Britain would be willing to provide foreign aid to compensate for the damage caused to neighbouring states by economic sanctions against SA.

Perhaps the single most important question currently being advocated by business in SA — and which has aroused great interest abroad — is the need for real political negotiation to begin between black and white leaders. The purpose of this would be to begin to negotiate new political structures and a constitution which would give blacks greater political rights in SA right up to the highest level. Not only is business trying to create a climate of opinion which would promote such talks, but we have also produced serious studies of what constitutional options are open to the country.

Business does not govern South or southern Africa, but it certainly can help to keep it governable.

It is important for people outside SA to understand that it is not an either/or situation. That is certainly what radical opinion would like us to believe, since it wishes to polarise views in SA. This is still a country with multiple options — options that will have to be discussed when black and white political leadership begin serious negotiations. However, it is important to recognise that options tend to dissolve if not exercised timeously.

A recent statement by the State President suggests that the government is also treating the preparation of constitutional options urgently, and is seeking to do so in ways which do not pre-empt any subsequent political negotiations.

The next parliamentary session will be crucial to perceptions abroad and in SA about the pace and extent of reform. I have told SA-watchers abroad to study the first few months of 1986 very carefully, as a great deal may happen on the reform front once Parliament re-opens.

FM 24/1/86

condemned him in 1982 as being financed by Pretoria with the aim of destabilising the Jonathan regime. Past indications, notably an admission by former Deputy Minister of Land Affairs Hennie van der Walt in 1982, are that Mokhele would be prepared to sign a pact with SA

Assuming that Lekhanya, having restored order among the armed factions, calls elections and a somewhat socialist-leaning Mokhele emerges triumphant (which is not necessarily inevitable), little is likely to change from SA's point of view. Lesotho's economic dependence on SA will remain. From its membership of the South African Customs Union comes 70% of the country's national revenue. Basotho miners employed on South African mines (40% of the country's male population and the most productive segment) earn Lesotho half its gnp (about R1 billion) in remittances from SA.

Furthermore, Lesotho's joint development with SA of the Highlands Water Scheme is regarded as valuable enough to both not to jeopardise it in the event of any party — of whatever political stripe — coming to power. The scheme is set to double Lesotho's income once it is operational in 20 years' time

Lekhanya had not (as the FM went to press) spelled out the course he will follow.

Yet his conservative leanings, closeness to King Moshoeshoe, and concern at the devastating prospects of a prolonged South African border squeeze, evidently propelled him to remove the intransigent Jonathan (see box)

Jonathan's political demise was precipitated by SA's choking of the country's vital supply lines. After less than a month, this form of South African pressure demonstrated Lesotho's utter dependence on SA. The effective economic blockade thus seems to have proved a more potent weapon than cross-border attacks in clamping down on the ANC. This assumes, of course, that the new authority in Lesotho and Pretoria are able to work out a way of monitoring refugees from SA, who last year entered Lesotho at a rate of 50 a month.

The events leading up to last Sunday night's relatively quiet ousting of Jonathan are still far from clear. Four days after apparently trying to prevail upon Jonathan to change his stance against SA's demands to expel ANC refugees, Lekhanya acted

It seems that Lekhanya put his foot down after becoming "fed up," as one ambassador in Maseru put it, at Jonathan's lack of response to the concern he had communicated to the PM earlier this year about the increas-

ingly tense situation in the country. The Youth League of the ruling BNP, whose first loyalty was essentially to Jonathan, appear to have alienated many people by "throwing their weight around"

What was initially reported as a "coup" a week ago — when Lekhanya's men surrounded Jonathan's office in downtown Maseru — seems in fact to have been the general's ultimatum to Jonathan to reign in and disarm the Youth League and to deal with Pretoria. Lekhanya, according to one account, took the PM to the King and explained that his loyalty was first to Moshoeshoe, and not necessarily to Jonathan

Just what kind of role Moshoeshoe, whom Lekhanya named Head of State, will play remains to be seen. Moshoeshoe is linked to the royalist Marematlou Freedom Party, which is not regarded as a force in the land. In 1970, Marematlou won only two seats. Like Lesotho's electorate — which has the highest literacy rate in black Africa — the king has been on a enforced political holiday for 20 years, since signing a virtual declaration of abdication in 1966

At any rate, it will be interesting to see whether the king shaves his beard, which he vowed not to until such time as Lesotho was returned to constitutional government

THE FCI CHARTER

Visionary, but...

Handwritten scribbles and the number 133 in a circle.

"Words, words, words," said Hamlet when asked what he read. For some time the business community has made its views known on reform — that negotiation with accepted black leaders must begin, influx control must go, as well as group areas and the whole shooting match

The latest initiative is the Federated Chamber of Industries' (FCI's) Charter of Social, Economic and Political Rights, and the supporting Action Programme of South African Business. Do these documents contribute towards a solution of our difficulties, are they the Magna Carta of reform the FCI believes them to be — or just more words?

The FCI's Charter of Social, Economic and Political Rights has a magisterial ring. But it is far less convincing on detail and may err through being too ambitious in scope.

We have certainly come a long way from the heady, if puzzling, days of the Carlton and Good Hope conferences when business was asked by P W Botha (then Prime Minister) to stand by him in reform. Some, indeed, asked then what precisely does he mean? Well, as it turned out, essentially a loosening-up of the informal sector and the pass system, freehold for blacks, the eradication of the race-sex laws — and, alas, decentralisation. Everyone hopes for more

All this is trite. The real question is whether business can play the role of facilitator (as psychiatrist Carl Rogers would put it) in the current political ferment. There have certainly been significant entries into the political arena by various groups, sometimes alone, sometimes in concert

We have seen major businessmen urging swifter reform on President Botha. Some have trekked to Lusaka to meet the banned and exiled African National Congress (ANC). And — in its quiet way — perhaps one of the most important developments has

been the formation of the Private Sector Council on Urbanisation

The council comprises representatives of the Association of Chambers of Commerce (Assocom), the Afrikaanse Handelsinstituut (AHI), the FCI, the National African Federated Chamber of Commerce (Nafcoc), and the Urban Foundation (UF). In summary, its stated goals include

- A parliamentary commitment by government to remove influx control,
- An immediate end to shack demolitions, forced removals, and freezes on city growth;
- Acceleration of the acquisition and servicing of land at affordable prices,



Confrontation brings chaos



Conciliation creates wealth

(MO) (AB) (BREA)

A PROGRAMME FOR JUSTICE

The FCI's Charter of Social, Economic and Political Rights, with the accompanying Action Programme for South African Business, consolidate most existing reform suggestions. A basic perception is that no serious political bargaining can begin "until all parties are convinced that government is willing to negotiate a new constitutional dispensation based on power-sharing up to the highest level"

To get there, according to the Action Programme, "a fundamental requirement is to create rapidly and urgently a climate for negotiation and a generally accepted framework within which such negotiation can occur" The role of business will be that of facilitator, urging a new urbanisation strategy, privatisation and deregulation, opening the economy to all, and the elimination of social barriers based on race.

With that, it calls for:

- An undertaking by government to abolish statutory race discrimination in all legislation;
- The restoration of a common South African citizenship;
- The abolition of specific laws such as influx control and the Group Areas Act;
- Lifting the State of Emergency;
- A return to the basic norms of South African common law, thus re-affirming the rule of law; and
- The release of political prisoners from

detention

In the short term, the Action Programme calls for a "moderate stimulation of the economy . . . to absorb excess capacity and to expand investment The emphasis should fall on lower interest rates interlinked with a supply-side approach involving a cut in direct taxation and curbs on the share of government in the total economy to create the scope and incentive for private entrepreneurship."

The Charter itself sets out the basic philosophical premises on which the Action Programme is to be based. It covers the areas of human rights in these categories social and cultural, economic; civil and political, and personal and public responsibilities.

Space precludes giving full details, but the following statements are typical:

- All human beings are born free and equal in dignity and rights;
- Everyone has the right to respect for his private and family life; and the widest possible protection and assistance should be afforded to the family, which is the natural and fundamental group in society,
- Everyone has the right to freedom of thought, conscience, and religion. . . ;
- Everyone has the right to equal educational opportunities . . .
- Persons belonging to ethnic, religious or linguistic minorities shall not be denied

the right to enjoy their own culture, to profess and practise their own religion, and to use their own language,

- Everyone has the right freely to employ labour and to own or manage a business . . . ;
- Everyone has the right to work and to free choice of employment,
- No one shall be subjected to arbitrary arrest, detention or exile, and everyone shall be entitled to a fair and public hearing by an independent and impartial tribunal in the determination of his rights and of any obligations and of any criminal charges against him;
- No one shall be subjected to torture or to cruel, inhuman or degrading treatment or punishment;
- Everyone born in SA or the independent or national states . . . has the right to South African citizenship,
- Due regard being given to the protection of the rights of minorities, the will of the people is the basis of the authority of the government, and this shall be expressed by way of periodic and genuine elections which shall be by universal suffrage and shall be held by secret vote or by equivalent free voting procedures, and
- SA, as a sovereign state, shall respect the rights and independence of all nations and shall strive to maintain world peace and the settlement of all international disputes by negotiation, not war.

- Plans to increase the population density of existing townships "in formal and informal ways;"
- Deregulation of the informal sector;
- A reconsideration of industrial decentralisation; and
- Reconsideration of the 1913 and 1936 Land Acts

These are practical and considered suggestions It is against this and similar private-sector initiatives that the FCI Charter and Action Programme must be measured. It must also be asked why the FCI was unable to get other employer bodies and the UF to initial what are in many respects libertarian and bold documents (see box)

The AHI is brief "No comment at this stage"

Assocom's Raymond Parsons is somewhat more forthcoming "Assocom broadly supports the basic theme of the FCI Business Charter and its emphasis on continued business involvement in the reform process, but the details will have to be further studied . . .

"A few months ago Assocom published its own view of future constitutional options in SA — the so-called Lombard Memorandum a document which embodies many of the sentiments contained in the latest Business Charter (We) therefore believe there is common ground between Assocom and FCI perceptions of where the business community ought to stand on questions of political and economic reform The Assocom executive council will in due course give careful consideration to the FCI Charter"

A cautious response, to say the least — particularly since the *FM* understands that the Charter has been available in select circles for several months

Perhaps part of the FCI Charter's problem is that it is at once visionary, in search of the millenium as it were, and yet, in practical detail, not sufficiently instructive To call for one-man-one-vote (inevitably in a unitary state, it would seem, given the lofty principles of the Charter) as well as for the safeguarding of minority ethnic rights (Pretoria's bottom line) is actually impossible to implement at present

The pleas for the restoration of the rule of law, abolition of influx control and group areas legislation, freehold now, common citizenship — these have *already* been articulated, and in greater detail and depth, by the various business groups, either singly or, as we said, in concert

It seems, in many respects, that the Charter and Action Programme represent an attempt to lay the basis for a new constitution That is asking for the moon in the current climate of terror bombs and repression Nonetheless, because the FCI is a major and influential business body, the papers will heighten awareness of the degree to which business as a whole is looking for a way out of our economic and political mess



FCI leaders unveil Charter . . . sincere initiative

24/1/86

(223)

133

(305A)

FM

That is welcome

To secure a climate in which serious negotiation on power-sharing at central level can take place without acrimony is an enormous task. It is one in which business is not alone in seeking to play a mediatory role. The various churches, opposition parties, and even the press are doing their best in a bad, and some would say mad, world.

Business, as the FCI indicates, does have an edge in one respect. This is that employees participated in the changes in the labour field after the Wiehahn reports — the mass unionisation of blacks in legal structures. The relative stability in the factories and mines involved a learning process by both labour and management. It worked because the unions were able to deliver real gains to their members.

Is there, however, any such thing as a Wiehahn report, so to speak, on reform? Perhaps the FCI's Charter seeks to be just that — and it can't be, since it is weak in ways and means, which Wiehahn was not.

Again, the Charter best known to blacks is the socialist Freedom Charter. While many will endorse many of the sentiments in the FCI Charter, there is a long row to hoe by way of persuasion. Not to speak of getting government to see the sense of much that it contains.

It is not improbable, in fact, that change will come from the local level first, rather than from, say, a national convention — which is not to say that that route should not be actively pursued, since it makes sense and is, in the long run, probably inevitable, and revolution remote.

However, at present, black groups are divided and could not form a common front for negotiation even if government was to seriously take such a reconciliatory step. As an astute analysis of black politics (see *Current Affairs*) points out, most gains made by blacks since turmoil began in the Vaal Triangle townships on September 3 1984 have been at local level, through local negotiation.

The FCI Charter does not recognise this,

or the diversity of black political organisation, or even the essential intransigence of government. Instead it goes out of its way to praise government for the reforms it has made, which is fair enough except that government is not going to accede to one-man-one-vote in a unitary state, "not today and not tomorrow," as Mr Botha might say.

If, therefore, the release of the papers was designed to pre-empt a Rubicon 2 — which some fear will be delivered when Parliament resumes at the end of the month — it won't. It could in fact have the opposite effect: raising impossible expectations again.

Nonetheless, the FCI Charter is clearly a sincere and challenging initiative. We welcome it as such. We are sure that while other employer bodies have chosen not to endorse it in full, they agree with many aspects. Indeed, through such bodies as the Council on Urbanisation (with its FCI representation), they are in the process of both mediation and grassroots reform. One step at a time, as they say. ■

METROPOLITAN LIFE

Playing with the big boys

There's a familiar ring about it: a life company starts talking about a JSE listing; the press is summoned to an aseptic boardroom, where eloquent executives provide an impressive record of past performance; and another low-profiled insurer is propelled into the investing public's minds.

It happened twice last year, when Southern Life and Crusader Life moved toward listing, and it will happen at least twice more this year, when Metropolitan Life (Metpol) and Legal & General Volkskas (renamed Lifegro) go the same route.

The latest, Metpol, is an interesting listing and rather a large one. Rated among the 10 largest insurers in SA, with assets approaching R1 billion, it intends listing 43.2m shares of which 15m will be issued in the public offer at 315c, implying total market capitalisation of R136,1m. Unlike other listed life companies, which deal mainly in the middle-to-upper end of the insurance market, Metpol has a heavy bias towards lower income groups, and is active mainly in black and coloured markets.

After the issue Metpol, now a wholly-owned subsidiary of Sankorp/Sanlam, will be held 65% by Sankorp/Sanlam, and 35% by the public.

With the shares of Liberty, Southern and the Prudential all having around 3% historical yield, Metpol has pitched its issue on a relatively safe 4.4% forward yield. The margin, mind you, is somewhat thin, and although staggering profits of around 20% seem assured, they are unlikely to match the hefty gains of the Southern issue.

One may reasonably ask whether

Metropolitan Life (Metpol) operates in a relatively risky area of the insurance market, dealing in fairly cheap policies with high marginal costs. But the company believes its earnings and dividend record over the past five years speaks for itself, and that performance will be right up there with the industry heavyweights.

Metpol deserves to be rated with the likes of Liberty or Southern. After all, it operates in a relatively high-risk niche of the market, where lapses can be excessive; and,

FILLING ITS COFFERS

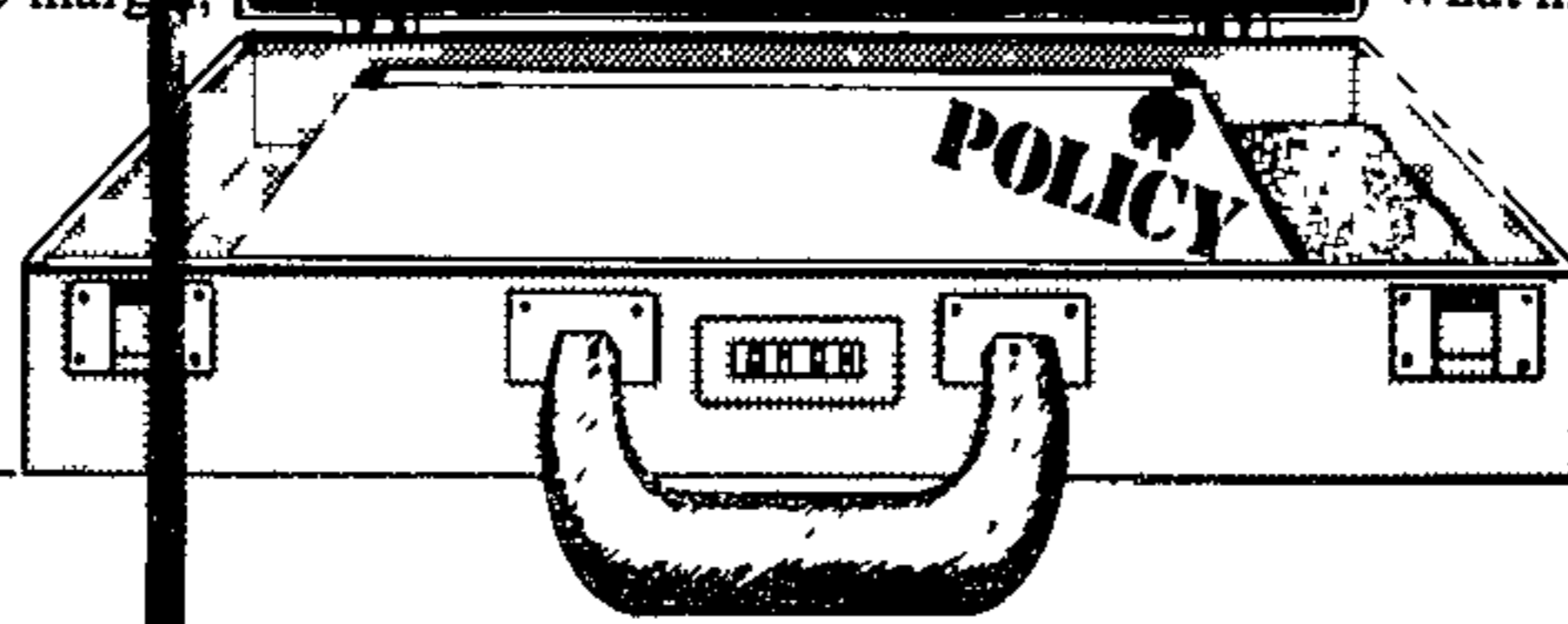
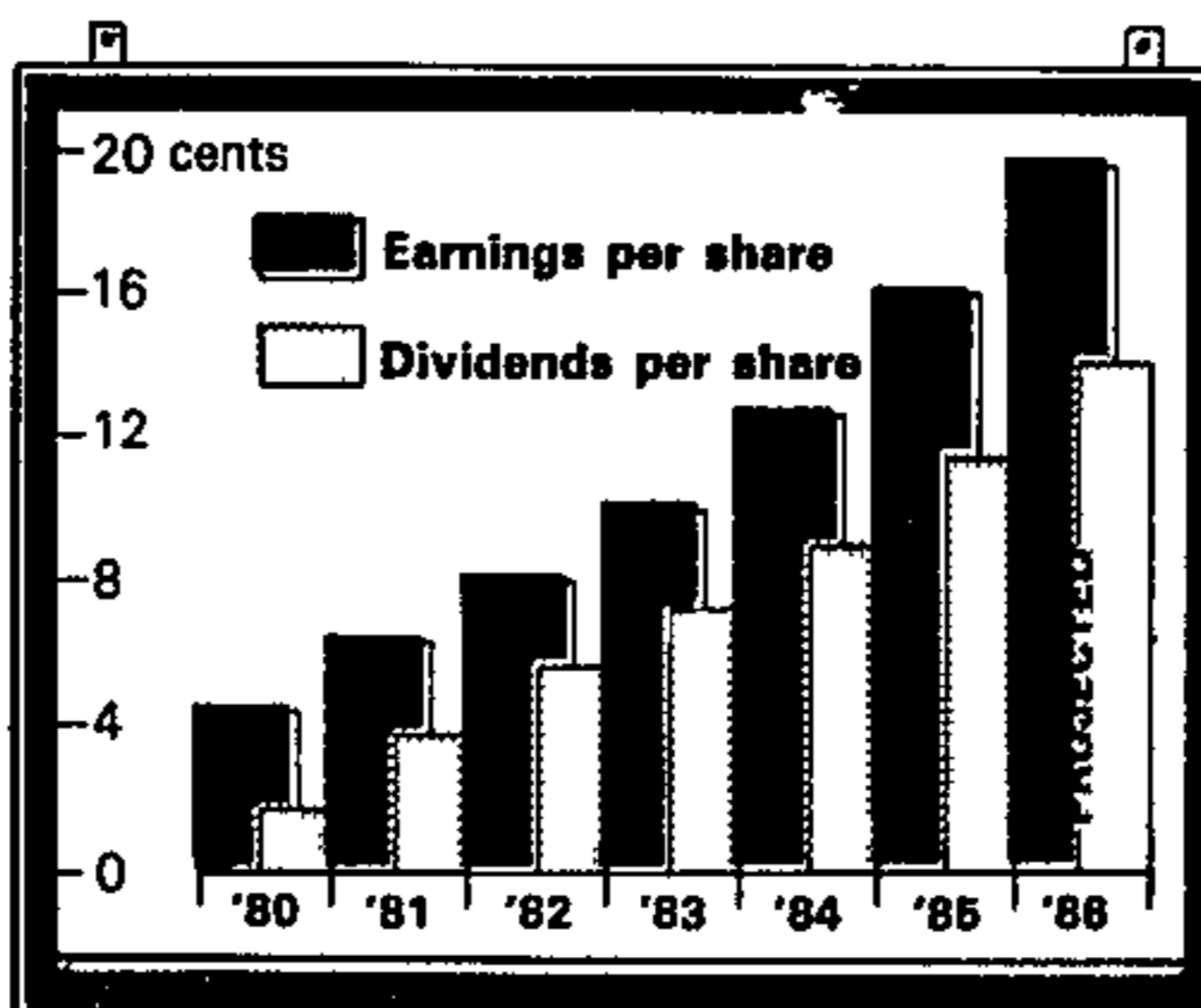

because it deals in cheaper policies, marginal costs are fairly high.

MD Willem Pretorius believes his company justifies a rating on par with the industry giants. He argues that "Every insurance company, including us, builds into its insurance premiums components for risk, profits and costs."

"As long as our actuary correctly projects costs and policy lapse trends, Metpol can trade as profitably as the best; the fact that we are somewhat downmarket makes no difference," Pretorius adds. To support his contention, he points to Metpol's earnings and dividend record over the past five years, which, indeed, is as impressive as those of any of the industry high-flyers.

It is no coincidence that life companies have been queuing up to be listed. Although they tend to justify a need for new capital by referring to "new business strain" and the need for aggressive expansion, I believe other reasons may lie behind their sudden affection for the JSE.

Put simply, economic factors have seldom so favoured an insurer seeking a listing. Faced with a tide of cash inflow, fed to them by a public increasingly predisposed towards life cover, insurance companies have become efficient investors. Investment returns achieved by companies like Metpol are consistently high, invariably outpacing inflation.

What makes a new capital issue so attractive now is that, with interest rates at high levels, the cost of raising additional funds is a mere fraction of their potential re-invested returns.

In January 1983, for example, an insurer seeking a listing would

Company-level bargaining at issue

BUS DAY

Seifsa declares historic dispute with 4 unions

14/2/86

140h

189

133

SEIFSA has taken an unprecedented step in recent labour history by declaring a dispute with four unions affiliated to the SA council for the International Metalworkers' Federation (IMF).

The employer body says it is declaring a dispute because employer organisations in the metal industry have given a commitment to negotiating at industry level on establishing future collective bargaining arrangements.

This commitment includes discussing union demands for bargaining at plant and company level.

At the same time one IMF union, the Metal and Allied Workers' Union (Mawu) is seeking, through dispute action, to persuade individual Seifsa members to negotiate on this issue at company level, Seifsa says.

Mawu is in dispute with more than 50 employers over their refusal to consent to company-level bargaining on issues now set at industry level.

Seifsa believes the IMF unions are seeking to make gains outside the agreed negotiating forum, before industry-level negotiations, scheduled for February 26, have begun.

"This places employers in the situation where they cannot meet their commitments to negotiate in a fair and proper manner. Seifsa believes the IMF affiliates, in these actions,

CLAIRE PICKARD-CAMBRIDGE

are undermining the collective bargaining process," Seifsa says.

The unions Seifsa is in dispute with are the Mawu, SA Boilermakers' Society, Engineering Industrial Workers' Union and the Steel, Engineering and Allied Workers' Union.

Seifsa says the four unions have been acting under the umbrella of the local council of the IMF.

General-secretary of the SA council of the IMF Brian Fredericks said yesterday the IMF unions would examine the situation and decide today what strategy to adopt.

He said the IMF unions supported Mawu in its ongoing struggle for plant and company level bargaining.

Seifsa's declaration of a dispute comes as a member company, ASEA Electric, faces a strike in demand of company-level bargaining at four of its plants in Pretoria and Rosslyn.

The strike began on Monday and a Supreme Court interdict was granted on Wednesday restraining Mawu members from "overnighting" on company premises or intimidating fellow workers.

Seifsa has asked Mawu to defer disputes it has declared with employers in the industry over company-level bargaining, until discussions on the matter have been held at industry level.

Longer hours split unions and commerce

ORGANISED commerce in the Transvaal unreservedly welcomes expanded shop hours but unions are angry at the "callous" disregard for their total opposition to the move.

The amended shop hours ordinance, which permits trading from 5am to 11.30pm, was passed by the Provincial Council this week.

National Union of Distributive and Allied Workers (Nudaw) general secretary, Dulcie Hartwell, told *Business Day* from Cape Town yesterday that "the forces ranged against us were just too strong — employer organisations, chambers of commerce, the Association of Chambers of Commerce, and provincial councillors".

than disadvantages. CBD Association chairman Nigel Mandy said, while shops might be chasing the same money, they would be providing a customer service. He pointed out that flexible hours did not mean longer hours.

Some smaller shopowners also opposed extended shopping hours. Their position was already threatened by the "big boys", and when they were forced to stay open beyond normal hours to compete, their financial plight would become even more serious.

Asked whether she planned any further protest, Hartwell said little could be done with unemployment already high.

Johannesburg Chamber of Commerce, Hillbrow Traders' Association and the Central Business District Association have welcomed the move, saying there were more advantages

for a long time. The Small Business Development Corporation said it "noted with approval that shopping hours in the Transvaal will in future be less restrictive".

GERALD REILLY, PETER WALLINGTON and CLAIRE PICKARD-CAMBRIDGE

Business Day weather

AIRLINE MOVEMENTS

Friday Air Schedule	1730	1905	SA429
Johannesburg to Cape Town	1745	1920	SA433



BUSINESS CLUBS

Because you deserve more WE RENT MAZDA AND OTHER FINE CARS

HUNT LASCARIS TBWA 8604170

Borrowing capacity
 Borrowing powers in terms of most restrictive limitation
 Borrowings
 Unused borrowing capacity

War of words starts between Seifsa, unions

1912/86 SOKJETAN

THE battle of words has already started between trade unions in the metal industries and employers before the parties meet to discuss vital issues affecting the 300 000 workers in the industry.

The Steel Engineering Industries Federation of South Africa (Seifsa), which represents employers, has declared a dispute with four trade unions affiliated to the International Metalworkers Federation (IMF).

Seifsa said one of the unions concerned was seeking, through dispute action, to persuade individual employers who were its members to negotiate issues at the shop floor level.

However, IMF's secretary Mr Brian Fredericks has accused employers of playing a game in trying to resist proposals their unions have made concerning collective bargaining in the industry.

The talks take place this week.

CUSA

• The Council of Unions of South Africa's (Cusa) joint executive committee met at the weekend and made important decisions on the future of the federation. Cusa's president Mr James Mndaweni said they did not like to release details of the meeting at this stage.

• Cusa and the Azanian Confederation of Trade Unions (Azactu) meet again on Sunday to discuss various issues, including examining common ground for future co-operation.

• The Black Domestic Workers' Association is to hold an important

WORKERS' DIARY — By JOSHUA RABOROKO

meeting in Soweto on Sunday. BDWA's general secretary Mr Terrence Phiri says this meeting will cover matters such as exploitation of members by employers, possible legal action against some employers and further relationships with other organisations.

Members are urged to attend

NUM

• A seminar on effective negotiation is to be held in Johannesburg, starting on February 25. Speakers include National Union of Mineworkers (NUM)'s general secretary Mr Cyril Ramaphosa, University of South Africa's Professor Nic Wiehahn, *City Press* editor, Mr Percy Qoboza, African Bank's Mr Moses Maubane and experts on labour.

• The Minister of Manpower, Mr P T C du Plessis, is to talk at a ceremony where awards will be made to top 15 qualifying artisans of 1985. The occasion will be held at the Wanderers Club next Wednesday.

• About 90 employees who downed tools after the alleged assault on a worker by a supervisor at a factory in Jacobs have resumed work. The president of South African Allied Workers' Union, Mr Ashley

Shezi, said the workers went back after management had met the workers' committee and promised a subsequent meeting with the workers soon.

• The Industrial Court judgment finding Natal Die Casting Company guilty of an unfair labour practice has been sent for review to the Supreme Court. A company spokesman said an application has been made and the company will not reinstate the sacked 112 workers pending the Supreme Court's decision.

Inquest

• The inquest into the death of leading trade unionist, Mr Andries Raditsela resumes in the Johannesburg Magistrate's Court next Monday.

• The strained relationship between retailers OK Bazaar and the Commercial Catering and Allied Workers' Union will be normalised soon.

The company applied for an urgent Supreme Court order restraining the union from organising a nationwide strike. In reply to the court action the union denied that it intended to call a national strike.

• Members of the Black Health and Allied Workers' Union who went on strike at E J Atcock Pharmaceutical company in

Krugersdorp have returned to work after management agreed to reinstate their colleague.

• The African Miners and Allied Workers' Union is to join either the Cusa or Azactu, the union's general secretary, Mr Vuyani Madolo, announced this week.

Mr Madolo said this resolution was taken at a special meeting of the union. For a long time they felt they should affiliate to one of the two federations.



CUSA's president Mr James Mndaweni.



MANPOWER Minister, Mr P T C du Plessis ... to talk at ceremony.

Time off for May Day ^{Cape Town} _{23/4/46} stayaway

Staff Reporter

BUSINESS organizations are adopting an attitude of qualified sympathy to worker plans to observe Labour Day on May 1

The latest Cape Town Chamber of Commerce bulletin advises employers to treat "sympathetically" requests for time off to observe May Day. However, time off should be given on the basis of "no work — no pay — no disciplinary action"

The bulletin says the chamber supports a review of public holidays to allow the inclusion of a holiday acceptable to organized labour. But if May Day becomes a holiday, an existing holiday should be abolished "so that the total number of public holidays during the year would not be increased"

The director of the Cape Chamber of Industries, Mr Colin McCarthy, said "where there have been no preliminary negotiations between labour and management, our policy remains one of no work, no pay"

Swopped

In Johannesburg, the local Chamber of Commerce has appealed to employers not to victimize workers forced to stay away from work on both May Day and June 16

A spokesman said some companies had already had talks with union officials and had swopped another holiday for May 1

An Assocom spokesman said they had advised employers that where there had been no prior negotiation with workers, they should stick to a policy of "no work, no pay"

The Transvaal Chamber of Industries, noting that a May Day stayaway seemed likely, supported the "general attitude of organized industry" which was "no work, no pay"

8/5/86
BUS DAY

Whites urged to join struggle

Business Day Reporter

THE UDF affiliated Johannesburg Democratic Action Committee (Jodac) called for whites to stand together with oppressed blacks in South Africa by joining in the struggle against apartheid.

Speakers at a meeting held at St Martins-in-the-Veld, Dunkeld, called for apartheid to be dismantled by whites joining organisations that would replace the present unjust regime.

Albert Nolan, a Catholic priest, asked whites to understand the reasons for violence in black townships.

"For people who have been fighting for just rule with their lives as their only weapon, it is hard to see a brother informing the oppressors and crippling their efforts."

8/5/86
BUS DAY

More data-based graphics in PWV

Industrial staff

THE signwriting industry is being invaded by graphic computers which can reduce costs and production time dramatically on selective contracts.

Major signage companies in the PWV area have already installed graphic computers which can design and cut self-adhesive signs to desired specification.

The introduction of data-based signwriting systems does not endanger the future of signwriters, whose artistic flair and skill still form the integral part of the profession, says Natanya Signs MD David van der Knaap. He says the system's main advantages are its speed and accuracy, although it's uneconomical for large-scale work.

8/5/86
BUS DAY

New rents Bill comes in for flak

ORGANISED industry and commerce have petitioned government to scrap the new, controversial Local Authorities Amendment Bill.

The Bill could force employers to pay their black employees' rents to local authorities

Assocom manpower secretary Vincent Brett says government should face political problems with political solutions "The Bill will

BEULAH BROWN

have a very detrimental effect on industrial relations between employer and employees," he told *Business Day*

The Federated Chamber of Industries says it believes the Bill could open employers to attack from the international trade union movement, thus aggravating the threat of international sanctions

CHERN

BW DA 12/5/76
Govt rethink on

rent collection

CHRIS CAIRNCROSS
and LESLEY LAMBERT

133

GOVERNMENT is believed to be backing down from its proposal empowering black local authorities to force employers to act as rent collection agents.

There has been criticism of the plan from all quarters, including organised commerce and industry.

The proposal is contained in a clause of the Black Local Authorities Amendment Bill, tabled in Parliament last month by Constitutional Development and Planning Minister Chris Heunis. It is now before a standing committee.

The draft legislation empowers local authorities to issue garnishee orders instructing employers to withhold from wages or salaries amounts due to local authorities.

It would enable magistrates to issue warrants of execution against employers' moveable property in the event of their failure to collect amounts employees owe their local authorities.

Criticism of the legislation is that it disregards the rights of the individual, passes the buck to the employer, and will inevitably lead to friction between employer and employee.

It is understood the Bill has come in for flack in the committee stage and there is every indication government will scrap the clause entirely.

3 000 WORKERS IN WAGE DISPUTES

LENMASEKO

ABOUT 3 000 workers were involved in work stoppage over wage demands in the metal industry yesterday.

Two companies, Barlow Rand and GEC, are locked in disputes over wage demands made by metalworkers' unions at plant-level. About 3 000 workers are presently involved at two Barlow Rand group subsidiaries, Fuchs and Barlow Rand Appliances in Alrode, and GEC plants on the Reef.

The disputes have roots in union demands outside the annual wage negotiations between the Steel Engineering Industries Federation of South Africa (Seifsa) and the metalworkers' unions.

At Barlow Rand Appliances, workers are demanding an hourly wage increase of R1,50; a bonus for R75; long service benefits.

Demands

The striking GEC workers are demanding across-the-board hourly wage increases ranging from 50 cents to R1,50.

These demands are in addition to wage proposals submitted by unions affiliated to the International Metalworkers' Federation at Seifsa-level. The IMF unions,

Mawu included, are demanding a minimum wage of R3,50 an hour.

The unions, which include the Metal and Allied Workers' Union, are pressing for negotiations at company-level.

Meanwhile the South African Black Municipal and Allied Workers' Union has condemned the dismissal of its 1 000 members at the Tembisa Council. The union has warned that workers at other local authorities would go out on solidarity strikes.

Sabmawu general secretary Mr Philip Dlamini told the *Sowetan* that some strikers had been ordered to vacate council-owned houses in the area. "The workers who have been ordered out the council houses are those on the fire brigade and the ambulance service," he said.

Boycott

Local residents had resolved to intensify a rent boycott in a bid to force the council to settle the dispute, Mr Dlamini said. The town council fired the 1 000 workers after they took part in a strike over wage demands and better working conditions. According to Sabmawu, the minimum salary earned by a council employee was R280 a month.

Other work stoppages were: ● Concor group was hit by strikes at its Johannesburg, Cape Town and Westonaria plants yesterday. Members of the Building Construction and Allied Workers' Union at Concor are demanding hourly wage hikes.

Workers at six Pioneer Ready Mix Concrete are still out on strike. They are protesting "unfair dismissal". Workers told the *Sowetan* that they had been dismissed, but this could not be confirmed by late yesterday. Pioneer plants affected by strikes are in Pretoria, Vanderbijlpark, Vereeniging, Stilfontein, Johannesburg and Boksburg.

About 900 workers are involved in the dispute. ● A number of workers at Supervision Cleaning Services have downed tools, but the *Sowetan* could not establish the reasons for the action. The Brushes and Cleaners Workers' Union is investigating the matter. ● The wage strike by about 3 000 workers at Sentrachem subsidiaries is still on. ● About 400 members of the General and Allied Workers' Union are involved in pay disputes with Securitas at Florida. The Black General Workers' Union (Blagwu) and Racec company in Witbank has reached an agreement over retrenchments which were to be effected this month.

BID FOR

PEACEFUL SOLUTION

SOWETAN Reporter

THE African National Congress and the National African Federated Chamber of Commerce have agreed that the urgent task faced by all South Africans was to find a solution to the crisis which has engulfed the country.

The agreement follows a weekend meeting where delegations of Nafcoc and the ANC led by their respective presidents, Dr Sam Motsenyane and Mr Oliver Tambo, met in Lusaka.

In a statement released by Mr Gabriel Mokgoko, Nafcoc's public relations officer, the delegations met in a cordial atmosphere and discussed a wide range of issues of concern to all the people of South Africa.

The Nafcoc delegation explained that their organisation had for many years been in-

involved in various efforts to encourage a peaceful resolution of the conflict which is now tearing the country apart.

The delegation also explained that the purpose of these efforts was to help create the situation when it will be possible for all genuine leaders of South Africans to enter into dialogue aimed at a just and agreed resolution of the fundamental problems facing the country.

"The delegation further explained that as an organisation of black business people, its members are equally affected by all the problems facing black community in general.

"Nafco is therefore committed to do everything in its power to ensure that the black people of our country live in freedom and equality

with our white compatriots," the statement says.

The ANC, the statement continues, expressed its appreciation of the initiative taken by Nafcoc to discuss these

vital issues. It explained its own commitment to strive for a united, democratic and non-racial South Africa.

The ANC affirmed that it sees Nafcoc as playing an important

role in the creation of such a society, acting within the context of the decisions of its own national conferences.

The delegations agreed that the meeting constituted a valuable

experience which helped to clarify the respective contributions each organisation was making in the effort to create a peaceful, happy and prosperous South African society.

Some far 29/5/86

133

Employers plead for detainees

Call Time 20/6/86 (133)

PRESSURE is mounting on the government to release or charge detained union leaders following urgent requests from a growing number of employers who report that the arrests have had a crippling effect on industrial relations.

Major employer associations which have telexed the Minister of Law and Order, Mr Louis le Grange, include the Association of Chambers of Commerce (Assocom) representing 23 000 employers, and Assemp, an employer association in the retail trade.

However, it is not yet clear whether Mr Le Grange will be prepared to meet business leaders in the wake of more than 60 spontaneous sit-in strikes at retail chains on the Reef.

The minister's spokesman, Captain Henry Beck, confirmed that businessmen have requested a meeting, but had not yet been given a reply.

'Wildcat'

Hundreds of workers have staged sit-down strikes in shops and supermarkets. Trade union sources said at least 53 businesses on the Reef were affected by wildcat strikes to protest against the alleged detention of union leaders.

The Federated Chambers of Industry (FCI) has not telexed the government on this, but several of its major members have done so.

Mr Tony Bloom, head of the Premier Group, said in a telegram to Mr Le Grange: "We urge you to reconsider your policy."

Warning of "a legacy of bitterness", he said detained trade unionists should be charged or released.

"We are now faced with attempts to run our factories and enterprises by dealing with the mob, as the leaders are in custody," he said.

Assemp chairman Mr Don Findlay said Assemp's telex had urged Mr Le Grange to release leaders, and expressed deep concern that detentions could be highly detrimental to manage-

ment-employee relations.

Other difficulties also reported following the arrest of union leaders include:

- Numerous disputes between companies and unions that cannot be resolved in the absence of detained leaders.

- Many wage negotiations have ground to a halt.

- Many union leaders are also in hiding and cannot advise members.

The chairman of Anglo American, Mr Gavin Rely, has also made a public call for the detained union and community leaders to be charged or released.

He has said "It goes without saying that in these circumstances neither civil nor industrial relations development can move forward."

AECI group industrial relations manager Mr Andre Botha the group had expressed grave concern about the detention of trade union leaders which could lead to serious industrial relations problems.

Accede

Opposition spokesman on labour matters Mr Andrew Savage yesterday called on Mr Le Grange to accede to the appeals from the business community.

- There were "some strikes in some areas but not nationwide strikes," the Bureau for Information said in Pretoria yesterday.

Further information would be given "after the situation has crystallised," bureau spokesman Mr David Steward said at the daily briefing — Own Correspondent and Sapa.

Metal workers must decide on employers' offer to break dispute

By Mike Siluma

Metal industry employers will meet 15 trade unions again today to try to break a partial deadlock affecting many of the industry's 350 000 employees

Three of the unions — the Metal and Allied Workers' Union (Mawu), the Engineering and Allied Workers' Trade Union (Eawtu) and the Steel, Engineering and Allied Workers' Union (Seawu) — are involved in a dispute with the employer body, the Steel and Engineering Industries Federation (Seifsa). Together, they represent about 60 000 workers

RESERVATIONS

After two months of negotiations, 10 of the unions have accepted the offer, some with reservations.

These include the Mineworkers' Union, the Iron Moulders' Society of SA, the SA Electrical Workers' Association and

the Amalgamated Engineering Union of SA

The SA Boilermakers' Society, previously also in dispute with Seifsa, is expected to accept the final offer

Last week, it recommended that its members do so

The position of the Electrical and Allied Workers' Union is unknown

All unions which have accepted were party to the industry's 1985 main wage agreement, and include the Mineworkers' Union, the Iron Moulders' Society of SA, the SA Electrical Workers' Association and the Amalgamated Engineering Union of SA

Mawu, Eawtu and Seawu (all affiliates of the International Metalworkers' Federation) have demanded, among other things, the recognition of May Day as a paid holiday, a reduction of working week to 40 hours, a guaranteed 50c, across-the-board hourly increase, as well as a new minimum rate of

R3,50

The employers' final offer, to which the unions have to respond today, would guarantee hourly personal increases ranging from 32c at the bottom to 60c at the top. It would lift minimum rates from R2,22 for the lowest grade to R5,81 at the top

Seifsa has proposed that the demand for the reduction of the hours of work be referred to a joint employer-union committee, which would have to make recommendations by the end of next February.

LABOUR DAY

Proposing that a commission of inquiry into public holidays be established, Seifsa has suggested to the Government that May 1 become a public holiday called Labour Day

If representations to the authorities failed, employers would negotiate with unions the basis on which May 1 should be a public holiday

Clean-up order 2 held at

'Empty' pledges attacked

Business leaders, employer associations and trade unions were urged yesterday to become more involved in politics so that reforms needed to restore peace and prosperity in the country could be implemented.

Speaking at an industrial relations conference in Johannesburg yesterday, Professor Willem Kleynhans, head of Unisa's department of political studies, said he had seen scores of political statements, advertisements and pledges made in the media lately by businessmen and various employer groups.

Business leaders had grown fond of saying that business could play the role of catalyst in the reform process.

Professor Kleynhans warned that without the political power to put their pledges into practice, words spoken by businessmen were worthless.

"Black workers are pointing fingers saying that employers are not doing enough and their complaint is legitimate."

139 (134) 11/1/86
DD

Union, chambers warn on threat to labour

JOHANNESBURG — Current circumstances posed a major threat to South Africa's labour relations systems, a joint statement by the Federated Chamber of Industries, the Associated Chambers of Commerce and the Council of Unions of South Africa said last night

The statement, arising from a meeting between the two employer organisations and the union federation, said they believed "conflicts should be resolved through negotiation, discussion and compromise".

The statement said the detention of union representatives and community leaders "creates a leadership vacuum in our society which does not build the trust so essential for an effective and sound industrial relationship"

The statement said the groups reaffirmed their belief in a united, non-racial and democratic South Africa where the rights and freedoms of all citizens were protected

South Africa's crisis,

it said, could only be resolved by involving all leaders in free political activity and taking part in serious discussion about a future South Africa

"This can only be achieved if a formula can be found for all leaders, including those in prison, to take part in a democratic, non-violent political process."

● The national president of the Federated Hotel, Liquor and Catering Association, Mr Mike Kovensky, said in Cape Town yesterday that there was a special case to be made for urgent government assistance for the industry, which had been one of the country's main producers of foreign exchange

South Africa's hotel industry, which employs more than 140 000 people, had been plunged into its gravest crisis since the 1930s, he said

Unless South Africa's image abroad "can be perceived to have changed," the prognosis for the hotel industry must be bleak

The managing direc-

tor of Protea Hotels, Mr Otto Stehlik, said the whole infrastructure of tourism in South Africa, built up over many years in what had become the country's second biggest industry next to mining, was "crumbling"

The importance of the tourist industry was not generally appreciated, with the result that farming, for instance, received far greater government assistance than did tourism, he said

Cosatu cancels talks after raids

COSATU, the Congress of South African Trade Unions, has cancelled a second round of talks with two employers organisations because of continuing State pressure.

Sources within Cosatu said Wednesday night's meeting — just a day before the deadline given by Cosatu for the autho-

rities and business to meet certain demands — was cancelled because of continuing raids and detentions

It was to have been a sequel to a meeting held on Monday between Cosatu, the Association of Chambers of Commerce and the Federated Chamber of Industries

Issues discussed at Monday night's meeting included the widespread industrial action taken by workers to protest against the emergency and the employers' re-

sponse to a list of demands drawn up by Cosatu affiliates

The first set of Cosatu's demands are

- An end to intimidation of shop stewards, officials and workers,
- The release of all union leaders,
- "A movement to a democratic resolution of our country's problems.

The second set includes:

- That detained union members were not dis-

missed;

- That detained members get full pay for the period of their detention;

• That wage increases delayed because of the emergency be backdated to compensate fully for such delays,

- That all employers make available to shop stewards or Cosatu officials facilities to communicate;

• That employers allow all members at least two hours a week during working hours to discuss and attend to union business, without loss of

pay,

Employers are reported to have agreed to the second set of demands

Sources said Cosatu was satisfied at the employers' response regarding these demands.

On the first three employers suggested a joint union-employer delegation to the Government Cosatu said this was out of the question because many of its leaders were in detention.

133

11/7/86

BUSINESS 11/2/88

153

Union, employers call for end to violence and emergency

SEVERAL major employers and a union federation have issued a strongly-worded statement calling for a stop to all acts of violence and an urgent end to the state of emergency.

The statement follows a meeting between the Federated Chamber of Industries (FCI), the Association of Chambers of Commerce (Assocom) and the Council of Unions of SA (Cusa)

They say their joint memorandum "is an indication both of the gravity of the present situation as well as an indication of the steps which could be taken to over-

come it". Areas of joint concern and con-

CLARE PICKARD-CAMBRIDGE and DIANNA GAMES

- SA's current crisis can only be resolved by involving all leaders in free political activity to discuss the future
- The emergency and its regulations have curtailed union and employer freedom and rights
- Current circumstances pose a major threat to SA's labour relations system because conflicts need to be resolved through negotiation and compromise.
- Emergency regulations fundamentally hamper the effective operation of unions. The detention of union and community leaders creates a leadership

vacuum that does not build the trust essential for sound industrial relations.

The detention of community and union leaders and members creates a climate for increasing tension not conducive to resolving SA's critical problems

A belief in a united, non-racial and democratic SA wherein the rights of all are protected.

Government said on Wednesday that the two-day-old ban on indoor gatherings of certain unions in Johannesburg and Roodepoort had been a mistake. A spe-

cial Government Gazette was printed yesterday to rectify the error

Progressive Federal Party (PFP) spokesman Helen Suzman said the ban had been a "most serious blunder" and was further indication of the "ineptness of government, which cannot even use its own rotten legislation correctly."

Bureau of Information spokesman Leon Mallett said "A mistake was made and now it has been corrected"

But a leading legal firm called it a display of "sheer incompetence", even by government's "diminished standards"

Premier Human Resources director Rob Childs said most businessmen did not believe the ban had been an error

- The organisations removed from Monday's list by government are the Commercial, Catering and Allied Workers Union of SA, Cosatu, Council of Unions of SA, General and Allied Workers Union, Media Workers Association of SA, Health Workers Association, Metal and Allied Workers Union, and the National Union of Mineworkers
- The prohibition, covering Soweto, Diepkloof, Meadowlands and Dobsonville has been extended to include student representative councils of all schools, colleges and/or universities.

AMGMS 11/7/86

133

Emergency — a guide for employers

By DICK USHER
Labour Reporter

GUIDELINES for employers during the emergency have been issued by the Cape Chamber of Industries.

The chamber's weekly bulletin says the guidelines were drawn up after a meeting between the Federated Chamber of Industries and the Minister of Manpower.

It suggests it would be good industrial relations practice for employers to confirm with the police when it was suspected that an employee had been detained.

Send Bible

"Communicate clearly to all workers that the employment relationship with workers will not be affected by involuntary absence from work," it says.

"Send a Bible to the detainee if the place of detention is known."

"Inquire from the detainee's family whether they require any assistance, financial or otherwise, and assist in these needs as far as possible"

On communications between employers, trade unions and

members the bulletin advises that written documents about bona fide trade union matters can be distributed on company premises

Bona fide trade union meetings can be held indoors and the chances of keeping meetings peaceful will in all probability be enhanced by keeping them as small as possible

Outdoor meetings, whether on or outside company premises, may be held only with the permission of the local magistrate or the Minister of Law and Order

"It will help if the employer assists the trade union by assuring the authorities that the meeting is arranged to conduct trade union business."

Security forces will not interfere in a legal strike.

"If workers participating in an illegal strike are on company premises, are out of the public eye, behave and do not contravene any emergency regulations, the security forces will not interfere

"However, should management report that workers are out of control, or should they contravene emergency regulations or endanger life or property, this may be necessary"



H
S
I
V
E
P
S

L/K ARBUS

12/7/85 133

Employers
care —
Unisa studyLABOUR
AFFAIRSDICK
USHER

ABOUT 80 percent of South African employers believe the business sector has an obligation to improve the social circumstances of their black employees, according to a new Unisa study.

The study, *An Assessment of the Development and Welfare of Employees in the Republic of South Africa*, by Professor Piet Nel of Unisa's Bureau of Market Research, says that employers are generally well-disposed towards their black employees

About one-third apply minimum living standard figures, but more than one-fifth do not follow a policy of equal work for equal pay.

"Segregation in the workplace is, however, fairly common. Separate facilities are most common in respect of cloakrooms," says the study.

"Discrimination, a built-in element of labour policy and legislation for many years in South Africa, has been progressively dismantled since 1979. Today, the only legal discrimination left in the labour field is in a few job categories in the mining industry."

The study estimates that 1,7 million blacks — 23,1 percent of the economically active black population — are unemployed and underemployed in South Africa and the TBVC countries (Transkei, Bophuthatswana, Venda and Ciskei) at present

Between 3,6 million and 6,8 million new jobs will have to be created over the next 15 years.

"This task should be measured against the present 7,72 million jobs in South Africa and the TBVC countries and an increase of 226 000 jobs in the past five years and 1,55 million over the past 15 years

"An analysis of job creation in the period 1950 to 1985 shows that it was only from 1960 to 1970, when the GDP rose by 5,9 percent per year in real terms, that the percentage increase of employment was at least equal to the increase in population"

Since 1970 there had been a marked improvement in the economic welfare of blacks, says the study.

"Their share in the personal disposable income of the RSA has risen from 32,2 percent in 1970 to 44,5 percent in 1985. A fairly drastic redistribution of income has occurred since 1980. In the period from 1980 to 1985 the real personal disposable income of whites declined by 17,9 percent."

The study says that two factors were chiefly responsible for the redistribution of income:

- Average real remuneration of whites rose by 0,3 percent per year between 1972 and 1985, compared to increases of 4,7 percent, 1,5 percent and 3 percent for blacks, Indians and coloureds
- Massive increases in direct taxes paid by whites. In 1985 whites paid 15,7 percent of their income in direct taxes compared to 8,8 percent in 1980

GfSA is target in Britain

LONDON — The Anti-Apartheid Movement has launched a major campaign to try to force the giant British mining finance house, Consolidated Gold Fields PLC, to "get out of South Africa."

The CGF group is to become the non-stop target of demonstrations and "exposures" of its role in South Africa in a bid to cause maximum embarrassment to the group and the British Government

A wing of the Anti-Apartheid Movement, the Counter Information Services (CIS), has started the process by publishing a booklet titled Consolidated Gold Fields — Partner in Apartheid.

The CIS accuses CGF of making "massive profits" through Gold Fields of South Africa while absolving itself of "responsibility for GFSA's employment practices"

The CIS publication claims GFSA employs 72,000 black mineworkers on its group-administered gold mines, making it the largest foreign employer of black labour in South Africa

The CIS alleges that the GFSA minimum wage for underground black mineworkers in 1985 was half the minimum living level and that in spite of record earnings, the company had refused to yield to the National Union of Mineworkers' demands for an additional four per cent increase over and above that negotiated with the Chamber of Mines — DDC

DD
19/7/86

'Hundreds' of employers join pleas on detentions

By DICK USHER, Labour Reporter

INTENSE behind-the-scenes pressure against the state of emergency has been put on the Government by hundreds of employers responding to demands from trade unions.

They have been sending messages to the Government urging an end to the emergency and the release of detainees

Because the employers have preferred to adopt a "private" approach the number is not known, but observers estimate that countrywide they run into hundreds.

This is in addition to public statements and actions by leading employers and employer federations such as AE & CI, the Federated Chamber of Industries (FCI), the Association of Chambers of Commerce (Assocom) and others.

According to weekend reports President P W Botha called the attitude of the FCI, the country's largest employer organisation, "quite ridiculous"

Leading employers have met the Minister of Law and Order, Mr Louis le Grange, to object to detention of trade unionists. They said the absence of leaders actively involved in settling disputes was leading to serious problems in industry.

269 officials held

According to the Labour Monitoring Group (LMG) at least 269 office-bearers and officials of unions were in detention last week.

An earlier LMG statement said that those held included 41 officials and members of the Metal and Allied Workers' Union (Mawu), 24 from the Commercial, Catering and Allied Workers' Union (Ccawusa) and 18 from the National Union of Mineworkers

These and other independent unions have recognition agreements with hundreds of employers throughout South Africa

Since the imposition of the emergency on June 12 shop stewards at individual companies have approached their managements to send messages to the Government urging an end to the emergency and the release of detainees, specifically union members and leaders

According to observers many employers have responded to the call and have preferred to adopt this low-key approach to the emergency

But the LMG noted that workers were becoming disillusioned with the gap between liberal statements by top businessmen and the behaviour of some local managements



Sasa passes resolution against apartheid

Body to promote changes for a more equitable SA

DURBAN — The South African Sugar Association (Sasa) has passed a resolution expressing its opposition to apartheid and is to draw up an affirmative action programme to be carried out in the near future, Sasa's chairman said yesterday

Dr Kees van der Pol, speaking at the association's annual meeting in Durban, said the anti-apartheid resolution should be regarded as the industry's declaration of intent to do what it could to promote changes which would create an equitable South African society

"Traditionally Sasa has kept a low profile on political issues but we can no longer remain silent, even though our members represent the entire political spectrum," he said

While not taking sides for or against the government, Dr Van der Pol said the association "must take sides on such major issues as the abolition of apartheid, the sharing of power on an equitable basis among all sectors of our population and in the restoration of law and order in our society"

Dr Van der Pol said although Sasa, which represents 25 000 growers, 15 mills and a central refinery — employing more than 154 000 people throughout the KwaZulu/Natal region — had carried out its social responsibilities and had made considerable progress towards a more equitable society, much remained to be done

"We must not only aim to alleviate the effects of apartheid, but must also work toward the abolition of apart-

heid by setting an example and providing leadership within our sphere of influence

"We must openly support and encourage the government to proceed in haste with its declared goal to abolish apartheid."

Dr Van der Pol said violence created violence and everyone would be losers "The abolition of apartheid is not an end in itself to be achieved at any price — it is the means to bring about a just, peaceful and prosperous society in which we can all share."

"I also hope and trust that our overseas customers and friends of South Africa in general will accept our resolution as an expression of solidarity with their objectives to promote change in our country and not as an empty response to the threat of sanctions"

Dr Van der Pol said if economic sanctions were imposed, the many forces working for peaceful change within South Africa would find themselves on the opposite side of those seeking change through sanctions

"There is another way to promote change, and I refer to the Natal/KwaZulu indaba in which the South African Sugar Association is playing an active role seeking to promote power sharing in Natal

"It is my honest belief that we can find a workable structure which will enable all the inhabitants of this part of South Africa to work together towards the creation of a just and peaceful society, and which could be an example to the rest of our country" — Sapa

Racism: Employers have ^{Can Tim} power ^{26/7/62}

~~133~~ 133
Labour Reporter

SOUTH African employers are in a better position than politicians to eliminate racial discrimination because they "don't need anybody's permission" to bring about change, the former director of the National Institute for Personnel Research, Dr Dawie Gouws, said yesterday.

At the launch of a new industrial relations consultancy, of which he is a senior partner, Dr Gouws said the workplace provided "a better opportunity for the elimination of discrimination, significant participation in decision-making and the building of a just society" than similar efforts by politicians.

"You have the authority and the power to bring about change. You don't need anybody's permission," he told the gathering of top local business people.

"You must get away from believing that the political situation and the housing crisis must be solved before you can take things further."

Adversary

Dr Gouws said most black workers had developed an "adversary" relationship with management and the capitalist system because they felt excluded from the running of the companies for which they worked.

There were too few blacks in middle and senior management, and employers did not make enough effort to counter the "relative impotency" blacks suffered as a result of the political and economic system, he said.

If management failed to give blacks access to power within their business organizations "there are others waiting to give them a different experience of power — sometimes of a destructive kind", Dr Gouws said.

133

Cane growers change name

Mercury Reporter

THE Natal Indian Cane Growers' Association, founded 50 years ago, decided at its annual meeting in Stanger yesterday to drop its racial tag in keeping with the changes taking place in South Africa, its president, Mr Pat Bodasing, said.

He said the association's constitution had been amended, changing the name to Natal Cane Growers' Association, making it a fully-fledged non-racial body.

The move follows the South African Cane Growers' Association's decision to open its doors to people of all races.

Mr Bodasing said that cane farmers of other race groups could apply for membership of the Natal Cane Growers' Association.

'There was unanimous support from 250 farmers at the meeting for the racial tag to be dropped,' he said, adding that those present agreed that it was a step in the right direction, especially now that sanctions were threatened.

'I believe that other community organisations should also open their doors and become non-racial to pave the way for a new South Africa,' Mr Bodasing added.

There were tense scenes at the meeting as some people objected to the presence of a House of Delegates MP, Mr S V Naicker, deputy Minister of Environmental Affairs and Agriculture, at the meeting.

Some members of the audience, who said they were opposed to the tricameral Parliament, expressed strong reservations about Mr Naicker's presence.

Mr Bodasing confirmed that 'some people because of their political views, had objected to Mr Naicker's presence'.

'I personally invited Mr Naicker to our meeting and I am glad that the matter ended there and that there were no further repercussions from members,' he added. He said Mr Naicker had remained until the end of the meeting.

1/8/86
S.M.K. (133)

Employers resist union demands, says LMG

By Mike Siluma

Few employers have met the demands made by the Congress of SA Trade Unions (Cosatu) regarding wages and the status of workers detained in terms of the state of emergency, says the latest report of the independent Labour Monitoring Group (LMG) which puts the number of union leaders currently held under the emergency at 320.

Demands made by Cosatu include continued income for detained unionists, time off for union business and an end to night shift work because of dangers of returning home late at night during the emergency.

Mawu, one of the unions hardest hit, had reported that, by and large, metal employers were not paying up. The union was put in a position where it had to directly assist detainees' families by paying their water, rent and electricity bills.

"South Africa's largest union, the National Union of Mineworkers, faces a large employer, Goldfields, which granted job security but did not pay wages. The situation is somewhat better at Anglo American and De Beers," said the report.

It said an additional problem for NUM is that families of many detained union members are in distant places like Lesotho and Transkei.

According to the LMG, guidelines to employers from organised commerce and industry, while sympathetic, did not guarantee jobs and wages for detainees.

Eighty-two percent of detained unionists were from Cosatu, 14 percent from the Council of Unions of SA and 4 percent from the rest.

A
d
f
i
e
s
i

Tuesday, August 5, 1986

~~133~~ 133

Peace pact used 'to form Inkatha union'

Mercury Reporter

THE Natal Agricultural Union and the Louwsburg Farmers' Association have been accused by Conservative Party members of forming an Inkatha-backed 'trade union in disguise' in the Louwsburg farming district

The accusation was made at the Natal CP congress at the weekend by a party member, Mr Adriaan Kriel, who is also a farmer

He claimed farmers in the area had been persuaded by the NAU to make their facilities — including schools — available to Inkatha to sign up all their labourers

In return for this, the organisation and the workers would co-operate on matters of housing and security in the area

This, he claimed, was merely Inkatha's way of beating the aims of the Congress of South African Trade Unions (Cosatu)

It was well known that Cosatu wanted to form a farm labourers' and domestic workers' trade union, he said, adding that this was the only way in which Inkatha could beat them to it.

Approached by the Mercury, a spokesman for the NAU declined to comment, saying it was a private matter between the farm owners and Inkatha

But Mr Tjaart van Rensburg, chairman of the Louwsburg Farmers' Association, said the 'peace pact' between the farmers and labourers had nothing to do with a union

'The black people who live in the district have very strong Inkatha orientations anyway. It is a genuine feeling they have, and have always had'

'The pact is merely a way for us to live in peace, in a kind of partnership,' said Mr van Rensburg

If Inkatha managed to sign up several members in the area, it was simply because they were already strong supporters, he said.

The 70 members of the Louwsburg Farmers' Association supported the move wholeheartedly, he said

Among them, according to Mr van Rensburg, are several CP members who have entered into the agreement 'unofficially' to save face

'None of the farm labourers, or farmers, is forced to join a spokesman for the United Workers' Union of South Africa (Uwusa) — an Inkatha backed organisation — was unavailable for comment.

(News by J Moore, 12 Devonshire Place, Durban.)



FAST!!!
14
TEXTILE

375
FITTED FREE

DUNLOP SP5 STEEL

600x14

DUNLOP D157 - 6 PLY TEXTILE

6975

CASH — FITTED FREE

CROSS-PLY
RETRREADS
FOR
MOST CARS

2775

CASH — FITTED FREE

DUNLOP SP SPORT

TEXTILE

7275

CASH — FITTED FREE

STANDARD
RADIAL-PLY
RETRREADS

3275

CASH — FITTED FREE

DUNLOP SP SP

TEXTILE

7875

CASH — FITTED

BAKKIE
RETRREAD
UP TO 670x14

3575

CASH — FITTED

Businessmen told to study labour law

capl. notes 6/8/86 133

EMPLOYERS who established good relationships with their employees would have fewer problems with workers adopting the "militant ideologies" of certain trade unions, the director of Human Resources at the National Productivity Institute, Mr Louis Pepler, said yesterday.

Addressing the Afrikaanse Sakekamer in Cape Town, Mr Pepler urged businessmen to give workers the feeling that they had a stake in the company for which they worked and to look after workers' interests.

"Organizations which have a good relationship with their workers have no problem with unions. If workers get what they

want they don't need the union.

"It is up to management to combat the militant ideas propagated by some unions from the inside, so that their workers don't fall for these ideas," he said.

Mr Pepler said managers should study labour law so that they knew what they could and could not do.

They should also get to know the trade unions and their leaders and teach them about Western economic concepts.

Good labour relations were central to increased productivity as they helped to keep lines of communication between management and workers open.

Evictions - a call to Vaal bosses

VAAL organisations have called on employers to actively involve themselves in persuading the Lekoa Town Council to stop evictions of rent defaulters.

In a statement to the *Sowetan* at the weekend, the organisations, which include trade unions, community, political and church groups, said the council should stop evictions and negotiate with residents.

The council has temporarily stopped evictions after intervention by the Oranje Vaal Relief Trust which has undertaken to persuade residents to pay rent.

This was confirmed by the town secretary, Mr Ben Scott.

He said the council will consider further action starting from today after he had received a report back from the Trust. The council will also discuss the matter at its monthly meeting tomorrow.

The council has evicted at least 31 people from their homes in Sharpeville, Zamdela, Boipatong, Bophelong and was about to evict Sebokeng residents when the Trust intervened.

The town clerk, Mr Nikolaas Louw, has said that the council will evict people on Saturdays when everybody is at home. "We do not want to be seen to be acting irresponsibly," he said.

Meanwhile the newly-formed Vaal Stop Eviction Committee has pledged to fight evictions and to strive for the maintenance of freehold rights.

Employers 'can do more for workers'

133
CITY PROJECT 11/10/88

SOUTH African employers have taken their social responsibility role further than their counterparts elsewhere, but the nature and scope of the challenge facing us demands even more, says Urban Foundation executive chairman JH Steyn

The private sector possesses an abundance of practical skills and expertise in management, negotiation and tough decision-making. Thus it is particularly well-placed to make a vital contribution to the process of socio-political transformation

Steyn identified three distinct, but inter-related avenues for socio-political involvement:

Programs can be started within the work environment and which could have immediate transformative effects, among these being the more energetic and varied training for black staff and of dynamic black management development

Achievements in these areas have been disappointing, despite a virtual doubling of blacks employed in professional or managerial positions between 1977 and 1987, the percentage this comprises of both the total number of professionals and managers (7,1%) and of the total black work force (2,5%) remains very low

Providing housing for black employees is receiving more attention but, the time for dynamic action to translate the emerging opportunities into a new housing dispensation for the black working class has indeed arrived.

Singly or in co-operation with other employers, possibly through private sector organisations, employers should facilitate the access of their staff to building societies and other sources of financial support on a widespread and systematic basis

Steyn referred to house occupancy averages of 10 to 13 persons per household and the number of homeless people and said numerous studies have shown a vital link between the quality of the home environment and

both overall quality of life and work satisfaction among black employees

Employers must act to begin to alter these circumstances immediately

The private sector can become involved in promoting real reform by playing a facilitative role

This can be done by using sophisticated and skilled manpower resources to promote access for blacks to profitable business activity

There are insufficient significant examples of successful initiatives by the business sector to accelerate participation by blacks in the free enterprise system

Yet the innovative ability, drive and determination currently locked up in SA's business leadership, once released, could have a major impact on the very great backlog of black business development

This could be done through partnership agreements, inputs of expertise, the encouragement of profitable links and by providing financial and other backing – for emerging community groups enabling them to develop into effective and responsible agents for change at the local level

Co-ordinated action by business by the formation of "reform alliances" to lobby government enable the business community to make a dramatic and lasting impact on social and political life

By "reform alliance" is meant a formal coalition reflecting as broad a range of interests as possible formed to campaign for a specific reform objective

The business sector, in collaboration with community leadership, was instrumental some 10 years ago in forming such an alliance – the Urban Foundation

Now the need is to earnestly examine how efforts can be expanded and accelerated by seeking a wider range of coalitions than those already spawned, such as the Private Sector Council and the Law, Review Project, to promote meaningful change, Steyn said

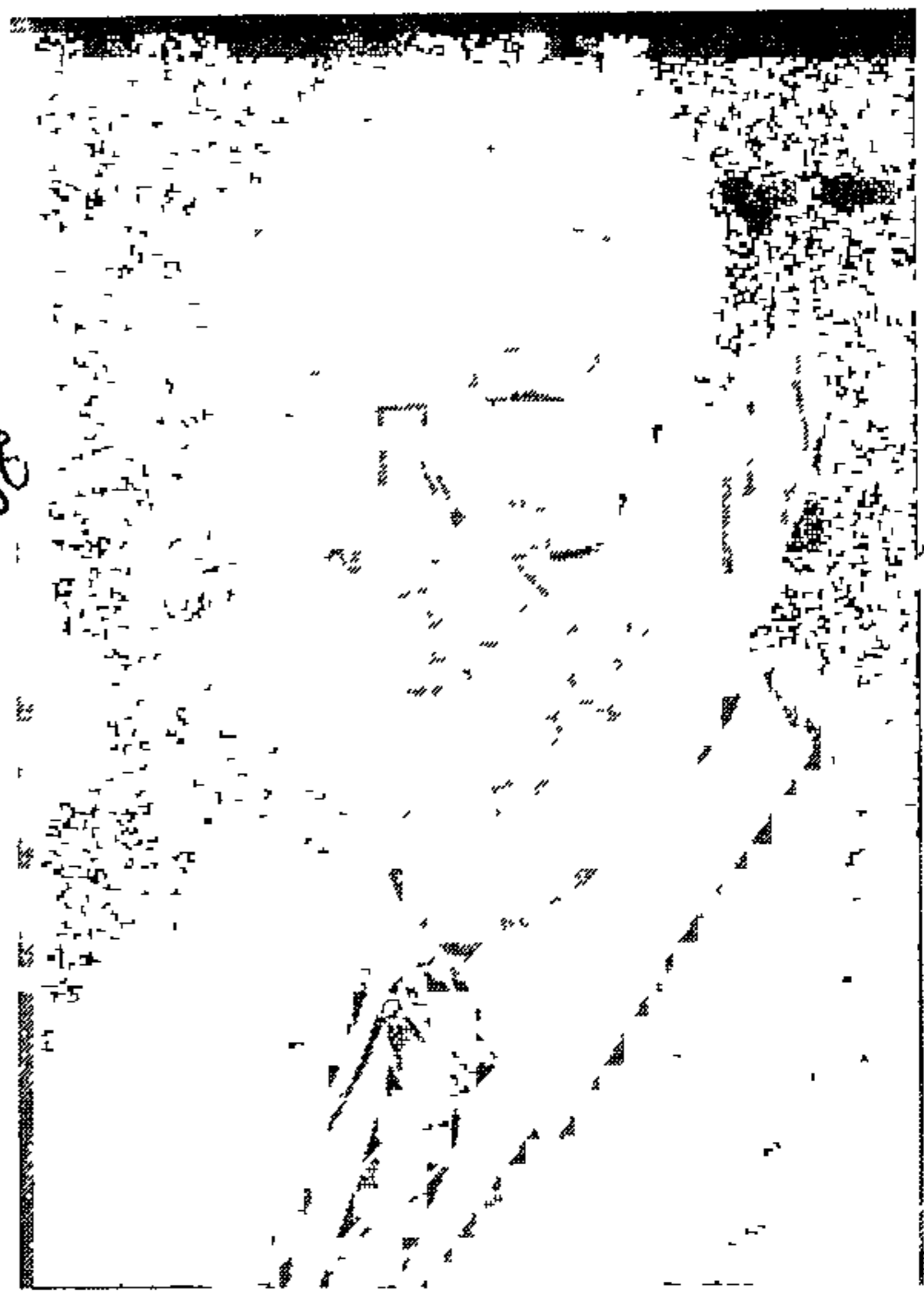

Urban Foundation executive chairman JH Steyn wants employers to do more to fulfil their socio-political responsibilities

BUSDAY 24/10/86

133

Bosses urged to join unions in the search for solutions

ALAN FINE

SA MANAGERS should be willing to search for creative solutions to a unique set of problems in co-operation with the most appropriate unions, rather than taking the conventional view that they should stay out of politics.

That was said yesterday by Kate Jowell of the University of Cape Town's Graduate School of Business in an address to the American Chamber of Commerce

Jowell examined the current ideological struggle within the Congress of SA Trade Unions (Cosatu) between the so-called populist and workerist factions — roughly the pre-Cosatu UDF and non-aligned unions respectively — over the most appropriate political role for a trade union movement.

She concluded that, despite the rhetoric and the regular, political work stayaways that had emanated from Cosatu since its formation last November, the workerist approach had by no means been crushed

Jowell said the stayaway weapon was the most important manifestation of the Cosatu debate. It brought out the differences between those who believed the stayaway should be an increasingly used "bludgeon on Pretoria", and those who saw it as a weapon whose value was more symbolic than real and which should be used in a controlled and limited way

For the latter — the workerists — the stayaway was a "least-risk, pragmatic response by a basically reformist union movement under extreme pressure. It recognises the need to make symbolic political statements ... but tries to orchestrate them with the minimum dam-

age to carefully built up collective bargaining arrangements with management".

The workerists appeared to be losing the ideological battle. But, said Jowell, there was a chance that as the process of amalgamation into large industrial unions continued, the smaller general unions — which typified the populist approach — would be swallowed by more pragmatic organisations.

Business had recently taken some positive political steps — like the joining of forces by Seifsa and the FCI with two Cosatu unions over forced removals at Brits, the joint statement by the FCI and Assocom with the Council of Unions of SA calling for an end to the state of emergency, and the rescinding of the ban on union meetings after pressure from organised labour and business.

What was needed now was a faster search for joint union/management action beyond the factory gates, Jowell said.

Business wants clarification on May Day as a holiday

25/10/86 BB STAR

133

By Sheryl Raine

Business leaders have called on the Government to convene a commission of inquiry urgently into the country's public holidays in the hope of establishing appropriate holidays for next year.

The proposal to establish a commission, by the Port Elizabeth Chamber of Commerce, was adopted unanimously by Assocom at its annual congress in Johannesburg this week.

Businessmen were particularly anxious that clarity be established on the question of Labour Day (May 1) before next year.

SPECIFIC CHANGES

It was suggested that if necessary, the commission issues an interim report with recommendations for specific changes for 1987.

Last year, May 1 and June 16 (Soweto day) were declared holidays by major, emergent trade unions and were observed by millions of workers. Other days such as March 21, the day 19 blacks were shot in Langa near Uitenhage in 1985, have also been marked by stayaways.

Businessmen recognised the need to reflect the

customs, cultural needs and character of the whole of the country's population in the list of public holidays, but were not in favour of extending the number of holidays in the year.

They said certain days had already become de facto holidays as a result of labour demands and the provisions of many union-employer agreements.

They believed it was necessary to consult all groups on their needs and desires concerning public holidays.

"It is necessary for public holidays to become South African, as opposed to black or white," said a delegate from the Maritzburg Chamber of Commerce, which seconded the proposal.

"Until there are holidays that other races can identify with, whites will be prescribing what is good for other races. We must do something soon because Labour Day is just around the corner," said the delegate.

In Natal the issue of public holidays has become particularly confusing since kwaZulu recognised May 1 as a public holiday. Most black workers in Natal live in the homeland.

Employers get warning of stiff penalties

Crackdown on illegal workers

STAR

27/10/80

133

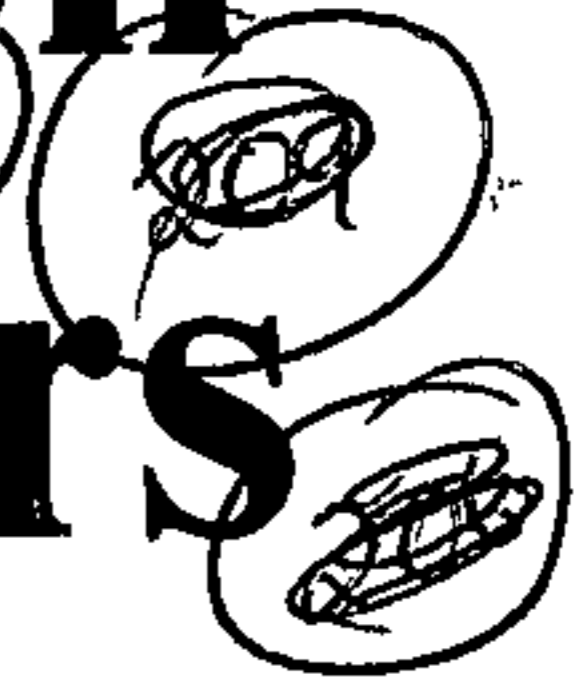

By Sue Leeman, Pretoria Bureau

The Department of Home Affairs has sent out more than 190 000 letters to employers warning that severe penalties await those who employ illegal aliens, according to spokesmen.

The Aliens Act provides for fines of up to R5 000 or two years' jail for first offences in some cases

The letter also tells employers that, in terms of the Aliens Act, an immigration officer may ask any employer for information about foreigners working for him.

It says a person who is not a South African citizen may be arrested without warrant if he cannot produce proof that he is entitled to be in the country.

The letter, signed by the department's director-general, Mr Gerrie van Zyl, is part of a government crackdown on people entering the country

illegally

The Minister of Manpower, Mr Pietie du Plessis, has estimated that 1,3 million people are now working illegally in South Africa

Many of those entering the country without the proper papers are Mozambicans and the Department of Home Affairs says there are now about 225 000 of these people illegally in the country

Earlier this week, police confirmed that 20 Mozambicans had been arrested on the East Rand, allegedly for being in the country without permission

The letter says its purpose "is to inform employers of the requirements of the Aliens Act and to assist them in determining whether their foreign employees are legally permitted to sojourn in the Republic and are legally employed".

It points out that workers from the Transkei, Bophuthatswana, Venda and the Ciskei, who live permanently in these countries, are aliens in South Africa, but have been exempted from the restrictive provisions of the Aliens Act.

However, to be employed in South Africa, they need a TBVC passport, travel or identity document endorsed with permission, as well as a written employment contract or a so-called "call in card" (an abridged service contract attested to or issued by the labour authorities in the TBVC country concerned).

Other workers from any foreign country must hold passports or travel documents from the countries where they are citizens as well as work permits.

- | | |
|---|-----------|
| (ii) In the case of an employee who is a member of the South African Transport Workers' Union . . . | R
1,00 |
| (iii) In the case of an employee who is a member of the Transport Workers' Union of South Africa | 1,00'' |

Signed at Johannesburg for and on behalf of the parties to the Council this 17th day of June 1986.

G. F. VAN NIEKERK,
Chairman.

S. TSHABALALA,
Vice-Chairman.

E. NEL,
Secretary.

No. R. 2267

31 October 1986

BASIC CONDITIONS OF EMPLOYMENT ACT, 1983

CONTINUOUS WORKING

I, Joël Daniël Fourie, Chief Director: Labour Relations, duly authorised thereto by the Minister of Manpower, hereby in terms of section 33 (1) of the Basic Conditions of Employment Act, 1983, declare the manufacture of particleboard from raw wood, as carried out by Interboard SA (Pty) Limited at Wadeville, to be an activity with respect to which work may be performed continuously in three shifts per 24 hours, seven days a week. Provided that the conditions of employment, as published under Government Notice R. 2167 of 28 September 1984, or any Government Notice published in substitution thereof, be adhered to.

J. D. FOURIE,
Chief Director: Labour Relations.

No. R. 2286

31 October 1986

LABOUR RELATIONS ACT, 1956

BUILDING AND MONUMENTAL MASONRY INDUSTRIES (TRANSCVAAL).—AMENDMENT OF MAIN AGREEMENT

I, Pieter Theunis Christiaan du Plessis, Minister of Manpower, hereby—

- (a) in terms of section 48 (1) (a) of the Labour Relations Act, 1956, declare that the provisions of the Agreement (hereinafter referred to as the Amending Agreement) which appears in the Schedule hereto and which relates to the Undertaking, Industry, Trade or Occupation referred to in the heading to this notice, shall be binding, with effect from the first Monday after the date of publication of this notice and for the period ending 30 April 1987, upon the employers' organisations and the trade unions which entered into the Amending Agreement and upon the employers and employees who are members of the said organisations or unions; and
- (b) in terms of section 48 (1) (b) of the said Act, declare that the provisions of the Amending Agreement, excluding those contained in clauses 1 (1) (a), 2 and 3 (4) shall be binding, with effect from the first Monday after the date of publication of this notice and for the period ending 30 April 1987, upon all employers and employees, other than those referred to in paragraph (a) of this notice, who are engaged or employed in the said Undertaking, Industry, Trade or Occupation in the areas specified in clause 1 of the Amending Agreement.

P. T. C. DU PLESSIS,
Minister of Manpower.

- | | |
|---|-----------|
| (ii) In die geval van 'n werknemer wat lid is van die South African Transport Workers' Union | R
1,00 |
| (iii) In die geval van 'n werknemer wat lid is van die Transport Workers' Union of South Africa | 1,00'' |

Geteken te Johannesburg vir en namens die partye by die Raad op hede die 17de dag van Junie 1986

G. F. VAN NIEKERK,
Voorsitter

S. TSHABALALA,
Ondervoorsitter.

E. NEL,
Sekretaris

No. R. 2267

31 Oktober 1986

WET OP BASIESE DIENSVOORWAARDES, 1983

AANEENLOPENDE WERK

Ek, Joël Daniël Fourie, Hoofdirekteur: Arbeidsverhoudinge, behoorlik daartoe gemagtig deur die Minister van Mannekrag, verklaar hierby kragtens artikel 33 (1) van die Wet op Basiese Diensvoorwaardes, 1983, dat die vervaardiging van spaanderbord uit onverwerkte hout, soos uitgevoer deur Interboard SA (Pty) Limited te Wadeville, 'n bedrywigheid is met betrekking waartoe daar aaneenlopend in drie skofte per 24 uur, sewe dae per week, gewerk kan word. Met dien verstande dat die diensvoorwaardes, soos gepubliseer by Goewermentskennisgewing R. 2167 van 28 September 1984, of enige Goewermentskennisgewing gepubliseer ter vervanging daarvan, nagekom word.

J. D. FOURIE,
Hoofdirekteur: Arbeidsverhoudinge.

No. R. 2286

31 Oktober 1986

WET OP ARBEIDSVERHOUDINGE, 1956

BOU- EN MONUMENTKLIPMESSELNYWERHEID (TRANSCVAAL)—WYSIGING VAN HOOFOOREENKOMS

Ek, Pieter Theunis Christiaan du Plessis, Minister van Mannekrag, verklaar hierby—

- (a) kragtens artikel 48 (1) (a) van die Wet op Arbeidsverhoudinge, 1956, dat die bepalings van die Ooreenkoms (hierna die Wysigingsooreenkoms genoem) wat in die Bylae hiervan verskyn en betrekking het op die Onderneming, Nywerheid, Bedryf of Beroep in die opskrif by hierdie kennisgewing vermeld, met ingang van die eerste Maandag na die datum van publikasie van hierdie kennisgewing en vir die tydperk wat op 30 April 1987 eindig, bindend is vir die werkgewersorganisasies en die vakverenigings wat die Wysigingsooreenkoms aangegaan het en vir die werkgewers en werknemers wat lede van genoemde organisasies of verenigings is; en
- (b) kragtens artikel 48 (1) (b) van genoemde Wet, dat die bepalings van die Wysigingsooreenkoms, uitgesonderd dié vervat in klousules 1 (1) (a), (2) en 3 (4), met ingang van die eerste Maandag na die datum van publikasie van hierdie kennisgewing en vir die tydperk wat op 30 April 1987 eindig, bindend is vir alle ander werkgewers en werknemers as dié genoem in paragraaf (a) van hierdie kennisgewing wat betrokke is by of in diens is in genoemde Onderneming, Nywerheid, Bedryf of Beroep in die gebiede in klousule 1 van die Wysigingsooreenkoms gespesifiseer.

P. T. C. DU PLESSIS,
Minister van Mannekrag.

SCHEDULE

INDUSTRIAL COUNCIL FOR THE BUILDING INDUSTRY
(TRANSSVAAL)

AGREEMENT

in accordance with the provisions of the Labour Relations Act, 1956, made and entered into by and between the

Master Builders' Association (Witwatersrand and Transvaal South);

Master Builders' and Allied Trades Association (Pretoria and Country Areas); and

Master Masons' and Quarry Owners' Association (South Africa) representing its members in the Monumental Masonry Industry

(hereinafter referred to as the "employers" or the "employers' organisations"), of the one part, and the

Amalgamated Union of Building Trade Workers of South Africa and
White Building Workers' Union

(hereinafter referred to as the "employees" or the "trade unions"), of the other part,

being the parties to the Industrial Council for the Building Industry (Transvaal),

to amend the Agreement published under Government Notice R 4 of 7 January 1983, as extended and amended under Government Notices R 2315 and R 2316 of 21 October 1983, R 2214 and R 2215 of 5 October 1984, R 954 and R 955 of 26 April 1985, R 2374 of 18 October 1985 and R 2161 of 17 October 1986

CHAPTER I

1. AREA AND SCOPE OF APPLICATION OF AGREEMENT

(1) The terms of this Agreement shall be observed in the Building and Monumental Masonry Industries—

- (a) by all employers who are members of the employers' organisations and by all employees who are members of the trade unions,
- (b) (i) in the Magisterial Districts of Alberton, Balfour, Benoni, Boksburg, Brakpan, Delmas, Germiston, Heidelberg (Transvaal), Johannesburg, Nigel, Randburg, Randfontein (excluding that portion which falls outside a radius of 48,28 km of the General Post Office, Krugersdorp), Roodepoort, Springs and Wonderboom (excluding that portion which falls outside a radius of 32,18 km of the General Post Office, Pretoria), the area within a radius of 48,28 km from the General Post Office, Krugersdorp, the area within a radius of 32,18 km from the General Post Office, Vereeniging, the area within a radius of 32,18 km from the General Post Office, Pretoria (excluding that portion of the Black Area Uitvalgrond JQ 4341 which falls within the said radius), the areas within a radius of 16,09 km from the General Post Offices, Klerksdorp, Potchefstroom, Witbank and Middelburg (Transvaal) respectively, and in the Magisterial District of Kempton Park (excluding that portion which falls outside a radius of 32,18 km from the General Post Office, Pretoria, and which, prior to the publication of Government Notice 551 of 29 March 1956, fell within the Magisterial District of Pretoria),
- (ii) in the Magisterial District of Bethal (including that portion of the Magisterial District of Hoëveldrif which, prior to 1 March 1979, fell within the Magisterial District of Bethal)

(2) Notwithstanding the provisions of subclause (1), the terms of this Agreement shall—

- (a) only apply to those classes of employees for whom wages are prescribed in this Agreement and to learner artisans,
- (b) apply to apprentices and trainees only in so far as they are not inconsistent with the provisions of the Manpower Training Act, 1981, or any conditions prescribed or any notice served in terms thereof,
- (c) apply to "labour-only" contractors, working partners and working directors, principals and contractors,
- (d) apply to foremen and general foremen,
- (e) not apply to clerical employees and administrative staff,
- (f) not apply to persons who are engaged in the installation or wiring of lighting, heating or other permanent electrical fixtures in buildings or the repair or maintenance of lifts in buildings,
- (g) not apply to university students and graduates in building science and construction supervisors, construction surveyors and other such persons doing practical work in the completion of their academic training,
- (h) not include the Iron, Steel, Engineering and Metallurgical Industries as defined in paragraph G of the Certificate of Registration of the National Industrial Council for the Iron, Steel, Engineering and Metallurgical Industry of South Africa,
- (i) be subject to the provisions of any determination by the Industrial Court in relation to the Building Industry and the Furniture Industry

BYLAE

NYWERHEIDSRAAD VIR DIE BOUNYWERHEID (TRANSSVAAL)

OOREENKOMS

ooreenkomstig die Wet op Arbeidsverhoudinge, 1956, gesluit deur en aangegaan tussen die

Master Builders' Association (Witwatersrand and Transvaal South);

Master Builders' and Allied Trades Association (Pretoria and Country Areas); en

Master Masons' and Quarry Owners' Association (South Africa) wat sy lede in die Monumentklipmesselnywerheid verteenwoordig,

(hierna die "werkgewers" of die "werkgewersorganisasies" genoem), aan die een kant, en die

Amalgamated Union of Building Trade Workers of South Africa en

Blanke Bouwerkersvakbond

(hierna die "werknemers" of die "vakverenigings" genoem), aan die ander kant,

wat die partye is by die Nywerheidsraad vir die Bounywerheid (Transvaal), om die Ooreenkoms, gepubliseer by Goewermentskennisgewing R. 4 van 7 Januarie 1983, soos verleng en gewysig by Goewermentskennisgewings R 2315 en R 2316 van 21 Oktober 1983, R 2214 en R 2215 van 5 Oktober 1984, R 954 en R 955 van 26 April 1985, R 2374 van 18 Oktober 1985 en R 2161 van 17 Oktober 1986 te wysig.

HOOFSTUK I

1. GEBIED EN TOEPASSINGSBESTEK VAN OOREENKOMS

(1) Hierdie Ooreenkoms moet in die Bou- en Monumentklipmesselnywerheid nagekom word—

- (a) deur alle werkgewers wat lede is van die werkgewersorganisasies en deur alle werknemers wat lede is van die vakverenigings;
- (b) (i) in die landdrostdistrikte Alberton, Balfour, Benoni, Boksburg, Brakpan, Delmas, Germiston, Heidelberg (Transvaal), Johannesburg, Nigel, Randburg, Randfontein (uitgesonderd daardie gedeelte wat buite 'n straal van 48,28 km vanaf die Hoofposkantoor, Krugersdorp, val), Roodepoort, Springs en Wonderboom (uitgesonderd daardie gedeelte wat buite 'n straal van 32,18 km vanaf die Hoofposkantoor, Pretoria, val), die gebied binne 'n straal van 48,28 km vanaf die Hoofposkantoor, Krugersdorp, die gebied binne 'n straal van 32,18 km vanaf die Hoofposkantoor, Vereeniging, die gebied binne 'n straal van 32,18 km vanaf die Hoofposkantoor, Pretoria (uitgesonderd daardie gedeelte van die Swart Gebied Uitvalgrond JQ 4341 wat binne genoemde straal val), die gebiede binne 'n straal van 16,09 km vanaf die Hoofposkantoor op onderskeidelik Klerksdorp, Potchefstroom, Witbank en Middelburg (Transvaal), en in die landdrostdistrik Kempton Park (uitgesonderd daardie gedeelte wat buite 'n straal van 32,18 km vanaf die Hoofposkantoor, Pretoria, val en wat voor die publikasie van Goewermentskennisgewing 551 van 29 Maart 1956, binne die landdrostdistrik Pretoria geval het),
- (ii) in die landdrostdistrik Bethal (met inbegrip van daardie gedeelte van die landdrostdistrik Hoëveldrif wat voor 1 Maart 1979 binne die landdrostdistrik Bethal geval het)

(2) Ondanks subklousule (1), is hierdie Ooreenkoms—

- (a) slegs van toepassing op dié klasse werknemers vir wie lone in hierdie Ooreenkoms voorgeskryf word en op leerling-ambagsmanne,
- (b) van toepassing op vakleerlinge en kwekelinge slegs vir sover dit nie strydig is met die Wet op Mannekragopleiding, 1981, of met voorwaardes of kennisgewings wat daarkragtens voorgeskryf of bestel is nie,
- (c) van toepassing op "slegs-arbeid"—kontrakteurs, werkende vennote en werkende direkteurs, prinsipale en aannemers;
- (d) van toepassing op voormanne en algemene voormanne,
- (e) nie van toepassing op klerke en administratiewe personeel nie;
- (f) nie van toepassing nie op persone wat betrokke is by die installering en/of bedrading van elektriese lig, verwarmings- of ander permanente vaste elektriese toebehore in geboue of die herstel of onderhoud van hysers in geboue,
- (g) nie van toepassing nie op universiteitstudente en -gegradueerdes in die bouwetenskap en konstruksietoetsinghouers, konstruksieopmeters en ander persone wat besig is met praktiese werk ter voltooiing van hul akademiese opleiding,
- (h) nie van toepassing nie op die Yster-, Staal-, Ingenieurs- en Metallurgiese Nywerhede soos omskryf in paragraaf G van die Registrasiesertifikaat van die Nasionale Nywerheidsraad vir die Yster-, Staal-, Ingenieurs- en Metallurgiese Nywerheid van Suid-Afrika,
- (i) onderworpe aan die bepalings van alle vasstellings gemaak deur die Nywerheidshof met betrekking tot die Bounywerheid en die Meubelnywerheid

2. CHAPTER I—CLAUSE 4 WAGES

(1) Substitute the following for subclause (1)

“(1) (a) *General*.—No employer shall pay and no employee shall accept wages at rates lower than the following, read with the remaining provisions of this clause

Employees	Wages
	Per hour
	R
1. Master craftsman.....	7,07
2. Craftsman	6,37
3. Artisan.....	5,66
4. Artisan (waterproofing).....	5,66
5. Waterproofing team leader	2,84
6. Waterproofing worker.....	2,24
7. Artisan (ceiling and/or partition erector)	5,66
8. Ceiling and partition worker	2,24
9. Learner ceiling and/or partition erector. First year	1,83
10. Learner ceiling and/or partition erector. Second year	2,24
11. Learner ceiling and/or partition erector. Third year	2,84
12. Artisan (resilient floor layer)	5,66
13. Resilient floor layer	4,04
14. Learner resilient floor layer: First year	1,83
15. Learner resilient floor layer: Second year	2,24
16. Learner resilient floor layer: Third year	2,84
17. Artisan (carpet layer)	5,66
18. Carpet fitter	4,04
19. Learner carpet fitter: First year	1,83
20. Learner carpet fitter: Second year	2,24
21. Learner carpet fitter: Third year	2,84
22. Artisan (mass manufacturing)	5,66
23. Machine operator (mass manufacturing).....	4,04
24. Joinery assembler (mass manufacturing)	2,80
25. Manufacturing worker (mass manufacturing)	1,47
26. Learner artisan (mass manufacturing) First year	1,47
27. Learner artisan (mass manufacturing) Second year.....	1,91
28. Learner artisan (mass manufacturing) Third year	2,57
29. Learner artisan (mass manufacturing): Fourth year	3,71
30. Artisan's assistant	3,85
31. Block layer	2,84
32. Learner block layer	2,24
33. Plant operator	2,44
34. Learner artisan First year.....	1,83
35. Learner artisan: Second year	2,24
36. Learner artisan: Third year.....	2,84
37. Learner artisan: Fourth year	3,85
38. Apprentice: First year	—
39. Apprentice: Second year	—
40. Apprentice: Third year	—
41. General worker—Area A, on construction	1,63
42. General worker—Area B, on construction	1,47
43. General worker—Area C, on construction	1,25
44. General worker—Not on construction	1,25
45. General worker—Waterproofing	1,63
46. General worker—Ceiling and partitioning	1,63
47. General worker—Resilient floor laying	1,63
48. General worker—Carpet laying	1,63
49. General worker—Mass manufacturing	1,28
50. Cleaner	1,14
51. Night watchman (per shift)	12,01

(2) Insert the following new subclause:

“(1) (b) The wage rate for Artisans who are registered with the Council as such and who have required that status through the learnership scheme of the Council shall remain at the rate as published by Government Notice R. 2374 in *Government Gazette* 9971 of 18 October 1985”

3. CHAPTER IV.—CONTRIBUTIONS TO FUNDS**CLAUSE I.—GENERAL**

(1) In subclause (5), delete paragraph (c).

(2) Reduce all contributions in subclause (5) by R1,50.

(3) Insert the following new subclause after subclause (5)

“(5A) Every employer shall pay to the Secretary of the Council the amount which he is required to contribute to the Building Industry Training Fund in terms of clause 7 (3) of Government Notice R. 1886 of 31 August 1984. The amounts collected in terms of this subclause shall from time to time be paid over to the Building Industries Federation (South Africa)”

2. HOOFSTUK I KLOUSULE 4. LONE

(1) Vervang subklousule (1) deur die volgende:

“(1) (a) *Algemeen*.—Geen lone wat laer is as dié hieronder genoem, gelees met die res van die bepalings van hierdie klousule, mag deur 'n werkgewer betaal en deur 'n werknemer aangeneem word nie

Werknemers	Lone
	Per uur
	R
1 Meestervakman	7,07
2 Vakman	6,37
3 Ambagsman	5,66
4 Ambagsman (waterdigting)	5,66
5 Waterdigtingspanleier	2,84
6 Waterdigtingswerker	2,24
7 Ambagsman (plafon- en/of afskortingsoprigter)	5,66
8 Plafon- en afskortingswerker	2,24
9 Leerling-plafon- en/of afskortingsoprigter Eerste jaar	1,83
10 Leerling-plafon- en/of afskortingsoprigter Tweede jaar	2,24
11 Leerling-plafon- en/of afskortingsoprigter Derde jaar	2,84
12 Ambagsman (veerkragtigevloerlêer)	5,66
13 Veerkragtigevloerlêer	4,04
14 Leerling-veerkragtigevloerlêer. Eerste jaar	1,83
15 Leerling-veerkragtigevloerlêer Tweede jaar	2,24
16 Leerling-veerkragtigevloerlêer Derde jaar	2,84
17 Ambagsman (matlêer)	5,66
18 Matinstalleerder	4,04
19 Leerling-matinstalleerder. Eerste jaar	1,83
20 Leerling-matinstalleerder. Tweede jaar	2,24
21 Leerling-matinstalleerder Derde jaar	2,84
22 Ambagsman (massavervaardiging)	5,66
23 Masjienbediener (massavervaardiging)	4,04
24 Skrynwermonteerder (massavervaardiging)	2,80
25 Vervaardigingswerker (massavervaardiging)	1,47
26 Leerling-ambagsman (massavervaardiging). Eerste jaar	1,47
27 Leerling-ambagsman (massavervaardiging) Tweede jaar	1,91
28 Leerling-ambagsman (massavervaardiging) Derde jaar	2,57
29 Leerling-ambagsman (massavervaardiging) Vierde jaar	3,71
30 Ambagsassistent	3,85
31. Bloklêer	2,84
32 Leerling-bloklêer	2,24
33 Toerustingbediener	2,44
34 Leerling-ambagsman Eerste jaar	1,83
35. Leerling-ambagsman. Tweede jaar	2,24
36 Leerling-ambagsman: Derde jaar	2,84
37. Leerling-ambagsman Vierde jaar	3,85
38 Vakleerling Eerste jaar	—
39 Vakleerling: Tweede jaar	—
40 Vakleerling. Derde jaar	—
41. Algemene werker—Gebied A, op konstruksie.....	1,63
42 Algemene werker—Gebied B, op konstruksie	1,47
43 Algemene werker—Gebied C, op konstruksie	1,25
44 Algemene werker—Nie op konstruksie nie	1,25
45 Algemene werker—Waterdigting	1,63
46 Algemene werker—Plafonne en afskortings	1,63
47 Algemene werker—Veerkragtigevloerlêer	1,63
48 Algemene werker—Matlêer	1,63
49 Algemene werker—Massavervaardiging	1,28
50 Skoonmaker	1,14
51 Nagwag (per skof)	12,01

(2) Voeg die volgende nuwe subklousule in:

“(1) (b) Die loonskaal vir ambagsmanne wat as sodanig by die Raad geregistreer is en wat daardie status verkry het deur die leerlingkema van die Raad, bly soos gepubliseer by Goewermentskennisgewing R 2374 in *Staatskoerant* 9971 van 18 Oktober 1985”

3. HOOFSTUK IV.—BYDRAES TOT FONDSE**KLOUSULE I.—ALGEMEEN**

(1) In subklousule (5), skrap paragraaf (c)

(2) Verminder alle bedrae in subklousule (5) met R1,50

(3) Voeg die volgende nuwe subklousule in na subklousule (5)

“(5A) Elke werkgewer moet die bedrag wat by verplig is om tot die Opleidingsfonds van die Bounywerheid ingevolge klousule 7 (3) van Goewermentskennisgewing R 1886 van 31 Augustus 1984 by te dra, aan die Sekretaris van die Raad betaal. Die bedrae ingevorder ingevolge hierdie subklousule moet van tyd tot tyd aan die Building Industries Federation (South Africa) oorbetal word”

(4) In subclause 11, substitute the amount of R0,19 for the amount of R0,12 wherever it appears.

Signed at Johannesburg this 27th day of March 1986

J. A. BARROW (Jr),
Chairman

G. H. BEETGE,
Vice-Chairman.

W. DE J. STAPELBERG,
General Secretary.

No. R. 2287 **31 October 1986**

LABOUR RELATIONS ACT, 1956

**LIQUOR AND CATERING TRADE, CAPE.—
RENEWAL OF MAIN AGREEMENT**

I, Mattheus Willem Johannes Le Roux, Director: Manpower, duly authorised thereto by the Minister of Manpower, hereby in terms of section 48 (4) (a) (ii) of the Labour Relations Act, 1956, declare the provisions of Government Notices R. 1297 of 24 June 1983, R. 2096 of 21 September 1984 and R. 736 of 18 April 1986, to be effective from 1 November 1986 and for the period ending 31 January 1987.

M. W. J. LE ROUX,
Director: Manpower.

No. R. 2288 **31 October 1986**

LABOUR RELATIONS ACT, 1956

**LIQUOR AND CATERING TRADE, CAPE.—
RENEWAL OF MAIN AGREEMENT**

I, Mattheus Willem Johannes Le Roux, Director: Manpower, duly authorised thereto by the Minister of Manpower, hereby, in terms of section 48 (4) (a) (ii) of the Labour Relations Act, 1956, declare the provisions of Government Notice R. 1298 of 24 June 1983 to be effective from 1 November 1986 and for the period ending 31 January 1987.

M. W. J. LE ROUX,
Director: Manpower.

**DEPARTMENT OF MINERAL AND
ENERGY AFFAIRS**

No. R. 2264 **31 October 1986**

MINES AND WORKS ACT, 1956 (ACT 27 OF 1956)

AMENDMENT OF REGULATIONS

The Minister of Mineral and Energy Affairs has, under section 12 of the Mines and Works Act, 1956 (Act 27 of 1956), made the regulations set out in the Schedule.

SCHEDULE

1. In these regulations "the Regulations" means the Regulations published under Government Notice R. 992 of 26 June 1970, as amended by Government Notices R. 303, R. 304 and R. 305 of 1 March 1972, R. 1346 of 4 August 1972, R. 2101, R. 2102 and R. 2103 of 15 November 1974, R. 513 of 1 April 1977, R. 1189 of 8 June 1979, R. 537 of 21 March 1980, R. 2227 and R. 2228 of 31 October 1980 and R. 2703 of 11 December 1981.

(4) In subklousule 11, vervang die bedrag R0,12 oral waar dit voorkom deur die bedrag R0,19

Geteken te Johannesburg op hede die 27ste dag van Maart 1986

J. A. BARROW (Jr),
Voorsitter

G. H. BEETGE,
Ondervoorsitter.

W. DE J. STAPELBERG,
Hoofsekretaris.

No. R. 2287 **31 Oktober 1986**

WET OP ARBEIDSVERHOUDINGE, 1956

**DRANK- EN SPYSENIERSBEDRYF, KAAP.—
HERNUWING VAN HOOFOOREENKOMS**

Ek, Mattheus Willem Johannes Le Roux, Direkteur: Mannekrag, behoorlik daartoe gemagtig deur die Minister van Mannekrag, verklaar hierby, kragtens artikel 48 (4) (a) (ii) van die Wet op Arbeidsverhoudinge, 1956, dat die bepalinge van Goewermenskennisgewings R. 1297 van 24 Junie 1983, R. 2096 van 21 September 1984 en R. 736 van 18 April 1986, van krag is vanaf 1 November 1986 en vir die tydperk wat op 31 Januarie 1987 eindig.

M. W. J. LE ROUX,
Direkteur: Mannekrag.

No. R. 2288 **31 Oktober 1986**

WET OP ARBEIDSVERHOUDINGE, 1956

**DRANK- EN SPYSENIERSBEDRYF, KAAP.—
HERNUWING VAN HOOFOOREENKOMS**

Ek, Mattheus Willem Johannes Le Roux, Direkteur: Mannekrag, behoorlik daartoe gemagtig deur die Minister van Mannekrag, verklaar hierby, kragtens artikel 48 (4) (a) (ii) van die Wet op Arbeidsverhoudinge, 1956, dat die bepalinge van Goewermenskennisgewing R. 1298 van 24 Junie 1983, van krag is vanaf 1 November 1986 en vir die tydperk wat op 31 Januarie 1987 eindig.

M. W. J. LE ROUX,
Direkteur: Mannekrag.

**DEPARTEMENT VAN MINERAAL-
EN ENERGIESAKE**

No. R. 2264 **31 Oktober 1986**

**WET OP MYNE EN BEDRYWE, 1956
(WET 27 VAN 1956)**

WYSIGING VAN REGULASIES

Die Minister van Mineraal- en Energiesake het kragtens artikel 12 van die Wet op Myne en Bedrywe, 1956 (Wet 27 van 1956), die regulasies uiteengesit in die Bylae uitgevaardig.

BYLAE

1. In hierdie regulasies beteken "die Regulasies" die Regulasies afgekondig by Goewermenskennisgewing R. 992 van 26 Junie 1970, soos gewysig by Goewermenskennisgewings R. 303, R. 304 en R. 305 van 1 Maart 1972, R. 1346 van 4 Augustus 1972, R. 2101, R. 2102 en R. 2103 van 15 November 1974, R. 513 van 1 April 1977, R. 1189 van 8 Junie 1979, R. 537 of 21 Maart 1980, R. 2227 en R. 2228 van 31 Oktober 1980 en R. 2703 van 11 Desember 1981.

FCI 'Bill of Rights' for SA's industry

133
Cape Times 5/11/86

JOHANNESBURG — A powerful case for a scientific wealth-sharing programme in which all in SA should participate was advanced at the annual convention of the Federated Chambers of Industry (FCI) here yesterday. The plea came as part of a report on the FCI's ambitious Business Charter.

in partnership not confrontation.

"Secondly, we are committed to installing monitored programmes to equalize opportunity in recruitment, training and education.

"This is an enabling exercise to break the historical disadvantages which many workers have found themselves locked into

"Thirdly, we recognize that business is currently the only area of contact on a major scale by blacks and whites at all levels. That is why we are concentrating our initial thrust within corporations and industries.

"But business needs to help expand the interface to also encompass political and socio-economic sensitization

"More broadly, many of the people in this country need a far broader access to decision-making and wealth — in housing, education, community development and many other areas.

Intensive work on implementing the charter had already been undertaken jointly with the management and staff of 120 private sector and para-statal organizations

Reinforced by a determined grass-roots, blood-sweat-and-tears programme, the injection of the charter into the economy is ahead of schedule and the results are "most encouraging", it was revealed

Reporting on the practical implementation of the charter, the chamber's Christo Nel said intensive work on implementing it had already been undertaken jointly with the managements and staff of 120 private sector and para-statal organizations, and the figure should reach 150 by the end of this month

The FCI Charter is essentially a "Bill of Rights" which seeks to replace confrontation in the workplace, and more widely, with co-operation under a system in which labour can achieve a greater stake in decision-making and in both existing wealth and in wealth creation

Nel told Sapa "The gist of the first objective is that managements and labour should approach joint enterprise

People in this country need a far broader access to decision-making and wealth — in housing, education, community development and many other areas

"Next the informal sector and small businesses need intensive lobbying at local government level for more deregulation and easier access to trading and markets

"Of course the Charter has to be understood from grass roots to the boardroom

"Also, there has to be a consolidated drive drawing support from across the entire spectrum of industry and commerce" — Sapa

'Higher wages pricing SA out of export market'

Unions 'must take part in Wesplan'

By AUDREY D'ANGELO
Assistant Financial Editor

THE trade unions must be involved in Wesplan — the campaign to create more jobs in the greater Cape Town area which was launched this week — if it is to have any hope of success, Plessey (SA) MD John Temple said yesterday.

Warning that the unions' co-operation was vital, Temple said that export orders and therefore jobs were already being lost because wage rises were pricing SA out of the market

'Special export projects'

He suggested that, purely to provide jobs, there should be special export projects making little or no profit, with union representatives on teams going overseas to secure orders and helping in the costing to keep prices competitive

These should be quite separate from the normal profitable business of the company, for which higher wages and salaries would be paid.

Temple emphasized, in an interview, that he was in favour of higher wages and living stan-

dards for SA workers and sought no confrontation with the unions in their efforts to secure this.

"I take the view of Henry Ford, who said he wanted the workers to earn enough to be able to afford to buy Ford cars.

"SA must pay people more so that they can spend more and pull the economy up by its bootlaces — but only if they are giving value for money on the export markets"

Temple said pressures in this country were pushing up labour costs, and it was not always possible to pass these on to the customer

"We used to do a lot of exporting but next year we have budgeted to do none. We have been priced out of the export market

"If a firm makes no profit on a product it drops it and if a product is dropped, job opportunities are lost"

Temple said it was cheaper to import a PABX switchboard than to make it in this country

This was not necessarily due to SA levels of productivity

"At Plessey, SA, people are as productive as at Plessey anywhere in the world, as far as out-

put per person goes, for the level of automation we have

"But we cannot compete with the British level of automation so we cannot produce as cheaply"

This situation would change, he said, if export markets were sufficiently large to make more automation worth while.

To achieve this, unions and manufacturers must get together round a table and achieve a balance.

'More jobs'

There should be a two-tier structure. There should be a normal programme of giving people good wages for products which could be sold profitably when these were costed in, and there should be special projects when there was an opportunity to get a large export order providing work for less skilled people who would otherwise be without it

"We can get large export orders for work that can be done by less skilled people, such as making cords. And if we can sit with the unions and agree to do it as a special project, telling them the price the market can stand, more jobs can be provided."

Business should join workers

6/11/86 Bus. DAY
BUSINESS should join workers in refusing to take part on the boards of State institutions like the Unemployment Insurance Fund (UIF) and Workers' Compensation Board (WCB), says outgoing FCI president John Wilson.

He said employers should work more closely with workers where there was a shared purpose and where conflict would not arise

He added "Workers' bodies refuse to participate on the boards of

133
Industrial Staff
the UIF and the WCB because they are denied a voice in the government of the country.

"It would be a truly meaningful act of solidarity if business, too, stepped down from these boards and instead negotiated with unions on such real, practical issues"

Business would then act as an "honest broker" in transmitting the concerns of labour to the State.

Hard year ahead for bosses

By Sheryl Raine

Wage bargaining next year is likely to be the toughest yet experienced by management, leading industrial relations consultant Mr Andrew Levy says.

Speaking at a conference in Johannesburg yesterday, Mr Levy said workers were looking to their unions to make good the ravages which inflation had inflicted on their earnings

He predicted that:

● Pressure would be exerted on employers by unions seeking national wage rates and enterprise-level bargaining. He believed the Congress of SA Trade Unions had set a minimum wage objective of about R3,50 an hour

● There would be increased industrial action related to wage talks, which would take the form of go-slows or overtime bans

"With any wage claim there is now a bigger chance that industrial action of some sort will follow," he said

● May Day would be a public holiday, but demands that June 16 be declared a holiday were not as well-supported

He believed demands for improved leave would be an important item on the bargaining agenda next year but that requests for a reduced working week would not be supported as strongly by unions

● See Page 9.

Fidelity assets top R1-bn

Assistant Financial Editor

THE Cape Town-based Fidelity group, including the Board of Executors, now has assets of R1,1-billion under administration

Announcing this with the results of the 18 months to September, chairman Stanley Lewis says it "not only reflects the drive for new business but also the growing acceptance of the broad range of services offered by the group"

The group, which has changed its financial year, achieved a net operating income of R6,8m for the 18 months to September

On an annualized basis this is R4,5m compared with R4,2m for the 12 months of 1985. The final dividend is 45c a share.

Group income after an increased tax bill of R2,8m (R1,9m) rose to R3,9m compared with R2,1m in 1985, and R2,6m on an annualized basis, and dividends rose to R1,7m (R1,1m)

Earnings rose by 14% to 281c compared with 164c in 1985 and 187c on an annualized basis and the dividend by 13% to 127c (75c) a share

Lewis reports that "both the Board of Executors and Fidelity Bank performed well, with assets under administration increasing from R700m to R1,1 billion"

He says it is "pleasing to report a 19% growth in after-tax profits

"This result was achieved against a backdrop of heightened political uncertainty, volatile financial markets and after making prudent increases in provisions"

Hostile reaction to export drive plan

Assistant Financial Editor

GETTING trade unions to help secure export orders for goods produced at competitive prices, in order to provide more jobs, is theoretically possible, says Cape Chamber of Industries industrial relations adviser Ian Newall

But he warned that in practice it might be possible only after a lengthy period to build up trust between the unions and management

'Information'

"It is not something that will happen tomorrow"

And any chance that unions might agree to a special export project with workers temporarily accepting less than the normal rate of pay would depend on how much information they were given about a firm's profits and how much they trusted this.

Newall was commenting on a suggestion by the MD of Plessey (SA), John Temple, that the unions could help SA firms to avoid being priced out of the export market through wage rises

Temple suggested that there should

be a two-tier system. Firms should pay normal rates for work done for the domestic market.

But, in order to secure export orders to provide work for the unemployed, there should be special projects with lower rates of pay in which union representatives should be told "how much the market will stand" and help with the costing

● Reaction from at least one union — Cosatu — is already hostile. Regional general secretary Nic Henwood has warned that the unions are unlikely to participate in Wesplan — the campaign to create more jobs in greater Cape Town — if it undermines their attempts to secure a living wage for their members

'Cheap labour'

Labour Reporter Hilary Venables writes that Henwood said unions were "not going to help provide cheap labour for bosses who were worried about their export markets"

"Jobs are not lost because of higher wages. They are lost because the bosses want to maintain their high profits", he said

my file 7/11/86

133

REPORT SLAMS SA EMPLOYERS

SOUTH African companies are still in the iron age in terms of retrenchment policy, according to a new report.

There is 'cause for serious concern' that so few firms have guidelines and proper procedures.

In a survey conducted by Potchefstroom University, and presented at a conference there on economics, business economics and manpower research, Ms Elsa Kruger of the National Manpower Commission, said it was found that while 65 percent of the companies surveyed had resorted to retrenchment, and

'Lack of guidelines on retrenchment'

58 percent were party to industrial council agreements, only about 15 percent (7 percent of the total) said their agreements provided for retrenchment procedures.

The firms approached employed some 375 000 of whom 54 percent were blacks, coloureds or Asians. More than 60 percent said they were affil-

ated to employer organisations, about half being members

However, only 24 percent confirmed that these organisations issued guidelines on retrenchment

Of the 58 percent of the overall sample who were party to industrial agreements, only about 15 percent (7 percent of the total sample) indicated that such agreements provided for retrenchment procedures ..

The report notes: Keeping in mind that some 65 percent of all participants had recourse to retrenchment, the lack of guidelines on retrenchment practices, is cause for (serious) concern.

INDUSTRIAL RELATIONS - EMPLOYERS' ORG.

1987

Own Correspondent

Chit Tips 9/7/87
Nafcoc
business
labour
charter *133*

JOHANNESBURG. — The National African Federated Chamber of Commerce (Nafcoc) has drawn up a national business charter intended to persuade large corporations and public employers to adopt fair labour practices.

Presented yesterday at the organization's 23rd annual conference, the charter is meant to supersede such employment guidelines as the EC and Sullivan codes, which "do not go far enough".

Among the commitments the code calls for are:

- The SA business community should commit itself to working towards the eventual elimination of racial discrimination in the work-place and in all facets of private and public life;
- The private sector should support the principle of the lifting of all laws and regulations that impede black economic advancement, participation and upward mobility in the work situation;
- The private sector should undertake to contribute generously to the improvement of black education, the promotion of community development and upgrading programmes;
- The private sector should strive for political representation of all citizens at national, provincial and local structures of government.

Reach out to workers — De Beer

CME 11/27/75
12/16/77
133

Own Correspondent

DURBAN. — Business must reach out to black workers, understand their needs, fears, grievances and demonstrate "that their own best hope for the future, like ours, lies in the successful functioning of a free enterprise economy"

This was the principal thought in Zach de Beer's speech last night to Durban businessmen

He is chairman of the Southern Life Association and Anglo American Property Services

De Beer said that there was a danger of "estrangement, frustration and alienation among our black people and therefore the industrial workers"

It was easy enough for business to wash its hands and blame the government, and apartheid, for this situation but this attitude would not get business far — it was more important for management to bridge the gap as part of its system

"Business must be prepared to devote real resources to this task, to give it real priority SA's future may in the end depend on this issue as much as on any other"

On other points he said

□ Economic integration had reached a point which whites had come to firmly accept but there was a danger that blacks might now start rejecting the possibility because they were confined to the "bottom of the pyramid"

□ Colour bars had to go and intensive training for black workers provided and the black people should become part of the planning and production process

□ Urban housing was a national priority with the provision of suitable land a pressing need — money was not a major factor, land was A healthy property market required that the Group Areas Act should go

In industrial relations, to grant workers rights without parallel political rights put management in an "excruciatingly difficult position"

SA should go for the smokestack, resource-based, labour intensive and export-orientated industries which meant maintaining an under-valued rand

The inward flow of capital, now reversed, demanded a high level of domestic savings and a strong current account surplus (more should be exported than imported)

Proposal for 10 Cops moved to firmer

in the issue price of 35c

CAT 4/17/82

3/7/82

133

~~133~~
~~133~~
~~133~~

FCI criticizes union crackdown

Own Correspondent

JOHANNESBURG — Organized industry has told government any crackdown on the black labour movement would be wrong, and that unions' political activities will not normalize till their members are given an effective say in running the country.

These views are contained in a Federated Chamber of Industries (FCI) memorandum sent to the Minister of Manpower, Mr Pietie du Plessis, on May 15 — during the SATS strike and soon after the events at Cosatu House

which raised fears that a crackdown was imminent

The FCI criticizes the approach of the "security establishment" that unionists will not be harassed and/or detained "as long as they are involved in 'bona fide trade union activities'"

It says such a view is out of touch with reality in that "it gives rise to a dangerous mode of thinking which suggests that the political dimensions of industrial relations issues can be resolved by using physical force against a few communist agitators and revolutionaries"

It is many employers' experience that the leaders of organizations like Cosatu and the

National Council of Trade Unions are not communists threatening free enterprise, but legitimate representatives of organized employees' views

The FCI says there is an urgent need for serious and open discussion to clarify the roles of the Manpower Department, the security establishment and employers in industrial relations.

Industry has accepted it will become involved in the larger black struggle for political rights and greater economic welfare

The FCI called for a reduction in confrontation on all sides

Neither the minister nor the Director-General of Manpower could be reached for comment

W/EARLS
31/1/87

Political ~~role~~ role for unions

LABOUR
AFFAIRS
DICK
USHER



RECENT rueful recantations by prominent entrepreneurs of their support for the tri-cameral system have hardly increased unionists' confidence in the political acumen of the business community.

Although it's of not much more than passing interest compared to the daily hurly-burly of shop-floor relations, many unionists are in the we-told-you-so mode on the issue.

A campaign against the new constitution was one of the few overtly political stances taken by the Federation of South African Trade Unions (Fosatu), in alignment with many other community organisations.

At the same time that the business community is catching up with the unions on this issue, however, there is a growing realisation that the two could share a common purpose.

The idea was expressed late last year in an address to the Federated Chamber of Industries by Mr John Wilson, outgoing president, but it had been around before that.

At its base is the concept that capital and labour have demonstrated their ability to negotiate viable agreements on a wide range of shopfloor issues, then why not on issues of larger social concern such as the future of the country?

They are already negotiating successfully on some issues where the Government has failed to provide any resolutions — the widespread acceptance of labour's right to a May Day holiday, for example.

The union movement constitutes the one force with legitimacy for three major actors in the South African drama — workers, capital and the Government — and as such will fill an increasingly important role in the future acts of the play.

And because it is the one outlet where the black community can negotiate on an equal footing with other parties, it's also probable that more and more major social issues are going to be argued out round the industrial negotiating tables.

Both parties have a full grasp of the consequences of failing to reach negotiated settlements on industrial issues, which both have to bear, and this awareness extends to the costs of failing to arrive at a negotiated settlement on the ultimate issue.

...demand that working hours a day as a holiday.

First employer to condemn Cosatu siege

THE chairman of a major multinational has condemned government pressure on the Congress of SA Trade Unions — the first to do so since police laid siege to Cosatu House in Johannesburg a month ago.

Employer organisations, organised commerce and industry have been silent on last month's raids and alleged harassment. But last week John R Wilson, chairman of Shell SA, warned that state pressure on Cosatu could "bode ill for the future."

"The raiding of offices, the banning of meetings and the indiscriminate beating and arrest of hundreds of workers is not likely to crush the union," he said. "Rather, it will

**WEEKLY MAIL REPORTER,
Cape Town**

strengthen their resistance and support and will have adverse ramifications for stable industrial relations, the effects of which will be felt throughout industry

"Violence in any form must be condemned, no matter who the perpetrator. But violence will not abate under the present repressive conditions."

Wilson said trade unions could play a "vital and important role" in a negotiated settlement to the country's problems. "Sadly, though," he said, "as violence, high-handed and strong-arm tactics are employed in

what is transparently an attempt to crush an increasingly powerful government opponent, one's belief in that negotiated future becomes even more fragile."

He condemned what he termed the "apparent wanton destruction of Cosatu's property and possessions" during the Cosatu House siege in Johannesburg last month, particularly the seizure of affiliates' records and books when many were preparing for annual wage negotiations.

"Businessmen are realising more and more that labour and capital should be seeking closer collaboration in attempts to boost the country's shaky economy," he said.

133 ~~133~~ W/Mail 22-28/9/87

...positions in ...

ASSOCOM-FCI MERGER

Leading from behind

Moves towards a merger of SA's two major employer bodies, Assocom and the FCI, have been put on hold — but two powerful affiliate bodies, the Johannesburg Chamber of Commerce (JCC) and the Transvaal Chamber of Industries (TCI), are becoming more outspoken in their demands for change

Last week, outgoing JCC president Pat Corbin told businessmen that the JCC was prepared to pool its assets (estimated at about R5m) with the TCI to form a common Witwatersrand Chamber of Commerce and Industry, even if this meant going over the heads of the smaller Reef chambers.

F/M
133
3/4/87

76



The JCC owns the building it occupies, while the TCI has a short-term lease with Allied Building Society, so the TCI would be more secure in the chamber of commerce offices. JCC members overwhelmingly support the move and so has its council

Incoming JCC president Aubrey Pitt hopes the rationalisation will be even wider. "We're talking to the Soweto Chamber, the coloured chamber and we hope for greater co-operation with the Johannesburg Sakekamer," he says

Acting TCI president Hennie Viljoen is more cautious "We are exploring every avenue of co-operation and I expect to see joint TCI-JCC committees in future. But there's no immediate prospect of a merger"

Indeed, Assocom president Harold Groom's much-publicised meeting last week with his FCI counterpart Hugo Snyckers was apparently not even "a talk about talks"

Snyckers says even after the FCI's rationalisation moves, it would continue providing much the same service "We will streamline our services and carry them out more cost-effectively"

But with half the head office staff retrenched and some services disappearing, this might not be too easy. The FCI is closing its parliamentary office, a well-supported lobbying and information centre

Senior Assocom sources refuse to speculate publicly about the prospects for a merger and believe that any more discussion could be counter-productive. National executives of both bodies will hold their mid-year meetings in May and the issue has been put aside until then

Assocom seems to be in no hurry to follow the JCC's lead and wants the FCI to make the first moves. Senior sources say ongoing JCC-TCI talks "will have no bearing" on possible merger developments in the parent bodies

Corbin claims the FCI is out of step with its members' views "FCI corporate council members I have canvassed are overwhelmingly in favour of merger," he says. "A chamber has no authority unless it represents its members" ■

The widening gulf

133

Divisions within organised business in SA go deeper than the split between Assocom and the Federated Chamber of Industries (FCI) over the Margo recommendations on tax reform.

There is serious disagreement within FCI on its pro-Margo stand — specifically on its acceptance of the Comprehensive Business Tax (CBT). The divisions flared in public for the first time at the Assocom congress in East London last week.



On the eve of the State President's summit on taxation reform, FCI issued a formal statement in support of the CBT.

The same day, chairman Roderick Draper of the Natal Chamber of Industries (NCI) Taxation Committee and of the Pinetown-New Germany division of the NCI, attending the Assocom congress as a delegate of the Durban Metropolitan Chamber of Commerce, publicly dissociated his branch from the published remarks.

He told congress that Natal, which is the largest constituent chamber in the FCI, "is very definitely not in favour of the CBT. In fact we vehemently disagree, and we have made our position quite clear to the FCI executive council."

He has since confirmed that position to the *FM*. "The Taxation Committee actually recommended to FCI that it should not accept the CBT and made it known that we at NCI did not agree with it. We prefer Value Added Tax, but if we cannot have that we would accept something along the Assocom lines."

"We were absolutely amazed when FCI, in its wisdom, publicly accepted the CBT

and my intention at the Assocom congress was to let members know that at least some industrialists still have their heads screwed on the right way."

Draper was not the only dual FCI-Assocom member at the congress. Yet he and his fellows voted in favour of the Assocom motion accepting "in modified form many of the changes in personal and corporate tax proposed by the commission" and rejecting the CBT outright.

That public disclaimer will not endear Assocom to the FCI and should certainly add spice to any discussion on Margo at the FCI convention in Bloemfontein next week — if there is any discussion. Tax reform is not on the agenda, only a speech by Department of Finance Director of Public Finance Dr V E Solomon on "Government priorities and tax-

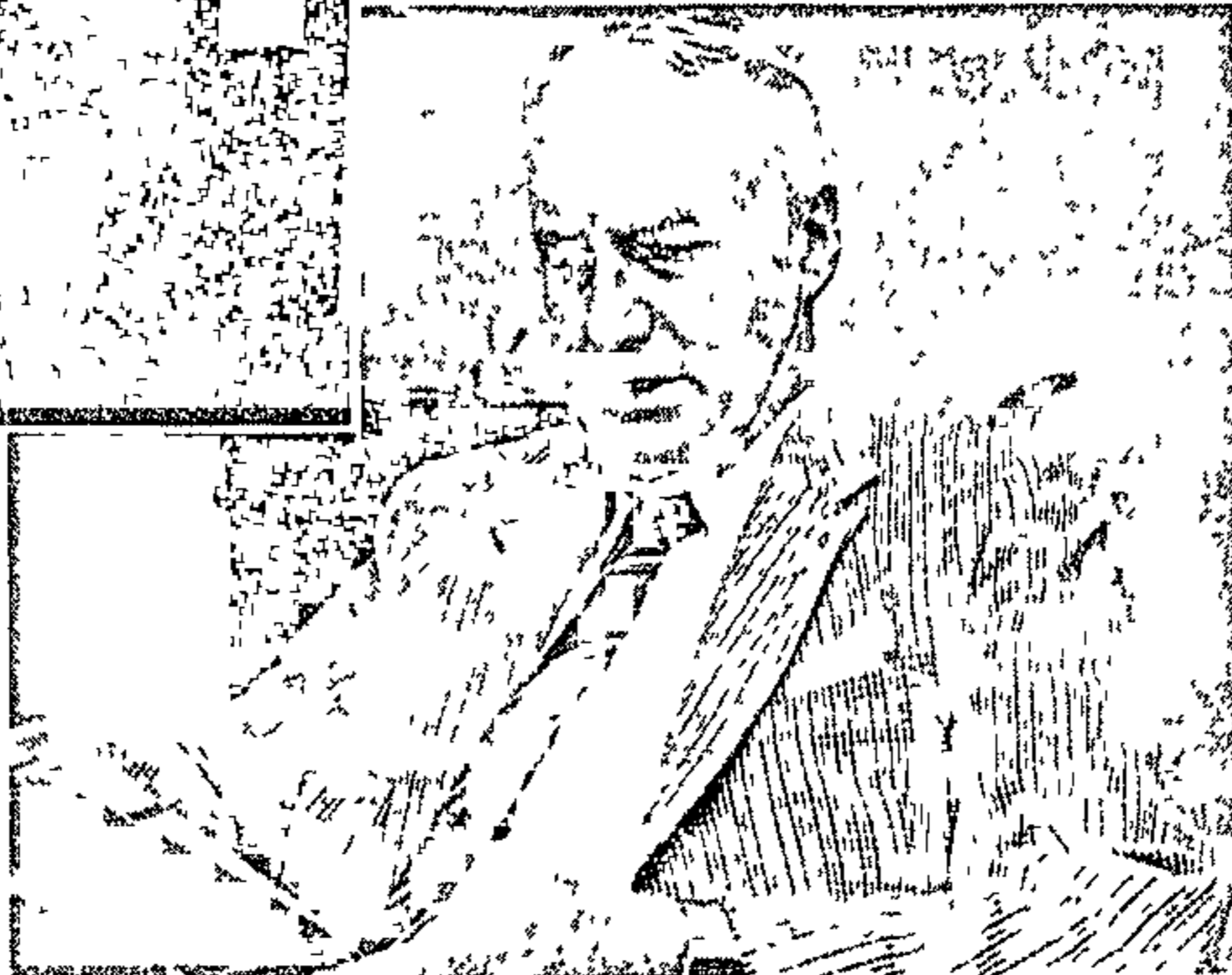

FCI's Snycker's, Assocom's Groom... shall we dance?

ation in the light of the principle of deregulation."

Nor is the major issue of the Group Areas Act.

In fact, the convention generally underlines the increasing divide between FCI and Assocom, and would indicate that organised business in SA is moving closer to conflict rather than co-operation.

Assocom concentrated on topical, bread-and-butter issues. But the congress — which should have been a premier event on the South African business calendar — was effectively sidelined by other events.

It was upstaged by the presidential tax summit, which drew off many top businessmen and much media attention and by the SA Agricultural Union congress and its detailed report on the aftermath of the Natal floods.

Yet its informed rather than inflamma-

tory approach to issues such as decentralisation, deregulation, privatisation and urbanisation hit home. The message to government was loud and clear: get on with the job of reform.

FCI, on the other hand, does not intend to formulate any specific motions for reference to government. The theme coincides to a degree — "The potentials and pitfalls of deregulation and privatisation" — but the emphasis is dramatically different.

President Hugo Snyckers maintained at a pre-convention press conference in Johannesburg this week that "the present industrial strategy (of government) is not at fault, it is not being pursued urgently enough."

Assocom's assertion is that it is very much at fault.

Further divergence between the two bodies occurs over the issue of merging. Outgoing Assocom president Harold Groom invited it, saying openly that unification was "inevitable."

FCI's Snyckers "noted" the remarks and said they would "receive attention," but emphasised the chamber's strong belief that manufacturers should have separate representation.

Call for closer ties between Assocom and FCI

CME-7095
21/10/87
133

From DAVID FURLONGER

EAST LONDON. — Closer ties between employer bodies such as Assocom and the Federated Chamber of Industries (FCI) are inevitable, Assocom president Harold Groom said last night.

He said while special services would always be needed for particular sectors of commerce and industry, the areas of common ground were growing all the time.

Addressing the opening of Assocom's National Congress in East London, Groom said the economies of scale to be achieved from sharing services deserved examination by employer bodies.

As president for the last year, Groom has been in the thick of attempts to forge more co-operation — even a merger — with the FCI. He also favours discussions with the Afrikaanse Handelsinstituut (AHI) and other employer bodies to find areas of common activity.

He said last night: "I would there-

fore, in the first instance, appeal to my colleagues in the FCI, with whom we have a close affinity, to give serious consideration to this matter in the coming year.

"The recent creation of the Witwatersrand Chamber of Commerce and Industry (WCCI) through a merger between the Johannesburg Chamber of Commerce and the Transvaal Chamber of Industries indicates that the arguments for co-operation are profound.

"The case for closer collaboration among major employer bodies has almost become a structural inevitability."

Defending the role of business in pressing for reform, Groom insisted such activity was not party political.

Even where such pressure involved the taking of political decisions to satisfy it, "it should be understood that our motivations are not party political, but economic", Groom said.

"Assocom is not an organization of protest but one of negotiation."

(133) 13/day 21/10/87

SA now 'facing moment of truth'

EAST LONDON — SA had reached a moment of truth in its history and the next five years would decide what the next 50 years would hold, National Education Minister F W de Klerk said yesterday.



● DE KLERK

De Klerk told Assocom's annual meeting the success or failure of the attempts now being made to lay a stable, peaceful and prosperous foundation for SA, would determine the country's future.

Although the country was facing adversity, this should be seen as a challenge to all well-meaning South Africans.

Guidelines

Setting out government's guidelines for meeting the challenges facing the country, De Klerk said a distinction should be made between legitimate grievances and unreasonable demands. To accede to the latter, or to ignore the former, was "just another form of suicide".

SA could not rely on help from the outside and had to solve its problems itself.

The country as a whole and each of its components carried a tremendous conflict potential and, unless it was properly contained, it could destroy the country. Stability should never be placed at unnecessary risk.

De Klerk said the maintenance of order was a key concept in the quest for a prosperous and secure SA — Sapa.

Assocom president predicts ...

Closer links for employer organisations

DAVID FURLONGER

EAST LONDON — Closer ties between employer bodies such as Assocom and the Federated Chamber of Industries (FCI) are inevitable, Assocom president Harold Groom said last night.

He said while special services would always be needed for particular sectors of commerce and industry, the areas of common ground were growing all the time.

Addressing the opening of Assocom's National Congress in East London, Groom said the economies of scale to be achieved from sharing services deserved examination by employer bodies.

As president for the last year, Groom has been in the thick of attempts to forge more co-operation — even a merger — with the FCI. He also favours discussions with the Afrikaanse Handelsinstituut (AHI) and other employer bodies to find areas of common activity.

He said last night "I would therefore, in the first instance, ap-

peal to my colleagues in the FCI, with whom we have a close affinity, to give serious consideration to this matter in the coming year.

"The recent creation of the Witwatersrand Chamber of Commerce and Industry (WCCI) through a merger between the Johannesburg Chamber of Commerce and the Transvaal Chamber of Industries indicates that the arguments for co-operation are profound.

"The case for closer collaboration among major employer bodies has almost become a structural inevitability."

Defending the role of business in pressing for reform, Groom insisted such activity was not party political.

Even where such pressure involved the taking of political decisions to satisfy it, "it should be understood that our motivations are not party political, but economic", Groom said "Assocom is not an organisation of protest but one of negotiation."

Effective management needed

FCI, chamber

can this
13/3/87

**movement under
fire — report**

33

From DAVID FURLONGER

JOHANNESBURG — The Federated Chamber of Industries (FCI) and chamber of industries movement is losing credibility among leading businessmen

It lacks leadership and effective management, is no longer certain of its role, and is in danger of attempted manipulation

These are the findings of a confidential report being studied by the FCI's management board. The report, by management consultancy Pim Goldby, was commissioned by the FCI late last year

Context

FCI officials denied yesterday the report was damaging and said its findings "should not be taken out of context"

According to Goldby, the chamber movement has problems on two fronts — credibility and financial viability

The report says the chamber of industries movement no longer has a clear definition of what it represents. Objectives are open to interpretation and reflect lack of unity. There is no cohesive image and a growing disillusionment among members

It says both the FCI and movement as a whole have lost credibility with many of the country's most influential business leaders

The Goldby report says the chamber of industries structure no longer serves the interests of the movement. It warns that interests "close to home" — at FCI level — are allowed to overshadow those of the movement

It says there is need for strong leadership in a changing South Africa and that the movement requires "more effective management"

THE FCI has already announced it is cutting staff in order to save costs. The Goldby report says the financial position of the movement generally is poor and worsening

Membership is decreasing and there is little incentive for chambers with income outside subscriptions to increase their own membership. The movement must also find alternative income to make up for that lost when the Corporate Forum — a group of more than 50 major industrial enterprises — withdrew last year

A leading industrialist said last night the report reflected the view of many businessmen that the FCI was not consulting its membership about many of its decisions, particularly its outspoken role in pressuring the government to speed up the reform process

Concern

He said "While many of us have no argument with the political stance the FCI has taken, too often it is done without proper consultation. There has been concern with the way it has presented its case to government. It was not done in a particularly diplomatic manner"

FCI management board chairman Norman Duncan said a decision on the findings would be taken before the next executive meeting in May. He added "We are considering it, but at this stage the views expressed are merely those of Pim Goldby"

FCI president Hugo Snyckers said "It is important the report should not be taken out of context. We asked Pim Goldby to tell us what was wrong with the movement, not what was right. When you ask for something like that, of course it is going to be full of criticisms"

ANC 13 'not criminals'

Sendu
331/8/87

THE Freedom Charter ran like a golden thread through all the statements of the 13 convicted ANC guerrillas, the Supreme Court heard this week.

Denis Kuny, SC, was speaking in mitigation in the trial of self-confessed Western Cape commander of Unkhonto weSizwe, Lizo Ngqungwana and 12 others.

They are Cyril Ntabeni, 31, of Khayelitsha, Mithetho Myanya, 37, Joseph Mkhuhlwana, 31, Anderson Ncivata, 34, Reed Macozoma, 27, Norman Siseko Macanda, 29, all of Langa, have been convicted of harbouring or assisting terrorists.

Joseph Ngoma, Themburkosi Mzukwa, 26 of Langa, Sazi Veldman, 29, Quentin Michels, 27, of Mandalay and Cecil Esau have been convicted of terrorism.

Commendable

Kuny described the charter's aims and principles as "commendable and desirable in any language."

"It was understandable that the men have committed themselves to work for a society based on the principles of the Freedom Charter

"To people who have been deprived and discriminated against, the document must appear as a shining light," Kuny said

"The men were not criminals in the true sense that they had robbed, raped, stolen or killed."

He said the judge might have gained the impression that the men were of some integrity and intelligence.

"Their statements ring true I believe there is nothing the State can seriously challenge when it comes to the experiences of the men

"I suggest their own community would not look upon the acts as harsh as the white community," he said.

Limpet mine

"It was unfortunate that sending people to court did not deter others

"We must take note of the state of the society from which they come and discontent within it"

He referred the court to a Natal case in which the judge commented on the real and legitimate grievances of black people"

Kuny said the court should impose lenient sentences as all had been involved in one limpet mine incident

Ntabeni and Macanda had been in jail for nine months and others for 15 months.

Gladwin Mabengeza of Guguletu was a man of principle and conviction who did not feel he had to apologise

Sentence is expected next week.

'Give workers shares and say'

By AUDREY D'ANGELO
Financial Editor

IT is useless for companies to offer shares to their workers in the hope of eliminating "them-and-us" hostility unless this is accompanied by consultation and fair treatment, says Albert Koopman, former Cashbuild MD and now an industrial-relations consultant.

Koopman, who pushed up profits at Cashbuild through a worker participation scheme, is now retained as a consultant by a number of major companies.

Almost every seat was taken at a seminar organized yesterday by the Cape Chamber of Industries and the Institute of Personnel Management at which Koopman explained the increasing importance of good industrial relations and how to achieve them.

In an interview, he said his successful policy of encouraging worker participation at Cashbuild was "the difference between action and dreaming".

He said that when he took over at Cashbuild, profits were falling "and things were so bad there that we had to make it a 'crime' to use offensive bad language to the staff".

Koopman rocked the business world not only by involving workers at all



Albert Koopman

levels in planning the firm's strategy, but by dismissing three of the management staff when complaints about them were found to be justified.

"This was a complete reversal of the previous situation when any worker who caught a manager out in wrongdoing was likely to be dismissed, so they kept their mouths shut about it," said Koopman.

He considers worker participation essential in running a business in SA today.

"If we want to create a second Japan in this country, that is the way to go."

"It's not a black-white thing, although it tends to be that in practice in this country, but staff and management working together in their common interest."

He thinks the trade unions are willing to cooperate with business, and are aware that both sides are interdependent. "It is business that is intransigent."

Koopman is in favour of profit-sharing incentive schemes based on productivity, but he said. "I disagree with any policy of issuing shares before providing justice in the workplace and restoring the workers' dignity and pride."

"I don't advise any company to offer shares in lieu of a meaningful say in one's working life. There should be total worker involvement in all things affecting their rights."

His dealings with black labour have made him optimistic about the future of whites in SA.

"The goodwill of blacks is unbelievable—we must tap it."

48645 27/8/87 (133)

MP's plan for farmworkers' union

A NATIONAL PARTY MP plans to help farmworkers in his constituency form unions before "leftists radicals" do so.

Speaking during the agriculture vote debate in the House of Assembly yesterday, Mr J A Jooste said it was inevitable that the farmworkers would form unions.

"I will go to my farmworkers and help them organise before the leftist radicals do," said Mr Jooste (NP De Aar). He asked the Conservative Party member who had spoken before him: "Does he think they will not organise?"

"You are the leftist radicals," a CP member retorted.

"Do you want black farmworkers in the regional services councils," asked Professor S C Jacobs (CP Losberg).

Speaking after him, Mr W J D van Wyk (CP Witbank) asked the Minister of Agriculture, Mr Greyling Wentzel, to state where he stood on black farmworker representation on RSCs. He asked the Minister to intervene with the Minister of Manpower, Mr Pietie du Plessis, to ensure that farmworkers did not unionise.

Farmers did not want the

blacks on the farms unionised and the blacks did not need it, Mr van Wyk said. — Sapa.

MP ordered out

THE leader of the PRP, Mr Pat Poovalingam, was ordered from the House of Delegates after refusing to withdraw the word "liar".

Chairman of the Ministers' Council Mr Amichand Rajbansi said Mr Poovalingam had tried to get civil servants to apply pressure to a "certain female".

Mr Poovalingam said that anyone who claimed he had done such a thing was "a liar."

Employers urged to support change

CAE Toms 4/11/87

133

Staff Reporter

EMPLOYERS could not ignore the real moral outrage of the Western world against so many of SA's repressive systems as "personified by the often wild distortions of the fundamentally outdated" apartheid system. - This was said yesterday by John Herdman, president of the South African Motor Industry Employers' Association during his presidential address at the 78th annual conference of the Motor Industries Federation

As one of the largest organizations in the country, the association could not simply react to the changes, take up a defensive position and shrug off the "inevitable moves" towards reform.

While the association had no right to demand of the government actions which were totally impractical or impossible to achieve, it did recognize and "strongly support the need for change in an organized and planned way".

The rapid growth of the trade union movement had promoted change to a great extent and employers were particularly concerned where those changes affected their business.

The growth of the "non-white" trade unions had been dramatic and the years of chaos had gradually given

way to intelligent organization and improved administration.

The association should anticipate the needs and inevitable demands of their employees and should recognize that they were simply trying to achieve a higher standard of living and a better way of life for themselves and their families.

The advancement, development and welfare of the lower paid workers should be promoted because if it was not done, increased conflict could be expected, Mr Herdman said.

Motor mechanics training revised

CAE Toms 4/11/87

Staff Reporter

THE syllabi and curriculum of the current "hopelessly out-of-date" training system of motor mechanics have been re-organized.

John Herdman, president of the South African Motor Industry Employer's Association, said yesterday the move would ensure people are trained to meet current demands

In terms of the latest government policy, the training of artisans would become the responsibility of each individual industry. Current discussions will lead to the establishment — in conjunction with trade union associates — of an own National Industry Training Board for the motor industry

The Training Board would eventually be responsible for the accreditation and trade testing of apprentices

Herdman said it was envisaged that a modular system of training would be established whereby an apprentice would achieve competence in all sections of his trade, and would be passed on the basis of ability.

London stocks afterhours: Blyvoors 550, Bracken 207, Driefontein 21¹/₂, E Rand Pro 10³/₈, Freegold 12¹/₄, Grootvlei 21⁵/₁₆, Harmony 11³/₄, Leslie GD 178, Randfont 92¹/₂, Southvaal 50, Stifontein 5⁷/₈, Venters 14.

Commodity Index 1658,1
Platinum \$513,00
Palladium \$114,50
Raw Sugar £107,60

Wt News 7/11/87 (135) (137) (139)

BUSINESS

**LABOUR
AFFAIRS
DICK
USHER**



Views worth putting on record

A WIDE range of topics was covered this week by John Herdman, president of the South African Motor Industry Employers' Association, in his annual report

As head of one of the largest employer organisations in the country his views are worth recording.

ON CHANGE. I have never supported demands for dramatic and immediate change

We as an association have no right to demand of our Government, actions which are totally impractical or impossible of achievement. But we do recognise and strongly support the need for change in an organised and planned way, the recognition of the rights of all and the opportunity for participation of everyone in the achievement of a better way of life.

The natural reaction to change is one of fear, a fear that we will not be able to adapt to new situations and natural reluctance to change the often deep and inbred sense of values which most of us have accepted as a matter of course without any great degree of personal thought

ON TRADE UNIONS: As employers we are naturally concerned with the changes taking place in our country which affect our business and these are to a great extent being promoted by the extraordinarily rapid growth of the trade union movement

The growth of the trade unions has been dramatic and the years of chaos are gradually giving way to intelligent organisation and improved administration and we must expect these improvements to continue

The increasing maturity of the trade union movement is a great tribute to the leaders and officials who have emerged over the past few years . . .

Unfortunately, but understandably, the trade unions, particularly the emerging black unions, are adopting a strongly politically influenced approach

We should not be surprised as this has been the pattern of trade union development since the origin of the first trade unions and we, in negotiating with the trade unions, must expect to be faced with politically motivated demands

We cannot respond to these demands as this is a matter for the Government of the country.

ON EMPLOYEES: We must anticipate the needs and inevitable demands of our employees. We must recognise that they are simply trying to achieve a higher standard of living and a better way of life for themselves and their families

We must promote the advancement, development and welfare of the lower paid workers as fast as it is economically possible for us to do. If we do not do so sensibly and quickly we can only expect increased conflict and I believe that the interest of our industry, our employers, employees and our country as a whole require above all peace, stability and understanding

ON UNEMPLOYMENT: Unemployment still remains the country's greatest single problem .

The poverty, deprivation and unfulfilled expectations of our lower skilled people continues to feed the despair and misery which has been the main cause of the social unrest which continues to plague so many parts of our country .