

GOLD

9/1/81 — 28/12/81

# The golden year 79 FM 9/1/81

1980 was a good year for those who held the right stocks at the start. It was much more difficult for those looking for reasonably-priced investments during the year. And it was most frustrating for those who started with too little, too late

After a very good run in 1979, Diagonal Street started 1980 with a bang. The Soviet invasion of Afghanistan took place just before Christmas, and the Iranian hostage drama was at its peak in the New Year with front-page news virtually every day. Bullion, as a result, moved up from \$420 at the end of November 1979 to \$560 by the first trading days of January.

Diagonal Street reacted with extraordi-

down. There were rumours that the US hostages were soon to be released, and Federal Reserve Board chairman Paul Volcker made murmurings about renewed US Treasury gold sales which were eventually to be unfulfilled

IMF auctions were still going on, of course, but at this stage they were tending to buoy up bullion by providing more buying opportunities, rather than depress it through placing surplus stocks on the market.

Robert Mugabe's landslide win in the Zimbabwe elections in early March hardly moved the market, though Diagonal Street had previously been sluggish ahead of the

generally at the time of the possibility of a significant further decline in bullion which was at that time establishing a base around \$550 following a sharp fall from above \$600.

But again, those with foresight were able to pick up industrial shares at relatively low levels in anticipation of accelerating corporate profits from the then-growing consumer boom. The JSE Actuaries industrial index, which had opened the year at 456.7 had by then reached 509.9.

The first quarter of the year saw the average London gold fix at just over \$632, but it opened the April/June quarter churning around in the mid-\$500s. US interest rates were by that time up to 20%, and president Jimmy Carter was finding even these levels ineffective in cooling the economy down.

## Gold on the move

It was only in mid-April that the cost of money in the US showed its first sign of cracking, and further ructions in the Middle East pushed bullion back up to \$535. The JSE Actuaries all golds index, which a year before had hovered around 234 points, was now up to 482, having broken 500 in the latter stages of January.

Then came a relatively quiet period on Diagonal Street, with brokers waiting for another lead. Though US interest rates were on the decline, the rate of decline was still fairly slow, and daily volumes were generally around the 2.2m shares mark. And when bullion fell back to below \$500 there were some serious losses on the golds board.

The volatile effects of world politics on bullion were shown up yet again when the abortive raid on Iran by the US in an attempt to free the hostages was reported. Gold bounced up to over \$550, but the price quickly fell back to just over \$510 and share prices responded accordingly.

At this time, platinum and other precious metals were following gold closely though with somewhat more uncertainty. Copper prices moved widely, though the US raid put some strength behind the price. US Secretary of State Cyrus Vance's resignation over the debacle in the desert didn't help matters.

All the while, brokers looking at the industrial board were growing more concerned over one phenomenon which was increasingly becoming evident.

Despite a continuing and ever-growing stream of handsome company results being generated by high levels of consumer expenditure, share prices were stagnating, and the index was still below the levels

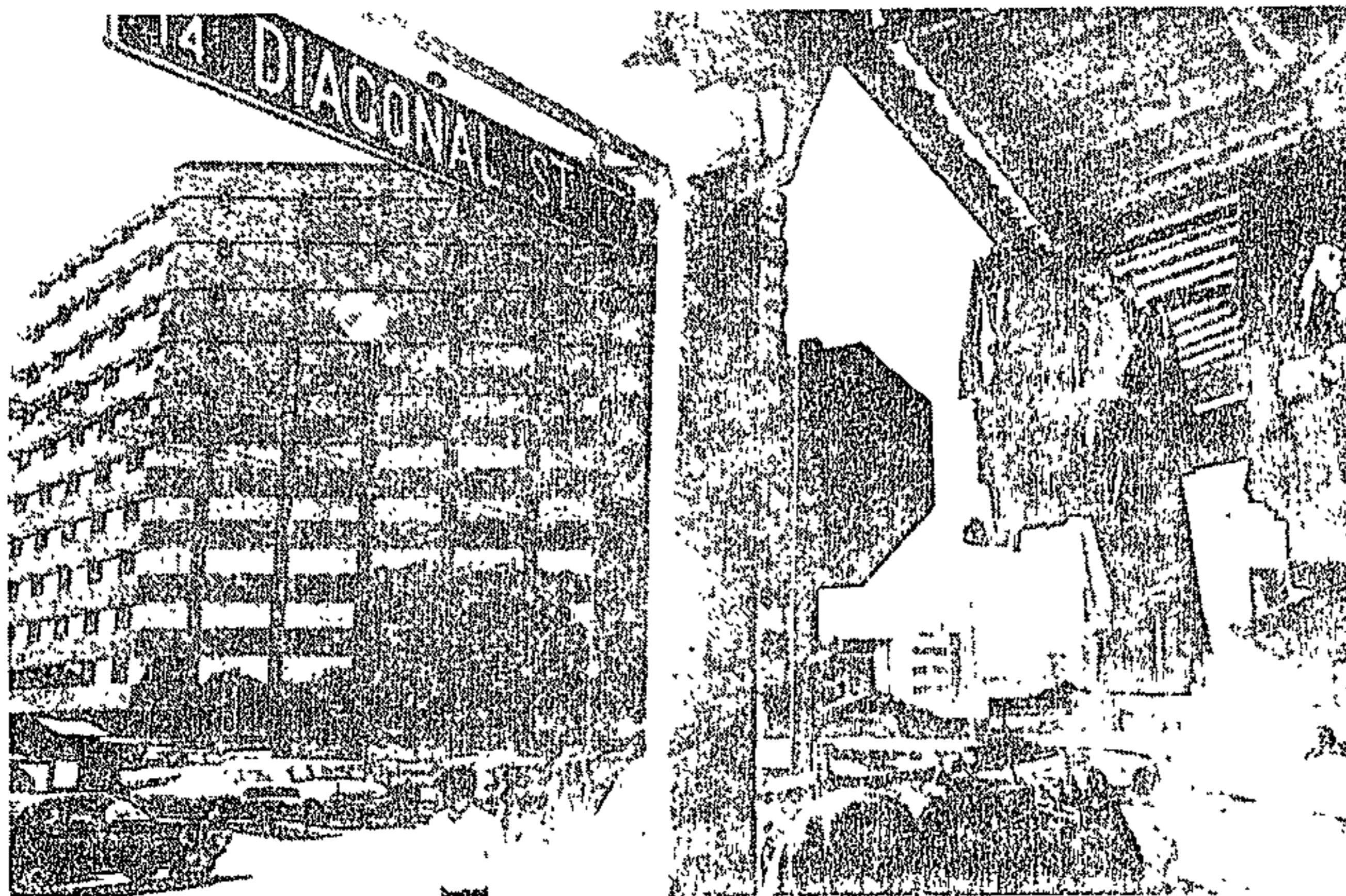

nary volumes for a Christmas season, and there were some large gains in gold shares. But the best was yet to come

The Afghan situation was compounded by reports of Soviet troop build-ups on the delicate Iran/Afghanistan border, a matter of hours from the oil-rich Persian Gulf.

As a result, bullion burst through to its all-time record \$850 on January 21, with the London afternoon fix on January 25 taking an unprecedented 71 minutes and seeing gold fluctuate more than \$50 before dropping back to just under \$700.

It was these influences which were to dominate the market strongly last year as war fears replaced oil price hikes. Middle East tension ranged from Iran to the Lebanese border later in the year.

By mid-February, bullion had lost some support as international news quietened and London tested the \$600 level going

results. We were in a bull market and no-one was interested in "bad" news. The indices had slipped back slightly, and the following week there was significant downward pressure as US interest rates moved up to over 17%, making fixed-interest stocks increasingly attractive in comparison with equities

Of course at that stage local interest rates were still soft, with three-month paper available at around 4.7% and long gilts at just over 9%. This, at least, enabled local brokers who were far-sighted enough to pick up stock at low prices when foreign investors were looking elsewhere. With the real inflow of funds from the steadiness of bullion still in the pipeline, these low rates were set to continue.

The March Budget did not initially move the market, as gold remained unsettled by high US interest rates and a firm dollar. Swiss bankers were talking fairly

5 MAR 10/1/81

79

58

# Golds slide to a five-month low

By Pieter de Vos  
Golds flickered briefly on the JSE on Tuesday, but slid to a five-month low during the stock market's first full week of trading in the New Year.

Though the decline seemed to be halted towards the close of the market, investors were cautious and nervous. In London the international bullion price seemed to rise off the week's bottom, but it still did not inspire any bullish sentiment among investors.

## This week on the JSE

A slight drop in US interest rates sent bullion briefly above the 600 dollar mark earlier in the week, but as it sank back later the JSE gold board moved down in line with the international market prices.

Deelkraal was steady on good quarterly results, but Doorns, which increased its earnings because of capital expenditure allowances, was down by 50c.

The results of West Drie and East Drie market sources considered disappointing.

Kloof was 125c down on results, Libanon 25c down and Venters untraded. Only Gold Fields' marginal mine, Viaks, moved up slightly on announcement of a drilling programme.

The easier trend among golds occurred across the whole board, though more

expensive issues such as Randfontein were virtually steady compared with Monday's price levels and Harties not far below.

Announcement of the Central Selling Organisation's sales slump caused a slight dip in De Beers, though it was difficult to tell whether it was because of the sales or general lack of interest from overseas investors in the JSE as a whole.

The coal sector seemed steady compared with Monday's levels, but other

mining shares were hardly traded on Friday.

Palamin was slightly up, but Samancor a little down. Gefco moved higher during the week and platinum were higher.

Triomf showed some hefty gains on the announcement of talks between Dr Louis Luyt, its chief executive, and the US oil company Occidental Petroleum.

Excellent results from Curries and Curfin led to a strong rise for both.

## ARCHITECTURE

Cape Provincial Institute of Architects' Prize  
For the best student in :-

## FINE ART & ARCHITECTURE

1980  
F Dunckley  
Gardner Travel Prize  
student who has  
factorily completed  
2nd and 3rd major courses.

appoport

Gohl Memorial Prize  
the best woman student  
3rd year.

C Tredgold

Haddon Prize

the best student of  
lecture (or Quantity  
/ing) in the subject.  
Professional Practice.

ryce Lewis

J B M Hertzog Prize

the best final year student.

ead

in Prize

the best work in fourth

ryce Lewis

erry Prize

the best work in

year.

in Rosenfeld.

# Falling gold erodes reserves

RDM  
10/1/81

79

By HAROLD FRIDJHON

THE official gold and foreign exchange reserves dropped by R519-million in December to R5 266-million — the lowest since May 1980.

The revaluation of the gold holdings was responsible for almost R261-million of the decline because the relatively unchanged stock was valued at R399,42 against R420,75 at the end of November. In November the average gold price at London's second fix was about \$623, but in December it fell to \$595.

In addition to the decline in the value of the Reserve Bank's gold stock, the other components of the reserves also dropped sharply. Other assets, largely holdings of currencies, fell R210-million to R341-million; foreign bills came down by R47-million to R31-million; and investments were marginally lower at R40-million.

The drop in the Reserve Bank's currency holdings can be the result of a number of factors.

First and foremost December is seasonally a month of a heavy outflow of funds from this country. There are big dividend payments which have to be made to foreign shareholders, as well as the payment of interest. There is a squaring of accounts between South African branches and their overseas head offices. And then there is the yearend balancing of books on international transactions.

The other factors which have to be considered are the possible repayment of foreign debts and it is probable that the heavy import of merchandise took its toll as goods poured in to meet boom demand.

From the peak at the end of September when the reserves stood at R6 484-million with gold valued at R469,34 they have dropped by R1 217-million.

And it is interesting to note that in September, the bank held R701-million in foreign currency against December's R341-million.

The other major feature in the latest monthly statement from the Reserve Bank is the huge increase in bills discounted, which rose from a recent high of R561-million to R1 070-million — which is a high as far as I can gather.

It is known that the discount houses were in the bank to the extent of R670-million because of the ever-tightening situation in the money market, but banking circles are unable to account for the additional R400-million.

Bankers say that the demand for additional facilities could not have come from the banking sector. Although some of the larger banks were looking for cash at the end of December they would have discounted or sold assets through the discount houses and would not have gone direct to the central bank.

They doubt that the Land Bank would have been involved because it uses the commercial banks for additional facilities. The Reserve Bank sent the Land Bank to the commercial banks some months ago to mop up some of the liquidity in the banking sector. On the other hand, the Land Bank has a discount quota from the Reserve Bank.

It is possible that the

National Finance Corporation might have had heavy discounts with the central bank as commercial bankers withdrew deposits to meet their own end-of-month requirements.

At the end of December the note issue reached R2 041-million compared with R1 630-million in December 1979. This is an increase of 25% which gives some indication of the explosion in consumer buying power. With inflation running at 14% plus the note issue was higher than the inflation rate and to some extent reflects the additional buying power which has been injected into the economy.



# Growing gold mountain

One of the most celebrated international monetary rows of the 20th century flared up on the eve of World War 2 over the affair of the Gold That Never Moved.

The moral of the tale is even more applicable today: because of the high price and soaring security costs of the yellow metal, central banks, gold dealers and other bullion enthusiasts prefer to shift the stuff around as little as possible.

One result is that gold stocks in London have probably risen during the past decade alone by more than 700 tons, at a conservative estimate worth more than R10 800-million at present prices. Perhaps nearly half of this has come in during the past two years.

Apart from the high cost of transport and insurance, the other main reason why gold has become physically concentrated in London and the other main trading centre in Zurich is that the bullion business has become increasingly speculative.

Long-term investment buying and purchases by industry — transactions which would tend to be reflected in physical movements — have become relatively less important. This was especially so last year when trading was dominated by short-term speculative movements of funds.

## Furious

The pre-war furore blew up when Czech officials in German-occupied Prague in March 1939 instructed the Bank for International Settlements (BIS), the central bankers' bank in Basle, to transfer Czech gold worth R10.8-million held in the Bank of England vaults to the account of the German Reichsbank.

The BIS complied — and the Bank of England carried out its instructions. The upshot when the news leaked out two months later was a

furious row in which both the Bank of England and the BIS were castigated in Parliament and the Press as having in some way collaborated with the Germans.

What nobody realised was that the gold never left London. For some reason the Reichsbank left it in its account at the Bank of England only to have it frozen at the outbreak of war. The supposed theft and surrender all took place within the Bank of England's vaults.

Apart from looking after part of Britain's gold reserves (another large portion is held with the Federal Reserve Bank of New York), the Bank of England today still provides vault space for gold deposited by foreign central banks.

## Discreet

The Bank also operates on the bullion market to buy gold needed for the sovereign-manufacturing activities of the Royal Mint, which have grown rapidly in recent years.

The BIS is still one of the Bank's most important foreign customers, along with the West German Bundesbank (the second largest holder of gold after the US). Safeguarding part of their gold stocks is all part of the discreet range of services that the Bank performs for a large number of monetary authorities.

The Bank of England's little-publicised bullion activities are no doubt an important support for the London gold market. The Swiss National Bank, for instance, apparently does not make the same range of storage facilities available for foreign central banks (although it looks after a large amount of BIS gold).

One Swiss dealer claims the Swiss National Bank has simply run out of space — the bank is building new vaults at its headquarters in Berne, although these are intended to house securities as well as gold.

One of the most important of the Bank of England's gold operations is to help store bul-

Gold is simply too precious to shift around more than necessary, especially at a time when bullion changes hands speculatively and at such speed. By David Marsh in London and Bernard Simon in Johannesburg, for The Financial Times.

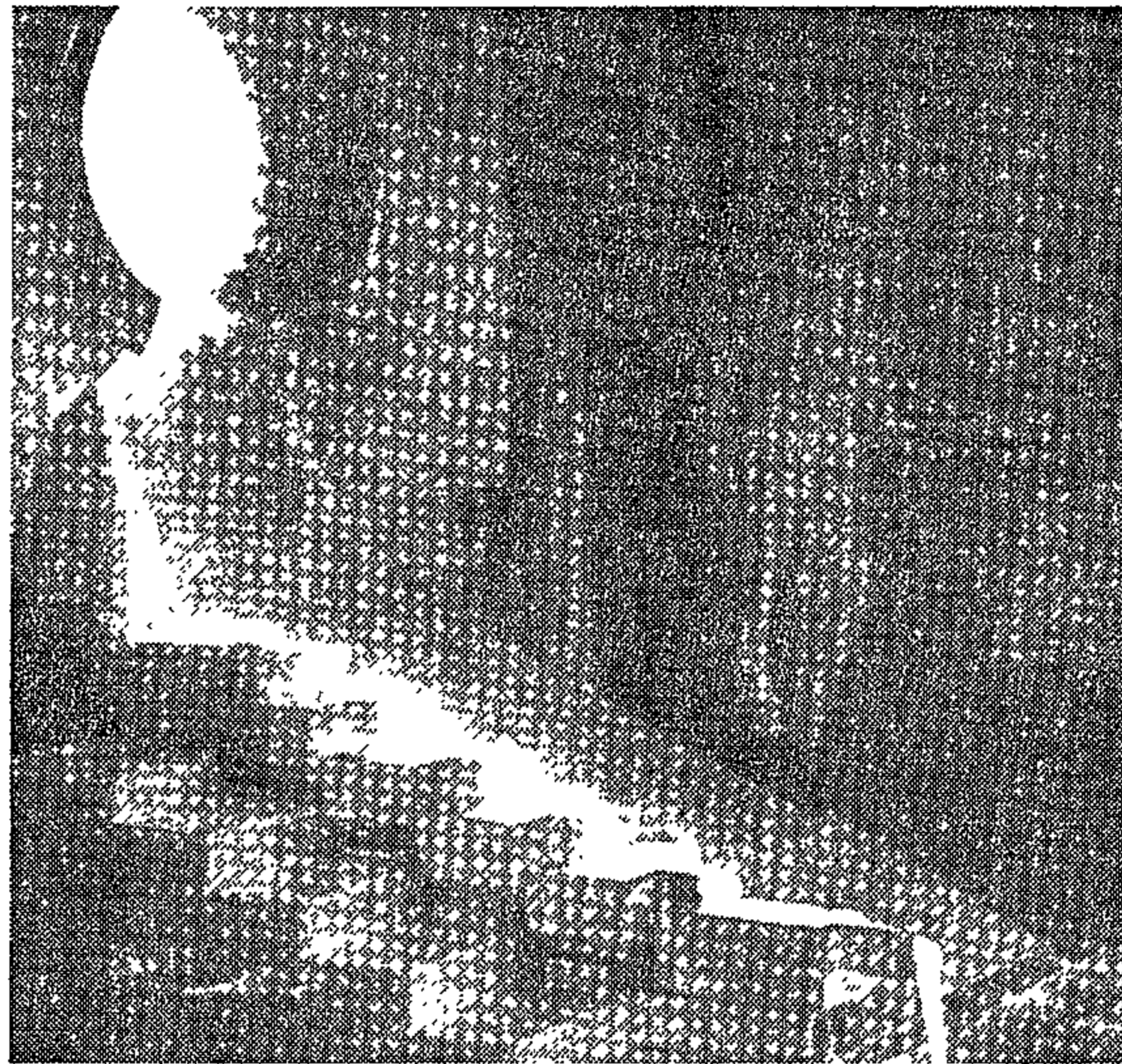

Molten gold flows on the first leg of its journey to world markets.

lion sent to London by South Africa.

The world's most important gold producer has always had close marketing ties with the City — up to 1968 the Bank of England functioned as the South African Reserve Bank's selling agent — and it still uses London as an important outlet for its international sales.

Gold purchases by the central banks of developing countries have been increasing during the past two years. And more South African gold seems to be staying in London rather than being sent to other centres like Zurich.

Gold exports from the UK to Switzerland were down sharply in 1980. So some of the gold stocks built up in London undoubtedly reflect an increase in customers' holdings at the Bank.

Unlike the New York Fed, which publishes some figures on the gold

it keeps on behalf of about 70 central banks, the Bank of England provides no statistics on the extent of its "foreign account" gold holdings.

Of the rest of the gold stores in London, a large part is kept at the big bullion houses — at least one of which has had to build new vaults during the past year or so.

## Substantial

In recent years very little, if any, gold from the Soviet Union, the world's second largest producer, has been sent directly to London.

During the 1960s large shipments came to London, handled through the Moscow Narodny Bank's City branch.

Since the Russians restarted substantial sales to the West in 1972, the marketing has been carried out through its Zurich-based trading bank, the Wozchod Handelsbank, which occupies a prime site near

the city's railway station and sells a variety of Russian postage stamps, rustic dolls and colourfully-printed ornaments as well as gold.

One important reason why the Soviet Union switched to Zurich was its distrust of the security arrangements at Heathrow airport, where large losses of gold and diamonds occurred, particularly in the 1960s.

But the Russians can still sell gold physically in London by arranging what is known in the trade as a "location swap" with a London or Swiss gold dealer. This involves the Russians exchanging metal held in Zurich for a separate amount of bullion stored in London.

The arrangement allows the Soviet Union effectively to bring gold into London without the possibility that the transaction would ever show up in detailed gold import

figures (the publication of which was stopped by the Bank of England four years ago).

Up to a few years ago, South African gold was sent to London through the weekly mailship service from Cape Town to Southampton.

Now bullion is seldom sent by sea because of the cost of insurance, which is much higher for longer times.

Gold sent from Johannesburg to London comes by South African Airways, with the air freight arrangements mainly handled through the Mitchell Cotts transport company. Consignments sent to Switzerland go by Swissair, and to West Germany via Lufthansa.

Competition among the airlines is, however, becoming more intense. One of the cheapest is the Dutch airline KLM, which has picked up the contract to carry a large slice of South Africa's Kruggerand exports.

## Cover

The rising price of gold during the past few years has placed limits on the volumes that can be consigned from place to place at any one time.

According to one London insurance broker, the maximum value of gold in transit for which insurance can be arranged at short notice is about R190-million — which would place an upper limit on gold consignments of about 13 tons, based on the present price of about 563 dollars per ounce.

Larger amounts can however be transported when the broker has enough time to organise extra cover from the international insurance markets.

However, at least one London bullion house says it can no longer transport even amounts of 10 tons because it is impossible to organise Lloyd's cover for metal worth R153-million.

The cost of insurance is about R382 for every R765 000 of the value of the gold — which would work out at about R76 000

for a 10 ton consignment.

Rising insurance charges have even had an impact back at the mineshaft. South African mines have recently reduced the amount of gold sent in railway trucks (the normal way of shifting it from the mines to the Rand refinery, except for the Free State mines, which fly gold to Johannesburg) because insurance costs had become exorbitant.

the legal entities comprising the group become irrelevant. As such, the situation differs from that which applies in a head office branch situation where all profits earned within the economic unit must of necessity be eliminated. On the second issue the panel did reach consensus. This involved an unrealised profit between two subsidiaries in a group where the buying subsidiary was excluded from the consolidated accounts.

the legal entities comprising the group become irrelevant. As such, the situation differs from that which applies in a head office branch situation where all profits earned within the economic unit must of necessity be eliminated. On the second issue the panel did reach consensus. This involved an unrealised profit between two subsidiaries in a group where the buying subsidiary was excluded from the consolidated accounts.

costs allowed for in the original the construction, could

No. 119

23 Januarie 1981

WET OP DIE SUID-AFRIKAANSE  
RESERWEBANK, 1944

BEPALINGS VAN STATUTÊRE GOUDPRYS

Hierby word bekendgemaak dat die Minister van Finansies kragtens artikel 17A (1) van die Wet op die Suid-Afrikaanse Reserwebank, 1944 (Wet 29 van 1944), alle goud van die Suid-Afrikaanse Reserwebank met ingang van 31 Desember 1980 teen R399,42 per ons suiwer goud gewaardeer het.

No. 119

23 January 1981

SOUTH AFRICAN RESERVE BANK ACT, 1944  
DETERMINATION OF STATUTORY PRICE  
IN GOLD

It is hereby notified that, in terms of section 17A (1) of the South African Reserve Bank Act, 1944 (Act 29 of 1944), the Minister of Finance has valued, as from 31 December 1980, all gold of the South African Reserve Bank at R399.42 per fine ounce of gold.

GOLD

FM 23/1/81

79

# The hostage paradox

With most of the world apparently bearish on gold, it is difficult to see many positive factors. The state of the US economy still has a negative influence on bullion. And though it seems that US interest rates are past their peak, a solid fall would probably be needed before gold responded with an upward move.



Jimmy Carter . . . a parting shot at the dollar

But this ignores political developments. And anyone looking for a sharp gold price improvement needs to look in that direction.

Paradoxically, resolution of the hostage situation could be the factor which triggers an upward bullion move. Relaxation of fears that Iran would become a large seller of gold have disappeared, leading to an immediate bout of bear covering. But it is the small print of the hostage agreement which could have most effect. The US government has agreed to help track down the Shah's assets in America and facilitate their return to Iran. More to the point, anyone in the US who has information on the assets' whereabouts has to inform the authorities under penalty of prosecution.

It was President Carter's earlier freeze on Iranian assets which contributed to a large part of bullion's rise to \$850 last January as the world took the view that the US was not the place for funk money. If the Shah's US assets are located and turned over to Iran, fears for the security of investments in the US, particularly by some of the Opec nations' ruling classes, could see a dollar sell off and a major switch to gold. And one of Carter's last presidential acts has been to kick the dollar firmly in the teeth. So much for trying to leave office in a blaze of glory.

Then there is Poland and the apparently

increasing likelihood of a Soviet invasion. Russia can perhaps afford to let Solidarity let off steam, but it cannot tolerate the drying up of necessary military parts and equipment made in Poland. It seems that Eastern Europe's arms industry is highly integrated and that upheavals in Poland are leading to procurement difficulties. If the Soviets do move their divisions into Poland a rapid sell off of D-marks and Swiss francs is possible, meaning another bull point for gold.

Finally, in recent weeks, according to London dealers, several central banks in the LDCs have been buying bullion as it hovered above \$550. And that has helped underpin the gold price.

Taking these three factors together, a near-term view could be that gold is set for a run-up to, perhaps, \$650, before any dishoarding takes place. The 1974-76 gold bear market lasted about 20 months. So if the present bear market follows its predecessor's pattern, the world could start turning bullish sometime during this year's third quarter even with no outside help. The bear market started last January.

So there are grounds for being positive on gold. The ride could be pretty wild over the next six months or so and investors will need to be fast on their feet to avoid the losses of temporary price setbacks.

But for anyone prepared to take a view on 1982, there could be some good buying opportunities right now.

Jim Jones

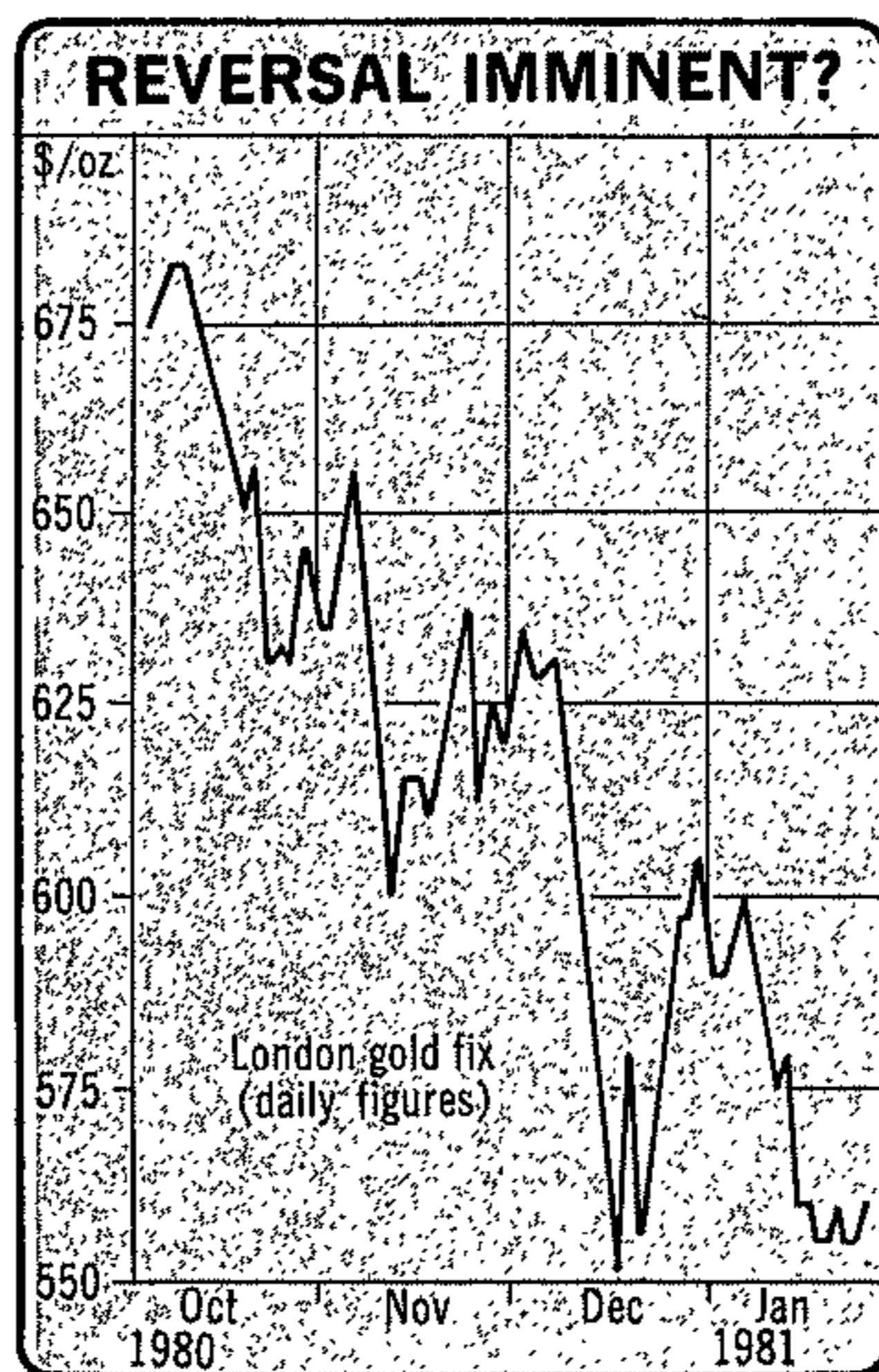

# Gold hits the <sup>RDM</sup> 'support level' <sup>24/1/81</sup> (79)

By SIMON WILLSON  
Industrial Reporter

EXACTLY a year after its all-time record of \$850 an ounce, the gold price bumped the psychologically important \$550 level yesterday and only just stayed above it, closing at \$553.

But gold's \$25 drop since Wednesday has taken the Johannesburg Stock Exchange with it, and in yesterday's tumbling trading the RDM industrial index dipped for the second successive day.

Gold shares were also hit in London, where some counters lost as much as \$8.

The \$550 level for gold has a mystique about it because it is what analysts call a "support level" for the bullion price.

It is the level at which gold-holders, seeing bullion on the

way down, order their brokers to sell all to cut their losses.

If gold drops below \$550 in the next few days it is highly likely this "stop-loss" selling will haul it further down to \$500 — its "resistance level", at which speculators will hang on, thinking the price cannot dip any lower.

The downward pressure on gold came mainly from the continuing high interest rates in the United States, which lure short-term funds away from gold and mop up any spare cash which investors want to stash away.

Investors go for gold in times of international tension, when world currencies are thrown into turmoil, but the world has looked marginally more peaceful since the release of the American hostages in Iran.

Osborn Prize

S A Read

For the best final year student.  
General J B M Hertzog Prize

D H Pryce Lewis

For the best student of  
David Haddon Prize  
Architecture (or Quantity  
Surveying) in the subject  
of Professional Practice.

Miss C Tredgold

For the best woman student  
in third year.  
Molly Gohl Memorial Prize

P A Rappoport

For a student who has  
satisfactorily completed  
1st, 2nd and 3rd major courses.  
Helen Gardner Travel Prize

P F Dunkley

Sixth Year

For the best student in :-  
of Architects' Prize  
Cape Provincial Institute

ARCHITECTURE

FINE ART & ARCHITECTURE



This week on the JSE

5 MAR 24/11/87 -72

# Poor time for gold price

By Ann Crotty

The main feature of this week's trading was the increase in the gold bullion price on Wednesday. It was the peak of a brief rally in which gold gained about 16 dollars an ounce. But this was followed by a fall that brought the price at the end of the week to below last Monday's opening. Throughout the week the gold price was erratic

in line with expectations of development in the Middle East. There appeared to be little market consensus on the effects of the situation. On Monday, bullion opened 5 dollars easier on the previous close and this was attributed to news of the imminent hostage release. More news brought about a recovery and the day saw a closing price of 564.5 dollars. On Tuesday the gold-board was steady, firming

marginally, in line with a slightly higher gold price. On Wednesday gold closed at 577.5 dollars which was a rise of 13 dollars on the previous day's close. During the day's trading gold shares followed this increase as did the rest of the market. Gold dropped back on Thursday and brought the market with it. The Friday opening in London was 556.5 dollars. This

meant that the week's gains, plus 4 dollars, were wiped out. The financial rand traded most of the week at 91.5/92.5 US cents. Friday's quote fell to the 90c region and brokers said this helped to bring some overseas interest into the market. Volumes traded during the week were low but brokers pointed out that average daily value of turnover was in the region of R10-million.

## Record international trade boom for SA

Own Correspondent

South Africa's international trade boom on world markets is continuing with last year's export figures hitting nearly R20 000-million. Countries in Africa bought goods worth R1 102-million — a record — while old trading partners in Europe accounted for most of the exports at R5 167-million. Figures released by

the department of customs and excise in Pretoria show exports had increased by 34 percent to R19 868-million in 1980 and that imports went up 45 percent — R9 904-million to R14 336-million.

The huge difference of R5 532-million between imports and exports is largely due to the higher gold price, economists say.

### FINE ART & ARCHITECTURE

Cape P  
of Arc  
For th

Sib  
P I

Helen  
For a  
satis  
lst,

P A R

Molly  
For  
in tl

Miss

Davi  
For  
Arch  
Surv  
of f  
D H

Gen.  
For  
S A

Ost  
For  
yet  
D

Jo  
Fo  
th  
R

### ARCHITECTURE

STAR 26/1/81 (79)



# Bullion and sl

## Business Reporter

Gold shares took a hammering today as the international bullion price dropped by about 20 dollars in the first few hours of London trading.

On the JSE, up to 20 percent and more was knocked off gold share prices, especially among marginals, with Rand Leases showing the sharpest drop, shedding 31 percent compared with last night's closing price.

The JSE all gold index was 8,5 percent down on last night's levels. The more expensive issues took a beating with the rest of the market. Randfontein lost 1600c including its ex-dividend of 650c.

Among the Free Staters, Pres Brand and Pres Steyn were both marked down 300c at mid-session, among the Klerksdorpers Harties took a knock of more than 10 percent, shedding 750c.

But the marginals and cheaper issues had the worst of it. Grootvlei dropped 145c before lunch, Willage was 25c down and Vlaks was 50c down. Leslie was 35c down, FS Saai 115c and Unisel 110c.

Our London correspondent reported that the gold price tumbled as investors decided that Ronald Reagan was going to be bad for gold.

President Reagan's early statements about cutting government spending — including a freeze on new office furniture — and suggestions that Far Eastern investors had now become sellers, knocked gold back.

The effect on JSE golds filtered through to the rest of the market, with De Beers following golds downwards, Barlows dropping by 30c before lunch and Sasol down to 380c.

However, at these levels brokers saw a steadying in the whole market while others predicted a bounce in the gold price in later trading.

Collieries were marked down with a loss of 150c.

## FINE ART & ARCHITECTURE

Cape Provincial Institute of Architects' Prize  
For the best student in :-

Sixth Year  
P F Dunkley

Helen Gardner Travel Prize  
For a student who has satisfactorily completed 1st, 2nd and 3rd major courses.  
P A Rappoport

Molly Gohl Memorial Prize  
For the best woman student in third year.  
Miss C Tredgold

David Haddon Prize  
For the best student of Architecture (or Quantity Surveying) in the subject of Professional Practice.  
D H Pryce Lewis

General J B M Hertzog Prize  
For the best final year student.  
S A Read

Osborn Prize  
For the best work in fourth year.  
D H Pryce Lewis

John Perry Prize  
For the best work in third year.  
R A van Rosenfeld.

Wave of <sup>STAR</sup> selling 27/1/81 hits golds (79)

By Michael Chester  
Financial Editor

Hammered by a wave of selling that started in the Far East yesterday and hour by hour spread to all the main bullion markets, the gold price fell to 513.50 dollars an ounce in Hong Kong today.

The price later struggled back to 519.12 dollars in the Far East but rode on down to 516.50 dollars in Zurich and still lower to 514 dollars in London when the European markets opened.

It left gold showing losses of 100 dollars an ounce in little more than a month.

The loss to South Africa, as the main gold producer, can be measured by estimates that every 10-dollar fall in bullion prices pulls down export income by as much as \$20-million a year.

CAUSE

Analysts put the cause of the gold slide on the easing of international political tensions, now that the US hostages in Iran have been released and troubles in Poland appear to be off the boil.

International investors are also switching funds to the US dollar on world markets, attracted by high US interest rates offering good returns on capital.

Gold shares on the Johannesburg Stock Exchange also took a battering yesterday, with losses running as heavy as 20 percent in 24 hours.

By this morning, the JSE gold index, which started the year at 728 points, had sunk to 555 points.

See Pages 30 and 32

Cape Provincial Institute  
of Architects' Prize  
For the best student in :-

Sixth Year

P F Dunkley

Helen Gardner Travel Prize

For a student who has

satisfactorily completed

1st, 2nd and 3rd major courses.

P A Rappoport

Molly Gohl Memorial Prize

For the best woman student

in third year.

Miss C Tredgold

David Haddon Prize

For the best student of

Architecture (or Quantity

Surveying) in the subject

of Professional Practice.

D H Pryce Lewis

General J B M Hertzog Prize

For the best final year student.

S A Read

Osbourn Prize

For the best work in fourth

year.

D H Pryce Lewis

John Perry Prize

For the best work in

third year.

R A van Rosenfeld.

# Industrial nations made 'killing' on rise in gold 512 3/2/80 77

GENEVA — Industrial nations have gained 4370m dollars from the rise in the price of gold in the 1970s — equivalent to over 500 dollars for each person in their population, a United Nations study has reported.

In contrast, developing nations have lost over 1000m dollars by sticking to holdings in the US currency since the international community abandoned a fixed dollar price for gold in 1973, the study for the UN conference on Trade and Development (UNCTAD) said.

"It is clear that developing countries have paid a heavy price for their willingness . . . to accept the pledge of the United

States of America that the dollar was as good as gold," the report by two UNCTAD economists said.

Mr David Bridsky and Mr Gary Sampson said industrial countries owned 90 percent of the 1060m ounces of gold held by nations as reserve assets in the 1970s.

Seven countries held nearly three quarters: the U.S., West Germany, France, Italy, Switzerland, Netherlands and Belgium.

The two leading gold producers, South Africa and the Soviet Union, were also large beneficiaries of the rise in the gold price from an official 35 dollars an ounce in 1970 to a market determined 512 dollars at

the end of 1979, they said.

The gold price later rose to a peak of 875 dollars an ounce in January 1980, but has since fallen back to around 500 dollars.

The UNCTAD study called for the setting up of a "gold account for development".

Under the plan the International Monetary Fund (IMF) could sell gold it still owns to the poorest countries at below-market prices.

"As of June 30, 1980, the bookkeeping value of the IMF's gold stock was 4900 million dollars, while its market value was 6700 million dollars," they said. "The initial capital value of a gold account for development established at this time would therefore have been 6200 million dollars."

The study calculated the financial gain by residents of developed industrialised countries from the price rise in the 1970s was more than 500 dollars a person. But in some countries the gain was much smaller, ranging from 53 dollars in the US to nearly 6000 dollars a person in Switzerland. — S.A.P. — Reuter.

my Sacks Memorial Prize

f Rens

/11 Engineering.

ident in Land Surveying or  
iminations to the best male  
rded on results of final  
fessor George Menzies Prize

B F McClelland

J H Rens

D P Weeks

T J Cumming

P M Salmon

Fourth Year (Gold Medal)

Miss N C Davidson

Third Year (Silver Medal)

Miss G C Littlewort

Second Year (Bronze Medal)

For the best student in each  
of the 2nd, 3rd and final years.  
Corporation Medals

# MARKET DATA

# Gold:

## Bullion slide drags gold board down

By Geoff Shuttleworth

Gold shares continued to be marked down after bullion fell to 479 dollars, about 15 dollars down on London's close last night.

Dealers said that there were few buyers in the market and volume was consequently very small. London investors were small net sellers and local investors are sitting out on the sidelines awaiting either a recovery or a sharp downward movement.

The financial rand cushioned to some extent the fall in prices and was quoted around 88 US cents, down from last night's close at 89 US cents.

Losses in heavyweights extended to 350c in the case of Vaal Reefs to 7 950 while Randfontein shed 275c to 6 300 and ERPM shed 175c to 1 700.

Medium priced issues had Elands down 15c to 635, Elsburg shed 10c to 370 and Venters shed 35c to 980. Marginals continued to suffer the highest proportional losses. Modder shed 20c to 180 — 70c off its rights offer price — while Grootvlei lost 45c to 780 and Marievale lost 15c to 360 giving it a massive 33,3 percent historic dividend yield.

Other precious metal shares shadowed gold. Rusplats shed 15c to 555 and Implats lost the same to 760.

In collieries there were 8 losses and not a single gain. Losses extended to 50c for both Amcoal and Wits Colls while Trans Natal shed 20c to 930.

Where changed, other metal and mineral shares were lower.

Mining financials were lower with the exception of Vogels which put on 5c. Anglos shed 35c to 1 450 while Johnnies shed 300c to 7 000 and TC Lands lost 100c to 4 600 (sellers).

De Beers continued its recent falls losing 5c at the opening to 905 while Anamint later shed 200c to 10 000 in sympathy.

The industrial board was generally weaker.

### Actuaries indices

**ALL MARKET**

2 pm	603,5
12 noon	606,4
10.30 am	610,3
Monday close	616,9

**GOLDS**

2 pm	535,5
12 noon	539,3
10.30 am	544,0
Monday close	554,7

**MET & MIN**

2 pm	246,3
12 noon	247,8
10.30 am	248,5
Monday close	249,6

**FINANCIALS**

2 pm	424,3
12 noon	427,2
10.30 am	427,6
Monday close	428,3

**INDUSTRIALS**

2 pm	545,6
12 noon	545,6
10.30 am	551,2
Monday close	555,3

### JSE indices

Close	All Market	Gold	Metals	Financials	Industrials
January 30	630,1	571,5	254,1	432,1	561,5
January 29	622,7	550,6	254,3	432,8	564,6
January 28	638,7	576,2	258,8	434,6	571,5
January 27	636,8	572,2	258,0	433,4	572,7
January 26	635,2	559,0	263,1	443,0	577,7
Month ago	746,8	728,1	294,8	478,9	610,8
Year ago	562,4	501,9	260,7	371,3	479,0

Bases at 1960. All market = 100. Golds = 87,9. Metals & Minerals = 27. Financials = 100. Industrials = 69,9.

STAR  
3/2/81  
79

### Today's features

GAINS			LOSSES					
Price	Cents	Percent	Price	Cents	Percent			
H Parker	85	15	21,4	Simmers	400	65	14,0	
KWV Bat	7%	125	5	4,2	Don Dp	1 600	250	13,5
Kimet	255	10	4,1	Eddels	220	30	12,0	
Vogels	205	5	2,5	Suthsun	305	35	10,3	
Lonrho	265	5	1,9	Modder	180	20	10,0	
New Wits	435	5	1,2	ERPM	1 700	175	9,3	
N Canvas	495	5	1,0	Toncor	250	25	9,1	
				Nat Coal	100	10	9,1	
				John Orr	200	20	9,1	
				P Brand	4 125	375	2,3	
				Altron	550	50	8,3	
				Sulder	55	5	8,3	

### Today's most actives

Vol	Price	% gain (loss)	Value	Price	% gain (loss)
Boland	105 157		441 649		(0,5)
Sasol	71 850	(2,7)	436 320		(3,0)
SA Brews	64 158	(5,9)	410 112		
Pioneer	61 400		41 800		(1,5)
Toigate	49 750	(5,9)	272 477		(3,1)
Debeers	48 801	(0,5)	255 067		(2,7)
Trust Bank	46 450	(2,0)	236 000		(3,6)
Retco	42 750	(3,8)	207 000		
SA Drug	41 900		205 305		(5,9)
Senchem	41 800		199 000		(5,9)
Safmarn	35 500	(2,3)	174 300		(4,5)
Elsburg	34 224	(2,6)	171 477		(5,3)

## LONDON TODAY

### Gold, equities lower

LONDON — When the London Stock Exchange opened today gold shares opened as much as four dollars lower and leading equities were marked down a penny or two reflecting the overnight losses on Wall Street and

the sharply easier trend of sterling.

Gold bullion opened around 480 dollars an ounce, its lowest level since March last year, and gold shares were again marked lower accordingly. Amgold was down four

dollars at 79 while Johnnies fell three dollars to 62.

Against the trend, electricals moved higher on the news that state owned British Telecom may be allowed to raise funds from financial institutions.

Third Year (Silver Medal)  
Miss G C Littlewort  
Second Year (Bronze Medal)  
of the 2nd, 3rd and final year  
For the best student in each  
Corporation Medals

GOLD

79  
Cover-up FM 6/2/79

One of the last chinks of light in the mysterious workings of the international gold market is being closed. From this month, the Swiss customs authorities have decided to stop publishing detailed figures on the movement of gold in and out of Switzerland on a country basis.

Breaking down gold imports and exports on a country basis "can be misleading or endanger general economic interests," the Swiss customs authorities said by way of explanation. In fact, the customs are conceding to massive pressure from the big three Swiss banks which run the Zurich gold market, with support from the central bank.

The Swiss banks became upset last year when European newspapers started publishing details of the monthly customs figures which they had assumed to be secret. They complained that it put the Zurich market at a competitive disadvantage against London, which doesn't publish figures, and was particularly upsetting for the Soviet Union which likes to surround its gold sale operations with the tightest secrecy and is known to have been using Zurich as its main sales outlet to the West in recent years.

Last December's farewell figures show that physical supplies of gold to the Swiss market fell roughly a third last year to 629 t. The fall partly reflected a drop in supplies from the Soviet Union, the world's second largest producer after SA, which sent only 40 t to Switzerland (presumably for sale) against 214 t in 1979.

South African deliveries to Switzerland also declined last year, though less spectacularly from 117 t to 95 t. However, it seems probable that indirect supplies of South African gold via London to the Swiss market also fell sharply during 1980 since

imports from London were down to 131 t compared to 313 t in 1979.

On the export side, the amount of gold taken out of Switzerland fell 15% last year to 552 t. Demand from the big jewellery centres, particularly in Italy, appears well down. Both Iraq and Iran withdrew official monetary gold deposited in Zurich early in the year.

But 1980 was also marked by an upsurge of gold buying by the central banks of rich oil exporting countries. Indonesia is known to have bought 56 t of gold between February and December, while IMF statistics show that total world monetary gold holdings rose by 68 t in the first ten months of the year, after declining by roughly 250 t a year between 1973 and 1979.

With a gold price that has dropped back from around \$800 to barely \$500 an ounce in the space of a few months, these central banks are sitting on some pretty heavy losses. But now that the Swiss customs are no longer publishing detailed gold movement figures, it is going to be harder to tell who is buying and selling — and who is doing it stupidly or wisely.

# The fire is not out

During its first weeks in office, the Reagan administration is playing a cool political line on SA. But when it comes to economics, matters are a whole lot different. Wittingly or unwittingly, the new government should be good for us, writes a senior FM staffer, from Washington.

That is a growing view among that section of the Washington economic community that is not pandering to the new president. Put simply, they say that President Reagan has promised too much, too soon. And though Americans, on the whole, are prepared to give the new president a chance to put the nation's economic house in order, the honeymoon could end sooner than later.

Expectations have been raised that several incompatible factors cannot be merged into a coherent economic whole. The federal budget is to be balanced, taxes are to be cut, defence spending is to be increased, inflation is to be cut to 5% by 1984, economic growth is slated at 5% in the same year and unemployment is then targeted at only 6%.



Ronald Reagan . . . heading for a short honeymoon?

The view is gaining ground that the targets are far too optimistic and that pressure from special interest lobbies will have slowed down the administration's plans well before this year is out.

The US has taken some 20 years to reach its present economic predicament. And, once the public realises there are no near-term solutions, disillusion could set in fast. The impact for SA is obvious — the fire under gold has not been put out, it is simply on a lower gas.

Though America is only one part of the gold price equation, for the present what happens here is of prime importance. Political influences on the gold price have taken a back seat and, for the time being, Opec surplus nations such as Saudi Arabia have a vested interest in maintaining the dollar's strength.

The US is the only economy capable of absorbing and recycling Opec surpluses — the entire Opec surpluses simply cannot be diverted into other currencies or gold while ignoring dollar investments.

So, the Washington view goes, the Opec

surplus nations are not about to initiate a scramble into gold if that is likely to depress the dollar. And, barring political traumas in Poland, gold's near-term prospects will depend largely on how Americans perceive the development of their own economy.

What are they likely to get? For a start, Reagan's economic proposals envisage federal spending cuts this year of between \$10 and \$12 billion, rising to \$40 billion next year. Those savings are earmarked to be channelled into defence spending. So, on the assumption that the entire round of non-defence spending cuts will not be agreed by Congress, federal spending could well be higher this year.

On the other side of the coin, across-the-board tax cuts of 10% have been proposed, contingent, it is said, on decreases in

spending. However, it would be political dynamite to reduce the proposed level of tax cuts. And, as they cannot be delayed, it seems that federal income is in for a drop of \$40 billion-odd.

It all adds up to prospects of even larger budget deficits with all the implications that has for inflation and, ultimately, the gold price.

A shift in American attitudes towards gold is still some months off. High interest rates continue to keep many speculators on the sidelines and the Federal Reserve can be expected to keep rates high as an inflation-combating measure.

For the next few months that could be the major determinant of the American economic factor in the gold price equation. But, according to Washington's pro-gold lobby, administrative moves to re-

duce inflation will take time to have effect. Higher food and fuel prices in the pipeline are expected to increase the nation's inflation rate soon.

If that happens, Americans could end their honeymoon with Reagan by mid-year. By that stage, gold's prospects should be looking a great deal more healthy. Industrial demand is already picking up, and if that is accompanied by an investor demand uptick once the normal mid-year period of seasonal gold price weakness is over, bullion could be heading up towards the \$600 level again.

All this, of course, assumes no change on the European political front. If there is an open Soviet invasion of Poland, as opposed to a creeping takeover of that country, all gold price projections are telescoped.

For the best student in each of the 2nd, 3rd and final years.  
Corporation Medals  
Second Year (Bronze Medal)  
Miss G C Littlewort  
Third Year (Silver Medal)  
Miss N C Davidson

DEPARTEMENT VAN FINANSIES

No. 270

13 Februarie 1981

WET OP DIE SUID-AFRIKAANSE  
RESERWEBANK, 1944

BEPALING VAN STATUTÊRE GOUDPRYS

Hierby word bekendgemaak dat die Minister van Finansies kragtens artikel 17A (1) van die Wet op die Suid-Afrikaanse Reserwebank, 1944 (Wet 29 van 1944), alle goud van die Suid-Afrikaanse Reserwebank met ingang van 31 Januarie 1981 teen R352,55 per ons suiwer goud gewaardeer het.

DEPARTMENT OF FINANCE

No. 270

13 February 1981

SOUTH AFRICAN RESERVE BANK ACT, 1944

DETERMINATION OF STATUTORY PRICE  
IN GOLD

It is hereby notified that, in terms of section 17A (1) of the South African Reserve Bank Act, 1944 (Act 29 of 1944), the Minister of Finance has valued, as from 31 January 1981, all gold of the South African Reserve Bank at R352,55 per fine ounce of gold.

CHEMICAL

A E & C I Prize

For the first year student  
obtaining the highest average

L Menegaldo

Drawing.

Awarded to the student with the  
best classwork in Engineering  
Sammy Sacks Memorial Prize

J H Rens

Civil Engineering.

Awarded on results of final  
examinations to the best male  
student in Land Surveying or  
Professor George Menzies Prize

B F McClelland

J H Rens

D P Weeks

T J Cumming

P M Salmon

Fourth Year (Gold Medal)

Miss N C Davidson

Third Year (Silver Medal)

Miss G C Littlewort

Second Year (Bronze Medal)

of the 2nd, 3rd and final years.

For the best student in each

Corporation Medals

FACULTY OF ENGINEERING



FACULTY OF ENGINEERING

Corporation Medals  
For the best student in each  
of the 2nd, 3rd and final years.

Second Year (Bronze Medal)  
Miss G C Littlewort

Third Year (Silver Medal)  
Miss N C Davidson

Fourth Year (Gold Medal)

- P M Salmon
- T J Cumming
- D P Weeks
- J H Rens
- B F McClelland

Professor George Menzies Prize  
Awarded on results of final  
examinations to the best male  
student in Land Surveying or  
Civil Engineering.

J H Rens

Sammy Sacks Memorial Prize  
Awarded to the student with the  
best classwork in Engineering  
Drawing.

L Menegaldo

A E & C I Prize  
For the first year student  
obtaining the highest average  
mark.

G L Cragg

79 EDM  
17/2/81  
'Another big gold price rise unlikely'

Political Staff

THE ASSEMBLY. — It would not be prudent to expect another large increase in the average gold price in the next year, Mr Owen Horwood said yesterday.

But he tempered this warning with optimism about the long-term outlook.

"I am decidedly bullish but would not wish to base short term fiscal policy on too optimistic a price," he said.

"Our policy during the current year of basing our revenue estimates on a conservative gold price has stood us in good stead, so much so that at current gold price levels we are able to fund rising Government expenditures, expressed at current prices, in a healthy and disciplined manner."

Several times in his speech, Mr Horwood underlined the value of gold to the economy.

Early on he said it was clear the Government's revenue would be considerably higher than budgeted for. Last year he had estimated it would amount to R10 856-million.

He said tax revenues were expected to exceed this estimate by a fair margin, despite substantial tax reductions.

The rise in imports and declining tendency in merchandise exports were neutralised by the sharp increase in the value of the net gold output, to over R10 000-million in 1980 from R6 000-million in 1979 — an increase of almost 70%.

The surplus on the current account of the balance of payments had thus amounted to between R2 500 and R3 000-million — about equal to 1979.

# SA's gold coin quota doubled and interest on Bonus Bonds up

Political Staff

THE ASSEMBLY. — The quota of gold coins sold in South Africa will be doubled and Defence Bonus Bond interest rates and bonuses will be raised in mini-Budget windfalls for the middle and higher income brackets.

The Minister of Finance, Mr Owen Horwood, announcing the doubling of the quota of gold available for sale within South Africa — from 150 000 to 300 000 ounces a year — said the move was expected to help reduce the existing high premiums on Kruger Rands.

And a new series of Bonus Bonds, to become available on April 1, will carry interest rates of 9% and will pay an additional bonus interest of 5% on redemption after five years.

"This is tantamount to an attractive rate of about 10% a year to redemption," said Mr Horwood.

The current issue of Bonus

Bonds, carrying 8% interest will be withdrawn at the end of February.

The increase in the quota of gold coins available for sale locally follows a 44% increase last September.

"Despite the freer availability of gold coins today there are still indications of an unsatisfied local demand, which is evidenced by the high premiums prevailing in the local secondary market," Mr Horwood said.

"My department is still in consultation with the Chamber of Mines and Intergold on improvements to the present distribution system, but I have in the meantime decided to double immediately the quantity of gold available for the domestic distribution of gold coins," he said.

Details of improved distribution methods would be announced soon.

Referring to Bonus Bond interest rates, Mr Horwood said

the new issue of bonds would be available from post offices and the Treasury from April 1.

"As a result of the recent sharp rise in interest rates the yield on this bond (the present issue at 8%) has fallen out of line with market rates and the issue will consequently be withdrawn at the end of this month."

In line with a more realistic approach towards exchange control, Mr Horwood announced doubling the credit limits for foreign controlled companies in seeking local credit.

"Although I do not foresee that there will be an immediate large-scale switching by these companies from foreign to domestic financing sources with a concomitant drain on our foreign reserves, the greater flexibility should substantially enhance South Africa's attractiveness to foreign investors."

## R8m for flood victims

THE ASSEMBLY. — The State would provide R8-million for rebuilding Laingsburg and other flood-stricken areas in the Karoo, the Minister of Finance, Mr Owen Horwood, said yesterday.

A further R2-million had already been provided for temporary housing.

Spontaneous reaction by all South Africans to alleviate the suffering of those affected by the floods reflected compassion for the flood victims, he said.

"Great credit is due to the South African Defence Force, the South African Police, the Cape Provincial Administration, the various Government departments and the many private organisations and individuals for their effective and generous assistance."

The substantial agricultural damage would be dealt with by the Department of Agriculture and Fisheries.

The Cape Provincial Administration would help local authorities with reconstruction projects, he said. — Sapa.

J H Rens

Professor George Menzies Prize  
Awarded on results of final  
examinations to the best male  
student in Land Surveying or  
Civil Engineering.

B F McClelland  
J H Rens  
D P Weeks  
T J Cumming  
P M Salmon

Fourth Year (Gold Medal)

Miss N C Davidson

Third Year (Silver Medal)

Miss G C Littlewort

Second Year (Bronze Medal)

For the best student in each  
of the 2nd, 3rd and final years.  
Corporation Medals

FACULTY OF ENGINEERING

# The sterling option 79 FM 20/2/81

The first formal public progress report from the eight-man working party which is putting together the nuts and bolts of the London Gold Futures Market contains

Headed by Keith Smith, who as director of Mocatta and Goldsmid (bullion dealers) and of Commercial Metal (London Metal Exchange members), usefully straddles the two markets involved, the party will recommend that:

- the contract lot be 100 ounces
- delivery be in 100 ounce bars or three 1 kg bars with a minimum gold content of 0.995
- the trading currency be sterling
- the trading period be the current month and six following months.

The other details, delivery point (London), market location (LME) and initial membership (the five London bullion houses plus LME dealing members), were all self-evident from the start.

What stands out in the proposals is that while the 100 ounce contract matches the big established markets in Chicago and New York, the choice of sterling is at odds with the internationally accepted dollar pricing of gold. Working party chairman Smith was judiciously laconic when asked about the sterling contract by the FM. "There was no particular reason not to (go for sterling)," he said. "London is the home of the pound. Thus it was believed to be the best currency for the new market."

## Other variation

The other variation on the American futures markets, the six month trading period as opposed to 22 months across the Atlantic, has a firmer basis. As Smith pointed out, and London-based US commodity traders agreed, the nearby months are far and away the most heavily traded positions in the US markets. "There is not a great deal of volume in the far out months," said Smith.

It is not yet clear whether the interface between sterling and dollar prices will create a problem of foreign exchange dealing for LME members of the gold futures market. But it will be no handicap to the bullion houses, with their forex banking affiliates David Hargreaves, of commodity traders Rayner Harwill, believes the sterling choice was a "fighting compromise" reached out of deference to the LME whose contracts are priced in pounds.

While the working party has still to fix trading hours for the gold market, Hargreaves says it is likely that it will close before New York opens, thus obviating the problem of simultaneous dealing in gold and pounds and dollars.

This could be done without interfering unduly with the aim of a London futures bridge between the Hong Kong market (which closes at 09h00 GMT) and New York (which opens at 14h30 GMT).

Trading hours are, however, probably the least problematical of the questions facing the working party. The major one is undoubtedly the setting up of a clearing house and the financial backing for it (which will need to be of the blue chip

little that is new or enlightening. As far as it goes, the report, in essence, confirms the leaks, hints and speculation which have surrounded the deliberations of the



**Rothschild's Guy . . . sceptical about new market**

variety) plus rules and regulations.

Smith says: "We are still aiming for May as a starting date" but at least two bullion houses feel this is overoptimistic and there is speculation that the launch will be postponed for three or four months.

One hurdle which seems to have been cleared is the Bank of England's early misgivings about futures markets in general. Governor Gordon Richardson, commenting on the US precious metals futures markets at an early stage in the discussions about a London equivalent, said: "They may have reinforced, and certainly have not reduced, the gyrations of prices in the physical markets . . . (and) great care must be taken in drawing together the final details before any scheme is finally put to us." As one leading bullion house put it this week: "I think it can be accepted that the working party would not have got this far if the Bank was still rooted in these fundamental prejudices."

That said, it is far from certain how strong will be support for the new futures market. The five bullion houses, Rothschilds, Mocatta, Sharps Pixley, Montagu and Johnson Matthey, are all committed to membership of the joint company, London Gold Futures Limited which will run the market. It is an open question, however, as to membership from the LME side. Unofficially, it is estimated that only be-

working party since it started work last September — with the aim of getting the new market into operation by May this year

tween six and eight firms will join out of 32 LME ring dealing members.

A more important imponderable is whether the new market will be used by major producers and consumers to hedge sales and purchases. According to Pat Smith, of Johnson Matthey: "At the moment most of the interest has come from traders."

Speaking from the producers' viewpoint, David Potts, Consolidated Gold Fields bullion expert, said that while he accepted that gold futures markets were a fundamental part of the "whole scene" and that London had to have one to keep its status in international circles, "we (producers) are still learning about them." The questions of daily settlement of margin calls which have so far been a deterrent to SA gold producers using the US markets, and others, still remained.

In addition, he said, SA producers "blamed the futures markets for the extra fluctuations in the price which have caused big problems for mine planning." He did concede, however, that this attitude "may slowly change as the market develops in London." And Potts is aware that American and Australian producers did take advantage of the futures markets to hedge forward sales when gold was around \$700 an ounce a few months ago.

Robert Guy, bullion director at N M Rothschild, feels that the rules governing any futures markets, geared as they are to the "lowest common denominator" — the small investor/speculator — cannot give credit to the financial strengths of big producers. They are also limited in how far forward they can sell and in what quantities.

## Bilateral contracts

He has no doubts about the case for hedging — in the same way as any producer, say Boeing Aircraft, will cover export orders with long lead times, but Guy advocates bilateral forward contracts between gold producers and bullion banks as a more viable alternative to direct use of futures markets. Margin requirements could be fixed and varied on the basis of the banks' assessment of the producers creditworthiness. Dates would not be limited by futures markets regulations nor would the size of contracts. And the nuisance of dealing with daily margin calls — if the price went against the producer — would be avoided.

The bullion bank could try to match the forward sale with a forward buyer or, providing it had sufficient gold stocks of its own, go short in the spot market and lay off the released funds to match the period of the sale at a rate of interest which matched the contango. Or the bank could hedge its forward purchase in the futures markets on its own account. "It would be a much simpler process and less of a strain on the management of the producer," said Guy.

Malan Chemical Engineering  
Medals

For the best student in each of the following years:-

# BIG BUILD-UP IN GOLD RESERVES

(79)  
A plus  
21/2/81

## A BIG increase in central bank activity on world bullion markets is reflected in figures from the International Monetary Fund.

They show that developing countries last year built up their gold reserves by more than 220 tons, worth more than R2700-million at present prices.

A large slice of the rise—about 66 tons—is ac-

counted for by a rise in South African reserves, mainly due to retention of gold production, the Financial Times, London, reports.

But the IMF figures do not include purchases believed to have been made by countries such as Iraq, Libya, Singapore and Iran, which either keep their gold reserves secret or do not give full figures.

Part of the increase in developing nation reserves stems from restitution of gold to member countries by the IMF at the beginning of the year. But the bulk of the rise clearly re-

flects buying on the market.

Indonesia increased its holdings by 66 tons, worth more than R750-million. Other increases were registered mainly by countries in Latin America and South-East Asia.

They included the Philippines, Thailand, Colombia, Brazil, and Uruguay. Jordan also became an official purchaser.

The increase in developing countries' reserves last year overstates the total net increase in official gold reserves because of selling by the

IMF itself and Canada, the Financial Times says.

Professor R. M. Gidlow of the University of the Witwatersrand says one reason why central banks in developing countries have been buying gold is mistrust of the dollar.

Writing in the latest issue of South African Banker, he says another reason was the freezing by the United States of the Iranian dollar assets of the Iranian central bank in November 1979.

This shocked the international business community and gave countries which are experiencing

strained foreign relations with the United States an incentive to reassess their attitude to gold.

The buying by developing countries partly reflects a desire to build up a war chest. Gold, unlike foreign exchange, cannot be frozen by foreign powers if it is held in the vaults of the central bank which owns it.

Central banks in third world countries also like to possess gold as it can be used as collateral for loans from the Euro-currency markets. They could also be buyers if they anticipate a rise in the gold price.

submitted in C E 214, design  
P C Watt

# Mines still studying gold futures entry

RDM (79)  
28/2/81

By JOHN MULCAHY

THE gold-mining industry is still considering selling gold forward on US or other markets — notwithstanding a conflicting report from New York.

Dr Simon Brand, chief of financial policy in the Department of Finance, was reported to have said in New York that a Chamber of Mines study had determined that to allow gold-mining companies to hedge on futures markets would not be advisable.

The report said Dr Brand indicated the chamber had not made a final decision on the subject, but industry sources said yesterday the whole question was still under negotiation.

The sources added that the chamber's study had produced pros and cons, and "various alternatives", but these were still under consideration.

The Reserve Bank has given its blessing to the hedging proposals, and has said approval will be forthcoming for the foreign exchange needed to hedge on the futures markets.

The chamber's study was an internal one, and the sources said there was little likelihood of its full findings being published.

They said it was a "very involved subject", with broad

and important implications for shareholders in the mining companies.

"If we were to lock a portion of our future production into a price of \$500, and the price went up to \$1 000 an ounce, we would look a little sick, while a fall in the gold price to, say, \$350 would be of much benefit to shareholders."

One of the alternatives to hedging on the futures markets would be to sell forward to bullion dealers — effectively, dealers would lend cash to producers.

Dr Brand said in the Reuters interview that South Africa's 1980 gold production was about 650 tons, down from about 700 tons in 1979, reflecting the policy of mining lower-grade ore as the gold price rose.

In informal discussions in Washington, Dr Brand said he had underlined a call by the Minister of Finance, Mr Horwood, for an International Monetary Fund investigation of gold's role in the world monetary system.

The sharp rise in the gold price over the past two years had caused a major inflow of funds to South Africa and a surge in money supply, and there would be a strong attempt to get the money supply

under further control, said Dr Brand.

This would mean that domestic interest rates would be higher than they were last year.

Major moves would probably be delayed until the findings of the De Kock Commission on the monetary system, expected towards mid-year.

The higher interest rates would be one factor in reducing economic growth, said Dr Brand, and the growth rate for this year was estimated at 5% against 8% in 1980.

The recent sharp appreciation of the rand was also likely to stop. The present 30% premium of the commercial rand over the financial rand was unlikely to change in the near term in spite of the Government's desire to unify the two rates.

South Africa's current account surplus was likely to be reduced in 1981, and the Government would only need to borrow externally to keep a presence in international markets.

Dr Brand added, however, that Escom and the Railways would need capital during the year, and if conditions in domestic capital markets were not right they might borrow on international markets.

# Pressure is on at some gold mines

NM 6/3/81 (79)

Inclusion

Nieuwveldt

R25 a week

**Financial Editor**  
**JOHANNESBURG**—  
 The average break-even point for the South African gold mining industry is \$218 an ounce, based on the December quarter working costs and grades, but for some mines the pressure is on at the current gold price, analysts said.

Questioned on the fall in the gold price to well below \$500 an ounce, analysts said to some extent the current rand exchange rate of \$1 274 compared with \$1 335 averaged in the December quarter, is cushioning the fall in the gold price.

Nevertheless, analysts said dividend prospects at a number of mines were not good at present and

some mines must also be close to State Assistance.

Mines like W R Cons must be on State Aid, while Durban Deep and ERPM must be close, as well as Venters and Leslie.

If the gold price stays at current levels, Marievale will be forced to close and it is unlikely to apply for State Aid. A mine must show a life of about eight years before aid is possible.

Lorraine, which has a break-even point of \$537 an ounce based on the December quarterly results, is in a very difficult position. The mine has recently undertaken a R80 million five-year capital expenditure programme which is considered necessary for the long-term future of the mine — R27 million is to be spent this year and R28 million in 1982. No dividend was paid in the year ended September 1980.

ERPM is yet another

mine with a huge R300 million five-year expansion programme underway. The company also made a R47 million rights issue as a precaution if the gold price were to temporarily fall below \$600.

Chairman Mr Danny Watt told the annual meeting last September the company would be able to weather a fall in the gold price to around \$500 for a year, without having to review the expansion programme, but a prolonged fall would force the mine to review the situation rather than carry on the programme in its proposed form.

Welkom, which has begun to move into lower grades, might arrest this to some extent, but generally the mine has worked out most of the higher grade areas. In the December quarter the grade fell to 4.75 grams a ton from 4.87 g/t.

Workers

R per year.

ve %

**ANALYSTS** said at the current gold price and working on December quarter figures, the break-even point for the gold mines in the industry and excluding uranium is:

FS Geduld \$187,	Durban Deep \$421,	West Dries \$116,
Pres Brand \$185,	ERPM \$435,	Randfontein \$280,
Pres Steyn \$232,	Harmony \$346,	Western Areas \$366,
Vaal Reefs (North) \$201,	Buffels \$228,	Bracken \$303,
Vaal Reefs (South) \$153,	Stillfontein \$246,	Grootvlei \$281,
Welkom \$270,	Deelkraal \$404,	Kinross \$212,
West Deep \$154,	Doorns \$200,	Leslie \$348,
Western Holdings \$164,	East Dries \$100,	Maries \$349,
E T Cons \$214,	Kloof \$126,	St Helena \$159,
Harties \$194,	Libanon \$248,	Unisel \$229,
Lorraine \$533,	Venters \$383,	Winkels \$144.
Blyvoor \$220,	Vlaks \$323,	

Mean: R23,79

Range: 0 to R400

The 22 workers in the lowest bonus category received no bonus at all.

Included in the table are 24 workers, on four farms, whose

# Gold lower, but boom will go on — economists

Angus 7/3/81

79

## Financial Editor

**THE gold price has tumbled in the past two weeks giving rise to fears that the business boom might soon start to peter out. But economists generally believe there is little likelihood of this.**

A lower gold price will reduce South Africa's foreign exchange earnings and reduce the amount of money available for buying goods from overseas.

But there is no need to worry about this happening at this stage.

Dr C Stals, senior deputy governor of the Reserve Bank, made that clear this

week. He reported that if it became necessary, the Reserve Bank could easily borrow up to 1000-million dollars (R780 - million) overseas. Furthermore, it could raise at least a similar amount of money through gold swops.

## MONEY SUPPLY

Dr Stals gave the impression that the Reserve Bank would probably welcome a small balance of payments deficit. Such a development would probably help it to control the money supply and reduce inflationary pressures.

Mr Brian Kantor, a senior lecturer at the School of Economics at the University of Cape Town, said it would take a sharp fall in the price of gold to below 500 dollars to reduce aggregate demand below potential output this year.

In an economic forecast prepared for a group of Cape Town stockbrokers, he argues that South Africa's economic growth rate last year was not the official 8,1 percent or so but 17,4 percent.

The low official figure is due to gold output being valued for the national in-

come figures at 1975 prices.

The high gold price was not just the result of inflation and had a real influence on the economy.

The accumulated momentum from the 17 percent growth rate will continue to drive the economy for the better part of 1981.

This would continue to be the case even with a falling gold price and rising real interest rates.

Real growth as conventionally measured is likely to be more than 5 percent, Mr Kantor says.

## BUSINESS MAIL

# Downside only for gold, say the fundis

RDY  
11/3/81

79

LONDON. — Gold remains fragile and is unlikely to withstand sustained pressure which could result in its testing \$450 in the next few weeks — and be found wanting, according to the predominant view in a survey of dealers and analysts.

A Reuter survey shows some experts believe the price may consolidate after rallying to above \$470 from its fall to nearly \$450 last week — its lowest since December 1979 and showing a loss of more than \$100 in six weeks.

However, few are convinced of the prospect of any upside potential. There is a wide expectation of a fall to \$400 to \$420.

Nevertheless, the effect on gold of any failure by the US Administration to check Government spending will be overshadowed by interest rates as long as the Federal Reserve maintains a tight monetary policy, say US dealers.

Although dealers in Europe and elsewhere report a restoration of physical demand and renewed speculative purchases, the extent of the bearish sentiment overhanging the market is illustrated by the result of a survey of US brokerage advisers last week which showed only 18% expected gold to rise.

Commenting on the recent rally, some London dealers note the strong overhead resistance encountered at \$520 last month when gold appeared to be consolidating above the \$480 psychological and technical support point.

One dealer believes the upside resistance point could since have fallen to \$490 to

\$500. A downward break is, however, more likely than an upward movement, and given the present nervous market, a severe drop is in prospect to about \$400, he says.

One analyst says that any softening of US interest rates over the next week or so could stimulate sufficient interest to provide a phase of consolidation.

Another says the timing of any upturn later this year will relate directly to the movement of US interest rates, in which a buy signal for gold would correspond with a fall in prime rate to below 15% from the 18.5% now charged by major US banks.

For the next few months the price is likely to stay in a dull trading range, which could be a bottom building phase for much higher prices later in the year, he says. Technically, gold looks to be forming a double bottom, which would propel an eventual return to \$700.

Some Zurich dealers believe the recovery which set in last week reflects a bottoming out of the downtrend, but others see scope for further falls to perhaps \$425/\$430.

Those who believe the price may slip below \$450 say there is virtually no chance it will breach \$400, which would be below the level at which a number of central banks of industrialised countries have officially valued their gold reserves.

They say professionals and speculators have been the main influence in the market lately, with large investors holding off.



# Fall in S Africa's gold production

17/3/81

Mercury Correspondent (79)

SOUTH AFRICA's gold production fell marginally to 1 725 120 ounces in February from 1 727 538 ounces in January, but was substantially lower than the output of 1 844 109 oz in February last year.

While the gold price has shown a downward trend over the past few weeks, lower grade areas are still being mined, as the average price is relatively higher than it was some time ago.

Mr Gerald Langton, managing director of Anglo American's gold division, said yesterday it was not surprising that overall gold production had dropped, as mines could not change grades on a day-to-day basis, and a price of \$500 an ounce was still relatively high.

He noted that as forecast in the annual reports of the Free State producers, the gold price had changed to a level similar to the current price, and for this reason grades have been reduced.

## Planning

Mr Langton said there would be no change in Anglo's mine planning, as 'quite fortuitously', the group had anticipated the current gold price and was operating on that basis.

An important consideration is that mines are obliged to average out

## Business Mercury

their production for the life of the mine in terms of leases, so that in times of high gold prices they will exploit low-grade areas, and in turn look at high-

grade sections when the price is low.

Mr Colin Fenton, a director of Gold Fields of South Africa, said the group had devised a system which allowed flexibility on grades. He said the GFSA producers were in a position to change areas quickly, and fluctuations in the gold price were handled without too much difficulty.

terms,  
rse or cow  
Beaufort West  
again seemed  
extent this  
the grazing  
t West City  
ng has been

For the estimates of payme  
valued at the rates then curre  
Council common ground. Farme  
value of their land varied end  
may reflect actual variations  
safer to apply a uniform rate  
(127 workers had no cattle at  
one had 5 cows.  
one had 2 and  
One worker had one cow,  
Cattle:  
4 had 4 donkeys.  
3 had 3 donkeys and  
21 had two donkeys  
2 had one donkey each,  
100 workers had no donkeys, (76, 92%)  
Donkeys:

# Break-even

## gold price Average 23/3/81. (71) 'staggering'

**SOARING** working costs on gold mines sent the break-even gold price for Durban Deep to 376 dollars an ounce last year, up from 261 dollars in 1979.

In addition, capital spending was raised by 36 percent to R11.7-million

The break-even price represents a 'staggering' increase of 44 percent, says the chairman, D T Watt

'With very little scope to increase the gold yield, the profitability of future operations remains as sensitive as ever to fluctuations in the gold price, but with the added complication that a higher break-even price is now required.'

### 27 PERCENT HIGHER

Working costs of R31.90 a ton were 27 percent higher

From record earnings of R29.2-million (R9.7 million), total dividends of 460c were paid

But this year's average gold price is expected to be below the 617 dollars received last year, and a lower dividend will be paid in June, says Mr Watt

○ Earnings at ERPM increased fourfold to R55.2-million last year, the highest in the 85-year-old mine's history.

Its average gold price of 624 dollars was 85 percent more than the 1979 figure

Dividends will also be lower than last year's 189c because the gold price will drop below 600 dollars

Working costs of R45.57 a ton rose by 22 percent, an unprecedented rise, says Mr Watt. Costs continue to rise at an 'alarming' rate.

The mine is to spend R300-million over eight

years on expansion and modernisation

### FINANCING

This is to be financed from internal sources if the gold price averaged 600 dollars in the first year.

To prevent the drop in gold price hindering the programme the mine raised R46.7-million from a rights issue of shares. Another R15.8-million can be raised through options between 1983 and 1985.

○ Group Five Engineering's chairman, Mr Fred Low, forecasts a 20 percent rise in profits for 1981.

Earnings recovered sharply last year to R5.3-million from R860 000 with the ending of losses in Botswana.

Tom Hood

# Govt hopes for R1 500m surplus

79 NM 26/3/81  
Financial Editor

SOARING company taxes and a buoyant gold price have assured the Government of an estimated surplus on its accounts of at least R1 500m for the year to March 31, instead of the anticipated deficit of R3 657m.

The surplus would be made up of R1 242m in the Stabilisation Account and R300m surplus on the Government's accounts.

By the end of February the spending/revenue equation was R37m in deficit with revenue averaging R1 156m a month and spending R1 159m. But there was only R805m left to spend in March and if averages continue the surplus should be about R300m.

Revenue in March 1980 was R926m — 10 percent up on the average for the year.

There is a hidden factor that will make the real surplus larger. In the March 1980 budget Mr Owen

Horwood, the Minister of Finance, estimated a deficit for the year of R2 227m and he was expected to fund a further R1 430m in loan redemptions.

## Deficit

The total deficit was R3 657m. Most of this amount has been raised. For example, bonus bonds have brought in R100m more than anticipated and foreign loans have brought in R96,5m (just short of the R100m target) without much effort.

The Treasury has frozen R1 242m of the surplus in the Stabilisation Account.

Budgeted spending was R13 564m and the actual amount spent by February 28 was R12 759m — most departments have spent their full allocations.

Estimated revenue was R11 334m but so far R12 722m has flowed in — 2 percent above expectations — and there is more to come.

In the second area — that is Government money-raising — the latest accounts show a deficit of R67m which, with some fine tuning, will break even at March 31.

## Mini Budget

Earlier, when Mr Horwood presented his mini Budget, he asked for authority to spend R8 900m until he could present the main Budget in August. He did not quantify the income and spending except to say:

● Government revenue will be considerably higher than originally budgeted for;

● Tax revenues exceed this estimate (of R10 586m) by a fair margin;

● Expenditure on our efforts to contain Government expenditures have been largely successful;

On expected revenue in the year ahead, he said:

● Non-gold revenues promise to show another healthy increase during the next fiscal year;

● Gold revenue the estimation will be more problematical.

and payment  
listed  
week, cash  
say, cleaning  
on the farm  
two more  
mer's wife employs two  
even at wage rates as low  
male labour forces, there  
the farmer in taking on men  
the women to work in the  
those employing relatively  
men than those of most  
this is reflected in wage  
a captive labour force  
of working for the farmer  
obs are available, so the  
working in the town is

3  
4  
4  
4  
8

Washington

Hourly Type of work

Women workers: work

below.

wage and payment

Information

windows once a

are not likely

part-time to w

full-time work

as those listed

is no work for

workers. On o

house is a majo

few workers - tl

On some fa

domestic workers

rates which are

for the farmer

or not working a

women are faced

practically impos

mean that living

In Nepal malaria barrier in the area along the Southern border had for centuries reinforced the country's isolation. Control measures in the late 1950s initiated a wave of local migration hillsides, leading to economic and social development

In Ceylon eradication of malaria was accompanied crowded third of the island to what had been the r

versely, if supply is greater than demand, premiums will be adjusted downwards. Ideally, agrees Mackay-Coghull, the solution is to make coins freely available to meet local demand. But this would lessen SA's foreign exchange earnings from gold sales abroad so the Treasury is reluctant to let market forces play their full role. He believes the changes came at a propitious time for the market, as at present it is neither bullish nor bearish. He concludes: 'The only danger of the thing is that we find demand substantially higher than we think it will be.'

... blindness) has driven the central and southern tier of settlement ... Few of the houses are not large a about force, many standards tend to as, as much higher ated and dying or ... the vigor and e thary and quiet resignation on the thesis of advance and retreat.



Krugerrands . . . a new look to selling

### KRUGERRANDS Meeting demand

79  
FM 27/3/81

Official premiums charged on Krugerrands are to be raised on April 13 from their present 15% level to 20% for 1oz coins, 23% for 1/2-oz coins, 26% for 1/4-oz coins, and 30% for one-tenth oz coins. This is in terms of an agreement be-

1303

Alan L. Sorkin

Human Capital - a good or service which increases the productive capacity of human beings. This investment in health or education yields a continuing return in the future. Thus greatest benefits to young people, migration a form of human capital - migrate when young.

$$\frac{\text{GNP or NI}}{\text{POP}} = \text{per capita income}$$

GNP of India large, but since large population, so small per capita income. GNP - total productive capacity of the economy (useful for war potential). Expenditures on health potentially productive in four ways.

A. Increase the number of man hours of work that can be performed - unemployment can be a problem. (Ceylon by lowering the death rate increases productivity).

B. It improves the quality of work. Mushkin using an econometric model indicates that in agricultural regions of less developed countries endemic malaria reduced the productivity of workers by 30%. Weisbrod et al in an extensive study of the productivity effects of schistosomiasis in St. Lucia

tween the Treasury and the Chamber of Mines. The selling price will also from April 13 be based on the average of the previous working day's two price fixings on the London gold market. This is a change on the old system of determining Krugerrand selling prices on the previous Friday Monday London gold fix. A new distribution system has also been introduced.

These moves, says Intergold chief executive, Don Mackay-Coghull, are aimed at eliminating the secondary premium market in Krugerrands, which was open to speculative abuse

The existing distribution system had also led to long time delays for prospective buyers. By doubling the supply of Krugerrands for sale in SA to 300 000oz (announced by Finance Minister Owen Horwood in last month's Part Appropriation Bill) and increasing the official premium to a level about half that which prevails in the secondary market, government and the Chamber hope to move substantially towards matching supply to demand

Plans are for the 18 banks at present in the distribution system (these include the leading commercial banks) to operate the new changes. Existing bank commission on Krugerrand sales will be abolished and the buyer will pay only the new fixed premium. The banks will be reimbursed by the Chamber.

Of course, the carefully negotiated new distribution system could fall apart if demand continues to outpace supply. Then the waiting lists in Krugerrand purchases, which the banks will now abolish, and the secondary premium market could re-emerge.

Mackay-Coghull indicates government will adopt a flexible approach to premium setting. Should demand exceed supply premiums may be raised, he says. Con-

... to find any association between the number of workers and productivity. Very or by action of a of other activity is employed could be

E = illiteracy

(The coefficients for labour, infant mortality, and population per doctor differ significantly from zero at least at the 0.02 probability level).

C. By clearing otherwise uninhabitable areas it makes possible the use of natural resources that could not otherwise be used.

# Gnomes' mixed opinions on gold's prospects

S. Times 29/3/81

79

ZURICH — Has gold finally turned the corner? Here in Zurich — where all the action takes place — opinions are as varied as the weather.

A senior vice-president of one of Switzerland's biggest banks says: "There is no other way for gold to go but up. Yet an executive vice-president of the same bank tells me that he sees little upside for gold — at least not for the next few years."

A spokesman for another major banking institution is more guarded.

He believes that the outlook for gold hinges largely on the pending American monetary reforms. He adds: "The application of a consistent monetary policy combined with supply-side measures offers a good chance of curbing inflation, reducing unemployment and increasing capacity utilisation."

"Needless to say, Reagan and his team will have to fight a number of battles in Congress and in the public arena. Above all, one should not entertain any illusions regarding the amount of time that is needed to implement this economic programme."

Returning an inflation-ridden economy to the path of purchasing power stability represents a task which takes several years.

What I find especially intriguing is the common belief among all the banks that their clients should be holding between 10% and 20% of their portfolios in gold.

Even those who are adopting a bearish stance on bullion will not hear of their clients dropping the gold ratio of their portfolios below 10%. Which suggests that tradition does not evaporate easily.

It also suggests that there is a steady demand for gold, as new clients are presumably credited with their requisite 10% shortly after being taken on to the books.

Obviously, the age-old arguments as to why gold should move one way or the other are being trotted out in Zurich as they are in Johannesburg.

However, the gnomes tend to give some of them a somewhat different slant. Those who view gold's outlook in a positive light follows:



By JOHN SPIRA

## DIAGONAL STREET

### Outlook

### Hinges

### on U.S.

### Reforms

their official reserves — and adding to it. There is no more talk of demonetisation. Gold has graduated to a stratum where it has earned the label of respectability.

"World gold output is relatively small — and dropping. Its current annual value is in the region of \$18 000-million — a tiny figure when compared, for example, with Opec's surplus of \$120 000-million."

"International political tensions might have eased a little recently. But the potential for another major flare-up is ever-present."

"Gold remains an important component of world monetary reserves. When the price stood

tige as well as practical reasons.

And while he discounts the possibility of a renewal of US or IMF gold sales, he sees the withdrawal of facilities for the financing of the Hurts' silver stockpile as part of a grand plan to keep gold down and the dollar up.

"Unlike the Carter Administration," he says, "the Reagan Government is not overtly hostile towards gold. But, since a high gold price implies a weak dollar, the standing of the latter will be given top priority."

Since gold and silver are both precious metals and as such tend to move in tandem, a soft silver price will prevent gold from moving to the levels

witnessed last year.

Interestingly, one of the banks is now having certain of its clients invest in selected South African gold shares on the basis of the attractive returns currently ruling and the fears inherent in these shares when bullion moves higher.

On balance, however, the banks are wary of investing in South African gold shares, because "costs are rising rapidly and the South African inflation rate is showing a few signs of abating."

Political risk is not offset by high returns. "The South African economy is on the verge of a recession — a development which implies lower prices of South African shares across the board."

When I left Johannesburg 120 weeks ago, my overriding impression of local and world opinion regarding gold's future

price behaviour was of virtually undiluted pessimism.

After spending some time in Zurich, I learn that this is not the case.

For the past several months, I have been among those who expected a weaker gold price two weeks ago. I was unable to rid myself of the nagging thought that if bearish opinion was as prevalent as I believed it was, perhaps — on the grounds of contrariness — the time had come for a new bull phase in gold.

Apparently, this is now not so. Generally, the theory of contrary opinion operates only in circumstances of overwhelming bullishness or bearishness.

With world opinion so sharply divided as to gold's future performance, I am inclined to the view that it remains in a bear trend — despite the strong improvement of the past couple of weeks.

# STEEL PIPING FOR SALE

Round Pipe in Shorts (1.5 - 3.5 metres) approx. 70 tons each 273 O.D. x 10.0 and 406 O.D. x 10.0 to BS4360 Grade 43C. R345 per ton or o.n.o.

"Interest in the yellow metal has broadened considerably over the past two to three years -- a factor which implies that steady net long-term buying should buoy up the price whenever it starts sinking to lower levels.

"National monetary policies have altered. Central banks and various official bodies are now, in contrast to the situation of three to five years ago, holding gold as an important part of

gold holdings throughout the world exceeded the value of total global foreign exchange.

Accordingly, a reduction in the gold price reduces the world's pool of international liquidity, so that at a certain (unspecified) price for gold the central banks will launch a support operation to ensure sufficient lubrication for the wheels of international trade.

"Middle East buying has become a permanent feature of

"The speculators have finished selling and may enter the market again shortly."

I must confess to having been surprised over the comments gleaned from those who are taking a negative view of the gold outlook. I had expected them to project the price to lower levels over the next year or two -- but certainly no further ahead than this.

Yet the economic adviser of one of the banks was unequivocal in his belief that the world is on the threshold of an era of low and containable inflation rates.

He says: "After 20 years of constant erosion of purchasing power, no one wants inflation. The man-in-the-street has suffered for long enough and he is now demanding a halt.

"A few years ago, no one would have believed that the electorate of the world's strongest economy could have voted -- to so overwhelming a degree -- for a man whose prime election platform was to fight inflation.

"To me, this represents a complete change in the fundamental approach to money management. And I am confident that it can work. The world can enjoy growth without inflation.

"But before this can materialise, some of the excesses of the past will have to be eradicated. Accordingly, I cannot envisage reflation in the US in the short term -- certainly not before the end of this year.

"Reagan's mandate is clear. The people have told him he must beat inflation. And this he will do -- to the exclusion of all else.

"This is why I expect gold to decline and remain below \$600 for the next several years."

Another source is adamant that the US is setting its sights on a strong dollar -- for pres-

# Germany

## roars into

S. Times 29/3/81

## SA gold

79

79

(T)  
IO (-  
(1  
(E)  
(S)  
Filed  
:  
tr previous  
les can be  
re work was  
on on their  
etc., but answers elicited in this way are probably of little

SOUTH Africa is selling a far greater proportion of its bullion through German banks.

German bullion sources estimate that the Reserve Bank sold about 25% of its gold through West German bullion houses in 1980 compared with about 10% in the Seventies.

The increase in the German share of the cake was at the expense of the Swiss houses. Sources here estimate that the Swiss Gold Pool, Union Bank of Switzerland, Swiss Bank Corporation and Credit Suisse received only about 40 to 50% of South Africa's gold last year.

In the early Seventies, about 70% was sold through Switzerland, 20 to 30% was sold through London, and New York banks and merchants received about 5% of the production.

The main German gold dealers are Deutsche Bank and Dresdner Bank, and Deutsche Bank, in particular, is very active in the market.

A few months ago some Swiss bankers were complaining bitterly that they were receiving less gold. Yet in interviews in Zurich they appeared much happier and said that they were again receiving more South African gold.

The German banks have become competitive because they have excellent connections with

By Neil Behrmann  
Frankfurt

wealthy Arabs and official agencies of Opec. The same applies to the Swiss, but over the past few years the Germans have been highly competitive in the market.

In a recent interview in Pretoria, Dr Chris Stals, senior Deputy Governor of the Reserve Bank (who is in charge of South Africa's gold sales operations), said that the bank had a very sophisticated dealing team which sold the gold at the best possible price. Dr Stals said that the dealers understandably sold to aggressive bidders.

But he recalled that in the past few years Zurich, Frankfurt and London rather than New York had tended to place the larger orders.

European bullion managers also point out that they have accepted gold in poor markets. The Americans, on the other hand, withdrew whenever the market turned.

A German bullion manager said that South Africa would probably sell its full production this year because the current account of the balance of payments had turned from surplus into deficit.

Last year the Reserve Bank

increased its gold reserves by about 65 tons.

So actual gold sales were lower than production during 1980. Dr Stals emphasised that South Africa would not be forced to sell more gold than annual output this year, even if the present rally petered out and the market resumed its downtrend.

He said the Treasury had repaid a considerable proportion of foreign loans during the gold boom of 1979 and 1980, so that there were plenty of credit facilities available.

He said that South Africa's credit standing was excellent. Besides conventional credit, the Reserve Bank could use a proportion of gold and swap if for foreign exchange.

In 1975 and 1976 the Reserve Bank deposited 8-million ounces of gold with Swiss and German banks, and received foreign exchange to tide the economy over a weak period. When the gold price strengthened in 1979 and early 1980 the Reserve Bank repaid the foreign exchange and sold 4-million ounces on the market.

There is now considerable scope to roll over the present swap and to renegotiate yet another gold swap deal.

German and Swiss bullion houses said that this would be necessary only if the price fell to the \$400 area.

When pressed, workers would agree that it would be better to have a bigger house, more money, longer holidays, etc., but answers elicited in this way are probably of little

suspicious and unwilling to voice their complaints in case they landed in trouble later.

# Industry buys more gold

JOHANNESBURG—Although the current gold market is described as weak, it is showing remarkable resilience in the face of high real interest rates.

This is so particularly in the United States and there is evidence of increasing offtake by the industrial sector, say the chairmen of the Transvaal gold mines administered by Anglo American Corporation.

Writing in their annual reviews for 1980, Mr Gerald Langton, chairman of Western Deep Levels, Mr Dennis Etheredge, chairman of Vaal Reefs, Mr Harry Oppenheimer, chairman of Elandsrand and Mr Nicholas Oppenheimer, chairman of S A Land, comment:

This underlying long-term strength reflects the compensatory nature of the various market sectors and the likely trend of market fundamentals over the next few years. It bodes well for the future.

It seems clear the price volatility during the past year stemmed almost entirely from the activities of short-term investors and speculators who used the gearing opportunities afforded by the futures markets, particularly in New York, to trade enormous quantities of gold, the chairmen say.

### Futures

The influence of these futures markets has grown spectacularly along with their trading volumes. During 1975, the first full year of trading, approximately 900 000 gold contracts were traded in U S markets.

Last year, a total of 11 000 000 contracts was traded, representing approximately 34 400 tons of gold or 138 tons of gold daily on average.

Looking at such volumes in the context of a total supply of physical gold in 1980 of only about 1 074 tons, excluding scrap, (1979 1 765 tons) the dominance of the futures markets rather than the physical bullion markets in short-term price determination is hardly surprising, the chairmen point out.

In spite of this, last year's gold price volatility was relatively of the same order as that seen in 1973.

(unknown) : (9)

2	32	18	6	10	124
3	1			2	4
3	1				6
3	4	1			10
3	3	2	1	1	13
3	1			1	3
3	7			3	15
4	3				9
4	5			2	18
9	3			1	21
1	1				13
2	4				12
5,01-7,50	10,0			15	

### Net supplies

Net supplies by the major producing nations, South Africa and Russia, declined to approximately 645 tons and 80 tons respectively after 703 tons and 230 tons in 1979.

The high gold price enabled South African producers to exploit lower grade ores and the Reserve Bank to withhold gold from the market.

It also assisted the communist block to achieve its foreign exchange requirements with significantly lower sales volumes.

In spite of the continuing expansion of the South African gold mining industry, supplies from this source are unlikely to increase significantly, owing to the lower grades being mined.

The IMF supplied only 69 tons in 1980 in the final auction sales of its four-year programme compared with 170 tons in 1979 and it seems unlikely that further supplies will be made available from this source, at least for the foreseeable future.

New gold offtake by jewellery manufacturers is estimated to have fallen to about 350 tons or less than half of 1979 levels. — (Sapa)

OF WORKERS	TOTAL NO.
> 65	
60, 1 - 65	
55, 1 - 60	
50, 1 - 55	
45, 1 - 50	
40, 1 - 45	
35, 1 - 40	
30, 1 - 35	
25, 1 - 30	
2,01 - 25	
0 - 20	
AGE (YEARS)	(R)
WAGE	

Distribn

Age (x) a

35



# Gold price should stabilize this year

79 CT 31/3/81

—Anglo

TODAY'S gold mine annual reports from the Anglo group contain both bullish and bearish news — a fairly encouraging forecast that the gold price should stabilize this year but there is an unexpected R120m rights issue by Elandsrand and little immediate prospect of expansion at Sallies, both of which will not find favour with the gold bulls. Sallies, too, is to make a rights issue.

Elandsrand's board says the right issue is necessary due to the drop in the gold price and problems in mining operations which have retarded the build-up of tonnage from the upper levels of the ore body over the past two years.

It had been hoped that sufficient funds could be realized from early stoping operations to meet Elandsrand's continuing capital expenditure programme with any shortfall being covered by bridging finance arranged with AAC. The mine has used some R38,6m of its R40m loan facilities with Anglo.

A shareholders' meeting will be held on April 21 to approve an increase in the authorized share capital from R16m to R21m and shareholders will also be asked to sanction an increase in the borrowings limit from R40m to R100m.

## Elandsrand

Elandsrand will use the funds to continue with the development of a sub-vertical shaft system allowing it to mine the higher grade reef at lower levels to realize the considerable profit potential.

Sallies is to undertake a two-year underground sampling programme costing R10,1m over the old Van Dyk No 5 shaft. The announcement says the programme will enable the company's technical advisers to evaluate with greater accuracy

the development of the gold market."

And the chairmen are particularly confident on the long-term outlook.

Mr Gerald Langton, chairman of Western Deep Levels, Mr Dennis Etheredge, chairman of Vaal Reefs, Mr Harry Oppenheimer, chairman of Elandsrand, and Mr Nicholas Oppenheimer, chairman of SA Land comment that this underlying long-term strength "reflects the compensatory nature of the various market sectors and the likely trend of market fundamentals over the next few years.

It bodes well for the future,

rather than the physical bullion markets in short-term price determination is hardly surprising, the chairmen point out. Despite this last year's gold price volatility was relatively of the same order as that seen in 1973-74.

## Lower grades

Net supplies by the major producing nations, South Africa and Russia, declined to about 645 tons and 80 tons respectively after 703 tons and 230 tons in 1979.

The high gold price enabled South African producers to exploit lower grade ores and the Reserve Bank to withhold gold from the market. It also assisted the communist block to achieve its foreign exchange requirements with significantly lower sales volumes.

In spite of the continuing expansion of the South African gold mining industry, supplies from this source are unlikely to increase significantly due to the lower grades being mined. However, Soviet sales could possibly return to previous levels should economic circumstances so dictate.

The IMF supplied only 69 tons in 1980 in the final auction sales of its four-year programme compared with 170 tons in 1979, and it seems unlikely that further supplies will be made available from this source, at least for the foreseeable future.

## Jewellery

New gold offtake by jewellery manufacturers is estimated to have fallen to about 350 tons or less than half of 1979 levels. Renewed demand nevertheless may be expected as the market eventually adjusts to higher price levels and as the availability of scrap gold declines.

"Unless official sales resume on a large scale, and this is unlikely, it would seem that demand will match the supply from all sources with price fluctuations being the determining factor. In the longer term these fundamental considerations will govern the development of the gold market."

## Uranium

The uranium outlook remains gloomy with the market oversupplied and prices likely to be affected by the new Australian developments. Prices in the spot market fell dramatically during the year and opportuni-

By PAUL DOLD  
Financial Editor

the potential which exists for a full-scale mining operation. The gold bulls had been anticipating a virtual new mine in the near future.

And recent geological and sampling information suggests the extent and value of the ore reserves and potential reserves may now not be as great as was believed.

## Gold price

The gold price is showing remarkable resilience in the face of high world interest rates. The market should stabilize this year and in the longer term supply and demand fundamentals will ensure that the trend remains upward, the chairmen of Anglo's Transvaal mines say.

"Unless official sales resume on a large scale, and this is unlikely, it would seem that demand will match the supply from all sources with price fluctuations being the determining factor. In the longer term these fundamental considerations will

irrespective of the short-term fluctuations which will undoubtedly persist.

"It seems clear the price volatility during the past year stemmed almost entirely from the activities of short-term investors and speculators who used the gearing opportunities afforded by the futures markets, particularly in New York, to trade enormous quantities of gold."

The influence of these futures markets has grown spectacularly along with their trading volumes. During 1975, the first full year of trading, about 900 000 gold contracts were traded in US markets. Last year a total of 11m contracts were traded, representing about 34 400 tons of gold or 138 tons of gold daily on average.

Looking at such volumes in the context of a total supply of physical gold in 1980 of only about 1 074 tons, excluding scrap, (1 765 tons) the dominance of the futures markets

ties for doing new short-term business at reasonable prices were further reduced.

In addition to the over-supply condition which has developed, South African uranium producers have also to contend with the desire of many of the electricity utilities to diversify their supply source.

The fact that Australian producers are receiving permission to proceed with the development of their mines has presented the utilities with this opportunity which has been compounded by the aggressive pricing policy adopted by the Australians.

"Given a situation in which uranium over-supply is projected for some years, it is difficult to see how spot prices can improve and pressure from our present customers to modify our existing contracts appears a likely corollary. At best it will be possible to maintain present contract prices only in current money which means, of course a decline in real terms."

To a great extent health is a purchasable commodity. South Africa

can purchase as much or as little health for its money

with

the Ca

to

it

s of

rely

- an

cymen

al

ation

ty is

its

oup H

strate

y

ation

evolve

strate

1.

the

. the

social

rise

tion

nd

ture t

to a

table

brunni

ities

# IMF gold sales unlikely, say Anglo chairmen

RDM 31/3/81 79

## Financial Reporter

**FURTHER** gold sales by the International Monetary Fund are unlikely in the foreseeable future, according to experts at Anglo American Corporation.

They also say gold is showing remarkable resilience in the face of high interest rates, particularly in the United States.

These views are put forward in identical comments by Mr Harry Oppenheimer, in his capacity as chairman of Elandsrand, Mr Nicholas Oppenheimer, chairman of SA Lands, Mr Dennis Etheredge, chairman of Vaal Reefs, and Mr Gerald Langton, chairman of Western Deep Levels.

They say that in spite of this, last year's gold-price volatility was relatively of the same orders as that in 1973-74. demand will match the supply

from all sources with price fluctuations being the determining factor.

"In the longer term these fundamental considerations will govern the development of the gold market.

"Notwithstanding short-term speculative influences (we) believe that 1981 will prove to be a year during which the market stabilises and, in the longer term, supply-demand fundamentals will ensure that the trend will remain upward.

"This underlying long-term strength reflects the compensatory nature of the various market sectors and the likely trend of market fundamentals over the next few years. It bodes well for the future, irrespective of the short-term fluctuations which will undoubtedly persist.

The chairmen say: "It seems

clear the price volatility during the past year stemmed almost entirely from the activities of short-term investors and speculators who used the gearing opportunities afforded by the futures markets, particularly in New York, to trade enormous quantities of gold.

"The influence of these futures markets has grown spectacularly along with their trading volumes.

"During 1975, the first full year of trading, approximately 900 000 gold contracts were traded in US markets. Last year a total of 11-million contracts were traded, representing approximately 34 400 tons of gold, or 138 tons of gold daily on average.

"Looking at such volumes in the context of a total supply of physical gold in 1980 of only about 1 074 tons, excluding scrap, (1979 1 765 tons) the dominance of the futures markets rather than the physical bullion markets in short-term price determination is hardly surprising."

They say that in spite this, last year's gold-price volatility was relatively of the same order as that in 1973-74.

Net supplies by the major producing nations, South Africa

and Russia, declined to about 645 tons and 80 tons respectively after 703 tons and 230 tons in 1979.

The high gold price enabled South African producers to exploit lower-grade ores and the Reserve Bank to withhold gold from the market.

It also assisted the communist block to achieve its foreign-exchange requirements with significantly lower sales volumes.

In spite of the continuing expansion of the South African gold-mining industry, supplies from this source are unlikely to increase significantly because of the lower grades being mined.

However, Soviet sales could return to previous levels should economic circumstances dictate.

The IMF supplied only 69 tons of gold in 1980 in the final auction sales of its four-year programme compared with 170 tons in 1979 and it seems unlikely that further supplies will be made available from this source, at least for the foreseeable future.

New gold offtake by jewellery manufacturers is estimated to have fallen to about 350 tons - less than half of 1979 levels.

3

believes TB to be on the rise due to the combined effects of resettlement, poverty, malnutrition and overcrowding, which he describes as 'a positively lethal combination', particularly when coupled with the factors of family breakdown, migrant labour, poor agricultural development, non-existent labour opportunities, limited land resources and the efforts of people to support themselves on reduced remittances from migrant labourers (Star, 25 January 1978). Against such a background there is, he believes, no possibility for a decrease in TB. Similarly medical reports have emphasised that it is a web of social and political circumstances that is the major determinant of the rates of malnutrition in this society. The annual report of St Michael's Mission Hospital in Baltharos, for instance, states that much of their medical work is devoted to combating malnutrition and it comments that this work is mostly pointless as the effect of divided families, low wages, widespread poverty all combine to lead to medicine having little impact on the incidence of malnutrition in this area. Increasingly it has been realised that social and political factors are the major contributors to the rates of morbidity and mortality in a society and ironically with the development of medical technology it has been recognised that this technology and doctors have only a limited role to play in improving the nation's health standards. To express this irreverently: considerable evidence points to the doctor and hospital at present standing in much the same relationship to implement effective medicine as the garage and motor mechanic do to implement effective road safety.

For too long the germ theory of disease has occupied the centre of the medical stage and it has been believed that to prevent or treat disease it is only necessary to break the most important link in a chain (Krikel and Beuster, 1977:167; MacMahon and Page, 1970). However, the correct model for interpreting causation of disease is more the interconnected web rather than that of a chain. Medical technology only play a limited role in affecting some of the factors in this web. If medicine separates itself from attempting to influence the other factors in the web not directly amenable to medical technology, it cannot by definition be effective medicine. To fail to recognise this would be to trap the medical profession into the role of body repair maintenance mechanics. In positive terms effective medicine is the medicine which is deeply involved in combating the whole causative circumstances - socio-economic as well as medical - underlying morbidity and mortality.

# Amgold hopeful on gold price

EDM  
3/4/81  
79

By ADAM PAYNE

IN a wide-ranging review of the gold mining industry, Mr Julian Ogilvie Thompson, chairman of Anglo American Gold Investment Company (Amgold) is optimistic about a "reasonable price" for gold this year. But he advises a cautious approach because further weaknesses could still occur.

He says in his report for the year to February 28: "The outlook for gold supply is for continued gradual decline, barring substantial increases in communist sales which are more than usually difficult to predict in present circumstances.

"Further IMF and US Treas-

ury auctions are not foreseen, especially in the light of the renewed focus on gold's monetary role by the United States Congress and elsewhere.

"On the demand side there is evidence that both jewellery and certain categories of investment demand have begun to improve in response to the lower and relatively less volatile price, and other applications should recover gradually with the projected revival in the world economy later this year."

Mr Thompson says there is little consensus on the short-term economic outlook in the US, or on the prospects for a lasting abatement of inflation.

Energy problems persist and the geopolitical balance remains precarious. In this setting, the incessant build-up of investment funds in the Opec countries and elsewhere implies that gold will continue to have a role in accordance with the risk-aversion principle in portfolio management.

He believes overall demand will be sufficient to ensure a reasonable price for gold in the coming year.

Reviewing last year's gold market, he says an outstanding feature was the dramatic reduction in supplies. This drop was the result of lower sales from the communist bloc and more particularly of the cessation of the IMF auctions early in 1980 and the absence of any sales by the American Treasury.

With the disappearance of these two dominating supply factors, the official sector emerged as a net buyer for the first time in many years.

"The continuance of the reserve asset diversification process which has gained momentum over the past two years, as well as the transfer by certain central banks of their gold stocks to their own countries, provide added confirmation of the importance attached to gold as the major single component of international reserves.

"Estimates are that consumption by the jewellery industry halved; other fabrication was slightly lower as was the offtake for official coins, including sales of all Krugers which absorbed 3 142 500 oz compared with 4 940 755 in 1979. Net hoarding and investment, although much reduced, accounted for almost a third of total demand."

Reviewing the performance of the gold-mining industry last year, Mr Ogilvie Thompson says that revenue of more than R10 000-million was 80% higher and profit after tax and capital spending of R2 575-million was 125% higher than in the previous year.

Amgold's earnings at R315-million were nearly 2½ times those of the previous year.

For the industry as a whole,

there was a further decline in gold production from 702,8 tons to 674 tons. The average grade fell by 11,1% to 7,28 g/t.

Working costs a ton milled rose by 17,7% in 1980 compared with 11,2% the previous year.

Capital spending on producing mines, which had increased by more than 50% the previous year, rose by a further 34% to R922-million.

In 1980 the South African mining industry increased its uranium production by 28% to 7 078 tons, contributing to the global oversupply.

"A continuation of this situation in the next few years will make it unlikely that spot prices will improve and, at best, current contract prices will only be maintained which will mean a decline in real terms."

He says the dramatic drop in the spot price has occurred because of the fall in projections of demand for additional power generation.

Existing producers have expanded their production capacity and several new producers are about to emerge, particularly in Australia.

An oversupply is developing that is affecting uranium consumers' perceptions of the security of their future supplies.

This fact and the desire to benefit from prevailing high interest rates caused electricity utilities in the US to begin to liquidate surplus inventory which in turn accelerated the market's decline.

He considers that in the longer term there can be no doubt that the balance between supply and demand will re-establish itself, especially when utilities start ordering new generating capacity to maintain sufficient generating reserve and to replace obsolete capacity.

However, it is likely that when this balance does return to the market, projections of nuclear power growth will be more realistic than five years ago and prices will be more in line with market fundamentals.

The desire of uranium consumers to diversify their sources of supply may have an adverse effect on long-term supply contracts with South African producers, particularly since the future high-grade, low-cost producers in Australia have adopted an aggressive pricing policy, he says.

# Degree of Reagan's economic success critical to gold price

By Geoff Shuttleworth

The extent to which US President Reagan succeeds in his aims of rejuvenating the US economy will be of critical importance to the gold price, Amgold chairman, Mr J Ogilvie Thompson, said in the annual review.

The reduction of inflation and the re-establishment of a US presence in the world fall into the same mould as they will influence the factors which affect investment and speculative demand: inflationary expectations, the strength of the dollar and political and economic uncertainties.

"In this environment, and given the reduced level of supplies, there is hope for greater stability in the market which would be to the benefit of consumers of gold, parti-

cularly in the jewellery trade."

He said an outstanding feature of the year was the dramatic reduction in supplies to the market, despite a somewhat greater flow of scrap.

This was the result of lower sales from the communist bloc and more particularly, of the cessation of the IMF auctions early last year and the absence of any sales by the US Treasury.

With the disappearance of these two dominating supply factors, the official sector in fact emerged as

a net buyer for the first time in many years.

"This includes retentions by the South African Reserve Bank.

The continuation of reserve asset diversification process, which has gained momentum over the past two years, as well as the transfer by certain central banks of their gold stocks to their own countries, added confirmation of the importance attached to gold as the major single component of international reserves.

Less optimistically he noted that estimates are that consumption by the jewellery industry halved; other fabrication was slightly lower as the off-take for official coins, including sales of all Kruggerand coins which absorbed 3.1-million ounces of gold compared with 4.9-million in 1979.

Net hoarding and investment, although much reduced, accounted for almost a third of total demand.

"The outlook for supply is for a continued reduction, barring substantial increases in communist sales which are more than usually difficult to predict in present circumstances. Further official sales are not foreseen.

Turning to demand, he said there is evidence that both jewellery and certain

categories of investment demand have begun to improve in response to the lower and relatively less volatile price, and other applications should recover gradually with the projected revival in the world economy later in the year.

The role of central banks cannot be predicted with any certainty. However, the lack of progress on the Substitution Account proposals, the persistence of global payments imbalances and potential restrictions on the free transfer of monetary assets continue to impart an additional dimension of security to gold holdings as the ultimate means of settlement.

Private investors will be influenced by these issues and the firmer military stance being taken by Reagan Administration as well by the more immediate negative implications for gold of tight monetary policies and a stronger dollar.

Nevertheless, there is little consensus on the short-term economic outlook in the US or the wider implications of the proposed new fiscal strategy and the prospects for a lasting abatement of inflation.

In the meanwhile, energy problems are far from resolved and the geopolitical balance remains precarious.

- 13) Rossi, E.L.: "Growth Change and Transformation in Dreams". Journ. of Humanistic Psychology. 11:2, 1971.
- 14) Bührmann, M.V.: "Tentative views on dream therapy by Khosa diviners". J. of Anal. Psychology, 23:2, 105-111, 1979.
- 15) Bührmann, M.V., Schweitzer, R.D.: "Therapeutic Techniques among the Xhosa Amagqira (Indigenous Healers)".
- 16) Holdstock, T.L.: "The bodily aspects of the person-centred theory of Carl Rogers". J. of Humanistic Psychology.
- 17) Campbell, Joseph: "The Hero with a Thousand Faces". Abacuss, 1975, p.327.

Am.J. of Psychiatry.

Free Press, 1974.

Abacus, 1975.

Abacus for Psychiatry, 1979.

Johannesburg,

Its Relevance for

1974.

19 May 1977.

251.

4) Pfister Dshar "Instructive Psychoanalysis among the Navenos".

# Hard time ahead for gold, N.M. says Mines economist

3/4/81

Financial Editor

79

GOLD has a difficult time ahead but 'the picture could change suddenly', Mr Mike Brown, chief economist of the Chamber of Mines, told a seminar of the Durban Chamber of Commerce recently.

He said that the current economic and political situation may mean a fairly difficult period ahead for gold in the short term.

The fundamental factors continue to look favourable for gold and will probably increasingly assert themselves as the year progresses.

Mr Brown said that in the interim, the ability of the American authorities to maintain interest rates at a high level in an economy where growth was basically consumer-led and very vulnerable to high interest rates, as well as their success in combatting inflation in a possible scenario of increasing budget deficits, high defence expenditure and proposed tax cuts, will be watched with considerable interest by gold producers, users, investors and the gold and foreign exchange markets.

There were five points to be considered in the outlook for gold.

- While bullish euphoria had been deflated, other world anxiety factors and inflation had not been eased and were positive factors for the gold price;
- There has been no dramatic change in the politico-economic situation which would warrant any deep, or prolonged, fall in the gold price;
- It was possible that monetary measures and high interest rates could still force gold below its historic trend levels;
- Any fall in the price would be countered by a strong rebound in industrial demand, the absence of official sales and the continued development of gold as an investment and part of the monetary scene.

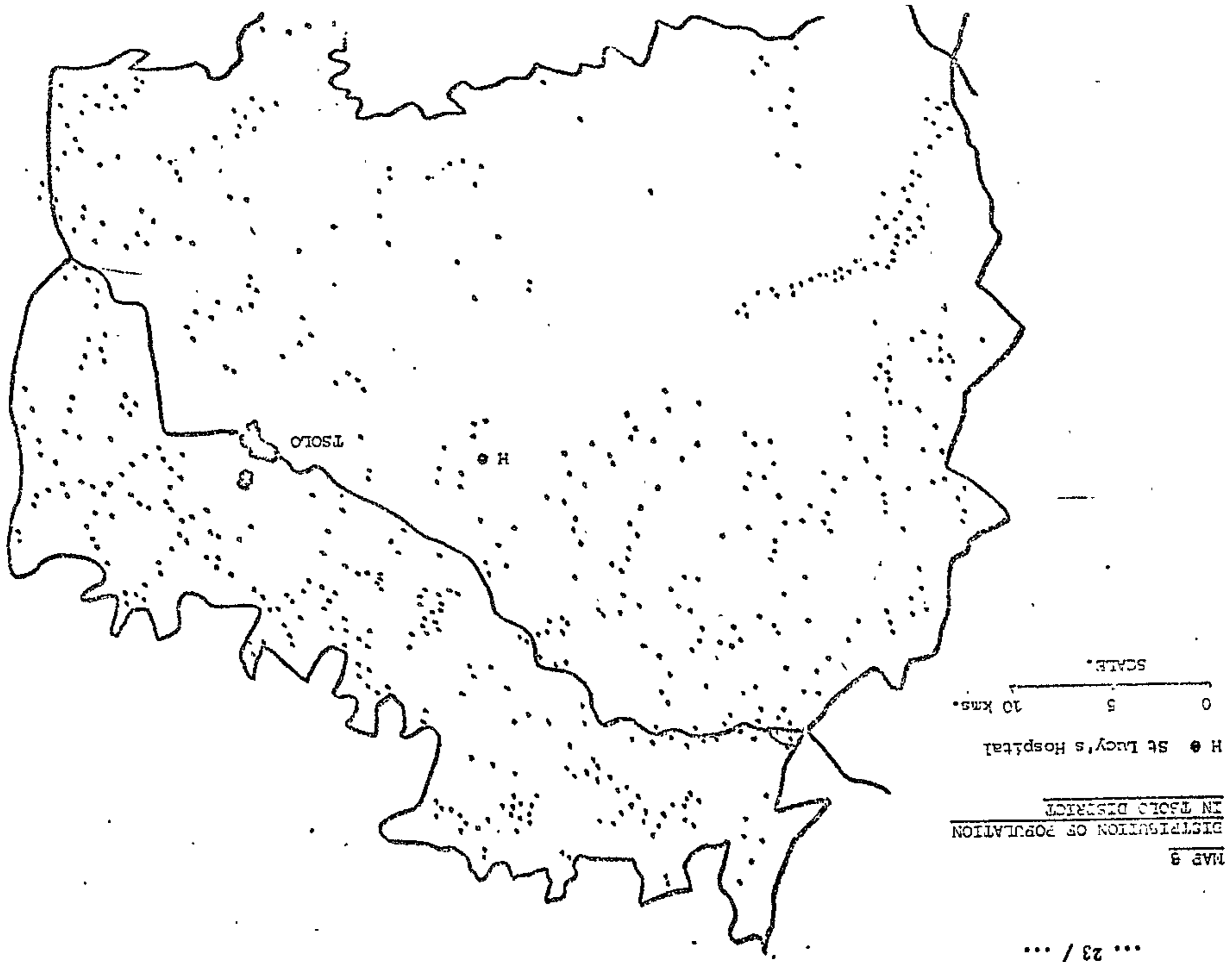

care delivery, involving local as well as professional workers, as, for example in CATBA's and Care Groups, which might combine the advantages of each.

The chances of admission to hospital were found to be similarly dependent on distance from hospital; those living more than 25 miles from a hospital had a chance of admission 10% of that of someone living less than 10 miles from a hospital. It seems probable that this pattern prevails throughout southern Africa.

The service cost per outpatient attended at hospitals is lower than at hospitals in the rural areas the cost per attendance at mobile clinics than at hospital and high cost of treating outpatients would alter that the marginal costs (that is, cost of patients seen) are probably higher patient contact requires more transport between running costs of clinics and outpatients institutions in Malawi, Botswana and Zimbabwe. It would be interesting to know whether patient at clinics is offset by lower travel time and cost) and a better quality of service.

### Legislation

'Legislation which prevents the upward mobility of blacks still applies and it is to be hoped that the forthcoming report of the Wiehahn Commission on industrial relations in the mining industry, which will now not become public until after the General Election in April, will suggest the means to overcome this problem. 'Imaginative thought will have to be given to training schemes as the old methods such as trade apprenticeship will not cater sufficiently rapidly for the needs of the future.' (Sapa)

might prove an incentive to develop new techniques of health

	Cost per contact	Cost per likely-effective patient contact (R)
6. Ibid. p. 53		
7. Ibid. p. 118:		
Fixed clinics	1,02	1,15
Mobile: air	2,09	15,96
Land	0,95	8,81

\*Ciskei Anti-TB Associations

# Drop in world gold supplies

NM 3/4/81

79

**JOHANNESBURG**—An outstanding feature of the year was the dramatic reduction in supplies of gold to the market, says Mr Julian Ogilvie Thompson, chairman of Anglo American Gold investment Company (Amgold) in his review for the year to February 28, 1981.

This drop was the result of lower sales from the communist bloc and more particularly, of the cessation of the IMF auctions early in 1980 and the absence of any sales by the American Treasury.

With the disappearance of these two dominating supply factors, the official sector in fact emerged as a net buyer for the first time in many years.

The continuance of the reserve asset diversification process, which has gained momentum over the past two years, as well as the transfer by certain central banks of their gold stocks to their own countries, provide added confirmation of the importance attached to gold as the major single component of international reserves,' says Mr Ogilvie Thompson.

### Jewellery

Estimates are that consumption by the jewellery industry halved; other fabrication was slightly lower, as was the offtake for official coins, including sales of all Kruger rand coins, which absorbed 3 142 500 ounces compared with 4 940 755 in 1979.

Net hoarding and investment, although much re-

duced, accounted for almost a third of total demand.

The outlook for gold supply is for a continued gradual decline, barring substantial increases in communist sales, which are more than usually difficult to predict in present circumstances.

'Further IMF and US Treasury auctions are not foreseen, especially in the light of the renewed focus on gold's monetary role by the United States Congress and elsewhere,' says Mr Ogilvie Thompson.

'On the demand side, there is evidence that both jewellery and certain categories of investment demand have begun to improve in response to the lower and relatively less volatile price, and other applications should recover gradually, with the projected revival in the world economy later this year. 'In relation to expected supplies, therefore, I believe that overall demand will be sufficient to ensure a reasonable price for gold in the forthcoming year but the present climate dictates a cautious approach in the light of further weakness that could still occur.'

New developments: Mr Ogilvie Thompson pointed out that the industry has taken advantage of the higher price of gold to embark on many new

projects.

Twenty shafts on 16 of the 37 mines in South Africa were in the process of development and it was perhaps only in the early 1950s, when the Orange Free State gold field was being opened, that as many shafts were being sunk as is happening now throughout the Witwatersrand basin.

Mining operations: Technological development is an area in which much effort is being concentrated with a view to reducing cost inflation, says Mr Ogilvie Thompson.

'It is important that there should be breakthroughs in the 1980s, particularly in relation to deep level mining where the problems of heat and rock pressure must be ameliorated.

'Initial steps have already been taken in the development of stabilising pillars in attempts to reduce the effects of seismic activity.

'With the same aim, trials have been conducted to establish a practical method of milling waste rock to fill mined-out slopes, and underground tests will commence during 1981.'

Mr Ogilvie Thompson emphasises that the shortage of skills is becoming more apparent daily in the mining industry.

# Polish loan exposure led to gold liquidation

CT 11/4/81

79

LAST YEAR it appeared that the gold price would largely be the result of the battle between jewellers and investors. Well, nothing has changed — this year that story will apply even more. What is fascinating is how this battle was fought and how the story is changing. New sources of supply appeared as well as new sources of demand on top of which volatility appears to have established itself as a permanent feature of the gold market.

## Disharding

This was a new source of supply. New in the way it was a major feature appearing at very high price levels. It was also new in that it was in the main "scrap jewellery".

It came out of the Middle and Far East with only some appearing in the West, in spite of the impression created by those pictures of long queues outside New York jewellers in January 1980.

Many believe that it was caused purely by the high price, but a closer look provides a fuller picture. Eighty tons of this gold came from Iran alone. Did they sell to get a profit, or did they sell to gain currency having brought it out of Iran and needed cash to set up a new home?

Did other Middle Eastern disharders have similar motives owing to the destabilization of the Middle East or did they do it for profit?

Jewellery sales show us that the sellers were the smaller investor insofar as the large investor would not need to resort to such actions. We know that the disharding from the Middle East took place in the first four months of 1980 in which time the gold price moved from \$850 to \$480 and then began to recover.

In the \$600 — \$700 region disharding from these sources largely ceased. So both causes

IN this article, the latest in our series where leading business men give their views on topical business trends, an investment specialist at The Board of Executors, Mr Julian Phillips, gives a personal view on the outlook for gold, and although the price is currently weak, suggests this may be a short-term situation.

Mr Phillips who was formerly with Hill Samuel and Chase Manhattan was originally a London stockbroker and settled in Cape Town a year ago.

He is closely in touch with bullion dealing in the main European and Far Eastern centres and has made a special study of the gold market over the past 10 years.



Mr Julian Phillips

could have influenced the small investor. The large investor did not liquidate his gold holdings; he just stopped buying when he felt prices were too high.

One thing is apparent, that although few gold market participants became disillusioned, more and more of them will be willing to take profits with a view to buying back at lower levels. Many disharders were unwilling or unhappy sellers.

For instance, European sources alleged that certain German "gold" banks were heavy sellers in the early months of 1981. Apparently their loans to Poland are large so when the situation there degenerated, they felt it prudent to protect against possible losses.

They chose to liquidate some of their own gold holdings to rectify the situation. This helped the gold price down to its recent low. The Bundesbank then stepped in with help.

Since then there has been no selling from those sources. Rather, other European bankers believe they will re-enter the market as buyers as soon as they can. So in both cases of disharding political instability caused a fall, not a rise in the gold price.

## Volatility

Since 1975 the growth of the futures markets in the United States has been spectacular. In 1980, 11m contracts were traded on the Commodity Exchange of New York.

This was approximately 34 400 tons of gold, or 138 tons of gold daily. On average, South Africa produces only 13 tons a week!

But the difference between physical supply and "Comex" trading is enormous. Comex definitely dominates short-term price fluctuations, but physical buyers control the medium and long-term prices.

When there was an excess supply of gold early in 1980 the gold price was pushed much lower than expected and with very little physical selling.

It was mainly the traders on Comex, partly speculating but mainly "hedging" (the first is inspired by a profit, the second by the need to protect himself against price movements) that pushed the price lower than had been expected.

probable more than double when unofficial purchases are added.

It must be remembered that official institutions are only interested in buying large volumes of gold. As a ton of gold only costs \$16m, smaller quantities look like small change.

If the price is rising on small quantities it is unlikely that central banks would participate until volumes rose.

Central banks are usually permanent holders of gold for two reasons.

First, they diversify their reserve holdings (Switzerland, Germany and France have proved the value of doing this throughout the 1970s).

Second, in the case of poorer countries, they free themselves from loan restrictions.

It works like this — should the IMF lend to a Third World country they frequently impose economic constraints on that country. The government of that country resents that, so buys gold with the borrowed funds, making further borrowings against that gold.

## Reduced supply

These new funds are then used to repay the IMF, leaving the second loan outstanding with no economic restrictions.

The most significant factor of all over the last three years in the gold price level is the fall in the supply of gold. The table attached shows how dramatic this will continue to be.

This fall in supply is spectacular. The fall off in supply from official sources, such as the IMF and the American General Services Administration, appears almost permanent.

As I have mentioned before, the fall in supply from Russia is due to its having decided to supply direct to large official buyers in the Middle East.

Furthermore, the disharding from the sources mentioned earlier have been completed, particularly at these price levels.

Whether a high price inspires massive disharding remains to be seen. If that is so, at what price is an even bigger problem!

David Potts of Consolidated Goldfields in London feels that that price should be around \$850 and higher.

Some feel it will be a little lower. It will have to be substantial if it is to replace the expected 25 percent drop in supply this year.

Remember too, that last year the 16 percent drop in supply (albeit accompanied by a similar drop in demand) led to a doubling of the average gold price. It is difficult to envisage a falling price pattern when such a large drop in supply is expected.

I can only agree with the statements emanating from the mining houses and gold market members who are indicating with admirable understatement, that the gold price trend remains upwards.

I would go further and say that the jewellers gained a reprieve last year due to disharded gold. So far this year there is no evidence of jewellery disharding.

It was they who took it up to \$850 from \$250 in mid-1979. They undoubtedly take their lead from the physical market but add this enormous volatility factor.

The level of their activity is certainly influenced by interest rate levels in the United States. Over the last six months when physical gold has been roughly in balance (on diminished demand and supply) rising prime rates in the United States have had a major impact on gold price levels.

Should demand outweigh supply markedly, I would expect Comex to add tremendously to any price rise, even if prime rates were rising.

One thing is for sure, the volatility factor provided by the futures market is here to stay.

### **New buyers**

1980 saw the entrance of two new buyers. Japan was the first. Traditionally Japanese ladies have not favoured gold jewellery because of its colour against their skin. Platinum has looked more attractive. But in 1980 the Japanese took significant quantities of gold, not for jewellery, but for long-term investment reasons.

The second new demand feature was much more significant. Official institutions, mainly Central Bank, purchases grew enormously in number and amount in 1980 and, so far in 1981 the trend is even more significant.

In 1980 actual recorded official purchases were 154 tons, although this figure would



# Mines need \$670 to maintain profit

SINGAPORE. -- South Africa's gold mines would need an average price of \$670 an ounce this year to maintain profit margins, said the vice-president of Merrill Lynch International, Mr David Fitzpatrick, at a two-day gold conference sponsored by Euromoney and Advanced Management Research International.

He said that given the continued rise in costs in the industry, the unit cost of producing an ounce of gold should register at least a 20% increase in the next 12 months.

Although political upsets could drive the gold price above \$670 at times, gold would probably trade below \$670 for much of the year.

South African gold mines continued to offer high dividend

income, even on the basis of a cautious gold-price forecast.

But in 1981 it was less likely that gold shares would outperform US stock markets in particular and world stock markets in general.

The gold price had been in a secondary bear market since January 1980 when it briefly touched \$850, and it could reach its low in the next three months, said Mr Fitzpatrick.

In 1980, about half of all new gold produced flowed into investment discounts. But this year, jewellery and industrial demand could absorb 90% of supplies, which would be bullish for the gold price.

At \$480 gold was at a comparable stage of its price or investment cycle as it was in mid-1976 when it traded near \$120. — Reuter.

(5/3) The Latitude of Promotional Agents

The actual methods of promotion are a direct result of the analysis of the product as well as by the industry and receive attention.

With other doctors accounted for 22% of the total, the firm literature, advisers and detailment sources of information. Detailment were a particularly prevalent source of information. Although doctors also rely on information sources such as MIMS, it is clear that promotional activities of firms are also of considerable influence; the fact that drug firms continue promoting must indicate that the effort pays off.

• / ...

South African gold mines continued to offer high dividend

South African gold mines continued to offer high dividend	South African gold mines continued to offer high dividend
---	---

(5/3) The Latitude of Promotional Agents

The actual methods of promotion are a direct result of the analysis of the product as well as by the industry and receive attention.

With other doctors accounted for 22% of the total, the firm literature, advisers and detailment sources of information. Detailment were a particularly prevalent source of information. Although doctors also rely on information sources such as MIMS, it is clear that promotional activities of firms are also of considerable influence; the fact that drug firms continue promoting must indicate that the effort pays off.

With other doctors accounted for 22% of the total, the firm literature, advisers and detailment sources of information. Detailment were a particularly prevalent source of information. Although doctors also rely on information sources such as MIMS, it is clear that promotional activities of firms are also of considerable influence; the fact that drug firms continue promoting must indicate that the effort pays off.

• / ...

# Gold bouggs talker heart!

S. T. Wines 19/4/81

(79)

## Chamber is bullish

By Andrew McNulty

A PLATTBORA of gloomy gold price predictions from the United States has been given the lie by an authoritative new study on the bullion market by the South African Chamber of Mines.

The chamber forecasts continuing, steady increases in central bank purchases of gold as nations with a surplus balance of payments, mainly those rich in commodities, seek to diversify their holdings of reserve assets from sole dependence on the US dollar.

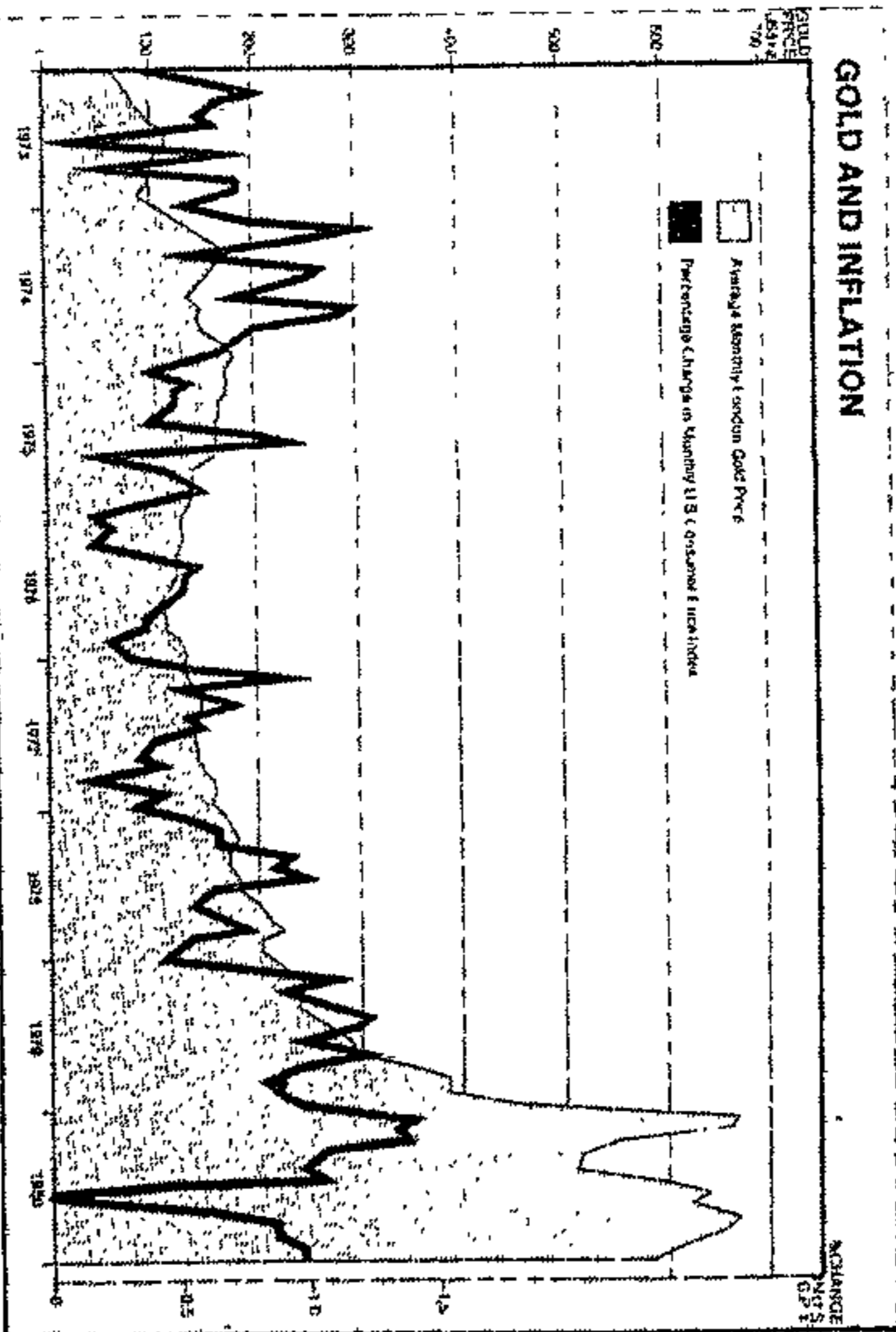

This graph, extracted from the Chamber of Mines report, highlights the close correlation between the gold price and percentage changes in US inflation.

This forecast is made by the chamber, which oversees South Africa's multi-billion gold industry, in a study which foretells the highly regarded annual gold market study by the London-based Consolidated Gold Fields.

The growth of central bank holdings of gold is seen as a strong stabilising factor in the market that can be expected to act as a cushion to any further weakness in the price.

The chamber says: "Demand from central bank gold purchases is an important factor in the gold market both through the growing physical off-take from the market by central banks and for the psychological support provided to the market through this official recognition of gold's desirability."

Total official gold reserves currently amount to 113.3-million ounces. At a gold price of \$500 an ounce, the value of these reserves amounts to \$56.6 billion.

This is more than double the official holdings of foreign exchange held by central banks.

which currently amounts to about \$260,000-million.

In addition to the importance of gold in the official reserve structure, the European Economic Community has pooled 20% of its gold holdings as part of the backing for the European Monetary System and the issue of European Currency Units.

About 85.63-million ounces of gold are now used for this purpose by member countries of the EMS.

Official IMF (International Monetary Fund) statistics show that purchases by central banks totalled 198 tons for the period January to December 1980.

But the figures are distorted because many countries — such as Singapore, Iraq, Iran and other Opec nations — are rumored to have purchased gold and have not updated statistics of their gold reserves.

Main additions to central bank reserves in 1980 are reported by Indonesia to be up 65.6 tons, South Africa up 65.9

tons (mainly constituting with-holding supplies of newly mined gold to support the gold market) and small but steady purchases by many South American countries, which led to an increase of 39.2-million tons in the reserves of "western hemisphere" countries.

The net change in central bank gold reserves in 1980 reported to the IMF amounted to 115.1 tons.

This was a primary aspect of greatly increased investment demand, which more than offset a 44% fall in demand from the industrial markets, where consumption is estimated at 575 tons in 1980 after the previous year's 1,022 tons.

Many experts predict that a sustained lower gold price will bring about a strong return of interest from the jewellery and other industrial markets.

Also expected further to bolster investment demand are purchases by private institutions and investors.

These include less sophisticated investors in developing countries who buy small gold bars or wafers as a means of storing wealth and of transporting wealth in emergency, and, secondly, more sophisticated investors in Western countries who purchase as part of a balanced portfolio of investment assets.

To Page 3

7940 Rev. 4  
UP-NUMBER

SPERRY U  
Converse

Term	R
X	
XQT command	5.2
%	2.5
.	2.5
*	2.1
	2.1

# Optimism on Gold

From Page 1

79

Included in this category are a growing number of institutions such as insurance, mutual or pension funds taking advantage of gold's hedging properties against inflation and the contra-cyclical nature of the performance of the gold price vis-a-vis other investment assets both to reduce the volatility of such portfolios and to preserve real asset values.

Other points from the chamber's study include

The high level of trading recorded on US gold futures markets in 1980 despite the extremely high interest rates reached at two stages in the year, which normally detract significantly from futures activity

The relationship between the price of gold and the price of oil was maintained during 1980, with the gold price following much the same trend as the spot price of oil on the Rotterdam market

Net supplies of gold to world markets in 1980 are estimated by the chamber at 1 380 tons compared with 1 765 tons in 1979. The 1980 total is made up of 980 tons of free world gold production net sales by the communist block of 100 tons and net dishoarding 300 tons.

Against the fundamentally firm background to the gold market, however, the chamber notes that the importance of investment demand in the present stage in the gold market makes investor expectations concerning future inflation rates, interest rates and currency fluctuations of prime importance

DD 22/4/81  
79

# Gold gives Horwood surplus of R1 200m

JOHANNESBURG — A budget surplus of R1 200 million appears to be the outcome of the fiscal year which ended on March this year, according to the preliminary figures issued by the Treasury.

When Mr Owen Horwood, Minister of Finance, presented his budget in March last year he forecast that his surplus would be R39 million but he was not to know that the price of gold would soar to the heights that it did resulting in the inland revenue account earning R11 833 million against an estimated R9 841 million.

But Mr Horwood has wisely tucked this surplus away, out of reach of grasping colleagues who

might be tempted to try to spend it.

During the course of the year R1 242 million was "frozen" in the stabilisation account and will only be used if the economy nose-dives and if the money supply position has been brought under complete control.

For the year to March total collections by Customs and Excise and Inland Revenue amounted to R13 302 million which was R2 446 million more than the original estimates.

State spending, including supplementary allocations, was expected to total R13 727 million. Actual expenditure, according to the preliminary figures, was R13 642

million which reflects favourably on the minister and the staff of the Treasury for resisting departmental pressures to spend more money as revenue flooded in.

On last year's estimates the deficit before borrowing — and before the supplementary expenditure which amounted to about R700 million — was R2 227 million which the minister proposed meeting by borrowing R3 657 million, of which R1 430 million was to repay previous borrowings.

As things have turned out the R2 227 million deficit shrank to R340 million and net borrowing was about R1 548 million after repaying

maturing loans, which is R679 million less than had been anticipated.

The difference is the surplus of R1 208 million.

If inflation were not running at its present too-high rate and if the total money supply had not exploded to R16 217 million at the end of December, nearly 27 per cent above the previous year's figure, Mr Horwood might have made some telling handouts.

The gold bonanza which was largely responsible for the surplus looks like being a once-off for the next year or two and therefore should not be taken into account in normal year-on-year budgeting. — DDC.

DATE

8,86  
 32,93  
 32,69  
 19,08  
 33,34  
 1,25  
 1,08  
 17,47  
 15,18  
 10,71  
 16,65  
 14,39  
 17,11  
 1,20  
 13,04  
 17,86  
 12,57  
 1,23  
 14,71  
 15,68  
 19,30  
 2,64  
 2,02  
 7,22  
 5,13  
 0,31  
 9,61  
 1,16  
 0,49  
 4,75  
 9,96  
 9,78  
 8,62  
 1,91

**GOVERNMENT NOTICES**

**DEPARTMENT OF CO-OPERATION AND DEVELOPMENT**

No. 860 24 April 1981

**ABOLITION AND RE-ESTABLISHMENT OF TOWNSHIP COUNCILS FOR KAMAQHEKEZA, KAMHLUSHWA AND EKULINDENI — KANGWANI.**

I, George de Villiers Morrison, Deputy Minister of Co-operation, acting on behalf of and by direction of the Minister of Co-operation and Development under and by virtue of the powers vested in him by subregulations (3) and (4) of regulation 1 of Chapter 3 of the Regulation for the Administration and Control of Townships in Black Areas, published under Proclamation R. 293 of 1962, as amended, hereby:—

(a) abolish the township councils established by Government Notice R. 1760 of 1978 for Kamaqhekeza, Kamhlushwa and Ekulindeni, and

(b) re-establish, with effect from the first day of the month following the date of publication of this Government Notice, township councils for the three townships, Kamaqhekeza, Kamhlushwa and Ekulindeni.

G. DE V. MORRISON, Deputy Minister of Co-operation.  
 (Files T8/6/12/K87, K77 and E28)

**DEPARTMENT OF FINANCE**

No. 878 24 April 1981

**SOUTH AFRICAN RESERVE BANK ACT, 1944**

**DETERMINATION OF STATUTORY PRICE IN GOLD**

It is hereby notified that, in terms of section 17A (1) of the South African Reserve Bank Act, 1944 (Act 29 of 1944), the Minister of Finance has valued, as from 31 March 1981, all gold of the South African Reserve Bank at R381,18 per fine ounce of gold.

**DEPARTMENT OF FOREIGN AFFAIRS AND INFORMATION**

No. 899 24 April 1981

**PRESENTATION OF CREDENTIALS**

It is hereby notified that Mr P. H. Meyer was received by the President of the Commission of the European Communities and the President of the Council of Ministers of the European Communities in Brussels, Belgium, on 16 and 17 March 1981 respectively, on which occasions he presented his Letters of Credence as Ambassador Extraordinary and Plenipotentiary of the Republic of South Africa.

[12/107 (32)]

No. 900 24 April 1981

**PRESENTATION OF CREDENTIALS**

It is hereby notified that Mr W. R. Retief was received by the President of Austria on 26 March 1981 on which occasion he presented his Letter of Credence

**GOEWERMENSKENNISGEWINGS**

**DEPARTEMENT VAN SAMEWERKING EN ONTWIKKELING**

No. 860 24 April 1981

**AFSKAFING EN HIERINSTELLING VAN DORPSRADE VIR KAMAQHEKEZA, KAMHLUSHWA EN EKULINDENI — KANGWANI**

EK, George de Villiers Morrison, Adjunk-minister van Samewerking, handelende namens en in opdrag van die Minister van Samewerking en Ontwikkeling, kragtens die bevoegdheid hom verleen by subregulasies (3) en (4) van regulasie 1 van Hoofdstuk 3 van die Regulasies vir die Administrasie en Bestuur van Dorpe in Swart Gebiede, steekondie by Proklamasie R. 293 van 1962, soos gewys.

(a) skaf hierby die dorpsrade wat by Goewermentskennisgewing R. 1760 van 1978 vir Kamaqhekeza, Kamhlushwa en Ekulindeni ingestel is af; en

(b) stel hierby, met ingang van die eerste dag van die maand wat volg op die datum van afkondiging van hierdie Goewermentskennisgewing, dorpsrade vir genoemde drie dorpe Kamaqhekeza, Kamhlushwa en Ekulindeni, weer in.

G. DE V. MORRISON, Adjunk-minister van Samewerking.  
 (Lêers T8/6/12/K87, K77 en K28)

**DEPARTEMENT VAN FINANSIES**

No. 878 24 April 1981

**WET OP DIE SUID-AFRIKKAANSE RESERWEBANK, 1944**

**BEPALING VAN STATUTÊRE GOUDPRYS**

Hierby word bekendgemaak dat die Minister van Finansies kragtens artikel 17A (1) van die Wet op die Suid-Afrikaanse Reserwebank, 1944 (Wet 29 van 1944), alle pond van die Suid-Afrikaanse Reserwebank met ingang van 31 Maart 1981 teen R381,18 per ons suiwer goud gewaardeer het.

**DEPARTEMENT VAN BUITELANDSE SAKE EN INLIGTING**

No. 899 24 April 1981

**OORHANDIGING VAN GELOOFSBRIEF**

Hierby word bekendgemaak dat mnr. P. H. Meyer op onderskeidelik 16 en 17 Maart 1981 deur die President van die Kommissie van die Europese Gemeenskappe en die President van die Raad van Ministers van die Europese Gemeenskappe te Brussel, België, ontvang is en dat hy by daardie geleentheid sy Geloofsbriewe as Buitengewone en Gevolmagtigde Ambassadeur van die Republiek van Suid-Afrika oorhandig het.

[12/107 (32)]

No. 900 24 April 1981

**GELOOFSBRIEF OORHANDIGING**

Hierby word bekendgemaak dat mnr. W. R. Retief op 26 Maart 1981 deur die President van Oostenryk ontvang is en dat hy by daardie geleentheid sy Geloofsbrief as Buitengewone en Gevolmagtigde Ambassadeur

OF VAN 25

RDM 28/4/81  
**A case for \$600 gold**

By JOHN MULCAHY

ON fundamental inflation and currency bases the gold price should now be about \$600.

This is the view of the London Finance Monitor. It suggests that if one knows at any given time what the price of gold should be when related to inflation, rash buying or selling can be avoided.

A figure for gold has been calculated relating to the dollar and the pound, weighted against US, UK and other major countries' inflation rates, and at this stage is above \$600.

However, gold keeps pace with inflation over long-term cycles, and the figures cannot be expected to coincide on a yearly basis.

What should be kept in mind is the big influence the futures markets have on short-term gold-price determinations. Output of the South African mines in 1980 was 674 tons, yet in the same year on the US futures markets 11,000,000 contracts representing 34,400 tons of gold were traded.

In addition, says the Monitor, such is the state of the world that one can expect a few psychological triggers to come along this year, and it can be reasonably expected that gold will go up to \$750 or more this year.

While the gold price is largely determined by these fairly volatile psychological forces, the reality is that all it has done over the past 400 years is to keep pace with inflation.

The Monitor says that if one relates the gold price and the cost of living over those 400 years it can be seen that there were wide divergences before the indices come together. These swings provided opportunities for speculative gains, and

for the unwary investor spectacular losses.

Looking at platinum as an alternative, the Monitor says it has been hit by recession and demand from the motor and petrochemical industries, glass manufacturers and the jewellery trade.

However, with the US Government proposal to increase its stockpile by 200,000 ounces, equivalent to 1.5 months' production from Rustenburg and Impala, the outlook is brighter.

The long-term future is good, says the journal, and investors are likely to vie with traditional commercial producers once the platinum price starts to move up.

Silver is still bedevilled by the Hunt brothers, who have sold relatively little of the 63-million ounces of the silver they hold.

After the fiasco last year they were supposed to liquidate their holdings, but timing and conditions of the sale were left to them. Large sales, when they do come, will depress prices.

In addition, the US is intent on disposing of silver from its strategic stockpile, but on the credit side there are some important industrial uses being developed for silver. Long-term prospects are bright.

**SECTION II**  
**INCIDENCE (PRODUCTION) AND PREVALENCE OF SILICOSIS; COMPENSATION**  
 I would like to preface this section with a number of qualifications and to suggest some of its shortcomings. There is a vast quantity of unpublished and published primary source material pertaining to the disease on the period during which I am working for my theses, 1902 to 1925, and for this reason I have been reluctant, for this particular conference, to do later research, that is from 1930 to approximately 1978. However, although the terminal point of the detailed work in this section is approximately 1930, I have attempted to bring this study up to date by trying to show what the current incidence is.

2.  
 In fact, exist, future research in this field must be undertaken in perhaps less obvious sources and if possible in the records of the Witwatersrand Native Labour Association. Another defect in this paper is the lack of information thus far acquired on the use of radiology - so essential an aid for the diagnosis of the disease in living people in the earlier part of the paper. Dr M. Hurwitz has indicated that shortly after William Conrad Röntgen's discovery of roentgen rays (x-rays) on 8 November 1895, high quality plates exhibiting shadow and fine details were being produced. (2) In the mid 1890s x-rays were used by Italian and British doctors in soldiers wounded during various North African campaigns. (3) They were also used by the British during the Anglo-Boer war 1899 to 1902. (4) R. Ralston seems to have been one of the South African doctors to use x-ray equipment during the immediate post Anglo-Boer war period. (5) In the first decade of the 20th century, despite the difficulties of photographing lungs during respiration, modifications made to radiological equipment made it possible to obtain plates which early showed pinhead-sized tubercles. (6) The only other evidence that x-ray equipment was used on the Witwatersrand before 1916 (when it became part of routine usage by the newly

the material which I have investigated concerns the conditions on the mines and their relevance to white mineworkers, while the attitudes of trade unionists, mine management, the government and the medical profession relates also to white and other mineworkers rather than to the non-white labour force, the vast majority of whom were Africans. This may be because the obvious sources so far consulted reflect this bias. Although only a limited amount of material on the relationship of black, coloured and Asian mineworkers to the disease may, ground mining techniques and in the use of protective or

his Medical Bureau in addition to diagnoses of silicosis and tuberculosis), Andrew Watt. He stated that by 1911 had purchased three newer and improved earlier equipment) and that these had been enquiring into the prevalence of monary tuberculosis on mines in South Africa to as the Medical Commission of 1920s which provided an even more definitive aid in diagnoses of these diseases. (9) Doctors were thus able to detect the presence of disease, and at far earlier stages, whereas before this the early symptoms had been undiscovered and the disease, silicosis, could not be diagnosed. (10)

In order to assess whether the incidence and prevalence of silicosis is declining it is necessary to examine whether there were improvements in dust suppression particularly in underground mining techniques and in the use of protective or

TOM WOLFE

(79) FM 1/5/81

# A positive view on gold



Tom Wolfe, one of America's more authoritative commentators on gold, was in SA this week for talks with the Reserve Bank and the mining industry. Wolfe was formerly director of the US

Treasury's Office of Gold & Silver and now publishes the *Wolfe Wire* and the *Gold & Money Markets Analyst* newsletter. Here are his answers to the *FM*'s questions on gold and the US economy.

**FM:** What do you see as the major growth markets for gold?

**Wolfe:** Largely in the investment sector. The potential for increased investment in the US and other major Western economies is very large. Last year, for example, the increase in monetary assets held by individuals in the US was greater than \$300 billion. In contrast, the increase in gold held by individuals was less than \$3 billion. Institutional investors have yet to invest to a significant extent in gold. Institutions will almost certainly enter the market. Were they to invest only 1% of their total annual asset increase in gold, it would double US demand. US personal investment in gold is among the largest in the world and averages close to 200 t a year in coin and bullion. If institutional buying starts in the US, European institutions could quickly follow suit.

**Do you think central banks will continue to be net buyers of gold?**

Yes. Last year net purchases exceeded 6m oz, or roughly 20% of the gold

that came onto the world market. This is a significant trend. I expect no offsetting sales by monetary authorities.

**Is the US defence build-up bullish for gold?**

Yes. In the early Seventies, US industrial consumption was about 7m oz a year, largely because the defence and space programmes were in high gear. In 1980, the figure was down to about 4m oz. The defence build-up alone could add 50 t to the US's annual consumption by 1983. And if the politically popular space programme builds up, consumption will be boosted further. Higher defence spending is already cranked into the budget — a larger space programme isn't. So if it expands, the budget deficit could widen — again leading to fears of high inflation.

**What could go wrong with the US administration's anti-inflation policies?**

Anti-inflation policies are based on a sharp cut-back in government spending and encouragement of the Fed to maintain a very modest growth in money supply. However, the administration also advocates across the board, multi-year cuts in personal tax rates, which could average \$50 billion over the next three years. The US budget is already in very large deficit — probably \$60 billion this year. If the tax cuts are agreed by Congress and budget spending cuts are offset by higher defence expenditure, there are fears that large deficits could mean a continuation of high interest and inflation rates.

**Do you think the Reagan administration can maintain high interest rates if the US economy experiences a strong downturn?**

Neither the administration nor the Federal Reserve wants to retain high interest rates longer than is absolutely necessary to restrain a level of inflation that is considered excessive. There is a difference in objectives, however, in sanctioning the recent high levels of interest rates. The administration believes in maintaining high interest rates only under conditions in which the money supply is growing at a higher rate than is considered desirable over the long run. The Fed takes the more conventional view that high interest rates are necessary to restrain undue expansion of credit at a time when inflation is already considered too high and the economy is operating at a relatively high growth rate.

The US economy has been growing for the past three quarters and none of the US authorities believes high interest rates can create any near-term economic problems.

**Do US futures markets have a destabilising influence on gold?**

They add to price volatility in the short term, but there is no clear evidence that they cause substantially higher or lower prices in the longer term. If anything, they may support gold prices as they open investment in gold to a wider range of people.

I do not believe South African producers should hedge in futures markets to any large extent. If large forward sales by South Africans were recorded, other operators could construe it as a fear that gold prices were soon to fall — rather as insider selling of a company's shares signals poor results. This would work to the disadvantage of producers.

# Bull points for languishing gold

RDM  
11/5/81  
79

By NEIL BEHRMANN  
LONDON. — Most dealers in Switzerland, London, Frankfurt and New York believe that the gold price is beginning to bottom out.

Their confidence stems from gold's remarkable resilience in the face of the sharp increase in interest rates and the strong dollar.

Out of 11 dealers canvassed only three were neutral to bearish. The others believed the price had found a bottom, or was near the low point. Only two forecast a price of more than \$550 this year.

Most dealers predict a sideways trend, with gold rising or falling 5% to 10% from current levels, indicating a range of \$460 to \$540.

London bullion broker Sharpes Pixley said it was encouraged "by the support that may exist below \$480", but it was difficult to be inspired by near-term prospects.

"A range of \$470 to \$500 appears the most likely, particularly if the dull conditions continue," it said.

With most bullion dealers perceiving similar trends it could be a good time to discuss the economic fundamentals which are affecting bullion and foreign exchange markets.

The Reagan Administration and the Federal Reserve Bank are determined to squeeze inflation out of the system, a la Thatcher.

These measures take time, as shown by UK interest rates which have remained high for nearly two years.

Interest rates can dip for technical reasons. But it would be premature for anyone to misinterpret the moves and forecast a change in policy from deflation to reflation.

Interest-rate fluctuations are likely to reflect the Fed's attempts to smooth out the money supply. When rates dip slightly gold may rally, but the price could falter again when the market finds that the Fed continues to maintain an overall policy of slower monetary growth.

Interest rates of 20% on short-term and one-year money cannot be regarded as bullish for gold. From current prices, gold must rise to \$575 before an investor breaks even. Even if US interest rates decline to 15%, gold will remain an unexciting alternative investment.

The average European and US investor is thus ignoring gold. Speculative interest is minimal. There were small purchases ahead of the French election on fears of a socialist victory.

High interest rates and prospects of a recovery in the Unit-

ed States cannot be regarded as a sign that the jewellery industry will boom.

Gold demand from the US and Europe has been weak in the past few months, and the gold market is quiet. Normally, a quiet market is a bearish sign. With little demand forthcoming and continual supplies from the producers, prices tend to slip and then fall sharply.

So far, however, this has not occurred. The main reason appears to be fairly strong demand from the Middle East and Far East. London brokers report that the Far East has been buying small bars because people believe they should hold some gold.

Demand has come from Japan, Taiwan and other South-East Asian countries.

United States, Swiss and German dealers report solid buying from large Middle Eastern institutions. Saudi Arabian

sheikhs are said to be buying gold through a New York commodities firm.

Swiss bullion dealers say there have been good orders and buying has absorbed producer supplies easily.

Some dealers believe that the wealthy Middle Eastern investors and central banks are buying as a defensive measure.

Mr Thomas Holt, director of the Holt investment advisory service, says Arabs are buying gold to protect themselves from intermittent banking collapses. He maintains that the world is in the first stages of a deflationary spiral. Heavily indebted banks could fail and that is why wealthy investors are buying gold — a mobile asset.

This year's gold supplies, including dishoarding, could be about 38-million ounces. Jewellery and coin demand is estimated at 30-million ounces, leaving a surplus of 8-million

ounces valued at \$3 800-million at current prices. This surplus must be absorbed by central banks and private investors.

Considering that interest payments of Opec surpluses could be \$15 000-million to \$20 000-million this year. It is not surprising that the gold surplus can easily be absorbed.

By the same token, if jewellery demand remains low and other foreign investors continue to shy away from gold, it is possible that the price could stagnate in quiet trading for a long time.

In these circumstances it would pay the mines to hedge by selling gold on the futures market to take advantage of any rally.

If one is talking of an average gold price of \$500, gold-share prices are already discounting any short-term gold-price increase.



# The mines a falling gold price hurts most

By JOHN MULCAHY  
Mining Editor

A SUSTAINED gold price below \$500 would have severe consequences for several gold mines, and a drop to \$450 would place at least three producers in a loss situation.

The gold price has for some time been fluctuating below \$500, and although the average for the year to date is about \$520, there is a strong belief that the bottom is still much to the south.

Rand Merchant Bank economist Mr Louis Kruger said recently that the average for the year would be \$430, which would require a sustained fall to well below \$400.

There are opinions which contend that there are enough economic and political pressures to push up the gold price so that the average for this year is between \$500 and \$550 an ounce.

While there are no detailed figures available on uranium, there are negative indications for the short and medium term. Potential annual world output is estimated at 80 000 tons by 1985, and offtake is not expected to exceed 57 000 tons by that time.

West Rand Cons, which is

essentially a uranium producer, with gold as a by-product, can expect earnings of about 100c a share at a gold price of \$500, but if the average falls to \$450 the earnings potential disappears.

It is not surprising that the mine has been receiving State aid since the last quarter of 1980. WR Cons break even point for gold is more than \$900 an ounce, and even when uranium costs are reduced from those of gold, the break-even is about \$540, well above both the present price and the average for the year.

Nine gold or gold/uranium producers are eligible for State aid of which five are either receiving assistance or have applied for it.

West Rand Cons, Lorame and Wit Nigel are receiving aid, and Durban Deep and ERPM applied for it in the March quarter. The other producers which qualify for aid are ET Cons, Leslie, Stilfontein and Venterspost.

Loosely, a mine qualifies for State aid if -- in terms of a formula which takes into account the mining lease, ore reserves and capital expenditure -- the Government Mining Engineer is satisfied that in the absence of assistance a mine's

life could be reduced to less than eight years, and assistance would have the effect of prolonging the life.

The aid is given by way of a reduction of the tax charge in the case of producers liable for tax, or by direct capital injection. It is regarded as a grant and is not repayable.

Producers with no possibility of extending their lives beyond eight years do not under any circumstances qualify for State aid, and producers in this category include Bracken, Marievale, Elsburg and Free State Saaiplaas -- assuming there was to be no merger with Western Holdings and Welkom.

Taking the downside extreme of the gold price potential -- an average of \$400 -- the first of the remaining mines eligible for State aid likely to apply for assistance would probably be Venterspost. For the March quarter Venters costs, expressed in dollars an ounce, rose to \$396 and costs of stores and labour are rising all the time.

It is doubtful whether the Government Mining Engineer would accept the Middelvetri development in the assistance calculation, and this is seen as a possible reason for Venters soft-peddling in the area.

Leslie would probably not require State aid at a gold price of more than \$350, at least in the short term. Costs for the March quarter were \$313 an ounce of gold produced, and Union Corp's ability to contain cost increases is renowned.

Although Stilfontein has an element of uranium in its earnings structure, the mine is in a healthy state, and the break-even point for the March quarter was \$256.

It also has the prospect of loan returns from 85% subsidiary Chemwes, and the mine is expected to move into the Ventersdorp Contact Reel to a limited degree soon. This should add to its viability.

ET Cons is the least likely of the four "eligibles" to resort to State aid. It has a strong balance sheet and one only needs to look at the previously difficult period of 1974 to 1976, when the mine managed to continue operating without assistance.

Of the mines which have high cost elements, Elandsrand at \$473 and Deelkraal at \$410 are both new producers, with the problems regarded as temporary.

Marievale (\$354), Western Areas (\$388.50) and Free State Saaiplaas with costs of \$506 an ounce, would not be regarded as viable for more than eight years by the GME.

274  
79

# French trade link believed to be safe

**By Charlene Beltramo**  
It is doubtful whether France could cut trading links with South Africa even if it wanted to — it is among South Africa's top five trading partners for both imports and exports, according to the Department of Customs and Excise and Safto.

The election of a socialist government in France, experts contend, will not necessarily have an adverse effect on trade links although all are watching the situation carefully.

According to the Department of Customs and Excise, exports to France from January to December last year amounted to R407 148 414; of which the heaviest slice consisted of minerals such as coal and uranium — a total of R275,1-million.

Imports were substantially less, amounting to a total of R54 829 971 in the same period and consisting mainly of machinery, mechanical appliances and electrical equipment and parts.

## TEXTILES

Other exports from South Africa to France included R29,1-million in the form of textiles and metals and articles made textile articles; base of base metals — R14-million; live animals and animal products — R6,6-million and vegetable products — R5,9-million.

Sapa-Reuter reports from Paris that President-elect Francois Mitterrand wants to nationalise 11 companies under his programme of socialist measures.

They are: aircraft maker Dassault-Breguet SA; chemical giants Rhone-Poulenc SA and Roussel-Uclaf SA; electronics firms Compagnie Generale D'Electricite and Thomson-Brandt SA; telecommunications company ITT-France SA; engineers and steelmakers Pechiney-Ugine-Kuhlmann

SA, Usinor and Sacilor; the computer company CII-Honeywell Bull and the glass construction and electronics conglomerate St Gobain Pont-a-Mousson SA.

## TURNOVER

Their total annual turnover is more than R32 000-million.

The socialist programme calls for nationalising parent companies 100 percent and taking over partially-owned subsidiaries if their activities are "of strategic importance to the economy."

● Page 23: Mitterrand's big headache.

# \$706 is gold's correct price — analyst

RDM 13/5/87  
79

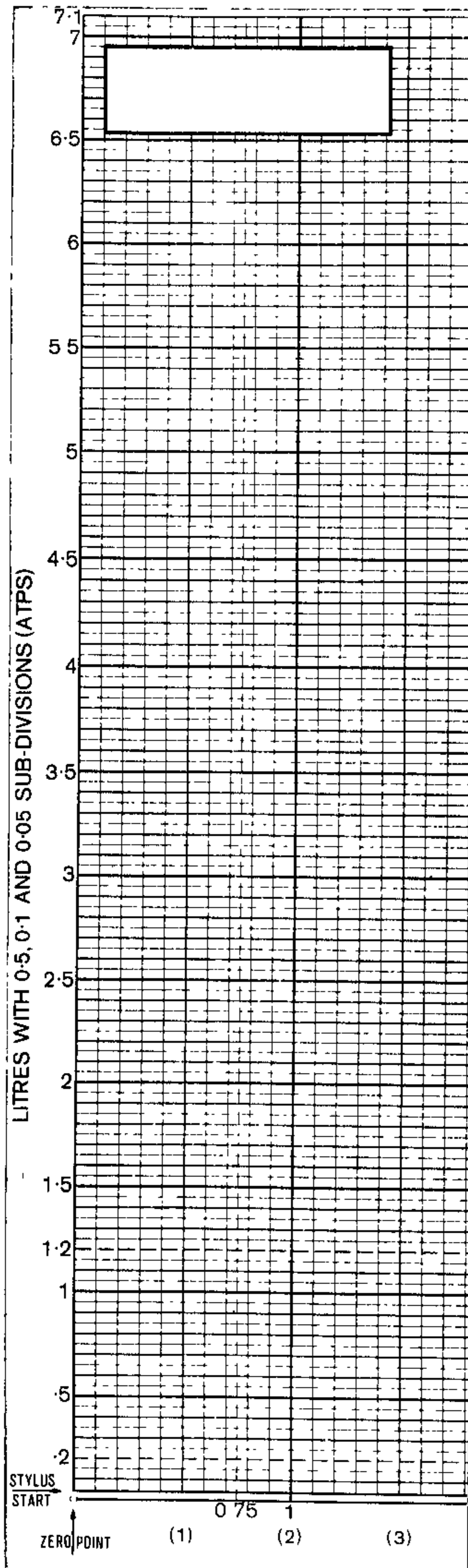

By JOHN MULCAHY

BASED on the gold-to-oil price ratio since 1950, which shows that on average 1 oz of gold bought 22 barrels of oil, and using the Saudi Arabian price of \$32 a barrel, the "right" price for gold at the moment should be \$704 an ounce.

Mr Reginald Eccles, joint editor of Metals Analysis and Outlook, said in a paper on the Long-Term Prospects for Gold at the metals and minerals conference in Johannesburg yesterday the rise in the gold price in recent times had gone some way to restoring the ratio of gold to foreign currency reserves in industrialised countries.

But this had overlooked the oil exporters, the most important accumulator of foreign reserves recently.

While the oil exporting bloc had significantly increased its share of foreign currency reserves over the past few years, it was a disproportionately small holder of gold.

Industrialised countries now held 69% of their reserves in gold, while oil exporters held a mere 21%.

With accumulated cash surpluses of \$400 000-million at the end of 1980 the consequences to the gold market of a move by Opec members to emulate the percentage gold holdings of their industrialised counterparts was obvious — at current prices the Opec cash surplus equated 26 years of the Western world's mine production.

Mr Eccles said he believed gold had possibly entered a final phase, in that it could lead to official recognition for gold's stabilising role within the international monetary system.

"In fact, to an extent, this international remonetisation has been in progress for some time. Gold has been mobilised as collateral for loans usually referred to as gold swaps, many countries now value their gold reserves at market-related prices, and gold forms an integral part of the European Monetary System."

All the evidence pointed to a growing recognition of gold as the ultimate store of value in the domestic and international arena, said Mr Eccles, and unless it was assumed that the financial and political uncertainty which had given rise to the process was about to wane the trend would continue.

In spite of governments' efforts to reduce the rate of inflation and the fact that the dollar had strengthened in recent months, Mr Eccles said he was not prepared to bet that the world was now entering a more stable period.

Decelerating inflation and the strengthening dollar were entirely consistent with the current phase of the business cycle, and it was doubtful whether either of these trends would continue once the next economic upswing was well underway.

There was likely to be a continued private sector institutionalisation of the gold market, a recovery in the commercial demand for gold

and accelerating interest on the part of monetary authorities.

Mr Eccles added that he was inevitably drawn to the conclusion that not only would the gold price recover from its recent decline, if not this year then certainly in 1982, but further that the long-term health of the metal was assured.

"One day perhaps we will return to a world of relative financial stability and quite possibly a maintained price for gold. That day, however, is far distant and in my opinion will require a gold price considerably higher than the current level."

\*\*\*\*\*

Mr Trevor Tarring, managing director of Metal Bulletin, co-organisers of the conference with Metals & Minerals Research Services, in a paper on futures markets and hedging, said the process of hedging was an operation on a futures market, deliberately undertaken, to be a mirror image of a position necessarily incurred in a physical commodity.

By way of explanation Mr Tarring referred to "perhaps the most shining example of a successful hedging operation which overcame more or less maximal geographical separation between the hedger and the futures market".

Mount Lyell, an Australian copper producer in the Goldfields group, undertook some hedging operations through the Goldfields Metal Exchange, dealing company, Tennant Trading Metals.

The operation was started with copper prices at historically high levels, and the object of the hedging was to lock these in, in advance, so that when the downturn came — as it inevitably did — the company's realised price was heavily lagging the downturn in the market.

He said there was no doubt that the greatest skill in hedging was required in deciding when and how to vary a basic hedging strategy.

"I would agree entirely with any salesman preaching the gospel of the use of futures markets, that the company which does not make use of hedging where it has a good reason and adequate facility to do so, is in fact deliberately gambling with the value of that company's stocks, and ultimately with its shareholders' funds."

On the other hand a hedging programme set up to meet a particular market circumstance and then pursued woodenly without reference to change in those market circumstances, was every bit as irresponsible as to refuse to consider hedging.

Mr Rod Holness, managing director of Commodity Brokers, said there had been substantial progress in the understanding and handling of all matters relating to futures trading in South Africa, and there was likely to be considerable expansion in the use of futures by local companies.

The major task in attempting to increase the use of futures

trading in South Africa was educating the private and public sector in the value of hedging.

\*\*\*\*\*

Mr Ian Greig, former chairman of Impala Platinum, said he believed the 80s would see a further worthwhile growth in world demand for platinum, though this was unlikely to be on the scale of the last decade.

He said the major growth areas would probably be in catalytic converters for the European automobile industry, once the present recession was past and there was more awareness of the health hazards of uncontrolled automobile emissions.

Other areas of growth were likely to be demand for platinum for fuel cells, though this development had been disappointingly slow in getting off the ground, purchases of platinum for the US Defence Materials Inventories, which showed a shortfall of 857 000 oz, and a steady though not spectacular improvement in demand for jewellery in Europe, where promotional efforts by the Platinum Guild and by Impala were beginning to bear fruit.

Mr Greig said it was more difficult to be specific about the outlook for platinum supplies and given an assurance of increased demand any of the three existing SA/Bophutha-Tswana producers, which at present accounted for nearly 75% of free world supply, could further increase production.

It had been argued that the producers were "giving away" money through adhering to the producer price, said Mr Greig, and that this price should be abolished, and producers ride on the ups and downs on prices on the proposed central market, just as gold producers and certain other metal miners did.

It would be difficult to achieve a fundamental change quickly and without further fragmentation of the market in the interim phase.

"I doubt if many consumers or fabricators with producer price contracts would rush to convert these to free-market related contracts," said Mr Greig.

The automobile industry would certainly not put itself at the mercy of such a market, and probably would never have followed the catalytic converter route if this had been the pricing formula for platinum.

LITRES WITH SUB-DIVISIONS (BTPS) @ 20°C (AWI) (1987)

F 18686

No 1031

15 May 1981

SOUTH AFRICAN RESERVE BANK ACT, 1944

## DETERMINATION OF STATUTORY PRICE IN GOLD

It is hereby notified that, in terms of section 17A (1) of the South African Reserve Bank Act, 1944 (Act 29 of 1944), the Minister of Finance has valued, as from 30 April 1981, all gold of the South African Reserve Bank at R357.21 per fine ounce of gold.

No 1031

15 Mei 1981

WET OP DIE SUID-AFRIKAANSE RESERVEBANK,  
1944

## BEPALING VAN STATUTÊRE GOUDPRYS

Hierby word bekendgemaak dat die Minister van Finansies kragtens artikel 17A (1) van die Wet op die Suid-Afrikaanse Reservebank, 1944 (Wet 29 van 1944), alle goud van die Suid-Afrikaanse Reservebank met ingang van 30 April 1981 teen R357.21 per ons suwer goud gewaardeer het.

ROM 15/5/81

# Lion's share for State

Mining Editor

THE greatest beneficiary of the rising gold price and the good fortunes of the SA gold-mining industry has been the State.

Gold 1981 says receipts from tax and lease payments from the gold mines rose from about R114-million in 1970 to R1 700-million in 1979, and were an

estimated R3 838-million in 1980.

The exceptional rate of increase is due to the operation of the formula for tax and lease payments which applies only to gold mines.

The estimated revenue the State received from gold mines in 1980 was almost double the

amount budgeted for by the Minister of Finance for 1980-81.

The proportion of gold-mining profits received from tax and State's share of profits increased from 37% in 1977 to 52% in 1980. The proportionate share of profits paid in dividends remained about 27% in recent years, but increased to 31% in 1980.

# South Africa's gold sales policy examined

CT 15/5/81 79

JOHANNESBURG. — South Africa, as the world's main producer of gold, is expected to adopt a sales policy which balances international responsibility and an acceptable degree of self-interest.

Consolidated Gold Fields says in its "Gold 1981" review of the gold markets that international responsibility is met by SA supplying gold regularly to the markets and keeping the world informed about the progress and future prospects of its mining industry.

An acceptable degree of self-interest involves attempts to reduce the volatility of the gold price and SA has been developing some expertise in this area, says Cons Gold.

"In the mid 1970s, when the gold price was weak after its fall from \$197 an ounce, SA urgently needed foreign exchange and direct sales at that time would have weakened the price further and exacerbated the foreign exchange problem."

## Gold swaps

The solution was found by "swapping" gold for foreign exchange and the terms of the exchange enabled SA to have the first option to buy the gold back at the swap price plus interest.

Changed circumstances and higher gold prices in 1979 made it advantageous for SA to exercise this option, with 70 tons sold on private markets and 8 tons added to official reserves.

In 1980, a total of 25 tons of swap gold were repurchased and went into official reserves which, according to IMF statistics, rose by 66 tons.

In 1980 it is estimated that the non-communist private sector increased its gold holding by 803 tons and inflows of gold came from new mine production of 943 tons and net sales from the communist sector of 90 tons, but there was a net outflow of 230 tons to the official sector.

This latter was an outstanding feature of 1980, being a reversal of the flow of gold which had occurred in each year from 1973 to 1979, from the official

sector to the private sector. The net purchases of 230 tons in 1980 compares with net sales of 544 tons in 1979.

## US supplies

The United States supplied only 11 tons of gold to the private sector in 1980, and this was transferred from the reserves to the medallion programme. It is planned to release 1 000 000 oz of gold a year in medallion form, though last year sales did not meet production and the gold bear market, together with cumbersome marketing methods, have been blamed as the chief reasons for the modest sales performance.

The principal focus of attention in gold market circles has not, however, been on medallion sales, but with the future gold policy of the US in relation to its reserves of 8 221 tons, which make up 23% of the total holdings of the official sector.

It is becoming increasingly difficult to imagine the logical basis for a resumption of US Treasury sales when good selling opportunities have been ignored during the past 17 months — also, one of the effects of the auctions in the past has been to depress the price and lay the foundations for an explosive upward movement.

## Holdings fall

US gold holdings have fallen substantially since the 1952 peak level of 21 000 tons, and the current holdings are now lower than the reserves of the European Economic Community, although they are still more than double the gold reserves of West Germany, which is second in the international league.

For 1981, Cons Gold says it does not expect any dramatic changes in mine production. Initial thoughts favour an increase in net sales from the communist sector because the Polish situation and poor grain harvests may require additional foreign exchange.

This foreign exchange is unlikely to be obtained by the modest increases which are ex-

pected in revenues from Soviet oil and gas exports, and any net purchases by the official sector will mean that supplies of gold to the private sector will continue to be limited.

The main feature of non-communist world mine production last year was the fall in production in countries with established gold mining operations because they were able to mine lower grade ores.

High gold prices in the second half of 1979 and for long periods in 1980 caused many companies to look again at areas which had previously been considered uneconomic or where mining had been suspended when the price was lower.

Cons Gold says it is currently making a survey of these prospects with the objective of isolating those which are likely to complete the route to profitable production.

Apart from Brazil and Ghana, where ambitious production possibilities have been mentioned, the output from each of these projects is not large, and the total of those which survive is unlikely to make up for the decline expected in SA production towards the end of the decade.

In 1981 Cons Gold expects a major improvement in the private sector holdings of carat jewellery, as disharding has stopped and there is some evidence that gold supplies to the jewellery manufacturing industry are increasing.

It is estimated that in 1980 the private sector increased its holding of carat jewellery by 120 tons — an increase of 270 tons by the developed countries and a reduction in developing countries' holdings of 150 tons — representing a significant slowing down from the 737 tons increase in 1979 and the addition of 1 007 tons in 1978.

The use of gold in the manufacture of electronic components was 81 tons in 1980, down 14% from the 94 tons used in 1979. A relatively flat trend is predicted for 1981, but if the US economy picks up strongly later in the year there may be a small increase of around 5%.

Most gold-using firms project little change in their gold use in 1981 over 1980 levels, and the few firms that did so were basing their forecast on the marketing of new products. On the other hand, technological substitution of gold will tend to

continue.

The use of gold in dental applications fell last year to 62 tons from 86 tons in 1979, and the dominant users, West Germany and the US, are again expected to reduce their requirements.

In West Germany the insurance authorities may soon insist on a lower gold content in dental alloys, while forecasts for gold use in dentistry for this year in the US are not optimistic, and further reductions amounting to 15% to 20% of the 1980 level of 13.8 tons are anticipated.

# Bull market still out of sight

RDM  
15/5/81

79

By JOHN MULCAHY

IT is not yet clear if the 15-month gold bear market is over, but its end will be signalled by a vigorous recovery in physical offtake by long-term investors, both private and official, and for fabrication by jewellery and industrial manufacturers.

Gold 1981, compiled by Mr David Potts, Consolidated Gold Fields chief gold analyst, says there is no guarantee of a rapid reversal of the price trend and an immediate start of a new bull market because the last bear market took 20 months to reach its base in August 1976, and it was three more months before there was a return to exciting upward movements.

There have been some signs in recent months of an increase in physical offtake in the Far East as a result of the "green card" proposal in Japan and return of investment interest in Indonesia.

The base of the bear market will provide some evidence of the extent to which there has

been an increase in gold investment by large financial institutions, individual investors and central banks, says the report, and the price will be crucial to the rate of development of the gold market in the 1980s.

"Long-term institutional investors with the responsibility to protect large funds from depreciation by inflation can only be expected to accept the problems of a volatile gold market if there is a prize in the form of a strong rising trend."

The new base will give an important indication of the trend as the statisticians' calculations will reveal how average gold prices compare with other investments in providing protection against inflation over the past decade.

If the net result is that the confidence of central banks and major private financial institutions is gained, they are likely to begin buying gold on a regular basis to build up a core holding.

As more confidence develops, part of the holding could

be traded to take advantage of market swings — selling towards the top of the market and rebuilding holdings during price falls could make a significant contribution to reducing extreme price fluctuations.

However, if the price drops to such a low level that the necessary impetus to increased involvement in the gold market is not achieved, the recovery process will be delayed, and it will require a large upward movement to generate the required conviction.

"It is somewhat ironic that we may have to witness another severe disruption of the gold market with possible detrimental effects on currencies and trade before the organisations which have the combined power to smooth the fluctuations have the confidence to commit themselves to the gold market."

# SA gold policy —

By JOHN MULCAHY

SOUTH AFRICA, as the world's main producer of gold, is expected to adopt a sales policy which balances international responsibility and an acceptable degree of self-interest.

Consolidated Gold Fields says in its Gold 1981 review that international responsibility is met by SA supplying gold regularly to the markets and keeping the world informed about the progress and prospects of its mining industry.

An acceptable degree of self-interest involves attempts to reduce the volatility of the gold price and SA has been developing some expertise in this area, says Cons Gold.

"In the mid-1970s, when the gold price was weak after its fall from \$197, SA urgently needed foreign exchange and direct sales at that time would have weakened the price further and exacerbated the foreign exchange problem."

The solution was found by swapping gold for foreign exchange and the terms of the exchange enabled SA to have the first option to buy the gold back at the swap price plus interest.

Changed circumstances and higher gold prices in 1979 made it advantageous for SA to exercise this option, with 70 tons sold on private markets and eight tons added to official reserves. Last year, 25 tons of swap gold was repurchased and went into official reserves, which according to IMF statistics rose by 66 tons.

It is estimated that the non-communist private sector increased its gold holding by 803 tons last year. Inflows of gold came from new mine production of 943 tons and net sales from the communist sector of 90 tons, but there was a net outflow of 230 tons to the official sector.

This official buying was an outstanding feature of 1980, being a reversal of the flow of gold which occurred each year from 1973 to 1979 from the official sector to the private sector. The net official purchase of 230 tons in 1980 compares with net sales of 544 tons in 1979.

# responsible self-interest

The US supplied only 11 tons of gold to the private sector in 1980, and this was transferred from the reserves to the medalion programme. The US plans to release 1-million oz of gold a year in medalion form, although last year sales did not meet production and the gold bear market together with cumbersome marketing methods have been blamed as the chief reasons for the modest sales performance.

The principal focus of attention in gold markets has not been on medalion sales, but with the gold policy of the US in relation to its reserves of 8 221 tons, which make up 23% of the total holdings of the official sector.

It is becoming increasingly difficult to imagine the logical basis for a resumption of US Treasury sales when good selling opportunities have been ignored in the past 17 months. One of the effects of the auctions has been to depress the price and lay the foundations for an explosive upward movement.

US gold holdings have fallen substantially since the 1952 peak of 21 099 tons, and current holdings are lower than the reserves of the European Economic Community, although they are still more than double the gold reserves of West Germany, which is second in the international league.

Cons Gold does not expect any dramatic changes in mine production this year. Initial thoughts favour an increase in net sales from the communist sector because the Polish situation and poor Eastern grain harvests may require additional foreign exchange.

This foreign exchange is unlikely to be obtained by the modest increases which are expected in revenues from Soviet oil and gas exports, and any net purchases by the official sector will mean that supplies of gold to the private sector will continue to be limited.

The main feature of non-communist world mine production last year was the fall in production in countries with established gold mines because

they were able to mine lower-grade ores.

High gold prices in the second half of 1979 and for long spells in 1980 caused many mining companies to look again at areas which had previously been considered uneconomic or where mining had been suspended when the price was lower.

Cons Gold says it is making a survey of these prospects with the objective of isolating those which are likely to complete the route to profitable production.

Apart from Brazil and Ghana, where ambitious production possibilities have been mentioned, the output from each of these projects is not large, and the total of those which survive is unlikely to make up for the decline expected in SA production towards the end of the decade.

CONS Gold expects a major improvement in private holdings of carat jewellery this year as discarding has stopped and there is some evidence that gold supplies to the jewellery manufacturing industry are increasing.

It is estimated that in 1980 the private sector increased its holding of carat jewellery by 120 tons — an increase of 2/3

tons by the developed countries and a reduction in developing countries' holdings of 150 tons — representing a significant slowing down from the 2.7 tons increase in 1979 and the addition of 1 007 tons in 1978.

The use of gold in the manufacture of electronic components took 81 tons in 1980, down 14% from the 94 tons used in 1979. A relatively flat trend is predicted for 1981, but if the US economy picks up strongly later in the year there may be an increase of 5%.

Most firms project little change in their gold use in 1981 over 1980 levels, and the few firms that did so based their forecast on the marketing of new products. On the other hand, technological substitution of gold will tend to continue.

The use of gold in dental applications fell last year to 62 tons from 66 tons in 1979, and the dominant users, West Germany and the US, are again expected to reduce their requirements.

In West Germany the insurance companies may soon insist on a lower gold content in dental alloys, and forecasts for gold use in dentistry for this year in the US are not optimistic. Further reductions amounting to 15% to 20% of the 1980 level of 13.8 tons are expected.

RDM  
15/5/81  
79



ORDER FORM

For publications obtainable from the Centre for Intergroup Studies, c/o University of Cape Town, Rondebosch, Republic of South Africa, 7700

Name and Address: .....

For publications obtainable from the Centre for Intergroup Studies, c/o University of Cape Town, Rondebosch, Republic of South Africa, 7700

Name and Address: .....

# Hopes for drop in State gold rake-off

RD.4  
19/5/81  
204  
79

By JOHN MULCAHY

THE proportion of gold-mining profits taken by the State may be reduced because of the Government's often-stated position that it will encourage the private sector to play a greater role in new capital development.

The president of the Chamber of Mines, Mr Bill Lawrence, told the World Gold Markets 1981-82 conference in London yesterday that such a tax reduction would encourage new capital investment in gold mining.

In addition, the higher distributable profits realised by the mines and their shareholders would have a significant multiplier effect on the SA economy by increasing the amount of capital in the private sector available for reinvestment.

Value added to the economy by gold mining in 1970 accounted for about 8% of GDP. In 1980, direct value added by mining contributed an estimated 17% of GDP.

Allowing for the indirect effects arising from spending in mining affecting other areas of the economy, the multiplier effect, Mr Lawrence said it was estimated that last year about 26% of total expenditure on GDP was generated by the gold-mining industry.

The shortage of skilled manpower would, if it persisted, undoubtedly act as a brake on expansion plans. Mr Dennis Etheredge, the previous chamber president, said last year there was a shortfall of 1 600 skilled personnel on the chamber's member mines, equivalent to the entire complement of skilled workers required to man two medium-sized gold mines employing 20 000 people.

Mr Lawrence said this problem had not been alleviated to any significant extent.

He believed the next decade would be marked by a return to a greater degree of stability in world economic systems and financial markets.

However, fluctuations related to economic cycles would continue and currency parities would react to differing rates of inflation or balance of payments positions in the world's trading nations.

Inflation might be reduced, but would certainly not disappear. Rapid changes in interest

rates, equity values and political instability would still cause short-term surges of money into and out of investment assets, including gold.

Three factors would be of prime importance in determining the performance of the gold price over the next 10 years, said Mr Lawrence.

Industrial demand, which in eight out of the past 11 years accounted for 85% or more of total gold consumed, should stage a revival from current low levels as a general economic recovery gets under way in the near future.

Purchases of gold jewellery continued to increase steadily in nominal terms over the past decade and this type of increase could still be expected.

However, the sharp rise in the gold price had reduced the physical volume of gold consumed in jewellery, and a full revival of gold jewellery demand to its previous levels of about 1 000 tons a year could probably be expected only when the rate of increase in real disposable incomes on a world-wide basis equalled or exceeded the rate of increase in the gold price.

The current renationalisation of gold reserves would continue to be a feature of the system in the years ahead, said Mr Lawrence. Central banks would add to their gold reserves if and when feasible and gold collateral transactions would become more commonplace.

"I would not be surprised to see the re-emergence of an inter-central bank market for gold, enabling countries in balance of payments difficulties to utilise their gold reserves as collateral or for currency swaps without affecting the free-market price of gold."

Signature: .....  
for R .....  
by Professor J Degenaar  
Annual Report. Available in  
..... (gratis)

17 Groenewald, Sosiale Assisand by Afrikaans-Sprekendes:  
Verdere Toeligting met 'n Steekproef van Studente.  
18 Van der Horst, Women as an Economic Force in Southern Africa.

17 Groenewald, Sosiale Assisand by Afrikaans-Sprekendes:  
Verdere Toeligting met 'n Steekproef van Studente.  
18 Van der Horst, Women as an Economic Force in Southern Africa.

PLEASE CIRCLE ITEMS REQUIRED

PLEASE CIRCLE ITEMS REQUIRED

# Horwood urges dollar link for gold

20/5/81 KDM  
79

By JOHN MULCAHY

THE plea by South Africa for a reappraisal of the monetary role of gold can no longer be dismissed as simply a ruse to give gold producers a higher price for their product than they would otherwise have obtained.

The Minister of Finance, Mr Horwood told the conference on World Gold Markets 1981-82 in London yesterday that in the gold debate of 10 to 15 years ago when the issue was whether the official price should be raised, SA spokesmen were suspected of engaging in special pleading on behalf of a large gold-producing country.

This was no longer the case as SA gold mines could hardly have done better than they had under the unsettled world political economic conditions of recent years.

SA producers would continue to benefit from an upward long-term trend in the gold price, and it could be argued that the re-establishment of a formal link between gold and the dollar would not be in the interests

of gold producers at this stage.

Mr Horwood said, however, that much more was at stake than the interests of gold producers — "We are now dealing with nothing less than monetary and political stability in the Western world and the survival of the free-enterprise system."

It was generally realised that the attempts to demonetise gold had failed, and while it was no longer the legal numeraire of the system, it had in recent years increasingly reasserted itself as a factor in international affairs.

"It has been used in swaps and as collateral for loans; it has been included in the pool of monetary reserves backing up the European Monetary System; and even at the relatively low market price of recent months, it constitutes about 55% of the total official reserves of free world countries."

The reluctance of some major industrial countries to give adequate recognition to the monetary role of gold could not be blamed entirely for the

unsatisfactory performance of the world economy over the past 15 years, but the attempt to phase gold out of the system had coincided with a period of serious financial instability.

The ploy of selling official gold reserves in the private market to depress the gold price and to diminish its monetary role did more harm than good to the system, and in trying to phase gold out of the system the "reformers" succeeded only in phasing out a lot of confidence and trust in currencies and in monetary arrangements.

Mr Horwood said there was an urgent need to clarify and formalise gold's monetary role, and the dollar held the key to the whole development.

"I have never seen the issue of monetary reform in terms of 'gold versus the dollar', but always as one of 'gold and the dollar'."

The notion of phasing out the reserve currency role of the dollar was for the time being just as naive as that of phasing out gold, and the best way of moving forward to a new gold-based system would be for the US to take the lead by restoring convertibility of the dollar into gold at a fixed price.

A new alliance between the dollar and gold could prove to be the key to the improvement of the working of the international monetary system, just as the alliance between gold and the pound proved so successful during the 19th century and up to 1914.

In any move towards a new gold-based system there were bound to be many pitfalls which would have to be avoided, said Mr Horwood, requiring a thorough investigation by experts.

"I trust that the new United States Gold Commission will leave no stone unturned in performing its task. In the meantime I see no reason why other qualified bodies, such as the IMF, should not conduct studies of their own in this important field."

There would be many experts who, while recognising the existence and importance of gold as an official reserve asset, would not favour the re-establishment at this stage of a formal link between the dollar and gold in a fixed official dollar price for gold.

While respecting this point of view, Mr Horwood hoped that these experts who were not prepared to go all the way to restoring a gold-based system would concur that it was highly desirable to reach agreement now on international rules for the valuation and use of gold by monetary authorities.

"What possible reason could there be for opposing the principle of reaching agreement on these issues other than an object-

session with the demonetisation of gold as an objective overriding all others?"

It would be naive to think that the institution of a new gold-based system would solve the world's present economic problems, without simultaneously tackling the basic causes.

"I am convinced that the world's present economic ills stem basically from a combination of excessive government spending and intervention in the economy, undue money creation, unrealistic interest and exchange rates, excessive use of mandatory price and wage controls, unjustified protectionism, undue reliance on exchange and import controls, the inordinate use of subsidies and the general lack of national and international financial discipline."

The monetary authorities of the world had much to gain and nothing to lose by forging sound money policies on the confidence which people consistently displayed in gold.

GOLD

# Conflicting hopes

79

FM 22/5/81

Finance Minister Owen Horwood has been left in no doubt that however uncluttered is his view of the complementary role of gold in the pursuit of a sound international monetary system (starting with the dollar), the new US administration does not see things quite so clearly. At the "World Gold Markets 1981-82" conference in London this week, Horwood's familiar plea for some reinstatement of bullion in official policies to buttress monetary discipline received a cool answer from the official US speaker.

Richard Erb, the designated US executive director of the International Monetary Fund, pointed out that the decline in gold's function in the American monetary system — an evolution which had been paralleled elsewhere — had not been the result of a change of philosophy. The process which culminated in the dollar devaluations of the early 1970s and ultimate end of the gold numeraire had been a series of pragmatic responses to market pressures.

That pragmatism remains the core of US policy. Horwood, who until 18 months ago has been a rather lonely finance minister in his proselytising mission at world monetary forums, may be right to feel encouraged by the reopening of the gold standard debate. And he has been especially cheered by the blue ribbon Gold Commission being set up by the US treasury to study and make recommendations on American policy towards the metal and its role in the domestic and international monetary system.

Erb acknowledged that the traumatic experiences of the last 30 years "should provide clear answers." But as he emphasised, the renewed interest in the monetary role of gold "springs in large part from the inability or unwillingness of governments to bring inflation under control. And the US Gold Commission will still have to wrestle with questions of judgment on which reasonable men can, and do, differ," said Erb.

Thus, in the Reagan administration's approach to US economic problems "the emphasis is on the fundamentals": a long-term restructuring instead of short-term demand management. Erb believes that Reagan's four-pronged programme — lower federal spending, restrained money supply growths, unfettering the operation of industry and incentives to earn through lower taxes — will ultimately shift the US down the bumpy road to lower inflation.

As for the Gold Commission and the monetary debate, Erb seemed to feel he was stating the obvious when he concluded:

"Success in reducing (US) inflation and money supply growth may have a more significant impact on the gold market than the outcome of the Gold Commission."

Not surprisingly, in the current beleaguered state of the market after its dizzy ride in 1980, specific guidance on the future of the gold price was not offered — voluntarily at least — by the 15 international experts recruited by Consolidated Gold Fields and the Government Research Corporation (of Washington) to speak to the conference. Tim Green, who specialises in monitoring the souks and bazaars of the Middle and Far East, did, however, offer a clue to the canny investors. The restoration of premiums over the London price, ranging from \$41 to \$76, in Cairo, Bombay, Jakarta and Taipei showed that the grass roots hoarders (of high carat jewellery and coins) who disinvested so heavily at the top last year were back in the market.

The bear market may thus be near its end. As for forecasts — about which each of the 300-odd bankers, brokers, traders, investors and miners (many of whom paid the £400 fee for the conference) had their own ideas — some were available. Republic National Bank's offer of an ounce of gold for the delegate who guessed the last fixing before Christmas this year drew 160 entrants. The range was \$375 to \$890 with a mean of \$564.

A persistent questioner extracted the following from a panel of market experts on the short term outlook:

"Leo Melamed, chairman Dellsher Investments, Chicago Mercantile Exchange: \$30 to \$40 either side of the current level.

"Gan Tjoen Hok of United Overseas Bank, Singapore: \$450-\$580, depending on

the Middle East

"Kenneth Yeung, of King Fook Finance, Hong Kong: \$450-\$550

"Keith Smith, managing director Moccatta & Goldsmid (slightly facetiously): \$456.33-\$498.72.

All of which, in the great guessing game, suggests that the grass roots hoarders who got it right last year may be getting back in at the bottom

# Gold's monetary role gains more converts

Argus 23/5/81

79

## Financial Correspondent

**LONDON.** — There is growing evidence that the message that gold has a role to play in international monetary affairs is getting through to a wider audience.

Not so many years ago, it was said to be impolite to discuss gold in front of modern economists, who regarded it as a 'barbarous relic'.

Today gold is being talked about and discussed by a growing band of converts.

Over the past 10 days the market place has seen publication of the best seller Gold 1981 from Consolidated Gold Fields and it has heard world experts at a two-day London conference on gold.

### LATEST STUDY

Now follows the latest study by Dr Fred Collender and Mr David Drummond of stockbrokers Strauss Turnbull on South African gold mining shares.

From South Africa's point of view, one of the more significant developments in the world gold debate must be the appointment of a US congressional committee to study present US policy towards gold and its role in the domestic and international monetary system.

Given America's strength of voice in the world, and its political power, the outcome of the commission could be very significant for those with gold's interests at heart.

Consolidated Gold Fields' survey makes the point that official pur-

chases of gold increased significantly last year.

The gold conference was told in no uncertain terms that central bankers would be displaying a more active interest in gold in the years ahead.

And Strauss Turnbull makes the point that in the uncertain world ahead, everyone should have an insurance in gold.

South African gold shares may have been out of fashion of late and investors in Europe and America — who have the world to choose from — may well be finding other investment areas more attractive.

### CONVINCING

But there is a convincing line in the Strauss Turnbull report which could well make overseas investors sit up and act.

The brokers say: 'The investment case for included selected shares of well managed South African gold mines in a portfolio is overwhelming.'

One factor which has undoubtedly contributed to the growing awareness of gold is the string of gold futures markets which are opening up around the world.

Dr Collender and Mr Drummond sum up the view of today's monetary world neatly.

'Over the longer term, gold will reassert itself. Over the next two years there should be a minor increase in production, but thereafter output should steadily decline.

'On the economic front, the paper moneys of the world will progressively falter, and international debt continue to mount.

'The Dollar itself will come under pressure as the support of high interest rates is withdrawn. On the socio-polit-

ical front, unrest is likely to continue in several of the eastern bloc countries.

'France could face a new period of inflationary unrest. Norway, Yugoslavia, and Turkey could become further focal points of Soviet attention, and the Middle East could again come under severe tension.

'It should not be forgotten that Opec countries now control 20 percent of the world's liquid reserves covered by only five percent of the world's gold reserves.'

Want to know what will happen to the gold price? Don't bother asking the experts, writes NEIL BEHRMANN.

# The great gold get-together

PDM 23/5/81

79

MORE THAN 300 dealers, mining house leaders, fabricators, jewelers and other fundis this week attended a mammoth gold conference sponsored by Consolidated Gold Fields and a Washington firm, Government Research Corporation.

In keeping with the ancient traditions of gold they met at London's historic Guildhall, but even that venue failed to draw any new light on the subject.

The delegates came from South Africa, the United States, Europe, the Far East, South America, Saudi Arabia and other Middle East countries. But for a sole reporter from Tass, delegates from the Soviet Union — the second largest producer — were conspicuously absent.

For an ounce of gold, participants could take a bet on the price of bullion on the last day before Christmas this year. Prices ranged from a low of \$370 to a high of \$890 and

the average price was \$564. It is highly probable that there would have been similar guesses at a conference in Ogies.

The 15 eminent speakers, including Minister of Finance Owen Horwood and Chamber of Mines president Bill Lawrence, refused to make voluntary forecasts.

Some did, right at the end of the conference, after persistent questioning from Ted Arnold, Merrill Lynch's precious metals analyst and a one-time mining editor of the Rand Daily Mail.

"We paid R700 to attend this conference, so you could at least tell us where the price is going," said Mr Arnold.

"I think it is going to trade between \$470 to \$520 in the next three months. Do you agree?" he asked.

With worried frowns a panel consisting of dealers from Zurich, London, Chicago, Hong Kong and Singapore thought that the bottom of

gold would be \$450.

The bravest speaker, (from Singapore) ventured that gold would rise to \$580, "depending on political events".

Keith Smith, managing director of Moccatta and Goldsbullion houses, said facetiously: "The bottom will be \$456.33 and top \$498.72," which is another way of saying "how on earth should I know?"

Rudolf Schriber, senior bullion manager of Credit Suisse, one of the members of the Zurich Gold Pool, said: "With that price range you leave me no option."

Meanwhile dozy participants sat through hour-long speeches with one speaker after another discussing in intimate detail what had happened in the gold market rather than what was going to occur.

Whiling away the time, reporters made bets on the most unremarkable speech, and there appeared to be a

close tie between Chamber of Mines president Bill Lawrence and South Africa Minister of Finance, Senator Owen Horwood.

Mr Lawrence set the pace in the first speech of the conference with the enlightening observation: "The unprecedented rise in the gold price over the past decade, has been reflected in a period of remarkable profitability and expansion for the South African gold mining industry."

Replying to a detailed question on gold's proportion of international reserves and liabilities, Sen Horwood said he was "not a walking encyclopedia," but he reminded his audience "that many years ago I told Parliament that gold would rise, and to my amazement, the price doubled!"

Realising that it would be front page news, if the South African delegation would forecast a lower price of gold in the coming year, I went up

to a Chamber of Mines official and said: "I am putting you on record as saying that gold will fall to \$150."

The official did not appreciate the joke, indicating that I was a heretic. "If you print that I will never speak to you again," he shrieked.

"Can't you see, gold has bottomed out. All the money which is deposited in dollars at high interest rates will rush into gold as soon as rates fall."

A precious metals buyer at a very large refiner was sceptical. "Producers always say that the price is going up and dealers don't really handle the stuff."

"Orders are slow and there is no follow-through in demand. Investors who bought gold at much higher prices are averaging their losses and are buying at lower prices again. I reckon that they are throwing good money after bad," he said.

Charles Stahl, editor of the New York-based Greens Commodities Market Comments, was optimistic: "The public is out of the market and most people are cynical. This means that gold is forming a major bottom," he said.

Yet last year the little guy was right. Consolidated Gold Fields consultant Timothy Green said that the day gold hit \$850 the Kuwait gold bazaars were under siege. Perhaps two or three thousand people milled around, fighting their way into overcrowded shops with cigar boxes and biscuit tins crammed with bangles and necklaces.

There were similar occurrences in jewellery shops all over the world.

"While the so-called sophisticated investors were buying the traditional hoarder was selling," said Mr Green.

"This year unsophisticated Middle Eastern hoarders are buying while all the experts are shying away from the market."

May  
1 Mei  
1980

May  
Mei  
1980

69 000  
8 333  
716 000  
758 000  
539 000  
8 518 000  
38 519 700  
69 368 000  
36 000 000  
433 117 200  
431 516 715  
818 000  
90 265 000  
14 500 000  
9 546 000  
91 700 000  
60 000 000  
13 090 000  
2 350 000  
153 700 000  
26 000  
41 000 000  
39 618 000  
113 727 000  
371 000 000  
69 900 000  
70 470 000  
27 535 000  
640 000  
133 650 000  
323 064 948  
45 199 465  
23 533 567  
337 000  
2 786 250  
1 414  
71 857 696  
394 922 644

No. 1237 12 June 1981

**SOUTH AFRICAN RESERVE BANK ACT, 1944**

**DETERMINATION OF STATUTORY PRICE IN GOLD**

It is hereby notified that, in terms of section 17A (1) of the South African Reserve Bank Act, 1944 (Act 29 of 1944), the Minister of Finance has valued, as from 13/5/81, all gold of the South African Reserve Bank at R360 per fine ounce of gold.

No. 1238 12 June 1981

Notice is hereby given that the transfer books of the under-mentioned local/internal registered stocks will be closed from 15 June 1981 to 15 July 1981 both days inclusive, and that the interest due on 15 July 1981, will be paid to the stockholders registered at the date of closing of the transfer books:

- 6½ Per Cent Local Registered Stock, 1993.
- Internal Registered Stock, 9,80%, 2001.

**DEPARTMENT OF INDUSTRIES, COMMERCE AND TOURISM**

No. 1226 12 June 1981

**NATIONAL BUILDING REGULATIONS AND BUILDING STANDARDS ACT, 1977 (ACT 103 OF 1977)**

The Deputy Minister of Finance and of Industries, Trade and Tourism has in terms of section 17 (3) of the National Building Regulations and Building Standards Act, 1977 (Act 103 of 1977), approved that the period during which all interested parties may lodge objections against the national building regulations as set forth in the Schedule to Government Notice 125 of 1981 (*Government Gazette* 7377, dated 6 February 1981) be extended to 16 October 1981.

**DEPARTMENT OF INTERNAL AFFAIRS**

No. 1222 12 June 1981

**ALIENS ACT, 1937**

**CHANGE OF SURNAME.—VAN DER MERWE TO JAMNIK**

The State President has been pleased under the provisions of section 9 of the Aliens Act, 1937 (Act 1 of 1937), to authorise Charles Viktor van der Merwe, residing at 9 Bantry Road, Bryanston, Randburg, to assume the surname of Jamnik.

No. 1237 12 Junie 1981

**WET OP DIE SUID-AFRIKAANSE RESERWEBANK, 1944**

**BEPALING VAN STATUTÊRE GOUDPRYS**

Hierby word bekendgemaak dat die Minister van finansies kragtens artikel 17A (1) van die Wet op die Suid-Afrikaanse Reserwebank, 1944 (Wet 29 van 1944), alle goud van die Suid-Afrikaanse Reserwebank met ingang van 31/5/81 teen R360 per ons suiwer goud gewaardeer het.

No. 1238 12 Junie 1981

Hiermee word bekendgemaak dat die oordragboeke van ondergenoemde plaaslike/binnelandse geregistreerde effekte van 15 Junie 1981 tot en met 15 Julie 1981 gesluit sal wees en dat die rente betaalbaar op 15 Julie 1981 aan die effektebesitters wat op die datum van sluiting van die oordragboeke geregistreer is, betaal sal word:

- 6½ Persent Plaaslike Geregistreerde Effekte, 1993.
- Binnelandse Geregistreerde Effekte, 9,80%, 2001.

**DEPARTEMENT VAN NYWERHEIDSWESE, HANDEL EN TOERISME**

No. 1226 12 Junie 1981

**WET OP NASIONALE BOUREGULASIES EN BOUSTANDAARDE, 1977 (WET 103 VAN 1977)**

Die Adjunk-minister van Finansies en van Nywerheidswese, Handel en Toerisme het ingevolge artikel 17(3) van die Wet op Nasionale Bouregulasies en Boustandaarde, 1977 (Wet 103 van 1977), toestemming verleen dat die tydperk waarin belanghebbendes besware kan indien teen die nasionale bouregulasies wat in die Bylae by Goewermentskennisgewing 125 van 1981 (*Staatskoerant* 7377 van 6 Februarie 1981) uiteengesit is, verleng word tot 16 Oktober 1981.

**DEPARTEMENT VAN BINNELANDSE AANGELEENTHEDE**

No. 1222 12 Junie 1981

**WET OP VREEMDELINGE, 1937**

**VANSVERANDERING.—VAN DER MERWE IN JAMNIK**

Dit het die Staatspresident behaag om, kragtens die bepaling van artikel 9 van die Wet op Vreemdelinge, 1937 (Wet 1 van 1937), Charles Viktor van der Merwe, woonagtig te Bantryweg 9, Bryanston, Randburg, te magtig om die van Jamnik aan te neem.

# UK chartists see gold falling to 300 dollars

Alguo 13/6/79 (79)

are going to have another opportunity in the next few months to build up a portfolio for the next bull market.'

on her charts the storm breaks in the early 450-dollar range.

Mr David Fuller of Chart Analysis says everything points to a trading range between 375 and 425 dollars once the price slips below the present 460 to 470 dollar band.

Mr Lake is the only chartist bold enough to say outright that gold shares should be sold.

Miss Wood says merely that now is not the time to buy gold or gold shares. But that there is no need to panic.

But when experts in anything are all agreed, then events have an uncanny way of proving them wrong.

## INTEREST RATES

One gold bull is Mr Arthur Abrahams of Bone, Fitzgerald.

He believes that gold's soggy performance is closely linked with worries over United States interest rates. He does not think US rates will go to 25 or 30 percent, as some have suggested.

Significantly, no chartist suggests that investors should part with their Kruger rands or gold coins.

Sterling holders will have done well out of them because of the recent weakness of the pound.

In an earlier comment, Mr Julian Baring of James Capel said: 'Our message is to keep your heads down by all means, but there is no cause for panic.'

Long-term investors who missed the gold market on the two previous occasions look as if they

## Financial Correspondent

**LONDON. — Several City chartists and brokers are bearish about the gold price. Some claim gold is 'teetering on the brink' before plunging.**

The slide could be down to the 300-dollar mark, with some pauses on the way.

Anxious chartists taking the temperature of gold as it has wandered between 460 and 470 dollars see the next 'stop' — once it has pierced 456 dollars — somewhere between 375 and 425 dollars.

Mr Brian Marber of Simon and Coates says gold 'made its big downward decision' when the price fell below 475 dollars.

## WAR SCARES

'Even two war scares in a week — the incidents of the Iraq bombing and the latest dramas over Poland — only spurred the price weakly, and for just one day,' he says.

Mr Richard Lake of Grieveson Grant sees the major selling signal at about the same level as Mr Marber, and he is predicting the next stop will be somewhere around 380 to 400 dollars.

'I am very bearish. In eight or nine months we could see gold down to 300 dollars,' he told the New Standard.

## HIGH RISK

Miss Bronwen Wood at Rowe and Pitman says gold has been 'high risk' ever since the price slipped below 490 dollars, and

only talk about rights if we are prepared to rescue these people before the law if they do not. Whether the ship car stalls or the crops fail, the same argument applies. Instead of saving lives Wolraad had gone home and set about or a lifeboat service or lighthouse. Suppose that as a these services were established. As a consequence able to save many more lives in the future (as well as his own). Is this less admirable? In general, should we invest in capital

10/.....

and neglecting to send off an Oxiam cheque this month, both of which have the consequence of causing the death of a certain number of people. In addition, Wolraad's deed raises a number of other difficult questions. Having got to the wreck, on what basis was he to select which passengers to save first? It is difficult to discover a general rule. The conventional "women and children first" (besides being rather arbitrary) does not define which women and which children. Suppose Wolraad rode out to the wreck for the purpose of saving his father. Would his action be any less good than? Had the rule of women and children first been enforced, he might not have ridden out at all. Could he be censured for this? If members of his

12/.....

9/.....  
Iv considered to have been a Good Thing. be admired, it cannot be argued that he did 12. Indeed, his fame rests precisely on liberally more than could reasonably have did the conclusion that the ship-wrecked require him to rescue them though of course

10/.....  
equipment now in order to increase food production later? This generation, then, bears burdens to lighten the load of our descendants. How do we weigh up loss of life (and loss of the quality of life) between generations? Who is so wise as to know the answers? Some economists, it is true, attempt to measure these variables empirically and pretend to believe their own results. Such studies do nothing to increase our knowledge, though they do provide a basis for the

ing and the value of nothing. el that saving life is the society has ever existed to imagine that one every high degree of coercion and e, since most farmers would njunction to save life is unfortunately morality has does not tell us whose life n, seems to contradict the t there is an important moral ng to keep alive"15. If we ept the extreme view that llagers with a machine gun

# All SA's Star 16/6/81 gold may 79 go to one market

From the Financial Times  
 BASLE — South Africa is likely to sell all its gold production of about 21-million ounces (650 tons) on the international bullion market this year, Dr Chris Stals, senior deputy governor of the South African Reserve Bank, said in Basle.

This would mark a departure from South Africa's policy last year when it stocked up gold reserves by 66 tons, mainly as the result of retention of gold production, as well as the unwinding of previous bullion exchanges with commercial banks.

Speaking at the annual meeting of the Bank for International Settlements, Dr Stals, who is in charge of gold operations at the Reserve Bank, said the need to sell all production was determined by the country's balance of payments.

South Africa's current account deficit was running at a seasonally adjusted annual rate of R1 000-million in the first quarter after a surplus last year.

One of the factors behind the swing into deficit was the lower price of gold which last year accounted for more than half of national exports.

However, Dr Stals said that even if the bullion price dropped further from its present levels the current account deficit would still be manageable.

South Africa would not be likely to sell gold from reserves if the balance of payments worsened further. It would be more likely to enter into more gold exchanges with international banks — a form of borrowing against pledged gold reserves, under which South Africa exchanges gold for foreign exchange for a fixed period.

Now suppose that over successive years the annual

(1) Plot this demand curve as accurately as possible, preferably using graph paper.

2. cont.....

- (2) Now suppose that over successive years the annual "crop" amounted to and 70 million bush gross value of the scheduled above was
- (3) Calculate the average years, and the output
- (4) Construct a schedule for each of the output the gross value of gross value. Plot curve. (It will be
- (5) From the demand curve on the market in or from these amounts would have to buy
- (6) Draw up a schedule buy or sell in each the government have to buy over the stabilization of the

...government would have to  
 ...years of part (2). Would  
 ...later than the amount it would  
 ...the answer mean that  
 ...is impossible?



# South Africa intends selling full gold production this year

ct 18/6/81 (79)

By NEIL BEHRMANN

**BASLE.** — The Reserve Bank is not considering another gold swap at this stage because there are more than sufficient trade finance and credit facilities to meet South Africa's foreign exchange requirements.

The bank also intends selling all the country's production of around 670 tons this year. Senior deputy governor of the Reserve Bank, Dr Chris Stals, said that there were still 4m ounces of gold which were held by Swiss and German banks, from previous swaps which were negotiated in the mid-seventies.

At that time South Africa was desperately short of foreign exchange, so the Reserve Bank negotiated two gold swap deals with the three big Swiss banks which form the Zurich gold pool, and West German banks who are important gold traders.

In all, about 8m ounces of gold were swapped for foreign exchange in 1975 and 1976. The Reserve Bank paid the banks' interest for the foreign exchange facilities.

Late 1979 and early 1980, the Reserve Bank unwound half of the swaps, amounting to 4m ounces. The foreign exchange was repaid and the bank began selling the gold late in 1979.

Though there is no official confirmation, it appears as if the bank began sales in November 1979 when the price broke through \$400 and continued selling into strength in the early part of 1980, when the price shot to a peak of \$850 and traded above \$700 for several weeks. The remaining 4m ounces of swapped gold remains in force, and with the balance of payments current account in deficit and the price weak, the Reserve Bank has decided to roll over the credit facility.

By the same token, however, the bank has not decided to negotiate a further swap at this stage.

"Though there are always the possibility of gold swaps, we do not feel that they are necessary under present circumstances and they are not

under serious consideration", said Dr Stals, who heads the bank's gold and foreign exchange operations. Neither Dr Stals, nor the Reserve Bank governor were prepared to comment on possible tactics if the gold price slipped to \$400. They pointed out that gold had remained remarkably firm considering the strength of the dollar and high interest rates.

In terms of other currencies, for example, the Swiss franc and Deutsche mark, the price had actually increased in the past few months.

"Gold has done very well in the circumstances so the current price could be already discounting high interest rates and the possibility of a recession in the United States", said Dr De Kock.

South Africa's gold reserves rose by 100 000 ounces to 12,25m ounces in the first quarter of this year, but Dr Stals insisted that the bank had no intention of withholding gold.

"When there is a deficit on the balance of payments current account we tend to sell full production", he said. Last year the Reserve Bank withheld about 1,4m ounces from the market.

The Bank for International Settlements (BIS) reported that central bank gold reserves rose 7,5m ounces in 1980. Opec countries added 3,4m ounces to their gold holdings of which 2,1m was accounted for by Indonesia. Non-oil developing nations increased their holdings by 2,8m ounces.

In money terms countries' total gold reserves rose by \$65-billion to \$553-billion in 1980 and gold reserves represented about 57% of total foreign exchange and bullion reserves in the international monetary system.

In countries such as the Netherlands, gold accounts for about 80% of total reserves.

Dr Stals suggested that countries should make greater use of their gold reserves. European countries swap gold for the European monetary system currency, ecu's. Countries such as Italy had

raised credit in the past with gold collaterals, while South Africa itself had swapped gold with Swiss and German commercial banks.

Countries also swapped gold with the Bank for International Settlements to meet short-term foreign exchange requirements. Even so, there was plenty of room for bilateral negotiations between countries' central banks.

These negotiations could be formalized under definite rules of independent organizations such as the IMF or the BIS.

BIS officials said that for many years countries had swapped gold forward for foreign exchange. There were several methods. Sometimes the gold was deposited at the BIS, the clearing bank for central banks, or it was pledged and held by the central banks themselves.

The BIS reported that its gold holdings had increased because of "net deposits received and "the conclusion with other central banks of swaps of gold (purchased spot) against various currencies."

Assistant general manager and economic adviser of the BIS, Professor Alexandre Lamfalussy, said that in relative terms the quantity of gold swaps was "insignificant".

He said that countries only needed to swap their gold as a last resort, especially if their credit rating was low. For example, West Germany has managed to finance its huge balance of payments current account deficit through borrowings because of its excellent credit rating.

There was no need to swap gold. Two other European central bankers, from separate countries, tended to agree. "Gold is being held by the banks because it can be used as a last resort", said one of the central bankers.

"Though gold has definitely increased in importance, other credit facilities can be utilized, especially if the countries have a solid rating in the markets," added the other central banker, who had an intimate knowledge of gold collaterals.

# FINANCE

## MINES CHIEF

# OPTIMISTIC ON GOLD PRICE

Aug 23/6/81

79  
~~77~~

JOHANNESBURG. — Optimism about the prospects for gold, tinged with concern about the effect of the skilled labour shortage on the country's ability to produce the metal, was expressed today by Mr R S Lawrence, president of the Chamber of Mines.

Addressing the chamber's annual meeting in Johannesburg he said the present relative stability in the gold price would be followed by real increases in the price continuing well into the future.

The gold price this year had been relatively low compared with the peaks last year.

Nevertheless the price this year has remained remarkably stable at levels which were unthinkable only three years ago.

### HIGH RATES

'This is particularly true if one considers the recent high United States interest rates, a strong dollar, an apparent stabilisation in the oil price and a generally slack international economy.

It appears from the available information that there is a closer balance between supply and demand at present.

Consequently, in the immediate future it appears unlikely that the gold price will vary greatly.

However, economic and political uncertainties remain. A turnaround in US interest rates, a weakening in the present strength of the dollar, further increases in the oil price and continuing political disturbances around the world are inevitable.

### UPWARD TREND

'I believe, therefore, that the gold price will resume its upward trend in order to balance projected supply and demand.

'In any event the broadening of the gold market which we have seen in the past five years will continue and this will ensure an increase in real terms in the gold price well into the future.'

The development of the South African mining industry was a classic example of the free enterprise system working successfully, and it was an example which could well be followed in other areas of public endeavour with similarly successful results.

'Nor should the benefits of co-operation and co-ordination be limited to South Africa alone.

'These are benefits which can and should be enjoyed by Southern Africa as a whole working in partnership together.'

### EXPANSION

The mining industry was planning to spend R12 000-million on expansion in the period to 1985 and would create nearly 100 000 new jobs, though mainly for unskilled workers.

However, it was difficult to see how these expansion plans could be implemented in the face of the worsening skilled manpower position.

In the nine months to March the number of vacancies for skilled workers on gold mines alone increased by more than 40 percent to 2 609.

Mr Lawrence called for a sound basic schooling for all as a starting point

to solving the country's skilled labour shortage and the subsequent teaching of technical skills to anyone who sought to acquire them, regardless of race or colour. — SA

E.B. Sutter, M.B., B.Ch., D.O. (Eng)  
Elim Hospital, Northern Transvaal.

The Care-Groups, a Community Involvement in Primary Health Care

## 2. FORMATION AND FUNCTIONING OF THE CARE-GROUPS

A hospital based team, consisting of a male social worker and a female nursing assistant, have been entrusted with the task to motivate and train groups of village health workers, known as care-groups.

Initially, after having contacted the village authorities and key persons, the team presented the problem of trachoma to the community and they discussed together ways of solving it. Members of the community were then motivated to come forward as volunteers. These villagers, mainly women, subsequently organised themselves as groups and elected their chairlady. It was made clear from the outset that the work was purely voluntary, their reward being good health for themselves and their community.

Level. We have found that the attitude accepted in the houses and most effective in initiating changes in attitude towards the disease. Hence we have attempted to involve the villagers themselves in the control of trachoma.

Valley Trust deep trenching method. Early in their training Care-Group members begin to visit neighbouring households where they give health education, examine all household members for trachoma and give treatment where necessary. Other ailments encountered are referred to the clinic or hospital. Each Care-Group member keeps a record of her visits made.

18.

drawn between prevalence and incidence. Prevalence cases constitute the number during a single period of both old and new cases, while incidence (or production) indicates the number of new cases produced during a given time. It should also be borne in mind that the given prevalence figures were imprecise and merely estimates. In 1910 M. Gemmill, an actuary at the Chamber of Mines, explicitly stated that there were 'no statistics' available for the establishment of an insurance fund, a scheme then being contemplated by the Chamber of Mines. In 1909 the Transvaal Leader reported that the true silicosis figures would 'never' be known because no specific records had been kept.

# Reagan calls for fresh assessment of gold's role

By Michael Chester, Financial Editor

President Reagan caused a stir on world bullion markets today by naming a special commission to make a new assessment of the role of gold in international monetary systems.

An announcement from the Treasury Department in Washington said the 17-man commission will study afresh United States policies on gold and send its findings and recommendations to Congress.

The implications of a possible change in US policy may have enormous implications for the economy of South Africa which, as the largest producer of all, earns about R10,000-million a year from gold exports.

The US has taken an anti-gold stance ever since President Nixon caused chaos on world currency markets in 1971 when he abruptly withdrew traditional US pledges to convert gold into dollars.

## ANCHORED

The shock announcement had repercussions on the international monetary system, which had been anchored by the convertibility promise.

A world conference was held to adjust virtually every major currency to meet the new situation in late 1971. One outcome was that the South African rand was devalued by a stunning 12.8 percent.

However, the currency crisis went on unabated

To Page 3, Col 8

In 1910 the Mining Regulations suggested numerous improvements (some of which have already been confirmed). Both commissions reported a risk of contracting silicosis that certain surface workers were also at risk.

surface workers were healthy group. The been no diminution that the average duration from seven to nine average had a life expectancy, with mine on average. (113) Percent of miners had since 1902, and the full manifestation of these effects on the development of silicosis. (114) The commissioners also concluded that in the secondary stage of silicosis there was a higher percentage of coexistent tuberculosis than had been previously recorded in 1903. (115) Subsequent writers believed that the mortality figures were probably an underestimation because 'at least one-third (and probably more) of the disabled miners' had left the Transvaal to die elsewhere. (116)

The Mining Regulations Commission stressed the importance of protecting workers from fumes and dust created by blasting and recommended the introduction of a single day shift. The latter was not made obligatory by the 1911 Mines and Works Regulations, framed in terms of the Mines and Works Act, introduced by Jan Smuts, Minister of Mines. Improvements were made to the blasting regulations, and other regulations provided for greater improvements underground concerning sanitary conditions on the recommendations of the commission. In addition, by 1914, it was estimated that 23 of the 42 producing mines had introduced the single day shift. (108a) Such improvements did not, however, satisfy Barry, who in 1911 gloomily (and correctly) predicted:

The terrible thing to think of is that it will take at least 7 years from the date upon which the whole community seriously starts trying to really achieve any noticeable results since, as things stand today, we are perpetually manufacturing fresh victims who will be with us for some such period as 7 years. (109)

In assessing the prevalence figures a distinction must be

17. comprised one-third of the white mining population, had not been augmented by further overseas skilled immigrants, because the latter were afraid of contracting silicosis for which the Rand mines were now notorious. (105) Finally the high prevalence rate of silicosis was attributed to the failure of the mine-owners to ameliorate underground mining conditions. Merriman referred to their 'callous indifference'. (106) Barry's experience on several committees of the Chamber of Mines preparing evidence for government commissions, made him completely aware of the attitudes of the mineowners and their reactions to suggested improvements. He stated in 1914 that they - he called them the 'sticker-snatchers' - had 'moved only when they had to'. (107)

WORKERS

(107a)

(108)

(108a)

(109)

(110)

(111)

(112)

(113)

(114)

(115)

(116)

(117)

(118)

(119)

(120)

(121)

(122)

(123)

(124)

(125)

(126)

(127)

(128)

(129)

(130)

(131)

(132)

(133)

(134)

(135)

(136)

(137)

(138)

(139)

(140)

(141)

(142)

(143)

(144)

(145)

(146)

(147)

(148)

(149)

(150)

(151)

(152)

(153)

(154)

(155)

(156)

(157)

(158)

(159)

(160)

(161)

(162)

(163)

(164)

(165)

(166)

(167)

(168)

(169)

(170)

(171)

(172)

(173)

(174)

(175)

(176)

(177)

(178)

(179)

(180)

(181)

(182)

(183)

(184)

(185)

(186)

(187)

(188)

(189)

(190)

(191)

(192)

(193)

(194)

(195)

(196)

(197)

(198)

(199)

(200)

(201)

(202)

(203)

(204)

(205)

(206)

(207)

(208)

(209)

(210)

(211)

(212)

(213)

(214)

(215)

(216)

(217)

the mortality, and make suggestions for improvements in living and working conditions of African miners. (149) This Committee of Doctors led to the informal inauguration of the Mine Medical Doctors in 1904 under the auspices of the Chamber of Mines, and in 1921 it was formally instituted as the Mine Medical Officers Association whose members provided part-time and full-time medical care for black mineworkers. (150)

Although the Department of Mines and the Chamber of Mines adopted the recommendations of the Committee of Doctors and the Coloured Labourers Compound Commission, individual mining houses were not receptive to many of them on the grounds of 'great expense'. (151) One mining house director was alleged to have complained that these suggestions would lead to 'pampering Africans' who had 'too much already'. (152) This led the Lieutenant Governor to introduce the Coloured Labourers Health Draft Ordinance in September 1905 which, when passed, enabled the Lieutenant Governor to enact regulations for the improvement of the health of African mineworkers. One of the first regulations was a provision enabling the Government Medical Officer or any other government official to inspect compounds and medical facilities and to enforce their installation or effect improvements if they were found wanting. (153) All these steps had been initiated originally by Milner. He had anticipated the advent of Chinese labourers in 1904, because of the shortage of Africans. Their living and service standards had been conditional for the introduction of Chinese indentured labour. Renewable three year contracts were also of the stipulated conditions. Because of the strictures placed on the importation of the Chinese, the Government did not wish to be found negligent in the case of African mine labour. (154) Some of the mine-owners objected to the Coloured Labourers Ordinance on the grounds that it was a 'dodge' to introduce 'contentious legislation' which would bypass the Legislative Assembly, especially regarding the housing and feeding of Africans; and they also believed that inspection would undermine the authority of the mine managers. (155)

The Witwatersrand Native Labour Association (the WMLA), established in 1900, had obtained monopolistic recruiting rights for Africans in South African territories, Portuguese East Africa and British Central Africa, and took steps to introduce founder medical examinations at its border depots and its central depot in Johannesburg. It also provided Africans with waiting stations at intervals of a day's march, and provided the recruits with food, clothing and blankets. (156) Despite these innovations, and improvements to the compounds and hospitals - the latter, which were really 'appendages' to the compounds, and which in 1905 were described by a medical doctor, F.C. Sutherland, as 'models of what such places should be', (157) the disease mortality figures, especially of 'tropical'

Africans, namely those who came from Africa North of latitude 22° South, were still a cause for considerable concern. (158)

A breakdown of the disease mortality rates shows that throughout the entire period under discussion, pneumonia, even after recruiting was prohibited in 1914 from Africa, north of latitude 22° South, leading to a drop in its mortality rate, was 'still the most formidable disease'. (159) The Committee of Doctors found that in the latter half of 1903 63 per cent of the total mortality could be ascribed to pneumonia, phthisis (meaning pulmonary tuberculosis) and other diseases. (160) Pneumonia, the 'most deadly' disease, contributed 32 per cent of the entire death rate. (161) Next in order of importance was tuberculosis which was found to be prevalent in the compounds and was a considerable 'factor in the death rate.' From July to December 1907 pneumonia had the highest prevalence rate of any disease (49,43 per thousand per annum) while its mortality rate accounted for almost 40 per cent of that from all causes, and was 10,14 per 1 000 per annum. Pulmonary tuberculosis ranked second as a cause of

to originate on the Witwatersrand, and it was often

and the result was that all the main currencies were allowed to float to find new exchange rates.

Critics have complained that a monetary system without gold as a pivot has been impossible to handle properly and some have blamed the Nixon move as the trigger to world-wide inflation troubles.

#### PRIORITY

What impressed bullion market observers today was the obvious high priority given to the new gold policy review.

Mr Donald Regan, Secretary of the US Treasury, will head the new commission. Members also include three Federal Reserve governors, Mr Charles Partee, Mr Emmett Rice and Mr Henry Wallich, a trio with huge influence on US monetary policy.

Bullion supporters have been encouraged to speculate that even if the US decides a return to a full gold standard is impracticable, at least there may be moves to re-establish a compromise.

to employ a person suffering from tuberculosis underground. As in 1903 and 1910, the death rate from pulmonary tuberculosis was still lower than that of lobular pneumonia, but the causes of both were still attributed to poor and overcrowded sleeping quarters in the compounds and to the fact that underground work increased miners' susceptibility to the disease. No longer was it attributed to the absence of change houses because the Mines and Works Regulations of 1911 had stipulated the construction of shelters - change houses were for whites - at the head of shafts, and some were built with temperatures at 10°F higher than outside temperatures. This was to prevent black miners catching chills when emerging from the hot and humid deep-level underground conditions. (165)

From 1916 to 1928 the incidence and prevalence of simple pulmonary tuberculosis dropped. (166) This may have been because of the introduction

Stw 23/6/81  
Fresh US  
look at role of gold

From page 1

to receive the fact that it was a punishable offence for management to

# Optimism from Lawrence on gold price

8/10  
23/6/81  
79

The present relative stability in the gold price would be followed by real increases in the price of gold continuing well into the future, Mr R S Lawrence, president of the Chamber of Mines, said in Johannesburg today.

- \* Mr. J. Frankish, Dr. Friedman, 9  
 Mr. Jos Gerson,  
 Mr. C. Goldsmith Johannesburg 2  
 Ms. J.M. Goodwin  
 Ms. P. Green, c/c  
 Dr. May Hansen,  
 \* Mr. J. Hedden, c  
 \* Mr. S.B. Henen,  
 Mr. S.B. Hofmeyr  
 \* Prof. T.L. Holds Johannesburg 2  
 Ms. J. Hollingsh  
 Ms. L. Hoogendoc  
 Dr. Hughes, Dep  
 Ms. D. Hendrie,  
 Mr. D. Horner, S  
 Dr. John Ireland  
 Dr. Marian Jacob  
 \* Dr. Basil Jaffe,  
 \* Dr. H.W. Kanis,  
 \* Ms. Elaine Katz, Johannesburg 2001  
 Dr. Maureen Kearney, Blyth Cottage, Station Rd., Rondebosch 7700  
 Dr. Haroon Khamissa, 89 Jupiter Rd., Surrey Estate 7700  
 \* Dr. Maurice King, 37 High Oaks, Welwyn Garden City, Herts AL8 7BT, England  
 \* Prof. Ralph Kirsch, Dept. of Medicine, Observatory 7925  
 \* Dr. I. Kitai, 20 Hettie St., Cyrildene, Johannesburg 2198  
 Ms. N. Klepper, School of Agriculture, UNZA, P.O. Box 2379, Lusaka, Zambia  
 Dr. J. Klopper, Dept. of Health & Welfare, Ciskei Govt., P. Bag X 517, Zwelitsha 5608  
 Mr. K.P. Klugman, Medical School, Univ. of Witwatersrand, Hospital Hill, Johannesburg 2001  
 \* Dr. P.W. Kok, P.O. Box 12, Elim Hospital, N. Tvl. 0960  
 Ms. A. Kooy, Saldru, School of Economics, UCT, Rondebosch 7700
- In his presidential address, Mr Lawrence said he also foresaw that the consolidation now taking place in the economy would provide the opportunity for a "further upward surge in the economy in due course."  
 He said the rate of growth of about eight percent in the real gross domestic product last year was the second highest in post-war history and one of the highest in the world, being eclipsed only by the rapidly expanding economies of Singapore and Hong Kong, and by certain Opec countries.
- CONSOLIDATION**  
 "That high economic growth rate experienced in 1980 was clearly not sustainable but a growth rate of around five percent for this year seems possible."  
 "There has been much comment on the change in the direction of the economy this year but it should be borne in mind that the normal economic and business cycle will continue to operate."  
 "The present period of consolidation therefore provides the opportunity for a further upward surge in the economy in due course."  
 Mr Lawrence said the economic cycle had also had its impact on the gold markets and prices had been relatively low compared with the peaks of last year.  
 "Nevertheless the gold price this year has remained remarkably stable at levels which were unthinkable only three years ago. This is particularly true if one considers the recent high US interest rates, a strong US dollar,
- an apparent stabilisation in the oil price and a generally slack international economy.  
 "It appears from the available information that there is a closer balance between supply and demand at the present time.  
 "Consequently, in the immediate future it appears unlikely that the gold price will vary greatly from the present relatively stable level.  
 "However, economic and political uncertainties remain. A turnaround in US interest rates, a weakening in the present strength of the US dollar, further increases in the oil price and continuing political disturbances around the world are inevitable.  
 "I believe, therefore, that the gold price will resume its upward trend in order to balance projected supply and demand. In any event the broadening of the gold market which we have seen in the last five years will continue and this will ensure an increase in real terms in the gold price well into the future."
- CO-OPERATION**  
 Mr Lawrence said that the development of the mining industry was a classic example of the free-enterprise system working successfully, and it was an example which could well be followed in other areas of public endeavour with similarly successful results.  
 "Nor should the benefits of co-operation and co-ordination be limited to South Africa alone. These are benefits which can and should be enjoyed by southern Africa as a whole working in partnership together." — Sapa.
- Rondebosch 7700  
 and, 1 Jan Smuts Ave.,  
 bosch 7700  
 a 0181  
 atersrand, 1 Jan Smuts Ave.,  
 7700  
 sch 7700  
 sch 7700  
 and, 1 Jan Smuts Ave.,

48, 5 + 31



**UNI  
EXA**

All answer books

Number of book
Number of this

Surname.....

First Name(s).....

Date.....

Degree/Diploma/C  
you are registered

Subject.....  
(to be copied f

Paper No.....

(to be copied from the heading on the Examination Paper)

needs to take a hard look at strategies. Industrial gold consumption has been on a downtrend for the past two years. But it has increased by about 15% over the last six months and could reach 50% by the end of the year.

But this is largely due to its reduced price, and Dr Robert Weinberg, Anglo American's gold marketing manager, says few people are selling gold jewellery this year.

The international jewellery industry's total gold requirements were 350t last year, including all the gold obtained from dishoarding. In 1978 the industry used 1 000 t and, in 1979, 740 t.

Recessions in Europe and America and the volatile gold price have been largely responsible for the low demand. However, much of the problem appears to lie with the industry's inability to hedge against price rises and its lack of sophistication in purchasing and marketing.

One American manufacturer, quoted in the Consolidated Gold Fields *Gold 1981* report, says the spectacular day-to-day swings in the gold price devastated the sales forecasting and production planning of the jewellery industry.

The report continues that a significant portion of the industry in the USA (and presumably the rest of the world) is somewhat under-capitalised. As a result sales were being maintained through depletion of inventories and smaller retailers had difficulty replenishing stocks at considerably higher prices.

"At the retail level," says Weinberg, "many jewellers are cutting their own throats with very high mark-ups. Some of them are taking as much as 200% on the price of the gold content on fairly small items."

Many concern themselves only with cash turnover, he adds, and do not worry about the number of units sold.

For some time the Chamber of Mines gold marketing arm, Intergold, has been

advising retailers to reduce mark ups to make it possible for the average consumer to buy.

Intergold manager Chris Raats says retailers should appreciate that they are less likely to feel the adverse affects of price fluctuations if their sales base is broad.

He says retailers tend to forget they are competing with the travel, appliance and other industries for disposable income. If they want to attract that income, he says, they must be more active and aggressive in their marketing.

Unlike the rest of the world, the local market is currently buoyant. Yet euphoric local retailers should remember that the favourable conditions are attracting alternative distribution channels, says Raats. Mail-order houses and department stores are increasing jewellery activities and retailers who are not making themselves sufficiently known to consumers are losing a tremendous opportunity.

IT enter in  
ch question  
high it has  
ins (2) and

External
(3)

**GOLD 74** PM 26/6/81  
**Caveat to jewellers**

International trends in the use of gold for jewellery manufacture indicate that the industry — especially at the retail level —

Initials		
----------	--	--

**NOTE CAREFULLY**

1. The answers only on the right hand pages will be marked. The left hand pages may be used for rough work, but no credit will be given for such work.
2. Enter at the top of each page and in column (1) of the block on this cover the number of the question you are answering.
3. Blue or black ink must be used for written answers. The use of a ball point pen is acceptable. Red or green ink may be used only for underlining, emphasis or for diagrams, for which pencil may also be used.
4. Names must be printed on each separate sheet (e.g. graph paper) where sheets additional to examination book(s) are used.

**WARNING**

1. No books, notes, pieces of paper or other material may be brought into the examination room unless candidates are so instructed.
2. Candidates are not to communicate with other candidates or with any person except the invigilator.
3. No part of an answer book is to be torn out.
4. All answer books must be handed to the commissioner or to an invigilator before leaving the examination.

**Any dishonesty will render the candidate liable to disqualification and to possible exclusion from the University**

# Gold's role as store of wealth still unchallenged

27/6/81  
Arcus  
39

**THE news that the United States Treasury has appointed a committee to investigate the role of gold failed to excite the Johannesburg Stock Exchange this week.**

Although gold shares showed a marginal improvement on the announcement, these gains were not held.

The rise in South African interest rates to new highs and the drop in the dollar price of gold to a new low for the year seem to have had greater claims on the market's attention.

The South African authorities can draw some

satisfaction from the news of the appointment of the committee. Four years ago it was the United States Treasury which was the protagonist in a campaign to destroy gold.

But while the appointment of the committee marks a considerable change in attitude, no one is getting too excited about this development.

This reflects a feeling that the committee may have been formed not to welcome back gold as an important constituent of the international monetary scene but to find ways to

rule out finally and completely any role for the metal in this area.

## ANTAGONISM

There is much antagonism to gold in the United States, especially among some influential economists. To them it is still a barbarous relic, deserving as little consideration as the cowrie shells which were also once used as money.

This antagonism is reflected in the media which tend to portray advocates of gold as having much in common with hot-gospelers — that is cranks whose convictions do not stand up too well to logical reasoning.

Bias against gold also comes through strongly in

By  
**DEREK TOMMEY**

articles ostensibly trying to describe what the advocates of a more important role for gold in international affairs are seeking.

These articles usually consist of suggesting that a return to the gold standard is being sought and then giving reasons — which is easy to do — why such a step is impossible.

## IGNORANCE

This is playing on the ignorance of the public and of some gold bugs, as anyone knowing even a little about economics must realise that a return to the gold standard is just not on.

A move back to the gold standard, no doubt, has appeal for some people because they believe it

would curb government spending and reduce inflation. But such views are based on the somewhat naive belief that governments never cheat.

Moreover, the views also fail to take into account the fact that the return to such a gold standard could seriously hamper economic growth.

It seems fairly certain, therefore, that no government will support a return to the gold standard.

## WELL SUITED

What role then can gold play in the modern world? The answer is simple — as a store of wealth for which it is extremely well suited.

The events of the past decade, including the collapse of the British pound and the American dollar have shown that over the long-term and in troubled times there is nothing to beat gold in this role.

Governments are especially aware of this. Countries such as West Germany and Japan, which hold large amounts of dollars in their foreign exchange reserves, have suffered heavy losses as a result.

So one can expect the committee, if it does anything constructive at all, will make recommendations in this direction.

But if it does not it will not matter. The people who count — the central bankers of the developed countries — now know all about gold's virtues.

## FLASH POINTS

And as long as there are flashpoints around such as Iran, Israel and Poland, which are all potential threats to the dollar, central bankers will continue to support gold in their usual discreet fashion.

Holders of gold shares may also be reassured by the fact that the rand's exchange rate this week continued to drop in line with the gold price.

As a result the mines are still continuing to receive R400 an ounce or near this figure for their gold. This is the same price as they have been receiving for the past two months or so.

As long as this situation continues, holders of gold shares should have no cause for concern.

## INTEREST RATES

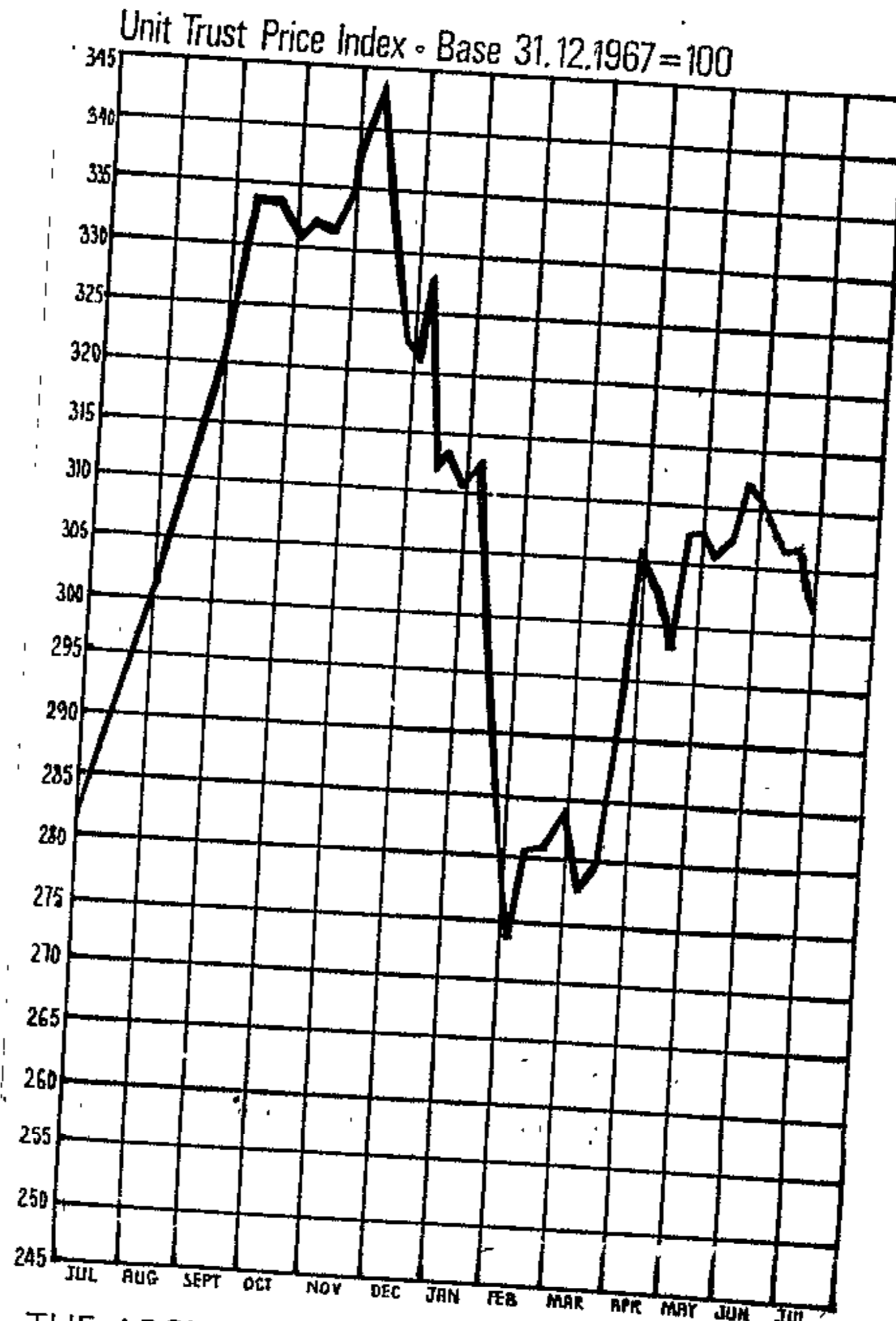

THE ARCUS unit trust index fell 3.7 points this week to 302.83.



# Oppenheimer sees firm base for gold over \$450

CT 30/6/81 (79)

JOHANNESBURG. — With serious private investors striving to protect their assets through a partial diversification into gold it appears that supply and demand factors will provide a firm base in the gold price between \$450 and \$500 an ounce.

Mr Harry Oppenheimer, chairman of East Rand Gold and Uranium, (Ergo), says in his annual review that speculative activity on the futures markets could bring about renewed bursts of volatility carrying the price outside this trading range, especially in the event of further international upheavals.

"Nevertheless, I am encouraged by the strength and stability of the market, particularly during a period of record high real dollar interest rates. After the instability of 1980, this must assist the market to consolidate and will provide the basis for its continued, long-term, upward trend."

Mr Oppenheimer says the outlook for this year indicates a further decrease in gold supplies with dishoarding unlikely to resume unless there is a substantial price increase.

"While industrial consumption will probably show a further decline, demand from jewellery manufacturers already shows a renewed upward trend."

He says the arrangement with Simmer and Jack to treat sands and slimes dumps and to exploit the underground ore reserves is an important step forward in the development of Ergo, principally by enabling it to expand the base of its existing activities.

"Shareholders are expected to benefit from this project, especially at higher gold prices and particularly as protection against the major risk is being provided by associated companies."

He adds that the decision to proceed with the Simmer project means that Ergo, which was otherwise expected to become liable for tax during the current year, is unlikely to pay a substantial amount.

The treatment of Ergo's Springs No 3 dam, which has a relatively high grade — 0,84 g/t — will be completed in August and will be replaced as the principal material source by dams 4, 5 and 6.

On the basis of earlier sampling, these dams are expected to contain a significantly lower average in situ grade of 0,52 g/t. As a result, gold production will decrease and is expected to be at least 5 600 kg, while about 275 tons of uranium and 480 000 tons of sulphuric acid will be produced this year.

## Uranium

Mr Oppenheimer notes that against the background of a continued decline in the projected growth of electricity demand, the uranium market weakened appreciably during the past year.

It was originally assumed that nuclear power would provide the major part of the additional generating capac-

ity which would be needed and the recent cancellations and deferrals by various countries has affected the nuclear industry particularly severely.

As a result of the declining price a substantial part of the world's uranium production already costs more to produce than can be realized on the current spot market, and a number of producers have been forced to curtail their operations and, in some cases, close, says Mr Oppenheimer.

In addition, it appears probable that some newly-discovered ore bodies will not be brought to account in the face of declining prices and rapidly escalating costs of capital and production.

"Consequently, supply and demand are likely to come into balance sooner than is generally anticipated, although it will be some time before this is reflected in a strengthening of real prices."

The international shortage of sulphur and sulphuric acid has eased somewhat and prices have recently weakened, says Mr Oppenheimer, although in South Africa demand for fertiliser, greater uranium production and the strength of the economy increased the demand for acid and prices continued to rise.

"Unfortunately Ergo's acid production costs have outstripped the escalation of its contractual prices to the extent where the return on the acid plant has fallen to an unacceptably low level."

He adds that Ergo has been forced to approach its customers to review contractual pricing structures "and negotiations are currently underway."

# Gold hits 18-month low in London

NDM  
30/6/80  
Financial Reporter  
79

The marginal decline in Eurodollar deposit rates appeared to have little dampening effect on bullish sentiment for the US currency, dealers said.

GOLD fell to \$428.75 in London yesterday afternoon, the lowest level since December 5, 1979. It edged up, however, to \$430/\$431 at the close.

The dollar closed at 2.3925/40 German marks after opening at 2.3795/3805.

The morning fixing was \$431.50 compared with \$442 at the second fixing on Friday.

Dealers said yesterday's trading was generally subdued with many operators engaged in booksquaring for the end of the month, quarter and half year.

Gold has now almost halved in its dollar value since the \$850 peak of January 1980.

After opening lower on the weaker trend in Eurodollar deposit rates the dollar rallied in the afternoon in a thin market on moderate buying in the US.

This means that the tumble is proportionately as hefty as the crash of 1975-76 that followed the 1974 surge when the price came within a whisker of \$200 before falling all the way back to just over \$100.

It rose it late trading to £1.9440.

Platinum is also under threat now with the free market price dropping to \$408.50 yesterday against the official producer price of \$475.

The French franc, which reached its lowest level for 23 years at around 5.76 to the dollar last Friday, maintained its recovery yesterday to trade at 5.6825 in mid-afternoon.

The dollar firmed in quiet afternoon trading to close above its opening levels against most leading currencies, dealers said.

The Soviet Foreign Minister, Mr. Andrei Gromyko's planned visit to Warsaw next month before the special congress of the Polish Communist Party made the currency markets nervous, dealers said. — Reuter, UPI.

Gold was characterised by lack of buyer interest and high dollar interest rates, dealers said.

It was continuing a slide that has wiped nearly \$240 off the price

(a) outsiders, and (b) local people.

The effect of economic non-viability

In Part I, I show how the economic conditions in the reserves inhibit projects like the dairies from being able to work efficiently and that they do not directly benefit the poorer people involved.

I suggest that it is because of this that such a tiny percentage of the total population of an area join such projects the adoption of new techniques (e.g. in agriculture) is not worth the cost involved for the majority of people. "...it was striking how attitudes tended to correspond broadly with the ability to cope with the demands of existing methods. Those families who were struggling to stay alive ... had low morale and far less interest in hearing of new methods than were those who had some surplus ..."

44

EXPLOITATION BY

EXPLOITATION BY

Here one must consider the exploitation that isolated villagers have experienced at the hands of outsiders ostensibly involved in beneficial activities. Villagers have had to take incoming groups at face value because they cannot assess the real motives of these people and the power backing them up.

The exploitation of the difference in world view has a long history going right back to the first missionaries. Men such as Dr Phillip, "The Defender of the Hottentots", who were ostensibly aiming to benefit "the natives", advocated breaking down the power of the chiefs and expanding British interests: "Wherever the missionary places his standard among a savage tribe, their prejudices against the colonial government give way, their dependence upon the Colonial government is increased by the creation of artificial wants ..."

John Mackenzie of Bechuanaland had interests beyond mere trade: "We invite John (Bull)'s attention to this delicious morsel of gold field, let him spread it like jelly over Transvaal and Bechuanaland and swallow the lot".

2.4 NOTES CONCERNING MY INFORMATION ON THE PROJECTS

1. Amathole Creamery was the only place where I could check the figures people gave me. Generally, their estimates of income were more than twice as high as the actual amount earned over the last year. Over-estimation of profits from the project may be a general trend.
2. Projects fluctuate so wildly over time (also depending on seasonal and market conditions) that it is misleading to take any one time as

# Gold falls to lowest price in 18 months

RDM 30/6/81 (79)

Financial Reporters

GOLD fell to \$428,75 in London yesterday afternoon, the lowest level since December 5, 1979. It edged up, however, to \$430/\$431 at the close.

The morning fixing was \$431,50 compared with \$442 at the second fixing on Friday.

The gold price tumble is proportionately as hefty as the crash of 1975-76 that followed the 1974 surge when the price came within a whisker of \$200 before falling all the way back to just over \$100.

Heavy losses continued in gold shares on the Johannesburg Stock Exchange and industrial shares also showed further declines.

The Rand Daily Mail gold share index fell to 478,5 from 515,1 yesterday. It hit a record 1 026,1 in September last year.

This means that thousands of millions of rands have been lopped off the value of gold shares in the past nine months — although prices generally are still just above the levels of early March this year.

The Rand Daily Mail 100 index of industrial shares dropped to 598,4 yesterday, the first time it has been below 600 in over three months.

But it remains reasonably near to its 1981 peak of 651,5 at the beginning of May, however.

The high level of interest rates in the United States is the main reason for the fall in gold.

There is, however, a speculative factor as well with disappointed investors selling out to look for new areas of opportunity.

Political events do not seem at the moment to have much influence on the market. The explosion in Teheran was barely noticed.

Altogether 42 gold shares fell on the JSE yesterday and only one rose, but the decline was

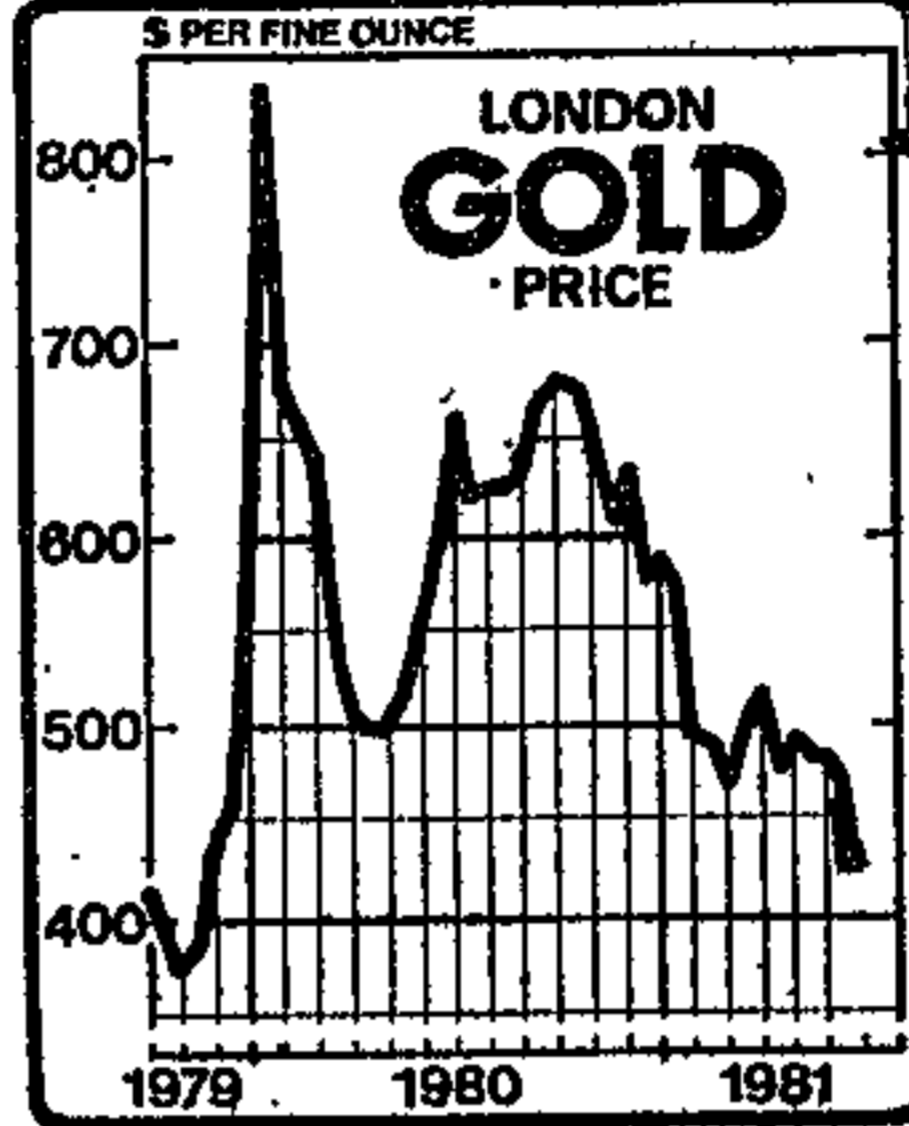

Gold at its lowest price since December 1979.

not quite as bad as the indices implied. This was because some shares were marked lower after dividend payments had been made.

Gold analysts said a gold price below \$450 would have serious consequences for many of the so-called marginal gold producers, putting at least three into a loss situation, while endangering dividend payments for others.

Mining analysts believe a continued gold price at the current level will stop dividend payments at least from Deelkraal, Elandsrand, ERPM and Elsberg.

The lower income is also likely to result in producers taking a closer look at capital expenditure programmes, as well as development of existing working areas and working costs.

● Platinum is also under threat — with the free market price dropping to \$408,50 yesterday against the official producer price of \$475.

● See Page 14

allocated the RDM's because they had the most land and stock at the time of survey.

I have made no attempts to analyse the class structure in detail.

Basic divisions I use are:

Professional and business people (shops and transport)

People with access to land

People with no agricultural resources who are generally migrants

One must note the family linkages within the business and professional class and how different sectors support each other at various times.

Number of Participants interviewed

Communal garden  
Zenzele Centre (which students helped to build)

Dairy  
Communal garden  
Communal garden  
Shearing Shed

Emphasis on agriculture (all fields used)

(5 members &

Project

Place

IDOLOPHU

INKOMO

ABALIMI

UMTHI

UMLAMBO

AMANTHOLE

IPOTI

IGUSHA

There were questionnaires for dairy me  
Anyone interviewed with one of these i  
interviewed with a general income que:

I used the questionnaire mainly to avc  
to be able to get hold of economic information and factom out now the projects  
run. Because there are so few people in projects and I could not interview  
many who are not involved, I was not aiming at a scientific collation of data,  
but rather at using the questionnaires to standardise issues raised in  
conversation and as a way of stimulating discussion. (All interviewing was  
done in Xhosa).

./..

Klarman, H.E., Francis, J.O'S, and Rosenthal, G.D. Efficient Treatment of Patients with Kidney Failure in Cooper and Culyer, 1973.

Kong-ming New P. & M.L. New Health Care in the People's Republic of China: The Barefoot Doctor Inquiry Vol.12, June, 1975.

Korn, J. Shall we send aid to Health? Agency for Environmental Protection Denmark, 1976. (Unpublished)

Krutilla, J.V. Welfare Aspects of Benefit-Cost Analysis Journal of Political Economy Vol.69, 1961.

Layard, R. (ed) Cost Benefit Analysis Penguin, 1972.

Lesourne, J. Cost Benefit Analysis and Economic Theory North Holland, (London, 1975).

McKean, R. Use of Shadow Prices in Chase 1968.

McLachlan, G. and McKeown, T. (ed.) Medical Care Nuffield Provincial (1971).

Medical Officer of Health - Cape Town 1965-1976.

Mishan, E.J. 1) Elements of Cost Benefit Analysis and Unwin (London, 1972).  
2) Cost Benefit Analysis Unwin (London, 1975) 2nd edition  
3) The Value of Life

Munnik, L.A.P.A. Satellietsklinik Skiereiland S.A. Medical Journal

Mushkin, S. Health as Investment Journal of Political Economy, Vol.70, 1962.

Myrdal, G. Economic Aspects of Health and Social Change No.7, 1952.

Newell, K. (ed.) Health by the People  
Newton, T. Cost Benefit Analysis in Unwin (London, 1972).

Nuffield Provincial Hospitals Trust  
Quantitative Methods in Health Services Research University Press, (London, 1975).

Nurock, R. 1) The CPA Day Hospitals Organisation Unpublished private paper 1970.

2) The Day Hospitals Organisation - The First Four Years S.A. Medical Journal, 25 May, 1974.

Obstetrics and Gynaecology - Departmental Annual Reports UCT/CPA 1965-1976.

Packer, A.H. Applying Cost Effectiveness Techniques to the Community Health System Operations Research Vol.16, 1968.

Urethra Service June, 1975.

**JOHANNESBURG.** — With serious private investors striving to protect their assets through a partial diversification into gold it appears that supply and demand factors will provide a firm base in the gold price between \$450 and \$500 an ounce.

Mr Harry Oppenheimer, chairman of East Rand Gold and Uranium, (Ergo), says in his annual review that speculative activity on the futures markets could bring about renewed bursts of volatility carrying the price outside this trading range, especially in the event of further international upheavals.

"Nevertheless, I am encouraged by the strength and stability of the market, particularly during a period of record high real dollar interest rates. After the instability of 1980, this must assist the market to consolidate and will provide the basis for its continued, long-term, upward trend."

Mr Oppenheimer says the outlook for this year indicates a further decrease in gold supplies with dishoarding unlikely to resume unless there is a substantial price increase.

"While industrial consumption will probably show a further decline, demand from jewellery manufacturers already shows a renewed upward trend."

He says the arrangement with Simmer and Jack to treat sands and slimes dumps and to exploit the underground ore reserves is an important step forward in the development of Ergo, principally by enabling it to expand the base of its existing activities.

"Shareholders are expected to benefit from this project, especially at higher gold prices and particularly as protection against the major risk is being provided by associated companies."

He adds that the decision to proceed with the Simmer project means that Ergo, which was otherwise expected to become liable for tax during the current year, is unlikely to pay a substantial amount.

The treatment of Ergo's Springs No 3 dam, which has a relatively high grade — 0.84 g/t — will be completed in August and will be replaced as the principal material source by dams 4, 5 and 6.

On the basis of earlier sampling, these dams are expected to contain a significantly lower average in situ grade of 0.52 g/t. As a result, gold production will decrease and is expected to be at least 5 600 kg, while about 275 tons of uranium and 480 000 tons of sulphuric acid will be produced this year.

## Uranium

Mr Oppenheimer notes that against the background of a continued decline in the projected growth of electricity demand, the uranium market weakened appreciably during the past year.

It was originally assumed that nuclear power would provide the major part of the additional generating capac-

ity which would be needed and the recent cancellations and deferrals by various countries has affected the nuclear industry particularly severely.

As a result of the declining price a substantial part of the world's uranium production already costs more to produce than can be realized on the current spot market, and a number of producers have been forced to curtail their operations and, in some cases, close, says Mr Oppenheimer.

In addition, it appears probable that some newly-discovered ore bodies will not be brought to account in the face of declining prices and rapidly escalating costs of capital and production.

"Consequently, supply and demand are likely to come into balance sooner than is generally anticipated, although it will be some time before this is reflected in a strengthening of real prices."

The international shortage of sulphur and sulphuric acid has eased somewhat and prices have recently weakened, says Mr Oppenheimer, although in South Africa demand for fertiliser, greater uranium production and the strength of the economy increased the demand for acid and prices continued to rise.

"Unfortunately Ergo's acid production costs have outstripped the escalation of its contractual prices to the extent where the return on the acid plant has fallen to an unacceptably low level."

He adds that Ergo has been forced to approach its customers to review contractual pricing structures "and negotiations are currently underway."

Roemer, M.I. Evaluating Community Health Centres Public Health Papers No.48, World Health Organisation 1972.

Rosser, R. and Watts, V. The Measurement of Hospital Output International Journal of Epidemiology Vol.1, No.4, 1972.

# Fear that gold is heading for 400-dollar mark

8000  
30/6/81  
79

By Colin Campbell,  
Financial Correspondent

LONDON — It was Black Monday for gold yesterday and London analysts are redoing their sums on individual South African gold-mining shares because they fear that gold could be headed for the 400-dollar mark.

Bullion analysts say that the chartists hold the key to where the gold price goes next. Having broken through several important resistance levels, chartists' predictions and readings are all the vogue.

London gold was fixed yesterday morning at 431.50 dollars an ounce and then fell further to 428.75 dollars at the afternoon fix. In the last eight months gold has fallen nearly 240 dollars.

"The chartists have been screaming for gold to go lower — and in the absence of any good buying interest gold had nowhere to go but down," an analyst at commodity brokers M L Doxford said last night.

## SILVER FALL

It was a generally bad day for precious metals all round. Silver plunged to 440.65 pence in London — a US equivalent of 8.58 dollars an ounce — its lowest level in two years. Platinum was down to 406 dollars against a pre-weekend New York quote of 418 dollars.

Central banks are believed to be poised to enter the gold market at around 380-400 dollars but, while the market is jittery, bankers are staying on the sidelines.

London bullion dealers do not believe that central banks have joined the selling spree — but their current lack of interest has left the market with-

out a prop.

There are several positive factors still running for gold: the latest political developments in Iran, the planned visit by Soviet Foreign Minister Mr Andrei Gromyko to Poland, the aftermath of the Mitterrand victory in France and the Israeli election.

However, there are several negative factors pulling investors away from gold — high US interest rates, a strong dollar, relative peace on the oil front, and a feeling that gold is yesterday's story.

Swiss dealers said last week that it was "hard" trying to support the gold price at around 450 dollars, and that many investors had decided to open bear positions in the metal.

At some point there will be bear covering and the market will turn — or at least its slide will be arrested — but until buyers do step in, sellers will outnumber buyers.

Mr Paul Sarnoff, director of Rudolf Wolff in New York, maintains that while US interest rates remain in double-digit figures and the US inflation rate remains in single figures, nobody is going to be seriously interested in precious metals.

July spot gold closed in New York at 426 dollars, and September futures gold was down 21.50 dollars.

# Hammered gold Star 30/6/80 (79) continues plunge

By Ann Crotty

Gold is continuing to plunge on international markets. London's opening price this morning was 421,50 dollars an ounce, a drop of nine dollars overnight and the lowest level it has reached since November 1979.

Today's price is less than half that at which gold peaked in January 1980 and represents a drop of 60 dollars in one month's trading.

In the wake of this morning's drop, gold shares on the local market continued to take a ham-

mering.

The Johannesburg Stock Exchange's all gold index dropped to 460,8 last night, 100 points lower than it was two weeks ago. Today's trading will see this index go even lower.

Dealers described the feeling on this morning's market as "very uneasy" with private investors anxious to sell but unable to find buyers.

Towards lunch they reported some stabilisation of prices at lower levels following the stabilisation of gold at around the 423-dollar level.

# Gold price drop may reduce inflation

Star 1/7/81

79

By David Breier,  
Chief Reporter

Johannesburg economists today predicted the plummeting gold price would help reduce inflation in South Africa.

Severely reduced gold profits for South Africa will have two conflicting effects on inflation, economists say.

One effect will be deflationary. It will cause money to drain from the economy. This reduces the excessive money supply which has created demand and therefore inflation.

The other effect will be inflationary as lower gold profits will cause a balance of payments deficit. This will reduce the exchange rate of the rand and imported goods will become more expensive, adding to inflation.

An example of the recent lowering of the rand exchange rate will be the 5c or 6c per litre increase in the petrol price expected shortly.

Economists agree that the deflationary effect of the gold price decline will

be more powerful than the inflationary effect. The overall effect will be anti-inflationary, they say.

Professor Joubert Botha, head of the Department of Economics at the University of the Witwatersrand, said the short-term effect would be a drop in the money supply which would fight inflation.

The long-term effect was difficult to predict because there were so many factors, he said.

Dr Johan Cloete, chief economist of Barclays Bank, said on balance the effect of the declining gold price would be anti-inflationary.

He said the outflow of money would help the Government's policy of reducing the money supply which has already begun with higher interest rates.

Mr Andre Hamersma, chief economist of the Standard Bank, said the lower gold price would assist in the fight against inflation by causing more money to flow out of the economy.

th

student.  
ze

Molly Gohl Memorial Prize  
For the best woman student

P A Rappoport

satisfactorily completed  
1st, 2nd and 3rd major courses.

Helen Gardner Travel Prize  
For a student who has

P F Dunckley

Sixth Year

For the best student in :-

Cape Provincial Institute of Architects' Prize

FINE ART & ARCHITECTURE

ARCHITECTURE

**GOLD**

# Down, but not out

79 FM

3/7/81

Gold's price decline of the past week or so seems to have developed a dynamic all its own. Particularly in the US, where futures markets for the moment exert the preponderant influence on bullion, the chartists are vying with each other to produce the gloomiest scenario.

They were right on the \$450 resistance level — once it was penetrated the scene was set for a fall to the next support level, \$380. And as US futures trading is highly attuned to chart movements, the fall to that level may be self-fulfilling. Much of it

could be due to stop-loss selling, but that does not detract from the fall itself.

The problem for investors is deciding how far the fall will extend and whether it is worthwhile trying to finesse the bottom of the market. The sharper and deeper bullion's fall is, the sharper could be the turnabout. If that happens and short sellers are caught on the hop, the latest price falls may seem like a mere hiccup.

It may be small comfort for investors who are suffering from the present fall in bullion and share prices, but there are

signs that a reversal may not be far away. For the present, we can probably safely ignore any but the most extreme political developments. News of this Monday's bomb attack on Iran's clerics was accompanied by further falls at the London gold fixes and lower prices for future delivery in New York and Chicago. A year ago, the bombing would almost certainly have set bullion alight. Nor, necessarily, would Soviet intervention in Poland heighten political fears. It may even be construed as a necessary move to restore order in an

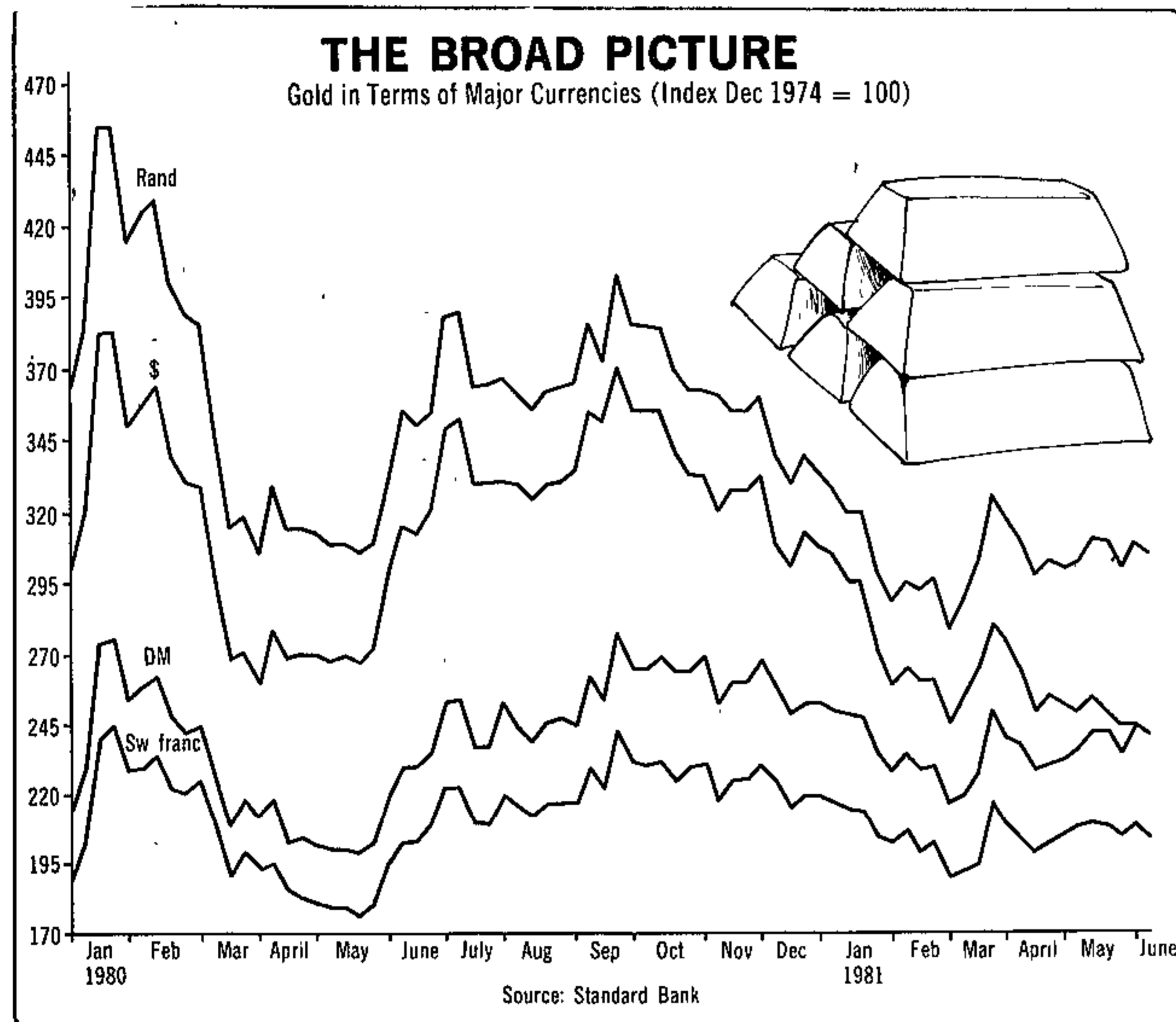

increasingly chaotic and high-risk (for Western bankers) satellite.

Nor, while we are on the negative factors, is there much point in expecting the recently-announced US Gold Study Commission to produce anything positive. Around Washington, the consensus is that the commission is simply a sop to the pro-gold lobby which supported Ronald Reagan's election campaign.

There is little advantage to America in returning the dollar to gold convertibility at a fixed price or even a revaluation of the country's official gold reserves from the present \$42,20 at which they are currently calculated. Convertibility at too low a price would lead to an outflow of bullion and a rush of foreign dollars into the US, while too high a price would lead to a tremendous burst of liquidity and inflation in the US. The overriding temptation must, then, be to leave well alone.

So what are the positive factors for gold?

For a start, the dollar and gold have not escaped their antagonistic relationship. Gold's dollar-denominated price merely reflects the strength or otherwise of the greenback. For the present the seesaw is

tilting in favour of the dollar. When it comes to other major currencies, which have almost without exception fallen against the dollar, gold's price performance has been a lot less volatile (see chart). We are still in the situation in which real returns on dollar assets result in weak bullion prices and vice versa.

But the seesaw which has led to the dollar's surge depends on a further balancing act — maintenance of high US interest rates, continued expectations of lower inflation and positive American economic growth. Let one of them crack and we could be back into a bullish tack for gold.

Let's start with interest rates and tight credit. Advance estimates by the US Department of Commerce indicate that the US economy will suffer an interest rate induced 3% drop in real gnp during the second quarter — a far cry from the first quarter's 8,6% advance.

That is where the first tricky part of the balancing act comes in. A brief recession would be enough to reduce tax revenues and widen the US budget deficit beyond expectations. And as most Americans, and the rest of the world for that matter,

remain convinced that unbalanced budgets are responsible for inflation, lack of confidence in the dollar could quickly revive.

On the other hand, if the Federal Reserve decides to allow interest rates to fall, one of the dollar's other props could be weakened — real rates of return on US dollar investments.

The Europeans, who have been forced into high interest rate policies to counteract their currencies' weakness against the dollar, have been nagging Washington to cut interest rates for several months. A high dollar means more expensive oil imports in local currency terms, even though dollar-denominated oil prices are, for the time being, sluggish. But let the dollar fall and the Opec hawks will have a field day as oil producing nations try to prop up their foreign exchange earnings. The result: another inflationary round.

Even if the dollar starts slipping, the present administration is unlikely to do anything to prevent it. Policy is for cleanly floating exchange rates and, perhaps more to the point, a large degree of official US indifference to gold price movements.

Everything, if we are not being too optimistic, adds up to a positive outlook for the dollar-denominated gold price. And if just one of the above factors does tilt the seesaw in gold's favour, the charts which futures traders seem to be taking as gospel could tilt the other way and set the New York and Chicago futures markets about. When the turning point will come is another matter, but it is probably not more than a couple of months away.

In September, the US Treasury will be requesting a \$100 billion-odd increase in the Federal debt limit — necessary if US Federal debt maturing after end-September is not to be defaulted. Apart from anything else, that increase will reinforce fears of larger future budget deficits. So even if the US administration manages to hold its act together for a couple more months, by September confidence in the dollar could come under yet another strain.

As well as asking how far gold can fall, we need to ask how far it can rise. If the past is anything to go by, the sharper and deeper the present fall, the sharper and steeper the eventual recovery. Don't count on an early move to the \$1 000 level being punted by some increasingly hysterical chartists. But a reasonable bet could still be a \$500 average for the rest of this year.



# We can cope if gold drops to \$400 — Horwood

Star 3/7/81  
79

By Colin Campbell, Financial Correspondent

LONDON — As the London gold price flirted around the 410-414 dollar level yesterday the Minister of Finance, Mr Owen Horwood, said: "It could be some months before we see a turn-around."

Against a background of high US interest rates and in the absence of any political explosion in the world, it was not surprising that gold was performing badly.

However, a gold price which hovered around the 400-dollar mark was something which South Africa could still handle, even if it did mean there would be a deficit on the current account of the balance of payments this year.

The Minister's party saw the British Chancellor of the Exchequer and other officials yesterday, but had no definite plans to meet French administration officials when it visits France shortly.

"In view of the course

of US interest rates, we expected the gold price to weaken," the Minister said, "but at some point gold would start to look attractive to industrial users, and when that happened there would be a positive effect on the price."

## NO PRESSURE

"Before the end of this year, we should see the gold price moving up again — but how far and how fast is anybody's guess," the Minister added.

South Africa would "tend to sell the greater part" of her gold production on the market.

Mr Horwood said that South Africa was not looking for overseas loans at present, and that the country was not under pressure to borrow from abroad.

On interest-rate developments in South Africa, Mr Horwood doubts if long-term rates will rise further, but there may be further rises in short-term rates.

"Higher interest rates in South Africa — which are now more realistic than they were a few years ago — suit us as a factor in the drive against inflation."

Inflation was still too high and "we remain determined to bring it down." Evidence from the last three sets of cost-of-living statistics indicated there were "hopeful signs" for the fight against inflation.

The Minister told British journalists that the South African economy was still strong, and that the country was expecting a positive growth rate this year.

Other points from the interview included:

- Since the introduction of the financial rand there had been equity investments through this medium of from R800-million to R900-million.

- The private sector continues to invest heavily in South Africa, suggesting they have a positive view of the country's economic prospects.

- The Reserve Bank was feeling more confident than it was six months ago that it had the money supply under control.

- Mining companies were still toying with the idea of selling gold on the futures market, and from a foreign-exchange control point of view there would be no barriers to stop them.

## DOLLAR DOWN

THE US dollar, which has reached lofty levels with support from high American interest rates, turned in a mixed performance yesterday, despite moves by several major banks to increase their lending fees, reports Sapa-AP from New York.

While the dollar reached a three-year high against the British pound, it fell from its post-World War 2 record high against the French franc and also lost ground to several other major currencies.

After most European currency trading had ended for the day, Chase Manhattan Bank of New York raised its prime rate to 20.5 percent from 20 percent, and was followed by First National Bank of Chicago.

PLANNING  
REGIONAL  
URBAN

...sions  
...ectively.  
...e third, fourth &  
...uilding Economics I,  
...dent in each of

...ctice.  
...s in  
...obtaining  
Quantity  
the Western

...tudy.  
-round student

(Cont'd)  
SURVEY  
QUANTITATIVE

# RAND RATE CHECKS LOSSES ON GOLD

**A SOARING dollar, which rose to its highest level against the rand this week, has cushioned South Africa from a big loss of revenue from the plunging free market gold price.**

The State collected R6 868-million, 52 percent of its revenue, from the gold mines in 1980, and

this could be cut drastically this year.

From an average of 614.36 dollars an ounce last year the gold price now stands around 414 dollars. Since January, gold has dropped by almost a third or 185.50 dollars.

The strong United States dollar, however, means the gold mines, like other exporters, get more rands from dollars earned.

The rand's rate against the dollar has dropped

from a January 6 peak of 1,347.5 to 1,115.3 yesterday, reflecting a 21 percent rise by the dollar.

The dollar, worth 74 South African cents on January 6 is now worth 89.6c, which represents a 17.4 percent decline in the rand.

As a result gold, priced at R444.71 an ounce on January 6, has dropped only R78.74 or 16.6 percent, which is far below the fall in dollar terms.

## No interest

The sharp rise of the dollar has been fuelled by near-record American interest rates which are higher than the inflation rate and provide an incentive to switch invest-

ments from gold, which earns no interest, to dollars.

Mr Brian Kantor, senior lecturer in economics at the University of Cape Town, described the lower gold price as 'clearly harmful' to South Africa. A higher gold price in dollar terms would have meant the country could have imported more and enjoyed a higher standard of living.

## Lower growth

'With 600 dollars an ounce South Africa could have long-term growth in the economy, but 400 dollars is a third less than that.'

The current price, however, was not low by 1979 standards.

Mr Sid Sharp, a deputy manager in Barclays' foreign exchange depart-

ment, pointed out that though the dearer dollar would make imports dearer, the country's imports would drop considerably with a lower growth rate this year and next.

## Mining

Mr Attie de Vries, deputy director of the Bureau of Economic Research at Stellenbosch, said falling gold revenue would affect the mining industry and Government finances.

'The Government will probably become much more conservative and not stimulate the economy further.'

The lower gold price would also have a depressing psychological effect on business just as the high gold price had brought optimism. People would become scared and more hesitant.

# Offices out of centre is trend for city

**By Vincent Leroux**  
**DECENTRALISATION.**  
— A major feature of office development in Johannesburg during the 1970s — is likely to be an equally important trend in Cape Town's business development in the 80s, property consultants say.

Gone are the times when agents spent their time canvassing companies to offer them special deals on floorspace in the city.

Today, with office space in Cape Town in short supply, accommodation headaches are now the lot

of the prospective office tenant.

With so little space available in the city, businessmen and professional men are being forced to look south to Claremont, Rondebosch and Pine-lands, where a number of new office developments are being built or are in the pipeline.

## MARCH 1982

The most important of these are the Pick 'n Pay centre in Claremont, the Checkers centre in Rondebosch, both of whose office blocks will be available in March 1982, and

the proposed Lonsdale Park development in Pine-lands, which will be completed in 1983.

Collectively the low rise office blocks of these three centres will offer close on 8 000 sq m of office space. A number of other developments are being considered in Mouille Point, Rosebank, Constantia and Rondebosch, which if undertaken will help soak up the expected increased overflow of tenants from Cape Town's central business district.

Although decentralisation has become a necessity, **Continued on Page 2.**

# Trend away from centre

From Page 1.

ity, it has also become for many businesses a preferable choice, offering a solution to traffic jams and parking problems, improved working conditions, and for some, closer location to workers' homes.

## BIGGER USER

A leading city property consultant, Mr Michael Divaris, said: 'Decentralisation is particularly appealing to the bigger space user who is not bound by the nature of its business to be located in town.'

Rentals of new office space in the suburbs were extremely competitive with comparable space in town. Office space in the Checkers and Pick 'n Pay centres, for example, was being offered at around R8.50 a sq m.

The big question regarding the decentralisation of Cape Town business is what effect it would have on the present CBD if it were to gather momentum.

R600  
R550  
R500  
R450  
R400

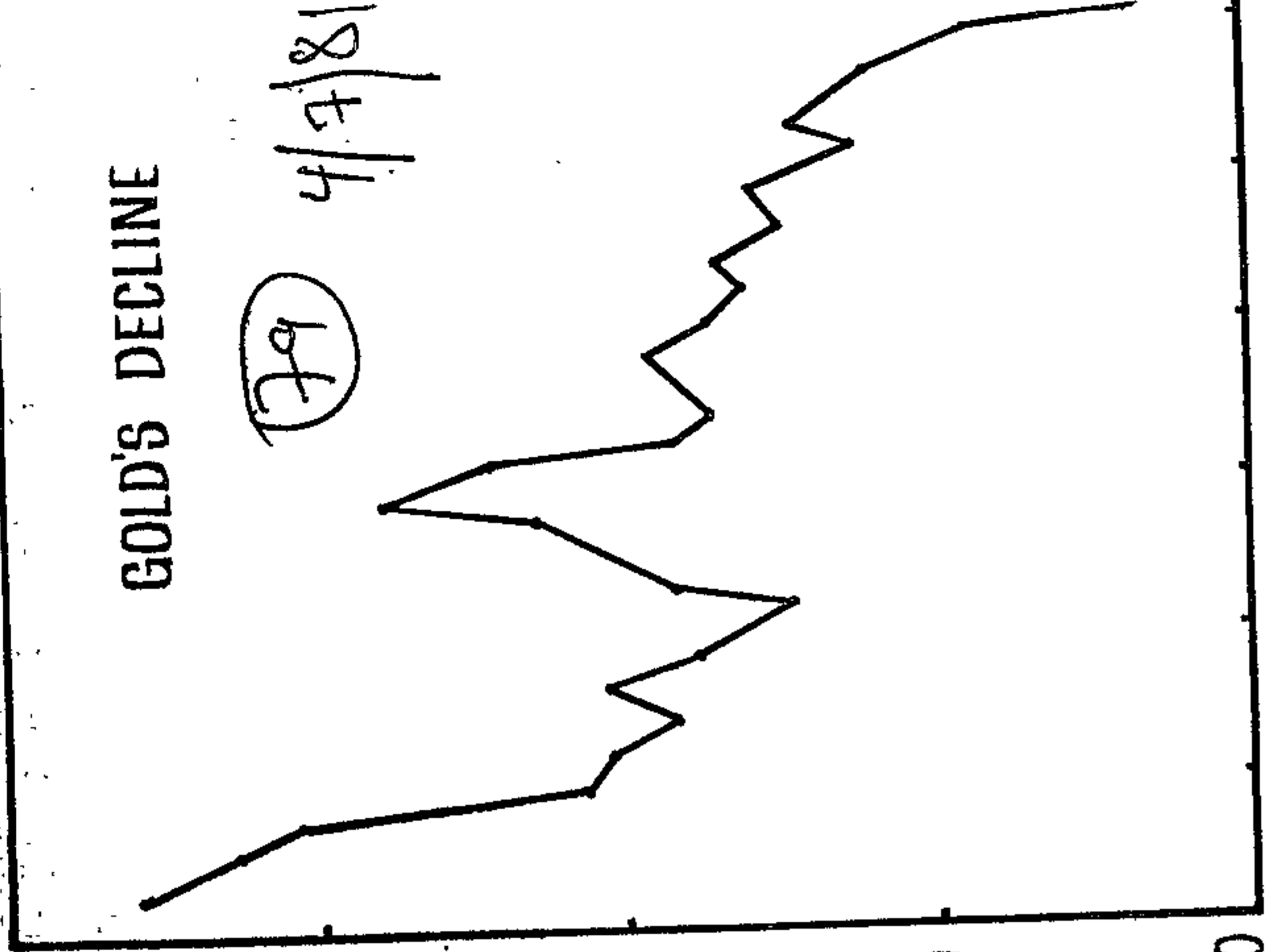

JAN '81 FEB. MARCH APRIL MAY JUNE JULY '81

GRAPH shows the ups and downs of the gold price as measured by the London closing price since January. Yesterday it closed at 414.75 dollars. South Africa now sells 70 percent of its gold on the Zurich market and only about 20 percent on the London market.

**Political Staff**

GOVERNMENT financial planners are preparing for a balancing act as the drop in the gold price continues reducing the flow of money into State coffers.

But informed sources said today they regarded as unlikely at this stage that the Government would resort to extraordinary tax increases as an alternative source of revenue.

The financial planners' main consideration appears to be the lagging consumer spending, which is already having effects on the economic situation.

However, the drop in the gold price appears to be fast ruling out the chances of tax cuts to relieve pressure on producers and consumers.

The Government might also look at its own spend-

# Govt ready for gold balance act

*Angus*  
8/7/91  
79

ing as a way of making up for lost revenue.

'All these matters will have to be taken into account and be weighed up carefully to see what can be done,' one spokesman said.

At the same time it was pointed out that the Government had not been caught totally unawares, as its financial planning was consistently based on

a lower gold price rather than the price at a specific time.

Also, most of the mines had already paid taxes based on the income they received when the gold price was at its high levels.

The Minister of Finance, Mr Owen Horwood, returns from overseas tomorrow and is expected to give some ind-

cation of how he sees the implications of the drop in the gold price.

An Opposition spokesman of finance, Mr John Malcomess, Progressive Federal Party MP for Port Elizabeth Central, said he doubted whether the situation had been reached where the Government would have to seek other sources of revenue to make up for the losses in its income from gold.

### BUDGET SHOCK?

He believed the main aim of the Budget should be to slow the inflation rate.

However, the Government has surprised the nation in the past, such as by its substantial increase of the price of petrol and steel, and he did not put it beyond the Minister of Finance to spring other surprises in the Budget.

GOLD

# The tussle goes on

79 FM 10/7/81

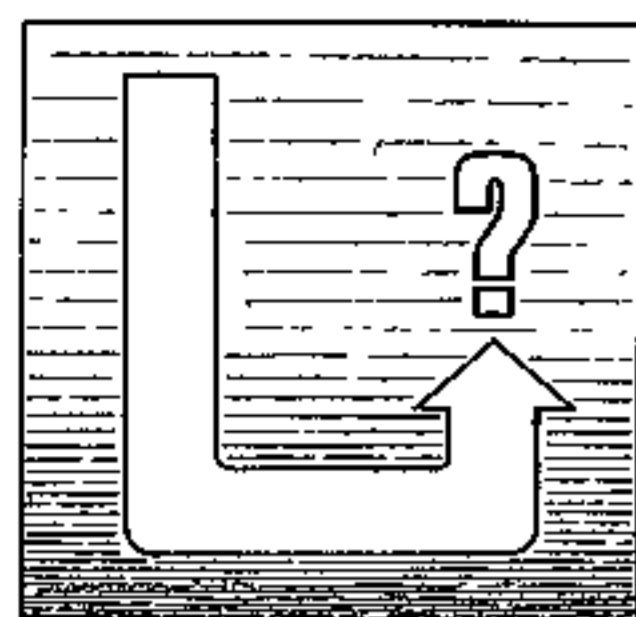

Differences of opinion make markets. And as bullion probes the \$400 level, at the moment that is particularly true of gold. On the whole Americans are reasonably opti-

mistic; their European counterparts are increasingly bearish over prospects for the next six months; and in Hong Kong, dealers and investors are adopting a wait-and-see approach.

As events in America are the prime factors influencing the gold price at present, let's first look at some of the optimism coming from the other side of the Atlantic.

Gold in the New York commodities markets fell to its lowest levels since 1979 this week. On Monday the gold contract for July delivery fell \$13.10 to \$399/oz, the lowest price since November 27 1979.

Nevertheless, gold dealers and analysts there keep looking for an upturn in the price. Dow Jones quoted one anonymous trader as saying about the Monday decline: "Technically it looks just horrible. But it is just another psychological number. The market has been fairly dull in post-holiday trading and will probably remain so this week."

And after that? The consensus is that gold has bottomed out and once interest rates start to drop — taking some of the lustre from the dollar — then gold will rebound.

Not that gold cannot go lower. New York traders see nothing magic in the \$400 price, saying that if it breaks below \$400, the next technical support level could be as low as \$350. Indeed, some international dealers see any gold price rise tied to a revival in industrial demand. Degussa AG has issued a forecast from Frankfurt saying gold prices will continue to fall as industrial demand declines over the Northern summer and as investors are drawn elsewhere by higher interest rates internationally.

In its June review, Degussa said that Opec countries have cut back on their gold purchases as the oil price and production declines cut into disposable income. Gold prices dropped 13% from \$483.25 to \$421.50 between June 1 and June 30 on the London fixing. At that price range, Degussa concedes that some central banks could be moved to purchase gold during July, but notes that this will depend on whether and to what extent the price continues to decline.

On the more enthusiastic side is Howard Ruff, the American financial adviser who specialises in "survivalist" invest-

ment strategies for the American who believes the apocalypse is nigh. Ruff is a long-time gold bug who startled the fraternity last winter by recommending his followers to sell their gold.

"I'm thrilled to death that gold has been going down. I feel professionally vindicated because I've been predicting that gold might go as low as \$400. Right now I'm cheering for lower, lower, lower. I sent out a buy signal last week at \$450. My point for throwing caution to the winds is \$400. I'm buying now and I think the risk-to-reward ratio will be irresistible at \$400. We could see as low as \$375, but that would just give us another marvellous opportunity to buy. Gold will go to \$2 000/oz sometime in the Eighties. If the next round of inflation hits 25%, we'll have \$2 000 or \$3 000 gold easily."

Less ebullient but more generally respected by trading professionals is Charles Stahl, publisher of the authoritative *Green's Commodity Market Comments* newsletter. "There are too many bears around. I haven't talked to a bull in a long time. I'm a believer in the contrary-opinion theory. When the majority of people have a fixed idea about what a market will do, usually the opposite will happen. So this week I bought gold futures contracts."

Looking to the broader view is Thomas W Wolfe, the Washington-based economist who advises major gold traders. Wolfe told the *FM*: "I'm not as sure as some

that a big drop in US interest rates will produce a big boom in gold's price. Nevertheless I look to the US economy taking one of two courses between now and 1982, either of which is likely to have a bullish impact on gold. One is that economic expansion will resume after this summer's slowdown and that will put demand and price pressure on all basic commodities including gold.

"Two, if the stagnation continues with a sharp rise in unemployment into next spring when we have our congressional elections, either the Reagan administration or the Congress may back away from the current austerity programme and we will see a rebirth of stimulation, inflation and rising attractiveness for gold.

"There are two other factors that may affect gold in the year ahead. One is the US Gold Policy Commission which must report by October on whether the US should move to greater dependence on gold as a monetary instrument . . . The second factor is whether major central banks resume large-scale purchases of gold again. During 1980, world central bank net purchases of gold topped 6m oz, or about 20% of world demand. This year, official gold dealings are at best neutral and may have edged to the sell side. The New York Fed reports nearly 2m oz sold off by various client central banks in January to March. But with the price this low, numbers of banks may be moving back into the market, sensing that gold

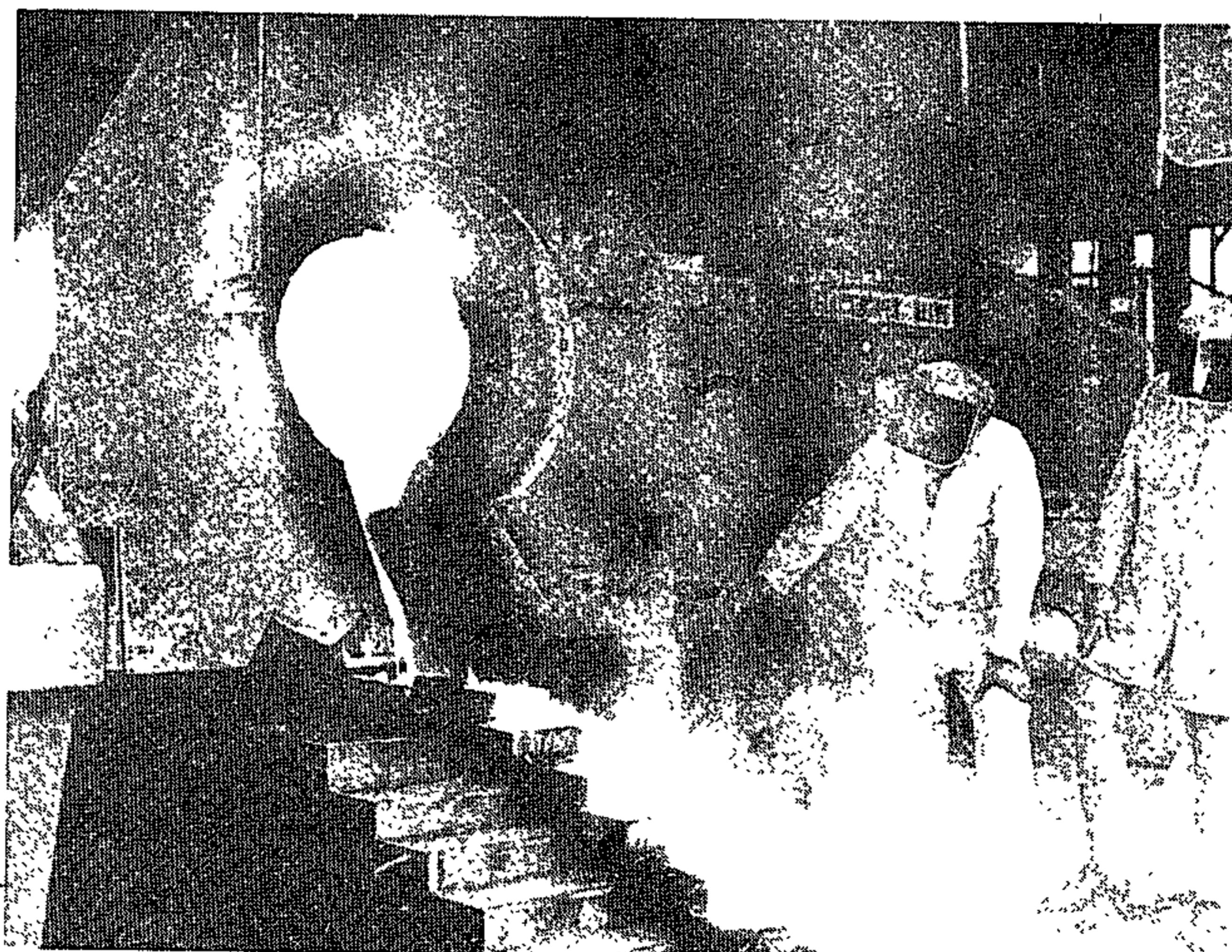

Gold pour . . . will it keep falling?

has reached the bottom of this cycle."

But there are different ways of interpreting economic indicators. So before we become too optimistic that a gold price recovery is just around the corner, what about the bears in Europe?

As one London gold dealer sees it, a major bear factor is that gold's price has been falling on small trading volumes. And that, he believes, means there is still considerable downside risk. The price could hit \$250, particularly if investors attracted to real returns on US fixed interest stocks continue to believe that gold remains one of the dreariest games in town.

He makes the point that even if American interest rates decline, this should be accompanied by a drop in US inflation rates. They are in single figures now and could be as low as 6% by year's end. In effect, if American inflation falls, US interest rates can move lower without reducing real returns available in US money markets.

Adding to his argument, he points out that the latest Soviet five-year plan calls for ambitious grain production increases and expansion of Russia's animal herds. The grain targets, he feels, will not be met. The Russians will need to import grain to feed their animals and that will need to be paid for by sales of gold into a market characterised by slack demand. The net result: further downward pressure on bullion.

#### Short-term pessimist

That takes us some years down the road. For the shorter term, a London stockbroker, who has been pessimistic on gold for some months, sees little hope for the rest of this year. On a fundamental basis, he says that slack demand has been compounded by a faster fall in speculative purchases than the rise in re-stocking demand by the jewellery trade.

There is, he says, something of a desperate battle going on around the \$400 level. And short-term investors have to ask themselves when or if we will see the final sell-off which characterises the final fling of most bear markets.

Another London broker warns against



**Economist Wolfe . . . near the bottom of the cycle?**

over-optimism if gold rebounds off the \$400 level. A rebound, he says, will confirm that we still have a bear market ahead of us. To be solid, recovery needs to be slow and steady.

If anything he is a member of the pro-gold camp — not for the immediate future, but on a one-year or so view. While the market is quiet, it is easier for gold to drift downwards rather than move ahead. But many holders, he believes, are currently wondering whether it is worthwhile to sell now and, perhaps, run the risk of being unable to recover their positions at lower prices.

In Zurich, where the major gold dealers are generally averse to being connected with forecasts, a positive view is that the market is due for a technical reaction. This, says one Swiss banker, is the fourth bear market since the two-tier system began. And in each of the previous three, price falls were overdone. He adds that American sellers have, so far, been proved right, but that it is impossible to determine when they will start to cover

their positions. That may be soon if sellers fail to push the price decisively below \$400. "But who can tell?"

In any event, he underlines the theory that lower US interest rates are not necessarily bullish for gold if American inflation continues to fall. And he warns that Soviet sales could become a factor as some Comecon countries continue to struggle with balance of payments problems.

#### Well-balanced market

Further along Zurich's Bahnhofstrasse, another banker believes that the dollar will remain a worthwhile investment and gold depressed for at least six months. "The physical market is well balanced, but as it is easy to sell forward and the market is thin, the gold price is vulnerable."

While Ramadan affects trading in the Middle East, interest from that area is muted. The same is true in Hong Kong.

There, hoarders are waiting for the market to stabilise before committing themselves. As with other markets for physical gold, trading in Hong Kong is quiet. That, for the time being, seems to put a damper on some of the normal signs of near-term price improvement. The past week or so has seen mild shortages of physical gold in Hong Kong, while last Saturday, backwardation developed on the Chinese Gold & Silver Exchange. In other words, traders were obliged to pay interest for selling short.

Those conditions at a time of heavy demand would be very strong positive price signals. But it seems that gold will need to penetrate \$400 before Far Eastern buyers pile into the market.

Are we in danger of slipping into the belief that there is no way for gold but down? The idea seems to have taken hold in several of the major centres, at least as far as the next six months are concerned. But as another London stockbroker puts it: "When the market turns, it could be fast. At this stage investors should be thinking along the lines of selective gold mine investments. Temporary losses could easily be outweighed by profits before the year is out."

# Gold: 'SA can expect a deficit'

C.T. 10/7/8!

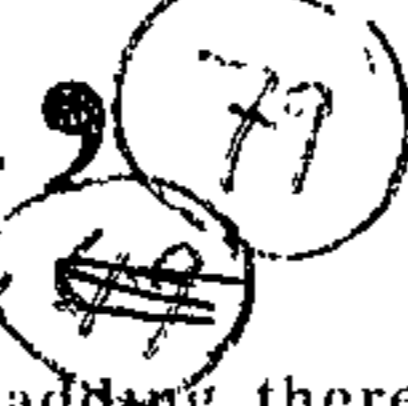

JOHANNESBURG — At the present gold price level, South Africa could this year expect a moderate deficit in its current account, the Minister of Finance, Mr Owen Horwood, said yesterday.

Speaking at a press conference at Jan Smuts Airport on his return from a two week European tour, he said he felt the main reason for the present easing off of the gold price was the very high interest rate abroad.

"This was especially so in the United States where there was a prime interest rate of about 20 percent.

"This means people holding gold may hope that interest rates will come down. But if they don't and they stay there for some time, as they have been doing, some people will eventually say it is about time they sold their gold and invested it where they can get 20, 21 or 22 percent on their capital, if not more."

Generally speaking, he did not think one could say the present gold price was a result of lack of confidence in the metal.

"I think it is a hard business view that is being taken in relation to the alternative income you can get if you release your gold and get the cash and then invest it at very high rates of interest.

"If interest rates are going to remain high, we may have to expect the price of gold to remain comparatively low."

"What it really means is that where the very high gold price, with other exports, gave us the record surplus in our current account, something like R3-billion last year, we will at this rate, I would think, certainly have a moderate deficit in our current account this year."

Mr Horwood, who visited Frankfurt, Bonn, Geneva, Lausanne, London and Paris, said he had come back very

encouraged, adding there was enormous constructive interest in South Africa.

"There is no doubt, talking generally, that the European economy is not in good shape."

## Unemployment

Great Britain's unemployment was 2.5 million, France's 1.8 million and West Germany's nearly 1.5 million. This was cause for considerable concern. Growth rates were very low and the immediate outlook was not very good. There were also balance of payments problems.

"With the slack in the economy, we will have to be more and more competitive to maintain our exports."

Referring to a statement by the French Government on Wednesday regarding nationalization of privately-owned French banks, he said general expectations were that large banks would be nationalized.

"But we have made it clear that we want business as usual."

## Interest

Mr Horwood said he found considerable interest in the idea of a constellation of Southern African States, the proposed multi-national bank and the small business corporation.

As far as the development bank was concerned, he hoped the government could make an announcement soon.

Generally, South Africa's creditworthiness abroad was extremely high.

Although he did not go overseas specifically to obtain loans, there was no doubt that if South Africa wanted them, it could do so on better terms than for a long time.

"But we must take into account that the European economy is not in good shape" — Sapa

N  
li  
bi  
ci  
H  
H  
di  
A  
th  
ga  
la  
pr  
m  
bo  
la

**Finance Reporter**

HOW the pendulum has swung. It wasn't so long ago that it seemed as if the gold price would never stop going up. We were being told that the rising gold price would be so good for the country.

And now we watch the price going lower and lower. But this time the news is not so good because a lower gold price means a lower growth rate.

We haven't yet been warned, but if gold should fall far enough in price and long enough in time, it could even be signalling the advent of a recession.

Thoughts of the tough times in 1976 with gold just above 100 dollars come to mind.

When gold fell from just under 200 dollars in December 1974 to 103 dollars in August 1976, the authorities devalued the rand in June 1975 and again in September 1975 in a "pegged" rate system.

Now the rand floats and the rate changes daily. This has had the effect of cushioning the decline in the gold price as can be seen in the accompanying chart.

In September last, gold was trading around 700 dollars with the rand/dollar exchange rate at 1,3285 giving an equivalent of around R525.

Since then gold has fallen by 42 percent but during this time the rand has dropped 17 percent to 1,0981.

The equivalent current price is therefore R370 which means that in rand terms gold has fallen only 30 percent. This gives a measure of protection to gold producers.

Gold has fallen from 466 dollars to 397,75 in just 11 days and is consequently in need of a rise in price to correct this sharp fall.

# Gold

**How the floating rand helps the mines**

*S. Tribune  
12/7/81  
79*

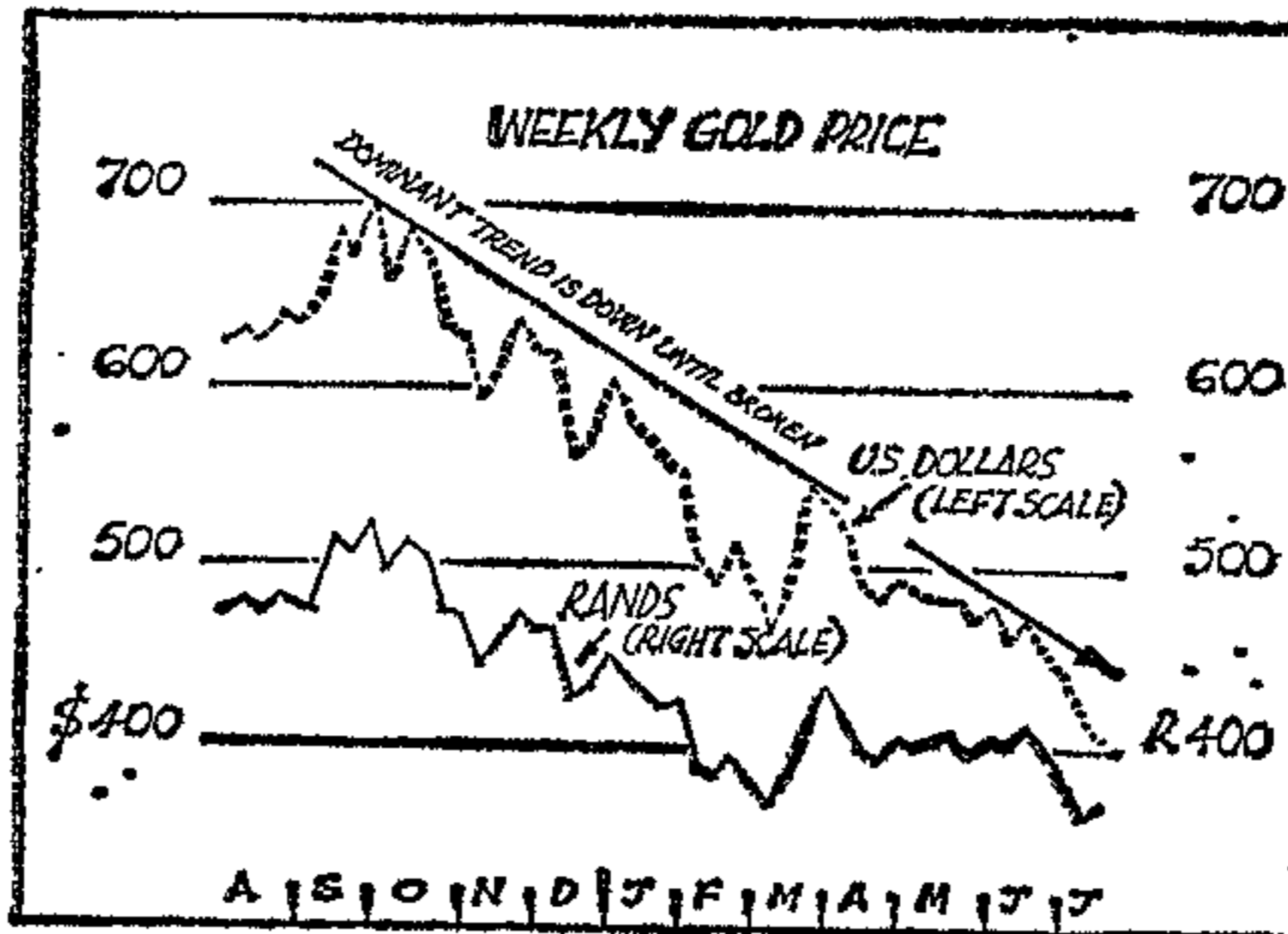

**Down, down, down . . . gold on the slide**

It is possible that the rally could push gold above 420 dollars in the next week or so. After that it could decline to around the 370 dollar level.

In the longer term, we cannot rule out the possibility that gold could fall to the 250 level which was first mooted in Tribune Finance last year, and which would be the worst possible downside objective.

Cyclically gold is due to make an important

bottoming out in February/March 1982 which means that there is likely to be more agony than ecstasy over the next nine months.

There is, however, some consolation in the falling rand in that it has the effect of increasing the price of imports and reducing the cost of exports

This obviously has a very beneficial effect on the balance of trade by curbing the demand for exports until such time as the pendulum swings back again.

No. 1501

17 Julie 1981

WET OP DIE SUID-AFRIKAANSE RESERWEBANK,  
1944

**BEPALING VAN STATUTÊRE GOUDPRYS**

Hierby word bekendgemaak dat die Minister van Finansies kragtens artikel 17A (1) van die Wet op die Suid-Afrikaanse Reserwebank, 1944 (Wet 29 van 1944), alle goud van die Suid-Afrikaanse Reserwebank met ingang van 30 Junie 1981 teen R352,47 per ons suwer goud gewaardeer het.

No. 1501

GA7662

17 July 1981

SOUTH AFRICAN RESERVE BANK ACT, 1944

**DETERMINATION OF STATUTORY PRICE IN GOLD**

It is hereby notified that, in terms of section 17A (1) of the South African Reserve Bank Act, 1944 (Act 29 of 1944), the Minister of Finance has valued, as from 30 June 1981, all gold of the South African Reserve Bank at R352,47 per fine ounce of gold.

79



# Low gold price hits housing industry in SA

5 times 19/8/81  
79

By Vera Beljakova

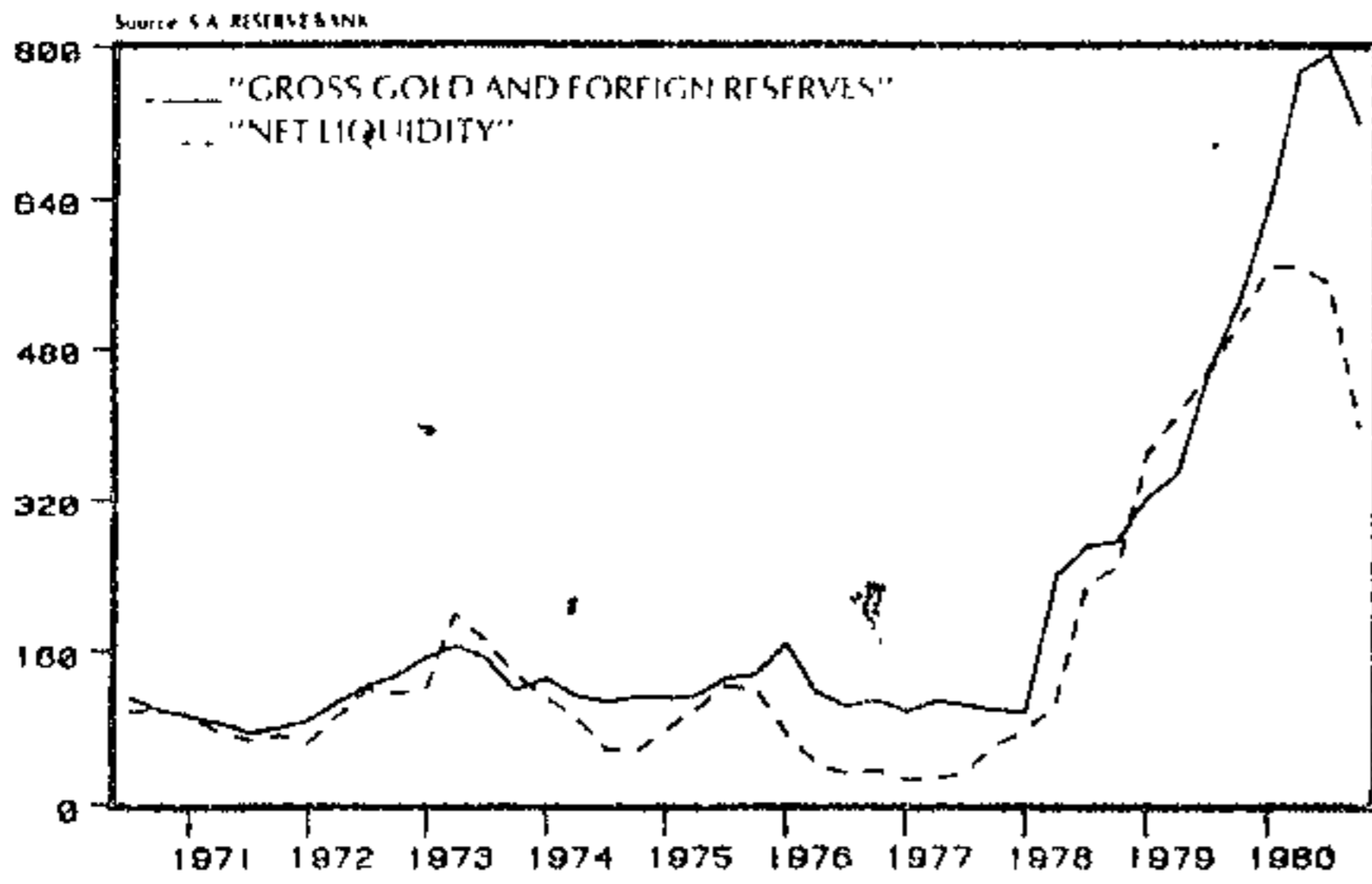

THE relationship between the gold price and the demand for homes is more than psychological

There is a direct cause-and-effect relationship between the gold and the foreign reserves and the net liquidity of building societies, which in turn finance home purchases.

"As there is a correlation between the gross gold and foreign reserves and net liquidity of the building societies, it is not surprising that the flow of funds into these societies has been partly stemmed by the fall in the gold price," states The Property Economist

Since the drop in the gold price, mining and financial houses have suffered a severe cutback in earnings as opposed to early 1980, when the high gold price swelled the coffers almost to bursting point

Prevented by Exchange Control regulations from investing overseas, these institutions had little option but to lodge their growing funds in local investment vehicles — and a large portion went to the building societies

A graph shows the 10-year cycle (1971-1981) of South Africa's gross gold and foreign reserves and the net liquidity of all the building societies.

"But a gold price of around \$400 dampens the enthusiasm

for investment in major sectors of the economy which has the spin-off effect of a reduction in job opportunities," claims The Property Economist.

"Fewer jobs, coupled with a net immigration of 30 000 people forecast for 1981, may create short term limited unemployment prospects."

Certain home builders, who tend to over-react during boom/gloom conditions, will lack the confidence to continue building despite the immigrant market demanding over 700 homes a month during 1981, predicts the survey's editor, Neville Berkowitz.

He also feels that homes should be built not for this year or next, but for the predicted economic upturn of 1983-1984.

He concludes, that the expected eventual gold price recovery will bring with it renewed consumer confidence together with an increased flow of money back into building societies.

"Bearing in mind, however, the 26% a year building cost escalation, home-owners should start building their homes now, rent them out and wait for the upturn in 1983"

BRIEFING

# Secret lever in the gold price

for 22/7/81 (79)

By George Milling-Stanley  
of the Financial Times, London

LONDON — There is obviously no means of assessing accurately the amount of gold that has been mined since man first fell victim to the yellow metal's allure, but most experts seem to agree that a figure of 100 000 tons would not be too wide of the mark. With some 30 000 to 40 000 tons of this known to be in official reserves around the world, that would appear to leave something over 60 000 tons in private hands.

Of course, much of this gold has been lost completely, while a considerable amount is lying at the bottom of the sea in what remains of wrecked ships.

At a recent conference in London's Goldsmith's Hall, Mr Dennis Etheredge, head of the gold and uranium division of Anglo American Corporation of South Africa, the Western world's biggest single gold producer, touched on this subject. He pointed out that even much of the gold on dry land is not in a form which would make it readily available to the market.

He also expressed his continued surprise at the fact that around 70 tons of gold goes into people's teeth every year, and is thus unlikely to come back on to the market.

Nevertheless, there is a significant amount of gold in various forms in private hands around the world, perhaps as much again as is currently known to be held in official reserves. Certainly, the amount of gold overhanging the market is large in relations to current Western world output of under 1 000 tons a year.

This gold is mostly in the form of bullion, coins, jewellery and industrial products of one sort or another, and it represents a significant depressing factor at times of rising prices. There have been two major price advances over the past 10 years, and sales from the private sector, or "dishoarding," played a substantial part in halting them both. These sales also contributed to the subsequent heavy falls in the gold price.

It now looks as though dishoarding will play a major role in the course of the gold price in the future, and Mr David Potts, chief gold analyst with Consolidated Gold Fields, has said that it could be one of the factors

which will delay for several years what he regards as the inevitable march of the bullion price beyond the 1 000 dollar an ounce mark.

There was one major difference between the two big shake-outs of the past 10 years. When gold peaked at 197 dollars in the mid-1970s, the International Monetary Fund and the US Treasury were both conducting big selling programmes which did at least as much as sales from the private sector to depress prices.

In 1980, however, when gold reached its all-time high of 850 dollars, sales from the official sector were only a minor influence, thus increasing the importance of the role played by dishoarding. The Middle East and the Far East, excluding Japan, were the major sources of dishoarding during 1980.

The sort of price levels which would lead to dishoarding on a similar scale in the future are difficult to predict, as they are related to the prices at which individuals bought their gold.

One thing is known for certain — dishoarding in 1980 began much closer to the eventual price peak than in the mid-1970s, and this is probably because many people had bought gold close to the top of the previous cycle, after being attracted into the market by the enormous publicity the gold price was receiving at the time. It is probable that something similar happened in early 1980, which suggests that the 800-850 dollar level of the next upward cycle will cause a sizeable shakeout as people who bought close to that level on the last upswing take what profits they can.

Experts seem agreed that the US will become the main component of private sector investment in gold during the 1980s, as inflation rates remain high despite the determined efforts of governments to reduce them. This would mean US citizens taking on the role played in the past by the buyers in the Indian subcontinent, France, and more recently West Germany.

Again, it is impossible to forecast what effect this will have on the bullion price. It is likely to remain volatile, however. To quote Mr Etheredge once more: "If even 1 percent of the money in US pension funds were invested in gold, it would be enough to tear the market apart."

Chas. McCarthy & Sons Building  
Prize  
Awarded to the final year student  
obtaining the best combined marks  
in Building Construction III & IV.  
M Yeats  
The Murray & Stewart Building  
Management Prize  
Awarded to the final year student  
wishing to proceed to postgraduate  
study who is judged to have  
produced the best overall results  
in the final year of building.

BUILDING  
(Continued)

# GOLD

80  
22/7/81

79

Gold has dipped well below half its peak price of eighteen months ago, a degree of fluctuation which qualifies it to be described as a volatile commodity. For all that, it has remained closely held in the vaults of the world's central banks — although price swings have lessened its appeal to individuals as a refuge against inflation and other ills.

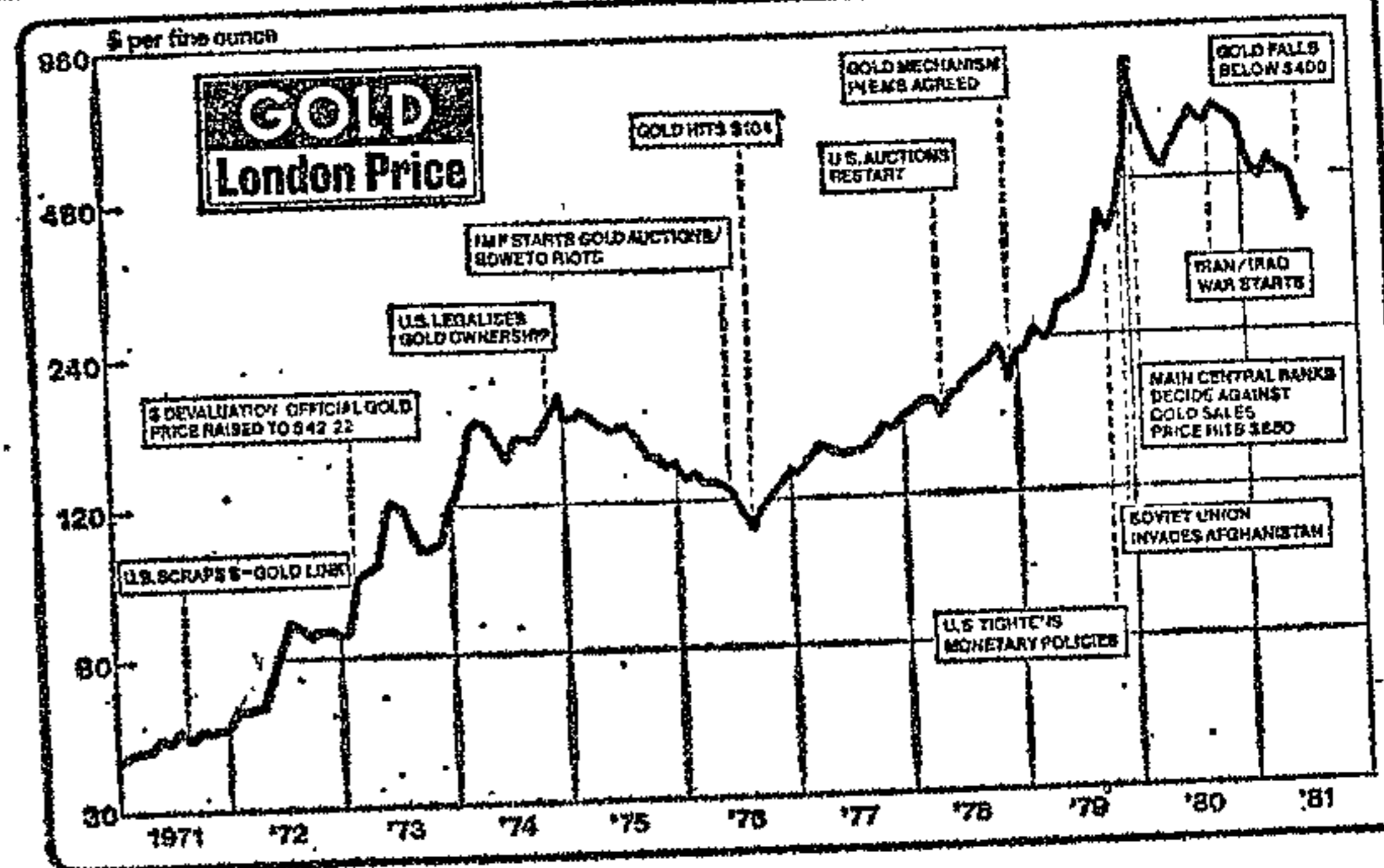

By David Marsh of the Financial Times of London

LONDON — The first law of the market-place—that what goes up nearly always comes down, invariably with a bump—has never been better demonstrated than on the international bullion market during the past 18 months.

In January 1980, in the fevered aftermath of the Soviet invasion of Afghanistan, some of the wilder gold-watchers saw the price explosion to 850 dollars per ounce as the springboard for a jump to 1 000 dollars and beyond. Sentiment has now turned completely, with the price collapsing to around the 400 dollars level this month — a product of an easing of political tensions, the sharp recession and, of the dollar, backed by record US interest rates, on the foreign exchanges over the past year and a half.

The price swings have emphasised once again the metal's sensitivity to the way the international investment community reads the pattern of world tensions. But gold has also been thrust into the political limelight for another reason.

At a time when the bullion price is being swayed as never before by pundits who form their judgments based on a mixture of fear, greed and mythology, it might be thought that the international monetary importance of the metal would be ebbing. In fact the opposite is the case.

Central banks and official institutions from the oil exporters and other developing countries have become

heavy purchasers of gold during the past two years or so, seeking to ape the old-established central banks in the West whose large gold holdings (even at the reduced price) make up the lion's share of their reserves.

If this were not enough to confirm that the metal has undergone a monetary renaissance, the industrialised countries too, while not buying, now see their gold stocks hoarded over the years as being too valuable to sell. Despite the clearly exaggerated price rise last year, which offered sizable profit opportunities to gold-owning countries in the West needing balance of payments finance, only Canada was either quick-witted or courageous enough to sell part of its holdings.

Instead, attention switched to the "invisible" ways of using gold to help plug payments deficits — either through collateralisation (in an explicit or implicit sense) or, within the EEC, through the mechanism which turns countries' gold reserves smoothly and painlessly into European Currency Units.

The absence of sales by the US Treasury and the International Monetary Fund last year (the IMF too thinks its remaining stocks of 3 200 tons will come in useful to back any commercial loans it may have to raise) was an important factor supporting the price last year.

Smaller countries in desperate financial straits from time to time had to turn to the last resort of gold sales (the most recent publicised

example is Costa Rica). But the combination of developing country purchases and the industrialised world's refusal to sell was a net increase in overall world official gold stocks last year for the first time since 1972.

Contrasting with heavy-selling by the private sector, official stocks could show another increase this year. The last word in this saga, of course, has not yet been written. The gold price could indeed recover, justifying the investment decisions by those Opec members which channelled large chunks of their oil revenues into the yellow metal last year.

Some of the more quixotic oil exporters, particularly Libya, would also argue that their purchases lately have been dictated not so much by the expectation that the price would rise as by a desire to buy an international asset that can be kept safely at the home central bank's vault free from possible Western interference.

All the same, an interim summing up of the state of play would be that the private gold owners around the world who have been heavy sellers of hoarded metal during the past 18 months have got their timing right — and the central banks have got it disastrously wrong.

There has been a sense of *deja vu* about the volatility of the past 18 months. The fall has been of an order of magnitude similar to the price collapse from close to 200 dollars at the end of 1974 to just above 100 dollars in autumn 1976. However, the gyrations this time

round have been more acute. The latter period has encompassed two spells (January to March last year and September 1980 to July 1981) each containing price falls of about 45 percent in dollar terms (although, because of the dollar's strength, the latest fall has been only 28 percent measured in Swiss francs).

These enormous price swings — which look likely to set the pattern for the foreseeable future — are due to a combination of factors. The first is the sheer size of the worldwide market, in which the number and breadth of participants has increased dramatically during the past few years.

Apart from the much greater role of Opec investors (both buying and selling), other new influences include the growing investment importance of gold in Japan, the entry into the market of more institutions and commercial banks (the most notable example has been Morgan Guaranty) and the active two-way trading — and sometimes outright speculation — carried out by a handful of Third World central banks.

Second, the futures markets, now established not only in New York and Chicago but also in the Far East and Sydney, and soon to be complemented by London, have become at times more important than the physical markets in determining price movements. Heavy trading in silver futures during the Hunt affair in 1979/80 — and more recently during the slide at the end of June and earlier this month — has also tended to spill over

into increasing volatility in gold. On the whole, though, volume on the US futures markets has been a good deal lower during the past year or so compared with the levels at the height of the Hunt manoeuvrings — although there are signs that it is beginning to pick up again.

Third, and most intriguingly, the big gold producers have become more sophisticated at playing the market themselves. South Africa and the Soviet Union have both swung through the same changes in financing needs during the past two years and also — whether through accident or design — tend to run their sales policies broadly in tandem. These factors together have tended to sharpen both the upward and the downward movements in the gold price.

Crucially, both the world's top two producers look likely to run current account deficits this year after being in the exclusive club of surplus countries during 1980. Their need to sell gold will increase as a result. This sets up a vicious circle (from their point of view) in which the price is pushed down by producer selling, thus increasing the volume of gold needed to be sold for the same quantity of foreign exchange — which pushes the price down still further.

All this is in contrast to the situation last year, when both countries were able to withhold significant portions of their production from the world market because of their healthy financial positions. South Africa has already admitted that

it is likely to sell all its production this year (last year it stocked up reserves by 65 tons). If the price fall continues it could even be forced to pledge some of its reserves by borrowing foreign exchange under gold "swap" arrangements with Swiss banks, along the lines of previous transactions carried out during the 1970s.

Soviet sales through Zurich seem to have been quite appreciable a few weeks ago, according to Swiss bullion dealers, although they have dried up during the recent sharp price fall. Soviet sales last year were believed to have been 80 to 100 tons — the lowest since 1971 — but seem likely to increase during 1981.

Information about exactly what Moscow is doing has become harder to gather since Switzerland stopped publishing customs statistics on gold movements at the end of last year. This followed a similar decision in 1977 by the British authorities stopping publication of UK gold import figures. Since February this year British gold export figures too have remained unpublished because of the civil service dispute.

Having fallen steadily since its high point of 720 dollars last autumn on the outbreak of the Iraq-Iran war, gold has failed to rally in spite of the successive crises over Poland, Syria and the Israeli raid on Iraq. Analysts have two explanations. Either gold these days is more sensitive to the Reagan Administration's resolve to screw down inflation than

to political developments or else the freeing of the American hostages in Iran and the slight improvement in East-West relations have outweighed the worsening of strains elsewhere in the world. Of the two, the second is more convincing.

With commercial and investment buyers around the world currently waiting to see the price go a little lower before they resume purchases, and even one or two of the new-found gold enthusiasts among central banks now starting to show more caution, the end of the bear market is not yet in sight.

Even Far East investors, who were an important source of physical demand in the first few months of this year, now seem to have become less active.

Demand is only likely to pick up again once US interest rates demonstrate a clear downward trend — which has been the unfulfilled hope of investors, borrowers and central banks around the world for more than a year now.

Meanwhile, sorry-eyed bullion buffs looking for that magic 1 000 dollar level surely do not need reminding that they already have a risk-free opportunity to double their money in five years — simply by investing in US domestic bonds, currently yielding 15 percent.

INSIDE  
BACK PAGE

Secret lever in the gold price

# Gold <sup>5/10</sup> saves <sup>24/7/71</sup> export totals <sup>7/7/71</sup>

By David Bamber

South Africa's minerals exports during May were more than R23-million higher than the previous month despite falls in many sectors.

The saviour, once again, was gold with exports which rose R33.2-million from R622.5-million to R655.7-million.

Silver earnings crashed from R9.1-million to R1.6-million but according to the Minerals Bureau, the slump was the result of irregular deliveries and can be expected to show a healthy gain when the June figures are published.

## SIMILAR

A similar situation arose in both iron ore and manganese exports, leading to earnings falling R8.4-million and R6.5-million to R13.6-million and R5.7-million respectively.

It is a different story when it comes to diamonds where the massive fall from R14.1-million to R4.9-million is a direct result of De Beers' diamond marketing policy.

De Beers has been withholding most of its gem production from the market due to weak demand but this time round also seems to have withheld industrial stones.

## BRIGHTER

On the coal front, however, there is a much brighter picture. Coal production rose from 9.9-million tons to 10.4-million tons and exports earned the country R89.4-million compared with R70-million the previous month.

Copper exports also increased, rising by R2.5-million from R6.9-million to R8.6-million.

Total sales' values reflect a fall in domestic consumption to R164.8-million from R182.2-million while export sales' values are estimated at R893.4-million compared with R870.2-million the previous month.

# SA's economy still rests on a golden foundation

JUST how reliant the South African economy has become on just one commodity — gold — is highlighted dramatically this week in the Volkskas Economic Spotlight.

In 1970, a boom phase in the economy (as was last year) R3 788-million was paid for the total goods imported and services provided. Revenue from the sale of gold paid 22,1 percent of this amount.

By MIKE PEIRSON  
Finance Editor

To afford her high goods imports in 1980," says the report. "The value of the rand would also probably have been very different.

So the hard facts are that the current account of the balance of payment would have shown a deficit of R6 459-million in 1980 alone if the same amount had been earned from gold sales in 1980 as in 1970. "If the gold price had not risen South Africa would have been unable

total revenue of R14 288 million. In percentage terms tax paid in 1971 against total revenue was 4,9 while 10 years later it was 25,4.

This large fluctuation in gold mine tax is of particular interest and for the economic policymakers it is both a blessing and a problem. "It has the advantage," explains the report, "that at times when the gold price — and thus gold mining profits — rise sharply, a larger proportion of the profit

accrues to the Treasury. This can facilitate control over the increase in the money supply.

"On the other hand, tax revenues from gold mines fall particularly sharply if the gold price should weaken, as is the case at present. "Usually this places the Minister in a very thorny position because the deficit on the State accounts increases and measures have to be taken to correct this." As a result we are now faced with an all-time high bank rate of 12,5

percent after this week's shock announcement of a two percent hike.

There is no doubt South Africa has to put its economic house in order as quickly as possible so that it can fulfil its ambitious future development projects, many of which are already in the pipeline.

On the positive side there is no restriction on lending imposed on the banks. In the past a pegging policy has been a predominant factor. Now the banks still hold

the option and the onus is on the borrower to be prepared to pay the higher price for his money.

It is felt that pegging would only be used as an absolute last resort. Some manufacturers fear, however, that the rate move may have a negative effect on the investment mood.

While it was recognised that some dampening down of the economic growth was required, it would do little to encourage potential investors. One of the consequences would be fewer job opportunities.

There are certain encouraging features, however. For example, the Monetary Fund in its annual World Economic Outlook published this week (see page 5) forecasts only a modest recovery in output in the industrial world next year: a further rise in unemployment; and a slowdown in inflation on-ly to levels at least as high as in the 1976-79 period.

There are certain encouraging features, however. For example, the Monetary Fund in its annual World Economic Outlook published this week (see page 5) forecasts only a modest recovery in output in the industrial world next year: a further rise in unemployment; and a slowdown in inflation on-ly to levels at least as high as in the 1976-79 period.

However, "says the report", inflation must still be characterised as a severe worldwide problem. Slow (or, in some countries, negative) growth remains a key feature of the international situation and outlook."

(66'7) spearsroads (33'7)

significantly higher in Nqutu and Nondweni

The incidence of both mild and severe malnutrition living in Nqutu and Nondweni are shown in Table 1.

The results of upper arm circumference measurements 464 children living in Crossroads and 416 children

## RESULTS

children were seen on a door to door basis.

The areas were chosen at random and the township whilst 202 were seen from four different parts of Nondweni. 214 Children were seen from three areas of Nqutu

1976 and 1977 under the Group Areas Act<sup>3</sup>

...were resettled in

GROUP AREAS	CROSSROADS	NQUTU AND NONDWEINI
TOTAL	7,5%	1,2%
(Arm circ. < 12,5 cms.)	0,4%	1,2%
Severe Malnutrition	6,1%	1,5%
Mild to Moderate Malnutrition (Arm circ. 13,5 to 12,5 cms.)	464	416
Number of Children		

TABLE 1 : INCIDENCE OF MALNUTRITION AS DETERMINED USING THE SHAKIR STRIP

# Gold slump could force a harsher budget

Staff Reporter

GOLD slumped further to \$391,25 at the afternoon fixing in London yesterday in yet another unfavourable drift on the economic front before the introduction of the national budget in parliament a week today.

Economists are predicting a neutral package from the Minister of Finance, Mr Owen Horwood, while the opposition believes the tax-paying public is in for a harsh time.

And in spite of fairly intensive lobbying, there is little likelihood of concessions on either an exemption on basic food items from GST, separate taxation of married couples or income-tax concessions on home mortgage bond interest.

## Causes

Major factors inhibiting growth and accordingly restricting the minister's leeway options after three years of boom conditions remain a downswing in the business cycle, stubborn inflation expected to average about 15 percent this year, a slip from surplus into deficit in the country's balance of payments with the rest of the world, and a gold price less than half the peak reached last year.

Nobody at the Department of Finance has ever provided advance gold-price figures on which budget calculations have been based. But there can be little joy with yesterday's levels around \$390 an ounce on the London

market, compared with an \$875 price 19 months earlier.

The PFP's finance spokesman, Mr Harry Schwarz, believes the slump could cost the country R800 million in lost tax revenue during the first half of the financial year, prompting speculation that GST may be increased to make up the shortfall.

## 'Frozen'

Figures released by Mr Horwood indicate that the gold boom last year contributed to a R1 200-million surplus in the state's accounts for the financial year ended March 31st, all of which has been "frozen" in the stabilization account. Were it not for an alarmingly high, inflation-fuelling rate of growth in the money supply, these funds could be used as a cushion to unpopular measures, but the huge bread-price rise of last week is considered as good an indication as any of the authorities' determination to maintain discipline at the expense of popularity.

The experts, understandably mindful of being proved wrong on the turn, aren't keen to stick their necks out on specifics of what Mr Horwood will do next Wednesday. The prevailing mood, however, was simply: "If you're expecting something for nothing, forget it."

No real fireworks are predicted, if only because the financial year has just eight months to run and if the situation is going to get desperate, it hasn't done so yet.

judgment on a representative successful and about

3. Except sampling envelope but appear

samples use sample units.

2. Judgment then do

1. Accessibility or Haphazard Sampling: easiest possible sample is obtained usually the way. Some non-probability methods that are used are: sample estimates. They may be good - or they may be statements can be made about the bias or reliability of probability of selection and consequently no accurate Here sample units are not chosen with any known

# Gold and the Budget

Well, \$400 an ounce wasn't the bottom for the gold price, as we hoped it would be this time last month. It is now down to \$392 and it looks as if it might go lower. That must have implications for next Wednesday's Budget.

Two events this week suggest that in the months immediately ahead gold is not going to be in brisk demand. One was President Reagan's fiscal victory in Congress, which has enhanced expectations of a secure recovery in the US economy.

The other was Fed chairman Paul Volcker's statement that he intended keeping money tight for the rest of this year. That means US interest rates will remain high for at least the next three months.

At the time of the last Budget (March 1980), the price of gold was more than \$600. The national accounts were drawn up then on the assumption that the average gold price would be above \$420 over the fiscal year. That proved to be very conservative. For the calendar year the average price was \$614 — double the 1979 average.

Consequently, the amount earned by the Exchequer from gold in the year to March 1981 was R1 850m — more than double the R646m of the previous fiscal year — inflated last year by an artificially low rand exchange rate.

In the first six months of this year the average price of gold was \$504, yielding tax receipts from gold mines of R1 194m. So, even at a significantly lower average gold price for the rest of the year, the Treasury will not face a sudden shortage.

An important reason for the maintenance of Exchequer earnings from gold, despite the recent lower gold price, has been the decline in the dollar value of the rand over the past six months as the terms of trade have swung against SA. In the case of some mines, their rand earnings have thus actually risen, despite the downward trend in the dollar price of gold.

Assuming that over the next six months the average price of gold slides to \$350, and the rand declines to \$1 in value, Exchequer tax receipts will be in the region of R800m, bringing the total tax paid by gold mines to about R1 990m — about equal to last year's receipts.

But if, when the gold price was higher than \$600 and the economy extremely buoyant, Finance Minister Owen Horwood chose to base his Budget on an annual average of only \$420/oz, he is unlikely to be less conservative now, especially with the terms of trade swinging against us.

If he assumes an average gold price for the next fiscal year of \$300/oz, Exchequer receipts from gold mining taxes could be back to the R600m level of March 1979. And that, of course, gives him much less room to manoeuvre than the FM expected last week.

It means that the need to contain government spending is even more pressing. Inevitably there are going to be capital projects initiated during a time of plenty that cannot now be curtailed. As the chances are that, against this background, Horwood will be budgeting tax revenues conservatively next year, the deficit before borrowing is likely to rise quite substantially.

An important indicator to price stability will be the manner in which the deficit is financed. Transfers from the burgeoning stabilisation account will have an inflationary impact. This account is not, as accountants tend to regard it, a general reserve of savings to be drawn down when needed. It is an economic means of regulating the productive capacity of the country's assets.

The financing options open to Horwood are either to borrow more locally long-term, which would help to control the money supply, or tap foreign markets. Both locally and abroad his credit is good. But at prevailing levels of interest rates the cost will be high.

As the FM shares Horwood's view that the price of gold, notoriously difficult as it is to anticipate, will rise again sometime next year, it believes the higher borrowing costs are well worth the candle.

Therefore, without deviating from his admirable conservatism of the past, Horwood should continue to free resources from the public sector to the private sector. Nor should he allow inflation to erode the tax cuts of last year. As President Reagan pledged on US television on July 27, he should ensure that last year's tax cuts are made permanent through automatic annual indexation if necessary.

But that means, of course, it is equally essential that he keeps spendthrift bureaucrats in line. Because substantial credit lines are available, the financing balance can be shifted a bit, but not to the extent of a destabilising list.

In short, the sharply weaker gold price must be viewed with caution when estimating next year's tax inflow. But it should not cause a panic switch in budget priorities — provided official spending is held in tight check.

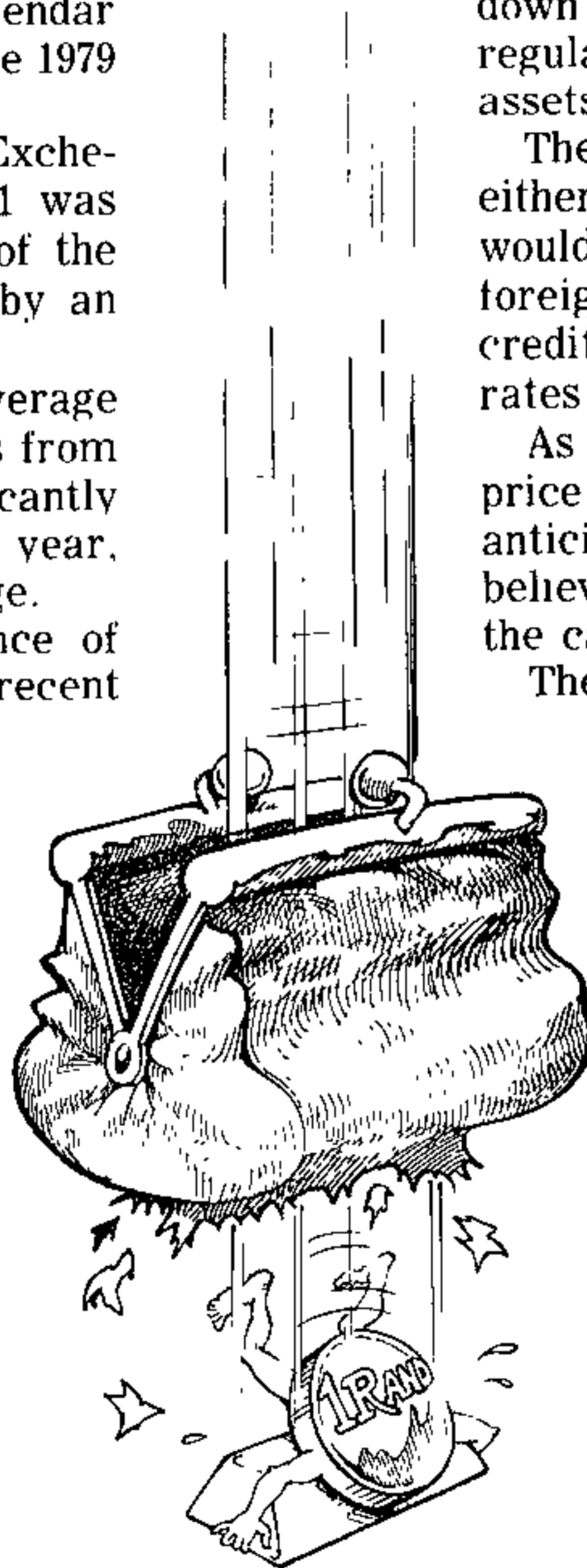

## GOLD PRICE

# Is this the turn? 79 FM 21/8/81

Is the present resurgence in gold (to \$434-37 at mid-afternoon on Wednesday) merely a technical aberration in a bear market, or is it that momentous event, a major turning point?

The factors working against a gold price rise at present start with the tight money policies of the US Federal Reserve Board, strongly backed by the Reagan administration. A succession of monthly money supply figures in excess of the Fed's strict target bands have meant the continuation of determined control, with little short-term relief in sight. These policies have driven up short-term interest rates to unprecedented levels. The best to be expected is for prime rate to have fallen to 16% by the year end, against the 20.5% at which it now stands.

High interest rates have made holding bullion an expensive business — a factor that triggered the recent sharp fall.

The longer term outlook for current US policies, however, is that they will succeed in "wringing inflation out of the economy." If this is indeed achieved, it could have further bleak implications for gold.

Another adverse factor is that US consumption of oil and imports has dropped and Opec is battling to re-establish a uniform and sustainable price structure. At least in the short term, inflationary pressure from endlessly rising oil prices has been reduced.

There are also some technical graphical indications, relating short-term fluctuations to the long-term trend line, which suggest the bottom could be as low as \$350.

### Demand recovery

The good news is that there are strong indications that industrial demand has recovered strongly — to an anticipated level of 900 t for 1981, according to sound overseas and local sources. Jewellery demand alone could come out at 450 t-500 t, and coins and medallions at 200 t-220 t. The manufacturing demand for coins was aided notably by a strong recovery in Kruggerand sales, possibly fuelled by investors wishing to get into the market at what could turn out to be a price floor. July figures, at 447 000, were the highest since December 1979 and the seven-month figure for 1981 was up by 32% on the previous year. The balance of aggregate demand is made up of technical uses like dentistry and electronics.

One local analyst says there are strong indications from the major European banks that bullion has made one of its

major periodic transitions. This one is from a phase dominated by speculative demand and the US future markets, with all their built-in volatility through stop-loss operations and leverage. The new phase reflects the dominance of the physical market where industrial demand finely balances the supply of newly mined gold and speculation is negligible. This pattern is reflected by turnover levels which are currently low, although the market may be reflecting a short-term upward kick which reflects the squeezing out of over-exposed US short sellers.

### Strong premiums

Prices on Middle East and Far East bullion markets, which reflected major discounts to London and Zurich at the peak, are now trading at strong premiums. This reversal suggests that dishoarding from those areas, which helped to put the cap on the bull market, has been replaced by renewed demand.

The FM finds the bullish arguments on balance more convincing. But this does not imply a repeat of the euphoria of 1979-80. What is to be expected is a sober market more solidly underpinned at around \$380-\$400. Upward movements from these levels should reflect a stable or slowly rising real price for gold plus corrections for any major currency ad-

justments. The continued relative stability of gold in other major currencies is encouraging (see graph).

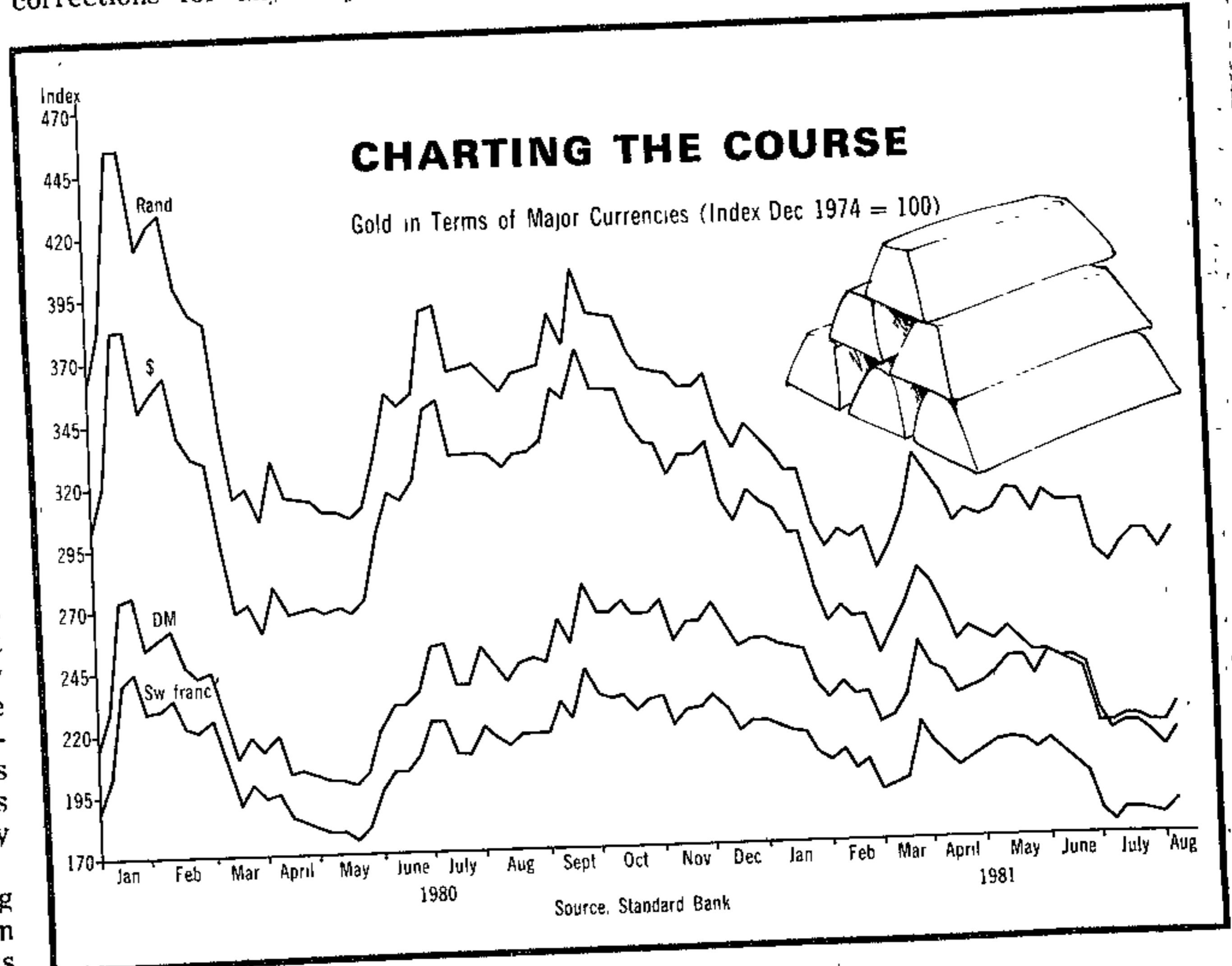



# A positive strategy for gold



Joel Stern is president of Chase Financial Policy, Chase Manhattan Bank, and a visiting professor at UCT's Graduate School of Business.

The price of gold is less than half its 1980 high, its price volatility since the beginning of the Carter presidency has exceeded the fluctuations in industrial share prices almost everywhere, yet modern financial economics emphatically teaches us that failing to include gold in our investment portfolio is suboptimal.

How is this conclusion possible? Rational investment management would appear to require a minimum exposure to gold. Yet the opposite is true. Stranger still, holding gold has nothing whatever to do with its price, nor the usual investment objective of "buy-low, sell-high." Excluding gold can reduce a portfolio's value at any gold price. Even more surprising perhaps, corporations would help their shareholders on a global basis by investing a fraction of their assets in gold.

This is the good news. The bad news is that gold bullion or coins are desirable, but gold shares are a distant second best alternative.

These conclusions are based on three fundamental principles of applied microeconomics in finance, one from corporate finance, the other two from investment management. The evidence supporting these principles comes from research covering 35 countries of the free world completed in April this year by Chase Financial Policy.

The first principle is concerned with the corporate finance decision rule for project selection in capital budgeting: viz. projects are acceptable if they promise expected rates of return at least equal to their cost of capital. The returns are difficult to estimate over project lives, but they are easy to calculate in terms of cash receipts and disbursements. The cost of capital is not a cash cost in a business. Rather, it is the investors' alternative opportunity rate of return, that is, the return they could expect to earn elsewhere on alternative but equally risky investments.

The capital budgeting principle means management must aim to do as

well as investors could otherwise expect somewhere else. As we shall see, this capital budgeting principle is the key to the role of gold in properly-managed investment portfolios.

Turning to investment management, the first principle is that on well-functioning capital markets, the returns investors can expect to earn are constant per unit of risk. This means that higher returns can be obtained only by bearing proportionately increased risk. Put another way, risks and rewards go hand in hand, investors get what they pay for and markets are thus a fair game.

The second principle of investment management is easiest to understand, but is the most subtle to apply: diversification pays. Thus, to assure a given return, investors must commit funds to a number of identically risky investments. After all, there is a difference between anticipating a return and actually earning it.

Some investments of a particular risk will perform better than expected, some worse, but on average the expected return should be realised. Statistical analysis tells us that 15 to 20 investments with a particular risk provide a better than 90% chance of earning the commensurate return.

A more subtle and much more important implication of the diversification principle is that investors benefit when they minimize their portfolios' covariance. This is fancy jargon for minimizing co-movements in returns. That is, on average it is better (i.e. more efficient) to design diversification so that when some returns are rising others are falling, even though identical average returns can be obtained if all investments in a portfolio rise and fall in value in unison.

"Better" means greater balance and occasionally higher value. In fact, serious researchers have shown that over time diversified portfolios that minimize covariance have greater efficiency than portfolios with greater than necessary covariance. Basically this means that should investors be forced to liquidate their portfolios, their average net proceeds would be greatest during declining markets with minimum covariance.

If you are still with me, it is time to combine the logic of the three principles into a coherent decision framework for gold.

Investors who dominate the price-

setting mechanism on share markets manage their portfolios to achieve efficient diversification with minimum covariance. Thus, when corporate management calculates costs of capital for projects, these required returns must be sufficient only to compensate investors for the risks that cannot be diversified away. That is, total risk which is the sum of diversifiable and non-diversifiable risk, is not relevant in capital budgeting because it is irrelevant to dominant price-setting investors. Only non-diversifiable risk matters.

Here is the key for gold: because of its large price volatility, gold has become highly risky to hold by itself (i.e. its total risk is large), but when combined with other investments in a portfolio, 94% of gold's risk evaporates.

More specifically, on a scale where 100 represents average risk for holding industrial shares, gold scores a highly risky 166. This means gold — when held alone — is 66% more risky than the average industrial share, equivalent to investing in shares of highly peared and highly cyclical firms.

But place gold in a well-diversified portfolio and its diversifiable risk is filtered out — its risk score declining to a mere 10. This is because on a worldwide basis almost all of the time the gold price moves in the opposite direction to both industrial share prices and the rates of real economic growth in 35 countries. There are precious few alternatives to gold that minimise covariance as efficiently. The closest is investing in Norway with a non-diversifiable risk index of 16.

The problem with gold shares is the political risk that accompanies them as excess baggage. Our research concludes that political risk, while neutral to cost of capital, severely erodes projects' rates of return by, for example, reducing or eliminating salvage value and the present value of distant cash flow.

In short, no matter what its price, the covariability characteristic makes much more efficient investment portfolios containing gold. Being out of step with other expected returns in the free world is gold's real attraction. Buying or selling gold because it is "cheap" or "dear" usually is a judgment best made with the following axiom in mind: hindsight is an exact science. It may be a game worth winning, but usually it is not a game worth playing.

# US 'seriously studying' return to gold

2/21/87

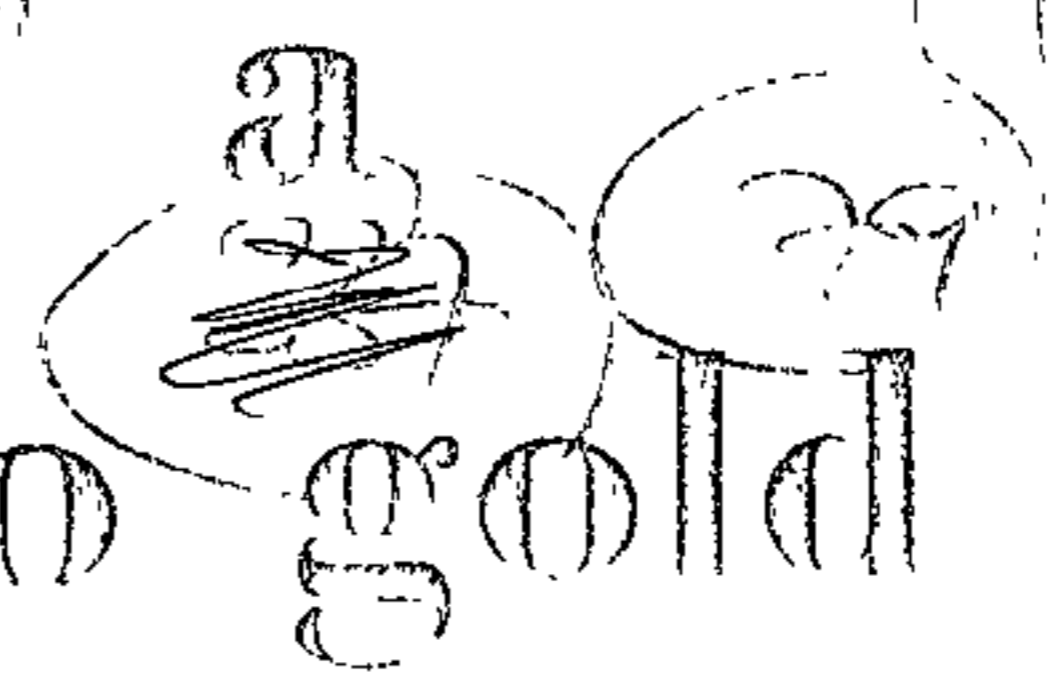

By John D'Oliveira  
WASHINGTON—Murray Weidbaum, chairman of the President's Council of Economic Advisers, said today that the administration was giving "very, very serious study" to a return to the gold standard.

Mr. Weidbaum was quoted briefly on American television last night during a discussion of America's continued problems with high inflation.

While Mr. Weidbaum does not necessarily speak for the Reagan Adminis-

tration, he is the most important administration voice thus far to speak about gold and its possible involvement in the United States monetary system.

Over the past two weeks three Washington Post political columnists have written about the strong push from deep within the Reagan Administration for a return to a gold standard.

All three suggested that the President himself favoured a return to the gold standard and two (who together write a single column) identified Mr. David Stockman, the

Director of the Office of Management and Budget, as a "closet gold bug" who could turn to a return to the gold standard in an effort to save the administration's faltering economic policy.

### DECISIVE

Mr. Stockman, is perhaps the most important of the administration's money men and his views could be decisive.

However, while most administration spokesmen and most of its outside economic advisers insist that there is no question of America returning to the gold standard, a special commission—appointed by the administration—is studying the role gold should play in the domestic and international monetary system.

### PRESSURE

The commission is due to report in October and it will come under tremendous pressure from the "gold bugs."

Even administration officials insist that the commission is doing no more than "going through the motions."

However, the whole issue has become sufficiently serious to have attracted the attention of two of America's leading newspapers, the New York Times and the Washington Post. Both acknowledged the pressure for a return to the gold standard—and both pointed out that this would not solve the United States' economic problems.

action as it was then worded. The 1959 amendment  
inter alia to bring such transactions within  
on and based on the decision in Smith's case  
t has achieved this result.

not be hit

# SA delegates

# to meet US

# Gold Commission

7/9/81

79 244

### Rules:

- (1) An intro by name and orified by function
- (2) The intro value
- (3) It is no contain proces
- (4) For a v
  - (a) mu in
  - (b) mu na
  - (c) mu tio
- (5) If a par name r

### Examples:

- (1) This se then pri REAL,

1.0	
2.0	
3.0	

**By David Canning**  
**DURBAN**—The growing debate about the merits of remonetising gold could have important implications for South Africa — and especially for the mining industry and shareholders.

I understand that many of the South African delegates to the coming meeting of the International Monetary Fund will be having discussions with members of the US Gold Commission now investigating the pros and cons of a dollar-gold link.

#### TRADITIONAL

The idea of a return to gold is regarded as "off-beat" and "unlikely" by traditional US economists opposed to the idea but a top mining man says there can be absolutely no justification for dismissing the likely results of the commission.

"The commission very much has the ear of President Reagan and his council of economic advisers. It is headed by a

man equivalent to our Minister of Finance and we should not fall into the trap of thinking this is one of those interminable South African-type commissions which generally come to nothing in the end.

"We firmly believe that something positive will come out of the recommendations and they will be swiftly acted on," he said.

However, the chances of a full return to the gold standard of yesteryear are regarded as slim, even in South Africa.

An economist said that the problems of the gold standard era were still too well remembered and many countries would not be prepared to link the value of their currencies to a metal mined largely in South Africa and Russia.

#### APPROACHES

Even if they did agree, it was difficult to see a way of their agreeing to a "fair" fixed value for gold.

Far more likely to emerge are new

approaches — possibly using gold in some way — to the world's enormous economic problems of inflation, widely-fluctuating currency values and the consequent trade difficulties.

There is undoubtedly a reaction against the flimsiness of paper money, which the IMF is still promoting, and a feeling that a link to gold will restrain governments from getting out of economic difficulties merely by printing more money and thus adding to inflation.

Any decision to peg the price of gold could have one big advantage for South Africa — it would give the mining industry a lot more certainty about where it was going.

At a price of 600 dollars an ounce most mines would be able to keep going for long periods — perhaps 20 years — by carefully planning the mining of low-grade ores first.

Of course the major problem — and one which could put mines out of business fast — would be a gold price which was too low. When gold was pegged at 35 dollars an ounce there were dire predictions that there would be no mines left operating by 1980.

#### NERVOUS

A number of mines are sitting nervously on expansion plans formulated at least year's higher gold prices and a fixed price would avoid that difficulty.

However, unless inflation and rising production costs are brought to a standstill (which seems impossible) a fixed price conceivably could have a severe impact on South Africa.

DO 2.0 K = 1 6  
 V.C.T.R.I.(K) = C.M.P.L.X.(R.E.A.L.(V.C.T.R.I.(K))) = A.L.L.  
 W.R.I.T.E.(3.3.0) V.C.T.R.I.  
 F.O.R.M.I.A.T.(. . . .)

TABLE

(c) E  
1

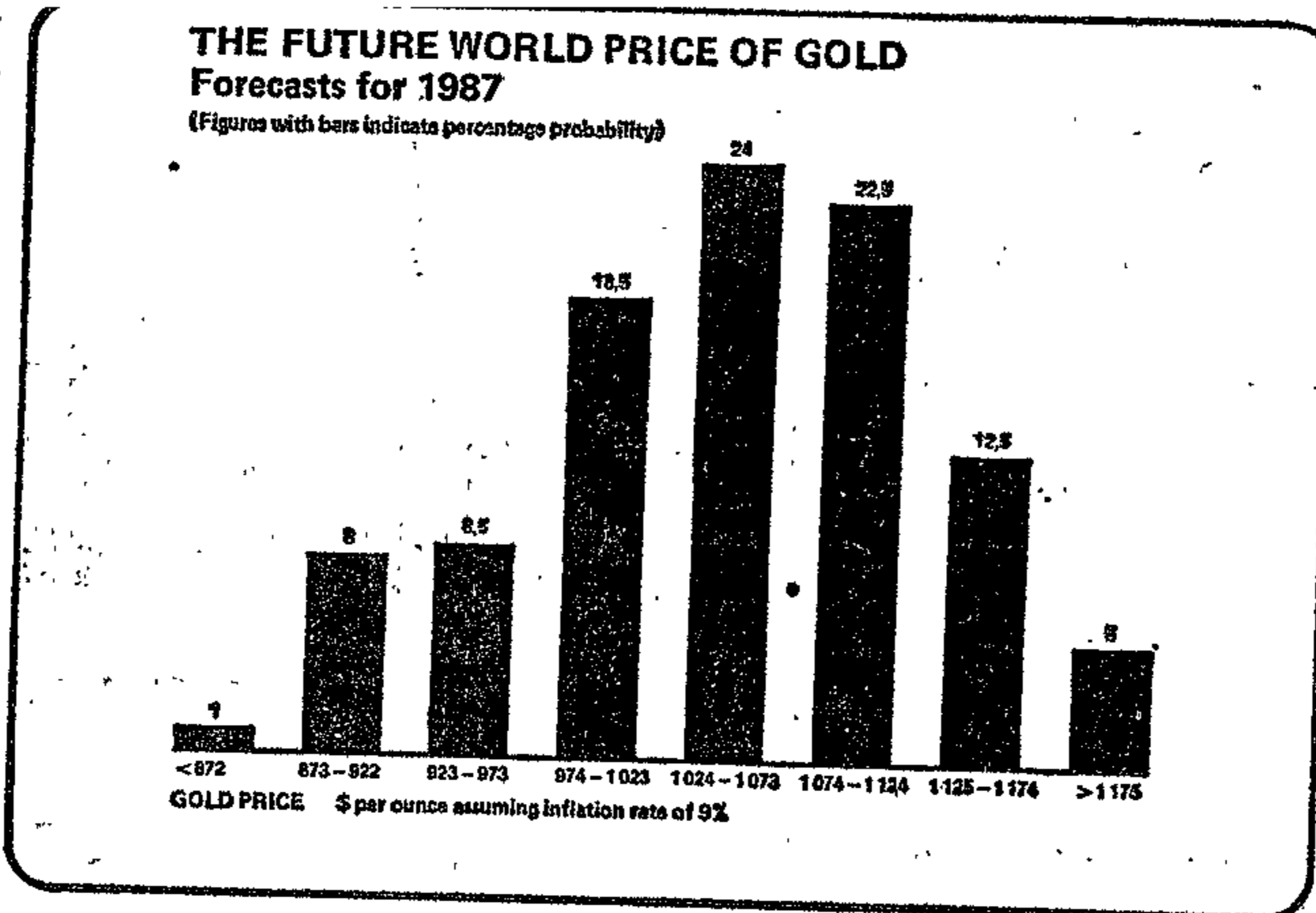

15-59,

ales  
yed

,6  
,8  
,1  
,8  
,6  
,4  
,4  
,4  
,5  
,2

# Scientific study sees gold at \$1000 in 5 years

*9/9/81*

*79*

By David Bamber

There is more than a 75 percent chance that the gold price will rise to above 1 000 dollars an ounce within the next five years.

This finding is published in a study entitled "The Future World Price of Gold" released by Anglo American Corporation yesterday.

The study was undertaken for Anglo by Dr Horace "Woody" Brock, president of Strategic Economic Decisions Inc of California.

Based on the "probability theory," the study shows there is a 24 percent chance that the gold price will be between 1 024 dollars and 1 073 dollars an ounce in 1987 and a 22.5 percent chance of it being between 1 074 dollars and 1 124 dollars.

### ● Probability

There is a 12.5 percent probability that the metal will be between 1 125 dollars and 1 174 dollars and a 5 percent chance of it being higher still.

On the downside, there is an 18.5 percent chance of gold being between 974 dollars and 1 023 dollars and an 8.5 percent chance of it being in the range of

most significant determinants of future demand are sociological, political and macro-economic in nature," it says.

For his reason, in addition to gold producers, interviews were held with bullion dealers, gold traders and analysts, international bankers, political analysts, journalists, economists, finance ministers, think-tank personnel, and so on.

Dealing with supply and demand for gold by 1987, the study comes to the conclusion that there will be strong worldwide demand for the metal while production is expected to be around current levels.

### ● Central banks

Large central banks are not expected to be net buyers of gold although the smaller ones should be if the bullion price does not move to the top end of the scale.

Jewellery demand should rise strongly in most parts of the world, while the electronics and aerospace demand should hold its own.

The dental demand is expected to fall slightly as the use of substitutes becomes more popular.

South Africa and Russia will remain the world's dominant gold producers.

As far as South African sales are concerned, the

the results, for all practical purposes would have been the same and the forecast therefore should be regarded as applying to the period 1986 to 1987.

He goes on to say: "This project will have been a success if two sets of insights are gained from it: a better understanding of the likely course of the gold price as the 1980s unfold, and an appreciation of a new forecasting methodology consistent with the economics of uncertainty and with modern probability theory.

"In a surprising number of cases the experts upon whose subjective judgments the report relies shares common probabilistic views about the future, and their opinions are embodied in the gold price forecast.

"It could well turn out that they are all wrong, and the gold price in 1987 might be 100 dollars or 2 000 dollars."

923 dollars and 973 dollars. The odds against a gold price below 872 dollars by 1987 are 99 to 1.

Prices are in terms of 1987 money and these particular forecasts assume an inflation rate of 9 percent.

On a 13 percent inflation rate there is a mere 1 percent chance of bullion being less than 1000 dollars an ounce while, at the top end of the scale, the metal could reach as much as 1458 dollars.

Assuming a near impossible nil inflation rate, the gold price would still be in excess of 500 dollars an ounce with a probability of 611 dollars and a ceiling of 700 dollars.

### ● Comprehensive

The study is exceptionally comprehensive with data being provided from some 80 interviews with "well-placed and well-informed people throughout the non-communist world.

"In trying to forecast the gold price it is not enough to hold discussions only with experts in the gold markets, for the

four most determinant factors appear to be price, the quantity of gold produced, the sales policy followed by the Reserve Bank and the prospect of much higher wages for black mine workers.

The study makes no pretences of being anything other than probabilistic.

### ● The same

Dr Brock notes at the beginning of the project that while the analysis was based on the year 1987, had the year chosen been 1986 or 1988

79 FM 11/9/81

# Gold: A look into the future

Any document entitled *The Future World Price of Gold*, sponsored and presented to the international bullion investment community by a group with the clout of Anglo American, is bound to be taken seriously. And that is the case even if the author, Dr Horace "Woody" Brock, (35), a Californian-based specialist in the economics of uncertainty, prefaces his talk through the paper by saying: "A good forecast is not at all one which is correct . . . (but) in gold one has to know the odds and it is possible to know the odds. You can't hope for any better."

Brock, head of Strategic Economic Decisions Inc, was commissioned by Anglo 10 months ago to "give a firmer base" for mining investment decisions with lead times of six or seven years, according to Anglo's gold supremo Dennis Etheredge. Introducing Brock to more than 200 gold specialists (including a couple of Russians) in London this week, Etheredge described previous mining house methods of assessment as a "pretty crude" mix of past knowledge and gleanings from supply-demand estimates. This "brew" produced an "intuitive feel" about the future. (And a conservative feel at that: 18 months ago when gold was above \$700/oz Anglo's high, medium, low range for five-year investment strategy was \$450-\$350-\$280, which looks rather clever right now).

The nub of Brock's report to Anglo is a histogram which shows the percentage of probabilities of gold averaging a range of prices in 1987, when it will be in supply-demand equilibrium. The range is surprisingly narrow, from less than \$520 an ounce (in 1981 money) to more than \$700. It is even tighter when the main groupings of probabilities are considered.

According to the report, there is an 18.5% chance of a \$581-\$610 range (again in constant money) by 1987, a 24% chance of \$611-\$640, a 22.5% bet on \$641-\$670 and 12.5% for \$671-\$700. This core of the odds on the 1987 price thus gives it a 77.5% probability of averaging \$636.70 oz six years hence. Or a mean of \$1 052 if rising prices deflate the purchasing power of the dollar by an annual average of 9%. It puts a real rate of return to the steadfast hoarder at 6.5% a year.

Brock has arrived at this range of "probabilistic price equilibria" after making a virtue of uncertainty in his report. "The decision to admit that we do not know the future and to ascribe subjective probabilities to different futures frees us from having to make specific assumptions about what will most likely happen. In this report there is no single 'planning scenar-

io' describing the future political economy of the world, but rather a host of different scenarios, each weighted by its probability."

His approach was to put together 48 risks in demand and supply — covering the full range of factors governing these, from interest rates, currencies, economic growth, political upheaval to fashion and investment trends, labour unrest, mining costs, and SA Reserve Bank and Russian sales policies — and hinge some 243 scenarios around these. The subjective probabilities, seen from a 1981 viewpoint, of what supply and demand would be between constant "low" (\$375) and "high" (\$750) prices, were provided by discussions with 80 international, but anonymous, experts in their fields. They included central bankers, finance ministers, industrial consumers, fashion leaders, political analysts and mining executives.

In all, it was possible to compute a mind-boggling 9.4m possible supply-demand curves from the inputs, said Brock. On balance, supply is likely to be much less price elastic than demand: A mean of 1 212 t at the low (constant) price and 1 230 t at the high.

Opinion on aggregate demand swings sharply between the two prices. The probability average for net private investment demand at \$375 is computed as 875 t but at \$750, drops to 173 t (with dishoarding coming in); large central banks net buyers of 25 t at the low price but sellers of 25 t at

the high; jewellery off-take ranges over 859 t and 472 t and electronics usage from 102 t-81 t. The difference between global mean demand at the two prices is a staggering 2 111 t and 762 t.

Brock, in his final computing of probabilities, narrows his demand curves, which fall steeply in response to price change, to six and supply to four — these rising at a shallow angle in response to price and the other various scenario inputs. They give 24 price equilibria between \$518 and \$730 with a heavy clustering around \$580-\$700.

But Brock — who emphasised the "murkiness" surrounding some of the major determinants of demand and supply — provides his own caveat to this new technique for assessing the odds. He notes that it will have to be constantly updated in the chase of the "moving target" that is, the gold price. This warning lay in what he found to be a "surprising" consensus among the "probabilistic views" put forward by the 80 experts. These experts' essentially "subjective judgments" were the core of the report. "It could well turn out that they are all wrong, and the gold price in 1987 might be \$100 or \$2 000," he said with disarming candour.

This, however, should "not cause undue concern" (even if it would almost certainly cause fainting fits in certain quarters). There was ample opportunity to update and revise the probabilities between now

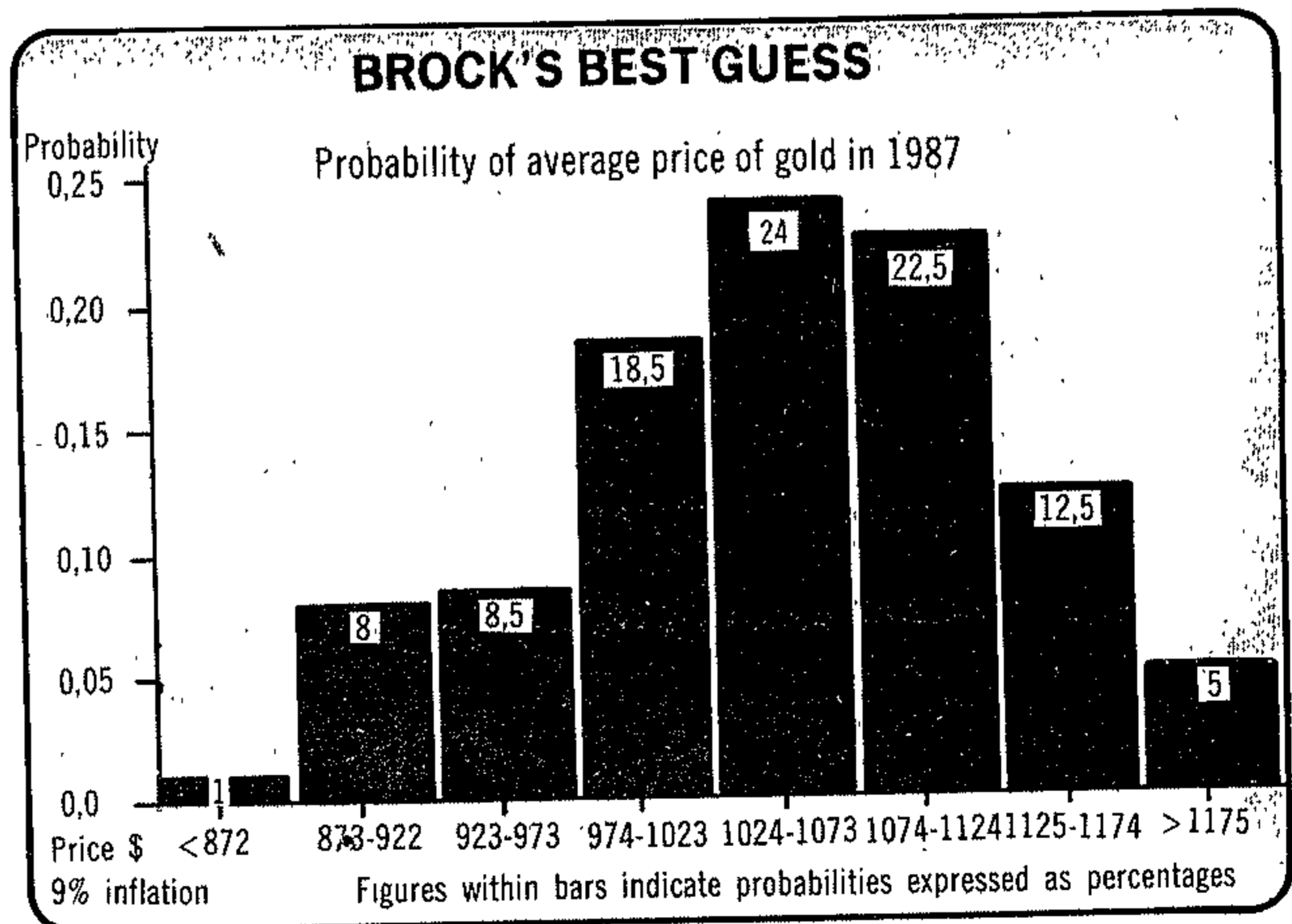

SECTION D: Video Research Project

Simon Burton  
Bill Cowan

In a separate book, answer TWO of the following questions.

12. Briefly describe, and evaluate, the use of Video techniques as a method of social analysis. Use examples from a project that you have participated in.
13. Choose one aspect of the research project which you have participated in and outline why you see it as important. Relate this aspect to other issues studied in the project.
14. What major issues related to the project were not studied, and why? Discuss the theoretical importance of these issues within the area of study.

and 1987  
 That blunt statement swallowed Apple seems well pleased with the new approach  
 Brock admitted there were uncertainties which may not have been put on the weight in comparing his multitude of scenarios. One which has heavily on Apple and other gold producers is how the rand-dollar rate will be managed at future gold prices. That clearly requires a probability study of its own for as the rand told the *NYT*. That, of course, is another thing that confuses us

Copyright: University of BC/VV

# Half central banks' reserves in gold

Financial Reporter

GOLD accounts for more than half the reserves of the world's central banks, the International Monetary Fund annual report reveals.

While the world's central banks at the end of May 1981 held 346,000-million SDRs in foreign exchange and SDRs, their gold holdings amounted to 384,700-million SDRs.

But the quantity of gold held by central banks showed little change either on the year or over eight years. This means the gold component of reserves has been influenced more by the gold price than physical quantities held.

At the year end central banks

held 939-million ounces, compared to 903-million in 1980.

The gold holding of the banks came down significantly in 1979, from 1,022-million oz to 930-million oz, when nine member countries of the European Currency Union deposited 20% of their gold holdings with the European Monetary Co-operation Fund.

## Inflation

Otherwise holdings have not changed radically in percentage terms over the eight year period reflected in the report's accounts.

The IMF expects inflation to moderate somewhat for all major groups of countries in 1981.

"Among the encouraging aspects of the world economic situation at mid-1981, were indica-

tions that the inflationary surge of 1979 and 1980 has abated," the fund said.

"An opportunity is now presented for its reversal. Monetary expansion in the major industrial countries has been considerably restrained and might be brought under control if policies of restraint are not relaxed prematurely and are accompanied by appropriate fiscal policies."

The report said it expects inflation to fall in the industrial countries from the 10% level that prevailed in first half 1981.

At the same time, it said, "with a much smaller rise in import prices in recent years, the average rate of inflation in the oil exporting countries is expected to decline somewhat in 1981".

The IMF added "If the numerous adjustment programs that

have been instituted with a view to improving both internal demand/supply relationships and external balances are appropriately implemented, some easing of the average rate of inflation among non-oil developing countries in 1981 would seem likely."

## Growth and oil

However, the fund said the US could be the key to any global reduction in inflation.

"The centre of gravity of global price developments has been raised to a degree that could hinder the reduction of global inflation if the US inflation rate is not lowered in the years ahead," the fund said.

The IMF said industrial countries had considerable surpluses containing secondary repercussions in the 1979-80 surge in ener-

gy costs.

"A related development of hopeful significance is that the former close linkage between economic growth and oil consumption appears to have been severed during the past few years."

After a decline of 3% from 1979, total energy consumption in the industrial countries was approximately the same as in 1973, despite a 19% growth of real GNP over the period.

In addition, the IMF observed a significant switch to non-oil sources of energy.

"Consumption of non-oil energy in the industrial countries is estimated to have risen by 7% from 1978 to 1980, compared with an 8% decline in the consumption of oil."

The IMF said the smaller surplus of the oil producers and the smaller deficit for the industrial countries will reflect "rapid increases in imports of the oil exporters and further declines in the volume of their exports".

The fund expects the surplus of the oil exporting nations to fall to \$96,000-million from a record \$112,200-million in 1980.

The current account deficit for the non-oil developing countries, on the other hand, should rise to \$97,000-million this year from \$92,100-million in 1980, the IMF said.

The IMF said the smaller surplus of the oil producers and the smaller deficit for the industrial countries will reflect "rapid increases in imports of the oil exporters and further declines in the volume of their exports".

The fund said the increase in the deficit of non-oil developing countries should occur because their economies will not grow rapidly enough to cover the cost of their imports.

*Here are central banks*

*?*

*a system*

*1981/15/19/81*

*(79)*



**DEPARTEMENT VAN FINANSIES**

No. 1973

18 September 1981

**WET OP DIE SUID-AFRIKAANSE RESERWEBANK,  
1944**

**BEPALING VAN STATUTÊRE GOUDPRYS**

Hierby word bekendgemaak dat die Minister van Finansies kragtens artikel 17A (1) van die Wet op die Suid-Afrikaanse Reserwebank 1944 (Wet 29 van 1944), alle goud van die Suid-Afrikaanse Reserwebank met ingang van 31 Augustus 1981 teen R352,90 per ons suiwer goud gewaardeer het

**DEPARTMENT OF FINANCE**

No. 1973

18 September 1981

**SOUTH AFRICAN RESERVE BANK ACT,  
1944**

**DETERMINATION OF STATUTORY PRICE IN GOLD**

It is hereby notified that, in terms of section 17A (1) of the South African Reserve Bank Act, 1944 (Act 29 of 1944), the Minister of Finance has valued, as from 31 August 1981, all gold of the South African Reserve Bank at R352,90 per fine ounce of gold.

# Perhaps the worst is past

Gold's recent recovery lends strength to the view that a major re-evaluation is once again in the making. After cresting just short of the \$460 mark, bullion has fallen back below \$450, still a sturdy 15% above its low point at mid-year. This striking improvement coincides with the publication of Dr Horace Brock's elaborate exercise in gold price forecasting, commissioned by Anglo American. The forecast concluded that bullion stood a 60% chance of exceeding \$1 000 an ounce by 1987, given an annual inflation rate of 9%.

High US interest rates have been the main brake on gold for many months. The emergence of substantial real returns on short-term money instruments has, as ever, dimmed the attractions of real assets, which offer no immediate return. But hopes are growing that the worst is past as far as interest rates themselves are concerned, while other factors are beginning to loom larger.

President Ronald Reagan's honeymoon with the US electorate seems, finally, to be losing its lustre. Especially since the last weeks of August, US and other investors have begun to adopt a more sceptical view of Reagan's policy objective — to wring the last drop of inflation out of the American economy.

There is now a more sober awareness that inflation is an intractable foe in the contemporary world, with America being no exception. Labour unions are loathe to relinquish their objectives of ever-rising living standards, and a few months of pressure from central banks are not sufficient to achieve the necessary alteration in their leadership's perceptions of what is feasible.

Americans are an impatient people, quick to lose faith if they do not achieve a quick fix. And the truth of the matter is that the Reagan administration has not succeeded in restoring America's economic health, despite the pain inflicted on many sectors by high interest rates. Although inflation rates are well below their peak, and there has been a notable respite on the oil price front, the underlying long-term inflation rate is still far too high for comfort.

There is increasing recognition that the problem of the Federal deficit remains intractable, with adverse medium-term implications for the fight against inflation. There are major constraints on further substantial expenditure cuts.

The Administration's forecasts envisaged budget deficits falling from \$56 billion in fiscal 1981 to \$42 billion in 1982 and \$27 billion in 1983. Recent calculations suggest, though, that a continuation of the current

interest rate pattern would add \$20 billion to the budgetary burden. So a like amount would have to be slashed from other appropriations.

The fairly effective resistance raised by Defence Secretary Caspar Weinberger to efforts to take some of the cuts out of defence shows how difficult is budget cutting.

And America is now within sight of next year's mid-term Congressional elections, so the chances, already slim, of cutting anything from social security must diminish further in the near future.

To return to gold, the current pattern of interest rates is clearly discounted in the price, so that even modest reductions would have a bullish influence. In other parts of the world, the shake-out of weak holders appears to have run its course. The outflow of gold from Eastern markets has already been reversed: in the first seven months of the year Japan absorbed no less than 88 tons, or five times the comparable amount for last year.

There is also encouragement to be drawn from the request by the Gold Study Commission for an extension of its report date. This development justifies the inference that the Commission's work on a possible renewed monetary role for gold is now to be taken seriously indeed.

Concurrently, several small gold producing nations have announced their intention to buy newly produced gold at market-related prices and use the bullion as collateral for foreign borrowings. There is also pressure from Europe for a more orderly world monetary system.

And, for what they may be worth, there are charting signals that gold has broken the downtrend into which it has been locked since September 1980.

The chartist view that gold was in a strong downtrend has certainly contributed in the recent past to short selling from American futures operators.

All these factors add up to an increasingly convincing picture of a gold price that has put the worst behind it, although there is no evidence to suggest that a period of explosively rising gold prices lies ahead.

What are the implications of this for the SA economy? The recent Budget was based on a projected average gold price of \$430. The emerging price pattern suggests that this could well turn out to be somewhat conservative. So the worst fears of the pessimists about the SA balance of payments and government's financing requirements now look unlikely to come true. The improvement will leave more room for manoeuvre on the other front — the continuing fight against inflation.

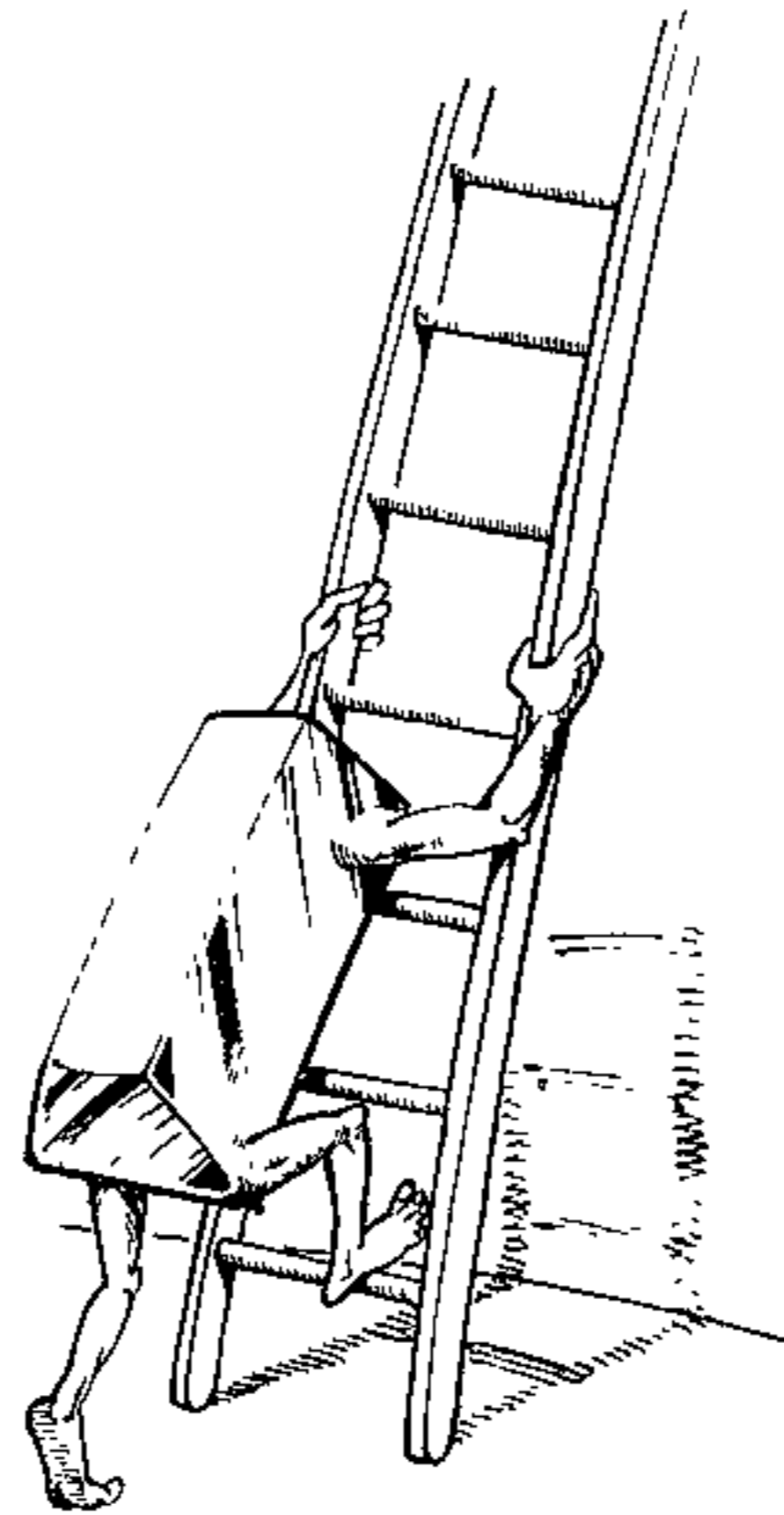

be sold in large quantities in supermarkets. However, in underdeveloped countries, the customer doesn't make one large shopping trip, thus food is sold more frequently and in smaller quantities. This factor must obviously be considered in international marketing.

2017 1/10/81  
(79)

# Positive signs for gold — Chamber

ALL the current negative factors influencing the gold price now are temporary, and they will be reversed, with an upward trend in the price expected, says Mr Lynne van den Bosch, president of the South African Chamber of Mines.

In an address to the American Mining Congress in Denver, Colorado, this week Mr Van den Bosch forecast a general excess of demand over supply, with production by South Africa, the world's major producer, having fallen by about 25% over the past decade as higher prices have led to lower-grade ores being mined with a consequent fall in output.

He also saw a continuing broadening of the gold market — which has widened considerably over the past decade — with the lifting of restrictions on the possession and trading of gold in a variety of countries, the emergence of gold futures markets and 24-hour world-wide gold trading.

Mr Van den Bosch cited the remonetisation of gold and demand for the metal by "the man in the street", evidenced by the sale up to now of more than 30-million one-ounce Krugerrands.

Other factors indicating confidence in the long-term future of gold were a resurgence of industrial demand, and particularly for gold jewellery, and the belief that in times of trouble or uncertainty gold symbolised security, added Mr Van den Bosch.

However, it was becoming clear that the gold price is cyclical, said Mr Van den Bosch, being influenced by economic trends, and the South African mining industry was having to learn to live with the vagaries of the price as it adjusted to the innumerable factors affecting it positively or negatively.

"But we remain convinced that in spite of these peaks and valleys the long-term trend will be upwards."

Mr Van den Bosch noted that South African mining companies were traditionally conservative when planning ahead and this, coupled with the increased value received for their gold due to the rise of the dollar constituted cushions against the current state of the gold market.

"Only in the event of a really serious downturn in the gold

By JOHN MULCAHY

price can I foresee any radical change in the policies of the higher-grade mines or any significant reduction of the \$8 400-million capital expenditure programme."

Excluding oil, SA's gold mines, with a revenue of \$13 000-million, earned more at prevailing exchange rates last year than the mining industries of Canada and Australia, which had respective revenues of \$7 700-million and \$5 500-million, and was second only to the US, whose mines earned \$46 000-million.

Mr Van den Bosch said that if coal and other minerals were included total receipts by SA mines last year amounted to well over \$19 000-million.

# Cons Gold hopes are high for the gold market

RDM

1/10/87

79

AT present gold price levels, dishoarding has dried up and carate jewellery is coming back into fashion, while central bank interest is active and new supplies remain scarce.

By JOHN MULCAHY

The Consolidated Gold Fields directors say in the annual report the group is confident that the fundamentals of the gold market are favourable, and "we would be surprised if the market ends the year on as depressed a note as it began".

"We cannot tell when these fundamentals will assert themselves, but in the meantime we are not totally at the mercy of events", the directors say.

They refer to the South African gold mines (GFSA) which are expected to achieve generally higher production rates this year, and the consolidation of East Driefontein, North Driefontein and West Driefontein should result in a significant increase in the mill throughput of the combined operation.

In the current year difficult market conditions have persisted, say the directors, with the gold price around \$114 lower than the average received in 1980/81, although base metal prices are higher.

The unfavourable impact of the lower gold price expected in the current year, ending June 30, could be more than offset by a number favourable factors affecting operating profits.

The directors add, however, that profits from financial transactions are hard to predict, "and in this area we cannot count on generating as considerable a profit as that earned in 1980/81".

Cons Gold's chief executive told reporters in London yesterday that the group faced a difficult year, with much hinging on the gold price and results from Amey Roadstone Corp.

He said Cons Gold's submission to the US Federal Trade Commission (FTC) on the group's planned purchase of more shares in Newmont Mining Corp was extensive, and the recently delivered documents replying to FTC questions "filled a truck".

The US Monopoly and Anti-Trust authorities are scrutinising Cons Gold's Newmont link because of the group's link with Anglo American and De Beers. Cons Gold holds about 8% of Newmont and hopes to raise its

stake to between 25% and 49%.

The Anglo/De Beers stake in Cons Gold, through Minerals and Resources (Minorco) is nearly 30%, and it is believed Cons Gold's freedom to invest in major US companies will depend on whether the group is viewed as an arm of Anglo and De Beers.

In the year to June Cons Gold spent £15 700 000 on exploration, more than double the previous year, and the group is budgeting for an additional 50% in exploration expenditure this year.

The directors say construction spending in the UK may at best have bottomed, and "the contraction of public sector construction spending in the UK cannot go on forever. Successive governments have neglected maintenance and repair of the public infrastructure to the point where our roads and sewage systems are becoming a menace to health and safety and many of our hospital buildings a disgrace."

Provided there is no further significant fall in the construction and industrial markets Cons Gold's operations in these sectors will improve because they have been trimmed down to much lower levels of capacity.

Prospects for the group's steel and construction material interests in the US are uncertain, say the directors, given the economic climate in which they will have to operate in the short term.

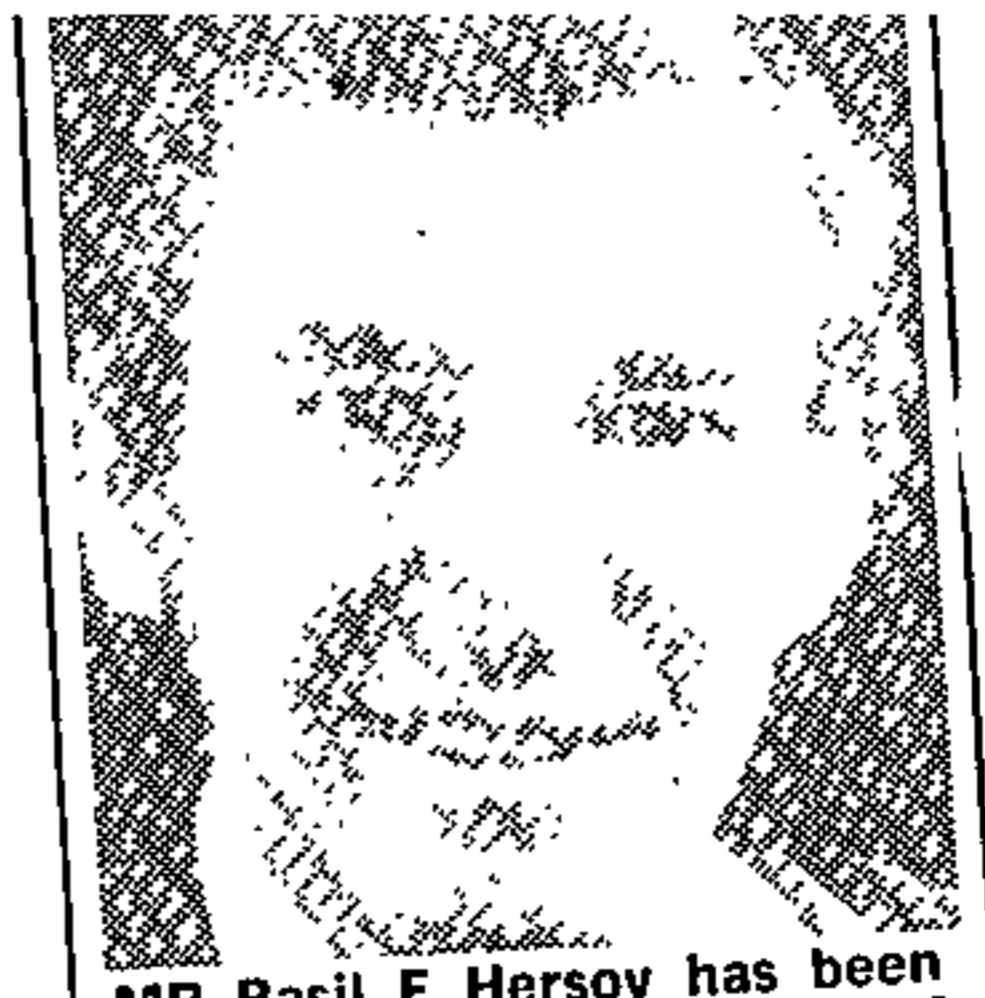

MR Basil E Hersov has been appointed deputy chairman of Barclays National Bank.

# Gold producers' revenue may drop R52-million

Star 8/10/81 79

By David Bamber

The revenue received by South Africa's gold producers during the September quarter could be as much as R52-million lower than in the previous quarter.

While the rand weakened further against the dollar from 1.19 dollars to around a naverage of 1.07 dollars, this was not sufficient to cushion the 57-dollar-an-ounce fall in the gold price from 478 dollars to a level of about 421 dollars.

## RAND TERMS

In rand terms, gold will have fetched about R12 660 compared with R13 000 in the previous three-month period.

Adding to the gloomy prospects for the results, the first of which, Gold Fields of South Africa, will be released tomorrow, is that working costs for the industry as a whole are expected to rise considerably.

This is largely as a result of the September quarter being the first period in which the full impact of the wage increases granted this year will be taken into account.

Furthermore, it is un-

likely that milling rates will be any higher than in the previous quarter as the 2.2 percent rise from 22.7-million tons to 23.2-million tons reported during that period was merely due to the mines returning to normal capacity following the December holidays.

However, there is a possibility that many of the mines will have followed the lead given by General Mining Union Corporation in the June quarter by lifting grades slightly.

Gencor was the only one to take this action while Anglo American Corporation and Gold Fields of South Africa reported further reductions.

There was almost no change to the grades of Johannesburg Consolidated Investments, Rand Mines and Anglovaal.

If the other groups did this during the September quarter the impact of the lower gold price would have been cushioned to some extent.

In addition to all of these factors, capital expenditure usually builds up as the year progresses so it is likely that capex bills will generally be higher than they were three months ago.

Therefore, assuming taxed profits are reduced by the lower revenue received and higher working costs, earnings a share after capex should be considerably down on the June quarter.

While the increases in working costs are a foregone conclusion, it will be interesting to see whether Anglo American will again head the list with the smallest rise.

ROGER GIDLOW

# Remobilising gold

FM 9/10/81

(79)



Roger Gidlow is Associate Professor of Business Economics at the University of the Witwatersrand.

Ever since 1973 there has been a very clear trend towards a limited remobilisation of gold in the international monetary system, starting with the decision of the Group of Ten countries to allow their central banks to sell gold on the private market.

The trend was reinforced by the Gold Collateral Agreement of 1974, which allowed central banks to raise international loans using gold as collateral through "gold swops." And in 1978 the IMF decided to remove all restrictions on gold trading between central banks, which permitted them to buy as well as to sell gold at market-related prices.

The establishment of the European Monetary System (EMS) was also favourable for gold. The European Currency Unit (ECU) is a reserve unit issued by the European Monetary Co-operation Fund to constituent central banks in exchange for 20% of their gold and 20% of their dollar reserves.

Under the EMS system, gold fulfils both a liquidity and a transactions role, because the rules provide for partial settlement in gold of obligations arising between constituent central banks. And every three months these contributions have to be revalued and the issue of ECUs recalculated accordingly, so that a rise in the gold price will be reflected in an increase in the number of ECUs in issue.

The monetary role of gold could be further boosted by the fairly recent emergence of a multi-currency reserve asset system. A major potential problem with this system is that of massive international capital movements based on anticipations of adjustments in major currencies and relative interest rate changes between different financial centres. These capital movements could well grow further and cause even more violent swings in exchange rates than in the recent past.

Central banks very probably will take more active steps to moderate these capital flows and so provide greater stabil-

ity to the foreign exchange markets. So if gold dealings between central banks became more common (and more respectable) there could be benefits.

Whenever strong upward pressures on a currency threatened to develop because of central bank purchases, diversion of some of that buying pressure to gold instead of the strong currency would moderate the upward movement. The recent rise of sterling to a level unjustified by industrial competitiveness is a good example of a case where gold purchases would have helped.

Conversely, the recent weakness in the D-mark could also have been moderated if even part of the movement out of that unit had been into gold instead of into dollars.

There is a contrary argument — that gold will not be required as an intervention medium because central banks can turn to other resources. There are mechanisms such as currency swops, loans on the Eurocurrency markets and borrowings on national capital markets.

But not all countries are both able and willing to borrow large amounts on the Eurocurrency markets, while currency swops are really available only in the case of large central banks. And even there difficulties might arise. So central banks might well decide that their gold holdings could play a more active role under a multicurrency system, particularly since foreign exchange holdings may have a somewhat more limited reserve role in the future.

Thus it may not be so easy for the US in future to run balance of payments deficits and so feed new dollar reserves into the world. Under the multicurrency system combined with floating there would be a far greater risk that an American deficit would cause a run on the dollar, with unacceptable implications for the US.

## Constrained growth

So we may be faced with a position where the growth in foreign exchange holdings is more constrained than before — which could also motivate central banks to use gold more actively.

Some observers believe we could be faced in future with a semi-permanent state of crisis in the markets because of even larger capital movements than at present and therefore even larger swings

in major currencies.

One reason why central banks might use their gold to a greater extent is that the IMF's attitude has changed. The IMF was strongly opposed to the development of a multicurrency reserve asset system and to a strengthened role for gold, but very much in favour of the SDR. These objectives are proving very elusive, so that it is to be expected that IMF opposition to central bank gold buying should diminish.

## Japanese banks

Secondly, past US opposition to gold was largely based on its desire to maintain the near-monopoly status of the dollar as an international reserve asset. That objective too is proving unsustainable.

Recent developments in the Japanese gold markets are very encouraging.

Apart from strong private interest in gold, there are government proposals that the Japanese commercial banks should be allowed — for the first time since 1927 — to deal in gold.

I believe that one reason for the proposed concession is that it will afford a medium for camouflaged gold dealings by the Japanese central bank itself. If it bought through the commercial banks, the Japanese central bank might not even bother to disclose its activities to the IMF.

Given that Japanese gold holdings are quite low and that the central bank frequently has a motive to moderate upward pressures on the yen, future central bank gold purchases become a strong possibility.

If I am right about the increasing mobilisation of gold under the multi-currency system, there might be a useful amount of net central bank buying in the 1980s — a development of great value to SA. And if the central banks of the industrial countries were to become net buyers, they quite arguably would be net buyers at times when private speculators were selling.

So you could get some stabilisation of the bullion market as well, especially if they became jobbers in gold and sold when the market was strong. But the necessary first step is to get the central banks of the industrial countries back as buyers of gold, after a long period of being totally non-committal.

# Gold is looking good

Agus 9/10/81

79



Mr Val Volker

Chief Buthelezi

THE Minister of Finance, Mr Owen Horwood, said yesterday he was optimistic that a more positive attitude to the role of gold was beginning to emerge.

Introducing the third reading of the Budget, he said he had observed this at the meeting of the International Monetary Fund and the World Bank in the United States last week.

'There is now, for the first time in years, a willingness to explore this matter in a rational and responsible manner, rather than to try to evade it on emotional and quasi-political grounds,' he said.

It is still too early to say what will be the outcome of the processes that are being set in motion to set right the lack of official international recognition of the role of gold in recent years.

It is therefore also too early to say what the implications for South Africa might be. However, I am optimistic that a more positive attitude about the role of gold is beginning to emerge.'

Referring to the local economy, Mr Horwood said it has become clear that a



Mr Owen Horwood

slowing down in the expansion of real economic activity was taking place.

This was partly due to scarcity of labour and to the effect of the international recession on the South African economy.

A pleasing tendency was the slowing down of the inflation rate.

The consumer price index had increased by 10,4 percent in the second quarter of the year compared with 13,1 percent in the first quarter of 1981 and 22 percent in the last quarter of 1980.

'The fact that the economy is still operating on a high level of activity and that the inflation rate appears to be showing a moderating tendency should, however, not lead us to believe that we can avoid the process of adjustment that the economy has been undergoing,' Mr Horwood said.

'In the first place, even although the moderating tendency in the inflation rate is encouraging, prices are still rising too rapidly to allow us to say that the battle against inflation has been won.

'Secondly, if nothing else reminds us of the need for consolidation and adjustment the performance of the balance of payments should most certainly do so.'

He said a continuation of a policy of controlling the rise in the money supply would be essential for achieving the twin objectives of further moderating the inflation rate and keeping the deficit in the current account of the balance of payments under control.

'Inevitably, the reduced liquidity in the economy — which is brought about by this policy — has the effect of pushing up interest rates.' — Sana.

# Optimism over gold's future role

CT 9/10/81

79

HOUSE OF ASSEMBLY. — The Minister of Finance, Mr Owen Horwood, said yesterday he was optimistic that a more positive attitude to the role of gold was beginning to emerge.

Introducing the third reading of the Budget he said he had observed this at the meeting of the International Monetary Fund and the World Bank in the United States last week.

"There is now, for the first time in years, a willingness to explore this matter in a rational and responsible manner, rather than to try to evade it on emotional and quasi-political grounds.

"It is still too early to say what will be the outcome of the processes that are being set in motion to set right the lack of official international recognition of the role of gold in recent years.

"It is therefore also too early to say what the implications for South Africa might be.

## 'SA co-operation'

"However, I am optimistic that a more positive attitude about the role of gold is beginning to emerge, and in addressing the annual meetings I took the opportunity once again of stating South Africa's position on the matter and to offer our co-operation on any positive proposals that may emerge."

Referring to the local economy Mr Horwood said it had become clear that a slowing down in the expansion of real economic activity was taking place.

This was partly due to scarcity of labour and the effect of the international recession of the South African economy.

## Inflation rate

He said a pleasing tendency in the internal economy was the slowing down of the inflation rate.

The Consumer Price Index had increased by 10.4 percent in the second quarter of the year compared with 13.1 percent in the first quarter of 1981 and 22 percent in the last quarter of 1980.

"The fact that the economy is still operating on a high level of activity and that the inflation rate appears to be showing a moderating tendency should however not lead us to believe that we

can avoid the process of adjustment that the economy has been undergoing.

"In the first place, even although the moderating tendency in the inflation rate is encouraging, prices are still rising too rapidly to allow us to say that the battle against inflation has been won

## Controlling supply

"Secondly, if nothing else reminds us of the need for consolidation and adjustment, the performance of the balance of payments should most certainly do so."

He said a continuation of a policy of controlling the rise in the money supply would be essential for achieving the twin objectives of further moderating the inflation rate and keeping the deficit in the current account of the balance of payments under control.

"Inevitably, the reduced liquidity in the economy which is brought about by this policy, has the effect of pushing up interest rates."

This was a concomitant of sound monetary policy that could not be avoided at the stage of the business cycle in which south Africa found itself at present.

Attempts to avoid it could only exact a heavy price later on in the form of higher inflation and excessive balance of payment deficits.

The other essential elements of the stabilisation policy required in South Africa were continued discipline in public spending and the sound financing of that spending.

"Of course, a fiscal policy approach in conjunction with the monetary policy that is being pursued also can have certain unpleasant side effects.

"In particular, it requires acceptance of a lower economic growth rate, a lower rate of increase in salaries and wages and in profits, and possibly a moderate degree of unemployment among certain categories of labour.

"However, I am convinced that not only can we at this stage afford to have a somewhat slower growth period for a while, but that we actually need a pause to enable us to catch up on our training programmes and on other measures to widen bottlenecks in the economy," Mr Horwood said.



# Temporary measure

79 FM 13/11/81

After last week's R1 billion gold swop, there was speculation that the move would allow SA sufficient flexibility in its gold marketing schedule to have a possible longer-term effect on the gold price.

However, these hopes appear to be largely unfounded and it seems the deal was a short-term operation aimed solely at protecting foreign exchange reserves in a very difficult cash position.

The speculation was centred on the fact that the swop was worth at least four weeks of South African gold production and might allow greater leeway in supplies of bullion to the market for a short while. Taking 2,64m ounces of gold effectively out of the system at one time was certain to have some effect, even in the near term, on the gold price and its prospects, they said.

However, since the deal was concluded some weeks ago, SA has apparently continued selling its full weekly production on world markets, indicating that the deal was struck to correct the immediate cash reserves position, and not to provide any longer-term protection against a decline in foreign assets.

The international gold market appeared not to take any notice of the deal and, with good grounds to believe that Russian supplies to the market are currently at a high level, the price-supporting effects of the swop would have been minimised.

Certainly, the amount of gold involved could have been enough to tip the demand/supply balance and support the short-term gold price. But, as one economist pointed out this week, the banks which arranged the deal may, as a result of the swop at this price level, merely be put in a position where they can release other gold reserves onto the market.

And this week's continued decline since the time of the swop to the \$412 level will maintain the pressure to liquidate gold to bolster the cash position.

The likelihood of further gold swops, given that Reserve Bank governor Gerhard de Kock this week said that negotiations were taking place, is uncertain. For one thing, the Reserve Bank appears to view the swop mechanism as a last resort in correcting the cash reserves position and is obviously reluctant to erode gold backing, strong as it may be.

And there is, as one mining house economist put it, a limit to the extent to which the Bank can fiddle with the technical ways of bolstering the reserves before it has to tackle the fundamental cause of the balance of payments problem. And that problem is not strictly related to gold.

In fact, of the R6 billion to R7 billion

swing in the balance of payments over the last year, the decline in the price of gold has been responsible for less than R2 billion. The remainder has been caused by the strength of the local economy and the booming demand for imports.

It is here, economists say, that action will eventually have to be taken in one form or another. The rand is already weak, or something could be done on this front. And if import controls seem an unpopular and undesirable last tack, the alternative would seem to be a continued rise in interest rates aimed at cooling down the local economy and, therefore, demand for foreign goods.

This appears to give further credence to the view that the gold swop is a short-term measure only and that the authorities are willing to correct the imbalances by these means while waiting for a strong gold price rise or an imminent reversal in the economy for a longer-term effect.

Another worry was that the sudden cash injection into the gold and foreign reserves picture would boost the money supply, with a subsequent detrimental effect on inflation. However, it seems that the cash was taken in and repaid in the form of foreign loans so quickly that any inflationary effects would be obviated. The swop could, in fact, be contractionary and certainly appears to

give increased flexibility in monetary policy.

One positive effect of the whole deal is the psychological boost which the swop, and its apparently ready acceptance by foreign banks, gives to the value of bullion as collateral. Nevertheless, the swop does not necessarily mean that overseas investors have taken a definite view on the future of the gold price, as the swop and the call options are all done at fixed prices.

At the same time there is always the possibility that the longer-term trend in bullion will be strongly upwards and the South African reserves position will benefit, as it has done in the past, through the buy-back of gold at a fixed forward price when the actual market price is considerably above this level.

The swop should have temporarily eased the pressure on reserves, although the downward slide in the bullion price and continued strong imports will work against the trend. Consequently, further gold swops could be on the cards to protect foreign assets. But they are unlikely to be significant enough to have a meaningful effect on the price of gold and will continue to constitute merely a useful and suitable way of maintaining the balance on the cash account.

Scott Hawker

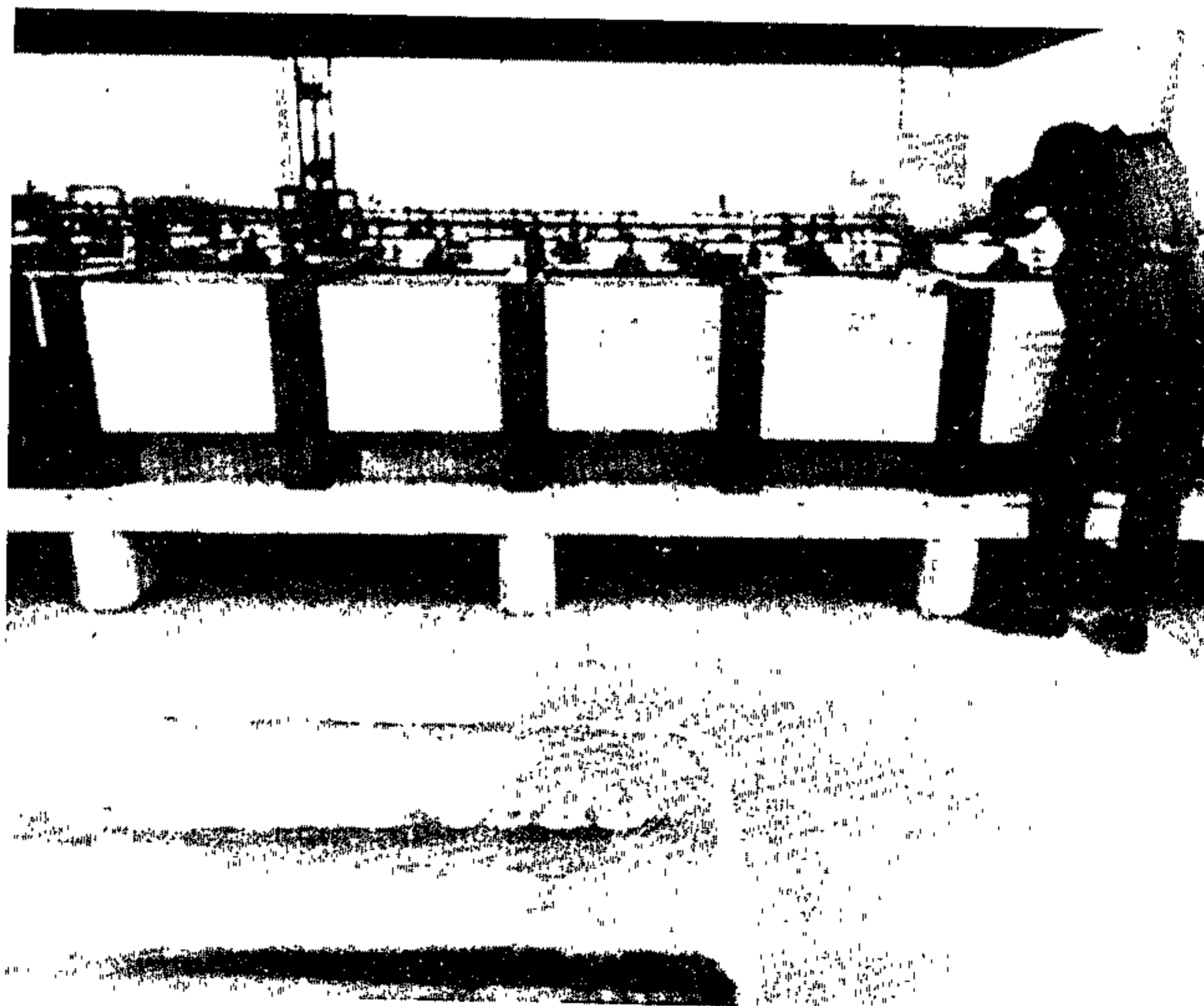

Bullion ... out of SA on temporary loan

# SA poised for a big gold swop deal

RDM 14/10/81 (79) (49)

SOUTH Africa is now on the brink of a major "gold swop" deal to raise hundreds of millions of rands worth of foreign exchange.

Contingency arrangements for a deal with overseas banks have already been cleared.

It seems certain to be put into action unless there is a remarkable and almost immediate turnaround on the balance of payments and the official reserves positions.

If it does go ahead, however, the swop is unlikely to involve as much physical gold as the two previous swops — in 1976 and 1977 — when around 4-million ounces were mobilised each time.

However, with the gold price today well over three times the level of the average London fixings at the time of the 1976 and 1977 deals that is hardly surprising.

A total of at least R700-million was raised in those two operations.

The intention, assuming the 1981 swop goes ahead, will be to keep it within 1976-77 proportions.

Basically a gold swop involves using gold as collateral for a foreign loan.

It avoids selling gold, and thus depressing the market.

The profit for the lender comes in the fact that the gold is sold spot by South Africa and repurchased forward at an agreed higher level.

In 1976 and 1977 the swops led to large rises in the reserves because gold was then valued at its official price of R29,55 but could be used for foreign exchange worth very much more.

A gold swop now, with gold already at a marked-related value, would rather mean a change in the composition of the reserves than an increase.

Liquidity would be boosted.

Large short-term borrowings from overseas central banks have already been made this month by the Reserve Bank.

This follows the whopping fall in the official foreign exchange holdings of the bank in September by R476-million to only R263-million.

This does not mean there is a

By HOWARD PREECE

"reserves crisis".

The official gold holding is worth over R4 500.

Also, over the four years 1977-80 South Africa piled up surpluses of more than R7 500-million and made massive repayments of foreign debt.

The result was that the country was actually under-borrowed.

However, the current account is now back in deficit — R1 412-million in the first half of 1981 — and that puts the reserves under pressure.

More particularly, it has put the "cash content" — the foreign exchange component of the reserves — under special strain in recent weeks.

There has now been a big shift in official thinking on how to tackle this.

Even last month the view in Pretoria was that after the first line of defence — official borrowing from central banks — the next line would be to create of reversal of the outflow of trade finance.

This would be done by raising the forward dollar discount to the level necessary to make it commercially sensible for traders to switch heavily from borrowing locally to borrowing overseas.

Dr Gerhard de Kock, the Governor of the Reserve Bank, had said several times that as much as R2 000-million could be mobilised over the medium term this way.

Gold swops, which have some disadvantages in terms of the effective interest cost, were seen as the third line with borrowing from the International Monetary Fund as the backstop.

In any case the foreign exchange holding looked sufficient to cope with the help of official borrowing from overseas.

That last point was changed considerably by the huge September outflow.

However, the crucial point is that the authorities have changed their mind over the re-

spective priorities of trade finance reversals and gold swops.

The problem with trying to create a flow of funds into the reserves through trade switching is that it also has an expansionary effect on domestic money supply.

Although the growth in money supply was cut down to an annual rate of 14% for May to July (and even less in August) the running rate for the broadly defined M2 in the first four months of the year was a horrendous 53%.

With the latest 12-month rise in the consumer price index at 15,5% inflation is clearly the most pressing danger in the economy.

The advantage of a gold swop deal for foreign exchange is that it bolsters the reserves but has no direct effect on domestic money supply.

Indeed, in so far as it allows the authorities to let the current deficit flow on it permits a more restrictive monetary policy.

This consideration has proved paramount in Pretoria.

79

tot by die westelikste baken van laasgenoemde gedeelte; dan weswaarts, noordweswaarts en noordwaarts met die grense van die volgende gedeeltes van die plaas Honingklip 178 IQ langs, sodat hulle in hierdie gebied ingesluit word: Gedeelte 2 (Kaart LG 1864/98), Gedeelte 5 (Kaart LG A2196/23), Resterende Gedeelte (Kaartboek 194, Folio 43) en Gedeelte 115 (Kaart LG A6849/71), tot by die noordelike baken van die laasgenoemde gedeelte dan algemeen suidweswaarts en noordwaarts met die grense van die volgende gedeeltes van die plaas Honingklip 178 IQ langs, sodat hulle in hierdie gebied ingesluit word: Gedeelte 106 (Kaart LG A3065/69), Gedeelte 107 (Kaart LG A3066/69), Gedeelte 108 (Kaart LG A3067/69), Gedeelte 109 (Kaart LG A3068/69), Gedeelte 110 (Kaart LG A3069/69), Gedeelte 113 (Kaart LG A3072/69), Gedeelte 112 (Kaart LG A3071/69) en Gedeelte 111 (Kaart LG A3070/69) tot by die noordwestelike baken van laasgenoemde gedeelte; dan weswaarts en algemeen noordwaarts met die grense van die plase Zwartkrans 172 IQ en Weltevreden 517 JQ langs, sodat hulle in hierdie gebied ingesluit word, tot by die suidwestelike baken van die plaas Hartebeeshoek 502 JQ die beginpunt.

Portion 119 (Diagram SG A1186/68), Portion 118 (Diagram SG A1485/68), Portion 6 (Diagram SG A5982/05), Portion 110 (Diagram SG A3195/64), Portion 106 (Diagram SG A1152/62) and Portion 36 (Diagram SG A3395/45), to the westernmost beacon of the last-named portion; thence westwards, north-westwards and northwards along the boundaries of the portions of the farm Honingklip 178 IQ, so as to include them in this area: Portion 2 (Diagram SG 1864/98), Portion 5 (Diagram SG A2196/23), Remaining Extent (Diagram Book 194, Folio 43) and Portion 115 (Diagram SG A6849/71), to the northernmost beacon of the last-named portion; thence generally south-westwards and northwards along the boundaries of the following portions of the farm Honingklip 178 IQ, so as to include them in this area: Portion 106 (Diagram SG A3065/69), Portion 107 (Diagram SG A3066/69), Portion 108 (Diagram SG A3067/69), Portion 109 (Diagram SG A3068/69), Portion 110 (Diagram SG A3069/69), Portion 113 (Diagram SG A3072/69), Portion 112 (Diagram SG A3071/69) and Portion 111 (Diagram SG A3070/69), to the north-western beacon of the last-named portion; thence westwards and generally northwards along the boundaries of the farms Zwartkrans 172 IQ and Weltevreden 517 JQ, so as to include them in this area, to the south-western beacon of the farm Hartebeeshoek 502 JQ, the place of beginning.

### DEPARTEMENT VAN FINANSIES

No. 2162

16 Oktober 1981

#### WET OP DIE SUID-AFRIKAANSE RESERWEBANK, 1944

#### BEPALING VAN STATUTÊRE GOUDPRYS

Hierby word bekendgemaak dat die Minister van Finansies kragtens artikel 17A (1) van die Wet op die Suid-Afrikaanse Reserwebank, 1944 (Wet 29 van 1944), alle goud van die Suid-Afrikaanse Reserwebank met ingang van 30 September 1981 teen R375,29 per ons suiwer goud gewaardeer het.

No. 2166

16 Oktober 1981

Staat van Ontvangste in en Oordragte uit die Skatkisrekening vir die tydperk 1 April 1981 tot 30 September 1981.

Tesourie, Pretoria.

### DEPARTMENT OF FINANCE

No. 2162

16 October 1981

#### SOUTH AFRICAN RESERVE BANK ACT, 1944

#### DETERMINATION OF STATUTORY PRICE IN GOLD

It is hereby notified that, in terms of section 17A (1) of the South African Reserve Bank Act, 1944 (Act 29 of 1944), the Minister of Finance has valued, as from 30 September 1981, all gold of the South African Reserve Bank at R375,29 per fine ounce of gold.

No. 2166

16 October 1981

Statement of Receipts into and Transfers from the Exchequer Account for the period 1 April 1981 to 30 September 1981.

Treasury, Pretoria.

#### ONTVANGSTE—RECEIPTS

Inkomstehoof	Head of Revenue	Maand September Month of September		Totaal 1 April tot 30 September Total 1 April to 30 September	
		1981	1980	1981	1980
Skatkissaldo, 31 Maart 1981 Skatkissaldo, 31 Augustus 1981	Exchequer Balance, 31 March 1981 Exchequer Balance, 31 August 1981	R —	R —	R 214 788 279	R —
<i>Staatsinkomsterekening</i>	<i>State Revenue Account</i>				
Doeane en Aksyns Binnelandse Inkomste	Customs and Excise Inland Revenue	227 318 963 901 821 910	169 740 428 771 321 408	927 252 944 5 913 803 115	622 712 576 5 617 615 811
		1 129 140 873	941 061 836	6 841 056 059	6 240 328 387
Staatsheffings Nasionale Padfondse Suid-Afrikaanse Ontwikkelingsstrustfonde Rekening vir Swart Vervoerdienste Fonds vir Sorghumb. ernavorsing S W A Gebiedsinkomstefonds—Verkoopreg	State Oil Fund National Road Fund South African Development Trust Fund Account for Black Transport Services Sorghum Beer Research Fund S W A Territorial Revenue Fund—Sales Duty	25 049 468 2 454 621 1 179 000 1 900 150 —	21 512 630 10 797 607 459 000 821 378 —	147 100 086 74 732 463 6 768 673 7 171 674 1 081 137	133 229 531 67 573 225 6 564 552 6 839 014 950 000
		1 169 724 113	974 652 890	7 078 111 472	6 455 490 799

# West German union leader visits E Cape

Ev Post 23/10/81 Post Reporter

(120) (100) (73) (1/10/81)

A TOP West German trade union official, Mr Eugene Loderer, is in Uitenhage as part of a countrywide fact-finding tour of German firms associated with the motor industry, and for talks with trade union leaders.

Mr Loderer is president of both the German Metal Workers Union and of the International Metal Federation (IMF).

He was invited to South Africa by three Federation of South African Trade Union (Fosatu) registered unions which are also affiliated to the world body.

He is being accompanied by Mr Paul Plum and Mr Albert Schunk, both of whom are members of the IMF.

A Fosatu spokesman, Mr Fred Sauls, said Mr Loderer would also establish better "fraternal links" with local unions.

Yesterday he visited the Mercedes Benz plant in East London where he met shop stewards, workers and management. Later he held talks in Port Elizabeth with representatives of the Metal and Allied Workers Union, the Engineering and Allied Workers Union and National Union of Motor and Rubber Workers of SA.

Today Mr Loderer will visit the Volkswagen plant in Uitenhage before flying to Johannesburg, where he will have talks with various trade union leaders.

Before returning to West Germany he will attend an executive meeting of the IMF in Nuremberg.

# Gold's place as reserve asset to bolster currencies

RDM  
26/10/81  
79

LONDON. — Gold should be returned to its former position as a reserve asset to underpin the world's currencies — but at a more realistic and more flexible price, says Mr Paul Bureau, a financial commentator.

Mr Bureau, a consultant for the Mirror group newspapers, was delivering the 12th Wincott Memorial Lecture in London on a theme he described as "the decline of monetary morality over the past 35 years"

In recent years, he said, it had been commonplace to refer to the disaster and breakdown of the system of fixed parities un-

derpinned by gold, set up in 1946 after the Bretton Woods conference

"But let us first ask what went right. Bretton Woods gave the world, between 1946 and 1971, 25 golden years of reconstruction and unprecedented economic growth reconciled with a measure of dual stability of exchange rates and domestic prices which

must fill us with nostalgic envy today"

Until the early 1970s, confidence in the dollar was buttressed by its convertibility into gold. However, after the 1971 decision to suspend convertibility and the drift to floating rates that followed, a new type of reserve asset, the special drawing right was created by the International Monetary Fund. This was based originally on gold, but then on a basket of currencies.

"The dollar has long since ceased to be a reserve currency. It became overabundant, not only in the reserves of central banks and monetary authorities, but in the vast pool of Eurodollar liquidity sloshing around the money markets of the world"

Latest figures showed the dollar to represent 73% or \$290 000-million, of foreign currency reserves. The dollar element in the Eurocurrency pool was about \$525 000-million.

"The sum total, namely \$815 000-million, held outside the US may be likened to a massive sword of Damocles and suspended by the cord of confidence"

For the future, the best insurance against the abuse of power and status was convertibility of reserve currencies into a unit of account which was independent of national governments and which had some intrinsic value — "in other words a commodity standard"

It was a matter for debate whether this should be based on one commodity or a collection.

"My own preference would favour gold."

It was simple, it had a long history as a monetary metal and represented the largest element in international reserves today.

However, his idea of a multiple convertible reserve currency would not be a return to the old gold standard.

Firstly, convertibility could be limited to transactions between governments or central banks.

Secondly, a realistic gold price would have to be set and official intervention would be necessary to maintain it.

Furthermore, by international agreement, across-the-board changes in the official gold price would be needed to allow the adjustment of world reserves and international liquidity to the expansion of production, trade and investment.

The possibility of such adjustment was included in the original IMF agreement, but the clause was never invoked. If it had been, there would have been less incentive for the inflation of world reserves held in the form of currencies.

"Such a system would help

# Experts differ on future of gold

RPM 26 10 87

TOP foreign money and gold market experts last night expressed sharply divided views on whether the world could ever go back to some form of gold standard money system, or whether the American gold commission studying the reorientation of gold can be taken seriously.

They were expressing their views on the Springbok Radio programme Top Level, after interviews in New York and Washington with the SABC's economics staff.

A managing director of the biggest bullion dealers in the world, Dr Hans Schreiber of Dresden Bank in Germany, said the issues had to be clearly defined, but he was convinced that some link to gold would enhance the monetary system. He was convinced from his talks with representatives of the American gold commission that they were taking their task seriously.

A Wall Street investment analyst, Mr James Sinclair, said the American gold commission should be taken very seriously. He believed the United States would adopt some form of gold link to guarantee adherence to anti-inflationary policies once these policies had proved effective.

One of the largest foreign brokers of South African gold shares, Mr Michael Levison of New York, said in the same programme that a return to the gold standard was inevitable and that it would not help to set a price for gold anywhere below \$800 to \$1 000 an ounce.

But he did not take the American gold commission seriously, and a return to the gold standard would come suddenly and without warning.

An American investment consultant, Mr John Exter of New Jersey, said in his heart of hearts President Reagan was a gold standard man.

# Russia and SA sharpen skills in gold game

Star  
27/10/81  
79

From the Financial Times

LONDON — South Africa and Russia, the two gold powers at opposite ends of the international political spectrum, are sharpening their entrepreneurial skills in the world-wide bullion trading game.

They need all the help they can get. Both are suffering because the price is below the 850-dollar peak and, with both economies strained by soaring defence spending, Pretoria and Moscow are having to sell more gold simply to make ends meet.

## Diversified

The big two have diversified their marketing efforts to include all the main bullion centres rather than just the principal two, London and Zurich. Both are now trying out a new approach with their commercial banking friends in the West and are also experimenting with use of the forward markets.

Pretoria and Moscow adopt different tactics to sell their gold. South Africa is keen on maintaining a reasonably steady flow of supplies. Russia sells in sporadic bursts, keeps sales details secret, and tries to muddy the picture (and make extra profits) by buying gold as well as unloading.

The Kremlin's yellow metal strategists have complained at times that South Africa's steady sales unduly depress the price.

The two sides have always denied any form of collaboration in gold marketing, even though informal contacts in this and other fields of joint interest undeniably exist (next month South African and Russian representatives will be discussing joint promotion of karakul pelts and their gold-advertising campaigns have an extraordinary resemblance).

The sharp-eyed gold managers at the Soviet bullion trading bank, the Zurich-based Wozchod Handelsbank, made sales last year when prices rose during the Russian invasion of Afghanistan and the outbreak of the Iran-Iraq war.

They followed similar tactics this year during the Warsaw Pact manoeuvres in Poland. Moscow's involvement in some of these events may give the Russians a unique marketing tool.

Precise estimates of Soviet sales are impossible because Wozchod is continually buying and selling in different centres.

However, net sales so far this year are generally believed to have been from 100 to 150 tons. One dealer said that the normally coolheaded Russians "lost their nerve" during the past few months by unloading on an already depressed market.

South Africa, too, is in difficulties. Foreign exchange reserves are down to the lowest for

seven years.

Dr Chris Stals of the SA Reserve Bank has admitted that further swaps may have to be negotiated soon.

At a time when more gold needs to be sold, Russia and South Africa are aiming to spread it around as widely as possible.

The bullion dealers at Wozchod work nightshifts to enable them to keep in touch with the New York market right up to the close.

In Pretoria, the Reserve Bank general manager in charge of day-to-day gold operations, Mr Hennie Bester, has gone one step further. He has a Reuters video screen installed in his home so he can watch world-wide price developments.

● Dr Stals said today: "There is nothing new in all this. We have been diversifying our gold sales in various markets for several years. "We have been selling our full production of gold since late last year and are not trying to extend the market because of balance of payments difficulties."

He said marketing of gold was done by the Chamber of Mines and not by the Reserve Bank. If the advertising publicity for gold by Russia and South Africa were similar, it was "coincidental."

"We both have the same interest in marketing gold and obtaining the best price we can get," he said.

# Don't return to gold base say US inquiry members

WASHINGTON. — Six members of the US Gold Commission have opposed returning to a gold standard, while three others favoured a money system based some way on the precious metal.

That was far from a full vote by the 17-member commission. Four members expressed no clear opinion at the panel's third meeting on Monday. Four others were absent.

But the tally made it clear there is a substantial body of opinion within the commission against either an international or domestic gold standard. Several members, not yet heard from, are expected to side against gold.

The commission was established by Congress to consider a possible role for gold in the monetary system. It is scheduled to hold public hearings in November and make its report on March 31.

The United States has not followed a gold standard — that is, the dollar has not been convertible to gold at a fixed price — since 1933 for domestic purposes or since 1971 internationally. Nor is the international trading world on a gold standard.

Advocates of a gold system argue that basing money on gold — a commodity whose supply grows slowly — would automatically put the brakes on inflation.

Two commission members, Lewis Lehrman, a businessman, and Arthur J Costamagna, an attorney, favoured making the dollar again convertible to gold. Mr Lehrman said this was the only way to achieve low interest rates.

A third proponent, Representative Ron Paul, Republican-Texas, proposed "a true gold standard" in which gold and gold certificates fully backed by gold would be the only money and the present dollar would disappear.

Among opponents, Representative Henry Reuss, Democrat-Wisconsin, said the present domestic and international monetary system "is the least bad of the alternatives".

Also in opposition were three governors of the Federal Reserve Board who serve on the gold commission: Henry C Wallich, Emmett J Rice and J Charles Partee.

Mr Wallich said: "There is no good way of going back to the old system."

Mr Partee said it could not be done without an international agreement. The rules of the International Monetary Fund, of which the United States is a member, currently ban gold standards. — UPI.



# Mines miss out on \$1bn by failing to hedge

RDP 30/10/87

79

LONDON. — The mining houses could have saved the gold-mining industry and South Africa's foreign exchange reserves as much as R1 000-million had they hedged only 15% of SA's gold production in the second half of last year.

If the houses had sold forward only 3 500 000 ounces, they would have covered production and profits of the 12 highest-cost marginal producers.

Several mines are receiving State aid and the way the gold price is behaving more could be financed by taxpayers soon.

In June 1980, Dr Chris Stals, head of the Reserve Bank's gold and foreign exchange operations, said the gold mines could insure themselves by selling production forward on the futures market.

Dr Stals especially favoured hedging by marginal producers. It was clear from subsequent interviews, which were published in Business Mail, that the Reserve Bank was only too willing to give the houses permission to use the US futures markets or forward facilities offered by European bullion houses.

## Reluctant

Most mining-house chiefs and other executives were reluctant to acknowledge the advantages of hedging and did not accept the Reserve Bank's offer.

Later, Marievale and Hartebeestfontein experimented successfully with hedging, but the amounts were small.

Here is what could have happened had the mines hedged only 15% of their production to insure high-cost marginal producers in an uncertain gold market. The average price of gold was \$638 in the second half of last year and the average one-year contango for one-year forward sales on the US futures markets was about 14%.

This meant that the mines could sell gold futures in Chicago or New York at an average price of \$727.

A year has passed and the current price of gold is about \$300 lower than the \$727 on the futures sale.

## NEIL BEHRMANN — the great gold blunder

By this time the mines would have covered the short hedge for a profit of \$300 an ounce.

This profit would have covered the dramatic revenue loss from the decline in the gold price this year.

This revenue would to a large extent have prevented the 24% rand devaluation against the dollar. Although the devaluation helps the mines it has an inflationary effect on the rest of the South African economy.

According to Mr Albert Loveless, head of mining research at London stockbrokers Simon & Coates, a dozen of the highest-cost gold mines produce 3 500 000 ounces of gold a year.

These mines could have saved \$1 050-million had they hedged their production.

The extent of the mining house blunder — as some analysts see it — can be appreciated when one considers that if the gold price continues to stagnate most of these mines and probably several others will receive State aid to keep them operating.

## Seriousness

After estimating working costs, capital expenditure and deducting uranium revenue, Mr Loveless calculates from the September quarterlies that West Rand Cons costs were \$725 an ounce, Elandsrand \$526, ERPM \$523, Western Holdings \$475, Lorraine \$470, Durban Deep \$412, Western Areas \$397, Venterspost \$395, Deelkraal \$388, Marievale \$336 and Vlaktefontein \$332.

Assuming working costs rise by 20% in the coming year, Vlaktefontein's costs will be just under \$400, only 7% below the current gold price.

This illustrates the seriousness of the situation. The reply of mining house executives over the past year has generally been: "It is easy to be wise after the event."

Their job, however, is precisely to be wise before the event — as several commentators were.

Some mining-house executives still believe that hedging is speculation and not insurance.

Recently Mr "Dammy" Watt, chairman of Rand Mines gold division and of ERPM, told the

Financial Times: "Do you ever hedge when you believe that the price is in a trough and may be rising?"

In August last year ERPM announced a R300-million expansion programme and management was confident that provided gold averaged \$600 for five years, the expenditure would be funded internally. The mine also raised R47 500 000 from a rights issue.

## Pruned

But what is that if it is not speculation on the prospects for the gold price?

Earlier this year Mr Watt announced that the expansion had been pruned.

In August last year ERPM would have been able to hedge its gold production up to two years forward.

One-year gold futures were nearly \$800 and in Chicago two-year gold was well over \$800.

If ERPM had sold 300 000 ounces, or only 3 1000 gold futures contracts, in New York or Chicago it would have had a guaranteed price of \$800 or more for two years out of those five years.

Assume, however, that the price was then "in a trough" and rose to \$1 000.

There would have been a loss of \$200 an ounce on the futures market, or \$60-million.

But ERPM would have sold its

gold production to the Reserve Bank at \$1 000, so the profit of \$60-million on the physical sale would have offset the loss on the futures transaction.

## CASH FLOW

ERPM was thus assured of a price of \$800, well over the budget of \$600 an ounce for its expansion project.

This would have yielded \$60-million a year over and above the projected price of \$600 an ounce.

In two years the mine would have guaranteed a cash flow of \$120-million, a large proportion of the cost of the project.

Sadly for ERPM gold was not "in a trough" and is now \$370 lower than the then forward guaranteed prices.

On 300 000 ounces, which is about 80% of ERPM's production, the mine has wasted potential profits of \$111-million. The expansion project has been virtually scrapped and to keep production going the mine will be asking for State aid.

All this could have been prevented had ERPM — and other mines — insured against uncertainty in the gold market by hedging on futures.

The opportunity cost has been enormous and some analysts believe this will one day be known as one of the great blunders of the South African mining industry.

Shareholders will no doubt question their chairmen about this mistake at the coming annual meetings of gold mines.

Anglovaal warns on consequences of price fall

# Gold—still SA's soft underbelly

RDM 30/15/81 79

A LOWER dollar gold price has a direct and detrimental effect on SA's balance of payments, and if it fluctuates at levels lower than in the past year even harsher monetary and fiscal policies will have to be pursued.

This warning is given by Mr Basil Hersov in his chairman's review of Anglo-Transvaal Consolidated Investment Company (Anglovaal). He says such a development will have an inhibiting effect on the growth of industry and must affect industrial company profits.

The belief of some economists that the South African economy over the past generation has been moving away from its dependency on the gold and other mining industries has proved incorrect.

"The fortunes of South Africa and the Anglovaal group, which in many respects is a microcosm of the SA economy, still depend very much on gold and other mining activities and will do so for the foreseeable future," says Mr Hersov.

Erroneous predictions, constantly made, prove that the future gold price level is impossible to assess as there are too many intangible factors at work for any rational short-term forecasts to be made.

In calculations relating to new mines or capital expenditure on existing mines volatile factors, such as exchange rates, inflation, price fluctuations and interest rates have to be taken into account.

"In all these matters we bear in mind that the gold price, being so central to our fortunes, has long since become an emotional issue where objectivity is nearly impossible."

For this reason, it is important to pay attention to both the pro-gold and anti-gold lobbies to maintain some perspective.

Greater sophistication has become necessary in the marketing and financing of mineral products taking into account the numerous futures and forward markets that exist, and the hedging made possible against movements in prices and exchange rates, as well as in interest rates.

"We believe that the best policy to pursue under all these circumstances is one of prudence and flexibility, combined with the broadest use of new techniques and skills."

Mr Hersov says financial results in the current year indicate improvements in most group companies. Subject to the usual provisos on the uncertainties of world metal and mineral prices, and no serious deterioration in the South Africa business climate, Anglovaal is again budgeting for high profits.

Attributable profit in the year to June rose to R47 654 000 from R38 074 000, and earnings rose by 25% to 1 121c a share.

Earnings growth in the past year resulted from higher dividends from mining investments and the considerable increase in the earnings of industrial subsidiaries.

The market value of the group's listed investments at June 30 was R302-million, compared with R266-million at the end of the previous year, and by October 2 the market value had risen to R407-million.

Anglovaal's industrial interests, which in the past year accounted for 41% of group income, reached an aggregate turnover of R1 000-million, and pre-tax profit of about R100-million.

All industrial companies in the group, with the exception of Denver Metal Works (Pty), performed satisfactorily, say Anglovaal's directors, with profit gains augmented by the contributions from Grinaker Holdings, Bakers and RISA Investments.

Since January this year there has been a slowing down in the economic growth rate, and although this cyclical trend is expected to persist throughout the financial year, the industrial group (ATI) expects to improve profits.

Mr Hersov says the financial strength of Anglovaal's subsidiaries has been improved in recent years by adopting conserva-

tive dividend policies, leading to substantial improvements in debt-equity ratios.

Anglovaal's search for gold, coal and base minerals was maintained at a high level during the year, with drilling programmes for gold in progress in the Free State and Western Transvaal.

In two areas of the Eastern Transvaal, where exploration is being undertaken in partnership with Anglo American Prospecting Services (Pty), drilling results have been disappointing, and the options over one of the areas are being abandoned.

Drilling continues in the remaining option area, says Mr Hersov, but it is not possible to forecast results.

Drilling of the various base mineral occurrences has been completed, and although studies of the results are still in progress, the development of a mine on these areas is unlikely.

Coal exploration has been intensified, with several areas prospected and additional reserves located in the Witbank and Bethal districts.

Mr Hersov says an assessment of total reserves will be made after more detailed drilling is completed in the current year.

SA's total coal exports will only reach the limit under existing export quotas in 1985-86, says Mr Hersov, but Anglovaal on its own behalf and that of its partners has for some years had an application for an export quota before the authorities.

The group has also applied for a licence to produce methanol, and a decision is awaited from the Minister of Mineral and Energy Affairs.

Mr Hersov goes no further on the Venetia diamond deposit in the Zoutpansberg district.

By JOHN MULCAHY

Even the sliding dollar fails to help

# Gold — down in the dumps

79 RDM (B.V) 3/11/81

CLOSING prices: London \$431.75; Paris holiday; Frankfurt \$432.98; Zurich \$430.50; Hong Kong \$432.78.

LONDON. — Dealers say gold has made disappointing progress in recent days in spite of a sliding dollar on foreign exchange markets.

Although gold has bounced back above \$430 the belief is that if it was in and firm upturn it should have already gone over \$440.

As US interest rates have fallen the dollar has tumbled by more than 6% against the Swiss franc and by more than 4% against the mark and sterling.

But in the same-time gold has staged only a 1% gain — a weak response to the currency moves.

On October 26 when the dollar was still firm, gold was trading around \$425. Had it reflected the decline in the value of the dollar since then, gold should have been over \$440.

Putting it another way, gold has actually fallen against European currencies. "It is all so sick and depressing," said a London bullion manager yesterday. "The market appears quite dead."

"The outlook is difficult to see. Either investors will be so disappointed that they will sell into the market and we will see a sharp crack, or they will say to themselves that gold is cheap and we will see a sharp rally."

A Swiss bullion manager said

gold's performance reflected a weak market.

"In line with my views for over a year I still remain a devoted bear," he said.

The Swiss manager said fabrication demand had improved in Italy, but it was not sufficient to offset higher sales from South Africa and Russia.

Middle Eastern demand was weak and investors were shying away from gold.

Another Swiss bullion manager said the gold market seemed in a narrow trading range of \$420 to \$440 and it might stay that way for some time.

"I am completely neutral. There is not much incentive to send gold higher or lower," he said.

He said marginal gold producers should hedge their sales forward.

"They can take advantage of the interest factor. For example, one-year gold futures are trading at \$490, a premium of 14% over the spot price."

## By NEIL BEHRMANN

The dollar has declined sharply because Salomon Brothers interest rate guru Dr Henry Kaufman predicted that US short-term interest rates would fall.

Soon after the forecast the Federal Reserve cut the discount rate by 1% to 13%.

US banks have cut their prime overdraft rates to 17.5% from over 18% a few weeks ago.

New York financial markets went wild with delight and there was a sharp rally in stocks and shares.

Dr Kaufman predicted that money market rates would continue to decline.

But overlooked amid all this was that Dr Kaufman had been saying all along that rates would soften until the end of the year, but would then surge to new highs — a warning he reiterated last Friday.

There has been a change in emphasis, however. Two weeks ago Dr Kaufman said that the upturn would occur within six months. Now he forecasts that the new highs will be reached within the next 12 months.

A London foreign exchange manager said yesterday there was still considerable borrowing pressure in the US and companies and individuals would soon step in to take advantage of low-

GOLD edged up yesterday. It was fixed at \$430 in London in the afternoon and at \$431 in the morning. Friday's second fixing was \$427.

It rose \$6.51 in Hong Kong to close at \$432.78. The price rose on the back of an easier dollar, surging to the day's high on short-covering around the close.

The dollar dropped to 230.35 yen in Tokyo, down from the day's opening of 231.90 yen and Friday's 233.35 yen.

The dollar stabilised in the afternoon session after falling to the day's low of 230.20 yen.

In London, the dollar made up some of the ground lost in the wake of Friday's US discount rate cut. It was helped at mid-session by short-covering and commercial orders in quiet trading.

The dollar rose to a midday 2,225.70 marks and subsequently 2,228.5/2300 marks after trading down to 2,201.5/30 marks in Hong Kong.

For this reason he thought that the dollar would rally or at least stabilise.

A currency economist at another bank predicted that the markets would remain uncomfortable for the next two to three months.

"Interest rates and currencies will remain erratic during this period," he said. "Gold is probably relatively weak because people are expecting lower inflation rates next year."

Trading in the pound was nervous because of the strike at State-owned B.L.

The dollar recovered as initial selling appeared to have been overdone, and banks and corporations took advantage of the lower levels to buy dollars.

Dealers said early trends reflected new positions at the start of the month and a view among some operators that the sharp fall in the dollar in New York late on Friday might have been overdone.

# Gold <sup>11/11/81</sup> tumbles <sup>(79)</sup> to \$418,50

## Financial Reporter

GOLD took a sharp tumble in London yesterday, dropping to \$418,50 at the afternoon fixing.

That compared with \$422,75 in the morning and \$429,75 at the second fixing on Monday.

Dealers said the lower price was in line with lower levels in late US trading on Monday where the implications of an imminent US recession offset possible gains the metal might have derived from the decline in US interest rates.

Stop-loss selling and small profit-taking also depressed the market yesterday, they said.

On foreign-exchange markets in London the dollar remained underpinned by short-covering in moderately active midsession trading, dealers said.

The dollar traded at a midday 2,2190/2200 marks after rising to an early 2,2215/25 from the opening 2,2103/13.

# Gold plunges through \$400

... while platinum hits 1981 low

ADM (B.M.)

18/11/81

79

By NEIL BEHRMANN

LONDON. — Gold plunged through \$400 for the first time since August 11 in active trading in London yesterday and dealers reported that there was also heavy selling from Switzerland.

The morning fixing was \$395.75 compared with \$404.25 on Monday afternoon.

It recovered a little \$398.75 at the second fixing.

After hours dealers quoted \$398.50/\$399.50.

Platinum was particularly weak yesterday, touching a 1981 low of \$375, exactly \$100 below the producer price of \$475.

Such is the weakness in the platinum market that some dealers believe that Impala will announce a production cut at its annual meeting today.

Silver fell to \$8, a third lower than the trading range which was seen only a few months back, while copper, accompanied by a slide in base metals touched a new 1981 low of 72.40c a pound in New York.

Gold was over \$450 three months ago but has been steadily falling since.

High interest rates and a general investment disenchantment with bullion seem the main reasons.

The slump in the platinum industry illustrates what is happening in the metals markets.

Platinum was fashionable as an investment in 1980 and wealthy people, including Arab sheikhs, bought the metal as an inflation hedge in 1980.

Yet at that time the fundamentals were already deteriorating because the US automobile industry was at the start of a long protracted slump. While industry was buying less, investors were absorbing the surplus metal from producers.

In fact the South African producers were far wiser than their gold mining counterparts because they sold metal forward at much higher prices on the futures markets, covering themselves against the sharp decline in the demand for their physical metal.

But the platinum companies also sell by-products, such as palladium, nickel, cobalt and copper and the slump in these

metals prices, especially palladium and nickel, has had a severe impact on true profitability.

Actual profitability was higher because of the devaluation of the rand against the dollar.

Although Rustenburg refuses to talk to the Press and to comment on the state of the market it was quite evident that conditions have been deteriorating.

The palladium price is currently trading at \$70 an ounce, 50% lower than Rustenburg's producer quote of \$140. It is widely known that the producer price is meaningless and that Rustenburg is offering discounts.

The mere fact that Rustenburg refuses to talk to the Press is a good enough indication that the market is bad.

Before the chairmanship of Mr Gordon Waddell, executives were prepared to comment on their products but, of course, at that time platinum was in a bull market.

The producers problem has been compounded because the investors who bought in 1979 and 1980 have turned sellers and each new bout of selling has put further pressure on the price.

It is now widely believed that the producers are already in the process of production cuts. If they have not actually pared output they are working at lower capacity.

In the annual report of Impala Platinum, chairman Mr Ted Pavitt warned that US automobile sales were being closely monitored.

"Adjustments to the production programme have already been made and the present rate of production is some 940 000 ounces an annum," he said.

Since the publication of that report in early September, there have been dramatic cuts in US automobile production, leading the platinum market to believe that further production cuts will be announced.

The decline in metals prices have been accompanied by dramatic falls in short-term interest rates.

# Gold mining industry vulnerable to inflation

Argus 2/11/81

79

**INFLATION has been called a silent thief and the aptness of the description will be obvious to anyone who has been trying to build up a nest-egg lately.**

It is not that inflation reduces the number of rands you may possess. What it does do is to curb greatly their buying power.

As a result you need far more of them to make a purchase than used to be the case, as anyone who has tried to buy a house recently will be well aware.

In the past 12 months inflation has averaged about 15 percent. But recently it has started to accelerate and has now been running around 20 percent when calculated on an annual basis.

This is a high rate even by world standards and a record rate for South Africa. If sustained it could have serious consequences for everybody in this country.

Unfortunately, people do not fully realise just how insidious and deadly

## Investment

By DEREK TOMVIEY

inflation is to their well-being.

At a 20 percent inflation rate the purchasing power of money is halved in less than four years and reduced by three-quarters in just over seven years.

It means that what costs R1 today will cost R2 in 1985 and R4 in 1989.

This is not a happy prospect for anyone on a fixed pension or for anyone planning to go on pension soon. In fact it must be obvious that in these conditions people should defer retiring and going on pension as long as possible if they have no other job to go to.

But it is not just the aged that will be hit by the high inflation.

### PRIME FORCE

In spite of the growth of manufacturing, the gold mining industry is still the prime force in the South African economy. However, it is extremely vulnerable to inflation.

Every time the industry's working costs in-

crease the amount of gold it can mine at a profit is reduced. So inflation not only reduces the industry's profits but also shortens its working life.

Only if there is a compensatory increase in the price of gold can the industry avoid this situation. But as the rate of inflation accelerates, the compensatory increases in the gold price have to be much greater.

Given the present rate of inflation, the gold mining industry will need an 80-dollar increase in the gold price in the next 12 months just to stand still and maintain its position.

This may seem an excessive increase. But you only have to contrast the gloom in mining circles at the prospect of the gold price going below 400 dollars an ounce with the euphoria just over two years ago when the gold price exceeded 250 dollars for the first time, to realise how damaging in-

flation is to the gold mining industry.

And because of gold's role as the economy's prime mover, the inflation is also damaging to the country as a whole.

### MONEY SUPPLY

It is obvious that the Government will have to curb this inflation if people are going to continue having any faith in money at all.

It is true that the Reserve Bank is at last getting the money supply under control but there are increasing doubts whether this alone will bring the inflation rate down.

It is obvious that the question for South Africa to try to emulate Britain and squeeze inflation out of the economy in the way that Mrs Thatcher's Government is doing there.

If South Africa were to try this it would run the risk of having another 'Soweto' disturbance on its

hands and make the cure worse than the disease. However, there is a school of thought that believes squeezing the economy would not curb inflation in any event.

### PROTECTED

This school maintains that one of the major causes of inflation in South Africa is the fact that the economy is nowhere near as free as people like to think.

A large number of producers and manufacturers in South Africa are protected from foreign competition by tariff barriers or by physical controls.

It is argued that this and the high degree of concentration of economic power results in many prices being fixed on the basis of cost plus profit rather than by free market forces.

As a result, neither the Government nor the private sector has much incentive to keep down prices, and this is especially so when the economy is booming.

It is contended that, any wage increase given to meet increased costs are quickly translated into price increases and so the

whole cycle carries on unchecked. This has led to the suggestion that the best way to counter inflation in South Africa would be to delink prices from costs and in this way break the cycle.

In practice it would mean that the Government would have to impose a full or partial freeze on prices.

However, the Government appears to be rather chary about such a move. It is probably concerned about the effect such a move would have on its political base.

Maize farmers in particular would be extremely upset if the price of their produce was frozen before the next price revision and the Government relies to a great extent on platteland support.

A lot of other people would also not like a price freeze.

But it seems that, the Government will soon be forced to take more action than it is at present to curb inflation.

If it does not, it stands to lose the support of the town and city dweller, and especially the aged.

BRIAN KANTOR AND DAVID REES

79 FM 27/11/81

# Gold and real interest rates

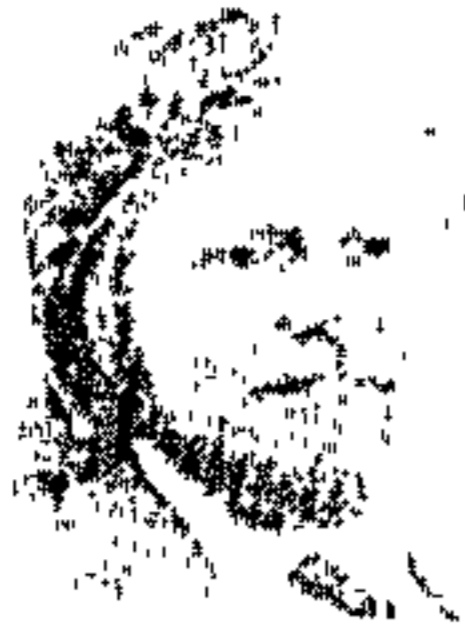

Brian Kantor (left) is an associate professor and David Rees (right) a senior lecturer in the Department of Economics at the University of Cape Town.

It is by now clear that the Seventies was a disastrous decade for savers. High inflation was associated with negative real interest-rates and growth rates were low. The gold price, in contrast, was buoyant. It rose five or six times faster than the consumer price index, as did the prices of other commodities such as platinum.

It is generally agreed that the high gold price is associated with high inflation rates and the expectation of high inflation rates in the future. Clearly, the gold price reflects, in some sense, the discounting of future inflation rates.

The difficulty in explaining the gold price, however, is that a simple association of the gold price and inflation is not satisfactory. A change in the expected inflation rate would alter the future gold price and nominal interest rates and the spot price of gold would not necessarily change.

Gold competes with other assets for a place in an investor's portfolio and hence must necessarily offer the same expected rate of return as assets which are substitutes in portfolios. If the interest rate offered by government bonds is 5% a year, investors will only buy and hold

gold if they expect the gold price to rise by at least 5% a year, otherwise bonds would be more attractive — they would sell gold and buy bonds. The gold price would fall until it reached a level where a 5% a year appreciation in price would be expected.

If today's gold price is \$400/oz and the interest rate is 10% a year, the price a year hence is expected to be \$440/oz. An increase in the nominal interest rate, because more inflation is expected, will leave the current gold price unchanged at \$400/oz, but change only the expected future price of gold.

It may be observed on the commodity exchanges that the future and spot prices of gold are related by market interest rates. Arbitrage between the money and gold market maintains this close relationship: Current value = Expected future value.

Increased inflation causes the expected future price of gold to increase, but this increase could be compensated for by an increase in the discount rate, that is, leaving the current value unchanged. Clearly, some other force influences the spot gold price. The real interest rate is the difference between nominal or published interest rates and the inflation rate. Changes in the real interest rate, in contrast to the nominal interest rate, would not leave the current price of gold or other real assets unchanged.

An increase in the real interest rate implies that the real return on capital and investments is expected to be higher in the future. In other words, in future, because capital has become more productive, consumption goods will be more abundant. Gold, which represents a claim on these future goods, must fall in

price. Gold and other assets are held because they are a claim on future consumption goods. With higher real interest rates, the supply of "goods tomorrow" will increase at a faster rate relative to "goods today" and, accordingly, the price of future goods today, represented by gold, must fall.

The evidence of the Seventies shows that higher inflation rates have been associated with lower (in general, negative) real interest rates than were realised in the Sixties. An inflationary environment is a less predictable environment. Plans are more likely to go awry, investment is discouraged and risks increase.

Accordingly, during periods of inflation, less real investment is undertaken and the reduced real demand for loanable funds means lower real interest rates — that is, while nominal interest rates rise, they rise by less than inflation. Higher inflation is also associated with lower real rates of economic growth — that is, the supply of future goods increases at a slower rate.

This variation in real interest rates is related to variations in the gold price in a statistically significant way. Low real rates of interest — that is, the low real return in savings and investment and slow growth which are correctly associated with inflation — made gold and other real assets much more attractive to hold in the Seventies. The gold price does not dance to the tune of inflation, nor to nominal interest rates. These variables affect the future gold price only. It is variations in expected real interest rates which cause fluctuations in the gold spot market, as in all the other markets for assets.

# The flame flickers

(79) FM 27/11/81

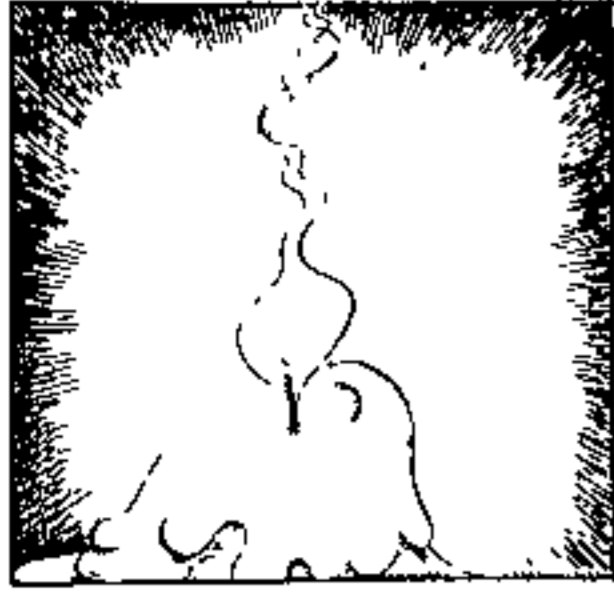

Life appears to be flickering out of the gold market. The price is having increasing difficulty holding its ground above \$400 and chartists are now talking bullion down below

\$350. Meanwhile, relying on recent conventional theories to predict when new life will be breathed into bullion's price is of dubious value. But the question of where gold is headed is becoming increasingly important not only to investors but to the mining industry which, for most of this year, has been able largely to ignore dollar price movements.

For the past two quarters SA's gold mining industry has been protected from the problem of lower dollar gold prices and unit costs rising at an annualised 20%-odd by a sharp deterioration in the rand:dollar exchange rate. The rand's value has slipped to its present \$1,03 from \$1,35 at the start of the year. With that, rand revenues/kilo of gold have actually risen on average even though bullion has slipped from just less than \$600/oz at the start of the year to its present trading range around \$400.

Now, however, the rand appears to be stabilising against the dollar as more restrictive monetary policies began to bite. The implications of that for the gold mines are worrying — at least in the near-term.

Unit costs were kept under control in the September quarter as the industry pushed more tons of ore through its mills. But there are limits to that, and the next couple of quarters could see the basic cost trend re-emerge. If the rand now holds against the dollar, the main hope for maintained or higher gold mine profits is an early improvement in the gold price. Prospects in the next six months or so do not, however, look all that bright. Beyond that is anyone's guess, though the trend has the greatest chance of being upwards.

As Dr Henry Jarecki, the chairman of Mocatta Metals Corp, put it at the FM's Investment in 1982 conference last week, the pattern of the Saudis buying as much gold as possible at \$400 and the Russians selling as much as possible at \$450 should probably be adjusted downwards by between \$20 and \$30 to be relevant for the next few months. He added that random political events will continue to spasmodically and temporarily boost the gold price, but that the major gold price determinants will be economic and political developments in the US.

Predicting those is rather like walking through a minefield. On one hand there are those who believe that supply side economics — stimulating output through tax rate

reductions — provide the answer to all of America's problems. On the other are the ardent detractors of the dollar who believe that it is only a matter of time before the US starts suffering from hyper-inflation. The truth clearly lies somewhere between the two extremes.

For the present, the Reagan administration is maintaining its vigorous plan to cut government spending. But can it go on?

Near-term prognostications by economists in the administration are for a further deepening of the US recession. Smokestack America is steadily revising downwards its estimates of near-term output as factory orders continue their decline. And that is being exacerbated by latest unemployment figures which show that 8% of the workforce is now on the streets. That poses the administration, which has to consider next year's congressional elections, an apparently immediately intractable problem.

An unemployment rate of 9% is generally considered to be political suicide. And as that level approaches — as it may if the Reagan programme of tax cuts fails to stimulate the economy — pragmatic politics will lead to reappraisal of the federal spending programme. But just such a move would tend to broaden the projected budget deficit. One of the cornerstones of Reaganomics is that tax rate reductions would increase national output. That would eventually lead to an absolute increase in tax revenues which, coupled with lower government spending, would cut into the federal budget deficit. The Reagan administration could, next year, find that political pressures force it into spending more while its tax or revenue base has declined.

Basically that is a recipe for rising inflation and, if the past can be taken as an indication of the future, a revival of interest in gold as an inflation hedge. Things may not be quite that simple.

High American interest rates have been



Mining gold . . . but which way the price?

at the root of gold's price weakness for most of this year. It simply became more attractive for investors to put their money into US fixed interest stocks rather than bullion. But the converse — that once interest rates fall, interest in gold will revive — is not necessarily true. The prime rate in America has been falling steadily for several weeks and gold has fallen at the same time. The reasons are varied.

An increasing supply of physical gold has been reaching Western markets from a Soviet Union which is suffering from its umpteenth poor harvest in a row. The Russians are selling gold to pay for grain imports. And the Soviet situation is bad. It may sound ridiculous, but the fact that the price of dog and cat licences in Russia has been sharply increased (to equal a month's average salary) merely underlines the problem. By some logic, apparently, Soviet economic planners reckon that higher licence fees will cause Russian pet owners to have their animals put down. That, in turn, should lead to lower demand for meat and therefore for grain imports. That's how bad it is.

When that increase in supply is set against American gold purchases which are well below year-ago levels because of de-stocking by industrial consumers, short-term gold price prospects are poor. However, de-stocking can only be taken so far. In 1980, for example, US commercial gold stocks rose by 2,5m oz. They fell by 1,6m oz in the first half of this year, so it is reasonable to believe that in the very near future US absorption of gold will reflect more closely the economy — or, more precisely, investment and industrial demand.

This year the US has been a net supplier

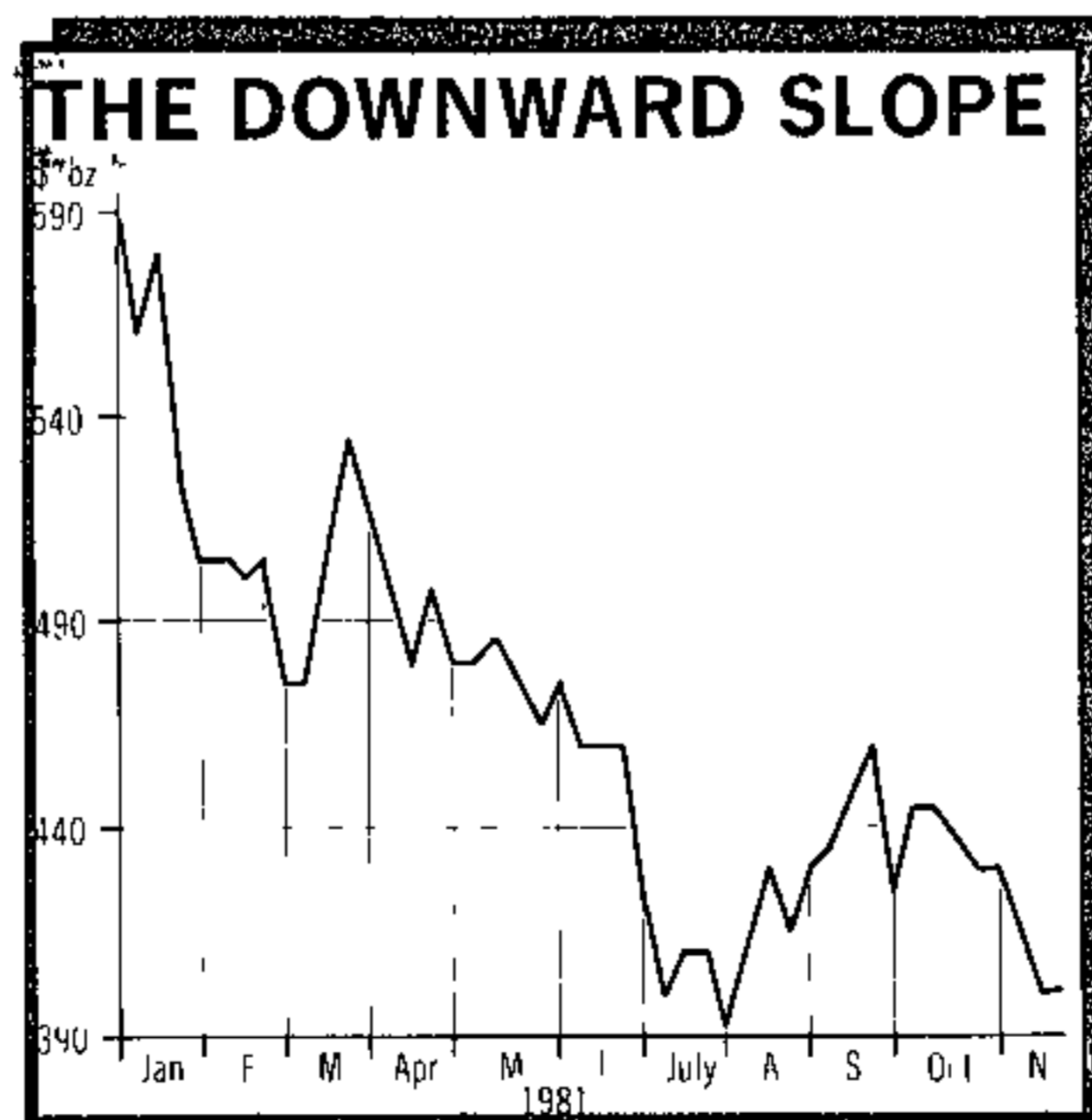

PLEASE TURN OVER



# Global tensions no longer give gold market a boost — Unisel

(79)  
Star  
21/12/81

By Mervyn Harris

It is questionable whether the reintroduction of a formal link between gold and the dollar would be beneficial for gold, Mr E Pavitt, chairman of Unisel Gold Mines, says in the annual report.

However, the appointment of the US Gold Commission to formulate a policy approach to the monetary role of gold reconfirmed gold's growing monetary importance.

This was even though its role in the international monetary system was

again not discussed at this year's meeting of the International Monetary Fund.

Mr Pavitt says that a new feature of the gold market has been increasing insensitivity to global tensions and political instability compared with the past.

In a year in which labour unrest in Poland continued to command world attention, and conditions in the Middle East were far from stable, gold reacted only marginally and briefly to individual incidents which, in previous years, would have signalled more sustained and

dramatic price movements.

The reason for this change of attitude on the part of buyers is not easily explained, says Mr Pavitt.

It would seek, however, that the world community is inured to uncertainty, and that only a high probability of global conflict in the event, for example, of a cessation of oil supplies to the West, would push the gold price higher to new sustainable levels.

## Promising

Recessionary conditions in most world economies, the stabilisation in the oil price, expectation of lower inflation rates and high US interest rates, have detracted from the appeal of gold as an important hedge asset.

Mr Pavitt says, however, that the outlook over the longer term remains promising.

79 Star 22/12/81

# Krugerrand sales rise in Hong Kong

By Richard Breeze

**HONG KONG** — Mr Bernard Denet, Intergold's chief executive, forecasts that sales of Krugerrands will rise to 200 000 ozs in Hong Kong in 1982 from 154 000 ozs this year.

Mr Denet told businessmen in Hong Kong that sales of the coins had slipped back 10 percent in 1981. But that total turn-

over remained at 365 000 ozs.

Mr Denet said that the outlook for gold was bearish in the short-term, but bullish in the medium and longer-term.

He stressed Japan's new role as a gold importer in November, Japan imported 41 tons of gold, making it the world's largest net importer.

During the year, Japan bought 19 percent of the world's total supply of between 200 and 220 tons more than three times the 1980 figure.

Japan would lead the gold sales market particularly when its banks were allowed to sell gold from April 1982.

The Japanese, he said, saved around 20 percent

of their income but were only now turning to gold.

Mr Denet said that the Hong Kong Government was currently studying a report submitted by Intergold which recommended the establishment of an assay laboratory in the British colony — a major gold trading and jewellery retail centre — to check the caratage stamp on local jewellery.

# Higher gold price in 1982 will curb mounting deficit

(79)

Star 24/12/81

## - Commerce chief

By Ann Crotty

A higher gold price in the second half of 1982 will help to reduce the large balance of payments deficit

which is currently building up, says Mr Martin Keyser in his presidential message to the Johannesburg

Chamber of Commerce.

Mr. Keyser said that there were a number of factors which indicated that 1982 would be a very challenging year for the private sector.

These included the Government's serious attempts to reduce in relative terms its direct command over the economy's productive resources, the expected strengthening in the gold price and indications that the struggle against inflation was meeting with some success.

Reviewing the past year Mr. Keyser pointed out that the growth rate of between 4 and 4,5 percent had resulted in rising income levels, more secure employment and increasing optimism regarding future income prospects.

One of the disadvantages of this trend was that consumers had been encouraged to raise their living standards by increasing the consumption proportion of their personal disposable incomes.

14—Savings down

### More willing

"Not only have consumers become more willing to commit larger amounts of current income towards consumption, but they have also committed increasing proportions of future income forward. The result has been a decline in personal savings."

However, Mr Keyser expected the economic slowdown and high finance charges to increase the proportion of personal savings during 1982.

Next year, which is expected to show a growth rate of from 2 to 3 percent, should be seen not as a difficult year, but as a period of consolidation, and it should be used as a springboard for the anticipated upswing in 1983.

Mr Keyser felt that one of the major difficulties facing South Africa next year would be the weak export markets.

May I draw your attention to the fact that nearly all these financial statistics are somewhat old. These, just given, are 16 years old.

The Chairman, Dr. Wallace Fox of the U.K., M.R.C., made this last remark - "This is a very serious situation. We use regimens with 80, 90, or 100% potentiality and then, in practice, are having only 50% success."

Where seems to be the fault? If you agree with the above statement, then three factors are left.

(i) Lack of money spent on the best bacteriocidal drugs;

(ii) Following of the drugs;

# Russia may aid Polish debts to West

London Bureau

LONDON. — Russian activity in the gold and foreign exchange markets over the last two weeks has prompted speculation among Western banks that the Soviet Union may be ready to provide Poland with financial assistance to meet pressing debts to the West.

At a meeting in Zurich last week, a group of Poland's main creditor banks decided to reject the military government's request for a \$350-million loan to help pay off existing arrears of bank interest.

The banks believe the Polish government should approach the country's Comecon allies first. They had agreed to reschedule some \$2 400-million of capital payments falling due this year but expect the Poles to pay off \$350-million of interest arrears first.

Earlier in December, the banks received assurances that the Polish Government would find the money and proceed towards signing the 1981 rescheduling agreement negotiated over a period of nearly nine months.

Sales of gold by the Russians on a large scale have been followed by foreign exchange transactions involving the swapping of dollars for other currencies, notably Deutschmarks.

Informed banking sources suggest the Russians could be willing to match Western financial assistance to Poland and may already have provided hard currency loans to the Poles of around \$2 500-million this year.

Apart from selling gold, the Russians appear to be running down their bank deposits in the West and have recently approached some Western banks for additional lines of credit.

Russian reserves of hard currencies held in the UK fell by \$750-million, to under \$500-million between March and August this year, according to figures from the Bank of England. They rose again to around \$1 000-million in September, but are expected to have been significantly reduced since.

Extracts from the Denver Department of Health & Hospitals

and the Divisions of Pulmonary Disease and Preventive Medicine

of the University of Colorado School of Medicine.

A Paper entitled, Monitoring Patients with Tuberculosis

for Failure, During and After Treatment. Albert, Iseman, Sbarbaro

& Pierson. 1976. Am.Rev.Res.Dis. Vol.114, No.6, Dec.'76, p.1051.

216 patients were reviewed.

1 568 radiographs were taken @ 8,36 dollars per plate.

2 865 sputum tests were performed @ 6,69 dollars a time.

Staff time, 2 865 visits @ 2,07 dollars a visit. Interestingly, during the follow-up, these facts came to light.

Out of 792 follow-up films @ a total cost of 6 621

dollars, only one indicated re-activation.

Out of 877 sputum analyses @ a total of 5 867 dollars,

only 4 showed positive re-conversion.

Out of 877 clinic visits @ a total of 1 854 dollars,

only 2 were detected as having re-activated.

Relapses were not due to alcoholism and personality

failures, either the drug regimen

tion of a statistical analysis on the staff, two, that a block vote is given to the immediate sectional head.

Personally, I favour the latter in the medical field, the former, possibly, for the major allocations at Head Office level.

Having had personal experience of the former, I can only say that the final distribution of funds was most carefully worked out and constantly reviewed for, as doctors, one was

GOLD  
1982

JAN. — DEC.

(79) Star 7/1/82

# Russian gold dumping was behind price drop — dealers

LONDON — The need to buy grain and help finance the Polish economy forced Russia to dump more than 200 percent more gold on world bullion markets last year and sent the price of the metal plummeting, say dealers and analysts in Europe.

South Africa, faced with balance-of-payments difficulties, also increased sales in 1981 but by a considerably smaller percentage, experts in London and Zurich report.

The two countries together account for 75 percent of world output of gold, says Consolidated Gold Fields, the London mining finance corporation.

A Consolidated analyst, who declined quotation by name, estimated that Soviet sales of gold jumped from 80 tons in 1980 to nearly 250 tons in 1981, worth R3 500-million at current prices.

## SA sales

David Marsh, bullion expert for London's authoritative Financial Times newspaper, said that the Soviets were faced with a need for hard currency to finance "high grain imports after the disastrous 1981 harvest, soft prices for oil exports, aid to Poland and the cost of occupying Afghanistan."

South African sales were said to have risen from about 600 tons in 1980 to 675 tons last year, worth R9 500-million.

These heavy sales drove the price of gold down steadily over the year from 602 dollars at the start of January

to 400.50 dollars on December 31 — a drop of 33.5 percent and less than half the record reached two years ago when gold peaked at 850 dollars in Europe on January 21, 1980, and touched 875 dollars in New York the same day.

Soviet gold and foreign-currency holdings are a State secret but the Bank for International Settlements in Basel, Switzerland, estimates Soviet borrowings of hard currency through last June 30 at R14 000-million and the figure is estimated to have reached more than R15 000-million by the

end of the year.

Soviet hard-currency reserves with Western banks have been reported at their lowest level in two years, about R5 500-million.

London and Zurich bullion dealers noted a change in the style of gold trading during 1981 by Russia and South Africa. Both diversified their operations to the detriment of Switzerland.

The countries are spreading their sales around to avoid overloading one market and causing a panicky downturn in prices. — Associated Press.

David Marsh, bullion expert for London's authoritative Financial Times newspaper, said that the Soviets were faced with a need for hard currency to finance "high grain imports after the disastrous 1981 harvest, soft prices for oil exports, aid to Poland and the cost of occupying Afghanistan."

A  
V  
B  
U

W

London

# US <sup>(79)</sup> set to sell own gold coin

**The Star Bureau**  
NEW YORK — A high-powered American Government study group is expected to recommend today that the United States mint a gold coin to compete with the Krugerrand and other gold coins.

The study group, part of the US Gold Commission, was established by Congress in October 1980 to study the role of gold in the US and the international monetary system.

Mrs Anna Schwartz, the group's director, announced yesterday that she expected the commission to publicly endorse a gold coin at a meeting in Washington today.

### Approval

The US coin, says Mrs Schwartz, would sell at market prices and would compete with the Krugerrand and other coins which now attract funds from Americans who wish to invest in gold.

Mrs. Schwartz believes the 17-member study panel will not propose other significant changes in gold policy and is almost certain to oppose a US return to a classic gold standard.

Any recommendation by the panel would have to be approved by Congress before implementation.

Commenting on the distinct possibility of a US coin competing with the Krugerrand, Mr. Don Redman, president of Hintz Peter Redman Investments, the US partner and

distributor of the South African Gold Coin Exchange (Sagce) and master distributor of Krugerrands in America, does not anticipate any immediate threat to the Krugerrand.

"If the US Government marketing record of previous gold coins is any guide, a new coin is not going to be an instant success, certainly not against the strong competition of the Krugerrand, the Mexican gold peso and the Canadian gold maple leaf," he said.

### Planning

Mr Kent McKamy, of Sagce in New York, also does not see a US coin as a threat to the Krugerrand.

"Launching the Krugerrand took a lot of investment and marketing planning," he said. It will take the US a long time to do the same. The Krugerrand is the best known coin worldwide."

### Japan to

d  
T  
I  
S  
e  
r  
(  
p  
e  
o  
n  
s  
s  
I  
I  
c  
t  
f  
a  
r

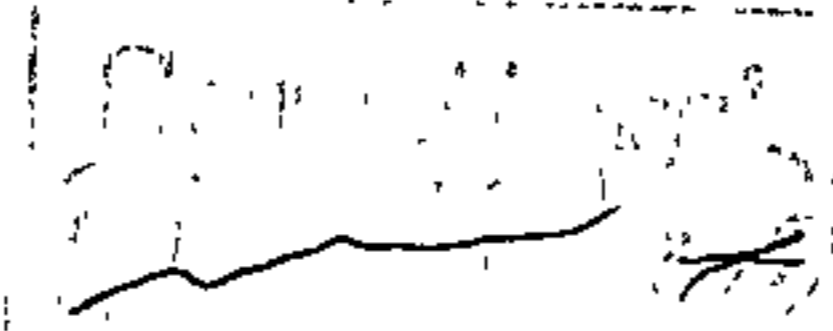

The text in this column is extremely faint and illegible. It appears to be a series of paragraphs or a list of items, but the characters are too light to read. The text is arranged in a vertical column, following the layout of the page.

The text in this column is also extremely faint and illegible. It appears to be a continuation of the text from the left column, but the characters are too light to read. The text is arranged in a vertical column, following the layout of the page.



## GOLD MARKET (79) Going East

FM 15/1/82

Japanese commercial banks (and perhaps Japanese securities companies too) will be allowed to deal in gold from April 1, 1982, although it seems that the prohibition on overseas gold dealing by Japanese banks will continue.

The Finance Ministry is now drawing up detailed rules for the banks' gold trading operations, in consultation with the banks themselves and other interested parties, as well as studying representations from the securities companies.

The banks are approaching the new situation in various ways. One intends to hold its bullion in London and sell gold certificates to its clients, to minimise any trading risk. Another will sell bars and coins as well as certificates, although this policy could give rise to problems of safekeeping gold at branch offices.

Another problem concerns assay requirements for physical metal, which will make it easier for the Japanese to operate through the medium of certificates.

The news from Japan could hardly have been better timed, with gold (at around \$382) at its lowest level for over two years and the market reeling under combined assaults from a multitude of bearish factors. Historically high US interest rates generated by the Fed's tight money policy, as well as the resultant slump in the American economy, have hit gold hard.

At the same time, inherently unconfirmable but very strong reports tell of extraordinarily high Russian sales to finance wheat imports and aid to Poland.

If the more cautious reports alone are true, the Soviets have sold around 250t to 300t in roughly six months. On an annualised basis, this rate would reflect sales of 500t to 600t, compared with SA's expected output for 1982 of around 675t.

But some reports talk of even higher Soviet sales, as much as 6t or 7t on some days, while *Time* makes the amazing claim that sales around the year end totalled 100t in three weeks. If true, this report would substantiate a rate of sales five times as high as annual production, and reflect a drawing on reserves (which total perhaps 1 800t) at a rate of over 5% a month.

On any reading, the market is being called upon to absorb gold at a rate which could equal the rate in the late Seventies when both the IMF and the US Treasury were selling off gold. This situation made available as much as 1 700t per year.

To set this figure in context, free world output is now around 950t, to which might be added "normal" Soviet sales equivalent to production of say another 300t, giving a total of 1 250t per year as "normal" supply of newly-mined gold. Of course, a further adjustment has to be made for net hoarding or dishoarding.

So Soviet sales in excess of output could be adding as much, annually, as 40% to supplies. One informed local source argues very convincingly that the present region of gold prices, far from indicating weakness, is an indicator of immense strength, when viewed in the light of the abnormal supply situation.

All the same, the gold market needs all the help it can get, and Japan already has the free world's second largest economy, and the fastest growing major economy too. The level of gold ownership, both at the official and private level, is not high, and increasing prosperity makes for higher levels of savings and excellent prospects for gold.

Roger Gidlow, Wits University Associate Professor of Business Economics, argues that the Bank of Japan might want to use

dealings (FM October 9, 1981). Gidlow says that there are several angles which make it likely that there will be increased Japanese buying, including accumulation by the central bank itself.

### Rare metals

Apart from the current strength of the economy, there have been official statements recommending that Japan should neutralise its balance of payments current account surplus and prevent undue appreciation of the yen through imports of rare metals. And the current level of the yen and the fall in the dollar price make gold imports relatively cheap.

There are reports that Japan imported as much as 43t of gold in November 1981 (much of it, incidentally, of Russian origin). Intergold's chief executive, Don Mackay-Coghill effectively confirms these reports, saying that Japan imported over 40t of gold in all forms during November.

And Intergold's Far East chief executive Bernard Denet has forecast that "a considerable growth in off-take by Japan" was a feature of last year's demand. Japanese off-take for 1981 is estimated by Intergold to have been about 150t to 160t. Demand from Japan "has probably been the single most important source of support for the gold price."

Mackay-Coghill says that Japan is expected to take some 220 000 oz of gold in the form of Krugerrand during 1982. The Japanese KR market has shown "tremendous growth" since the coins were launched there in late 1980. And, with the current moves to liberalise gold ownership, Japan is placed to become the world's major market on a per capita ownership basis in about five years.

# Soviets hold 2 000 tons of gold

ROM 21/1/80 (79)

By PAT SIDLEY

**THE SOVIET** Union has 2 000 tons in gold reserves, about five times its annual production. The value of these reserves exceeds total Soviet debt.

This was said by the professor of political science at Rutgers University, Dr Arthur Klinghoffer, when he addressed US and South African businessmen and economists in Johannesburg yesterday.

He was discussing the role of gold as a political weapon.

He said these gold reserves, which gave the Soviets a good credit rating, had

been slightly diminished by grain purchases.

Whenever possible, the Soviets did not sell gold. They sold only when they needed hard currency and tried not to sell when the price of gold was high to avoid a downward pressure on the price.

They had sold gold when the price was low to pay for grain.

Gold was the third largest currency earner of the Soviet Union after oil and arms, accounting for 10% of its hard currency.

Both arms and oil, Dr Klinghoffer said, were important substitutes for Soviet gold sales.

The oil and gold prices

were linked and a drop in oil prices increased pressure on the Soviets to sell gold to earn foreign currency. When the Soviets received enough from arms it was not necessary to sell much gold.

They could also use their foreign credit to finance imports

Both South Africa and Soviet Russia would favour a return to the gold standard, but this was not likely, Dr Klinghoffer said.

Oil accounted for half Russia's hard-currency earnings and if production problems reduced oil sales she would have to increase both gold and arms sales.

Replying to a question on

why gold had not responded to political crises, such as Poland, he said the first factor was that the dollar had been strong over the past two years

When the Solidarity trade union was first being organised and the Soviets threatened to invade, the price of gold had risen.

But the threat of invasion continued for a long time and the Soviets did not invade.

Meanwhile, the Polish economy had been wrecked and the Soviet Union had to subsidise the Poles. To pay for this Russia had to sell gold, pushing the price down

Table showing how diamonds performed against other investments.

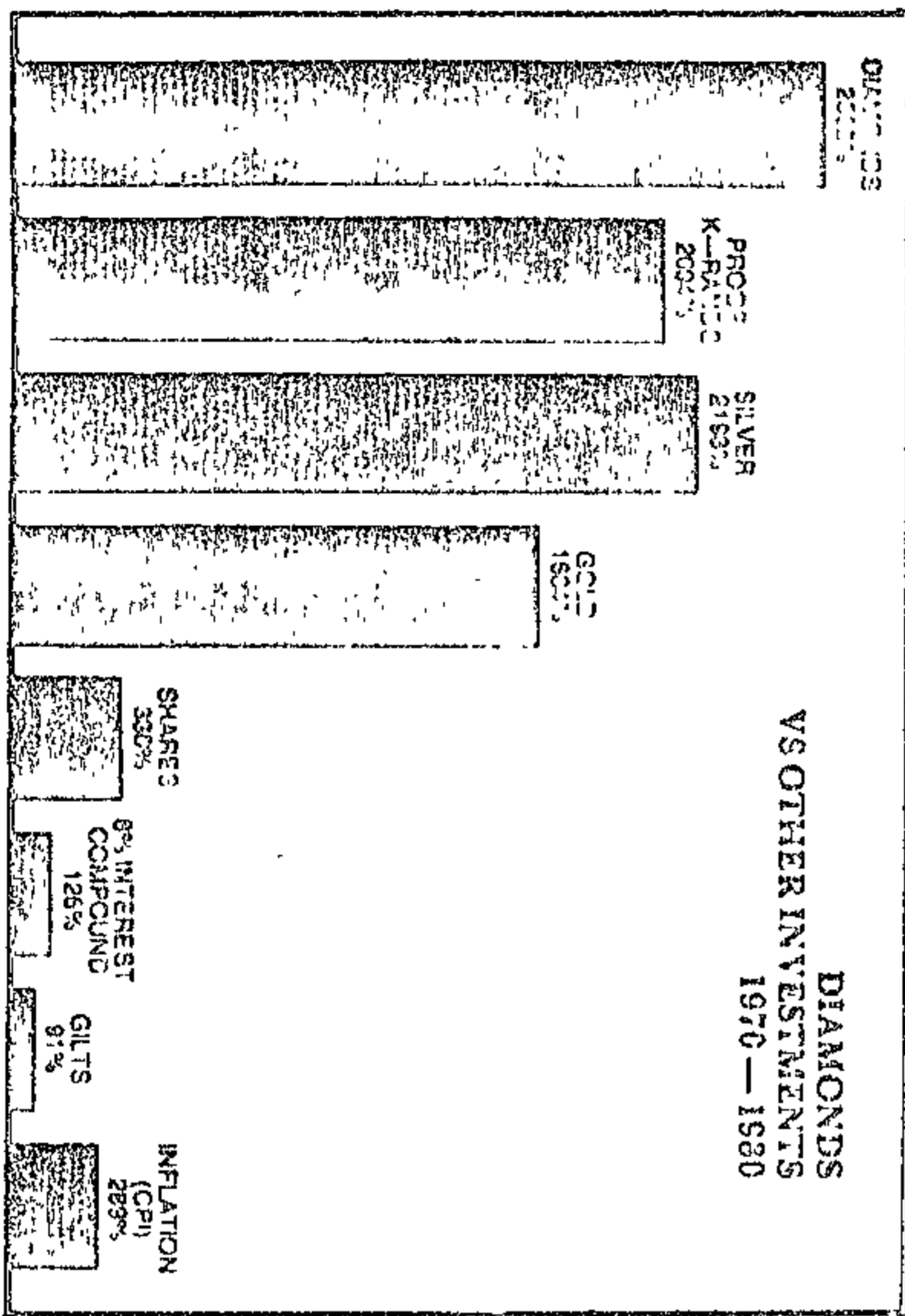

# Diamonds don't lose their lustre in the doldrums

IT IS a matter of record that diamonds impressively outperformed all other popular growth investments through the decade of the 1970s.

But what about the 1980s? Recently the investment diamond market has been in the doldrums, says Len Gullan of the Hard Asset Group.

Reviewing diamonds' past performance he says that the growth in values of investment grade stones over the period 1970-1980 was nothing short of spectacular.

As can be seen from the table on this page diamonds outperformed shares, fixed interest, gilts and inflation by enormous margins.

They also convincingly outstripped other popular hard asset investments such as Proof Krugerrands, silver and gold, he points out.

Although the long-term price trend for diamonds is one of impressive growth, this growth as with all investments, is subject to short-term price cycles, he explains.

Mr Gullan says that in keeping with most other hard asset investments there is something of a correlation between the movement and timing of diamond price cycles and that of the US inflation cycle.

"Both the US inflation rate and the prices of investment grade diamonds have been in a cyclical decline since early 1980.

"To see this decline in perspective, however, one should bear in mind that while diamond prices have come down about 35% on average, the price of gold has declined as much as 53% and silver has plummeted a whopping 81% from their peaks of early 1980 to their lows of recent months.

"In the last few months, US inflation has once again edged upwards and many analysts believe this is the commencement of a new inflationary wave.

Already the prices of gold and silver have bounced up sharply which could well be the signal that another bull market in investment diamonds is imminent," he says.

Mr Gullan says that the diamond trade, however, is still in the doldrums and this has led to recent speculation that diamonds may have permanently lost their lustre as investments.

"There has been some speculation in the Press that De Beers, which has long exercised a rigid control of the diamond market, may have lost their grip on the situation.

"I do not for one moment believe this to be the case. What has happened is that the nature of De Beers' control has changed in keeping with market circumstances and

this is likely to lead to somewhat more volatility in the price of diamonds in the future than has been experienced in the past.

"From an investor's point of view, however, this should be seen as a welcome development because for an investment to be worthwhile its price must move up and down in order to keep bringing new buyers into the market and allow earlier investors to take profits.

"I am afraid that the traditional diamond trade may have to get used to the fact that 'Big Daddy' (in the form of De Beers) may no longer be prepared to smooth out the price cycles for them. But for those who can adapt their thinking, diamonds could prove an even better investment medium in the future than they have in the past," he explains.

Mr Gullan said another factor which has exerted a bearish influence on the diamond market has been the fact that Zaire and Australia have opted to market their diamond production outside of the De Beers "syndicate".

However, investors should understand that only a small proportion of the diamond production of both these countries will fall into the 'investment grade' category, he says.

□ □ □

"Personally, while I believe that the syndicate will continue to retain a degree of control on the market, I do not see it as a material factor for investors whether they do or not.

"Investment grade diamonds constitute less than 2% of total production and this percentage is steadily diminishing. As such these stones are valid rarities and their prices will continue to appreciate long term no matter what developments occur within the diamond industry as a whole."

He stresses that investors would be well advised to only buy stones which meet international investor requirements because their added rarity value is likely to underpin their price appreciation regardless of developments in the industry as a whole.

"It would appear to be an excellent time for serious long-term investors to buy investment-grade diamonds. The risk of substantial price declines must surely be limited, while the potential for large-scale profits looms larger as each week goes by, says Mr Gullan.

"Remember, however, when investing in diamonds, that it is important not to over-pay as this can offset much of your profit potential," he warns.

# Rand's fall cushions low price

## 54% of world's gold from S.A.

**SOUTH African gold production fell to 31 221 174 ounces in 1981 — more than 500 000 oz down on 1980's 31 699 455 oz.**

The US Bureau of Mines reports that world production rose to about 29 200 000

oz last year from 29 million oz in 1979.

Although this meant a slight dip in the percentage of world output from this country, South Africa's contribution was still 54% in 1981.

By HOWARD PREECE

The sharp fall in the value of the rand against the dollar has cushioned the mines from some of the impact of the heavy tumble in the gold price.

In 1980 the average daily gold fixing in London was

\$614.36

That meant that the dollar value of gold produced by South Africa was about \$13 143 453 000.

Last year the average gold fixing was \$493.00.

That meant, with the small recession in output, that the dollar value of production plunged to \$9 601 543 000.

This represents a drop of nearly 25%.

However, the rand fell steadily against the dollar from its peak of about \$1.35 at the beginning of last year to hover around \$1.0251.03 at the end of the year.

According to the Reserve Bank, the rand fell 22.5% against the dollar between January and October, and the figure would have been much the same for the full year.

The Reserve Bank does not value gold production as such by gold price.

Sales will differ from production because gold is not sold for only one of these and because amounts are added to and/or taken from reserves, including the stock of Kruggerands.

But even with that qualification the cushioning effect on rand earnings of the slump in the foreign exchange value of the rand can be seen.

In 1980 the value of gold production, according to the Reserve Bank, was R10 141-million.

The final official figure for 1981 has not yet been disclosed but it is unlikely to have been much more than 20% down on the 1980 level.

In the first nine months of 1980 output was valued at R7 651 000.

For the January to September period of 1981 it was R6 191 000 — a fall of 19.9%.

Given though the implications of that drop are, they are patently a great deal less than painful than a drop of 50% that would have occurred without the fall in the value of the rand.

The rand's drop has, of course, had other adverse consequences — most notably in adding to the severe inflationary pressures already at work in the economy.

The US Bureau of Mines projects US domestic demand for gold increasing at an annual rate of 2.2% a year over the next 10 years.

In 1982 US gold consumption may advance to about 5-million ounces, up from 3 700 000 oz in 1980, but slightly below the level reached in the late 1970s.

World resources of gold are estimated at 2 000 million ounces with 40% in South Africa, 15% in the Soviet Union and 12% in the US.

R  
t  
R

RUST  
spend  
to A  
Wade

He t  
annual  
burg y  
lion w  
on ex

Re  
fa  
to  
gl

NEW  
Reagan  
address  
cial r  
eviden  
discipl  
and m

In r  
for the  
and in  
promis  
deficit  
dent R  
worrie  
drive i  
recent

"The  
cerned  
cy bet  
cal pol  
in the  
conce  
Wengl  
at Gol

Mr F  
G Lar  
speech  
suppor  
foreca

"We  
sively  
borrow  
longed

"As  
gram  
tremel  
ernme  
contin  
and a  
sion, w

1982,"  
Reuter

Fa  
Cis

A R 2 3  
is bein  
in the  
to be c  
May."  
Constr  
area c  
ablutic  
would

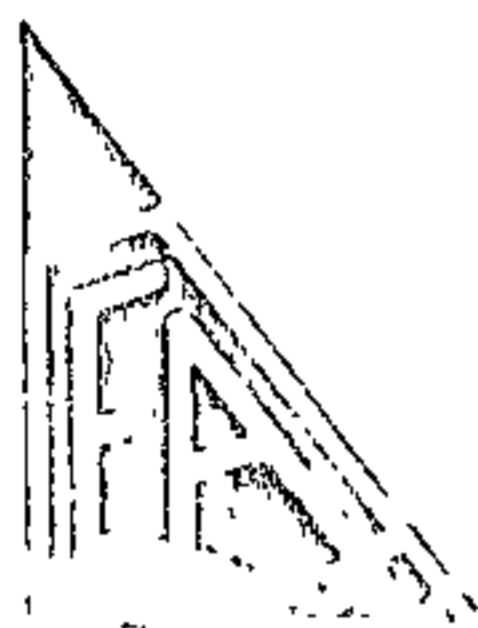

**FRASER ALEXANDER HOLDINGS LIMITED**

INTERIM REPORT FOR THE SIX MONTHS ENDED 30th NOVEMBER, 1981

The directors announce that the estimated unaudited profits of the Group for the six months ended 30th November 1981 are as follows:

	1981	1980
Estimated profit after taxation and after exclusion of minority interests.....	1 701	725
Loss: Preference dividends .....	40	—
<b>Earnings attributable to ordinary shareholders .....</b>	<b>1 661</b>	<b>725</b>

Ordinary shares in issue (as increased by the issue of 2 744 454 shares for the acquisition of shares in Marlin Investments Ltd and the conversion of A and B deferred shares into 1.5m ordinary shares)..... 12 744 454 8.5m

Earnings per ordinary share for the six months..... 13.0 cents 8.5 cents

Interim dividend..... 5.0 cents 3.0 cents

**Notes:**

- Estimated taxation payable for the period amounts to R922 000, (1980: R460 000).
- Capital commitments payable over a period of approximately 2 years amount to R2.5m and will be financed from internal resources and facilities available to the Group. (1980: R120 000).

**Business Prospects**

The company sold its subsidiary companies to Marlin Investments Ltd ("Marlin") with effect from 1st June 1981 and at present its sole investment is a majority shareholding in Marlin. The directors of Marlin report in an interim report released today that group prospects are good and there is a satisfactory level of activity in all divisions.

**Dividend Policy**

The directors have declared an increased interim dividend but it should be borne in mind that a part of this increase was to reduce the disparity between interim and final dividends.

**Interim Dividend**

Notice is hereby given that the directors have declared an interim dividend of 5 (five) cents per ordinary share in respect of the six months ended 30th November 1981 payable on or about 15th March 1982 to shareholders registered at the close of business on Friday 26th February 1982. The transfer books and register of members will be closed from 1st to 5th March 1982 both days inclusive. Non-resident shareholders tax at the rate of 15% will be deducted from

**ORANGE  
CORCOPILE  
BELTS**

UN  
30  
AM

NTS  
dia-  
ven  
de-  
—  
dial  
con-  
tion  
inc-  
De  
rm,  
ing  
  
will  
at on  
duc-  
l, the  
will  
on to  
year,  
ts by  
th of  
  
id  
40%,  
dia-  
by a  
  
dmit  
most  
the  
end  
the  
con-  
it is  
stra-  
  
say  
urket  
ned.  
por-  
cers  
nam,  
ex-  
burg  
the  
onths  
Aus-  
lying  
verp  
  
hton  
d by  
ting  
road  
  
s of  
ven-  
n ef-  
ting  
un-  
bel  
orth-  
  
tra-  
the  
the  
on  
Ma-  
ion,  
ner

### NEIL DENN port on his certain the huge diam

The third part of a mere 5% interest in the joint venture is held by a fiduciarious mining company headed by a confident mining executive, Neil Denn, played a role in the early discovery of the Anglo and an indirect joint venture through interholdings in Malaysian Malayan Mining. Because of his mining network has considerable power.

Mr Towie February last and Ashton Mining CSO. Mr Towie disclosed the other potential not been apparent were General powerful US which makes monds, and the retailer, Zale.

"I was not, not, against through the CSO's middle This includes ston and low bulk buying - fee to the CSC the market in

In January Mining's independent, a respected, Joris, valued Ashton by a higher than t Ashton Joint who was pr mended by D

The differ Mr Towie's s cially as Mr the general qual gyle deposit against the 8 mates of the

In July 1981 the ing brought values from verp, Tel A Mr Joris says the July parcel ferent from t

# Gold price depends on the Soviets

79  
RSM  
3/2/82

By JOHN MULCAHY

THE performance of the gold price this year, and the average revenue to the mines, is heavily dependent on actual Russian sales and private investment demand.

The London Mining Journal, in a gold survey accompanying its quarterly analysis of South African gold producers, says there is general agreement among bullion experts that no substantial changes in gold price levels are likely to occur during 1982.

Taking the extremes of the experts' ranges, the lowest estimate is around \$350 an ounce and the highest \$500.

The Journal says it is tempting to take the counter-view on the gold price, but this is difficult to justify on any objective basis.

Political and economic events occurred late last year that would normally have boosted the gold price, but in practice the market drifted in spite of generally improved jewellery demand, central bank purchasing and political events ranging from the attempt on Reagan's life, the assassination of Sadat and the military takeover in Poland.

The physical supply/demand position for gold appears to be well balanced, with new mine production estimated at about 940 to 950 tons, which will probably be supplemented by Soviet bloc sales of between 200 and 300 tons.

Additional supplies from either investment dishoarding or bullion jewellery liquidation seem unlikely, says the Journal, and there is no evidence to suggest any official monetary sales over and above the coin programmes already under way.

This suggests a total supply figure of around 1200 tons, and against this is firstly the demand for industrial use — including jewellery — of about 825 tons, reflecting the continued improvement in the jewellery market at stable price levels.

Coin sales — mainly Kruggerand, Mexican coins and the Canadian Maple Leaf — will probably be around 225 tons, leaving a balance of 150 tons, which is unlikely to be sufficient to meet the unpublicised, but growing demand from smaller central banks.

While Soviet sales have previously exceeded 400 tons a year — in 1963 and 1964, as well as 1976, 1977 and 1978 — but on these occasions they were selling, or could have believed they were selling, into a strong market.

Much attention is given to the Soviet need for gold sales to meet foreign exchange requirements, and it is true that bullion sales form part of their overall balance of payments programme.

However, the pattern of sales over the years does not support the idea that massive distress selling will take place to meet particular needs.

Soviet sales targets appear to be set well in advance, and are modified only if there is an urgent need for foreign exchange and the market is comparatively firm.

The Russian gold sales programme is managed in a

sophisticated way, and their knowledge of marketing is significant.

According to the Mining Journal it is reasonable to presume that if a substantial foreign exchange deficit arose that could be met only by gold sales, a gold swop programme, parallel to the South African arrangements, would be made rather than massive open market sales.

A figure of about 250 tons for Soviet sales this year is regarded as reasonable at current price levels, although additional sales could be made in a stronger market.

The incentive for private investment in gold is the profit motive — either a sharp rise in the real value of gold is anticipated or a fall in the value of currencies of other non-gold assets is feared.

In the short term, says the Journal, a sharp rise in the real value of gold cannot be expected.

The relationship between the average cost of production and the present selling

price does not demand it and there is no significant new use that would prompt a major change in supply/demand patterns.

In contrast to this position is the fact that currencies are rapidly losing value and there is a strong profit motive for the private investor to move into gold.

The currently high interest rates are a significant factor in the currency-versus-gold investment balance, and if the experts are correct that the gold market will remain flat this year, it would be correct to earn interest on currency now and to switch to gold later in the year.

However, it will require fine judgement, and some time within the next 18 months, the continued erosion of currency values will become an important market factor.

Some possibly small event will re-kindle public awareness and the demand for gold and gold-related assets will move ahead rapidly, as it has in the past.



# Kruger sales on the way up

By JOHN MULCAHY

KOM 5/2/82

7a  
STRONG sales in Europe, the US and the Far East boosted Krugerrand sales to a total of 379 844 ounces in January — 33,5% higher than in January last year and 5,6% up on December's sales.

Krugerrand sales were 359 870 oz in December and 284 422 oz in January last year. Sales in 1981 amounted to 3 559 517 oz — up 13,1% on 1980's sales.

Intergold no longer releases a breakdown of sales, but a spokesman for the Chamber of Mines gold marketing arm said it was reported that the lower gold price had encouraged consumers to buy Krugerrands at a price they considered to be relatively inexpensive over the long term.

The Intergold spokesman said the strong sales performance had provided an excellent start to the year.

Intergold has consistently promoted the Krugerrand investment strategy of building up a holding of coins along with other investments as

part of a balanced and diversified portfolio.

It has also encouraged investors to buy their coins over a period to balance the peaks and valleys in the price, and arrive at the most reasonable average price for their coins.

Intergold's Hong Kong representative recently forecast sales of 200 000 oz for 1982 in the area. Europe emerged as the main market for the coins last year.

Mr Don Mackay-Coghill, Intergold's head, said in London last month that US customers accounted for less than 40% of total Krugerrand offtake in 1981, while sales in Europe rose to about 50% of the total.

US demand had been dented by high interest rates, lower inflation and the weak gold price. The Polish crisis had stimulated European sales.

Mr Mackay-Coghill expected 1982 sales to be roughly the same as last year, but he said the first six months would be difficult because of the stagnation in the gold

price and the recession in the northern hemisphere.

Japan was likely to be the fastest growing market this year. Japan imported 41 tons of gold in November last year, making it the world's largest net importer for the month.

In 1981 Japan bought about 19% of the available supply of between 200 and 220 tons of gold last year, and is likely to lead the gold sales market when Japanese banks are allowed to sell gold from April this year.

Challenging the Krugerrand now are the Mexican coins, which have been redesigned in fractional form to compete directly with Krugers. A major US Government study group has recommended that the US mint a gold coin to compete with other gold coins.

There has, however, been some scepticism on the likely performance of a US coin as previous efforts have not been successful. The Krugerrand, the Mexican peso and the Canadian Maple Leaf are well established.

# SA and RUSSIA IN

RUSSIA is said to have entered a secret agreement to sell gold to South Africa.

Previously largely speculation, this is the message of a new report in one of the world's most respected private-circulation letters on international affairs.

Pretoria denied the agreement on Friday — advancing cogent arguments to support its case.

But the possibility remains that there may at least be a new "understanding" between the world's two greatest gold producers, both faced with a pressing need to raise money to balance their books.

The sales are said to be part of a "desperate" effort by Moscow to raise enough money to pay for imports of grain, largely from the US, to offset the largest-ever shortfall in the USSR's own grain crop.

The report says top-ranking Western businessmen who have been visiting Moscow estimate the total sales to South Africa so far could be worth as much as \$2 000-million (about the same in rands).

Moscow has also been selling through Zurich, London, Tokyo, and even through direct deals with Middle East oil-producing countries and the Italian jewellery industry, which dominates the jewellery fabrication business, says the report.

South Africa, likewise, has adopted a "broader-based" marketing policy to reduce the growing drain on the trade account (including gold) on its balance of payments.

# SECRET GOLD

BY STEPHEN ORPEN

## New evidence supports once 'unthinkable' scenario

Shattered by the misbehaving gold price and sharp downward arc in the export-import equation, the trade balance has already swung by an awesome R10 000-million since 1980 from a glittering surplus of some R6 000-million to a deficit of more than R4 000-million last year.

can gold experts questioned by Business Times. They stress that "necessity is the mother of invention", and that both SA and Russia face similar disaster should the bottom drop out of the gold market just when a much higher price for the metal is most needed.

In Zurich, the idea of a simplistic agreement for SA to buy Russian gold is considered out of the question.

But as two gold analysts there explain: "That does not mean there is not an underlying, standstill collusion arranged, of course, through third and fourth parties. "It would be highly surprising if, through such par-

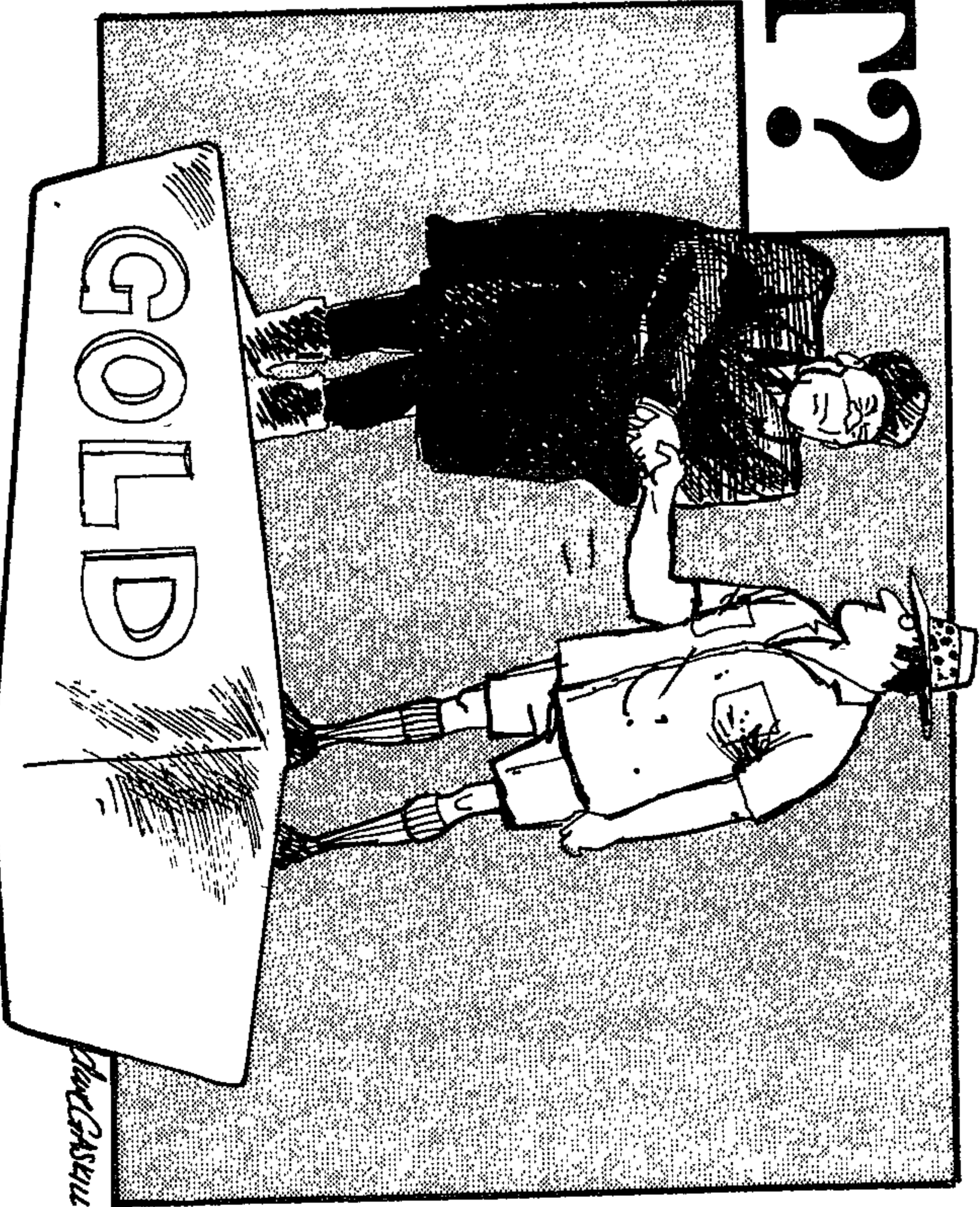

ties, there was not a new set of fluid arrangements under which the two major gold producers are avoiding any action which they can devise which might further depress the metal's price.

A London source comments: "It would clearly be the height of foolishness for Russia to be offering large parcels of gold in the same markets as South Africa at the same time.

"In diamonds, we have seen how De Beers, through its world selling force and market stabiliser, the Central Selling Organisation, has been able to secure co-operation from the Russians, overriding any question of conflicting ideologies, or affections, and whatever is said about it publicly.

"There is no reason why the same cannot apply in the gold business when pressing mutual, yet also exclusive, national economic interests are at stake.



# Nearing the bottom? (79) FM 12/2/82

Does gold's stabilisation above the \$370 support level indicate that the metal's bear trend is over? Or is this yet another consolidation point which will do nothing but lull

above the \$390 chart resistance level. But because it had failed to advance from there, it seems, gold dealers were obliged to take a fresh look at the market as the new year started. And when they saw no compelling reason to reverse the generally bearish trend which has been held by US futures traders for almost two years, the scene was set for the relatively orderly fall to a low London fix of \$369.75 on the morning of January 18.

On technical grounds alone, it is now easiest to go along with the trend and forecast that after a period of consolidation above \$370 a further drop to \$350 is on the cards. There are, however, sound grounds for believing that the end of the bear market is very near.

According to recent figures published by New York precious metals brokers J Aron, at prices just below the \$400 level gold supplies are tight relative to demand. In 1980, on Aron's figures, the high prices resulted in a slump in total jewellery demand to 3.9m oz from 23.7m oz in 1979. That, though, was accompanied by a reversal of the trend of the Seventies as central banks became net buyers of gold. Despite lower Soviet gold sales in 1980, official gold purchases were necessary to balance the books in the face of lower private investment and fabrication demand.

Conventional supply:demand forces determined the direction of the gold market last year. According to estimates by Aron, jewellery demand rose strongly, as did private investment demand for official coins. But most of the jewellery demand came from developed countries where the price of gold jewellery is well above the bullion price. Jewellery purchases in these areas are generally made with no intention of future sale. In other words, gold was moving into strong hands as buyers were able to afford jewellery as gold's price fell. At the same time, though overall investment demand fell slightly last year, demand for official coins advanced on 1980. Again, so the theory goes, gold has moved into private stocks which are unlikely to return to the market even if the price advances strongly.

In Aron's view and at the prices prevailing at the start of the year, mine production and Soviet sales are both set to rise, as are all elements on the demand side of the equation with the exception of net private investment. This, of course, is a projection based on no drastic changes in the economic picture or the price of gold and indicates a tight balance between supply and demand. Let only a couple of factors in the demand:supply equation vary and the potential is there for some sharp price moves — in either direction.

The main factors, though, which would give rise to gold price shifts would be changes in Soviet bloc sales and private investment demand. And the upshot of that is that private investors would have to push the gold price well above current levels if

analysts into a feeling of security until bullion suddenly sheds another \$20 or so? Making a case to justify either position is equally easy

The problem with the latest drop is that there were no obvious political or economic reasons for the price fall in mid-January. Gold had been apparently well supported

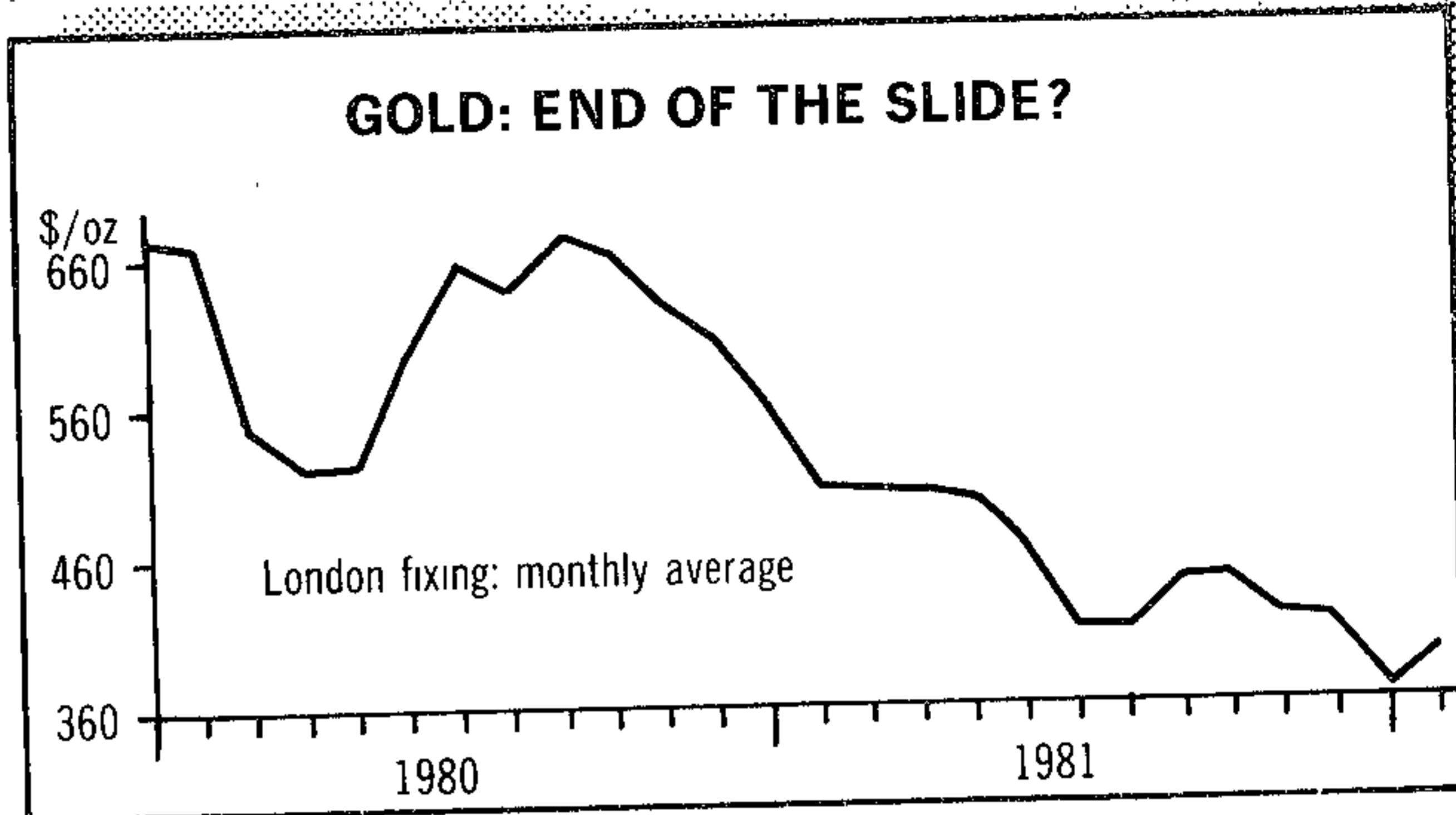

they wished to bid bullion away from official buyers. For two years investment in gold has been unattractive with a deteriorating gold price and more attractive returns available from investment in dollar securities. But let the gold price trend reverse direction and the rise could become self-sustaining.

Looking at the supply side of the equation first, some London analysts dispute the Soviet sales figures estimated by Aron for 1981. They reckon the Soviet bloc has sold about 250 t (8m oz) of gold in the past four months. Its sales bunched in the final months of last year as economic pressures built up. And, so the London dealers believe, Soviet sales will bunch in the first few months of this year. If that is right, before mid-year Soviet sales will have reduced to a trickle — the Soviet Union, after all, has gold reserve targets and cannot indefinitely sell more than it produces — cutting back the supply of new gold to the market. That should be a major spur for the bidding private investors will have to do to divert gold from other buyers.

That scenario is much too neat for absolute reality. Even if supply starts deteriorating as the year progresses, the dynamic of a declining gold price could further reduce investment demand and result in a continuation of the present bear trend. A change is needed in investors' economic perceptions, and in particular their expectations for America and the dollar.

Last year there was a vote of confidence in America and the dollar as the Reagan administration moved into Washington and apparently set about implementing the economic policies it felt were necessary to eliminate inflation and regenerate America's economic muscle. Disenchantment seems to be setting in with the realisation that there is no easy cure for America's economic malaise. Last weekend the administration put forward its economic proposals for this year. There is to be no increase in tax rates, military spending is moving sharply higher and an attempt to

pare government spending is to be made through cuts in the social security budget — hardly a political move that can be sustained in a congressional election year. It all seems to add up to unacceptably high (from the inflationary viewpoint) budget deficit of about \$100 billion this year and next — a far cry from the deficit reductions promised at the start of last year. Then there is the dollar — the star performer among world currencies in 1981. Now doubts are being cast on its ability to maintain its value in the face of increasing US trade deficits. In the first 11 months of last year the US trade deficit was \$38.4 billion against \$33.3 billion in the same months of 1980.

Of course, the dollar could be propped up by higher interest rates which, at the same time, would be part of the economic medicine needed to contain inflation. But the administration's flexibility on interest rates is circumscribed by economic and political trends. High interest rates have helped, for example, to push Detroit into its worst trading quarter since 1947 and flatten housing starts, unemployment is now at the politically critical 9% level; and there is still pressure from Europe for a lowering of American interest rates to match those on the other side of the Atlantic. Furthermore, the US economy needs stimulation if it is to escape the recession which, according to the IMF, resulted in GNP falling at an annual rate of 5.2% last quarter.

Probably more sooner than later, the strains in the American economy will reduce the attractions of dollar investments against those of gold. And it will not be necessary for that to coincide with a reduction in Soviet bloc sales for the supply:demand equation to be thrown out of kilter at current gold prices.

For the next month or so, near-term bearish factors will probably predominate. But there may be little point in trying to finesse the bottom of the market. The signs are that by mid-year gold will have escaped its present depression.

# Gold is rocking the boat and YOU have to pay

79  
454  
S. Gilmore  
14/2/82

## HORWOOD HITS THE PANIC BUTTON IN HIS MINI-BUDGET

THE introduction of the mini-Budget by the Minister of Finance, Mr Owen Horwood, shows all the signs of a panic reaction to a fall in gold revenue — and as usual the consumer is going to pick up the tab.

While the announcement of an increase in GST had been widely expected, if not deliberately leaked in an attempt to soften up the public, it had been hoped that lower income groups would be given relief in the shape of food being exempt, but no category of spending is being spared.

In this way the Minister will draw in an extra R600-million or so which, with R550-million from the imposition of a 10% import surcharge, will ease the pressure on the Government's finances.

Yet the introduction of a mini-Budget now, rather than waiting another month, only serves to underline the

BY JOHN GILMORE

seriousness of the situation — as the Minister implied on Thursday.

He said the measures could have been held over until March, but judged it in the national interest to act promptly to eliminate uncertainty and speculation.

The import surcharge will operate immediately and the extra GST will have to be paid from March 1. In this way the Minister could garner as much as R100-million in the first month alone from the surcharge, which would help him balance his books in the current fiscal year.

Surprise is still being expressed that a mini-Budget was necessary ahead of the main Budget at the end of March. Economists consider

that worse could follow.

The chief economist at Barclays Bank, Dr Johan Cloete, feels that at least one of the aims of the early Budget is "to soften the blow" for what could follow — probably an increase in the loan levy and possibly higher excise duty on cigarettes and drinks.

"The surcharge of course, includes oil imports so a rise in the price of petrol must be a strong possibility. And the increase in GST being across the board will hit everyone and lead them to seek compensation through wage and salary increases, which will only worsen the inflationary spiral.

In Cloete's opinion the least harmful way of raising

extra revenue would be to raise GST by no less than two or three percentage points, but on a selective basis, leaving out essential foodstuffs. People then would at least have a choice of whether to spend or not.

What Mr Horwood has done, however, is to boost inflationary expectations and it is now going to be almost impossible to bring down the rate in the current year. Not surprisingly, therefore, he admitted that South Africa was in for a tough year.

His main problem is the depressed price of gold and on this front he can expect little or no help in the short term. The gold price has declined from an average of \$613 an ounce in 1980 to \$460 in 1981 and an average this year of \$383.

And for every drop of \$100 an ounce it means a reduction in South Africa's earnings from gold sales abroad of about R2 100-million.

What is now being asked is whether Mr Horwood has acted too heavily too late, since the price of bullion has been falling steadily since it hit a peak more than two years ago.

While Mr Horwood has no real control over the gold price, economists point out that the downward trend was apparent at a fairly early stage. They say steps could have been taken before now that would have lessened the blow for consumers and restrained the increase in the rate of inflation.

## Greatermans sets the pace

RETAILING again held the spotlight on the JSE this week after the recent rush of takeover bids.

Though no more bids materialised, rumours were running strongly, supported by heavy dealing in certain shares with Greatermans to the fore. In just three days dealings 174 000 Greatermans 'A' shares were traded, pushing up the price from 1 160c to 1 220c.

It is thought the ubiquitous Natie Kirsh was in the background, having recently bought 49% of controlling company Griffon.

The other stock to attract attention was Tedalex and its associate Ellerines. More than 72 000 Tedalex shares were traded in four days — worth more than R500 000.

Chairman Benny Slome pooh-poohed takeover rumours.

However, one large firm of brokers was bidding aggressively for stock and a dealer went so far as to put a 900c-a-share price on Tedalex for a bid from Jan Pickard, whose Picfood operation is sitting on a pile of cash. Pickard could not be contacted for confirmation.

While there, I and learned about problems youngsters have. I b my years of personal contact with high school stu given me a broad knowledge of their problems and help.

Since I must move to the Cleveland area, I am esp terested in working in the Parma school system. my three elementary school children will be happy ready have friends in Parma.

I would appreciate an interview at your convenient be happy to send you my resumé or bring it with me time you designate. If there is additional info need, please contact me at (313) 349-2455.

Yours truly,  
John O'Reilly

79

# US body gives decision against gold standard

The Star Bureau  
WASHINGTON —  
After seven months of deliberation, the Federal Gold Commission has voted against returning to the gold standard.

Some of President Reagan's supply-side supporters insist that a gold standard is the only way to bring down interest rates and inflation, but most US economists oppose a return to a gold-backed dollar.

The commission's vote came just days after President Reagan said in a report to Congress that "the evidence does not suggest that (the gold standard) achieved greater stability in price levels or growth."

The commission did agree tentatively, however, that Congress and the Federal Reserve should study the merits of some kind of money rule — albeit not gold-linked — in order to slow the

growth of money and ensure a steady reduction of inflation.

It also voted in favour of creating a new gold coin, perhaps called the American Eagle, to be sold by the Treasury Department at a small mark-

up over the gold price.

Draft proposals recommend that the coin not be legal tender and have no dollar denomination, but that it be exempt from capital gains tax and sales tax.

(79) Star 17/2/82

# Capitalist West must

## protect gold

The Minister of Finance, Mr Horwood, today called on the West to help safeguard the future of the capitalist system by giving gold greater official status.

He was addressing an investment conference in Johannesburg.

The conference was run by stockbrokers Simpson, Frankel, Kruger Inc.

The Minister said that gold was increasingly reasserting itself in monetary affairs and suggestions for undertaking a serious reappraisal of the monetary

role of gold could not be dismissed as a ruse to give gold producers a higher price.

Much more was at stake he continued. "We are, to my mind, now dealing with nothing less than monetary and political stability in the West and the survival of the capitalistic system."

Mr Horwood suggested that the leading industrial nations should assign a formal and well-defined monetary

role to gold, not only as an official reserve asset but also as an international means of payment and possibly also as the numeraire for the system.

Gold was already performing an important monetary function but there was an urgent need to clarify and formalise this role so as to bring more order into the system, reduce uncertainty and

improve confidence in international monetary arrangements.

Mr Horwood stressed that neither he nor any other serious proponent of gold had ever opted for a return to the original Gold Standard.

What they had stressed, however, was a move towards a more normal gold-backed monetary system.

He suggested that the best way of achie-

ving this was for the United States to take the lead by restoring convertibility of the dollar into gold at an agreed price or range of prices.

The notion that gold was the enemy of the dollar was totally fallacious. The world needed both.

Some experts, while recognising the importance of gold, would not favour at this stage the re-establishment of a formal link between the dollar and gold.

However, the least that could be done was to reach agreement on international rule for the variation and use of gold by monetary authorities.

# Value of gold as valid hedge driven home

US gold investment could broaden dramatically as the price approaches 300 dollars, the conference was told today.

Mr N Chang, director of research and strategic planning in the commodity division of Shearson /American Express of New York, said that the case for gold as a valid inflation hedge and the best long-term preserver of buying power around the world had been dramatically driven home in recent years.

The attitude of most investors now was that of wait and see. As for institutional managers, the pressure to initiate gold investments had perhaps abated temporarily — but this was not to say that the perspective of gold as an investment was changing.

According to Mr Chang's technical analyses, there was a good possibility that the bear-eye of the gold market had already been completed, and the price was experiencing its final major down-move, he said.

At this moment, American investments in gold were minimal. There were various

groups of investors, among them:

● Those who had practically no interest in gold. "After 42 years of gold ownership prohibition, we might say that they have forgotten the gold habit," he said.

● The goldbugs — investors with a passion for all precious metals and an intense distrust of intangible

assets and paper money.

● Tax-motivated investors who find high value portables an attractive holding.

However, gold probably had its greatest future with serious long term investors, Mr Chang said.

"Generally these people are cosmopolitan and sophisticated in financial matters, and have been deeply dis-

turbed by the recent inflationary trend and the weakness of the dollar."

Several private US pension funds had minor involvements with commodity markets through fixed-income equities and commodity futures.

Indications were that perhaps up to 100-million dollars could be committed in this way.

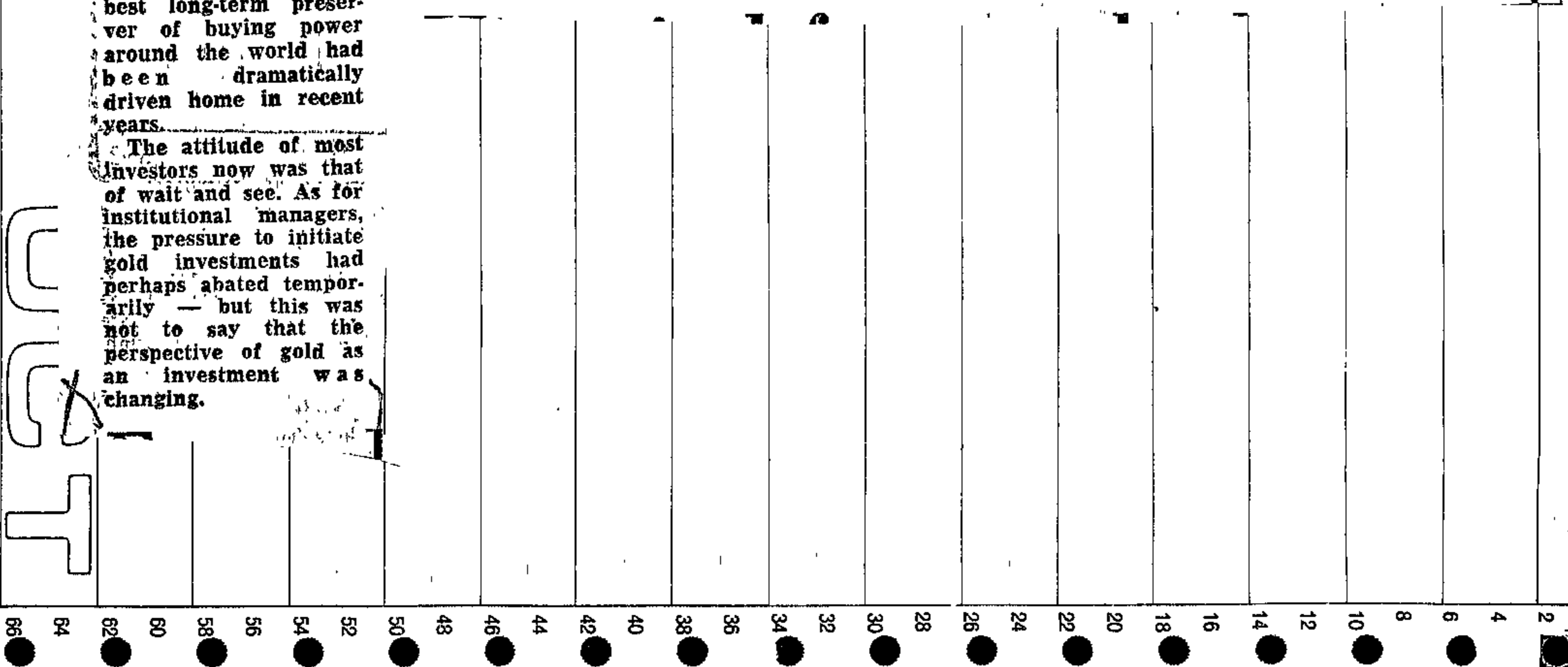

# Huge debts <sup>(79)</sup> force Soviet <sup>1004</sup> dumping <sup>19/2/82</sup>

By NEIL BEHRMANN

**LONDON.** — The gold price has cracked again under the weight of new Russian selling.

Dealers say the Soviet Union sold in Zurich and possibly Frankfurt yesterday.

Platinum and silver were near their January lows yesterday.

"The gold market seems to be in a new bear leg. Precious metals are not so precious any more," said a Swiss bullion manager.

"Most people have been trying to find a bottom over the past month and we are now looking silly because we advised our clients to buy," said a director of a US and London commodity house.

The London market was hit by large sell orders from Frankfurt and Switzerland yesterday.

When the market failed to hold above \$375 an ounce in the past few days, New York and London brokerage houses set off stop-loss orders for their clients and further selling orders depressed the market.

The latest quarterly report of the Bank for International Settlements (BIS) shows that Soviet debts to the West rose by \$6 000-million in the first nine months of 1981.

By the end of the September net Russian debts with banks in the 15 main Western countries stood at \$10 863-million against \$4 820-million nine months earlier.

The BIS said that the Soviet Union was the second largest borrower of funds from international banks, followed by Mexico.

The rise in Soviet debts show it is desperate for cash and few are surprised that it has been dumping gold.

Russia, however, has not sold significant quantities of platinum since December and some dealers said that this could be proof of low production.

Bullion dealers said that the SA Reserve Bank was withholding gold from the market in an attempt to support the price. They said the Reserve Bank would be forced to sell and had made a tactical error.

The bear market in precious and base metals mir-

rors the deflationary trend in the US and European economies. American banks raised their prime overdraft rates from 16.5% to 17% to the dismay of European leaders.

American rates rose because of the huge Budget deficit.

Paradoxically the dollar fell against sterling and Continental and Far Eastern currencies yesterday.

Dealers say that the dollar weakened because production in US factories and mines fell by 3% in January — the steepest decline since early 1980.

They reasoned that the Federal Reserve Bank would relax monetary policy because of the deepening recession.

The latest quarterly review of Metals Analysis and Outlook calculates that base and precious metals industry revenue declined by 22% last year to \$57 000-million. Since the beginning of the year their revenue is estimated at an annual \$50 000-million.

If South African gold and platinum producers are excluded from the total, says the firm, the remaining industries did little better than break even in 1981.

At current metal prices base metal producers are losing \$7 000-million a year.

Gold and platinum producers fared better last year because of the devaluation of the rand. But with the Reserve Bank intent on a support policy, brokers expect profits to be bleak. Impala Platinum has shown the trend.

JUST

68 64 62 60 58 56 54 52 50 48 46 44 42 40 38 36 34 32 30 28 26 24 22 20 18 16 14 12 10 8 6 4 2

# U.S. rates will still limit gold

79 S. Times 21/2/82

HIGH American rates will continue to limit any upward movement in gold, possibly until the end of 1982, say London brokers Scott, Goff, Hancock.

Their mining analysts are therefore very cautious about the outlook for gold shares in the shorter term.

However, further signs of deflation arising from political pressures could begin to reverse sentiment later this year.

With an easier money supply, the US economy may recover faster than expected later this year, so that, although inflation is unlikely to be a major problem just yet, pressures could begin to reappear.

It is now apparent that a critical factor in 1981 was the level of Soviet sales, which are estimated to be in the region of 250 tons.

This implies an overall net supply on the world market of around 1,180 tons for the year.

Indications are that Soviet sales will be of a similar magnitude in 1982 as another poor harvest looks unavoidable and economic conditions in the Eastern bloc are unlikely to improve much over the year, say the analysts.

It therefore seems likely that the Russians could still be large sellers to the West — not only of gold, but also of platinum, diamonds and oil (gas-oil sales from the Soviet Union are reported to have increased).

On the demand side, jewellery sales are likely to grow quite strongly at current prices, but this will not be sufficient to put any upward pressure on the gold price without increased demand from either the private investment or official sectors (see table).

On balance, demand must pick up substantially before the gold price can strengthen markedly.

This could arise from ei-

Gold Supply and Demand

Supply:	1978	1979	1980	1981 (E)	1982 (E)
Free world production	979	961	943	930	945
Net communist sales	410	199	90	250	250
Net official sales	362	544	-	-	-
Net dishoarding	-	-	350	-	25
<b>Total</b>	<b>1,751</b>	<b>1,704</b>	<b>1,383</b>	<b>1,180</b>	<b>1,220</b>
<b>Demand:</b>					
Jewellery	1,007	737	350	550	610
Industrial	301	289	242	220	230
Purchase of official coins	288	290	234	265	280
Net official purchases	-	-	230	145	100
Net private bullion purchases	155	388	327	-	-
<b>Total</b>	<b>1,751</b>	<b>1,704</b>	<b>1,383</b>	<b>1,180</b>	<b>1,220</b>

By Elizabeth Rouse

ther a sharp increase in jewellery-industrial demand as a result of increased economic recovery in industrialised countries, or a surge in speculative buying by private-official sectors following renewed fears of rising inflation and devaluing currencies.

The analysts see little chance of either eventuality over the next three months.

However, they feel that sentiment in the gold market is now at its lowest ebb and that any further downside may be limited, both by a change in expectations regarding inflationary pressure in the US later this year and by the inherently tight

supply-demand position.

The gold share market is at present discounting an average gold price of \$450. Should the 1982 gold price average less than \$400 for a prolonged period, earnings at a number of the more highly geared mines will fall severely, warn the analysts.

This is especially so as there appears to be mounting evidence of government support for the rand to maintain parity with the US dollar, and therefore little prospect of the mines being assisted by a further significant fall in the rand.

Although prospects for gold shares are therefore unexciting, inevitably there

will be a number of strong movements even in very dull market conditions. Gold shares should be treated strictly as trading situations until the gold price re-establishes itself in an upward trend.

Longer term holdings should be maintained in good quality mines only, either where there is the prospect of a good yield with minimal earnings erosion, or where there are prospects for increased earnings through growth.

Recommendations are: Driefontein, the largest and lowest cost producer which is likely to pay a final dividend of around 160c; St Helena, which is reasonably valued as life could be extended in the south sector.

UOST

86 84 82 80 78 76 74 72 70 68 66 64 62 60 58 56 54 52 50 48 46 44 42 40 38 36 34 32 30 28 26 24 22 20 18 16 14 12 10 8 6 4 2

1/3/82 (79) star

# Information

# gap lowering gold price

By David Bamber,  
Financial  
Correspondent

LONDON — The failure of the South African Government and mining houses to keep up a basic flow of information about gold supplies and marketing procedures to brokers and the media is partly to blame for many of the recent falls in the gold price caused by "psychological" factors.

In the absence of information to the contrary, speculation and even misinformation in influential quarters is helping to further depress the gold price.

For example, one influential Fleet Street newspaper reported last week that gold prices were being "driven down" largely as a result of South Africa "off-loading" bullion.

If information had been properly distributed, it would be common knowledge that:

• South Africa has a fixed policy of selling almost its entire production.

• Far from "off-loading," South Africa reduced production, as a consequence of planned mining of lower-grade ore to take advantage of the higher gold price.

• Neither South Africa nor the mines have anything to gain from over-supply and depressed bullion

prices.

I asked the chief bullion man of one large brokerage company last week what was happening to the metal. How did he see the short-term future?

He answered: "You tell me. The truth is we honestly don't know. We are completely in the dark."

It goes further than that, too. Gold is being "psyched" downwards by many brokers who are giving their clients a lop-sided view of the present situation.

They are reminding their clients that there are thousands of tons of the metal in the hands of private investors — waiting to be dumped on to the market.

Few highlight the demand and supply expectations for the year. Even fewer remind their clients that jewellery demand has picked up significantly and that the lower gold price has resulted in the sale of Krugerrands well above the levels of the comparative period last year.

### Little contact

Since the stout effort by Anglo American Corporation when they released predictions of the gold price compiled by Dr Horace Brock, there seems to have been little contact with the Press and leading London brokers to inform them of the latest developments in the market.

Daily fluctuations in the gold price prompt comment relating to

US interest rates, the oil price and Soviet bullion sales.

### Increased

While these factors undoubtedly affect the market, the impact is greatly increased by psychological factors.

Predictions on gold are difficult and perhaps not really expected but it would be reassuring to have some of the members of the greatest gold producing country in the world, even just once a month, sparing some time with those entrusted with keeping the public informed.

Bank  
04, Jan 1: Insurance Expen

Years 02 and 03 — same as

Insurance Expend  
Income Statement  
Dec 31: being closing e

Bank  
01, Jan 1: Insurance Expen  
being payment o

Premiums Treated as Business (1)

SOLUTION TO: GLS

300  
300  
000 27  
300  
000 27  
000 27  
300  
300

Dec 31:  
01, Jan  
Premium (2)  
Jan 31:  
Jan 2:  
Jan 2:  
Jan 2:

# Central banks offload gold

79  
MM  
2/3/82

Direct  
Life  
O:  
AVE

**LONDON.** — Gold continued to slip yesterday amid reports that central banks, including those of Opec nations, have been selling.

Gold was fixed at \$358.75 in London in the morning, but it rallied to \$361.25 at a long afternoon fixing. Friday's second fixing was \$362.60.

Yesterday's first fixing was the lowest since September 1979.

Gold improved slightly after the first fixing on small amounts of fresh buying and professional short covering.

Sentiment in the US and Far Eastern markets was affected by the strength of the dollar and short-term US interest rates.

US gold futures were lower in early trading. Dealers attributed the slide to US money-supply report.

Comex futures were down 40c to \$1.70 and IMM gold was off \$1.40 to \$2.70 in the nearby contracts.

NEIL BEHRMANN reports that fears of Middle Eastern and Eastern European sales are contributing to bearish sentiment in the gold market.

Dealers report that some Opec nations, notably Iran, Iraq and Libya, are selling gold because of the slump in oil prices. The Iranian-Iraqi war is costing the two nations thousands of millions of dollars and Libya's deteriorating relations with the United States threaten its finances.

Libya built up its gold reserves from 2 460 000 ounces in December 1979 to 3 580 000 last year.

Although the wealthier Opec states do not appear to be selling gold, individuals have been big sellers because they are disenchanted with the market.

Some bullion dealers, such as Mocatta and Goldsmid, are already affected by the debts of sheikhs who took a beating on the gold market.

Some bullion dealers say Romania has been selling gold.

Others say several countries carried out gold swaps at much higher prices than those ruling now and did not follow conservative banking principles.

Their gold collateral has fallen in value and these countries may be forced to sell gold if bankers refuse to roll over the loans.

South Africa's two gold swaps totalling 3 180 000 ounces were made when gold was above \$400.

Bankers believe, however, that the South African swaps were at conservative levels.

Indonesia has stopped buying gold. In 1976 Indone-

sia held 60 000 ounces and lifted its gold reserves to 280 000 ounces in 1979. Indonesia accumulated gold in the next 18 months at prices ranging from \$450 to more than \$600 an ounce.

Since the middle of last year, the Bank of Indonesia has stopped buying and its gold reserves remain at 3 100 000 ounces. However, there are no signs of Indonesian sales, but the market is worried about its deepening trade deficit.

There are signs that some central banks are buying gold, possibly through the Bank for International Settlements. Dealers say some countries, for example Britain, are trading in gold — buying for resale at a profit.

Far Eastern central banks continue to trade in the market. Singapore, a wealthy nation, recently sold gold. But the disposal was for trade.

Statistics from the International Monetary Fund show that three producing nations withheld gold last December in a futile attempt to support the market. South Africa's gold reserves rose 110 000 ounces to 9 290 000 ounces, and Brazil and Colombia each withheld 30 000 ounces.

The Canadian central bank appears to be a shrewd operator in the market. It sold all the way down and last December 190 000 ounces was thrown on the market. In 1981 the Canadians sold 520 000

bounces.

Romania reduced its gold holdings by 70 000 ounces in the 10 months to October and Portugal shed 20 000 ounces.

Bullion dealers say that the market may be stronger than is accepted. The Japanese increased their gold purchases from 30 tons to 180 tons last year and are still strong buyers. European jewellery demand also appears to be double the levels of early 1980. Those levels, however, were depressed.

Bullion managers are still surprised that the mining houses have not made use of hedging facilities either through the bullion houses or through the US markets. Amounts of gold hedged have been small.

One manager said the houses were trapped by their own mistake. Having failed to hedge at \$500 it was embarrassing to hedge at \$400 and even more vexing to sell forward at current prices.

Bullion managers still believe the mines should hedge.

Some wonder whether State aid is a disincentive to hedge. The mines are assured of being subsidised by the State, so perhaps the mining houses believe there is no point in hedging.

Others say shareholders might query hedging at current low prices.

The dollar weakened in the morning in London after its firmer opening on the back of Friday's \$1 200-million rise in US M-1 money supply.

(2) Premiums Treated as an Asset - Cont'd:

Year 02 - same as year 01	03, Jan 1: Life Policy	Bank	Income Statement	Life Policy	Policy written down to surrender value
300	300				
60					

(See Note 1 below)



# Churches told gold is key in apartheid fight

ARGUS 5/3/82 79

Argus Bureau

LONDON. — Churches here have been urged to enter the field of high finance to increase pressure on South Africa to change its apartheid policies.

Professor Charles Elliott, of the University of Swansea, said here: 'Churches should not be hoodwinked into thinking the international monetary system could not survive the loss of gold from South Africa.

'Gold is now too serious a problem to be left to the experts and churches and other organisations should press for monetary reform and the dethronement of gold.'

#### DEPENDENCE

He said South Africa depended on its gold sales at present and the loss of these could help force it to rethink its policies of discrimination.

Addressing the annual meeting of the Christian Concern for Southern Africa organisation, Professor Elliott said it was difficult to persuade

nations to take political action against South Africa because of the fear of checking the flow of gold.

'One can't divide this from the South African Government's oppressive legislation,' he said.

#### SWA PLAN

He added that the international monetary system could survive without gold if special drawing rights (SDRs) were developed properly.

Another speaker at the meeting, the Rev John Johansen-Berg, described the problems facing the people in SWA/Namibia and urged Western governments to consult church leaders in the territory before coming to any final solution for its independence.

He said this was important because an estim-

ated 90 percent of the territory's inhabitants were Christians, and their leaders knew their problems and what they wanted from independence.

Mr Johansen-Berg, who visited the territory last November, said:

'The people there want peace but they don't want peace without freedom.'

Ⓢ An emergency resolution condemning the ill-considered action of English cricketers going to South Africa at this time was also passed at the meeting.

# Gold's 2½-yr low

ARGUS 5/3/82

79

Finance Editor

THE price of gold — South Africa's most valuable export — fell again today following increased sales from Middle East oil producers who have been hit hard financially by the slump in the oil price.

In London today gold dropped to 337 dollars an ounce—the lowest for 30 months—before recovering to 340 dollars.

Since Wednesday the gold price has fallen by 10 dollars and since last Friday by 20 dollars.

It is now about 67 dollars below its price at the start of the year and

some 500 dollars below its peak of around 860 dollars reached for a few minutes in January 1980.

This year's fall in the gold price is the result of greatly increased sales from among many sources. These are:

● Forced selling by speculators squeezed by the higher interest rates;

● Sales by Russians to raise funds to buy grain for their own country and Poland;

● Sales by disillusioned investors; and last but not least

● Sales by Middle East oil producing countries.

As Russians, the other

main producer of gold after South Africa, tend to phase their sales carefully so as not to depress the gold market, it is believed that the latest sales of the metal, which have a sign of panic about them, are coming from the Middle East.

## OIL SLUMP

As a result of the slump in the oil market it is estimated that the Middle East oil producers' revenue from gold has been at least halved from about 1 000 million dollars a day to around

(Contd on Page 3, col 1)

# Gold

ARGUS 5/3/82

79

(Continued from Page 1)

500 million dollars or less.

The bulk of this money is still going to Saudi Arabia, so other producers must be running short of funds and have started selling the gold they bought in the boom days of 1979 and 1980.

## IMPLICATIONS

The latest drop in the gold price has implications for the South African economy. However, while unwelcome these implications are not so serious as to cause alarm.

This is because the gold mining industry, while an important sector of the economy, is no longer as dominant as it was even 10 to 20 years ago.

In the past 20 years South Africa's has become an industrialised country with gold contributing far less to the national wealth and employed than it used to do.

The gold mining industry, moreover, is not likely to be as hard hit in the immediate future as the drop in the gold price suggests. Most gold mines can vary the value of the ore they mine in line with the gold price. So by mining richer ore when the gold price falls they can maintain profits and employment.

A more serious consequence is that the gold mines could start cutting back on their expansion programmes which could hit the construction and engineering industries on the reef. However this would be a long-term development.

Although the Government's tax revenues will be affected by the lower gold price, here again the impact is unlikely to be as large as might be supposed.

## TAXATIONS

Gold taxation has dropped recently, partly because of the lower gold price, but also to a great extent because of tax write-offs as a result of major expansion programmes. So any cut back in new investment would increase tax revenues.

The most serious impact of the lower gold price would probably be on the balance of payments. As the drop in the gold price reduces the country's foreign earnings it means that it can buy less from abroad.

This might make it necessary for the Government to slow down the expansion of industry.

On the other hand, the lower oil price should lead to a significant reduction in South Africa's import bill as petrol, plastics and other petroleum-derived products should drop in price.

This could help to stimulate the South African economy, and the economies of many other countries as well, leading to a new economic upturn soon.

# Gloomy budget feared as gold nose-dives

CAPE TIMES  
5/13/82  
79

By GORDON KLING

THE COUNTDOWN to the national budget on March 24 took on an increasingly gloomy background yesterday as the gold price dived to a close of \$344,25 in London, a drop of \$9,25 on the previous day's close.

Share prices on the Johannesburg Stock Exchange continue to fall and interest rates are still soaring.

Coming at a time when the Minister of Finance, Mr Owen Horwood, is wrapping up the budget package, the recent adverse developments can be expected to accentuate the unpleasant consequences of what is certain to be a relatively grim financial year, even though much of the sting will have been removed by the recent increase in GST and introduction of a 10 percent import surcharge. Gold was fixed on the

London bullion market yesterday morning at \$347, a decline of about \$500 an ounce since the peak at the beginning of 1980. With every \$10 fall in the gold price meaning a R200-million loss in foreign exchange to South Africa, the swing in the yellow metal's fortune now amounts to a loss of about R10-billion over a full year. About half of this represents a loss to the Exchequer from reduced gold-mining company tax receipts.

And while the Department of Finance did not base projections on anywhere near the peak price, I understand there is serious concern over the present price level. One of the most senior officials managing the country's economy jokingly told a casual gathering two weeks ago, when gold was \$30 an ounce higher, that he almost cut his face

while shaving when the SABC recently incorrectly reported a gold price virtually identical to that now ruling.

The slide on the JSE in the past two weeks has knocked about 10 percent off share values, compared with a loss of 4,1 percent for the whole of last year when the downturn in the business cycle began.

Reflecting the tighter money conditions in the slump, the country's major banks yesterday announced another one percent rise in the prime rate charged their best customers to a staggering 20 percent, up three percent in the past few weeks and nine percent ahead of this time last year.

It is considered certain that Mr Horwood will avoid any increase in direct taxation on the 24th, but reintroduction of a loan levy on companies and possibly personal incomes as well is now being viewed as increasingly more likely. Any concessions are regarded as likely to be very minor indeed.

JUST

66 64 62 60 58 56 54 52 50 48 46 44 42 40 38 36 34 32 30 28 26 24 22 20 18 16 14 12 10 8 6 4

GOLD

79 FM 5/3/82

Mail

# Supply side sentiment

Is gold capable of doing anything but drift down slowly? Not if this year's performance is anything to go by. From a high of \$403.50 in the first week of January, bullion has drifted, with a few rallies, below the \$360 range. And there seems to be further to fall.

It is easy, of course, to be positive about gold on a longer view. But as far as the near term is concerned, the gold price has little going for it. As one London bullion dealer put it, any major improvement can only come from a reversal of the currently negative sentiment of the investment sector. It is not enough that stockpiling demand by European fabricators is strong or that Far Eastern — and particularly Japanese — gold purchases are high. Prices are low because of heavy supplies to the market and expectations that these will remain high with sales from private and official stocks.

From the investor's standpoint, a quick look at the economies of SA and Russia is enough to convince him that the two major producers will continue to move every ounce

of gold they can onto the market. And when that is added to by central bank selling from oil producing nations which are now moving into deficit, there is little prospect of supply shortages combining to drive up prices. Nor is investment demand likely to be stimulated by changing economic factors. High real dollar interest rates and dismal economic performances should ensure that.

It has, of course, been argued that central banks will step in to prevent their reserves being eroded by gold's price fall. But that implies an unprecedented degree of cooperation. And, as far as speculators are concerned, any central bank support action risks being more than offset if there are major liquidations rather than simply steady sales by Opec nations which move into deficit.

The prospect, then, is of further price weakness — or at least no early and sustained improvement. We are at the stage of the gold price cycle when recovery will be hesitant at first and then gradual rather than spectacular. Investors in gold need patience, but it will eventually be rewarded.

**T**UMBLING share prices on the Johannesburg Stock Exchange reflect the agonising reappraisal of South Africa's economic prospects in the wake of the gold market crash.

The news is obviously grim. But how grim? What new burdens will Mr Owen Horwood, the Minister of Finance, be forced to impose in his Budget on March 24?

How much further can the share market fall? What is the outlook now for employment, wages and prices?

Just how dependent, in fact, is South Africa on gold?

Let us look at the role of gold in the economy.

In 1960 when bullion was at its peak, gold sales totalled a massive R10 141-million (more than all other exports put together).

That was over R4 000-million higher than in 1975 and well over R6 000-million more than in 1978.

The gold price explosion was the equivalent (very oversimplified) of an overseas gift over those two years worth some R260 a head for every man, woman and child of South Africa's 25-million population.

This windfall injection of thousands of millions of rands into the economy turned a moderate upturn into a runaway boom.

For Mr Horwood it was one continuous Christmas.

**T**HIS is how the tax and lease payments from the gold mines to the Treasury soared in the fiscal years to March 31.

1977-78 R446-million.

1978-79 R862-million.

1979-80 R1 501-million.

1980-81 R3 633-million.

That giant bonanza, plus the introduction of General Sales Tax, enabled Mr Horwood to make sweeping cuts in personal income tax that included bringing the top effective marginal rate down from 72% to 50%.

According to the Chamber of Mines gold was responsible for 17.2% of the country's gross domestic product — the total value of all goods and services produced — in 1980 against only 5.5% in 1970.

The message is clear. Gold is overwhelmingly more important to South Africa than any other single economic factor, internal or external. The severe drop in the bullion price threatens to turn the natural economic downswing into a full scale recession.

That means most worryingly perhaps, that the unemployment situation is bound to

# Gold crash: 79

## What it means

RDM Industrial share price index (Index 1968 = 100)

Gold Price (monthly average)

(\$/fine oz)

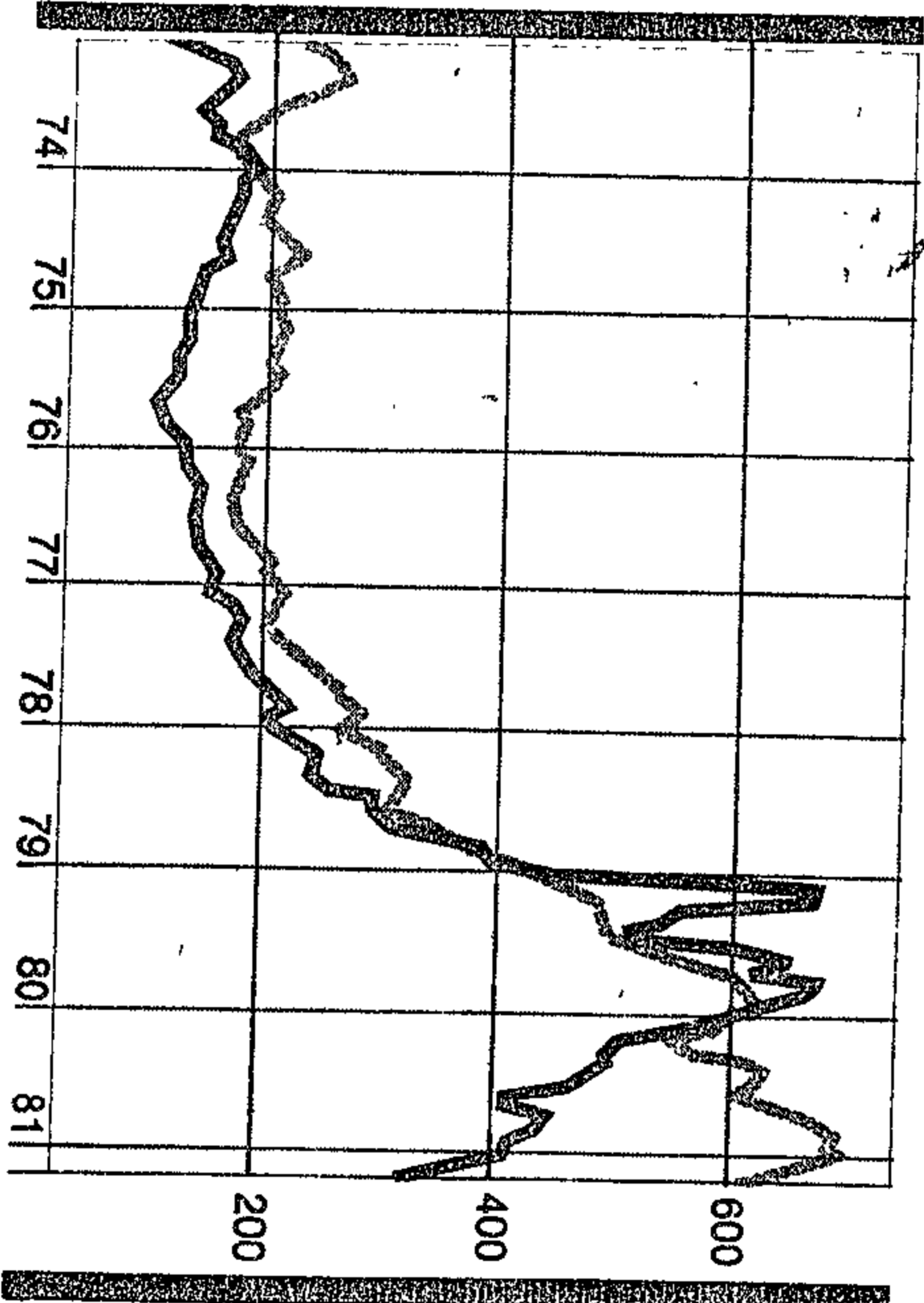

Financial Editor HOWARD PREECE assesses the implications for South Africa of the falling gold price which tumbled to \$330,50 yesterday afternoon.

worsen. Wage rises are bound to slow in money terms and probably fall in real terms.

But what about this month's Budget? The further slump in the gold price in the last couple of weeks obviously adds to Mr Horwood's problems — but not quite as drastically as seems generally supposed.

It is known that gold tax revenue for the 1981-82 year now ending will be down to about R2 185-million, nearly R1 500-million less than 1980-81. That, however, had been

estimated in the Budget last August so there is no shock there.

Standard Bank had also already calculated last month — before the mini-Budget rise in GST and the introduction of the 10% import surcharge — that with gold averaging \$400 tax from the mines would be down to R1 460-million in 1982-83.

But the further fall in the gold price over the past month means that Mr Horwood must allow for the possibility that gold tax could even drop below R1 000-million in the year starting this April 1.

Since he will in any case have to borrow heavily in the capital market to help finance the 1982-83 Budget he is most unlikely to want to try and raise even more money that way.

Further tax increases are, therefore, certain.

The most likely choice, for starters, is a 10% loan levy on both companies and individuals.

This would pull in around R660-million.

It would also, in my opinion, be far preferable to a further rise in GST, from 5% to 6%.

Another GST hike would add even more to the inflationary pressures in the economy and would put proportionately much greater burdens on the poorest sections of the community.

However, Mr Horwood's problems are not simply a matter of balancing the Budget sums.

The gold price plunge has greatly reduced South Africa's ability to pay for floods of goods from overseas.

The country's import bill soared from R9 739-million in 1979 to R14 207-million in 1980 and to an estimated R18 000-million in 1981.

After four years of surplus in 1977-80 the current account of the balance of payments showed a deficit last year of over R4 000-million.

In itself that was neither surprising nor alarming.

South Africa repaid huge amounts of foreign debt between 1977 and 1980 and was even "under-borrowed."

However, a further deficit of R4 000-million or so this year and the prospect of a further shortfall in 1983 is cause for concern.

**S**OUTH Africa's suspect political position makes it hazardous to depend on the availability of large and continuing capital flows.

Mr Horwood may well decide, therefore, to impose some additional taxes in the Budget to reduce spending power and thus imports.

Increases in duties on liquor and tobacco would be candidates here.

It is also possible if gold falls much more that further direct measures to check imports could be taken in addition to the 10% surcharge already announced.

Stiffer hire purchase regulations must also be on the cards.

With all this uncertainty and with no sign yet that gold is at the bottom share prices must still be vulnerable generally.

So, too, must house prices at the upper end of the property range.

Winter has come a little early this year. It will be quite a long while before summer returns.

# Gold's hope jewellery and small investors

77  
MDM  
10/3/82

LONDON. — The question facing the gold market over the next few weeks is whether impressive Middle and Far Eastern fabrication demand and small investor hoarding will offset sales from disenchanted investors, hard-pressed Opec nations and producers.

The message from London, Zurich, Frankfurt and New York bullion houses continues to be one of caution.

"We are probably within 5% to 15% of the low and we are due for a technical bounce, but the market still has not experienced the final sell-off which I have been looking for," says a German bullion manager.

"I am not ready to back gold with my own money and although there may be a technical rally, we could still see lower prices," says a Swiss bullion manager.

"The next testing point will be \$320 and it is possible that the price could fall below \$300," forecasts a London bullion manager.

The gold market is overwhelmingly bearish.

When gold was above \$360 there were few bear positions. But after it fell below \$350 traders and professionals sold short. The market is now in a much stronger technical position because these operators must eventually cover their positions. This is the main reason why the bullion managers are hoping for a technical rally.

From current levels the rally would carry gold to \$350.

Bullion managers say producers are withdrawing when the market is weak and selling into rallies. On the face of it this appears to be sensible policy.

But a German manager warns that such tactics can, in a bear market, work against the producer's interests.

By NEIL BEHRMANN

Over the past year price rallies have been aborted by larger than average producer sales. As soon as buyers see that price increases are limited they withdraw their orders and the next decline is deeper than the previous one. The manager advises producers to sell normal production regardless of the price and the market will adjust to these sales.

"I would much rather have the sharp final sell-off followed by a steady improvement in the market than this awful drift which pulls the price to lower and lower levels," he says.

The latest price decline, according to bullion managers, came about because disenchanted investors panicked and sold gold accumulated all the way down. Sales from weaker Opec countries like Iran and Iraq fuelled the collapse. But although the Russians sold about 50 tons earlier this year they have been out of the market.

The Russians took an unusual step and instructed a Swiss bank and a German bank to tell the media that they were not to blame for the fall. Swiss and German bankers accept that the Soviet Union is out of the market, but they believe it will be forced to sell again.

There are also reports of large bad debts incurred by Arab millionaires. Although their gold holdings have been sold, news of the debts has had a negative impact on the market.

But the main reason for the depression in the gold market is that the major Western and Eastern bloc economies are in a deflationary trend.

"Gold is no longer following interest rates. If it were it would have risen because US interest rates have fallen," says a London bullion manager. "Investors are selling because of falling oil prices — another sign of interna-

tional deflation."

Although investment demand is weak there has been a dramatic increase in fabrication demand in the Middle East and Far East. This demand could be the saviour of the gold market.

Mr Timothy Green, precious metals consultant of Consolidated Gold Fields, says: "The physical offtake from jewellers, coins and small bar hoarding is running at higher levels than producer supplies, including Russia. Eventually this must have a positive impact on the price."

Mr Green, who has returned from the Far East, found that besides excellent demand from Japan, gold purchases in Indonesia, Dubai, Kuwait, India and Middle Eastern countries were at much higher levels than in 1981.

"In the first six weeks of this year Indonesian demand was almost as high as orders for the whole of 1981," says Mr Green.

"Refineries cannot keep pace with the demand in places such as Dubai. Italian jewellery purchases are back to the levels of 1978 and 1979.

"The situation is very similar to 1976. Then a wave of investment selling pushed gold to lower and lower levels while the Middle Eastern bazaars and shrewd small investors were buying gold.

"Although prices may fall further, a few years from now we may look back with hindsight and say it was a good time to buy."

# Hard-pressed Soviets sell <sup>(79)</sup> 60 tons of <sup>Star</sup> gold in month <sub>12/3/82</sub>

**The Star Bureau**  
**NEW YORK** — The Soviet Union is so hard-pressed for foreign exchange that it sold off 60 metric tons of gold in January — the largest amount recorded in one month.

The US Secretary of State, Mr Alexander Haig, said later that the Soviet foreign exchange crisis was partly because of the situation in Poland, reports Reuter.

He made the claims during a Senate subcommittee hearing at which America's European allies came under attack for refusing to give up plans to build a natural gas pipeline to the Soviet Union as a protest against the crackdown in Poland.

Mr Haig defended the allies, whose economic actions had har-

med the Soviet Union, he said. In January the Soviet Union sold more gold than in any month in previous months of record — 60 tons compared with 200 tons for the whole year. The reason was Soviet "cash problems."

State Department officials said the estimate was reached on the basis of compilations by Western gold buyers. Based on the price of gold in London, the sale would have been worth 810 million dollars.

Soviet gold production is a state secret but Western intelligence agents estimate that about 300 tons are produced annually, and about 60 of them are used domestically. South Africa produced about 650 tons a year.

The Soviet gold sale

to relieve its foreign exchange problems, in tandem with South African gold sales for the same reason, could have been a major contributor to the dramatic drop in the gold price since January.

The US dollar rose sharply in relation to other currencies on foreign exchange markets yesterday as US interest rates increased moderately, AP reports. Gold prices slumped.

The dollar's strong performance came after a federal government report that US business inventories fell 0.4 percent in January. Also, at least two medium-sized US banks raised their prime lending rates from 16 percent to the 16.5 percent level quoted at most banks. Interest rates in US money markets rose.

In Strasbourg, France, the European Parliament called on EEC finance ministers to co-ordinate their monetary policies to help stem the US dollar's increasing value against their currencies and to agree on a joint policy leading to a reduction in interest rates.

Yesterday gold for current delivery dropped 8.60 dollars to 328.10 dollars on the commodity exchange in New York. That was the lowest price for gold since August 31, 1979 when it closed at 317.60 dollars an ounce. It opened in Hong Kong today at 326.68 dollars.

I  
i  
S  
T  
or  
Li  
pa  
er  
Ge  
mi  
sub  
cl  
Ma  
I  
Inv  
th  
co  
IG  
to  
its  
er  
aj  
lo  
te  
fe  
Li  
tio  
for  
ou  
Le  
Li  
of  
in  
in  
toc  
wh  
off  
Fre  
pr  
in

## GOLD <sup>79</sup> Going East

FM 12/3/82

Japanese enthusiasm for gold is running high. Bullion imports in January were 27 t. In 1981, the total hit 167 t, a staggering rise from the 32 t of the previous year.

Imports are expected to go even higher this month as the Japanese retail banks (21 000 outlets) stock up for April 1 when they will be able to deal in gold (FM January 15). And on the same day, a Japanese futures market opens for business to cream off some of the business presently dominated by Hong Kong.

In spite of the precipitous fall in gold — or perhaps because of it — Consolidated Gold Fields analyst Louise de Boulay, just back in London from Japan, reported queues outside shops selling 100 g to 1 kg investment bars last week. Almost inevitably the surge in Japan's interest has led to reports that its central bank is diversifying its reserves — and whittling away at the current account surplus — by stepping up its gold holdings.

The reports make some sense. Japan's 24.2m oz of official gold valued at \$300/oz constitute only 21% of total foreign reserves of \$34.7 billion. This proportion was the lowest among the West's industrial heavyweights. On international monetary fund figures for the end of 1981, it compared with 81% for the US, 63% for Canada (which sold last year), 53% for France, 50% for Italy, 40% for Germany and 28% for Britain.

The Bank of Japan, however, strenuously denies any change in its policy of neither increasing nor decreasing its gold hoard. Indeed the liberalisation of bullion dealing regulations to allow the banks in (although

they will have to buy supplies through the big trading corporations) suggests it is encouraging private hoarders — who could achieve the same net effect as if the bank itself was a buyer.

However, according to a US analyst, in the past week the Bank of Japan has made official purchases of gold in substantial quantities in the private market. "This is the first such move by a major industrial country in recent years," he says. "Because of its huge trade surplus, Japan has been accumulating large foreign exchange reserves and has long desired to diversify its holdings through gold acquisitions."

Two factors prevented official gold buying until now. First there was an awareness in the Ministry of Finance that in the normal thin market for gold, official purchases in quantities of any importance would quickly escalate the price. The second deterrent was a concern that official Japanese gold purchases might offend the US Treasury. But under current market conditions, these factors scarcely apply. The Bank of Japan has been able to acquire gold at what is apparently considered a good price without major repercussions in the market. And the US Treasury, which is aware of these actions, has made no private or public objections. The Japanese official gold purchases are not viewed as a support operation, but rather as an intention simply to build up stocks under apparently favourable conditions.

But equally the Bank of Japan has shown concern about currency outflows recently. The \$7 billion flood of zero coupon Euro-loans this year (FM January 29) have been a disturbing hit with Japanese investors because the effective interest — paid in a lump sum on redemption — ranks as a cap-

ital gain. In addition the surge in "Samurai" bonds — money raised in Japan by foreign groups lured by low interest rates — has increased capital outflow.

Therefore, the Bank of Japan is leaning gently on the retail banks to "go easy" on advertising campaigns about the long-term virtues of gold as an investment. That said, the Japanese penchant for "fashion" could prove the stronger force and gold is a buyer's market.



# Deflation <sup>(79)</sup> reason for gold slump

S. Times 14/3/82

LOWER oil prices, high interest rates, Russian sales and Middle East dumping all make good headlines, but the real reason for the slump in precious metals prices is that major Western economies are caught in a deflationary spiral.

Except for the early Thirties, when a fixed gold price was raised to \$35, a deflationary economic climate has always proved to be bearish for gold because the metal feeds on inflation.

Historic labour agreements in the United States and Canada, where Ford workers agreed to a wage freeze for 30 months and Macmillan Bloedel, Canada's largest forest-products company, actually cut salaries, are further signs that the man-in-the-street is accepting deflation and is not expecting a wage increase year by year.

With the squeeze biting and several mines under acute financial pressure, such a trend is not unforeseeable in South Africa.

But it is already apparent in the gold market with bullion deflating from a peak of \$850 an ounce to the lower \$300 range.

"There is good two-way business at current levels, but the bear trend is still in force," cautioned a London bullion manager.

He confirmed the findings of Timothy Green, gold consultant of Consolidated Gold Fields, that fabrication demand and small-bar hoarding had surged in the Middle and Far East.

Yet sales from the large investors, including wealthy Arab sheikhs who had been buying steadily all the way down, were swamping this demand.

With supplies of disenchanted investors still in ex-

By Neil Behrmann  
London

cess of demand, the market is weak.

Mr Green's view is that the Middle East bazaars were buyers of gold near the bottom in 1976, when the so-called sophisticated experts in the northern hemisphere were selling.

Yet he, too, is worried about this "second wave of investment selling" and fears that the price could fall in the short term.

Also at a Consolidated Gold Fields gold conference last year, Mr Green remarked that the small Arab investors were buying, and this was perhaps a sign that the market had bottomed.

But the price then was \$490 and, despite purchases of the little man, the disenchanted big investor has still had the upper hand in the past nine months.

The future of the gold market over the long 26-month bear market is that all the experts have been wrong at one time or other.

Bullion experts talked of support levels at \$650 then

● To Page 3

## Deflation the reason

S. Times 14/3/82

from \$400 to \$700 and then \$850.

The latest downward drift, which has continued for a much longer than expected period, has surprised almost everyone.

Thomas Holt, of Holt Investment Advisory, a New York consultancy, is one of the few who have been right.

Yet he, too, was wrong because he became bearish too soon and in 1979 was amazed to see the gold price soar

● From Page 1 (79)  
\$800, then \$550 down to \$480, \$390 and now the latest support level at \$300.

The experts who were bearish at \$600 became bullish at \$400 and the bulls at \$600 became bears at \$390.

Being too close to the market, all expected a repeat of previous post-war cycles.

"We are in a transition phase from an inflationary to deflationary era; that is why we are still seeing high interest rates in the face of depressed economic activity," says Mr Holt, adding that gold will bottom in the \$250 to \$350 area because that level reflects its true value in terms of inflation.

# Gold expected to earn even less

CALC TIME 125/3/82 (487) 79

Political Correspondent

HOUSE OF ASSEMBLY.

— The sharp drop in the gold price has meant a massive loss of government income in the past year — and this revenue is expected to drop still further in the year to come.

Giving these figures during his Budget speech yesterday, Mr Owen Horwood, also expressed continuing confidence in the long-term prospects for gold.

The Minister of Finance said estimated receipts from the gold mining industry in the 1982-83 financial year would probably not exceed R900-million, compared

to the R2 171m in the current year.

This represents a reduction of nearly R1 300m in one year.

"This huge loss in revenue is the direct result of the adverse effect that the drop in the gold price and cost escalations are expected to have on the operating results of the gold mines," he said.

"While I am certainly not pessimistic on the longer term outlook for gold — anything but — it would only be prudent to assume that the average gold price for the year 1982-83 will be significantly below the average realized during the current financial year."

## Long-term insurance tax up

HOUSE OF ASSEMBLY

— The Minister of Finance is to push up tax on long-term insurance companies and has instructed the Commissioner for Inland Revenue to investigate the taxation position of these companies further.

"Over the years the long-term insurance industry has grown enormously," Mr Horwood

said. "I feel it is only fair that it should make a greater contribution to the Exchequer."

He proposed that the percentage of gross investment income used as a yardstick to determine taxable income be increased to 40 percent. The additional revenue expected from the insurance industry in the current fiscal year was R38-million. — Sapa

GOLD

79 FM 16/4/82

# Guns and short-covering

The confluence of an apparent deadlock in British-American-Argentine negotiations on the Falkland Islands, increased tension on the Israeli-Lebanon border, further slippage in US interest rates and short covering pushed gold to \$366/oz by noon on Wednesday — 17.7% up from its March low.

London bullion dealers and gold analysts were divided on the influence of the Falklands factor as a market trigger as US Secretary of State Alexander Haig returned to Washington, thwarted in his first attempt to stop a shooting war in the South Atlantic between two US allies.

Sharps Pixley gives it little credence: "The Falklands crisis is a non-issue for gold unless the Russians get seriously involved. The Middle East might be a contributing factor but political events have really lost credibility in terms of moving the gold price since the Iran-Iraq war started. There are a lot of short positions in the market. What we have is a short market which is running away with itself."

At Johnson Matthey, Patrick Smith comments: "The Argentine situation must have some impact in the way that any international tension does. But in broader terms a lot of people, especially in the Middle East, have been waiting for gold to react upwards from the \$311 level. The market overreacted to reports of heavy Russian sales (the 60 t supposed to have been offloaded in January) and a correction was due. Now the momentum is being carried on."

Other dealers and analysts, however, believe the political factor is back in the market, combined with the heavy short position and the failure of US interest rates to go

higher.

"The Europeans are concerned at what is seen as a possible rift in Anglo-US relations. Mrs Thatcher is telling Haig it is time he behaved like an ally over the Falklands and not just an umpire," said one analyst. "We have also heard reports of a big Arab buyer in the market because of the Israeli threat to go into the Lebanon."

"On top of this you had a situation where almost every professional in the market was bearish of gold at \$312 even though there was evidence that physical demand was strong and that Russia had placed a lot of bullion outside the market (through

## LOCAL ANGLE

In Johannesburg, the rand closed on Wednesday marginally easier against the US dollar. The markets were, however, marked by an absence of activity and dealers speculated on how international events might unwind.

The rand finished on Wednesday at US 94,67/87c, slightly above the low of the day. Last Monday it closed at US 94,46/66c.

Dealers suggested the Reserve Bank had chosen to ignore movements in the gold price when responding to market forces in fixing the dollar-rand rate. As a result, they argue, the rand has been held down while gold has climbed.

The rand was more affected by the fluctuations of the pound which moved fairly erratically in response to developments in the Falkland Islands crisis.

Some dealers believed the Reserve Bank paid a large amount of attention to the dollar-sterling rate because of its relatively large weighting in the basket of currencies used to obtain the rand's trade weighted value.

Others denied this was the case, arguing that the Reserve Bank tended to set the level of the currency at a rate it would like to see for a mix of reasons and not just as a reflection of overseas events.

Summing up the position of the rand a senior dealer said simply: "We are in a wait-and-see situation."

In the forward market the premiums continued to narrow. One month was quoted at 2,33%, three months at 1,96%, six months at 1,97% and 12 months at 2,36%.

swaps). Now dollar interest rates are easing off because the expected \$10 billion bulge in the US money supply has failed to materialise.

"And in the background, even if it looks unlikely right now, there is the fear that if the Argentine is forced to default on any of its \$32 billion of foreign debt we could have a major international banking crisis. It all adds up," he said.

With the dollar easing at midweek the pound firmed slightly, although at \$1,7675 it was still 2c off its pre-Falklands level. Sterling's trade weighted average was 90,1 (91 on April 1) and the London Stock Market was calm ahead of Thatcher's report to Parliament. The Financial Times 30 share index stood at 552,2 (against 571 on the day of the Argentine invasion) but 10 points above the low hit after Lord Carrington resigned as Foreign Secretary.

Falling dollar interest rates were a major influence with the key Federal funds rate down at 14,75% (15,375% two weeks ago) and 13-week treasury bills at 12,65% (from 13,2%).

Apart from copper, up 5,7% mainly because of the suspension of Phelps Dodge production, base metals were quiet. Compared with April 1 levels, tin was only 0,7% higher at £7100/ton, lead 3,7% up at £331 and zinc 0,6% better at £415.

Gold was 13,3% higher than it was on the day Argentina invaded the Falkland Islands. Platinum, at \$353/oz, was 12,8% higher. But the sterling price of silver lagged with a gain of only 7,8% to 429 pence an ounce (a dollar improvement of 6,6%).

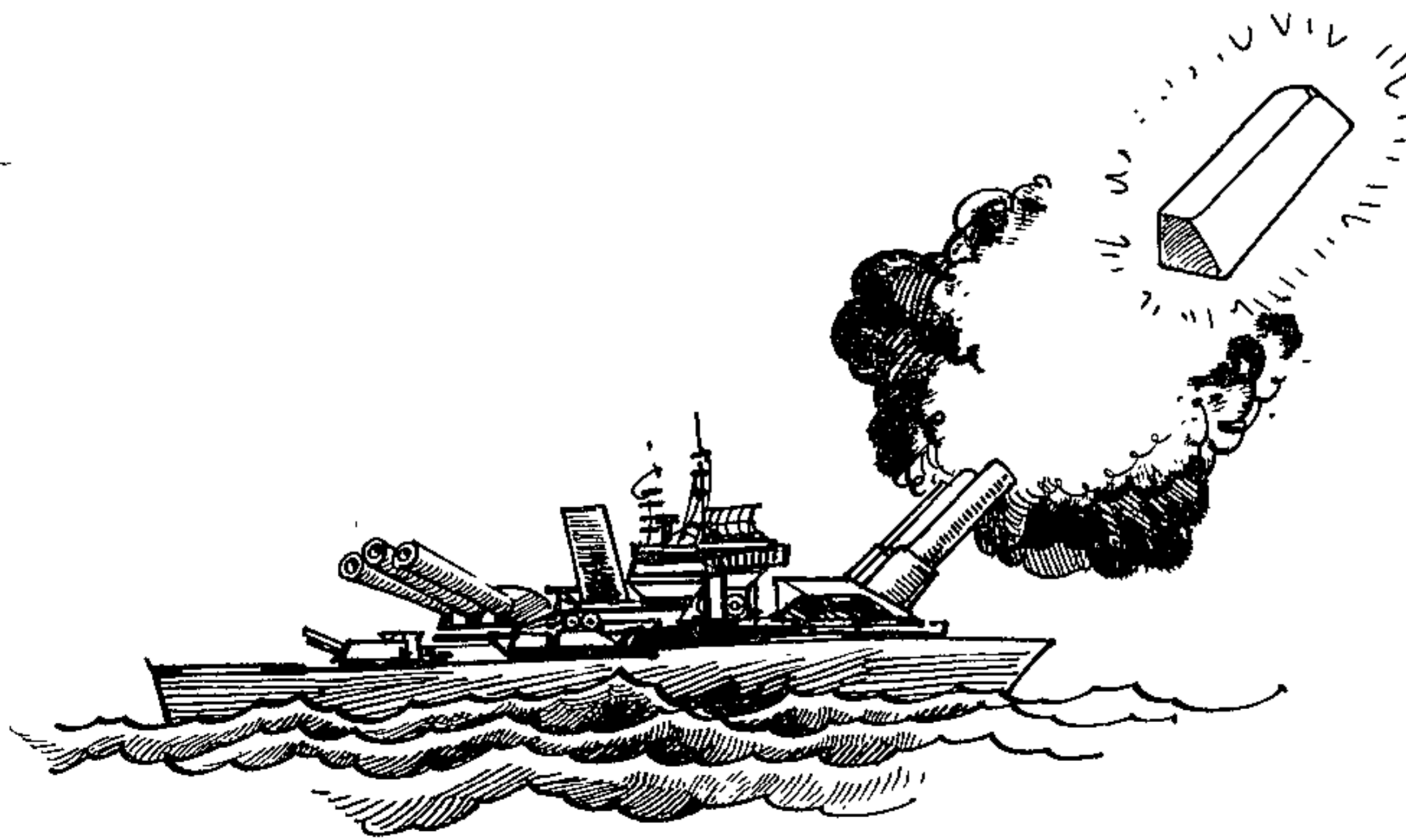

## US GOLD COMMISSION

### The final report

79 FM 7/5/82  
"If it ain't broke, don't fix it," is one of the more hoary but still favourite clichés of the American congressman. It demonstrates a healthy belief that while obvious improvements to a machine or a political system are tempting, they should not be tried while the object is still functioning adequately.

American gold bugs forgot that dictum. Last year, led by South Africa's self-appointed best friend, Senator Jesse Helms, the US Congress ordered the Reagan Administration to set up a blue-ribbon commission to study the American monetary system and to focus specifically on proposals to make gold the centre post of the US dollar.

Pro-gold forces in the US had good reason to believe that they at last had a president who was sympathetic to a gold-

based monetary system. During his 1980 campaign, Ronald Reagan had agreed to set up just such a commission and had repeatedly warned that "no nation with a strictly fiat currency has ever thrived and survived"

Yet the truth of the matter was that Reagan had no strong personal feelings about gold. The debate over the arcanities of gold, monetarism and Keynesianism were just so much babble to the candidate. Once ex-architects of Nixonomics, such as George Schultz, William Simon and Alan Greenspan, had secured the leading role in the campaign, Reagan became less vocal about gold and began to don the role of chief supply-sider.

When time came to fill the slots in the Reagan economic cabinet, the pro-gold forces had reason to worry. Chief economic adviser Murray Weidenbaum, Budget Director David Stockman and especially the new Treasury Secretary Donald T Regan were all considered anti-gold.

And when Senator Helms finally pushed through the gold commission authorisation the Reagan advisers showed just how anti-gold they could be. The Administration's selection of 17 commission members contained some leading pro-gold spokesmen such as Congressman Ron Paul and Lewis Lehrman, a wealthy Reagan backer who was building a reputation as an economic theorist. But fully 12 of the panel

could be counted as either vaguely or accidentally anti-gold, including Secretary Regan himself, economic guru Weidenbaum and Henry Wallich, the Federal Reserve Board member.

Then there was the choice of staff director. The selection of Anna J Schwartz was akin to choosing the fox to judge the poultry beauty contest. Schwartz not only was the co-author with monetarist Milton Friedman of his landmark book on world monetary systems but had established her own reputation as a leading anti-gold monetarist. As staff director, it would be up to her to draft the agenda for the busy members and to write and edit the final report.

There was a brief flicker of publicity and debate when the commission finally got underway last summer. Major magazines featured gold bars on their covers and, after lengthy debate of the issues of a gold standard, concluded that there was as much to say on one side as the other.

#### Recommendations

Only when the commission meetings wore on into the autumn did the clear trend toward an anti-gold conclusion emerge as inevitable. Some panel members, such as Paul, grew disenchanted with the complexities of the issues involved. Others, such as the politically ambitious Lehrman, dropped away from attendance to run for governor

of New York. Economic adviser Weidenbaum was a faithful attendee but paid no attention to the proceedings. He quipped to the FM after one session: "I love these meetings. I can work on my correspondence all afternoon without the phone ringing."

The commission's final recommendations were published last week and it is safe to report that the six main conclusions of the report did not satisfy anti-gold forces, while at the same time angering the pro-gold standard side considerably. Instead of flatly rejecting the idea of a gold standard for the US dollar, the panel then plunged ahead to endorse the current floating exchange rate system, the current system for valuing the US gold stock and the power of the US Treasury to periodically sell off part of the 264m ounce American gold hoard — none of the questions which the original legislative mandate wanted the panel to consider.

In summary, the gold commission recommended the following action on the six main issues under study:

□ The current sales of gold medallions by the US Treasury should be improved so as to attract the widest number of public buyers. Sales of the one ounce and half-ounce medals, which commemorate various US artists, have lagged for the last 18 months.

□ On the issue of whether the Treasury

# Sombre scenario

Gold faces a far more sober, if not sombre, future if action is taken on some of the ideas expressed this week at the Montreux conference on bullion and the monetary system, writes the *FM's* European editor from Switzerland. It was a major international talkshop (sponsored by the *Financial Times* and *The Banker* magazine) at which price forecasts were conspicuously absent.

One was proffered. A lukewarm estimate of \$500/oz by 1986 — barring economic accidents — came from Dr Hans Mast, executive vice president of Credit Suisse, who concluded that the long-term investment outlook was: "Quite good, though not at present extraordinary." Which might explain why SA's goldmining industry was represented by only four delegates. The other 150-odd delegates found the main thrust was on how to restore order to the gold market after three chaotic years. Senior Deputy Governor of the Reserve Bank Dr Chris Stals was heard banging the familiar drum of remonetisation — but a pragmatic version which stopped well short of the "dreams of making gold the impersonal disciplinary regulator of economic policy decisions." And he forecast that central banks will be taking a more active interventionist role to bring greater stability to the gold market.

The Stals version of "the formal remonetisation of gold" hinges on the need to codify and standardise the use of bullion in official transactions and so properly reactivate the over 1 billion ounces in national reserves. In what some bankers at the conference saw as a small cry for help, Stals asked for international rules (administered either by the IMF or the Bank for International Settlements) to replace the current multiplicity of methods of valuations and the ad hoc way in which swaps or gold collateralised loans are effected.

## Flexible system

As Stals sees it, there should be no difficulty in establishing a flexible system which can take account of gold's dual monetary-commodity status. "A formula for the pricing of official transactions in gold can be based on a fluctuating price — for example the London fixing," he maintained. His points were complemented by Robert Guy, director of London bullion house N M Rothschild. In what looked like an oblique reproof for marketing policies (at least in the past) Guy expressed the hope that central banks and major producers had learned something from the upheavals since 1979. He pointed out that in 1980 when the gold price averaged \$615, Russian sales

fell to 80 t (from 230 t) while SA's bullion holdings increased by 60 t, either because of the unwinding of swaps or withholding. In 1981, average London fixing \$460, Soviet sales trebled and SA reserves fell by nearly 85 t (the new swaps).

Although he posed the question, Guy seemed confident of a change in policies by central banks and producers in any new bull market to both enhance foreign exchange positions and to dampen volatility in gold. "There will be no action replay of the last three years," said Guy.

More mines have learned the lesson. Guy

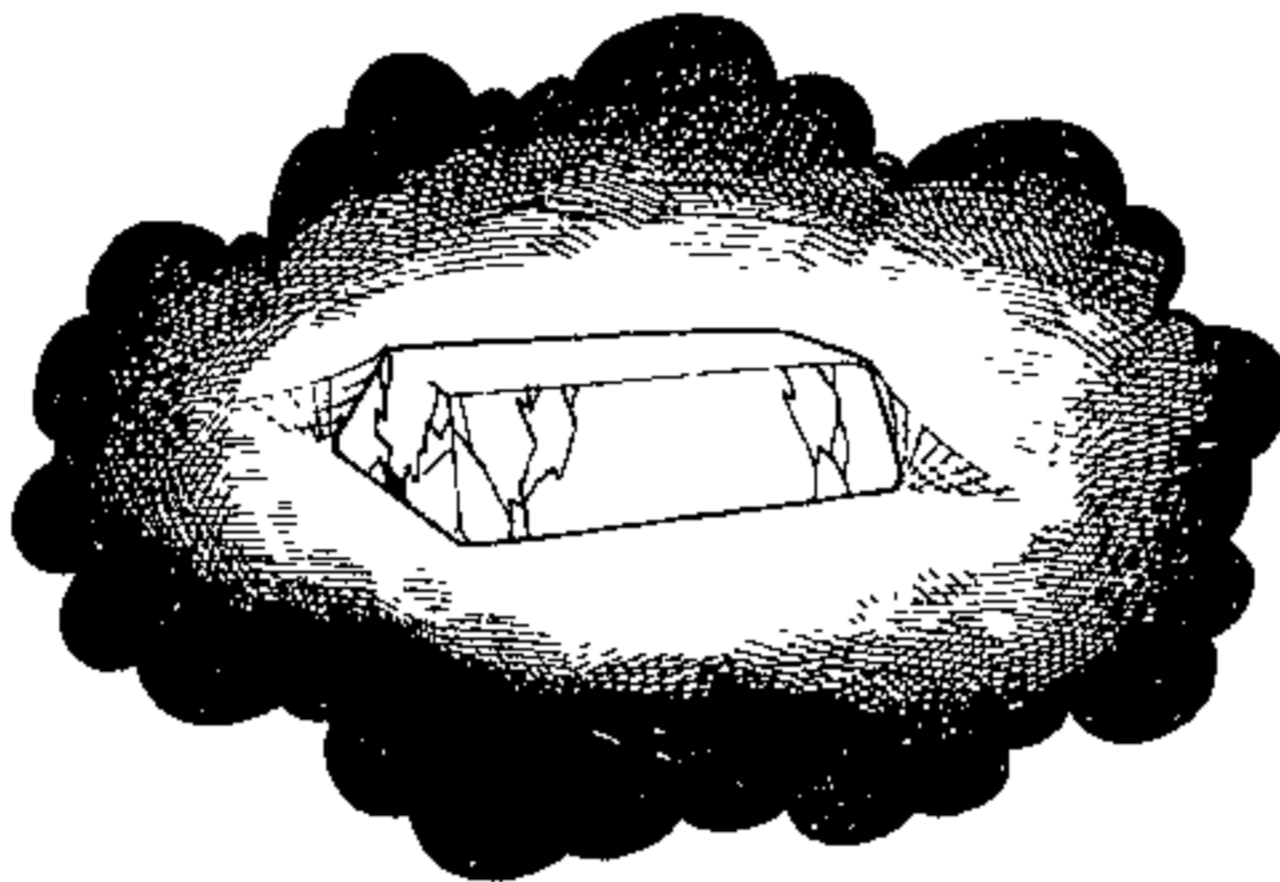

revealed that 10 SA mines were hedging forward production (either directly through futures markets or through the medium of the bullion houses). And Stals disclosed that the Reserve Bank was "under a lot of pressure" from the mining industry to act as a hedging agent itself. So far the idea has not got far. As Stals said, it would be a one-way option for the mines if they hedged with the Reserve Bank. Because they would sell in rands they would be hedging against currency fluctuations as well as gold price swings. The snag is the question of "who will bear the losses if the bank cannot cover the position," said Stals, who added "we are still looking at the possibilities."

A Reaganomic dream which could be a South African nightmare was unveiled by Arthur Laffer, a member of the Economic Advisory Board to the US President. Speaking at the Montreux gold conference, Laffer spelt out what the new wave of "classic" economics, which is superseding monetarism in the US, could mean for the dollar and hence gold. In short, the new classicists reject quantity or price controls on money. They seek to restore the quality of the dollar, ie, its value.

Laffer claimed that in spite of the US Gold Commission's rejection of the restoration of the convertibility of the dollar, the political process has begun which will lead to it. It may be 10 years — "it took us 10 to 15 years to get the dollar off gold" — but, he said, a start will be made "sooner rather than later" to the process.

Of course, the gold price would have to be a lot lower and more stable than it is now before the dollar locks back into it and ceases to be an "unhinged currency." Laffer favours a price of \$150 but he conceded it would probably be higher — \$200 or more.

Laffer's scenario was that the US Treasury would buy and sell gold (to anyone including US citizens) making a bid and offer spreads around the central parity price, if the price was bid up, indicating too many dollars, the US authorities would correct the position by selling bonds. If gold weakened because of a dollar shortage, bonds would be repurchased to meet the market. "The British did it for 200 years," said Laffer.

Any sudden disasters in world markets would be dealt with by temporarily closing the gold window again. The result would be to "make the dollar as good as gold . . . and who then would hold gold? The free market would crash," said Laffer.

He believes the gold market is already reading the signs. "The price of gold went to over \$800 when Jimmy Carter was president. Since Reagan's inauguration, it has fallen to \$330."

Laffer's enthusiasm for a gold-backed quality dollar left many delegates shaking their heads and muttering about oversimplification. But he clearly sees it as the answer. US interest rates would fall — and a 10-point drop in rates would save the federal government \$80 billion in debt servicing which currently absorbs \$112 billion. With interest rates down at 4% - 5%, the US economy would take off and with it a revival in world trade.

Laffer feels sorry for SA if this scenario comes to pass too soon. But he told the *FM*: "It really should have diversified more than it has. Its economy is too controlled and there should be more incentives for the private sector."

# High tech bedevils the gold market

(79)

ROOM

27/5/82

By JOHN MULCAHY

HIGH technology in communications has emerged as a contributing factor to the fluctuating fortunes of the gold price.

Consolidated Gold Fields says in Gold 1982 — its annual report on the gold market — that the short-term volatility in the gold market will probably persist, "being in itself a reflection not only of the growing number of participants in the market, but also the spread of instantaneous communications to every gold-dealing office in the world".

The wide-ranging and detailed analysis of the world gold markets concludes that the market has either bottomed out or is close to doing so.

It says the panic wave of disinvestment in February, sparked off by rumours of Russian and Middle Eastern selling, has subsided and provided it does not recur, leaves the market in a more soundly based position.

Prices should continue to trade in a wide range this year, supported at the bottom by strong physical demand and held at the top by profit-taking.

"Only a change in external economic or political circumstances will encourage the major investment buyers back into the market," says Cons Gold, and without their positive influence the market will find it difficult to sustain any upward movement.

The report says the tendency for all market participants to react at the same time, and in the same way to each perceived influence on the price "has undoubtedly been exacerbated by the development of sophisticated computer and chartist forecasting techniques especially associated with those dealing on the futures exchanges".

Figures presented in Gold 1982 show that contracts totalling about 40 000 tons of gold were traded on the US futures markets in 1981, or more than 40 times the amount of physical gold sup-

plied to the non-communist private sector.

The huge impact of the universal communications network makes it difficult for those holding the opposite view to withstand the sheer weight of buying or selling that results from chartist signals, "which therefore tend to become self-fulfilling".

The importance of sentiment and so-called technical factors in the gold market have become all the more apparent since the beginning of the year, says the report.

The price plunged from \$400 in January to a low of \$312 on March 15, only to recover to \$366 on April 14. It has since fallen to \$330.

These wild fluctuations have occurred in spite of the fact that there has been no fundamental change in the supply-demand pattern since the end of 1981, "nor indeed have most of the other factors assumed to affect the market altered radically".

Once a movement has started in either direction, it can be exaggerated, not only by activity in the physical market, but by the triggering of stop-loss buying or selling in the futures markets.

Since the freeing of the

gold price from official control in 1968 the market has experienced two distinct cycles, says the report.

The price first began to rise from early 1971, peaked at \$197 at the end of 1974 and was followed by two years of decline.

The second cycle started late in 1976, with a steadily rising price which culminated in the gyrations of 1979 and 1980, peaking at \$850.

In spite of a recovery in September 1980 the price has effectively been following a declining trend since January 1980.

"In attempting to judge whether the current cyclical downturn is now over, some interesting parallels and differences may be observed in the circumstances surrounding the two cycles."

In the earlier upward cycles, the similarities were:

- Fabrication demand was high in 1972-76 and in 1976-79, and in the first period fabrication demand exceeded supply, but in the second the shortfall was made up by gold supplied to the market from the official sector.

- Political tensions were running high in the Middle

East during both spells.

- After strong economic growth in the early 1970s, world inflation reached record levels, fuelled by the first oil crisis in 1973. Industrial production began to recover from the second half of 1976, accompanied by rising inflation and followed by another leap in the oil price in 1978.

Gold 1982 points to the significant influence economic conditions have on investment demand for gold, and notes that high real interest rates discourage speculation on the futures markets, removing the likelihood of any upward price pressure from that quarter until rates fall.

"By the same token, in the more sophisticated institutional investment markets, gold is bought only when the expected rate of return, in the form of a price increase, at least equates to or exceeds that from other investments."

Under present economic conditions interest-bearing assets will continue to look attractive in the short term.

"However, when gold is believed to have reached the bottom of the cycle, there are those, whether in the private or official sector, who will start buying cautiously in anticipation of improvement in the longer term."

# Physical jerks

79 FM 28/5/82

Investors hoping for an early improvement in the gold price could well be disappointed. This is the view of Consolidated Gold Fields, expounded in its latest annual report on the state of the gold market, *Gold 1982*. The basics for an eventual gold price improvement are in place, but they need time to become a dominant market factor. The trouble is, many investors have based their views on gold on trends in only one or two of the obvious factors of a complex market formula.

Starting right at the top, the demand side of the equation seems to point clearly to an imminent price improvement. For the first time since 1972, fabrication demand for new gold exceeded supply (by 51 t) last year. It is not difficult to see why. Demand for carat jewellery in the developed countries rose by 100 t to 373 t. And in the developing countries, which in 1980 dishoarded 150 t of the type of carat jewellery into which a large portion of savings are channelled, net consumption rose to 221 t. The trend is not surprising. Demand for gold jewellery in developed countries had been squeezed by the high gold prices of 1980, while in the developing nations there was heavy dishoarding in 1979-80. The trend reversed last year, especially as earlier dishoarders took advantage of lower prices to re-establish their gold holdings. Total non-communist world demand rose to 1 036 t from 542 t in 1980.

The pattern of the non-communist world's mine production was that a decline in SA with the continuing trend towards exploiting lower grade ores was more than offset by new mines coming on stream or increasing production from other countries. This increased total new mine production by 15,3 t to 961,6 t.

Taking these two trends an immediate conclusion might be that this year will see a shortage of physical gold. This is particularly so as mines in several countries have closed or are on the verge of closing. SA's production should rise, reckons Cons Gold, but the total new mine production available will increase only slightly above the 1981 level.

Several of the smaller gold producing countries decided last year to increase the gold content of their reserves by absorbing domestic production. The effect of this 260 t

absorption was effectively to offset the 283 t (against 90 t in 1980) of gold sold to the West by the communist block — again an offset which, in theory at least, should have contributed to a strengthening of the gold price.

A further development which should have helped boost the gold price was the increase in identified bar hoarding — from 7,5 t to 280,2 t according to Cons Gold's figures. The major boost came from Japan which took to gold in a big way. In 1980 it was a net seller of 15 t; in 1981 it took in 11,7 t.

In other words, there has been strong demand growth for physical gold from hoarders in the developing world and Japan, greater jewellery demand all over, increased purchases by central banks, a sharp reduction in dishoarding by the developing world and no great increase in new mine supply. And still the gold price fell sharply last year and dropped further as 1982 got into its stride.

The reason, says Cons Gold, is simple enough — dishoarding by "sophisticated" investors in the developed countries, coupled with little or no physical hoarding demand in these areas.

And this, according to Cons Gold, is likely to remain the nigger in the woodpile this year at least and not Soviet "dumping" as has frequently been made out. At which point we come back to the well known conundrum — when will things change?

Cons Gold provides the, by now, well known answer: not until real interest rates fall in the West nor until the gold price increases look at least as attractive to sophisticated institutional investors on return grounds as other investments. Essentially Cons Gold believes that the gold market needs to do a lot more spade work before it is ready for a steady advance.

The current physical demand is very price sensitive and, seemingly, ignores political developments. The gold price needs to prove that it has reached its bottom before institutional investors re-enter the market. And gold seems capable of doing this with active support from physical demand. Against that, however, has to be set the still alive penchant for profit taking as the price rises.

No help is to be expected from a remonetisation of gold, so the private sector will have to do most of the work necessary to get gold on the move again. And until the large institutional investors return, gold could find it difficult to sustain any price increase. So while Cons Gold believes the gold market has more or less bottomed out, it does not believe this signals an early strong price advance. Physical supply and demand are one thing, but in the short term they cannot overcome opposing investor sentiment. In other words, there is plenty of time to get back into the gold market.

## THE CHANGING MARKET

	1980	1981
Non-communist mine production .....	946	962
Net trade with communist sector .....	90	283
Net official purchases .....	(230)	(260)
New gold bullion supply .....	806	985
Identified scrap recovery .....	461	197
<b>A. Total gold supply .....</b>	<b>1 267</b>	<b>1 182</b>
Fabricated gold in developed countries:		
Carat jewellery .....	309	388
Electronics .....	84	85
Dentistry .....	60	61
Other industrial/ decorative uses .....	66	62
Medals, medallions and fake coins .....	18	13
Official coins .....	169	151
<b>B. Total .....</b>	<b>706</b>	<b>760</b>
Fabricated gold in developing countries:		
Carat jewellery .....	209	361
Electronics .....	2	1
Dentistry .....	2	1
Other industrial/ decorative uses .....	4	4
Medals, medallions and fake coins .....	3	15
Official coins .....	21	50
<b>C. Total .....</b>	<b>241</b>	<b>432</b>
<b>D. Small bars .....</b>	<b>N.A.</b>	<b>48</b>
<b>E. Total fabricated gold (B+C+D) .....</b>	<b>947</b>	<b>1 240</b>
<b>F. Bullion holdings (A-E) .....</b>	<b>320</b>	<b>(58)</b>
Increase/(decrease)		

able. Red or green ink may be used only for underlining, emphasis or for diagrams, for which pencil may also be used.

- Names must be printed on each separate sheet (e.g. graph paper) where sheets additional to examination book(s) are used.
- Do not write in the left hand margin.

Candidates of this year must present their answer books to the invigilator.

- No part of an answer book is to be torn out.
- All answer books must be handed to the commissioner or to an invigilator before leaving the examination.

**Any dishonesty will render the candidate liable to disqualification and to possible exclusion from the University**

# New light for gold

79 S. Times 30/5/82

A GLOOMY gold market has ignored the optimistic projections of Consolidated Goldfields, which estimates that jewellery, fabrication and coin demand is exceeding supplies for the first time since 1972.

By Neil Behrmann: London

Moreover, the company predicts that the gap will widen this year.

In its latest hefty report on the world gold market, Consolidated Goldfields estimates that fabrication demand for gold almost doubled from 542 tons in 1980 to 1 036 tons last year.

This consumption exceeded Western mine output and sales from the communist bloc by 51 tons.

Over and above this demand, hoarding of bars, especially in the Middle and Far East, reached 280 tons, the highest amount that Consolidated Goldfields has ever recorded.

All signs indicate that demand for fabrication and bar hoarding is running at still higher levels, says the report.

"It is entirely conceivable that the requirement for gold will again exceed the supply in 1982, and by an increased margin."

Yet, in spite of the much improved fabrication side of the business, the gold price continues to weaken.

The answer to this paradox, says Consolidated Goldfields is that investors are sitting on a large gold stockpile.

Disenchanted investors have been supplying the market whenever the price has rallied and have accentuated the downturn in a weak market.

The trends have been exacerbated by the futures markets because speculators have rushed to sell whenever

the price has broken various chart points.

"Approximately 330 tons must have been sold from investment holdings during the year to supply the gold required by fabricators," says the report.

So, although the firm is confident about the growth of fabrication demand, it is cautious about price forecasts.

It believes that gold will be supported at the bottom by strong physical demand, while each rise will be limited by profit-taking from investors.

Yet this week gold was again slipping towards the support levels of \$310 to \$320, and bullion dealers feared there would be another break followed by a sharp downturn.

Platinum was leading the way and fell below \$300 for the first time for nearly four years.

Silver touched a new low of \$6.35 an ounce compared

with \$50 at the beginning of 1980.

"I have yet to see a bearish report of Consolidated Goldfields. Mining houses are always bullish," said a cynical London bullion manager.

Regardless of the scepticism in the market, it does appear that physical demand, especially from the Middle and Far East, is drawing a considerable amount of gold from the market.

"Net fabrication of new gold into carat jewellery increased by 400% to 594 tons in 1981," says the report.

Although this consumption remains much lower than the annual jewellery offtake of more than 1 000 tons during the late Seventies, Consolidated Goldfields regards the improvement as impressive considering that prices are much higher than those years.

Gold demand was very strong in Italy, because the

Italian fabricators are exporting large quantities of jewellery to the Middle East and Central and South America.

Other salient features of the report were:

- Russian production is estimated at 300 tons and net sales from the communist bloc totalled 283 tons in 1981, compared with 90 tons in 1980. Rumania and Korea also sold gold.

- So far this year Russian gold sales have been lower, but Consolidated Goldfields expects the USSR to step up its supplies as the year progresses.

The company has not confirmed Russian gold swaps and believes that they are unlikely.

- Central banks, especially Indonesia, bought 260 tons last year, compared with 230 in 1980.

Most of the purchases took place in the first half of 1981 — at much higher prices. Indonesia was the main buyer, while Canada sold 16 tons.

- Colombia, Brazil, Zimbabwe and Zaire — gold-producing countries — added to their gold reserves.

- With the exception of Italy, European countries and North America bought less gold for fabrication purposes.

"..... however, one thing that does concern me about you auditors is that you tell us the financial statements are 'fairly presented'. What really mean?"  
 (A pertinent question from a user of audit financial statements.)  
 ay in response to the above question it from both an accounting and perspective.



# Gold falls <sup>Capric Times</sup> 22/6/82 below <sup>(79)</sup> \$300

By GORDON KLING

**GOLD** tumbled through the psychologically important \$300 an ounce price support level yesterday to the lowest levels in nearly three years, wiping millions of rands off deeply depressed gold shares on the Johannesburg Stock Exchange and further delaying prospects for the economy's recovery.

The London bullion price closed at \$296,75, the same as the afternoon fix and after a morning fix of \$297.

The 35 percent depreciation of the rand against the US dollar in the past two years has cushioned the blow considerably, but not enough to ease pressure on several state-assisted mines which can expect to go out of business unless a sustained price improvement gets under way in the near future.

The current price level is worth about R6,6-billion to the country over a full year, compared to possible earnings of about R11-billion at the \$850-an-ounce peak in January, 1980.

Dealers and stock market analysts had been expecting a renewal of the gold decline following the reduction of hostilities in the Falkland Islands and the Middle East, particularly since the price failed to gain much impetus from either outbreak.

● Dealers bearish, page

# Mines are sure gold price will rebound

ARGUS 23/6/82 (79)

Argus Correspondent  
JOHANNESBURG. —  
Anglo American and Anglovaal, two of the country's major mining houses, have said they had "utmost faith" in gold and were confident the price would rebound soon.

"Anglo is constantly looking at capital expenditure programmes and we have to look carefully at low-grade areas, but we do not believe the gold price will stay at these levels," an Anglo spokesman said.

Anglovaal, through its spokesman, said it had no doubts that in due course the price of the metal would rebound.

"The Government is clearly taking the correct action in allowing the

## Miners

(Continued from Page 1)

proposal of arbitration. This had been made because "a strike would hurt everyone — union members, the mining industry and the Government."

"The chamber says it can't give us more because it is concerned with the state of the economy and the mining industry. This is obviously a story," he said.

### POINTLESS

The chamber said its nine percent proposal had been coupled with an offer "which could lead to further improvements in conditions of employment later in the year."

"The unions said they were not prepared to move from their 15 percent demand."

On television last night, the Chamber's industrial relations adviser, Mr Johan Liebenberg, said arbitration would be "pointless."

value of the rand to drop against the dollar, which, in any event, is probably overvalued by virtue of the fact that South Africa's inflation rate is nearly three times that of the United States.

### CUSHIONING

"The devaluation of the rand, therefore, has the effect of cushioning the drop in the price of gold in terms of rands a kilogram."

Anglovaal said it was not impossible that, in the short term, certain mines would be caught in a working cost/gold price relationship squeeze.

Mr Ian Lamont, chairman of the joint Assocom/JCC economic affairs committee, said there may be a limit as to how far the Government would let the rand devalue. The steady fall of the rand was highly inflationary and if it was allowed to go too low it could cause more serious problems.

### PRICE DROP

A likely situation to the problem would be to increase general sales tax to make up for the loss of revenue from the gold mines.

Mr Lamont said the gold price started becoming a big problem when it dipped below R300 an ounce.

At the R300 level about 13 mines would not be able to make a profit. If gold fell to R275 an ounce another seven mines would join the list. These seven would include major producers such as Randfontein, Free State Geduld, Stilfontein and Harmony.

### UNPROFITABLE

At R300 an ounce 18-million ounces of South Africa's total annual 21-million ounce gold production would be profitable. At R250 an ounce only 14-million ounces would be profitable, meaning four-million ounces would become unprofitable to mine.

## Babysnatch Stella home

Argus Correspondent  
JOHANNESBURG. — A two-day baby-snatch ordeal ended in the early hours today when three-month-old Stella Groenewald was returned to the arms of her mother.

She was found last night in a Berea flat.

A relieved but angry Mrs Magda Groenewald, mother of little Stella, who was snatched from a Kempton Park creche earlier this week, hugged her daughter and vowed she would see justice

done to the alleged kidnapper.

A 17-year-old girl, who is married but separated from her husband, is believed to have taken Stella to her mother in Berea at 5 pm and then disappeared.

Mrs Groenewald and her husband Koen said the last two days had been a nightmare. They were still not sure exactly how three-month-old Stella had been found.

"The first we knew was a policeman tele-

phoned us at about last night and said baby had been found in a flat in Berea. He gave us the address. We went there but the baby was not there," Mrs Groenewald said.

"A Mr and Mrs Buitendach said they knew nothing about it but I found a baby's suit covered in blood which I knew was Stella's as she has an inborn complaint and is on a special diet."

"I screamed at a policeman to give me

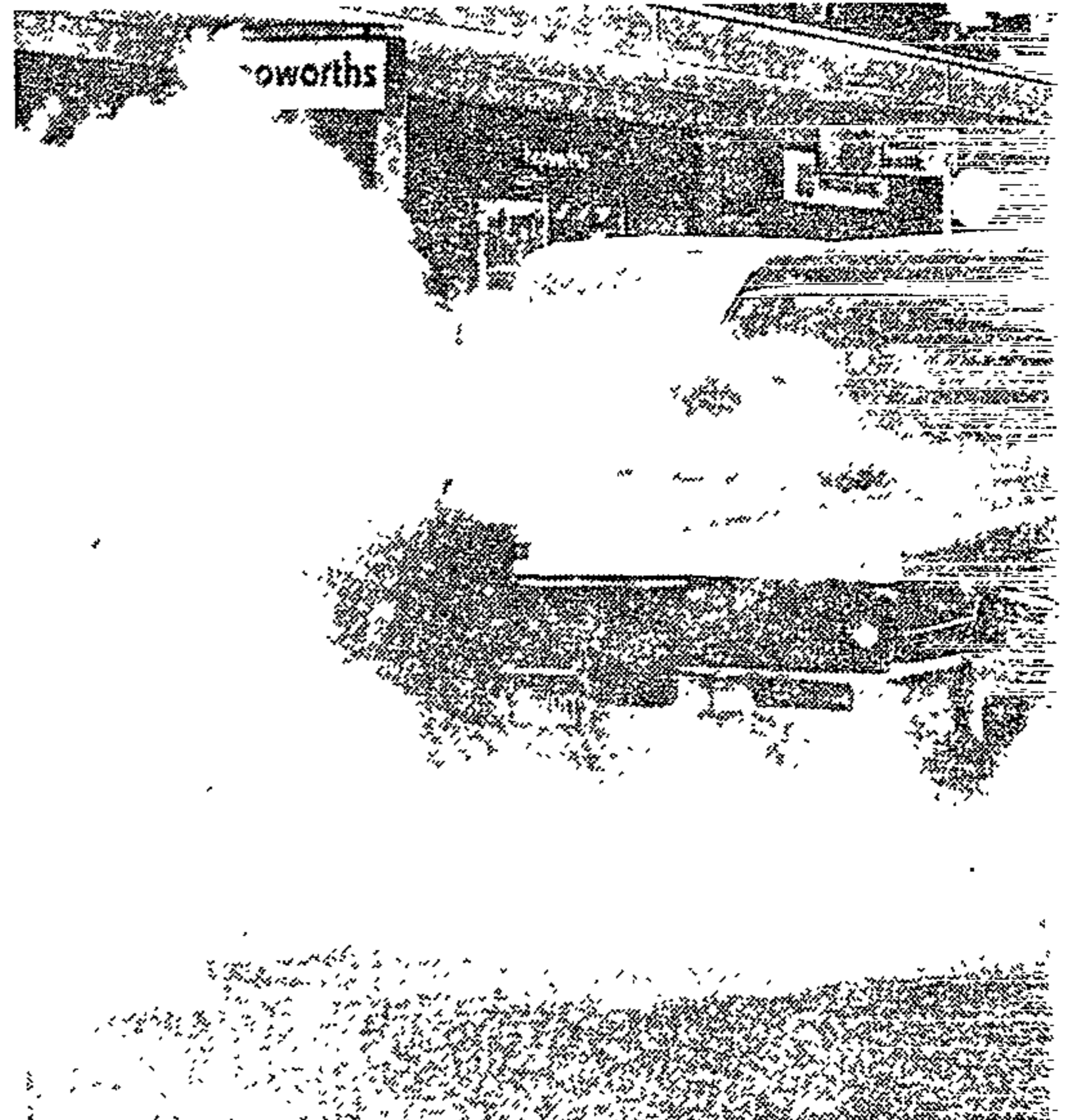

SMOKE billows from the hearse carrying former mayor's funeral in the city today. (Report P)

## Nats uneasy over Swazi land deal

### Political Correspondent

THERE is growing concern and unease in some Nationalist circles about the way the Government is handling the controversial decision to hand over Kangwane and Ingwavuma to Swaziland.

The Government has failed to respond to challenges to hold referendums of

the Minister of Foreign Affairs possibility of holding referendums have failed.

All the Prime Minister, B Botha, would say yesterday was not within the jurisdiction of provincial administration to referendums. He was referring Natal Provincial Administration to hold one.

An indication of the

# What \$250/oz would mean

FM 2/7/82 (79)

The price of gold is the bellwether of the SA economy. The expansion — sometimes erratic — of other industrial sectors in the last 50 years has not changed that simple truth. Yet few realise just how pervasive an influence gold has, especially when business activity in the West is on the ebb.

A high gold price, sustained over time, usually means a large inflow of foreign exchange, with export earnings exceeding the cost of imports. This, in turn, means a surge of liquidity filtered through from the gold mines into the banking system and other sectors of the economy. Demand rises and businessmen seek to increase profits by satisfying it. In that way the economy grows — the total value of output increases — meaning that wages rise and new jobs are created.

These effects are far-reaching. In the monetary area they influence the price of the rand, liquidity, money supply, interest rates and almost every other price in the economy. On the fiscal side, they swell gov-

ernment revenues. A \$10 swing in the gold price translates over a year into R200m in gold mine profits, according to the well-known equation. Government revenue influences government expenditure, and the size and financing of its deficit before borrowing.

In these ways a rising gold price increases total production, investment and income. Contrariwise, a decline in the gold price has exactly the opposite effect, causing in the same way, investment, output and income to decline.

Of course, these are implications that arise over a period of time from a trend in the gold price. More immediately, gold price fluctuations play an important psychological role. When it briefly tested the underside of \$300/oz last week, public reaction was swift. There was a pervasive gloom.

This is because a high gold price is associated, not always correctly, with general prosperity. Sometimes a high gold price re-

sults from high rates of inflation and low or negative real interest rates in the economies of SA's main trading partners. In other words, once the annual rate of price increases was deducted from interest rates, investors were left with little or no return. So investment in productive assets lagged behind demand, which became progressively more excessive, fuelled by governments' printing more money. This, in turn, created strong demand for a whole range of SA's mineral exports. Trouble is that it was not sustained.

It could be that a relatively low gold price, and less inflation in the West, actually brings over time greater prosperity to the West in general, and SA in particular. However, the immediate psychological response of investors to a declining gold price is inevitably based more on emotion than reasoned analysis. Therefore, falls in the price of gold tend to heighten immediately the erosion of business confidence.

Nevertheless, as Standard Bank economist Andre Hamersma points out, the gold price is not an isolated one. When it does fall, we do see a deterioration in our ability to pay our way whatever the longer-term implications for world stability and growth may be, although to some degree this can be cushioned by devaluing the currency.

Few analysts of the gold market believe that the slide in its price can last much longer. The fundamental demand and supply position, they argue, is virtually in balance. And the speculative forces that affect the price run in tandem with the state of the dollar in general, and the level of real interest rates in the US in particular. It is claimed, perhaps with a touch of self-interest, that these cannot remain very high much longer.

## THE GOLD FACTOR

### Measuring the response to gold at different prices

	1982	1983	1982	1983
Average gold price (\$/oz) .....	295	250	363	391
Trade balance (R billion) .....	-6	-6,5	-4,4	-3,6
Real domestic exp (%) .....	-1,6	-3,3	-1,5	-2,2
Real exports (%) .....	-1,1	+3,5	-0,4	+2,2
Real imports (%) .....	-12,5	-7,1	-12,3	-5
* Exchange rate (USc/Rand) .. ...	82	74	85	80
Consumer price index (%) .....	15	13,2	14,9	12,8
* Prime overdraft rate (%) .....	20	18,4	18,6	16,2
* Long-term Escom rate (%) .....	15,5	14	15,3	13,1
<b>Real gross domestic product (%).....</b>	<b>+0,8</b>	<b>-1,4</b>	<b>+1</b>	<b>-1</b>

\* Level in fourth quarter  
Source: Santambank

ARGG's 21/7/82

79

# R1 400-million jump in SA shares

SHARE prices rose by almost R1 400-million in the first two hours of trading on the Johannesburg Stock Exchange today following a seven-dollar rise in the gold price to above 360 dollars an ounce for the first time since mid-April.

Gold and mining financial shares were heavily traded, but the rally later spread to metals and mineral shares and to the industrial counters.

In the initial burst of trading some mining counters had price-gains of 10 percent or

more. Shares in the marginal mine ERPM jumped 100c to 875c, while the shares of the gold-mining holding company Middle Wits rose 120c to 950c.

Anglo American shares were heavily bought and rose 75c to 1 230c. Harmony's shares increased by 75c to 1 075c and Loraine's by 30c to 285c.

Other shares to show substantial gains in-

cluded Free State Gold, Western Holdings, St Helena, Buffelsfontein, SA Lands, Village, Randfontein, Grootvlei and Egoli.

By the middle of the morning the value of gold shares had risen around R600-million, mining financial shares by probably a similar amount and industrial shares by around R150-million.

The rally on the share

market has been gathering momentum since the beginning of the month, after the gold price began recovering from its 2½-year low of 296 dollars an ounce reached a month ago.

Although the recovery was slow at first, it has gathered momentum since the Iranian attack on Iraq and the emergence of signs that

American interest rates were starting to ease.

As a result of these favourable developments, the value of shares on the JSE has risen by around R6,7-billion since the beginning of July and are now worth about R54-billion.

This compares with a figure of R55,6-billion at the end of March and R71,6-billion last December.

# Gold's perennial <sup>(79)</sup> buying power <sup>star</sup> 27/7/32

ZURICH — Paid for in gold a sack of wheat costs about the same now as it did more than 3½ centuries ago, according to calculations by a Swiss bank.

Quoting historical documents from the early 17th century, Credit Suisse said in its latest monthly bulletin that a bushel of wheat which cost 0,38 g of gold in 1621 was equivalent to 0,324 g of the metal today.

"So over these 360 desolate and bloody years gold has not only maintained its real value but even increased in buying power," said Credit Suisse economist Mr Hans Mast.

"Compared to gold, all other commodities used as money — shells, cattle, stones or even silver — disappear from the picture." — Reuter.

# Gold shares boom up to 15 pc on JSE

AKGUS 20/8/82 ~~79~~ 79

By the Finance Editor

GOLD shares boomed on the Johannesburg Stock Exchange today, adding about R1 000-million in value in early trading following the news that the gold price had jumped more than 20 dollars in New York last night.

The shares of some of the marginal gold mines rose 15 percent or more in price. The average share price increase was just under 6 percent.

The jump in the gold price was caused by mounting concern in the United States about the health of the American banking system.

The flight into gold in the United States last night was triggered by rumours — which have been denied — that the Manufacturers Hanover, one of

the United States' biggest banks, was in financial difficulties because of its loans to Mexico.

Last weekend the Mexican Government ordered a temporary halt to all foreign payments to stem the flight of dollars abroad which has threatened to exhaust its foreign exchange reserves.

The gold price closed in New York at 373 dollars an ounce.

Today, in spite of the Manufacturers Hanover's denials, it rose to 383 dollars in Zurich before falling back to 379 dollars an ounce in London.

Mexico is one of the Western Hemisphere's richest oil countries, but has been hit hard by the recent slump in oil consumption. Its foreign debts

are estimated at 80-billion dollars (about R91-billion) of which about 17-billion dollars (R19,8-billion) are short-terms and due for repayment.

Many American banks have lent heavily to third-world countries. The economies of these countries have been seriously hit by the world recession and slump in raw material prices and there are grave fears about the financial health of these banks.

A continuation of the present gold price would greatly improve South Africa's economic prospects. It would increase the country's foreign earnings and ease its balance of payments problems. This in turn could open the way for the Government to embark on a more expansionary economic policy.

# GOLD HITS PEAK ABOVE 400 DOLLARS

APR 24/8/82  
79

Finance Editor

**FIERCE** demand for gold in London today pushed up the price of the metal at the morning fixing by more than 10 dollars an ounce to a nine months' peak of 411.50 dollars an ounce.

In the past 24 hours the gold price has risen more than 30 dollars an ounce and by more than 70 dollars an ounce in the past week.

The upsurge in the demand for gold has been triggered by falling American interest rates. This has led many investors and speculators to believe that the United States will soon start pulling out of its present recession. This in turn is expected to result in an improvement in economic conditions in other countries.

Already the lower US interest rates have led to a increased demand for crude oil and to a firming in

the spot oil price. Prices of other commodities have also started rising.

On the Johannesburg Stock Exchange today gold shares continued to rise in heavy trading, though many shares were subjected to heavy profit-taking.

Since Friday the value of shares listed on the Johannesburg Stock Exchange has risen by more than R800-million and in the past week by more than R5 000-million.

The increase in the gold price is good news for the gold mines. It means the local gold price is now above R460 an ounce — its highest price since the end of 1980.

A continuation of gold's recent price gain would boost the gold mines' earnings by around R170-million a month and South Africa's foreign earnings by about 160-million dollars a month.

# GOLD TOPS \$5000 BUT CRISIS LOOMS

ARCUS  
7/19/82  
79

## Financial Editor

THE gold price soared again in the world bullion markets today, jumping almost \$20 in 30 minutes trading in Hong Kong to break through the \$500 an ounce barrier for the first time since April 1981.

The metal later ran into resistance and fell back to hover around \$490 an ounce in the major bullion markets at midday.

The Johannesburg Stock Exchange was firm and active with prices rising just over R1 000-million by noon.

The gold price has risen almost \$100 since last Tuesday and is now more than \$200 above the year's low of \$296, reached at the end of June.

The steep rise in the gold price is the result of an extremely strong demand triggered by:

- Mounting concern about the fate of the world's banking system.
- The reduction in American rates and hopes for a recovery in the American economy, and

● The covering of "short positions" by speculators who had gambled on the gold price falling to \$250 an ounce.

## Tightlipped

Although Government officials all over the world are tightlipped about the banking crisis for fear of aggravating the situation, the position for many major banks overseas must be becoming extremely serious.

It is estimated that they are owed almost \$500 000-million by developing and Third World countries which, because of the world recession, are finding it difficult

to meet their interest payments.

The banks have already had to "reschedule" (a euphemism for easier terms) Poland's debts and are now faced with having to do the same for Mexico and possibly the Argentine.

## In jeopardy

As a result, a substantial part of their investment income and capital repayments could be in jeopardy — which means they may have serious problems in meeting commitments to their own depositors.

Because of this it is be-

lieved that many companies and private individuals are diverting their surplus cash to share investment and to gold.

Helping this process has been the drop in American interest rates, which should boost economic prospects there and make gold cheaper to hold.

The upsurge in the gold price, however, has caught many speculators by surprise and they are being forced to buy heavily in the bullion markets — which also appears to

(Turn to Page 3)



# Gold

(Contd from Page 179)

be pushing up the gold price.

The surge in the gold price, with the 35-percent devaluation of the rand against the dollar since 1980, means that the South African gold mining industry is now receiving almost a record price for its output.

Today's Hong Kong price is the equivalent of R571 an ounce. The last time the gold mines received this much for its production was early in 1980 — when a dollar was worth R1,35 and the gold price momentarily exceeded \$750 an ounce.

Windfall from <sup>79</sup> Star 2/9/82

# Drop of rand against dollar

By Mervyn Harris  
Gold mines will receive a bonanza of R574 an ounce at a bullion price of 500 dollars — R123 more than they received when bullion was at 600 dollars.

This windfall for gold producers is because of the fall in the value of the rand against the dollar for a high of 1,35 dollars two years ago to the present rate of slightly under 88 US cents.

### FIRMED

The bullion reached a peak of 850 dollars at the London afternoon fixing on January 21 1980, the exchange rate of 1,221 dollars to the rand meant that gold mines received R696. Six months later, in June 1980, when gold

averaged 600 dollars, the rand had firmed to 1,2980 dollars, reducing the revenue to producers to R462.

### BENEFITS

When gold soared to 500 dollars on European markets yesterday, the rand was worth slightly under 88 US cents, pushing up the revenue in rand terms for gold producers to R572.

The benefits for gold producers will be seen in their cash flows which will spill into higher tax revenues for the State and thus help reduce the budget deficit.

### CONTRAST

A bullion price of 500 dollars also means that all gold mines would operate profitably. This is in sharp contrast to the position 10 weeks ago when bullion plunged below 300

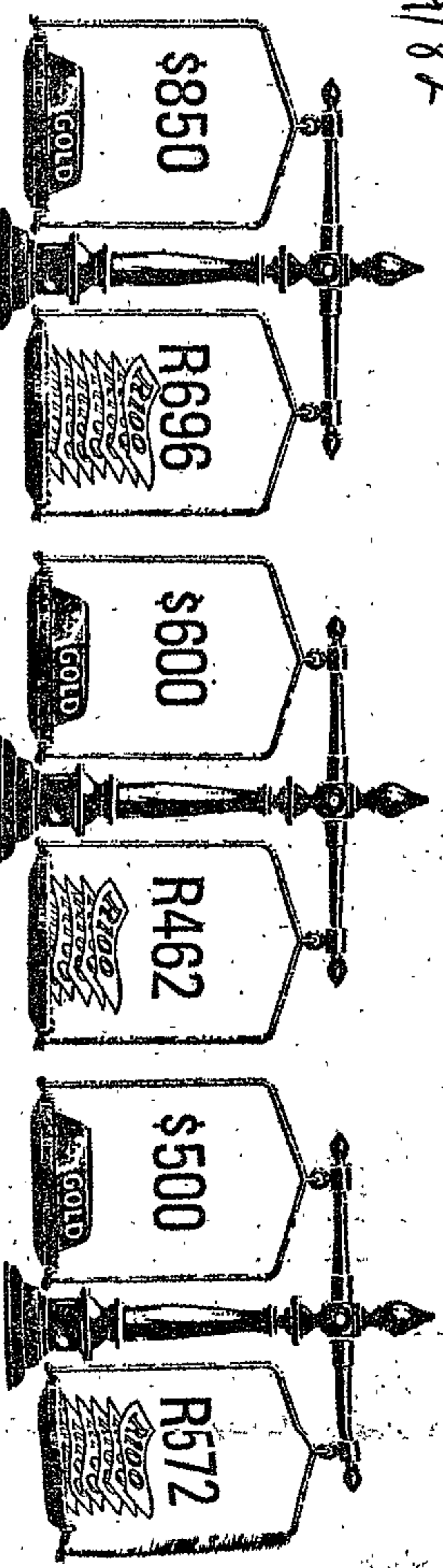

A set of scales shows at a glance the benefits of the weakening rand on currency markets when estimating South Africa's income from world gold sales. It shows that a gold price of 500 dollars today is worth even more in rand terms than when gold was at 600 dollars in 1980 because of changes in the rand-dollar exchange rate.

### JUSTIFIED

This meant that a low tonnage, high-capital mine like Cons Modder, which originally justified its capital expenditure at a bullion price of 800 dollars or R16 000 a kilogram would now receive more than R18 000 a kilogram at a price of 500 dollars. Cons Modder would therefore show a cash surplus, Mr Heever said.

**Financial Editor**

THE price of gold surged temporarily to a new 18-month high of \$512 an ounce in Hong Kong today before falling back to \$490.50 in what dealers described as highly nervous trading.

The new increase in price followed a \$21 jump in New York last night after rumours, later denied, that a West German bank was in difficulties and that Bolivia had defaulted on its foreign debts.

**CONCERN**

Dealers in New York said the rumour of a bank failure could have been caused by the misreading of a report that a West German oil company, Deutsche BP, had a loss of about R200-million on refining operations in the first half of this year. The name of this company is similar to that of a leading German bank.

Reports that Bolivia had defaulted were denied by a Bank of Amer-

# Gold price soars to new high of \$512

AR665  
9/9/82

79

ica spokesman, who said the country was up to date on all its payments of interest and principal.

However, in spite of the denials, the gold market remained firm, suggesting there was mounting concern about the health of the Western world's banking system.

The situation has not been helped by the news that the United States wants the International Monetary Fund (IMF) to create an emergency fund to handle financial crises like the one in Mexico.

An American Treasury spokesman said last night that while the United States was willing to bolster the resources of the IMF by early next year, it also wanted the emergency fund, reports Sapa-Reuter.

**ARGENTINE**

Meanwhile, talks were continuing yesterday between the Argentine and the IMF on a standby credit to enable the country to reschedule part of

(Turn to Page 3)

## Gold up

AR665 9/9/82 79  
(From Page 1)

its \$27-billion external debt.

Western central bankers fear that the military regime in Buenos Aires may refuse to recognise the need for a rescheduling package including tough conditions before it is too late. This could have severe repercussions for the world banking system.

The Argentine does not have as much short-term debt as Mexico, but it was \$2.3-billion in arrears with interest payments at the end of June and faces a \$12.7-billion interest bill in the second half of this year.

**'DEBACLE'**

In Toronto last night the South African Minister of Finance, Mr Owen Horwood, predicted that the price of gold would continue to rise during the next four to eight months.

He told reporters the recent rise in gold prices had been partly due to what he called the "Mexican debacle" and to the fear that Mexico's economic crisis would spill over to other countries.

Mr Horwood said the drop in interest rates in the United States made gold a more attractive investment, but added that the Mexican crisis was the "final straw".

# Gold once a hedge — now a refuge

Shes 14/9/82

From the Financial Times

**LONDON** — The only certain thing about the gold market, say the experts, is that it is unpredictable. Its behaviour in the past three months seems bent on proving just how paradoxical a market it can be.

When the price of gold slid below 300 dollars on June 21, there was no difficulty in finding gloomy followers of bullion who talked of the metal trading its way down to 250 dollars or below.

## BULLETIN

"In April," warned one analyst's quarterly bulletin, "300 dollars looked like the bottom. We are not so sure now."

By last Tuesday, however, gold was briefly dealt at slightly more than 500 dollars and the London market's morning fix was higher — at 488.50 dollars — than at any time since May, 1981. The price had climbed almost 100 dollars in the previous week.

If the gold market is unpredictable, it is also exceptionally hard to rationalise with hindsight. That is in part because the important deals are done behind closed doors, partly because so many interlocking influences act upon the unstable balance of supply and demand.

## GROWING FEAR

There is thus no single reason why the gold price is now racing back and forth between 450 and 500 dollars when a month ago it was circling around 340 dollars.

Any explanations must, of course, focus first on the growing fear, since Mexico's financial crisis, of a full-blown international banking collapse. With the financial system under such pressure gold has been transformed from a hedge into a refuge. However, the price had started to climb before Mexico, and that movement surely had more humble origins — falling interest rates on

both sides of the Atlantic were daily reducing the cost of financing gold stocks.

It seems, too, that — apart from easing their financial controls — central banks had played a direct part in reversing the two-year bear market in gold.

Back in June, 300 dollars had been regarded by many speculators as a "support level" for the gold price. If it fell below that, there was no knowing how far it might go. On the other hand, it was a point at which the metal had become historically so cheap that fresh buyers might be expected to enter the market.

## CENTRAL BANKS

It appears that the necessary buying — not in particularly large quantities — came mainly from some European central banks, clearly concerned to limit the embarrassing erosion of their gold reserves.

A further motive could have been to

preserve commercial banks' loans to South Africa. Many of these are backed by gold which is offered as collateral by Pretoria.

Once the fall had been reversed, these central bankers were able quietly to leak their excess holdings back on to the market and leave the scene (with a profit).

The market had been tripped into an upward tack, which it would have to pursue almost involuntarily.

The very steep rise in the gold price after August 13 was certainly inspired by news from Mexico.

## BIG DRAIN

It is possible that the atmosphere of banking crisis — to which Friday's reports of a Bolivian "default" can only add — will lead to a sustained rise in the gold price.

Whether it does so will depend on whether the extra demand for "precautionary" gold can be met from stock, which would have to come mainly from holdings of the mining countries, principally South Africa and Russia.

The Russians are said to have exercised considerable restraint in recent weeks, though their grain buys created a big drain on foreign exchange which will

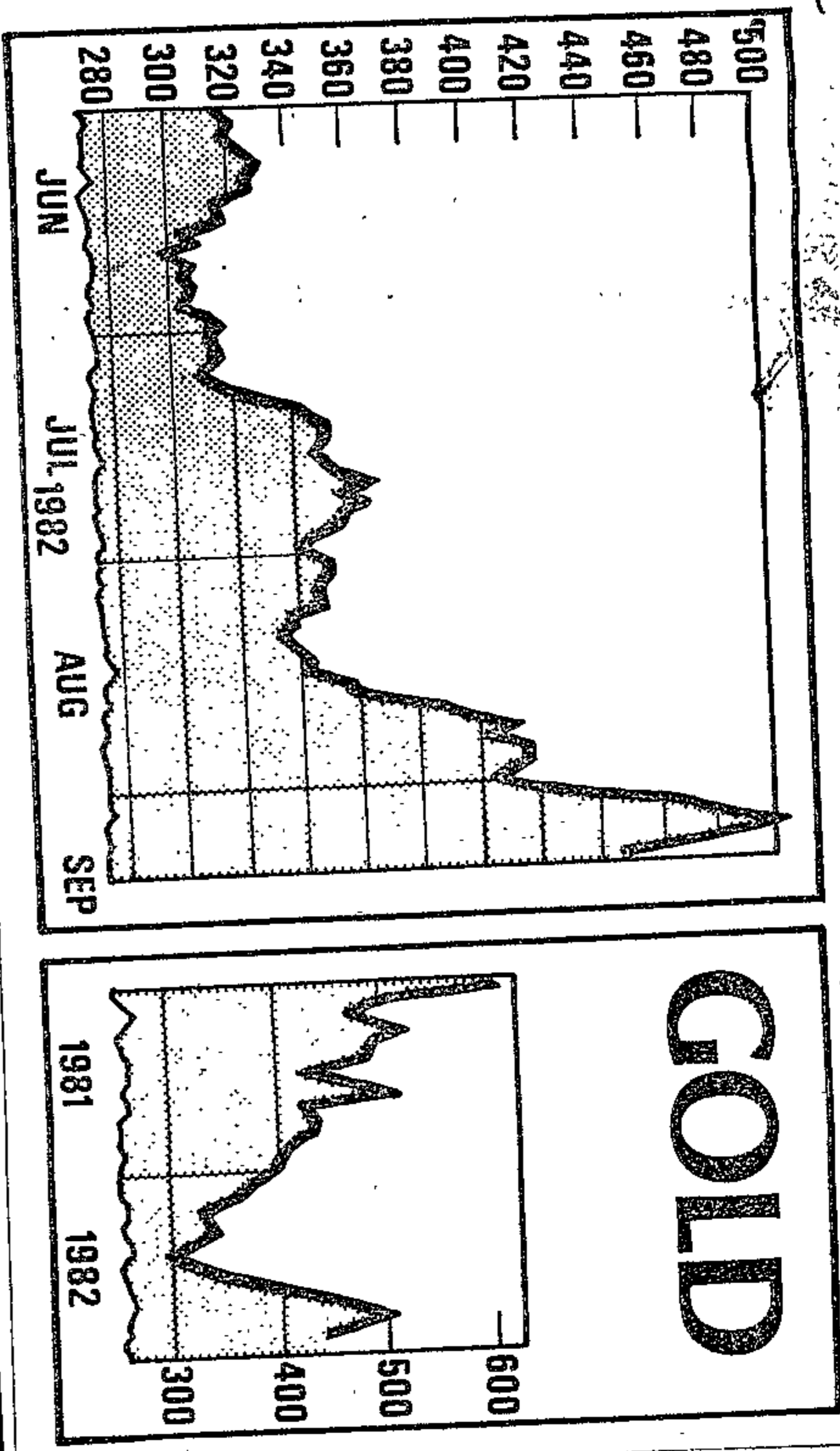

**Gold jewellery buying now open**

PEKING. — For the first time in almost 30 years, Chinese citizens who can afford it will be able to buy gold jewellery and ornaments. The Bank of China has announced that China would resume state sale of gold ornaments on the domestic market in late September. The sale of gold ornaments on China's domestic market was halted soon after the communist victory in 1949. Since then articles have been sold only to foreigners.

**UK party alliance rates low**

LONDON. — Britain's year-old Liberal-Social Democratic alliance has sunk to an all-time low in its standing with voters, according to an opinion poll published in London yesterday. The survey by the MORI polling organisation, taken for a television programme, found that only 14% of voters would back the Liberals and their Social Democratic Party allies if a general election were held now.

**Cargo spacecraft has docked**

MOSCOW. — An unmanned Soviet cargo spacecraft carrying supplies and equipment for cosmonauts Anatoly Berezovoy and Valentin Lebedev, docked yesterday with the orbiting space station Salyut T7, Tass reported. The cargo ship, Progress 15, was launched on Saturday. Tass said the two cosmonauts controlled the docking which was carried out "on commands from its mission control".

**Spanish plane crash toll now 52**

MADRID. — The toll from the crash of a Spanish chartered DC-10 last Monday has increased to 52 with the death of an American who was seriously injured. The Civil Governor's Office and hospital sources in Malaga said Ms

SOUTH Africa may soon have to make yet another gold swap deal and/or borrow substantially long-term overseas, presumably from the International Monetary Fund.

One or both of those courses seems inevitable unless there is a swift and improbably large improvement in the overall balance of payments position.

The "cash content" of the country's official gold and foreign exchange reserves slumped below any conventional safety margin last month.

The total gross reserves at the end of August were R3 600-million.

Of that amount, however, only R346-million was in some form of foreign exchange asset. The rest was in gold, subject to widely fluctuating market valuations.

Considering that the foreign exchange holdings plunged by over R500-million in August, alone their vulnerability is obvious.

In any case the total level of the gross reserves is also on the low side at present.

Rule-of-thumb economic wisdom says that the level should at least equal the cost of three months imports.

In the first quarter of this year South Africa's overall imports were officially valued by the Reserve Bank at R4 764-million.

So at R3 600-million on August 31 the reserves were patently under-strength — and they still would be even if the value

# Gold swap or IMF loan on the cards for SA

of the gold content increased by, say, 30%.

Another gold swap deal — there have been three already in the past year — would not increase the total value of the reserves.

It would, however, reduce the gold content and increase the foreign exchange holdings.

That would ease the "cash" problem in the reserves and would avoid the risk of having to sell some of the country's official gold stock on the market with the danger that such action could depress the gold price.

But if it is felt necessary to increase the total amount of the reserves on an on-going basis this would require medium or long-term borrowing.

South Africa could get up to about R1 000-million from the IMF without any special difficulty.

The possible need for this kind of credit facility is perhaps best seen by looking at the net reserves position — that is, the gross reserves minus the short-term foreign liabilities of the whole banking sector, including the Reserve Bank.

According to the Reserve Bank Quarterly Bulletin those liabilities were R4 286-million at the end of March this year — or more than the current amount of the gross reserves.

In the light of that situation the slump in the gross reserves in August looks even more ominous.

**Howard Preece**

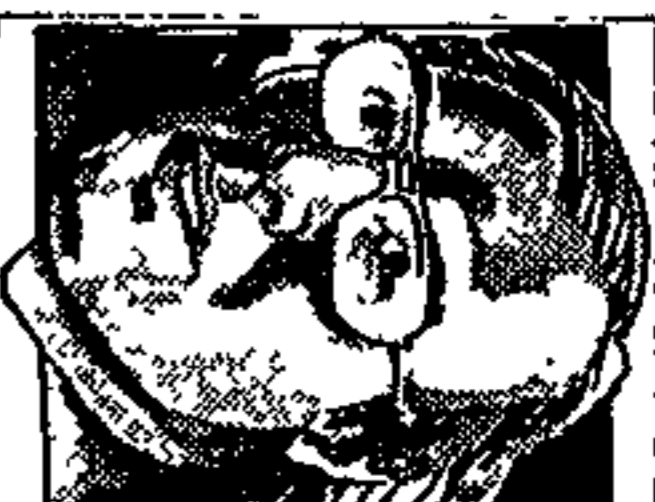

**Economic Spotlight**

Of course, there were almost certainly some special factors that adversely affected last month's figures.

It is also clear that the reserves must have been significantly boosted in September by some hefty short-term overseas borrowings by the commercial banks which were facing acute liquidity problems until the Reserve Bank eased their supplementary liquid asset requirements this week.

But the reserves cannot be left to rely on some sort of hand to mouth basis. Nor is the recent highly welcome but still unpredictable

upturn in the gold price anything like sufficient to take care of the problem.

The general issue was put in perspective last week by Dr C J de Swardt, head of the economics department of the Reserve Bank.

He told the Pretoria Chamber of Commerce: "Notwithstanding the recent recovery in the gold price the current account of the balance of payments will continue to show a large deficit in 1982."

"In 1981 the current account deficit amounted to almost R4 000-million and it is likely to be of the same order or slightly higher in 1982, provided that the gold price does not fall back significantly during the rest of the year."

"Even after assuming an appreciably higher gold price in 1983 than in 1982 the current account will probably still show a deficit for 1983 as a whole."

No wonder the reserves are still under pressure in spite of the fact that they were run down by R800-million between January 1981 and June 1982 and over R4 000-million of various foreign credits were also specially mobilised to support them. The extent of the pressures can be seen by looking at July and August this year.

According to the preliminary figures from Customs and Excise South Africa actually showed a huge R299-million surplus on the balance of trade in July.

Customs data can be misleading at times but even allowing for some margin of error, there must at least have been a very large trade surplus that month.

But the deficit on "invisibles" — shipping, insurance, dividends etc — could easily have been R300-million or more. Overall the total arithmetic on the current account of the balance of payments suggests the figures could still have been in the red in spite of the huge trade surplus.

The reserves figures seem to support this. There was a gold swap deal in July in which about 1 350 000 ounces of the official gold holding were effectively pawned, reducing the holding from just over 9-million ounces to less than 7 700 000 oz.

That ought to have pushed up the foreign exchange side of the reserves by around R450-million. In fact, they rose by little more than R300-million. It may be, however, that the July figures were particularly hit by interest payments on the foreign debt.

But what about the R500-million drop in the foreign exchange content of the reserves in August?

Part of the explanation has to be the continuing deficit on the current account of the balance of payments.

The commercial banks cannot be relied on to keep bringing in net new short-term borrowings from overseas (that is, after including roll-overs of previous credits and allowing for some repayments of outstanding debts).

The reserves — net or gross — are surely going to need some more formal assistance in the near future. There may also have to be assistance for the cash content of the reserves.

# Frenzy on JSE as gold price jumps

ARGUS

8/10/82

79

Argus Correspondent

JOHANNESBURG. — Stockbroker switchboards here jammed today as investors went into a frenzy with orders to buy gold shares.

The latest gold rush has been triggered by another drop in US interest rates which sent the dollar crashing against other currencies and the gold price soaring by more than forty dollars in three days.

In London today gold was fixed at \$438 — an increase of \$19.50 since yesterday afternoon's fixing.

Investors flooded Wall Street with buying orders yesterday as most major banks cut their basic lending rate amid signs that the US Central Bank might be easing its tight monetary policies to allow interest rates to decline.

### Biggest rise

The Dow Jones industrial average, which gained more than 37 points on Wednesday in the second biggest rise in its history, rose another 20 points yesterday to its highest level in more

South African gold shares led the advance on the London Stock Market. The market average of leading shares gained 8,5 points to 591, not far below the previous record high of 597,3 reached last year.

Stock markets in Sydney, Melbourne, Singapore, Hong Kong and Tokyo also recorded gains.

**Heavy trading**

In Johannesburg gold shares rose to the highest levels of the year in heavy trading.

Mr Paul Ferguson, the president of the JSE, said he expected today to be a "bigger than normal day".

"It is amazing how much the gold price is rising. The gold share market is reflecting this higher price and is anticipating that it will go even higher."

Stockbrokers said their boards were jammed an hour before trading started as investors rushed to buy gold.

(1/11)

It is cool  
 autumn  
 on the left  
 beside  
 some times  
 learning  
 stable  
 eyes  
 bucket  
 broom

1 It is raining  
 2 The wind blows  
 3 warm (clothes)  
 4 This side of  
 5 In the river  
 6 He (rich man)  
 7 hat  
 8 speed  
 9 nose pipe  
 10 family  
 11 indigo  
 12 unorganized  
 13 vegetable  
 14 sandals  
 15 ngokuhle  
 16 people  
 17 lion  
 18 whose (shirt)  
 19 whose is (father)  
 20 admire

It is not  
 (the sun) scorches  
 on the right  
 in front of  
 because  
 There (at Alice)  
 know  
 now  
 beer  
 north  
 indigo  
 vegetable  
 sandals  
 ngokuhle  
 people  
 lion  
 whose (shirt)  
 whose is (father)  
 admire

Translate the following:



Sept 11/10/82

# Soviets offload gold

From The Times  
WASHINGTON —  
The Soviet Union has sold a large quantity of gold in the last few weeks to raise hard currency for an expected record level of grain imports.

The grain is needed to offset last year's poor crop. If this year's crop is poor, as seems likely, it will be the fifth successive bad harvest.

The gold sales reflect a growing weakness in the Soviet economy, hit by declining oil revenues and an increasing need for imports from the West, including equipment to complete the Siberian gas pipe-

line, Western analysts say.

The Russians have also seized on the recent upswing in gold prices. They have sought in recent weeks to lower their dependence on grain supplies from the United States by trying to negotiate long-term agreements with France and Argentina, the analysts say.

These are the main conclusions of a survey of US officials and private forecasters conducted by the Times of London to assess the impact of the increased grain purchases on the Soviet economy.

Generally the

analysts agree that the outlook for the Soviet economy is not as all good this year. It is likely to include a record trade deficit with non-socialist countries of close to R5 110 million and a current-account deficit approaching R9 090 million.

There is, however, a lack of agreement on the implications of the economic downturn which may force the Russians to accelerate their gold sales.

The US National Security Council has just completed a study which suggests that the Soviet economy could follow the Polish pattern.

## ...and Krugerrand slips

The high level of consumer sales back to the market continued to have a detrimental effect on the sale of Krugerrands during September, when a total of only 20 198 ounces was sold, says Intergold.

The rapid rise in the gold price, from 404 dollars on September 1 to more than 500 dollars six days later, encouraged mass dishoarding as speculators realised profits from the sudden upsurge.

Many long-term investors perceived an opportunity to divest themselves of their gold.

Sales back to the market were parti-

cularly noticeable in Europe, where the downward realignment of local currencies against the dollar triggered many investors to withdraw from the market to await a more opportune time to reinvest.

Krugerrand demand at retail level, however, continued to increase in the United States, so much so that this important market absorbed the bulk of the excess stock coming out of Europe and the Far East.

The Reserve Bank has reported that its total gold and foreign assets increased by

R386 386 396 and stood at R3 986 657 223 on September 30.

According to the bank's monthly statement, gold holdings increased by R43 941 428 to R3 297 308 881 at the end of September. Gold reserves have been valued at R429,11 a fine ounce, compared with a valuation price of R426,33 a fine ounce at August 31.

Foreign bills decreased from R46 135 228 to R32 180 914 at the end of September. Foreign investments increased from R43 326 699 to R43 547 551.—Sapa.

# Minerals Bureau sees \$450

79

## 21% rise in gold earnings in 1983

By JOHN MULCAHY

AT \$450 an ounce and a rand exchange rate of \$0,95, South Africa's revenue from gold is expected to reach R10 203-million next year — 21,5% higher than the R8 400-million projected for this year.

The Minerals Bureau of the Department of Mineral and Energy Affairs says in a comprehensive forecast of mineral earnings for this year and 1983 that the embryo of recovery should emerge next year, enabling the mining industry to at least maintain earnings in rand terms.

Although the gold price is believed to have moved into a cycle in which it will rise to levels well above the \$850 peak reached in 1980, the bureau forecasts a modest increase for the rest of this year and for 1983, with an average price of \$370 and \$450 an ounce respectively for the two years.

To arrive at an average price of \$370 this year an average of \$416 an ounce for the last four months is required.

Total mineral sales this year are estimated at R13 685-million, or 0,5% lower than last year's R13 748-million. When Bophuthats-

wana is included this year's estimate rises to R14 577-million from R14 515-million last year.

Gold and non-gold export earnings for this year are forecast at R11 605-million compared with R11 655-million in 1981. The bureau predicts a 19,8% increase in total exports to R13 900-million next year, and an increase in revenue of 20% to R16 392-million.

Earnings from gold this year are expected to total R8 400-million, which is only 1,8% lower than last year in spite of a 15,2% drop in the average dollar price of gold.

Export earnings from coal are expected to top a billion rands for the first time this year. In spite of a projected 6,3% drop in tonnage, the value of exports is expected to rise 20,4% to R1 176-million.

For next year, coal export tonnage is expected to rise to 32-million tons from 28-million tons this year, and earnings from this source are expected to rise 14,3% to R1 344-million.

In comparative terms, the non-gold sector has this year outperformed gold, showing an increase of 3,4% over last year with sales forecast at R3 205-million.

"The 1982 spin-off which resulted from the declining rand is unlikely to recur and a small rise in the rand-dollar exchange rate is expected from \$0,935 to \$0,95. A lower inflation rate of 13% should assist in curbing costs."

Describing the rand depreciation over the past year as "the most important single factor that staved off a disaster for the industry" the bureau notes that in spite of reduced export tonnages and generally constant dollar prices, increased rand earnings have enabled the mining industry to remain profitable.

With about 85% of SA's mineral production destined for export, fortunes of the mining industry are inherently linked to the economic prosperity with SA's trading partners.

For the forecast, the bureau assumes that a modest increase in demand for ferrous and non-ferrous metals and industrial minerals will become apparent during 1983, a trend that will be supported by small but significant increases in consumption "but primarily by the rebuilding of severely depleted industry inventories made feasible by reduced interest rates".

"A strong possibility exists that 1984 will mark a period of sustained growth and renewed prosperity in the industrialised countries of the West in which South Africa's mining industry is well equipped to share.

"Overseas consumers are only too aware of the effect of a buyer's market on both prices and availability and many are expected to buy ahead of an anticipated upsurge."

The bureau says gold is now assumed to have started the fourth of its upward phases since it was freed from an official price structure in 1968.

This phase in the gold market is expected to gather momentum cautiously through the rest of this year and 1983, but with increasing impetus after that.

Although the SA economy is expected to decline before a recovery takes place, the bureau says this recovery, as was the case after the downturn of the late 1970s, will be led by the mining sector responding to improved foreign economic trends.

The falling trend in the average recovery grade of South African gold mines over the past decade seems to have changed to a gentle upward trend in response to the decrease in the gold price.

In the first quarter of this year the industry recorded an average grade of 6,65 g/t, which rose to 6,79 g/t in the June quarter, and is expected to continue rising into 1983.

Expansion in the milling capacity of some mines has been completed, and this has combined with the commissioning of Beisa mine to increase the industry's overall milling rate, another trend the bureau expects to continue next year.

"Taking these factors into account it is estimated that 660 tons of gold will be produced in 1982 — a marginal increase of 0,7% over the 1981 level — and rising to 670 tons in 1983."

For the  
Connoisseur's  
Cabinet



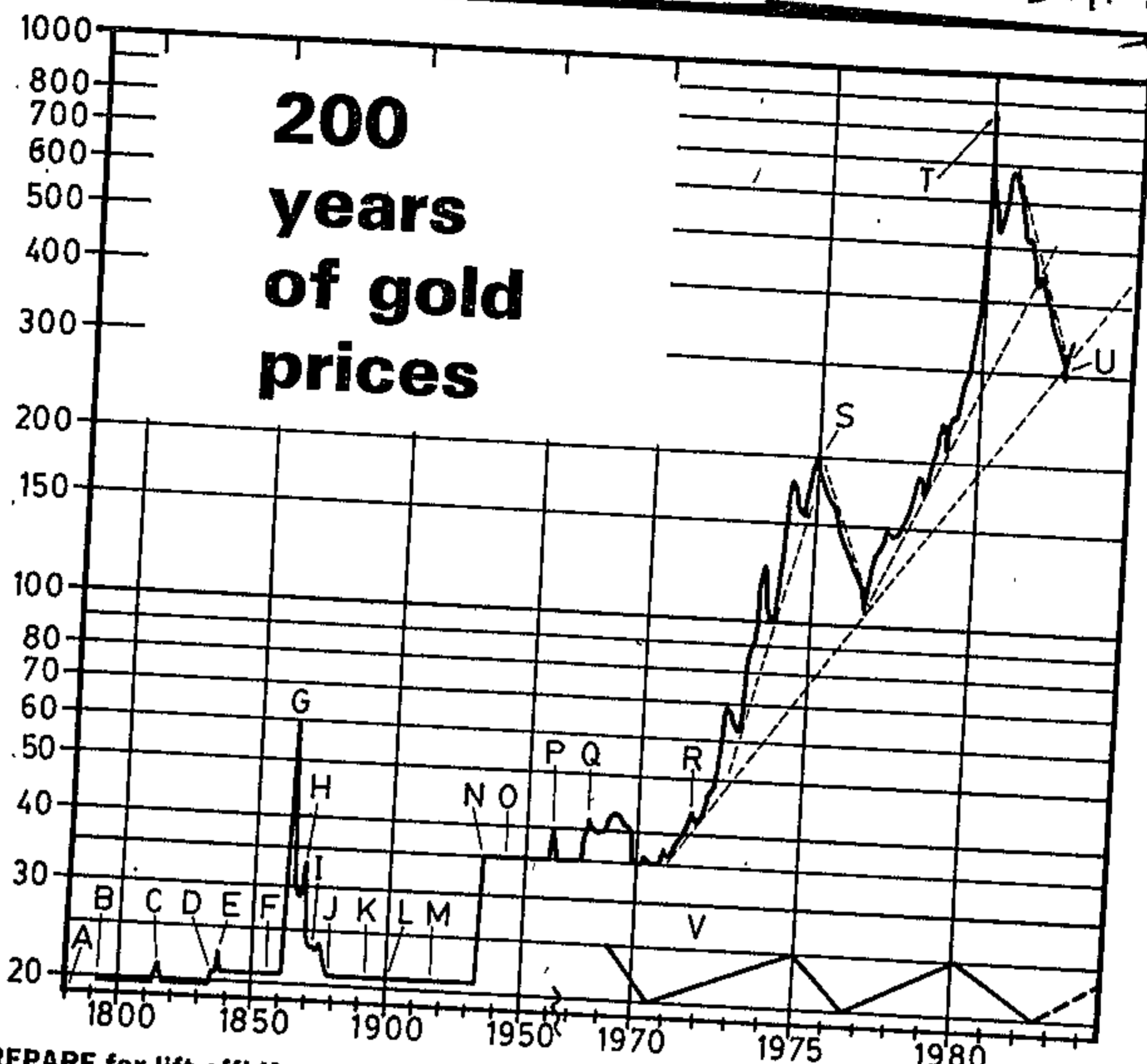

PREPARE for lift-off! If you place your faith in charts of the kind prepared here by the US Gold Newsletter, the gold price appears set for a lift-off. Those who regard the art of the chartist as not very far removed from the prophecies contained in knucklebones might take a rather dimmer view of the graph reproduced above. Whatever your persuasion the legend attached to the graph provides an interesting historical overview of the gold price:

- A = 1781 \$1 Gold money = \$400-\$1 000 paper money of \$19 an ounce.
- B = February, 1792: Bimetallic standard adopted, gold fixed at \$1 939.
- C = War of 1812. August, 1814, specie payments suspended. February, 1817: Specie payments resumed.
- D = June, 1834: Gold fixed at \$20,67 an ounce.
- E = Panic of 1837 (October, 1837): specie payments suspended. October, 1838, specie payments resumed.
- F = Panic of 1857 (September, 1857): specie payments suspended. December, 1857, specie payments resumed.
- G = Civil War breaks out December, 1861: specie payments suspended.
- H = September 24, 1869 "Black Friday".
- I = Panic of 1873 (February, 1873): US on gold standard (de facto).
- J = January, 1879: Specie payments resumed.
- K = Panic of 1893.
- L = March, 1900: US on gold standard (de jure).
- M = First World War: free export of gold prohibited September 1917 to June 1918.
- N = September, 1933: US citizens prohibited from owning gold. January, 1934: Gold fixed at \$35 an ounce.
- O = Second World War.
- P = November, 1961, London gold pool established.
- Q = March, 1968: London gold pool dissolved — "two-tier" market established. US off the gold standard (de facto).
- R = August, 1971: US off gold standard (de jure).
- S = January, 1975: US citizens permitted to own gold.
- T = January, 1980: High of \$850 an ounce.
- U = Low of \$296,75 an ounce, July, 1982 (washout bottom).
- V = Five-year 5 Mos-Gold Price Cycle March 1969 to January 21, 1980.

Source: Gold Newsletter, 4425 West Napoleon Avenue, Metairie, Los Angeles 70001, US.

Wkd - Rush 30/10/82

### SA Gold Production Metric Tons

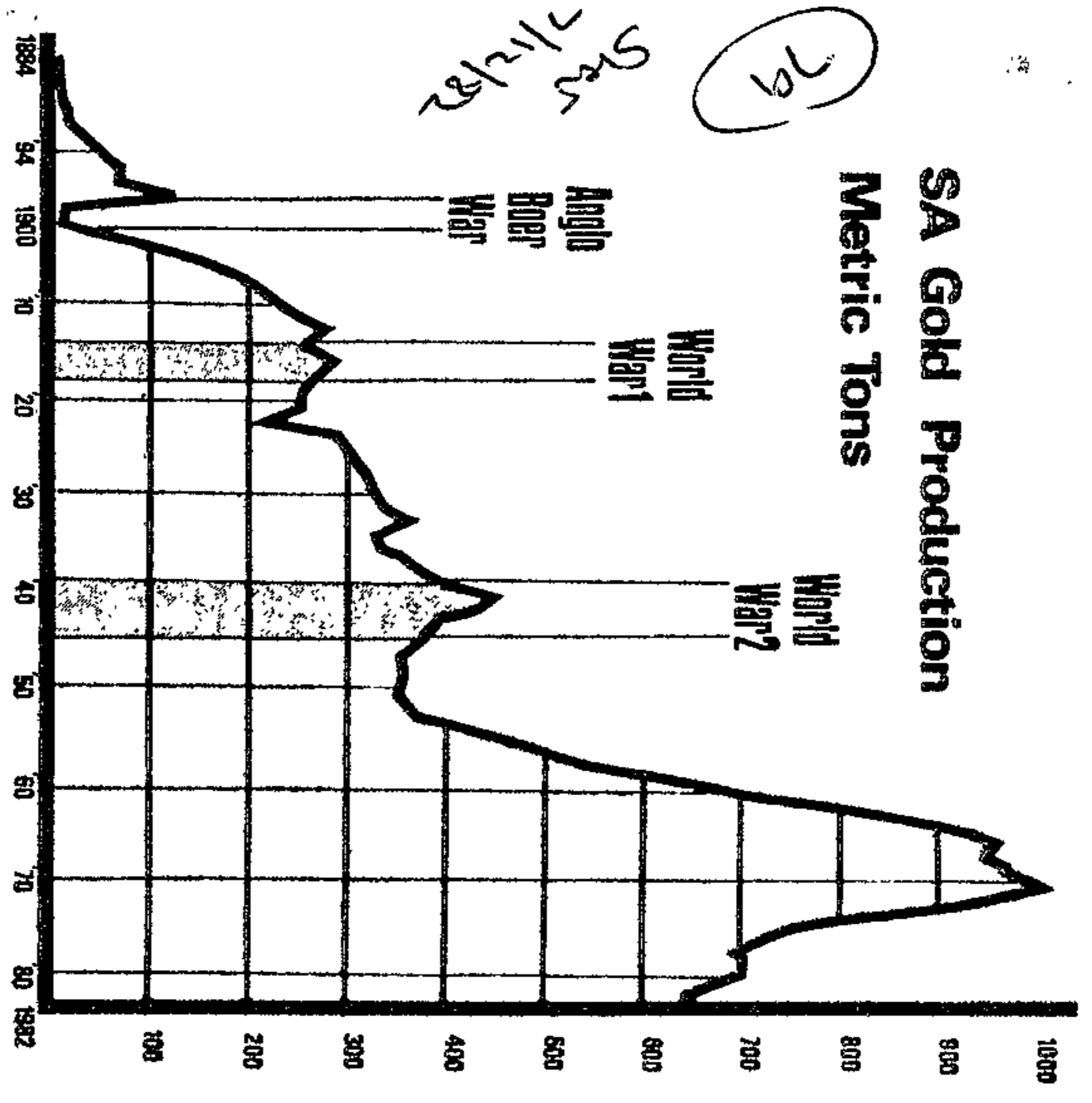

South African annual gold production over the past almost 100 years provides a pattern of rising and falling totals. The decline from the high of more than 1 000 metric tons in 1970 to an estimated figure of 645 to 650 tons this year represents a fall of 35 percent. Chamber of Mines' figures show that the average gold grade of South African mines will have dropped by about 45 percent from around 12.7 g a ton in 1972 to about 7 g by the end of this year. However, apart from the fact that many mines are forced into lower grade areas, the higher gold price (right) has enabled many mines to lower grades in the interests of extended life. The rise in the price of gold should be seen, however, in the context of rampaging inflation in the '70s and early '80s, which not only reduced the value of the rand but also dramatically raised running costs and capital expenditure. Looking ahead, the Chamber of Mines projects annual production around current levels until 1987 when a gradual decline will set in. By the year 2000, production will be about 350 tons a year, it is estimated. In the next 50 years, South African gold mines are expected to produce at least another 15 000 to 20 000 tons of gold. But to achieve this, capital expenditure will have to be well in excess of R50 000 million at current money value. Projections have, however, almost always been far from the mark. Fifty years ago it was assumed that gold production would long have ceased by the '80s.

### Average Annual Gold Price in Rand Ounce

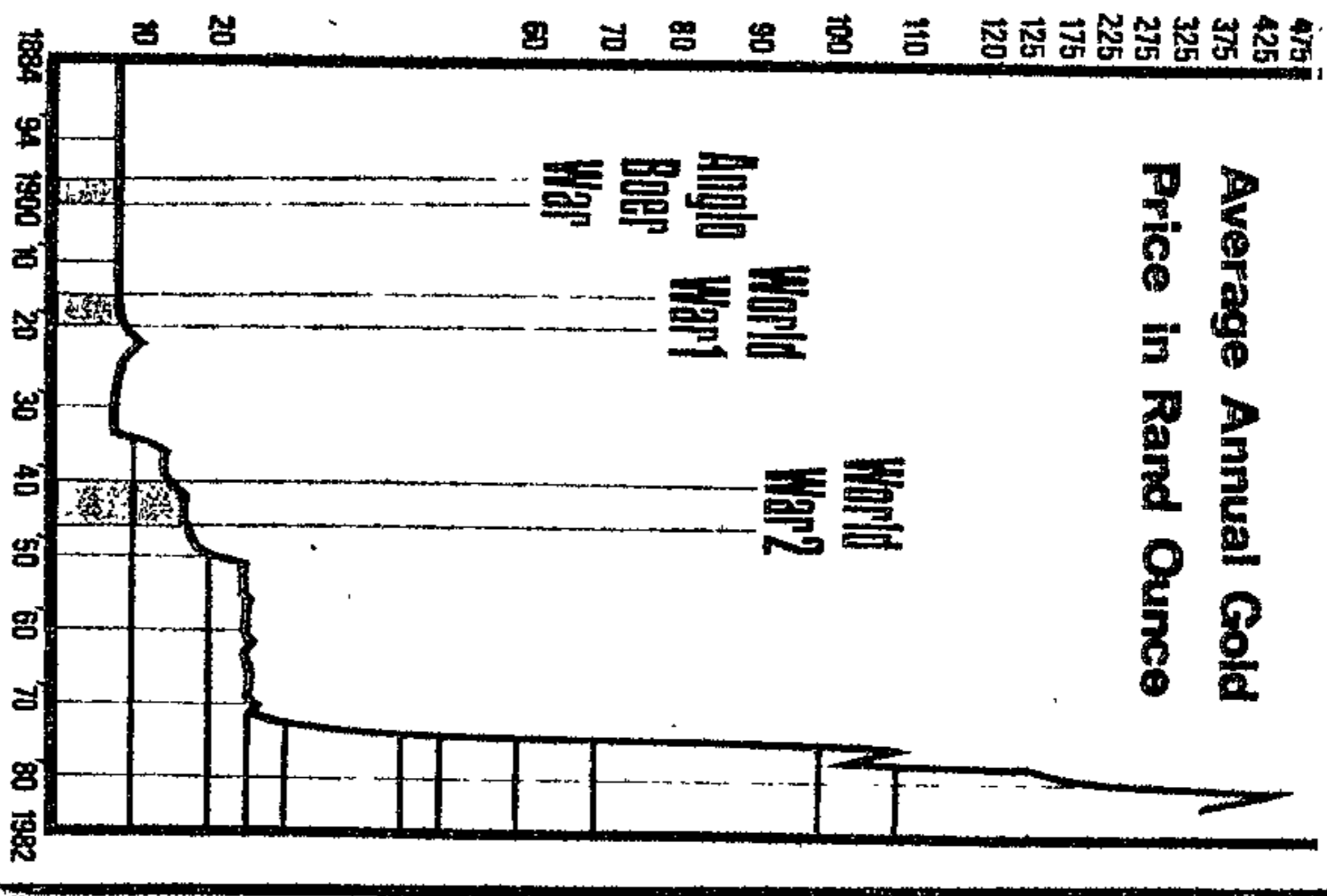

# Gold price shoots to near \$460

ARGUS  
7/12/82  
79

Argus Financial Correspondent

LONDON. — Gold shot up to \$458.15 an ounce at the fixing in London today, almost \$15 up on yesterday's close. Earlier it had traded briefly at \$490.

Explaining the spurt in the price, a London stockbroker said: "It's that man Kaufman again."

Dr Henry Kaufman, of New York brokers Salomon Brothers, had merely added his opinion to countless others that the Federal Reserve would soon lower its discount rate.

But for many investors the nod from Dr Kaufman has become the most important signal on the movement of the market.

### MORE SCEPTICAL

Other brokers were more sceptical. "There is no apparent reason for the rise in bullion," said one.

"We have thought for some time that gold is looking strong so the move comes as no surprise to us."

Another broker said gold was clearly reflecting the weakness of the United States dollar.

The brokers mentioned chart support.

But American dealers said earlier this week that there was a major resistance barrier at \$440 and if gold moved above this level, it would continue its march to \$500.

GOLD

1983

JAN.

—

DEC.

# Gold tops \$500 but falls back

ARGUS  
19/1/83

79

A LATE buying wave sent the gold price through the \$500 barrier in New York last night to a close of \$501.50, but the surge was not maintained in London today when it was fixed at \$497.75.

It had opened in London at \$500.50.

The close in New York was the highest level since September, when gold briefly touched \$512 there, and was 60 percent up from last year's low of \$296 reached at the end of June.

It was the first time since April 1981 that gold had closed above \$500 in New York.

Bullion dealers said the price was propelled upwards to its new high in the final hour of trading, Sapa-AP reports.

In London yesterday gold closed \$9 lower on the day at \$486.50 after an afternoon fixing of \$485, Reuter reports.

## PROFIT-TAKING

But dealers said this was due to profit-taking, which was a natural reaction after gains of around \$20 over the past week.

The rise in the gold price has taken place in spite of the strengthening of the dollar.

Dealers have been surprised by the sharpness of the advance, due partly to the drop in the United States federal funds rate from an average of 8.45 percent on Monday and partly to nervousness based on a false report that Iran threatened to block the Straits of Hormuz.

They say it has been fuelled by speculative buying with more small investors taking an interest.

In New York this interest began to abate towards the close, suggesting that the market could undergo a correction today.

at  
of  
ld  
of  
al  
of  
at

L  
I  
L  
E  
E  
K  
L  
L  
V  
W  
W



# High gold price could reopen mines — Anglo

ARGUS 21/1/83

74/24

JOHANNESBURG —

The higher bullion price could lead to the reopening of a number of gold mines in South Africa which were previously put in mothballs or considered not to be viable.

The first indications of this have come from the December quarterly reports released this morning of gold mining companies administered by the Anglo American Corporation

In his annual report to shareholders the chairman of SA Lands (Sallies), Mr N Oppenheimer, referred to the possibility of establishing a gold mine in the area of the defunct Van Dyk Consolidated Mines on the East Rand.

This project was shelved after the gold price tumbled to its low-

est level in three years when it dipped below \$300 an ounce during July last year.

But today the company said that in view of the more favourable gold price, de-watering of the Van Dyk No 5 shaft had recommenced and it estimated that the old workings would be entered within about four months

This does not necessarily mean that the mine will start up again as mining will be dependent on sampling results

### AFRIKANER LEASE

Another heartening fact to emerge from the quarterly reports is that gold has been produced for the first time from Vaal Reefs' Afrikaner Lease area

Elandsrand was one of the better performers in the Transvaal and to underline this the company has declared a maiden dividend of 15c.

### PROFITS LIFTED

The increase in gold price helped to lift profits from R19.3-million to R23.6-million and after deducting capital expenditure, earnings a share were left at 14.7c against 13c three months earlier

Other dividends declared today are: Vaal Reefs — final dividend of 600c (530c) making 950c (980c) for the year. South Vaal Holdings — final of 210c (195c) making 330c (355c) for the year. Western Deep — final of 260c (205c) making 395c (405c) for the year. SA Land — final of 40c (25c) making 75c (40c) for the year.

David Bamber

1.1  
1.2  
1.5  
1.8  
1.1  
1.3  
1.3  
1.6  
1.0  
1.5  
1.5  
1  
0  
3  
8  
3  
1

1  
2  
3  
4  
5  
6  
7  
8  
9  
10  
11

1982 sales below those for 1981

# Soviet gold surprise

79  
2014  
31/1/83

**LONDON.** — Sensible marketing tactics by the South African Reserve Bank and the Soviet Union have buoyed the gold market in recent months.

Both sell more gold than usual when the market is strong and reduce offerings during weakness.

The Soviet Union, in particular, has surprised the market.

After large offerings in 1981, the market expected Russia to sell big amounts in 1982. But it sold less than in 1981.

Bullion dealers estimate that communist bloc sales in 1982 will turn out to have been 230 to 240 tons compared with 283 tons in 1981.

Russian sales, estimated at 240 tons in 1981, are expected to have dropped to 150 to 200 tons for 1982. Other Eastern bloc nations increased gold sales — Romania and Hungary, for example.

Swiss, London and German bullion dealers say Russia has been more or less out of the market in the past four months.

Gold managers at the Soviet bullion trade bank, the Zurich-based Wozchod Handelsbank, trade and conduct arbitrage business in various centres, including Hong Kong, so it is impossible to assess what is happening on a month-to-month basis.

A Zurich bullion manager says: "It is difficult to estimate precise quantities of gold sold, but Russian sales in 1982 were definitely lower than 1981."

Russia also sold smaller quantities of platinum in 1982 than in 1981.

It slashed palladium supplies to boost prices.

Some dealers are perplexed by the smaller Soviet offerings of precious metals. They thought that the war in Afghanistan, lower revenue from oil exports and high imports of grain and other goods would strain the Soviet

By NEIL BEHRMANN

foreign-exchange reserves. Returns of the Bank for International Settlements, however, indicate that the Soviet's financial fortunes may be improving.

Soviet deposits at major Western banks and offshore centres rose from \$4 12 million in September 1981 to \$7 448-million in September 1982.

Soviet borrowings from these banks — possibly because the banks lowered their lending all round — fell from \$15 375-million to \$13 705-million.

Some analysts expect the Soviet Union to step up gold sales if the oil price falls.

A German bullion manager disagrees with this view, saying: "Russia can reduce sales volumes because higher gold prices are boost-

ing revenue."

Zurich dealers believe that Russia will continue to maintain a slower sales rate.

The Reserve Bank has become much more sophisticated in its trading techniques.

A fortnight ago when gold surged through \$500, dealers noted above-average Reserve Bank sales. In the past week SA sales dropped sharply, presumably because the Reserve Bank wanted to stabilise the price.

Statistics from the International Monetary Fund indicate that the Reserve Bank retained gold during times of market weakness and sold more on the market was buoyed last year. The Reserve Bank reserves dropped by

60 000 ounces in August when the market was strong, rose by 50 000 ounces in September when the price weakened and fell by 80 000 ounces in October and November when the market strengthened.

"South Africa on average sells 1 800 000 ounces a month, so these amounts are small," says a Zurich bullion manager. But the tactics help to stabilise the market.

A London bullion manager says: "South Africa is not manipulating the market. On the contrary, it wants steady price appreciation so that its main gold customer, the jewellery industry, keeps on buying."

Most bullion dealers believe it is only a matter of time before gold pierces \$500. For the moment it is meeting resistance slightly short of \$500. A Zurich bullion manager and a London bullion trader first expect it to react to \$470.

Cape Times 1/2/83 (79)

# Gold breaks through to \$500

GOLD broke through the psychologically important \$500 an ounce level on world bullion markets yesterday, closing at \$499,75 in London.

London's morning fixing was \$503 and the afternoon \$499,50, in a continuation of a recovery which has seen a 25 percent price rise in the past three months.

The period's \$100 rise, worth about R2-billion to South Africa over a full year, has taken the average price for the year on the London market to \$480 an ounce, against \$375 last year and \$460 in 1981.

● Mines receiving record price for gold, page 18

AR645      1/2/83      79

# Gold rises on fears over oil

## Finance Editor

THE gold price has risen to a 22-month high of \$508.50 following increasing fears that the sinking oil price will further intensify the serious international financial crisis.

There is concern that any large drop in the oil price would make it extremely difficult for several countries which are already in serious financial difficulties to meet their debt commitments.

This would undermine the entire Western world's banking system.

Since Friday, investors and speculators have pushed the gold price up by more than 15 dollars and it is now almost 70

percent higher than it was seven months ago.

However, considerable speculative pressure has also centred on another precious metal, silver. Its price has risen more than \$1 since last week to above \$15 an ounce.

As a result, the silver price is now almost three times what it was at the middle of last year.

Among developments triggering the latest buying of gold and other precious metals were:

- A drop in the spot market price of North Sea oil to \$28.88 a barrel;

- An announcement by Chile that it was suspending for three months the repayment of the principal on its debts;

- Reports that Venezuela, another major oil producer with \$18-billion in external debts, may have to seek aid from the International Monetary Fund;

- A slump in Nigerian oil production which has drastically reduced its ability to pay its trade debts, estimated at between \$3-billion and \$5-billion.

The British pound fell to a record low of \$1.52 in New York on the news of the drop in North Sea oil prices.

As a result of the North Sea oil discoveries Britain today is the world's fifth largest oil producer, with an output greater than that of all

the Opec member states with the exception of Saudi Arabia.

The United States President, Mr Ronald Reagan, recognised in his budget speech last night the seriousness of the monetary crisis by calling for extra finance for the International Monetary Fund.

However, there are doubts about whether the IMF would be able to counter a serious monetary breakdown.

Most economists believe that the only solution to the world's current financial problems is a major economic recovery led by the United States.

ARGUS 2/2/8  
79

# \$500 gold may mean no tax rise

## Financial Reporter

IF THE gold price stays around \$500 an ounce, it will mean no tax increases in the Budget next month.

Bank economists say the present high price of gold is bringing the Government millions of rands in extra revenue from the mines.

In its monthly economic review, Senbank said the chances were good that no tax increases would be announced if the gold price — fixed in London yesterday at \$508,50 an ounce — remained above \$450.

If the gold price fell the Minister of Finance, Mr Owen Horwood, might raise company tax.

An increase in indirect taxation was unlikely because of its inflationary effect on prices, the review said.

Mr Horwood raised sales tax twice last year, from 4 c in the R1 at the beginning of the year to 6 c in the R1, increasing many prices.

The chief economist of Volkskas Bank, Mr A Engelbrecht, said he expected "a neutral Budget" without tax increases if the gold price remained high.

"But it must be maintained in the vicinity of \$500 an ounce," he added.

"This would bring additional revenue and give the Minister room to manoeuvre."

He said any tax increases would intensify the present downswing in the economy.

## UNCERTAIN

But there could not be an inflationary Budget because the world economy was too uncertain.

"The Government will trim expenses and the Budget must be financed in a non-inflationary way," he said.

"Our inflation rate is 14,7 percent and this is a serious problem.

"But there can be large swings in the price of gold. That is a fact we cannot ignore."

# Gold shares nose-dive and Krugers drop R30

*Cape Times 24/2/83*

By PAUL DOLD, Financial Editor

UP to 15 percent was chopped off the prices of gold shares on the Johannesburg stock exchange yesterday as the gold price plunged to nearly \$470 shortly before the Opec ministers agreed in principle to cut their oil prices.

The lower oil prices have unsettled both the London and New York stock markets and could trigger an international currency crisis.

While so far there has apparently been little sign of a floor for gold some analysts believe the metal remains in a basic bull trend and the current weakness is a short-term correction.

Whether this is an accurate viewpoint remains to be seen. Gold is falling due the prospects of even lower world inflation rates as the cost of oil drops.

While US inflation is bound to rise as President Reagan reflates the economy the increase will be slow and off a low base.

## Bearish for gold

The bullion market so far is interpreting this as bearish news for gold and US investors have been sellers of gold shares for the past two weeks well ahead of bullion's dive.

The market is ignoring theories that the lower oil prices could lead to further shocks for the international monetary system and US banks if oil producers are unable to meet their debt commitments.

Although there was a slight recovery in share prices yesterday morning the downward trend was resumed in the afternoon in fairly heavy trading.

Volume in the morning was small but selling accelerated in the afternoon.

## Overseas selling

The Cape Times Johannesburg correspondent reports that Kruger rands dropped R30 to R570.

Bellweather Amgold lost R11,25 to R128,50.

The slide was sparked by the slump in the bullion price on prospects of falling oil prices, with New York leading the way overnight in heavy speculative liquidation and stop-loss selling.

Gold dived sharply in early trading on aggressive overseas selling, although volume was not particularly heavy. Mining financials and diamonds followed golds but other minings were barely tested and industrials were quiet and little changed.

The rest of the market followed golds down in the late afternoon. At the close golds were easier across the board and there were wide losses on most other boards.

Randfontein slumped R10 to R157. Vaal Reefs was 900c down at R124.

Other big losses included Durban Deep, 650c easier at R44, President Brand, off 600c at R52, and Freguls and President Steyn, both down 550c to R53,50 and R58 respectively.

Cheaper priced producer losses ranged to 140c as in Grootvlei.

De Beers eased 35c to 800c and Anamint 400c to R96. Palamin in coppers slipped 50c to 320c and RD Lease 20c to 190c.

Impala lost 30c to R10,20, Lydenburg 50c to 550c and Rustenburg 60c to 700c. Rooiberg Tin eased 25c to R22,75, Cons Murch 10c to 800c.

Amcoal fell 175c to R25,50 in easier collieries. Anglo American shed 130c to R20,40, Gencor 175c to R32, GFSA 750c to R144 and Johnnies 300c to R126.

## Industrial losses

In industrials many issues showed losses of 5c to 20c. Only clothings, fishing, food and motors showed any firmness on the day.

In generally unchanged banks, Sage Ltd eased 10c to 470c.

In insurances M & F added 25c to R62,75.

GF Properties eased 25c to 305c and RM Properties 35c to R10,25.

Amic shed 75c to R33, Barlows 30c to R12,40, Waverley 20c to 180c, SA Breweries 20c to 750c, Sasol 12c to 403c.

In clothings AF & OVR added 20c to 600c and AF & OVR A 50c to 600c.

In electronics Altron gained 75c to R14.

Cadswep firmed 50c to 850c and Premier Group 25c to R18,50, but Tiger Oats shed 50c to R27.

Sappi was unchanged at R10,50 but Hortors eased 12c to 145c.

Hiveld was off 20c to 530c.

Clicks shed 25c to 775c, Checkers 40c to 660c, Kimet 10c to 205c, Metro 100c to R16 and Met Cash 30c to 295c.

Trencor in transports eased 100c to R17.

● The volume of shares traded was 4 236 180, valued at R32 146 946, compared with 3 521 489, valued at R21 602 713, on Tuesday. The number of securities active was 329 (364). The five most active stocks were Protea, Samanco, Group Five, Leslie and Elsburg.

# Gold plunges another \$20<sup>79</sup>

LONDON. — Gold prices fell another \$20 in Europe again yesterday while investors bought dollars as a safety measure in the face of uncertainty over anticipated oil price cuts, dealers said.

Silver tumbled in Europe and the British pound touched a record low.

Gold, which recently traded at a two-year high of over \$500 an ounce, was fixed at \$470.25 in both London and Zurich yesterday afternoon after trading earlier around \$468.

It closed on Tuesday at \$488.50 an ounce and has now slid nearly \$40 in two days.

Dealers said the stronger dollar and expectations that lower oil prices would reduce inflation and boost the US economy helped to push gold down.

They said speculators were also selling gold as the price fell below levels they were willing or able to support.

## Oil and Opec

Money dealers said the dollar was being helped by a feeling that it was a currency of refuge given uncertainty over the effects of an anticipated cut in oil prices.

Gold, normally a haven for investors in times of political or financial trouble, had risen after the failure of Opec members in January to reach agreement on price and production policies for their oil.

Dealers said, however, that investors appeared to feel the benefits of an oil price cut for the world economy outweighed the impact it would have on the economies of oil producers with heavy debts like Mexico, Venezuela, Nigeria and Indonesia.

## Dollar and pound

The dollar traded at 2,4280 West German marks compared with Tuesday's close of 2,4097 marks, while it also gained ground against the Swiss franc and the Japanese yen.

The pound, a petro-currency hurt by the international oil price war, dipped to an all-time trading low of 1,5135 dollars in the afternoon before rallying to close at 1,5220 dollars, slightly up from Tuesday's 1,5203. — Sapa-Reuter-AP

CAP Times 2/4/83  
1  
f  
i  
1  
1  
1  
P  
C  
1  
1/2  
1/4  
1/1  
N  
S  
f  
J  
M  
S  
c  
3  
fi  
c  
d  
p  
fi  
ti  
ti  
d

S. Times 27/2/83 (500) (222/114) (79)

# Moment of truth for gold

## OIL SUMMIT MEETING COULD MAKE OR BREAK BULLION MARKET

By Elizabeth Rouse

**GOLD** faces its moment of truth at the coming Opec emergency summit oil producers' meeting.

Bullion, both gold and silver, are treading on an electric highwire, and unless Saudi Arabia and four member Arab Gulf exporters can pull other oil producers into line, sparks might fly.

What has oil got to do with gold?

In a sentence, world oil prices can make or break economies, cause booms or recessions.

As gold's fortunes are inextricably tied to these economies, to business cycles and to the relative attractions of alternative investments, what happens to oil leads gold by the nose — as explained below.

The world's leading oil producer, Saudi Arabia, and four other Arab Gulf exporters, the United Arab Emirates, Kuwait, Iraq and Qatar, will give dissident countries in the 13-member Opec oil cartel a last chance to agree on a new pricing structure or face a destructive price war.

A surprising phenomenon is gold's belated reaction to the long-obvious downtrend in world oil prices and then its slow reaction to the actual price cuts towards the end of last week.

But everything came crashing down on Tuesday. Gold was knocked from its two-year peak of \$511 the previous week to below \$465 on Friday, a fall of \$46.

The JSE Actuaries All Gold Index plummeted from 883.3 last Friday to 766.2 this week, a decline of 13.3%, as speculators scuttled out of the market.

Industrials lost confidence and the JSE Overall Index declined from 930.4 to 860.5, a loss of 7.5%.

If Opec, whose meetings

● To Page 3



# Moment of truth for gold market

● From Page 1  
frequently end in confusion, does not reach agreement, and the Saudi group declares a price war (loner Iran threatens to undercut Opec whatever the price), gold will take another knock.

The metal's price was due for a correction anyway on technical factors, according to some analysts.

A price of \$500 was not justified on fundamentals such as current jewellery and industrial demand.

That mark was also a critical point on the analysts' charts. Either gold was heading for \$525 or, if a sufficiently major event occurred (which proved to be the oil price chaos), the medium-term uptrend could be broken.

When a market becomes speculative, do not ignore the charts, say seasoned brokers.

Chart analysts now say that gold could drift down to \$460 unless it quickly retraces this week's lost ground.

The market is likely to attract fresh buying around \$480, but the recent support broken at \$480 will represent formidable overhead resist-

ance.

That is the medium-term reading for gold. In the longer term some chartists foresee a continuing uptrend, which many think is unbroken.

There are various factors which will influence gold's highwire act in the coming week.

● Consensus is that lower oil prices will hasten economic recovery in oil-importing countries, reduce inflation and undermine the importance of gold as a hedge.

● Opinions differ on the impact of lower oil revenues on debt-ridden oil producers such as Nigeria, Mexico and Venezuela, and the possibility of these countries defaulting on their debts.

● The fear of banking crises caused by these countries is therefore an important balancing factor for gold.

Total world indebtedness is \$700 000-million, of which \$300 000-million is owed to the world's private banking sector. This total is more than the total assets of the world's 10 largest banks.

However, some of these debts have been rescheduled.

S. Times 27/2/83 (500) (222/114) (79)



# Billions lost on shares as gold plunges

Financial Editor

BILLIONS of rands were wiped off share prices on the Johannesburg Stock Exchange today after the gold price plummeted more than \$40 to a six-month low of \$398 an ounce.

But a recovery in the gold price to \$419.75 led to shares firming slightly.

Dealers in London and Hong Kong blamed the drop in the gold price on continued heavy selling in Far Eastern markets as nervous investors continued to liquidate holdings in the face of falling oil prices and lower US interest rates.

## LOWEST

At its lowest today the gold price was \$64 below the Friday afternoon's London close and \$106 since last Monday's London close.

In early trading on the Johannesburg Stock Exchange today gold shares were showing bigger losses than for the whole of last week.

Some gold share prices fell more than 20 percent, though the average decline appeared to be between 10 percent and 15 percent. Later some of the losses were reduced.

At one stage Randfontein was down 1 550c to 13 600c but recovered to 13 850c. West Rand Cons dropped 265c to 775c, before rising 75c to 850c. Elandsrand, which closed at 1 230c on Friday, dropped to 1 125c before recovering to 1 140c, while Loraine dropped from 780c to 625c only to bounce back to 670c.

AD

A . 1

# Plunge in price stuns the JSE

Star 28/2/83  
(79)

# Gold below \$400, then a 'recovery'

**Hong Kong**  
Stunned disbelief on the Johannesburg Stock Exchange this morning greeted the news that Hong Kong had hacked the price of gold down to 395 dollars an ounce.

This was followed by a London opening price for bullion of 415 dollars, which proved to be the low point for the morning, a fact that probably helped prevent panic on the JSE. In any event, millions of rands were wiped off share values.

By midday the London price was in the 421 to 424 dollar range and Zurich was trading at between 417 to 421 dollars.

The sharp drop in gold brought about a 70,7 point decline in the JSE all-gold index and brokers were advising clients to exercise caution. The extent of the sudden weakness caught the JSE totally unawares, and by midmorning brokers were still trying to make sense of an extremely uncertain and volatile situation.

Hong Kong and Singapore, Asia's leading bullion markets, earlier suspended dealing in gold for future delivery after the price had fallen the maximum allowed for a single day. Suspension was brief, but it was said by dealers to be the first time this had happened in Hong Kong.

The extreme nervousness in Asian markets was generated by an oil crisis to which no solution appears to be in sight. The continuing decline in American interest rates reducing inflation and thereby making gold less attractive as a hedge to investors was only a background factor.

From Washington it was reported that the United Arab Emirates Oil Minister said yesterday that unless oil producing nations reached agreement on the price and production level of oil, the price war that would ensue would ultimately hurt the consumer.

## 'Defeat for other side'

"The producer won't be defeated, it is the other side that will suffer defeat," Mr Mana Oteiba said.

According to the United States Treasury Secretary, Mr Donald Regan, however, the lower the oil price goes, the better it will be for the world economy as a whole. "As oil declines we should see a decline in all price levels, including interest rates," Mr Regan said.

Both were interviewed separately on American television and both predicted lower oil prices in the days to come.

The 34-dollar-a-barrel benchmark set by the Organisation of Petroleum Exporting Countries no longer exists, Mr Oteiba said.

"We must now look for a new level of market," he said, predicting it to go down to between 30 and 29 dollars.

As to how he believed an agreement could be reached on a single price and production level, Mr Oteiba said: "We are now making contacts within Opec and outside Opec for pricing oil and agreeing on a quota."

He warned, however, that "we cannot wait forever," and confirmed having said recently that "other things will happen" if no agreement is reached within the next week.

Asked to elaborate on the "other things", Mr Oteiba said he meant that "we will choose our own way. We'll choose our own price and set our own level of production".

The current situation has been caused by "a shrinking market", due to very low demand. "We have to deal with this sharp decline . . . We must stimulate demand," he added.

## Protection

Mr Regan admitted that, in view of declining oil prices, some American banks would face difficulties because of loans made to less developed nations like Mexico, but he said those banks would be able to use the protection of institutions like the Federal Deposit Insurance Corporation to absorb the shock.

He said that as the price of oil declines "we should see a decline in all price levels, including interest rates in the United States".

The price of oil would probably keep changing between now and June, Mr Regan said, and predicted it would go down to between 29 and 25 dollars a barrel and produce a 10-percent savings in energy in general.

He said oil producing countries like Mexico and Nigeria would be affected, but indicated that "a lot of oil exporting nations have reserves and loans available to them" to cushion the impact.

See Page 12.

# Gold collapses to \$398 in heavy selling wave

CAPE Times 1/3/83 (79)

By PAUL DOLD  
Financial Editor

THE gold price cracked yesterday, diving to \$398 in Hong Kong and to \$413,50 in London in one of the sharpest falls by the metal.

The dramatic sudden weakness of gold shook bullion markets.

The sheer volatility of the metal which fell like a stone, devoid of interim technical corrections on the way down, caused alarm in the major bullion centres.

The price firmed in the morning in London to \$420 but gold eased back again towards the \$400 level in the afternoon with the late fix at \$408,50 (\$464,75) after the morning's \$419,75.

The unchecked descent suggests a major offloading of metal on the market in

Hong Kong, and in London last night there was strong speculation that a Middle East country had sold 15 — 40 tons of the metal.

If this did occur the bullion price should show some consolidation at current levels but it could take a considerable time for the price to shrug off this setback.

Only on Friday major South African institutions were confidently predicting that gold would show strong support around the \$470 levels, adding that a breaching of \$460 would be cause for concern.

None predicted that gold would test \$400.

The major plus factor to emerge from the drama of yesterday's events which saw up to 24 percent sliced off share prices — the top 20 falls of the day ranged from 12,8 to 24 percent — is

that the stock market moved down in a most orderly fashion in tandem with gold in spite of the financial rand no longer cushioning share prices.

However, it should be borne in mind that local institutions have been absorbing the bulk of overseas selling.

In the past three days the institutions have probably mopped up anything between R100m and R500m of foreign selling. Local resources are finite, and should gold continue to weaken a sharp slide in gold prices cannot be ruled out.

On fundamentals, short-covering by the bears is inevitable — probably leading to a rapid upward movement in share prices.

A heavyweight, such as Vaal Reefs standing on a prospective yield of 11 percent, must be considered attractive to overseas investors.

But a further complicating factor is the rand. If overseas the rand is perceived to be under pressure, foreign investors might be wary of being in a currency which could move lower.

Investors generally are confounded by the gold price in the face of the oil price cuts, particularly as

## Now, a new graph service for readers

BUSINESS REPORT today begins a comprehensive graph service to keep readers abreast of the latest developments in gold, commodity and share markets.

The graphs which are being provided by Trendline will provide Cape Times readers with an overview of financial markets at the current time.

At a glance readers will be able to see past performance of indices, metals and individual shares providing essential information on trends.

This addition to the Cape Times' normal wide coverage of stock market statistics will ensure that readers have the most comprehensive service available in Cape Town.

● The Cape Times was the first local newspaper to introduce a computerized share price service.

the latter had been widely predicted and should have been fully discounted weeks ago.

One theory is that American computer charts continued to remain bullish on technical reasons well after it became clear that oil prices could be cut and have only now turned bearish. Now, with stop-loss bells ringing, the sell-out is underway.

There is also some amazement that the gold market has not focussed more sharply on the debt problems of the oil-produc-

TUESDAY, N

# \$60 dive in SWISS panic

CAPE TOWN  
11/3/83 (79)

ZURICH. — Panic-selling spurred by dropping oil prices caused disarray in Zurich gold markets yesterday, where prices of the metal dropped over \$60 from Friday's close.

Some Swiss banking officials said they could not remember having seen such a steep drop, but could not immediately pinpoint a similar slide in price.

Some Swiss banks reported gold slid below \$400 in yesterday's trading, plunging from a close of about \$470 on Friday.

They attributed the decline to uncertainty over the price of oil as Opec members sought to prevent a price war following recent steep oil price reductions by Britain and Nigeria.

A Geneva gold dealer said there was no selling in the Middle East yesterday, implying much of the selling came from people worried that gold holders in the Middle East would sell the metal to make up for lost revenues.

"There were many reasons," the trader said in a telephone interview. "It started with the lower stock market in Hong Kong, where to cover debt they (investors) sold gold. But when gold went down \$10-\$15 many other people followed in panic selling." — Sapa-AP

# Gold starts to glitter again

2/3/83 Star Financial Staff (2a)

Gold shares staged a dramatic recovery in hectic and chaotic trading on the Johannesburg Stock Exchange this morning.

By noon the all-gold index had leapt a massive 67,7 points to 786,4 — its highest level in more than a week.

Brokers said investors were flooding back to the market and snapping up all available stock.

They said overseas selling of gold shares had dwindled and it was obvious that many believed the recent downward plunge in the bullion price had been too sharp.

The metal opened strongly in London this morning and was trading at 433 dollars an ounce ahead of the morning fix.

● See Page 14 of the Metro Section.

118645 2/13/83 (TR)

# Stock market follows recovery in gold price

By DEREK TOMMEY  
Financial Editor

THE price of gold rose strongly today and by noon it was \$430 an ounce.

This was a gain of \$17 on last night's closing price in New York and a rise of \$41 from yesterday's low point in Hong Kong.

Gold has now recovered about a third of its losses it incurred over the past 10 days.

Bullion dealers Samuel Montagu said in London today they expected the demand for gold to re-emerge if the price remained around its present level.

## Rally

The rally in the gold price spread to the Johannesburg Stock Exchange where gold shares also rose strongly in heavy trading.

By mid-morning the JSE gold share index had risen more than 50 points — an increase of around seven percent. But marginal mines were showing even great percentage gains.

Among the heavy-weight shares Randfontein gained R11 to R146, Elandsrand shares were 105c higher at 1 325c, Eisingburg 65c higher at 515c, and Grootvlei 200c higher at 1 750c.

~~(105)~~ ~~(105)~~ ~~(105)~~ (74)  
Export credit to  
D. Qisfatu 3/3/83.  
Transkei, Ciskei

JOHANNESBURG — The increasing industrial and agricultural development in Transkei, Bophuthatswana, Venda and Ciskei has created a demand for medium-term credit for capital goods to be delivered to these countries

The Credit Guarantee Insurance Corporation says as these countries are considered export markets, prospective contractors supplying capital goods to them can obtain export credit provided they hold a credit insurance policy issued by Credit Guarantee.

In order to meet the demand for export credit insurance, Credit Guarantee has developed a system whereby speedy decisions can be given on contracts in-

volving small amounts. A decision should not take longer than two or three weeks.

The credit periods which will be considered under this scheme are Contract value R50 000 — R100 000 — 2 year credit term, contract value R100 000 — R200 000 — 3 year credit term; contract value R200 000 — R300 000 — 4 year credit term

As is the case with other projects that qualify for export credit insurance, it would be a condition that the buyer pays a minimum of 15 per cent by the time delivery is made.

Contracts of less than R50 000 will not qualify for the credit terms exceeding 180 days — DDC

# The party isn't over

There is one certainty about the gold price; it is a mirror to uncertainty. The events of the past week have proved that beyond any shadow of doubt. But while gold can react quickly to changing short-term perceptions, the only sensible approach to the gold market is to take as long a view as possible. The gold price remains in an underlying bull trend despite its recent gyrations.

The difficulty, of course, is deciding what advice is realistic and what simply seeks to make a point by means of mental gymnastics.

Basic to gold's price movements at present are two factors: oil and speculative trading in futures markets. For the present they are both working in the same direction — hence the sharp gold price crack over the last weekend.

One view put forward early this year as Opec's grip on oil prices started to slip was that an oil price drop would lead to a worldwide banking crisis. The logic was simple enough: oil producer Mexico had borrowed \$25 billion-odd, largely from American commercial banks which had been willing to lend any amount when oil prices were rising; advancing interest rates had impaired its ability to service the loans, let alone repay capital; and declining oil prices pared the country's foreign exchange earnings capacity and thus lessened its ability to repay its foreign borrowings. A default, it was claimed, could trigger bank collapses and a major banking crisis in which the only asset worth anything would be gold. Other heavily-borrowed oil countries, notably Nigeria, Indonesia and Venezuela, were thought to be not far behind Mexico.

Of course, this scenario begged several questions. Falling oil prices should contribute to fast falling inflation rates. This, in turn, leads to declining interest rates which enhance the ability of sovereign risk borrowers to service their loans to the West's banking system. The combination of falling interest and inflation rates was seen as a gold price depressant. Furthermore, with oil prices declining, perhaps uncontrollably as an increasing number of producing countries failed to heed Opec's calls for a united pricing front, Russia would have to sell more gold to make up for the drop in oil export earnings.

Essentially all the main factors which only two years before had been cited as exerting upward pressure on the gold price were now acting in the opposite direction and forcing it down. When this combined with charts which had failed to break significantly above \$500, and particularly through the major \$520 resistance level, traders in futures markets took fright, started selling and triggered stop-loss selling orders. This, in turn, helped the chart's prediction of a gold price drop to become self-fulfilling. Futures markets

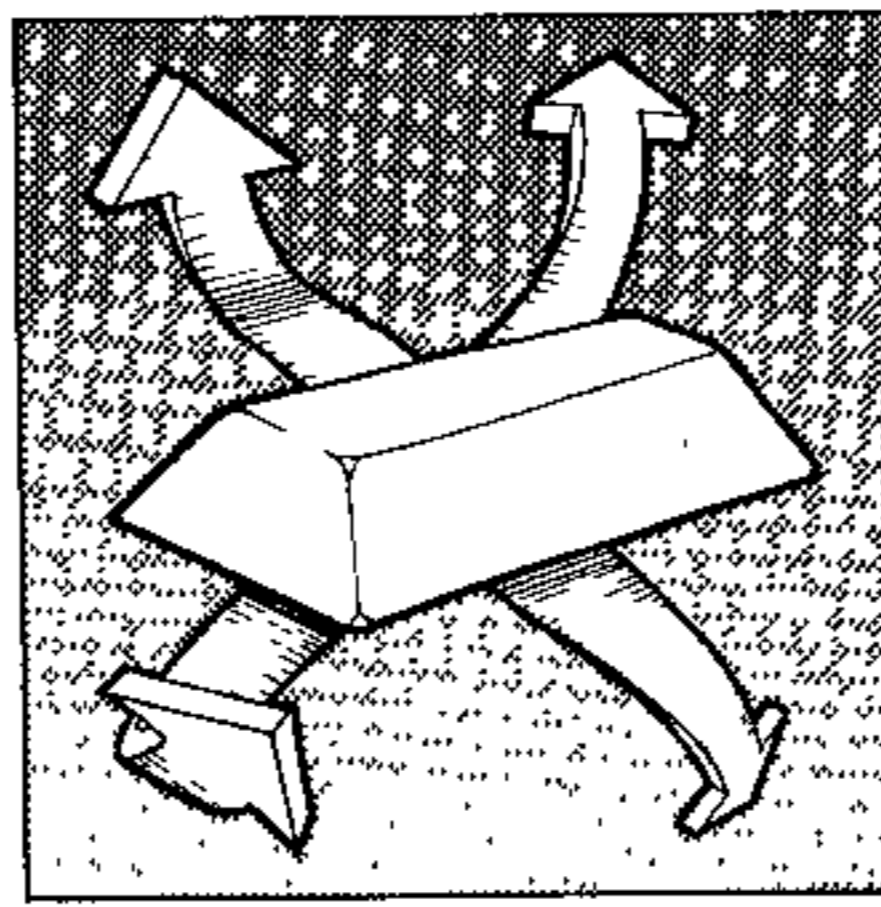

were, at the start of this year, preparing themselves for a change in sentiment.

There had been an almost steady rise of 70% in gold since mid-1982, when the price in London had bottomed at just less than \$300. And, in market parlance, a shake-out was due. Comex, on which trading is largely dominated by chart watchers, has seen its prices stabilise in the \$500 region, even though a lot of buying interest was evident. The corollary of this was that there was also a great deal of selling interest which could, given the right conditions, swing the gold price downwards.

Are there any indications that gold's price decline has run its course? If it has, now is the time to be buying back into the metal itself and shares which no longer have the price protection afforded until only three weeks ago by the financial rand.

The main focus of attention is on US economic policy and the problems still faced by the banking system. With lower oil prices helping to squeeze inflation out of the economy, America could tolerate some economic stimulation, which is necessary if unemployment rates are to be cut without any great risk of inflation being rekindled. Smokestack America has sufficient under-utilised capacity to ensure that increased output will not quickly run up against inflation-inducing capacity bottlenecks. From another angle, declining inflation and interest rates will help narrow the US budget deficit. This, in its turn, should

provide at least a psychological depressant for the gold price.

As far as the banking system is concerned, the threat of a major default-induced banking crisis appears to have receded. In other words, gold bugs should not look to these factors to provide a quick gold price fix. And it will be particularly so if the Opec oil ministers' meeting scheduled for this weekend fails to produce an enforceable and workable agreement on stopping the price-cutting in oil.

On the other hand, and it is the main optimistic point in sight, the gold price remains in a primary bull trend. Emerging from a 30-month bear trend is not without its false starts and spiky price performance. The underlying trend is one of gold price recovery — the present price is, after all, some 40% higher than it was just less than nine months ago. And that advance has been achieved concurrently with a strengthening of the American economy, declining interest rates, falling inflation and a firming dollar. In other words, gold has advanced overall in spite of a variety of inimical factors. The conclusion from this is that the basic gold price trend is sound notwithstanding the corrective setbacks of the past few days

The rate and extent of gold's price drop over the weekend are unprecedented. And though the market shakeout is, perhaps, welcome, it will make investors a great deal more cautious than they were during the price run up from \$300 to \$500. If that is the case, gold may well now have entered that stage in the bull cycle in which price advances are steady rather than volatile. This should last for at least a year.

An advance of this type clearly has a better chance of

being sustained than one characterised by sharp movements. By Wednesday this week, the gold market was settling down and showing signs of overcoming its initial shock. The excessive part of the fall was corrected with a price rise in London to the \$420 area.

It calls for strong nerves, but with the JSE Actuaries all gold index at 768.2% mid-week, 24% down on its 1 012.6 high of February 1, this could well be the time to be buying gold shares.



GOLD has done it again. It has once more made a mockery of most of the supposed expert forecasters.

But what will the price do now?

The developments in the market over the past two weeks have in some ways been the reverse image of what happened over July and August last year.

On this occasion, starting in the last few days of February, the gold price has taken a severe tumble — initially on the grounds that falling oil prices will further restrain world inflation — when the metal had previously been looking very firmly set.

Just after the middle of 1982 gold also defied the pundits, but in a quite different way.

It was in June last year that gold dipped momentarily below \$300, for the first time since mid-August 1979.

The price then rallied modestly but by July 7 it had slipped back to \$306.75, with little apparent support underlying it.

The vast majority of gold dealers, analysts and international investment advisers were by then taking a distinctly bearish approach.

This included a number of important investment commentators in the United States who had previously been long-standing gold bulls.

The consensus, with a few notable exceptions, was that gold was headed down for \$250, and that it might even be lucky to hold the line there.

The dominant factor was the steady decline in the United States rate of inflation which, coupled with continuing high nominal interest rates, meant attractive "real" rates of interest.

It looked as though the pattern of the 1970s — negative interest rates and a flight from paper money in search of all kinds of inflation hedges — was over and that gold would have to take a back seat, for a while anyway.

At that point the gold price soared steeply and surged to over \$400 by the end of

# Oil makes troubled waters for gold

79  
204  
9/3/83



Date	Gold price@ (London month high)	Oil price* (Shell S Arabian light)
January 1973.....	\$66	\$2.10
January 1974.....	\$141	\$9.60
December 1974.....	\$198	\$10.46
October 1975.....	\$145	\$11.51
January 1977.....	\$136	\$12.09
July 1977.....	\$148	\$12.70
January 1979.....	\$236	\$13.39
July 1979.....	\$307	\$18.00
November 1979.....	\$417	\$24.00
January 1980.....	\$850	\$26.00
April 1980.....	\$551	\$28.00
August 1980.....	\$645	\$30.00
November 1980.....	\$655	\$32.00
October 1981.....	\$451	\$34.00

@In the 1976-77 gold depression the price slumped to a low of \$103.05 at the end of August 1976  
\*The Rotterdam spot market can sometimes be more reflective of market prices than formal Opec levels. In November 1980 the spot oil price reached \$41, for instance. By December 1982, however, it was down to \$30.75 — signalling the disarray within Opec

August and to nearly \$490 in the first week of September.

The basic explanation for this remarkable turnaround in the gold market was a dramatic reappraisal of the immensity of the debt problems of a mixed bag of Third World, Eastern Block and oil producing countries.

Inevitably the exceptional recovery in gold during the third quarter of 1982 was over-done and there was a downward reaction again.

Even so, however, the bearish mood of June/early July 1982 was swept away and by the end of January this year gold was fixed fractionally above \$500.

Then came the growing

realisation that oil prices were being steadily discounted by various Opec members — among them Iran, Nigeria, Libya and Algeria.

This should hardly have been a surprise to the gold market — it had been clear for months which way oil was moving — but it still seemed to catch many bullion investors unawares.

There was a natural scramble by some gold holders to sell (taking handsome profits in many cases) before Opec got round to announcing a price cut to somewhere below \$30 a barrel.

That fundamental factor then caused a technical chain reaction.

Many US investors/speculators in commodities, including gold, operate with "stop-loss" provisions, often computersised.

That is to say, once a commodity price drops below some pre-determined level an automatic selling order is triggered.

So when gold fell back to around \$480 this provoked a selling wave which sent the price tumbling almost all the way back to \$500.

The market has now largely absorbed this particular stop-loss shock and is naturally recovering some stability.

But what happens now? Is there any logical connection

between oil and gold?

Some commentators think not.

The London Sunday Telegraph financial section argued three days ago: "In 1970 an ounce of gold would have bought 20 barrels of Arabian light crude which was then a modest \$1.80 a barrel. In 1976 an ounce would of gold would have bought 10.8 barrels, in 1980 21.3 and 12.2. There is no positive correlation between gold and oil."

It certainly seems absurd to claim, as some analysts have, that some formal ratio exists between gold and oil prices.

Back around September 1979 there was some support for an alleged "equilibrium" ratio of 16 barrels of oil to one ounce of gold.

It just happened that this conveniently tied in with the ruling \$400 gold/\$24 oil situation and could apparently be used with retrospective effect in 1974.

There is no reason, however, to see that as anything more than statistical coincidence.

But there is, in a much looser way, a perfectly logical connection between oil and gold.

The two great surges in oil prices, in 1973-74 and 1979-80, created huge international inflationary pressures and economic uncertainty almost everywhere.

What could be better for gold?

By the same token it is quite understandable that gold should be under pressure, in the short term anyway, from declining oil prices.

Apart from the crucial inflation issue there is also the possibility of gold sales by oil producers.

Also, since there are some oil analysts who believe that the posted Opec price could come right down to \$21 a barrel, it would be premature to assume that the gold slide has hit the bottom yet.

That does not mean, however, that other developments will not combine to give gold another upward push later on.

LONDON Gold fluctuated... New York opening amid... Cold averages... Last year hints...

- the block on this cover the number of the question you are answering.
- Blue or black ink must be used for written answers. The use of a ball point pen is acceptable. Red or green ink may be used only for underlining, emphasis or for diagrams, for which pencil may also be used.
- Names must be printed on each separate sheet (e.g. graph paper) where sheets additional to examination book (s) are used.
- Candidates are not to communicate with other candidates or with any person except the invigilator.
- No part of an answer book is to be torn out.
- All answer books must be handed to the commissioner or to an invigilator before leaving the examination.

**Any dishonesty will render the candidate liable to disqualification and to possible exclusion from the University**

# Bullion price pushes up gold shares

ARGUS  
19/4/83  
79

## Financial Editor

GOLD shares have been strong on the Johannesburg Stock Exchange in the past two weeks and one of the reasons is that the gold price mines are receiving is at a near record level.

Gold at the current price of around \$443 an ounce may not seem all that high in relation to the price ruling in 1980 and early 1981.

But if this figure is converted into South African currency at the latest exchange rate of around \$0,915 to the rand, the result is extremely impressive.

At \$443 an ounce the local gold price is around R15 500 a kg which is one of the highest ever received by the gold mining industry, figures issued by the Chamber of Mines show.

Last year the average gold price was R12 591,37 a kg, with the quarterly average fluctuating, but generally trending upwards, from R11 091,35 in the first quarter to R14 766,03 in the fourth quarter.

## SLIGHTLY DOWN

Indications are that the gold price received by the mines in the first quarter of this year will be down slightly on the fourth quarter — but much will depend on the extent to which the mines sold forward and when the mines sold their gold.

Given a continuation of the current dollar gold price, it would seem that this could be a record or near record quarter for the mines' rand income.

Meanwhile, it seems that South African investors are making most of the market in gold shares, Roy Assersohn of the Argus Foreign Service reports from London.

## NOT OVERPRICED

He quotes top London stockbrokers Rowe and Pitman who say that gold shares are no longer overpriced because South African investors have ensured that higher ratings will prevail on the stock market.

They say in their latest circular to leading clients that the Johannesburg view of values has become the dominant market force.

The abolition of the financial rand appears to have caused a sharp change in gold-mining shares.

"We initially thought that Johannesburg prices would fall towards overseas levels but the opposite appears to have happened," say the brokers.

"Johannesburg with its heavy institutional cash flow and limited avenues for industrial investment is now the major buyer of gold shares and that market's higher ratings now seem to prevail."

The brokers say that share prices are not discounting much more than about \$450 an ounce for the price of gold and this is "not unreasonable".

"Consequently we do not think that gold shares are overpriced at present levels," the brokers add.

## RECOMMENDATION

They recommend that investors switch their gold holdings away for the more marginal mines to those of the better class medium and low cost mines.

They recommend selling Bracken, Durban Deep, ERPM, Leslie and Loraine.

They rate Harmony, Randfontein, Southvaal and Western areas as buys, and suggest switching Blyvooruitzicht into Harmony, President Brand into President Steyn and Deelkraal into Elandsrand.

# SA MUST USE GOLD, SAYS CAPTEL

22 By David Braun  
 19 APR 1983  
 South Africa has the responsibility, as well as the opportunity, to use its international gold supply monopoly to advantage, David Hargreaves, director of the British Metals Research Unit, told the conference yesterday.

"The gaining of a domestic advantage by the control of supply and price to the market need not conflict with the well-

being of the industry worldwide if such controls are installed within a framework of commercial reality," he said.

To improve its market position in gold South Africa should consider:

- Strategic withholding and release of newly mined supplies.
- Use of the futures markets.
- Use of gold as loan collateral.
- A lobby for gold remonetisation.

Mr Hargreaves said SA had resisted using futures markets as an adjunct to its sales policy while the Canadians, whose gold production was less than 10 percent of South Africa's, were adopting a fairly aggressive stance.

The establishment of a market in Hong Kong had effectively heralded a 24-hour gold market upon which the traded price was totally dependant.

"There is a danger of undue volatility and organised squeezes as a result of such a volume of activity but there is little possibility of the market being dismantled. Continued growth is more likely," Mr Hargreaves said.

"SA's presence can be viewed in two ways — a stabilising influence or potentially the most powerful addition to a fast-moving market."

These reports are based on papers delivered at the Second Southern African Metals and Minerals Conference in Johannesburg yesterday and today.



VAUGHN

## Uranium recovery unlikely

There is little likelihood of a substantial further recovery of uranium spot prices in the near term. Mr Jim Vaughan, vice-president of Nuexco, told the conference yesterday.

"Two basic reasons argue against significantly higher near-term prices.

"First is the continued existence of a strong secondary market, where holders of inventory are selling material back into the market.

"Second is the chronic imbalance between consumption and production, which will result in the world's inventory position increasing further over the next five years."

Nuexco expects continued growth of installed nuclear capacity into the 1990s, from 146 gigawatts in 1982 to 370 gigawatts in 1996, a compound increase of about seven percent a year.

Consumption of uranium (mainly in nuclear plants) on a worldwide basis is forecast by Nuexco to increase from 29 million kg to 58 million kg in 1996, a compound growth rate of five percent a year.

Mr Vaughan said that with inventory redistribution likely to continue it was difficult to see a mechanism for substantial price strengthening in the near term.

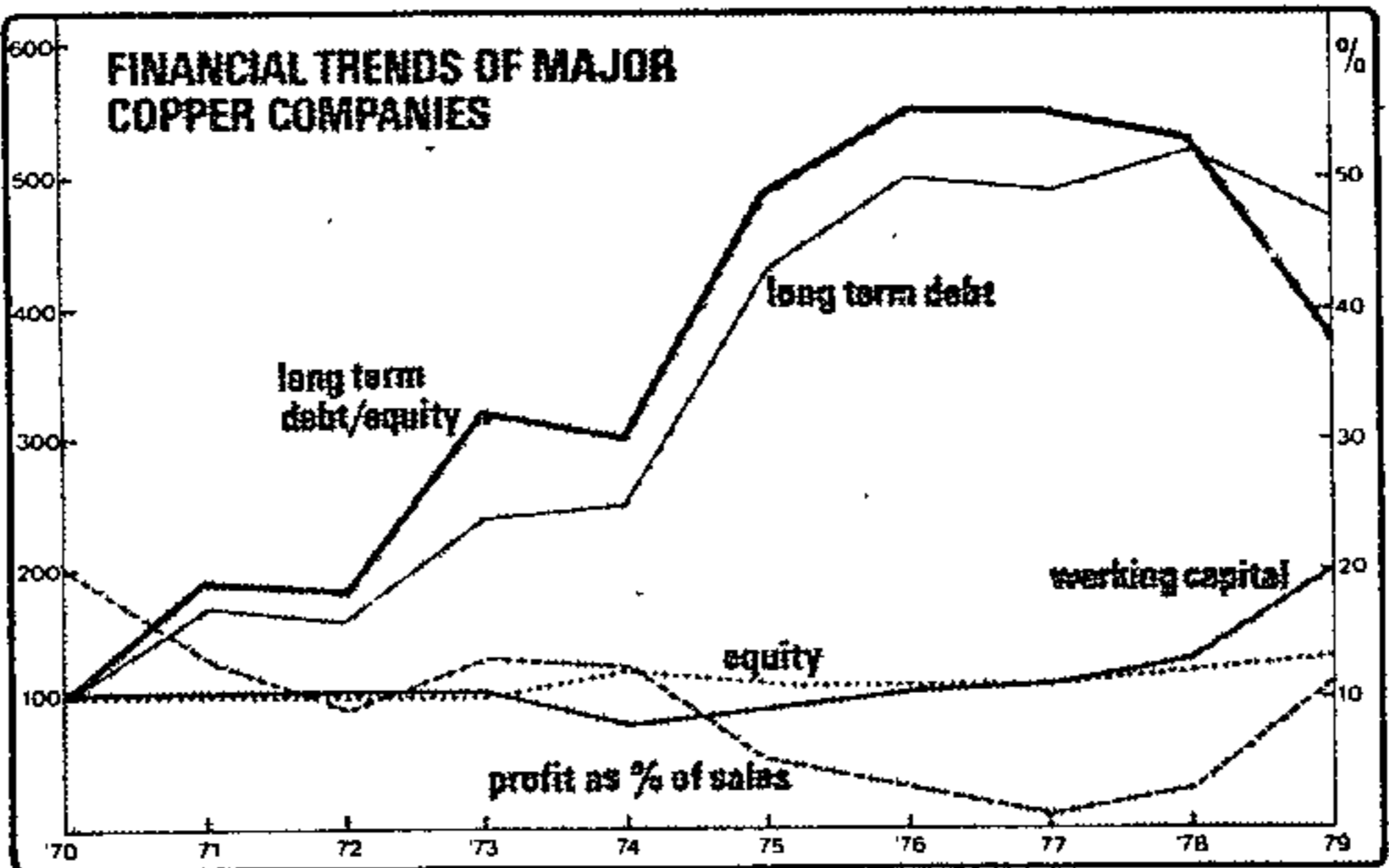

This plots the changing pattern of finances of the major commercial copper mining companies from 1970 to 1979. Whereas in 1970 longterm debt was only 10 percent of equity, by the late 1970s the figure had risen to more than 50 percent. A so-called "high-risk" industry should not operate with such high debt levels, says Mr Reg Eccles.

## Plastics outdoing base metals

Copper faces a potential major threat from fibre optics in the telecommunications end-use market. Mr Reg Eccles, group executive for base metals, Consolidated Gold Fields PLC, told the conference today.

"It is too early to assess with accuracy the extent of this threat but it has been estimated variously as displacing 100 000 tons to one million tons a year of mine copper production by 1990."

Mr Eccles said plastics had made significant inroads directly and indirectly into most of the base metal end-uses. It remained a major threat to copper in pipe and domestic construction materials, had taken a large share of the packaging market from tin, and had been a direct substitute of zinc in diecasts. Yet immediate prospects were for a revival in consumption and prices of all metals.

It appeared that copper, nickel and tin markets' problems would not be solved by a couple of years' reasonable economic growth.

"In my personal opinion real metal prices will remain weak, by post-war comparison, for most of this decade."

Mr Eccles said the fact that much Third World debt paper was worthless should result in a more conservative attitude on the part of banks to the financing of major minerals projects in developing countries.

Likewise the banks probably would adopt a more cautious attitude towards loans to commercial mining companies, given the latter's recent profits record, the worst in 50 years.

The mining industry would have to rely on risk capital, in turn placing responsibility for decision-making more firmly where it belonged, in the mining companies, and much less in banking halls and government circles.

The end result would be a healthier industry.



ECCLES

## Business 'uses' futures market poorly

The cash value of gold futures traded in 1982 was probably about R33 000 million, the Futures World editor said yesterday at a metals and minerals conference in Johannesburg.

Mr John Parry said: "A conservative estimate of world gold futures turnover in 1982 was 15-million contracts. A more realistic figure was probably nearer 20-million. At 400 dollars an ounce the nominal value of this trade was R660 000 million.

"This represents the face value of the contracts traded. It is slightly unrealistic, because future contracts are traded on a margin, and because all contracts are closed before delivery falls due. The cash value of the trade is considerably less than its nominal value, but even so it was probably around five percent of its nominal value."

Mr Parry said although there were 11 gold futures exchanges world-wide, more than half the business was done at New York's Commodity Exchange.

He said the futures business, especially in relatively new areas like gold, had been used poorly by many sectors, who should have been more enthusiastic.

GOLD

FM 29/4/83

(79)

# Fundamentally sound

There is absolutely no point in worrying about gold's daily fluctuations. They bear little relation to the basic trend and trying to out-guess the market is probably futile.

If this advice from one of London's leading bullion dealers seems extreme, it should be seen in the light of the gold market's present state. Basically, gold is in a bull trend and has been for the last six months or more. But this happy state of affairs will be characterised by enough fits and starts to make the most hardened gold dealer despair.

At the start of any bull market, a period of base building is necessary. Investors or traders need to be convinced that gold's new-found strength is not a flash in the pan. No-one is prepared to stick his neck out too far and trading in futures and physical metal becomes a highly professional operation. This professionalism carries with it a sophistication which to an outsider can appear to verge on the ridiculous. It is estimated, for example, that 40% of trading on the gold futures markets of New York and Chicago is done by computers. Traders simply cannot second-guess short-term price movements and to overcome this disability trading instructions are fed into computerised trading programmes. The result is that a small price drop can trigger a flood of stop-loss selling and a small rise a wave of buying.

The net effect is that price movements can become self-feeding.

The price of oil and its putative relationship to gold is of lesser importance than it was two years ago. Large oil price movements can, obviously, have a large effect on the gold price if they lead to altered perceptions of inflation. This happened towards the end of February when Opec's disarray and the developing oil price war led indirectly to a \$100 gold price drop from its heady \$500 level. The benchmark oil price appears to have stabilised close to \$29/barrel, so current gold price movements in response to oil are small and a matter of just a few dollars.

Of course, it took a combination of factors to generate

the end-February gold price drop. Apart from the oil considerations, there was a strong possibility that the US was about to embark on a gold selling spree. Though this suggestion was met with congressional hostility, it helped panic a market which was already nervous about gold's price. When this triggered computer-controlled selling orders, there was only one way for gold to move.

Essentially, though, these are superficial considerations. The main restraint to gold is the level of real US interest rates. Though nominal rates have fallen sharply in America, this has been accompanied by a significant drop in the rate of inflation so that the difference between the two has been little changed.

The result has been that the dollar has remained strong and real returns on dollar investments have been more attractive than the potential for gain in the gold market.

March and April are generally dull months for the gold market. The important European jewellery manufacturers tend to reduce their bullion purchases ahead of the August summer holidays and the market does not usually pick up until late June, when manufacturers start buying.

It is not only buyers of physical gold who are staying out of the market at present. In America the major broking houses have tightened up on high-rolling customers who suffered large losses in gold futures last year. In some cases business has been refused, while stiffer margin requirements have made speculative trading less attractive.

Gold's present price has to be seen in this context. At present the metal is trading just above \$430 against last year's average of slightly more than \$380. So it is clear that there is an underlying strength to the market. Just how far this will translate into price rises is another matter.

By year's end, the consensus is that gold should have reached the \$520 level. If it has, the period of consolidation and base building will be over and the metal will be away and running. This is sufficient reason for investors to establish their positions now.

79

# London Mining Journal predicts \$375 - \$450 gold price for rest of 1983

By PAUL DOLD  
Financial Editor

THE likely range for the gold price over the balance of the year is \$375 to \$450, the authoritative London Mining Journal forecasts in its latest review.

Reviewing the gold market, the Journal says the dominant influence is the likelihood of lower oil prices without a major price war.

As oil accounts for about five percent of expenditure in most major industrialized coun-

tries, the cut in prices is likely to reduce their inflation rates by about 0,75 percent — adding a similar amount to the real incomes of countries that import all their oil.

### Boom

The impact is hardly likely to create an industrial boom but it will provide a fillip to the growing signs of general improvement and investors attention will move away from gold to assets with an earning potential.

“With so much underutilized capacity available in the major manufacturing centres — plus lower oil prices — there would seem to be room for growth without significantly increased inflation. In turn this should lead to a more stable relationship between currencies.”

While these factors tend to turn attention away from gold and the market could drift in the short term, current inflation (although low), economic uncertainties and improving industrial demand were likely to sustain some support for the metal.

### SA economy

The predicted \$375 — \$450 gold price would not seriously threaten

the South African economy but it is probably a lower range than Finance Minister Mr Owen Horwood anticipated early in February when he abolished the financial rand.

Turning to possible further relaxations in exchange control the Journal says that foreign investment concessions for the major banks and institutions are likely. But linked to this development would be the need for a more responsive foreign exchange market currently dominated by the Reserve Bank selling the proceeds from gold sales.

### Investing

One proposal being considered is to allow the mines the option of receiving their gold sales proceeds in dollars instead of rands and possibly investing overseas for limited periods.

“It is unlikely that these particular proposals would have any significant impact upon the mines or the industry as a whole.”

“However, any more general relaxation of investment regulations for South African institutions could affect the industry's ability to raise funds for new developments.”

I  
TH  
J  
C  
t  
1

*republican*

# Gold price: SA 'reaping benefits'

*CAH Tunkis*  
29/6/83 79

HOUSE OF ASSEMBLY.  
— South Africa was today reaping the benefits of taking early corrective action in response to the decline in the gold price, the Minister of Finance, Mr Owen Horwood, said yesterday.

Introducing the third reading debate on the Budget, he said the decline in the gold price from a peak of over 850 dollars an ounce in January 1980 to below 300 in June 1982 had naturally had particularly serious implications for South Africa.

This had involved not only the Republic's balance of payments, but also its domestic economy and State revenue.

"Fortunately, however, we were able to read the signs reasonably correctly and took early corrective action in the shape of our policy of 'consolidation and adjustment'.

## 'Not easy'

"The adjustments we had to make were not easy, and the policies we applied were not always popular, but they certainly proved effective and today we are reaping the benefits," Mr Horwood said.

The gold price remained relatively weak, however, and had shown considerable volatility in recent months.

"The main reason for the relative weakness of the gold price is clearly the process of disinflation which has persisted in the main industrial

countries during the year.

"The major successes scored by many of these countries in the fight against inflation must be welcomed by all of us in the Western world.

"In the long run, strong and stable currencies in the leading Western countries must redound to the benefit also of South Africa.

## Delay

"But in the short term, it clearly serves to depress the gold price and to delay our next domestic economic upswing," Mr Horwood said.

The volatility of the gold price was also making the task of the monetary authorities more difficult.

"It not only has a direct effect on the current account of the balance of payments and on domestic monetary conditions, but also affects expectations regarding the likely appreciation or depreciation of the rand in terms of other currencies.

"These changed expectations produce sharp and substantial changes in short-term capital movements into and out of the country."

Mr Horwood said the balance of payments position and outlook, however, remained excellent despite the volatility of the gold price and the foreign reserves, and notwithstanding the reduction in exports and the increase in imports brought about by the drought. — Sapa

ky tr  
dy

# SA needs consistent rise in gold price

79  
2004  
27/7/83

By SI

By BRENDAN RYAN

Mining Editor

"If Government caus jury then it should co state the victim How this is not a matter for t port policy but for race cy and, if there is to subsidy, it should be adr tered and paid for by th partment concerned. ne Co-operation and De ment or Community I opment -- whichever sponsible for the sp dlocation of the t concerned"

His argument was sug ed by Mr Paul Brownin Mr Rodger Smith, o National Institute for T port and Road Research said there was evidenc large degree of unhap; about the services prc for the black commut

"The dissatisfaction fests itself in the aston growth of the taxi and services between black ships and urban centra ness districts.

"These will custo charge up to three tim subsidised bus fare at presumably -- since th mostly owner-driven - produce a profitable r

The reaction of ansport was that th vate operators should oist, tightly regula preferably legisla of existence. The G ment's attitude wa lear, but it had been i e in a speech by the or-General of Tran ho had said that tax ombis ought not to ed to pick up an ssengers along autt - routes

Dr Petrus du Toit, SIR's transport ar eup, agreed that pas idies were being t ransport policy-mak chieve socio-pol

THE gold price must accelerate consistently to sustain economic growth, says a study by Dr Gadd Ariovich, senior economist for the Chamber of Mines.

"As a continually rising gold price cannot be expected to last for ever, economic activity in South Africa will probably continue to be strongly cyclical in nature irrespective of movements in the gold price."

Dr Ariovich has used an econometric model to analyse the impact of gold on the South African economy and his findings are reported in the Chamber's March-June newsletter.

The model is run initially with a specific gold price and again with the gold price increased by \$100 an ounce,

keeping all other factors the same

In the model the gold price is increased by \$100 an ounce in the first year and in the second year

Dr Ariovich says gold influences economic activity through many complicated and interrelated channels and groups his findings under monetary and fiscal aspects, fiscal aspects and real economic aspects.

Monetary and fiscal: According to the model an increase of \$100 in the annual average gold price will give South Africa additional export revenue of \$2 300-million.

This will have a direct effect on the current account, increasing the foreign-exchange reserves and liquidity in the economy

The enlarged liquidity will reduce short-term interest rates. The study indicates that on an annual basis a \$100 an ounce increase in the gold price will reduce the annual rate on three-month bankers' acceptances by 2.25%.

The prime overdraft rate will not change immediately, but will fall about three months later by 1%, and six months later by 2%.

On an annual basis the prime overdraft rate will drop by 1.25%.

Long-term interest rates in the capital market are much less sensitive to fluctuations in the gold price, the study finds.

"This can most likely be explained by long-term inflationary expectations as an important determinant of capital market rates," says Dr Ariovich

A rise of \$100 an ounce in the gold price increases the narrowly defined money supply by only R78 200 000 in the first year, R372-million in the second year, R668-million in

the third and R176-million in the fourth year.

"These empirical findings suggest that the main effect of this higher gold price on the money supply can take as long as three years."

He says it appears that an increase in the gold price does not necessarily cause strong inflationary pressures as long as the rand is allowed to appreciate.

"However, there are moderate effects which may take as long as four years to manifest themselves"

Fiscal effects: For these sections of the experiment Dr Ariovich specified exact limits, raising the gold price from \$450 to \$550 in the first year and from \$495 to \$595 in the second year.

On this basis the South African Government would gain additional receipts of R450-million in the first year and about R400-million in the second year. They would be affected by the appreciation of the rand

This means the Government deficit before borrowing should be reduced and the lower Government deficit would in turn reduce inflationary pressures and possibly capital-market rates

Real economic aspects: The model shows a \$100 rise in the gold price will increase the growth rates of the gross domestic product by 0.15% in the first quarter, 0.57% in the second quarter, 1.04% in the third and 1.51% in the fourth

On an annual basis the higher gold price will contribute in the first year an additional 0.82% to GDP.

In the second year the \$100 increase will stimulate growth by 1.71% in the first quarter, 1.52% in the second, 1.13% in the third and 0.63% in the fourth

This is an annual GDP growth of 1.24% in the second year, but in following years the impact of the gold-price rise drops substantially

"These empirical results suggest that the main effect of such a gold-price increase on GDP will take place with a time lag of about 15 months," Dr Ariovich comments

Private consumption on an annual basis is also affected and should grow by 0.96% in the first year and another 1.09% in the second year

"It appears the main effect of the gold-price rise on private consumption operates with a time lag of about a year."

One of the strongest real economic effects of a \$100 annual rise in the gold price will be on investment. Gross fixed investment will increase by an average of 1.09% in the first year and 2.5% in the second year.

"It appears, according to the model, that as long as 16 months can elapse before the main effects of a higher gold price on the country's gross fixed investment are fully realised"

Wage and salary increases are also affected, but not in the short term. A time lag of up to 30 months may occur before wages respond to an increase in the gold price



## WATER IS LIFE



Why pay for water Borehole water costs nothing and beats water restrictions

Whether you require water for industrial purposes, for irrigation or for your swimming pool, we have a pump to suit you.

### GARVENS

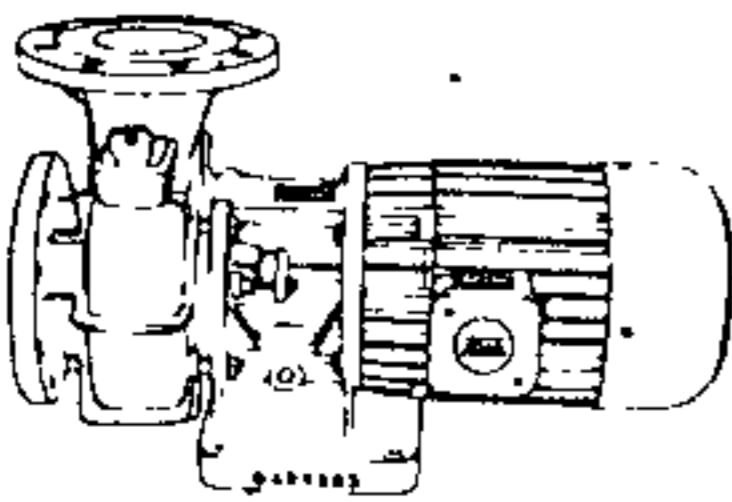

We supply, install, service and...

### JAGUARS

1981 XJ6 Series 3. Platinum with cloth	
37 000 km.....	R35 000
1980 XJ6 Red. 61 000 km.....	R22 000
1980 XJ6 White.....	R19 950
1979 XJ6 Sapphire blue.....	R16 950
1978 XJS RED IMMACULATE.....	R29 500

TERESA P...  
1983-1984

## The new The best of efficiency

How to continue performance on while decreasing tion on the other challenge faced engineers. BMW the solution lies employing advan to perfect what sidered superior engineering.

Consider the fuel injected M10 new 735i. Which greater responsi

september 9 1983

Financial  
Mail

GOLD

# Break - out imminent

An end to gold's long winter of price consolidation seems just as far away as ever. Or is it? At first glance it certainly appears to be the case, judging from the metal's response to the Korean airliner incident. Three years ago an event which perceptibly heightened world tension would have been followed by a major gold price surge. Today it seems that even the outbreak of nuclear war between the super-powers would be accompanied by no more than a hiccup in the gold price.

There is nothing surprising in this. From a chartist's viewpoint gold is in a major consolidation phase. And as the futures markets, which are so influential in determining gold's price level, are largely guided by chart considerations, gold remains locked in a narrow band around \$420. It has been there for six months and the way things are looking it could very well spend another half year in the same channel.

Except that there are fundamental forces at work which are likely to propel gold out of its lethargy soon.

Quite simply, gold is the dollar's inverse and, as long as investors believe the dollar and dollar investments offer good value, the price of gold will remain hamstrung. In other words, if we can decide when the dollar is to lose its attraction, we can define when gold will leave its consolidation area.

In a nutshell, investors perceive the dollar and dollar investments to offer good value because of the currently high level of real US interest rates and the dollar's own strength. Which is all very well until the realisation dawns that US interest rates are high for the wrong reasons.

No one disputes the inevitability of high interest rates as a result of policies aimed at dampening demand and reducing inflation rates. Conventional economic theory says that sooner or later the US economy will move into a period of cyclically low inflation, rates will fall and that this will stimulate economic growth.

The difficulty with this is that US inflation is now down to about 3% and yet real interest rates are at historic highs. The reason lies in the persistently rising US budget deficit — something Ronald Reagan promised to reduce — and the means by which it is being funded. Government is competing with the private sector for funds just as private sector demand for money is increasing. For the present these funds are largely being sourced from foreign lenders attracted by high interest rates and the accompanying strength of the dollar. The fact that foreigners want dollars helps feed the entire cycle of high rates, and a highly valued dollar.

Measured by the Morgan Guaranty index, the dollar has risen by 30% since late-1979 and, after adjusting for relative inflation rates, the American currency is at its highest level for over a decade.

The crunch will come when the US finds itself on a debt

treadmill. The deficit is rising and the cost of servicing the accompanying government borrowing is increasing at the same time. Unless the US authorities can work a miracle — something which is unlikely in the run-up to next year's presidential election — the only easy way out of the debt treadmill will be by monetising the federal debt. That means borrowing from domestic banks and accepting the major increase in money supply, and probably the inflation, this will elicit.

The outcome, as US money supply growth outstrips that of the other OECD countries, will be a sharp correction in the dollar measured against other world currencies and, most importantly, against gold.

The question remains, of course: When?

Investors have grown so inured to a flat gold price that expectations of a steady continuation of the situation are inescapable. Except that the US is up against one factor which it alone cannot control — its trade deficit. Last year America notched up a merchandise trade deficit of \$36,3 billion — its largest ever. It was offset to an extent by an invisibles surplus of \$28,2 billion.

But what is worrying is the fact that America could run such a large merchandise deficit in a year of recession when, had things been normal and weak domestic demand cut imports, the merchandise trade balance should have been running in the country's favour. This year the situation will deteriorate. The economic recovery and the strong dollar are combining to suck in imports, while the dollar's strength has already helped cut manufactured exports by 15,6% in the first half of this year.

Eventually, the American trade deficit will scare foreign holders out of dollar deposits. And they will become doubly scared if US money supply increases are accompanied by falling interest rates. At present, we have the paradox of greater-than-expected money supply increases leading Wall Street to push up interest rates because of fears of future inflation.

This syndrome has to break. We believe it will be sooner rather than later and that the dollar is set for a major rapid downward correction against other currencies and gold. The trigger could well be an easing of monetary constraints by the US Federal Reserve to bankroll the budget deficit.

It is always easier politically to take a soft line to boost the economy and employment as the presidential election bandwagon gets under way. This seems inevitable, even if it is accompanied by higher inflation rates, later this year or early in 1984.

The gold price target? In round figures the dollar faces a correction of 20% or so and that implies a gold price of just over \$500/oz. And this does not take into account the snowball effect of the further price rise expectations which will accompany gold's escape from its present constraints.



# Forced to love thine enemy

off

79

South Africans may view with alarm the prospects of the emergence from the US Congress of a Bill which will effectively block much of our access to International Monetary Fund (IMF) credits. There may, however, be another, and sunnier, side to the matter.

Should the Bill, which deals with a US\$8,4 billion increase in the American quota in the IMF, fail to pass, the Fund will be faced with a real crisis.

Should the American quota increase not

be forthcoming, other major industrial nations will also resist putting up new resources. The Fund is already stretched to the limit and has frozen all loan negotiations.

Now, according to a senior US Treasury official who requested the FM not to disclose his identity, the best option left to the Fund is to mobilise its gold reserves as collateral for borrowing on the international markets.

This source, who is a member of the

American delegation at the meetings in Washington this week, suggested that the Reagan administration would not oppose such a mobilisation of IMF gold reserves although Treasury Secretary Donald Regan did say recently such gold backed bonds might be preferable to US Treasury Bills and, therefore, not all that welcome in official Washington.

The irony, of course, is obvious. The IMF has over the years done all in its power to

*continued on P34*

Financial Mail September 30, 1983

off 79

FM 30/9/83

demote the role of gold as a monetary instrument. It created its own currency, the Special Drawing Rights (SDR) which became known as paper gold, and embarked on an ill-fated scheme in the Seventies to offload bullion onto the world markets. The bullion sales programme was a flop while the SDR is today looked on with deep suspicion by the Americans and other Western powers as a prime source of inflationary monetary creation. In fact, new creations

of SDRs were vetoed in Washington this week.

Now the IMF faces the prospect of being forced to recognise that gold may well be its saviour. It sits on some US\$40 billion worth at current prices, which is well above the quota increase of US\$32 billion now being negotiated.

Such use by the IMF would be recognition of gold's role as a prime reserve asset in an uncertain world.

Right now the matter is in the balance. Should the quota bill be passed with amendments curbing access by SA and communist countries, then the IMF would have been transformed into a political instrument with its monetary independence destroyed.

The Reagan administration may well resist that outcome and the result could be a resort to a gold standard by the metal's sworn enemy.

CC

# Shares plunge as gold drops

*Capt. Times 4/10/83* (79)

**Own Correspondent**  
**JOHANNESBURG.** — Hundreds of millions of rands were wiped off the value of shares on the Johannesburg Stock Exchange yesterday as gold fell below 400 dollars for the first time in a year.

However, Mr Owen Horwood, Minister of Finance, and his chief South African financial policy-makers remain confident that the gold depression will prove only temporary.

If the gold price setback should worsen and this should prove lasting, it would almost certainly delay the country's economic recovery.

Interest rates could also come under further upward pressures.

Yesterday was the

third Stock Exchange "Black Monday" this year.

The financial rand was abolished on February 7 and heavy profit-taking and selling by overseas investors forced share prices down.

On February 28, the gold price fell from \$464,75 to \$408,50, again forcing share values down.

The Rand Daily Mail gold share index plummeted to 748,1 yesterday from 973 three weeks ago.

● Full report, page 18

\$16,50 drop from Friday's close

# Gold plunges through \$400 level in London

CAPE TIMES 4/19/83

79

Own Correspondent

JOHANNESBURG. — Gold crashed comprehensively through \$400 an ounce in London yesterday for the first time in almost a year.

There were no new factors in the market yesterday, and the fall was a continuation of last week's easier trend which resulted in New York testing \$400 on Friday, and the price breaking below that level in Hong Kong earlier yesterday.

The last time gold fell below \$400 an ounce in London was October 5, 1982, when gold was fixed at \$390,25 an ounce.

In London gold was fixed at \$393,50 yesterday morning and slid further to an afternoon fix of \$389 an ounce, before rallying slightly to close at \$391/\$391,75.

## Selling

Friday's second fixing was \$405 and gold closed at \$406,75/\$407,25 in London on Friday.

Heavy technically-prompted selling outweighed the influence of an easier dollar, which under normal circumstances would have

## Closing gold prices

(In \$ an ounce)

LONDON:

391,00-391,75

Fixing am: 393,50

Fixing pm: 389,00

ZURICH:

390,00-393,00

— Reuter

boosted the gold price.

Overshadowing the market has also been a variety of poor fundamentals, ranging from a potential oversupply situation caused by heavy selling from South American countries to the perceived diminution of gold's role as an inflation hedge.

The Johannesburg Stock Exchange was the scene of frantic selling of gold shares, with offers flooding in from everywhere and no bidders.

Other reaction to the gold slump was the dramatic last-minute postponement by Escom of a R100m loan issue.

Lists for the issue were to have opened today, but a spokesman for Standard Merchant Bank, the lead bank with Senbank, said the decision to postpone the issue had been taken because the sharp drop in the gold price would cause uncertainty in financial markets.

In an interview with NEIL BEHRMANN in Washington after the International Monetary Fund meetings Dr Chris Stals, senior deputy governor of the Reserve Bank, said the Bank

would support the rand if gold cracked \$400.

He said the Reserve Bank would sell large quantities of dollars to support the rand rate if gold dropped below \$400, and the intervention would keep the rand from sliding too far.

Dr Stals predicted then that in the event of gold falling below \$400 it would soon recover, as physical demand improved at lower prices.

He stressed that the exchange rate was not entirely dependent on gold, as there were other exports and the bank could raise short-term credits.

While the main reason behind gold's slump was seen as technical reaction to last week's sharp declines, an easier silver price was also a major factor.

The declining trend in London followed price falls in New York and the Far East, where gold closed in Hong Kong at a bid price of 397,50 dollars.

Trading was active in all the bullion markets yesterday, with heavy liquidation and stop-loss selling triggered by the move below the chart support area around \$400.

## Weakness

Gold's weakness had been established in New York and Hong Kong at the weekend, and the failure in Hong Kong early yesterday to sustain a brief rally above \$400, triggered heavy stop-loss selling in early trading in London.

There was some short-covering in morning

trading in London as operators waited for New York's reaction.

After the Comex opening, where futures dropped to their lowest level since February, further liquidations hit the London market and the price dropped below \$387 briefly before recovering slightly to the afternoon fix of \$389.

The gold slump followed Friday's news of a \$2,3 billion jump in the United States M-1 money supply, high Federal Fund levels and an increase in one big United States bank's broker loan rate.

In spite of some bullish factors recently, gold has resisted breaching the established \$420 ceiling, and selling was encouraged by the large United States M-1 money supply increase, with downward momentum increasing as the price broke below \$400.

## Gold reserves

Seeking reasons for the metal's decline, some dealers cited rumours that heavily indebted developing countries — such as Brazil — might eventually sell gold reserves, but most agreed there was no evidence that such sales were in the offing.

Some dealers were surprised by the weakness of gold at a time when the counter-attractions of the dollar were not so obvious.

The dollar was generally weaker yesterday after running into some profit-taking on signs that the United States economic recovery might be slowing.

The consensus among dealers was that the gold price could edge lower by up to \$20 over the next couple of weeks before rallying back to \$400.

"We are really teetering on the knife's edge," explained one dealer.

# Gold price knocks Anglovaal gold mines

CAPX Tent 19/10/83  
79

Own Correspondent

JOHANNESBURG. — Eastern Transvaal Consolidated Mines and battling Loraine were the best performers of Anglovaal's gold mines in the September quarter, although their results were not outstanding mainly because of little change or only a marginal increase in the gold price and continuing cost rises.

The flagship, Hartebeestfontein, reported a 17 percent drop in earnings a share after capex, following a drop in working profit and after-tax profit because of slightly lower tonnage, higher costs and lower revenue an oz. Added to these factors, the mine received lower non-mining income and profits from uranium and acid sales were lower.

### Lower tonnage

There was one working day less in the quarter than in June and this was responsible for lower tonnage milled at Harties and Loraine but ET Cons achieved a small increase.

Village Main reduced its costs by 18c a ton and cost increases at the other mines were well contained, especially in view of the fact that they were subjected to the effects of higher wage bills for the full quarter. These increases only became effective in the last month of the June quarter.

Increased tax charges at ET Cons and Village Main were mainly responsible for lower after-tax profits.

Hartebeestfontein: Although tonnage was marginally lower, grade was higher at 10 g/t (9,8 g/t) so that gold production increased to 7 584 kg (7 485 kg).

In spite of lower tonnage and higher wages, unit costs were well contained but the rise in these costs was greater than the rise in unit revenue which led to a reduced unit profit of R80,36 (R81,16) a ton.

Working profit was R61,157m (R62,250m).

Profit from uranium and acid sales was almost halved at R3,309m (R6,577m).

### Royalty payments

Non-mining income decreased to R4,569m (R6,435m) — largely because of an under-provision for interest accounted for in June — and net royalty payments rose to R1,302m (R1,070m).

With tax at R31,941m (R35,918m) the final profit was R2,398m lower at R35,461m.

Capital spending was fractionally higher at R15m, while outstanding capital spending commitments at the quarter's end were R25,785m (R29,795m).

## Gold steady at \$397 Money market

LONDON. — Gold closed at \$397, little changed from yesterday morning's opening but up from Monday's close of \$394,50-\$395,25.

Dealers said there were no special features in yesterday's market. Most participants were sidelined in a nervous

Development values for gold were 1 502 cm g/t (1 398 cm g/t).

ET Cons: Grade rose strongly to 10,4 g/t (9,2 g/t). With total revenue rising to R11,483m (R9,757m) and costs of R5,494m (R4,802m), working profit rose to R5,989m (R4,955m)

Prospecting expenditure was cut one-third to R928 000 (R1,367m). Tax totalled R77 000, but in the June quarter there was a tax credit of R2,324m because of provisional tax overpaid in the first half of the financial year — based on the profits at that time and lower capital spending

### Increase in tax

Because of this increase in tax, the after-tax figure decreased to R5,069m (R5,887m).

Capital spending totalled R4,049m (R6,476m) with outstanding commitments being R5,332m (R3,715m).

Development values averaged 1 282 cm g/t (1 162 cm g/t).

Loraine: Mill throughput was 11 000 tons lower at 389 000 tons — partly because of the shorter working quarter — but the grade rose to 5,7 g/t (5,4 g/t) and this led to higher gold production at 2 227 kg (2 178 kg).

In spite of the lower tonnage, unit costs were well contained at R75,73 (R74,18) a ton.

Combined with increased revenue, this led to a 57 percent improvement in unit working profit of R11,64 (R7,41) a ton, giving a total working profit of R4,526m (R2,964m)

### Insurance claims

Non-mining income was lower at R49 000 (R719 000). The June figure was boosted by the receipt of two insurance claims.

Outstanding capital commitments at September 30, were estimated at \$4,8m (R7,344m).

Development values were down. A total of 1 282m (1 655m) was sampled on all reefs. The average value was 7,7 g/t (12,2 g/t), which over a width of 68 cm (64 cm) was equal to 528 cm g/t (778 cm g/t).

Village Main Reef: Sands treated decreased to 171 800 tons (182 400 tons) but the average yield was unchanged at 0,62 g/t

Because of the lower tonnage, unit costs decreased to R7,90 (R8,08) because working costs on this property are heavily and directly affected by the cost of chemicals used.

Unit revenue was fractionally lower, leading to a unit profit of R1,40 a ton (R1,25) and a total working profit of R240 000 (R229 000).

After deducting tax of R104 000 (R21 000 credit), the after-tax profit was reduced to R187 000 (R299 000).

JOHANNESBURG. — Three-month and shorter money market rates edged higher, with the key 90-day liquid bank acceptance rates lifted 10 points yesterday morning to 16,35 percent from Monday's 16,25 percent, but rates on longer-term paper held steady. Trading was dull after

### offices

as offices group to o finance can com- major mar- reighn ex- ation was ted in the — South K and the — and the nings from nge oper- ecreased by ast year.

one of the y Nedbank such an ex- on total use trading al services income and end on the

has always rressive ra- profits as a of share- ds

it achieved o of 27,2 per- red with 22,8 e previous 3 percent in

had a cap- of R131m at he year com- h R110m in led R61m to ed reserves. sts that the the elbow he advantage

Comment: Nedbank will certainly be a difficult act for the other major banks to follow Mr Abrahamsen said that interest on current account cost the group R20m; the cost must have been considerably greater for Barclays, Standard and Volkskas with their more extensive and expensive branch networks.

But these banks too have been offsetting these additional costs by increasing fee income and by more intensified participation in the financial and foreign exchange markets. How successful they have been will be revealed only when their next accounts are published.

### Competition

But one point is clear competition in the profit areas is increasing with all the banks offering additional services and expertise — which means increasing benefits for customers at competitive rates.

Nedbank has enjoyed a preferential rating on the Johannesburg Stock Exchange with a yield of 4,1 percent. The increased dividend will take the yield to about 5,1 percent, which means that the share should react favourably today.

## Wall Street

NEW YORK. — A broad decline in stock prices accelerated in afternoon trading yesterday, with blue-chip issues particularly hard hit.

Auto, mining, computer and financial issues were also numerous among the declines.

The Dow Jones average of 30 industrials, off less than six points at mid-afternoon, showed more than a 16-point loss half an hour before the close.

Signs of strong economic expansion and continued moderation in inflation have encouraged traders.

### Money supply

On Monday, the Federal Reserve Board said United States industry operated at 78,1 percent of capacity in September, the highest rate of factory use since October 1981. But interest rates remain persistently high, in spite of a slowdown in the growth of the United States money supply.

And with the Dow Jones industrials having hit a new peak last week, many institutions and other investors are currently seen taking

ed

tax i with lowa tax l Th cons enjo mon with taine 1984 cons unde nomi

### Ext

An of R: howt costs sever olds Re: relo const suffe unpr rates ity ir dustr Gro incre isfact comp how iary, obtai more

### Ra

### ag:

JOH The chan, the c day's after tiall, \$0,89:

The high at on able dolla by tl stem and unit closin Thi ing tures Ag: cies t US, UK We 2,308: Swi Net Fra Jaj Reut

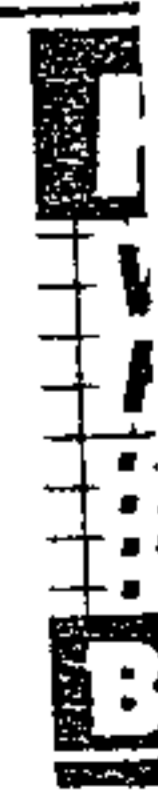

Lower grade and gold price knock Gencor mine

# W R Consolidated Mines show operating loss

By BRENDAN RYAN

JOHANNESBURG. — West Rand Consolidated Mines has started losing money again as a result of lower grade and the slide in the gold price.

The September quarterly results for this Gencor-controlled marginal mine near Krugersdorp show a working loss of R2,487m (June quarter — R114 working profit) and a net loss of R827 000 (R2,084m profit).

West Rand Cons' gold price received dropped to \$421 in the September quarter from \$433 in the June quarter.

If the gold price for the present December quarter remains at around \$400, West Rand Cons is faced with the prospect of heavy losses unless the mining plan is altered.

## Selective mining

Gencor may be forced to go for selective mining and "pick the eyes" from the mine's ore reserves depending on how future gold price movements are seen by the mining house.

West Rand Cons has shown that it can live happily with a gold price of around \$430 an ounce at current rand/dollar exchange values.

The September quarter's results from this very low-grade producer were affected by five percent drop in grade to 1,7 g/t from 1,8 g/t previously.

Gold production fell by 68 kg to 942 kg.

West Rand Cons still shows profits of R4,612m for the nine months to end September which, after capex of R1,032m, leaves distributable earnings of R3 580m from which an interim dividend of R2,267m has already been paid.

Unless there is a marked recovery in the gold price in the rest of the quarter it seems unlikely there will be a fi-

nal dividend from the company.

Grootvlei also gave problems in the September quarter but these appear now to be under control.

Tonnage milled dropped to 429 000 (481 000) because of problems with the phasing-in of the mine's new treatment plant.

The new milling section has provided plenty of teething problems while the carbon-in-pulp section is not yet working at its designed capacity.

Grootvlei has used a section of the old filtration plant to meet the shortfall.

However, the plant treated 165 000 tons in the month of September, which is the target rate for the expansion programme and hopefully Grootvlei can maintain this performance in the months ahead.

The tonnage not milled has been stockpiled.

Stilfontein had a good operating quarter in September maintaining grade and pushing up tonnage milled to 445 000 (435 000).

## Unit costs

Unit costs rose by four percent which is probably acceptable for the first full quarter after the wage increases for white and black employees.

Stilfontein's unit costs

of R73,76 are high by comparison to other mines in the group because of the amount of ore-sorting carried out on surface to improve grade.

The mine however got clobbered by tax. On pre-tax income of R15,163m (R13,745m) the tax bill shot up disproportionately to R7,392m from R4,723m in the June quarter.

Buffelsfontein had a very good quarter maintaining tonnage milled at 829 000 and raising grade to 9,2 g/t (9,1 g/t).

A drop in tax to R23,642m (R27,420m) left taxed income at R27,567m (R24,409m) and the mine increased its distributable earnings after capex by 17 percent to 144,9c a share.

Winkelhaak also put in a good performance in the September quarter increasing tonnage milled to 595 000 (585 000).

Pre-tax income dropped to R36,432m (R37,501m) but tax dropped further to R20,873m (R23,626m) leaving taxed profits up at R15,559m (R13,875m).

Distributable earnings after capex rose to 106,7c a share from 96,9c a share in the June quarter.

Leslie suffered an eight percent drop in grade to 3,2 g/t (3,5 g/t) which knocked gold production to 956 kg (1 007 kg).

The grade drop is temporary and grade should recover this quarter.

Leslie's pre-tax income was R2,371m (R4,626m) but the mine had a R353 000 tax credit for the quarter (R1,714m tax charge) which left taxed profits only slightly lower at R2,724m (R2,912m).

Marievale increased its distributable earnings to 12,8c a share (7,9c) in what was also a good operating quarter for the marginal producer near Nigel.

St Helena has still to receive any income from the Beisa section which turned in a reasonable performance in the September quarter producing 367 kg (307 kg) of gold and 121,1 tons (105,8 tons) of uranium.

Unisel performed well increasing distributable earnings to 33,4c a share (26,5c) after a solid operating quarter, maintaining grade and increasing tonnage milled.

Kinross was hit by a 14,5 percent jump in working costs to R24,167m (R21,106m) and a higher tax bill which removed any benefits from higher gold production by the mine.

Bracken paid out its distributable earnings of 36c a share in full in its final dividend of 37c a share for the six months to end-September.

Norman Bromberger

Telephone: (033) 63320 Ext. 313

3200

Pietermaritzburg

Address: University of Natal

DEVELOPMENT STUDIES RESEARCH GROUP (DSRG)

## INVESTMENT by Derek Tommey

# Gold share holders face difficult time

W/E PROUS (Bus) 22/10/83  
79

**THESE** are unhappy times for holders of gold shares.

Gold share prices have been sliding for six weeks, losing a quarter of their market value, and there is no sign yet that this is about to end.

Mainly responsible for this week's fall in gold shares was the drop in the gold price to below \$390 an ounce. Although the metal soon managed to climb above this point, there is no doubt that the move has further depressed speculation in the metal.

The September gold mining quarterly reports have also not been encouraging.

Although several mines were able to raise their profits last quarter, in many instances this was the result of lower tax payments as a result of increased capital expenditure.

But as capital expenditure has to come out of profits at the expense of dividends, the increased profits are not really what they seem.

### Inflation hedge

Unfortunately, there is nothing in sight that seems likely to reverse the present downward trend in the gold price. The governor of the Reserve Bank, Dr Gerhard de Kock, indicated this week that it could possibly remain at its cur-

rent levels for a year or more.

He attributed gold's stability to American efforts to keep down inflation which greatly reduces gold's attraction as an inflation hedge.

About the only factor which could help gold was a major international financial crisis following the possible defaulting of its debts by one of the major Third World borrowers. But he added that even this was only likely to have a temporary effect on gold.

### Ray of hope

In saying this Dr de Kock is really offering only a slight ray of hope to investors, for the longer the world has to cope with its international financial problems, the less chance there is that a crisis will eventuate.

Supporters of the crisis scenario maintain that most American banks are overlent to Third World countries and are thus extremely vulnerable to any default, which indeed is so.

They argue that one day Mexico or Argentina or Brazil will refuse to honour their debts and bankrupt many American banks forcing them to close their doors, wiping out people's savings. Therefore to protect oneself against this possibility savers should keep their assets in gold.

It sounds plausible, but would American banks ever be allowed to collapse?

The American government is fully aware of their problems and also the terrible repercussions that would follow were the banking system to go under.

As a result it can be relied upon to take all the necessary action to prevent a banking collapse.

Had there been a default a year ago and the American government had been caught by surprise and unprepared it is possible that their might have been a banking crisis then.

But now that the American authorities have had a year to draw up contingency plans, the likelihood of anything serious occurring seems extremely remote.

### Protection

The fact is that no American government could ever consciously stand by and allow a debt default by a Third World country to bring down its banking system and seriously disrupt its economy.

Which means that investors will have to accept that a major change has taken place in the investment scene.

There are a few other changes nearer home that investors will also have to look out for, following the apparent change in the Govern-

ment's attitude to the protection of industries.

Since 1925 it has been Government policy to stimulate industrialisation by offering protection to import-replacement industries.

### Productivity

As a result South Africa has built up a fairly large industrial base. However, while this policy was highly successful in its early days, it has become less so in recent years and has begun to cause great concern in official circles.

It has been found that the productivity of recently established enterprises was below that of older established ones, mainly owing to the small size of the local market. This means large sums of capital are being invested wastefully.

It has also been found that many of these enterprises are heavily dependent on imported raw or semi-processed materials, so accentuating the balance of payments problems.

### Competitiveness

On top of this the protection given these enterprises has resulted in a general increase in costs in South Africa and lessened the competitiveness of South African goods in overseas markets.

Finally, there is evidence that the policy of establishing import re-

placement industries has not led to the job creation expected as entrepreneurs had tended to go for capital intensive projects.

Summing up, the conclusion has been reached in official circles that this import-replacement policy is now constraining the economy more than stimulating it.

So a new policy is in the making. It is planned to stimulate export industry which will earn foreign currency, ease the country's balance of payments problems, and allow the authorities to follow a more expansionary economic policy.

A policy of fostering export industries, therefore, should generate growth rather than restrictions.

Just how this will be achieved remains to be seen. But there have been hints that protective tariffs could be reduced and competitive foreign goods could become more freely available.

It is still early days and there is as yet no clear indication as to how the new policy will be applied or what its effects will be. But there does seem grounds for suggesting that investors start exercising some degree of caution when investing in local manufacturing concerns.

Brighter outlook for S African economy as metal soars \$25 in

# Gold Notice Sur

ARGUS 29/11/83 ● 79

Financial Editor

**SOUTH AFRICA'S** economic prospects have suddenly improved after a sharp increase in the gold price in New York.

After hovering around a 1983 low of \$375 for the past 10 days, the gold price soared \$25 in New York last night to hit \$400 an ounce before easing back to \$395 an ounce.

In London today gold was trading at \$391.25 an ounce — a drop from last night's peak, but still \$16 above Friday's closing price.

Dealers in the Hong Kong market expect gold to continue its current upturn on follow-through buying in European and United States markets, reports Sapa-Reuter.

## Shares rallied

Gold shares rallied on the Johannesburg Stock Exchange at the news of the higher gold price to show gains of 100c and more.

The rise in the price will be welcomed by the gold mines and the authorities as it suggests the fall in the price, which started in February, may now have come to an end.

The possibility of a further drop in price has been worrying the gold-mining industry as not only would it have led to lower profits but at some mines it could have endangered production.

The higher price is good news for the Government as it reduces the threat of diminishing tax revenue and a deterioration in the balance of payments.

Dealers can give no concrete reason for the jump in the price, but some believe it may have been stimulated by the theft of three tons of gold from a London warehouse at the weekend.

In the past few weeks gold has been technically



## 1984 is a Leap Year — jump to it with The Argus calendar

**ON FRIDAY** The Argus, the paper with something new, something extra, something for everyone, brings readers a special bonus... a full colour calendar for 1984.

Don't miss this elegant, colourful souvenir of The Fairest Cape. It's meant for your home, office, study, workshop, classroom. And share it with your friends — send The Argus calendar overseas as a memento of the Western Province's scenic beauty. The calendar contains 12 outstanding pictures, including the three shown here, by our award-winning photographic team. It is a magnificent seasonal re-



We're No 1... Shafiek Sage and Mayoress Mrs Bri

Shafiek misses bus but gets I

By TRISH HANDLEY

found Shafiek had been left behind

# South African economy as metal soars \$25 in price sur

ARGUS 29/11/83 ● 79

Financial Editor

**SOUTH AFRICA'S** economic prospects have suddenly improved after a sharp increase in the gold price in New York.

After hovering around a 1983 low of \$375 for the past 10 days, the gold price soared \$25 in New York last night to hit \$400 an ounce before easing back to \$395 an ounce.

In London today gold was trading at \$391,25 an ounce — a drop from last night's peak, but still \$16 above Friday's closing price.

Dealers in the Hong Kong market expect gold to continue its current upturn on follow-through buying in European and United States markets, reports Sapa-Reuter.

## Shares rallied

Gold shares rallied on the Johannesburg Stock Exchange at the news of the higher gold price to show gains of 100c and more.

The rise in the price will be welcomed by the gold mines and the authorities as it suggests the fall in the price, which started in February, may now have come to an end.

The possibility of a further drop in price has been worrying the gold-mining industry as not only would it have led to lower profits but at some mines it could have endangered production.

The higher price is good news for the Government as it reduces the threat of diminishing tax revenue and a deterioration in the balance of payments.

Dealers can give no concrete reason for the jump in the price, but some believe it may have been stimulated by the theft of three tons of gold from a London warehouse at the weekend.

In the past few weeks gold has been technically "oversold" following sales by speculators in the expectation of a further fall in the price. More gold was sold than was physically available for delivery.

## Rush to buy

When news of the London gold theft became known and the market became aware that the loss would immediately have to be made good, there was a rush to buy as speculators tried to cover their positions.

The resultant jump in the gold price should hold confidence in the gold industry and metal markets as it indicates a considerable shortage of physical gold in the market.

South Africa produces about 22-million ounces of gold a year. A \$25 rise in the gold price boosts income from gold in a full year by about R660-million.



We're No 1... Shafiek Sage and Mayoress Mrs Br

## Shafiek misses bus but gets 1

By TRISH HANDLEY  
Staff Reporter

IT ISN'T everyone who gets a chance to ride in CA 1 — the mayoral car.

But 10-year-old Shafiek Sage of Heideveld managed it with ease.

Seeing two friends aboard a special bus heading for Mayoress Mrs Brenda Kreiner's Christmas party for children last Friday, Shafiek decided to go along too and climbed aboard.

After enjoying himself at the party at the Baxter Theatre complex, he went to the toilet. When he came out, everyone had gone.

Everyone, except a certain "Mevrou Burgermeester", who

found Shafiek had been left behind by the bus.

"We took him home in CA 1 and gave him a meal. Then he watched television," the Mayor, Mr Sol Kreiner, said.

Only then was it discovered he should not have been at the party at all.

"What had happened was that he was not invited to the Christmas party. He saw this bus and children, who said the Mayoress was giving a Christmas party, so he said fine, he would go along too.

"His family had been waiting for him from about 2pm," said Mr Kreiner.



# Chamber finds effect of gold price on trade hard to isolate

By Duncan Collings

Gold export sales account for more than 60 percent of South African mineral exports and for about 40 percent of total South African exports of goods and services.

The Chamber of Mines says in its latest newsletter that the direct and indirect contribution of the gold mining industry is about 25 percent of South Africa's total business activity or Gross Domestic Product (GDP).

Many believe that local business cycles are largely influenced by cycles in the gold price and that gold exports are a leading generator of economic growth in South Africa.

The central role of gold in the South African economy is well recognised by most economic commentators. If not all, Gold influences economic activity in South Africa via many complicated and interrelated channels. It is therefore difficult to isolate the effects of the gold price from a multitude of other factors acting simultaneously.

**DIRECT EFFECT**

Furthermore, an initial direct effect of the gold price is often followed by secondary and more indirect effects which could influence other channels not yet affected.

Monetary and financial variables tend to respond quickly to changes in the gold price. Dealers in the money and financial markets keep constant watch over gold price movements.

Even a momentary change in the gold price is immediately incorporated in their business decisions. Estab-

lished gold price trends tend to influence expectations about the future gold price and these expectations are incorporated in day-to-day deals.

It is therefore not surprising that money and financial markets occasionally react erratically to changes in the gold price.

A 100 dollar an ounce increase in the gold price gives South Africa additional export revenues of 2 300 million dollars.

This will have the effect of increasing the amount of money in circulation in the economy and will reduce short term interest rates.

### LONG TERM

However, long term interest rates are much less sensitive to fluctuations in the gold price. This is largely explained by long-term inflationary expectations.

The main effect of a higher gold price on the money supply can take as long as three years.

It appears that an increase in the gold price does not necessarily create strong inflationary pressures as long as the rand is allowed to appreciate in value against the dollar. However, there are moderate effects which may take as long as four years to manifest themselves.

It is difficult to identify the exact mechanism and channels through which the gold price influences GDP.

The effect of the gold price rise is diffused through the real economy via the working profits of the gold mining industry.

These working profits are distributed between dividends which encourage pri-

The influence of the gold price on the South African economy

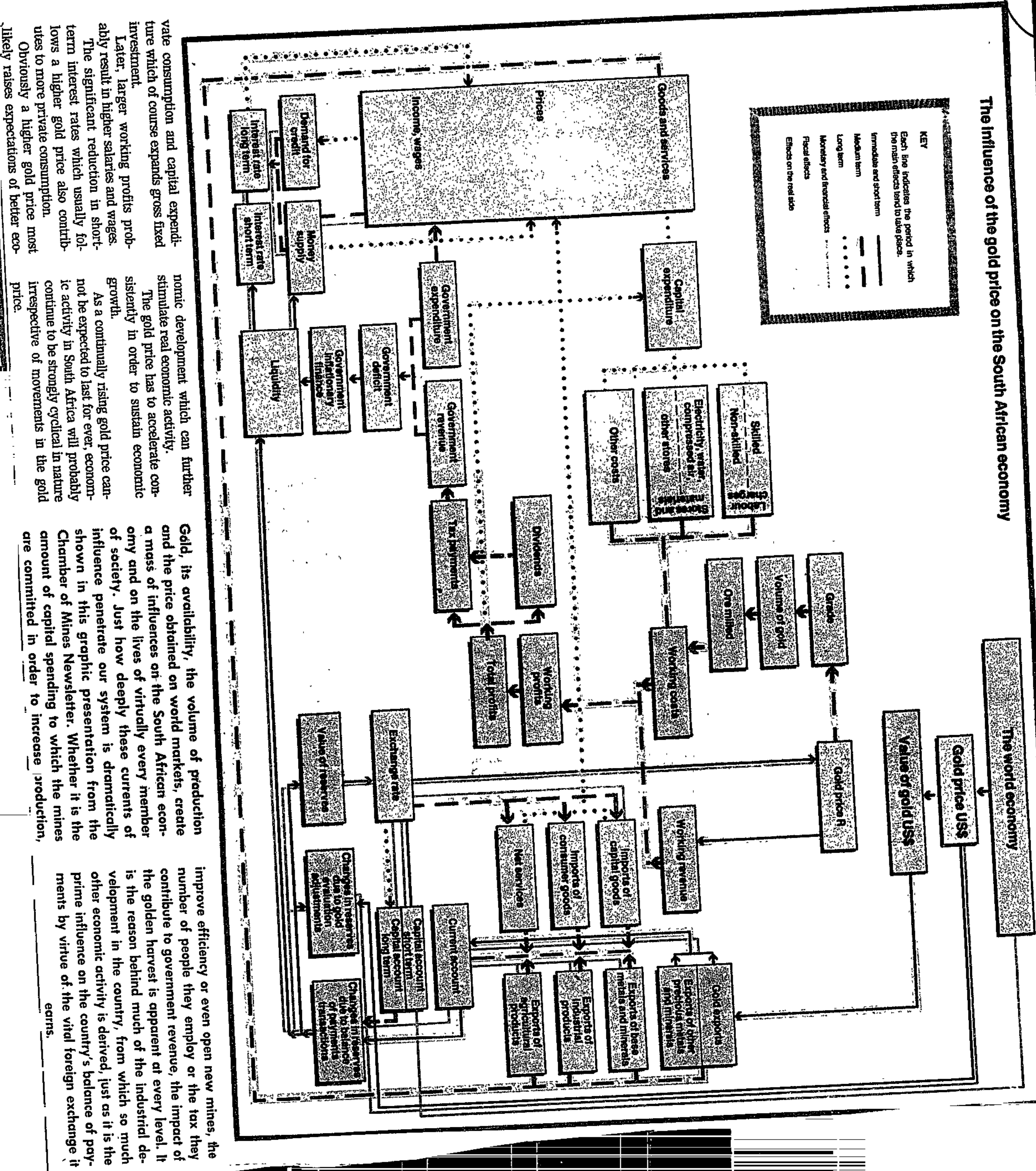

value consumption and capital expenditure which of course expands gross fixed investment.

Later, larger working profits probably result in higher salaries and wages. The significant reduction in short-term interest rates which usually follows a higher gold price also contributes to more private consumption.

Obviously a higher gold price most likely raises expectations of better eco-

nomical development which can further stimulate real economic activity.

The gold price has to accelerate consistently in order to sustain economic growth.

As a continually rising gold price cannot be expected to last for ever, economic activity in South Africa will probably continue to be strongly cyclical in nature irrespective of movements in the gold price.

Gold, its availability, the volume of production and the price obtained on world markets, create a mass of influences on the South African economy and on the lives of virtually every member of society. Just how deeply these currents of influence penetrate our system is dramatically shown in this graphic presentation from the Chamber of Mines Newsletter. Whether it is the amount of capital spending to which the mines are committed in order to increase production,

improve efficiency or even open new mines, the number of people they employ or the tax they contribute to government revenue, the impact of the golden harvest is apparent at every level. It is the reason behind much of the industrial development in the country, from which so much other economic activity is derived, just as it is the prime influence on the country's balance of payments by virtue of the vital foreign exchange it earns.

# The great gold cascade

By Roy Assersohn

**LONDON** — The most remarkable quality of gold is not the way it has beguiled mankind over the centuries, nor its beauty or malleability, but the way it has maintained its buying power.

At the beginning of this century the average pay packet of a British worker was equivalent to the price of half an ounce of gold.

Two world wars, the great depression, the abolition of the gold standard, the loss of an empire and inflation have not been able to change that in Britain.

It is the immutability of gold, not as a metal but as a store of value, that has made it

eternally fascinating to all who have or manage money.

That fascination appeared to have set gold firmly on the ladder to climb inevitably, first to 600 dollars an ounce and then, according to many pundits, onward and upward to 1 000 dollars.

But the fascination, and the expectation that the price of gold would keep rising this year, was badly shaken by the extraordinary events in the world's bullion markets over the past week; dealings seemed to go mad and for a while there appeared to be no bottom to the price.

It fell so far and so fast that at one point economic and political pundits were questioning the wisdom of the South African Government in abandoning a two-tier exchange rate for the rand. Those decisions were taken

**While European investors slept through the night, orders left in computers automatically sold bullion when certain limits were reached — and fortunes were wiped away.**

Last month on the basis that gold, which was then trading at around 500 dollars an ounce, would not fall, at least in the short or medium term, below 450 dollars an ounce.

When dealers left their desks and telephones in the two most important bullion dealing centres of London and Zurich last Friday night, that expectation still seemed to be reasonable even though gold had fallen back to 463 dollars an ounce.

Then came the first computer-inspired selling wave ever to hit the bullion markets.

In late dealings in New York last Friday night the price of gold for delivery in March plunged more than 20 dollars.

That triggered what dealers later described as "cascade selling" in the Far East while Europe was still asleep in the early hours of Monday.

The orders had been left in computers which automatically made the sales when certain limits were reached.

The result was the biggest one-day fall in the price of gold as the cascade selling deve-

loped momentum and gold hit 392 dollars an ounce.

The gold markets these days are almost entirely speculative. Huge volumes of speculative trading take place in the Cornex markets in New York where gold is traded on the basis of expected price movements. In this huge active future trading — there were 60 000 deals done on Monday alone — buyers place orders for gold they never expect to receive and sellers place their orders on gold which has never been delivered to them.

The London gold futures market is much smaller but no less volatile. Sophisticated electronic communications have reduced the world — despite differing time zones — into a financial trading village and this in turn has heightened the volatility of markets, including those in which gold futures are traded.

When the over-bought speculators took fright the market soon panicked. There have been few industrial buyers for some time because they either did not want to pay high prices

or they had sufficient stocks, so one selling order cascaded upon another.

The market had begun to look tired a week earlier and with sharp oil-price cuts beginning to appear likely, gold had suddenly stopped looking attractive to speculators.

Cheaper oil was seen as likely to cut inflation rates and thus reduce gold's importance, at least temporarily, as a store of value.

Oil-price cuts also increased the prospect of Middle East producers, always big holders of gold, selling some of their gold reserves to make good shortfalls in oil revenue.

The only certainty about financial markets is that they always overdo both fear and greed. So in the past few days the price of the precious metal has edged back up above 430 dollars an ounce, pulling the

prices of South African gold mining shares with it.

For the South African government the extraordinary events in the bullion markets have, in a perverse way, underlined the fortunate timing of the decision to abolish the two-tier rate for the rand.

Gold is all important to the prosperity of the South African economy. Sales of gold can account for as much as 50 per cent of overseas earnings. In the past when the price of gold has risen sharply, so too has the supply of money and this has helped stoke up inflation.

The events in the bullion markets have shown how lucky Mr Horwood and his colleagues were in being able to announce the measures three weeks ago. It would have been impossible for such a brave step to take place last weekend or this coming weekend.

## How the Zurich gnomes lost out

Own Correspondent

**ZURICH** — The Zurich gold pool is operated by the "big three" Swiss banks — Union Bank, Swiss Bank Corporation and Credit Suisse.

In 1981 the Zurich pool began losing a lot of business, mainly to London but also to other gold centres.

Above all, the two biggest producers, South Africa and the Soviet Union, which traditionally dealt through Zurich, switched their favour to London.

While the Swiss banks still take part in gold transactions handled in London their role is far weaker than it was. The first reason for this was

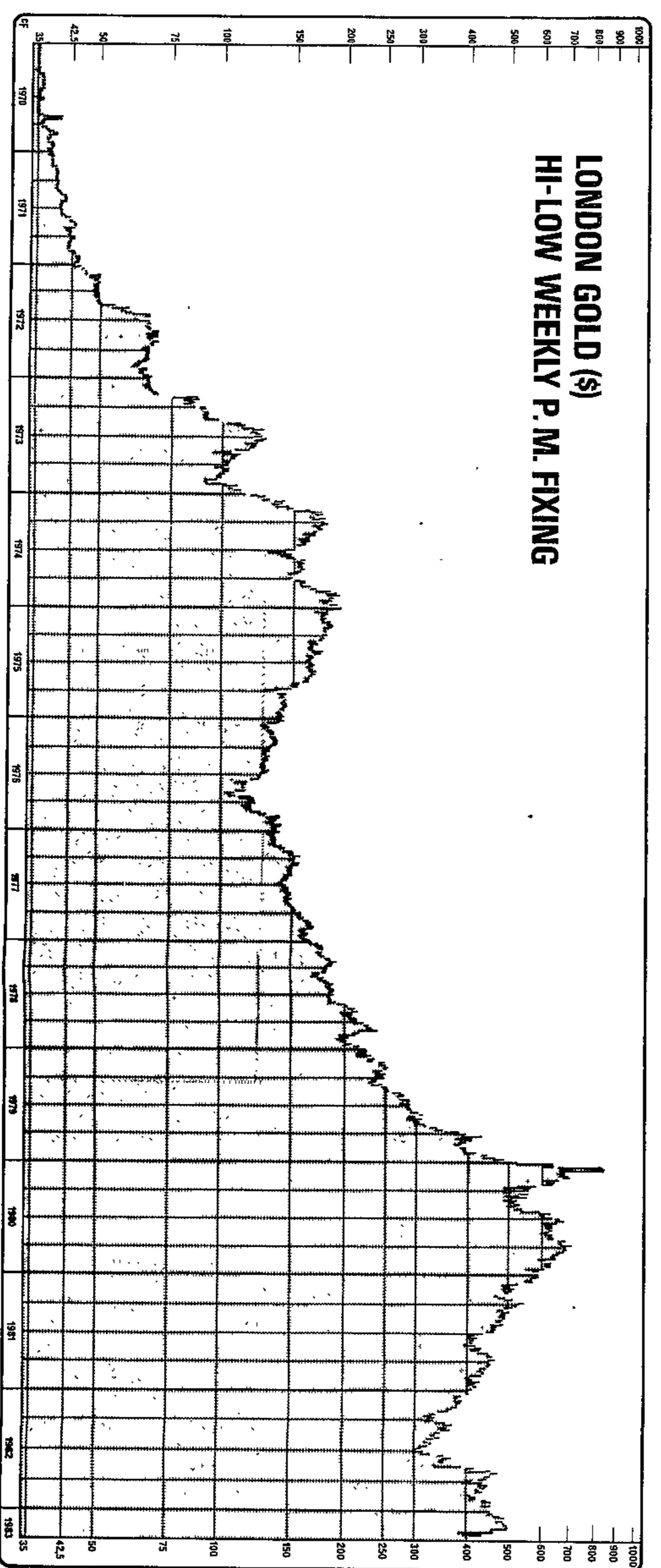

LEFT: At the mine face... getting at the ore more than a kilometre below ground.

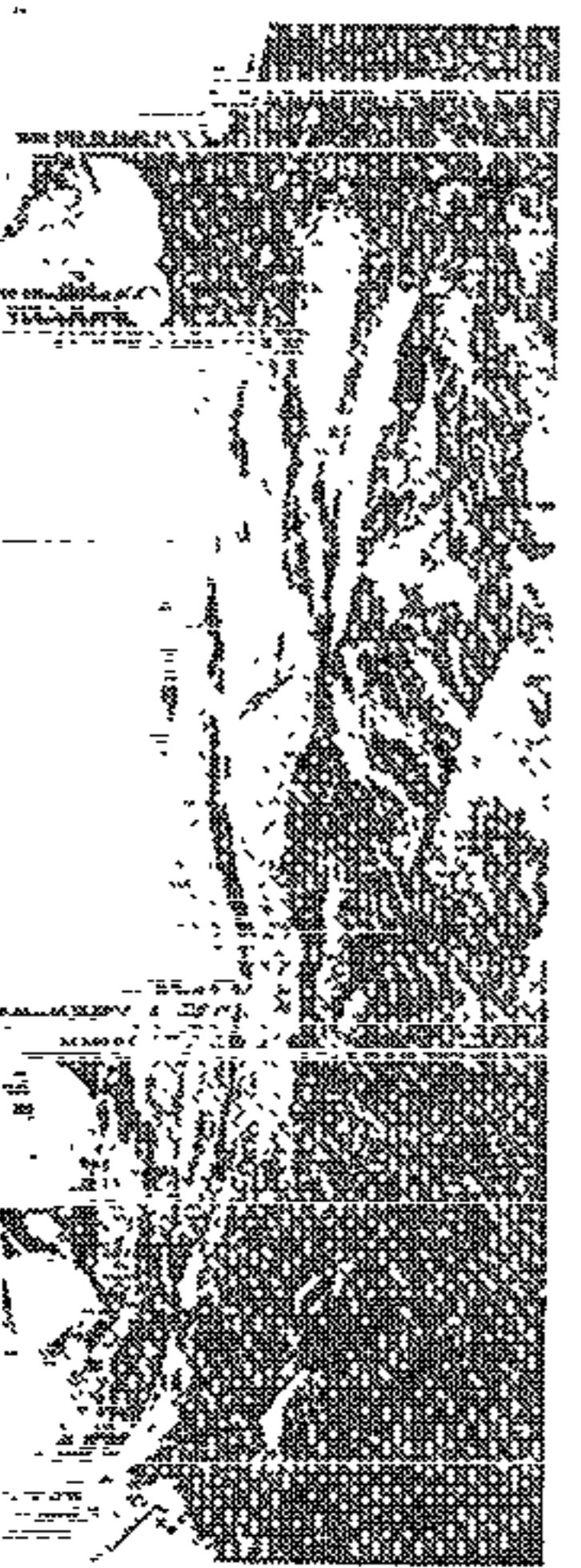

## The legendary foundation of power, status

By Roy Assersohn

**LONDON** — Gold has been the focus of man's greeds and fears ever since it was first washed out of river beds by the ancient Egyptians, with the aid of sheepskins. Over the centuries mines, palaces, temples and graves have been plundered for their golden wealth — resulting sometimes in upsetting the political and economic balance of Europe.

Until the discovery of the new world the amount of gold mined throughout Europe, India and a few other countries was small.

In the Middle Ages the all-conquering Spanish conquistadors ravaged the South American mines, which had yielded a third of all the world's gold until the great Californian and then the Australian gold strikes. These induced a widespread gold madness which lured hundreds of thousands to barren and undeveloped parts of the world.

Nuggets of up to 440 kilos and worth more than R1 million each at today's prices were discovered just below the dusty surface in New South Wales, while in California fortunes were made and just as quickly lost. The last great gold strikes were in the Klondike and the

most gold transactions to London and elsewhere.

It also stimulated a trend towards metal accounts at Swiss banks. These allow investors and speculators to "own" gold on paper without having gold bars in the bank.

Then, for six months, the Swiss Federal Customs authorities published monthly lists of all gold entering and leaving Switzerland, naming the country of origin and destination.

This greatly upset everyone as customers saw the move as a breach of usual Swiss banking secrecy.

Switzerland stopped the monthly lists before the end of 1981 but a great deal of damage had been done.

London now handles about 60 percent of Soviet gold sales. At one time, practically 100 percent of Soviet gold was moved through Zurich.

South Africa now deals with about 20 major bullion banks and brokers worldwide, with around 40 percent of South African transactions going through Zurich compared with about 60 percent before.

# The world's great treasure vaults

By Roy Assersohn

**LONDON** — The biggest storehouses of the world's gold are at Fort Knox in Kentucky and at the Federal Reserve Bank of New York.

At Fort Knox the underground vaults have been built to withstand a direct atomic blast and in New York a large proportion of the world's gold has been re-buried in the sort of rock from which it had been hewn in other distant parts of the world.

Four floors below the busy streets of New York's financial district around Wall Street, a honeycomb of steel-lined vaults has been blasted out of Manhattan's granite. Piled high in these cages are ingots roughly the size of three bars of margarine but weighing about 61kg and worth about R142 000 apiece.

The 13 000 tons of the precious metal is locked behind a 90 ton steel door. It is guarded by a

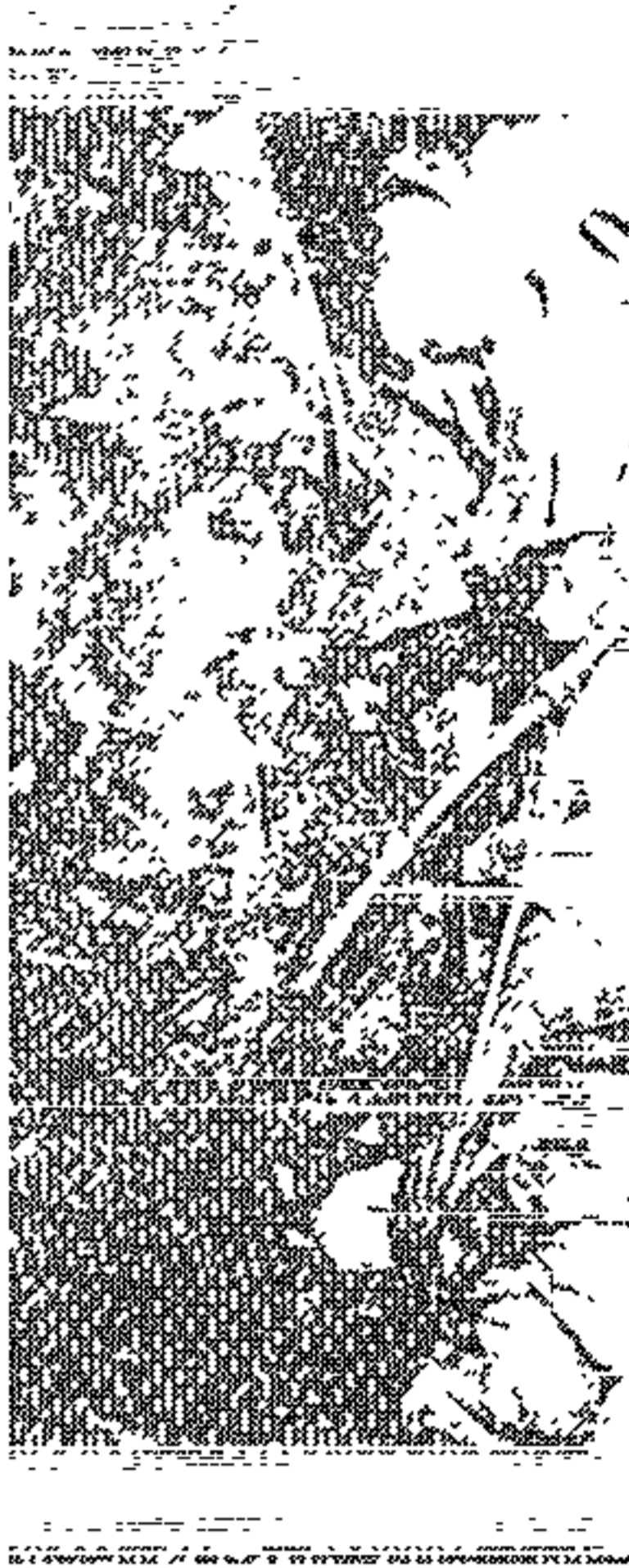

**RIGHT:** In the furnace room... pouring the metal for which thousands have risked their lives.

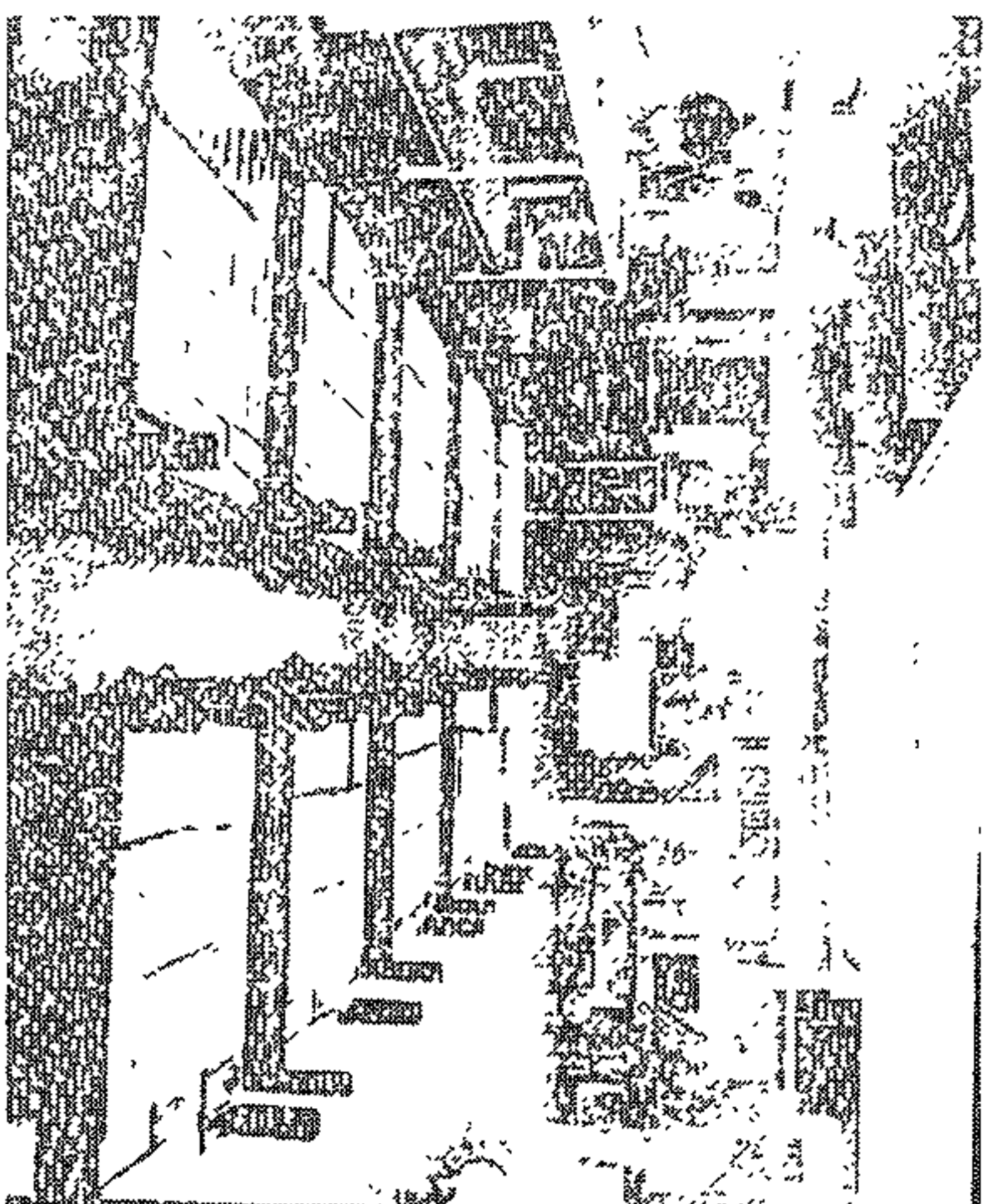

**LEFT:** At the refinery... just one day's production. Each 28 kg bar is worth about R420 000.

**RIGHT:** At the market... lull before the storm. Dealers wait in the London gold futures market.

The treasure of Ali Baba's forty thieves pales into insignificance beside the piles of gold in the world's storehouses. In Fort Knox, New York, London and Zurich, wealth beyond imagining lies beneath the streets.

be so sensitive that its alarms would be triggered by the movement of a fly trapped in the vaults.

The second-largest depository of central bank gold after the Federal Reserve Bank is the Bank of England. Unlike the "Fed", the "old lady of Threadneedle Street" is very much more secretive about its hidden store of treasure.

The Fed's open-door policy allows more than 15 000 visitors a year to inspect the gleaming wealth of nations 25m

below the streets of Manhattan.

By contrast the Bank of England keeps the location of its gold vaults a secret even from many of its own staff.

I am one of the few outsiders ever to be allowed into the gold vaults to see the neat stacks of gold belonging not only to the United Kingdom but many other publicity-shy central banks and other customers.

The ingots are neatly stacked on pallets standing on blue metal legs. They are stacked only to knee-height and are

much less impressive than the mountains of ingots on public view in New York.

Gold is extremely dense and the weight of the ingot piles is kept as low as practicable because bank officials fear for the physical foundations of the famous building which stands over a subterranean stream. If the gold was piled too high, the bank could start falling down.

After the Bank of England, the Swiss banks in Zurich are the most important depositaries for

the world's gold, acting as they do not only for governments but also private investors mainly from the Middle and Far East.

Once stored in these vaults, little of the gold is ever moved. The cost of transportation, security and insurance makes it unviable to shift bullion around these days. Instead, changes in the ownership of gold are done through gold swaps or allocation exchanges.

Such re-allocation is a bookkeeping exercise as a result of the deals done between central banks.

By merely re-allocating ownership by re-belling or physically moving some ingots from one pile to another with a changed entry in the books, governments can use their gold much more efficiently and much more safely than they could otherwise in big transactions.

These deals are invariably done in great secrecy, and outside the two leading bullion markets in London and Zurich. But the prices at which gold trades in these markets are important to central banks and governments. The Bank of England is an active participant in the bullion markets on behalf of its more publicity-shy central bank customers.

Some small and medium-sized countries have been having to sell part of their gold holdings, and the fear that others, including some oil producers, will have to do the same has been a major factor in the recent volatility in the gold price.



## Today in history

1797 — British troops under Lord Lake put down rebellion in Ulster, Ireland.

1857 — Peace of Paris ends Anglo-Persian war, and Shah recognises independence of Afghanistan.

1879 — Sir Owen Lanyon sworn in as Transvaal Administrator.

1944 — Soviet forces launch offensive in Ukraine against Germans in World War 2.

1952 — China accuses United States of using germ warfare in Korea.

1968 — Rhodesian Supreme Court rejects the Queen's reprieve of two Rhodesian blacks sentenced to death.

1979 — China-Vietnam conflict enters third week.

**TODAY'S BIRTHDAYS:**  
Miriam Makeba, SA singer (1932 —)

**TODAY'S THOUGHT:**  
To be ignorant that you are ignorant is a great step to knowledge — Benjamin Disraeli, English statesman (1804-1881).

### VOLUNTARY LIQUIDATION SALE of PERSIAN & ORIENTAL RUGS

**DISCOUNT UP TO 70%**

GB Inc have instructed us to liquidate their entire stocks of hand-made Persian and Oriental Carpets, Rugs and Runners at well below trade and cost prices.

DESCRIPTION	SIZE	RETAIL LIQUIDATION PRICE	PRICE
40 MORI BOKHARA	LARGE	R230	R60
19 JAIPUR KASHMIR	LARGE	R880	R370
30 FINE PRAYER	LARGE	R290	R90
7 BOKHARA	1.84 x 1.22	R1 100	R395
21 KARACHI	1.88 x 1.27	R1 495	R595
10 BELOUCHI	1.20 x .80	R480	R160
25 BABY TABRIZ	1.50 x .87	R480	R190
2 SILK HERKE GOLD THREAD	.99 x .64	R7 900	R2 350
1 SILK KHUM (QUM)	1.54 x 1.10	R11 000	R3 900
2 FINEST ISLAHABAD	1.55 x .97	R1 950	R595

PLUS MANY ANTIQUE & SEMI ANTIQUE CARPETS & RUGS FROM DIFFERENT DOMAINS — SPACE DOES NOT ALLOW US TO ADVERTISE EVERYTHING. NO APROS, NO TRADE-INS, plus/minus 700 PIECES FOR SALE

**9 am-2 pm**  
**Sale continues SATURDAY 5th MARCH**

**AT OUR PREMISES: No 4 FOUNTAIN GATE BUILDING (Ground Floor) 84 MARIA STREET, FONTAINEBLEAU, RANDBURG APPOINTED ADMINISTRATORS — PROTEA AUCTIONEERS 793-5551/5759 CREDIT CARDS WELCOME**

**NB:** This is a genuine sale — goods are in a 100% condition, plus carries a certificate of authenticity.

**DIRECTION:** From Jan Smuts travelling to Randburg turn left into Republic Road, past four robots, near street light into Maria Street (opposite Rubenso Building, Mercedes). From D.F. Malan Drive, right into Judges Ave, first robot left into Republic Road, past Windler Shopping centre, turn right one street before robot.

# Gold price spurts to close at \$403

By PAUL DOLD, Financial Editor

**GOLD** shares rose strongly yesterday as the bullion price breached the \$400 level in the key London market amid rising hopes that a turning point had been reached.

Gold closed at \$403 last night after a late fix of \$405 and the morning's \$405.75.

The key United States futures markets rose some \$8 reacting to the sharp rise in the London price. On the Comex Exchange the February contract spurted to \$411.60.

Analysts said the record trade deficit had prompted new buying from inflation watchers.

## Investors

Aiding the upturn was talk that Middle East investors were heavy buyers of physical gold in London, possibly on an overnight news agency report that a new land offensive by Iran may force Iraq to step up dramatically attacks on shipping and oil installations in the Gulf.

There were sharp gains across the gold board in Johannesburg with heavyweights gaining more than 500c as buyers scrambled for shares.

Kruger rand prices rocketed as well, with the one ounce coin rising some R27 on the SA Gold Coin Exchange and R22 on the stock exchange.

The sudden breakout by gold above the \$400 is good news indeed for the South African economy but the current rise is being viewed with extreme caution.

"There's no rhyme nor reason for it," a leading dealer for bullion brokers Sharps Pixley said.

"There has been buying from all quarters."

Brokers Samuel Montagu said: "Trading has been extremely busy all morning as the market continued the trend that developed on Monday when the metal jumped \$17 on the day. I still cannot see why the price didn't continue its climb Tuesday. But it's certainly climbing today."

"The demand on Wednesday was started to

some extent by good demand in the Far East and New York overnight. Then once it was nearing \$400 in London, speculators came in," a dealer for bullion brokers Johnson Matthey said.

Technically the metal will need to move up through the \$420 level before investors can be reasonably confident that the recent weak patch is over.

## Upward move

Nevertheless, the significance of the upward move through \$400 should not be underestimated. While short covering undoubtedly led to the sharp \$30 rise over the past few days, the key factor in the current market is that sentiment appears to have swung from strongly bearish to positive with the market once again taking note of bullish factors.

These include the growing United States trade deficit as well as hopes that United States interest rates may ease.

The United States trade deficit rose to a record seasonally adjusted \$8.97 billion in October well up on the \$5.81 billion in September.

The deficit for the first 10 months is now running at \$55.6 billion as against the \$42.69 billion for the whole of last year.

The growing deficit should lead to some fall in the dollar. The dollar moved down in the wake

of the latest deficit but lower interest rates are the key for a substantial change in the trend of the United States currency.

Fundamentally the market should be well above the \$400-mark at this stage with seasonal demand likely to support the price well into the new year.

Industrial demand should soon pick up with the United States economic growth leading to a commodity boom.

The sudden surge in the gold price has taken the markets by surprise. With the chartists predicting further falls many investors had gone short and have been frantically covering in these positions.

Gold shares seem likely to show further sharp rises if the tone of the gold market is maintained. The blue chips are offering in historic terms good value.

J  
T  
h  
e  
d  
e  
f  
i  
c  
i  
t

GOLD

1984 - 1985

CEMENT MANUFACTURING INDUSTRY, R.S.A.

AREA A: Alberton, Bellville, Benoni, Boksburg, Brakpan, The Cape, Durban, Germiston, Inanda, Johannesburg, Kempton Park, Kimberley, Klerksdorp, Krugersdorp, Nigel, Pinetown, Pretoria, Randfontein, Roodepoort, Simonstown, Springs, and Wynberg, Municipal Area: Port Elizabeth;

AREA B in all other areas.

# Gold price rallies to \$367,50

AKG US  
10/1/84 (79)

GOLD rallied at the morning fixing in London today to \$367,50 an ounce, up from yesterday's close of \$366,50 in London and \$365,50 in New York, Reuter reports.

Modest amounts of fresh buying in New York and some short covering helped gold partly recoup earlier losses.

The New York close was \$3 down on the day, which dealers attributed to the sharply stronger dollar and the prospect of a drop in the price of oil.

The dollar surged to new highs in New York after reports that European central banks were not planning concerted efforts to counter its strength.

#### RECORD HIGHS

It reached record highs against the French franc, lira and sterling before profit-taking trimmed its levels. For the first time a British pound was worth less than \$1,40, but it recovered to \$1,402 at the close.

The dollar reached a 10-year high against the German mark of 2,8460 before settling back to 2,84375 at the close.

The rand recovered slightly against the dollar in Johannesburg today. It was quoted at \$0,7865 after opening at \$0,78385, compared with the close of \$0,7855.

It reached a record low of \$0,7795 in yesterday's trading.

Bankers and economists say South Africa's hopes of a brisk economic recovery this year could be dashed if the gold price remains in the doldrums for long.

The slump in the price from \$400 a month ago jeopardises forecasts of around an economic growth rate of about three percent this year.

Most economists have based their predictions on an average gold price this year of around \$450.

One bank economist said that if gold remained around present levels for most of the year, the economy could face another year of negative growth, Sapa-Reuter reports.

The falling gold price and lower government revenue puts strong pressure on the Finance Minister, Mr Owen Horwood, to raise taxes in his March budget.

Some economists said they were hoping for a significant upturn in non-gold exports and an increase in agricultural output following good rains recently.

But the slumping gold revenue might now outweigh these gains.

London gold fixings were:

	Dollars an ounce	Rands a kg
Today		
10.30 am	367,50	15 022,87
Yesterday		
3.00 pm	365,25	14 949,90



Mr Owen Dinsdale, managing director of Barlows Manufacturing Co, has been appointed to the board of Barlow Rand Industries Earthmoving, Motor and Appliances division.

# JCI lifts profits — interim div up 38%

CAPE TIMES 17/1/84 By BRENDAN RYAN

**JOHANNESBURG.** — Johannesburg Consolidated Investment's (JCI) attributable profit is up 15,2 percent to R56,1m (previously R48,7m) for the six months to end-December.

However, the group's directors say it is unlikely a similar increase in attributable profits will be achieved in the second six months of the financial year to end-June.

JCI has increased its interim dividend by 38 percent to 180c a share from the previous interim of 130c a share.

Key factors in the group's improved performance for the first

six months of its 1984 financial year were the dividends from Randfontein Estates gold mine and Rustenburg Platinum Holdings.

JCI's profit before preference dividends rose to R60,3m from R53,0m of which the major contribution came from investment income.

### Investment income

For the six months to end-December investment income was R46,7m compared with R35,3m previously.

In the year, JCI received 532 842 new shares in Randfontein for the mineral rights it sold to the mine to set up a mining operation in the new Doornkop section.

Randfontein paid dividends totalling R12 last year bringing in an additional R6,466m to JCI.

The increased final dividend from Rustenburg last year was brought to account in the first half of JCI's 1984 financial year and contributed another R4,1m in additional income.

These two sources together totalled R10,566m in extra income and the remainder of the R11,4m improvement in dividend in-

come came from better payouts from Western Areas and also a dividend from antimony producer Consolidated Murchison which contributed nothing to JCI's previous interim results.

### Subsidiaries

JCI's attributable earnings from operating subsidiaries rose slightly to R7,6m from R6,3m previously.

According to the general manager of JCI's finance division, Mr Vaughn Bray, the improvement came from the group's Lennings industrial arm which has remained profitable.

Lennings lost money in the previous interim period but the group was restructured, recapitalized and returned to profitability in the second half of the year to end-June 1983.

Mr Bray said income from Tavistock colliery was down this year compared to last year, reflecting the overall depressed conditions in the international coal markets.

JCI's other net revenue dropped sharply to R6,0m (previously R11,4m). This was a major source of income to the group in the previous financial year when it was particularly successful in its money market operations.

Mr Bray said the drop was the result of a lower level of interest received, certain exceptional costs associated with investments including the group's acquisition of its stake in Premier, and a R2m provision for tax.

Mr Bray said JCI had worked off the tax loss on its own operations and would soon have to pay tax on its income

from interest and management fees.

The R8m (R6,1m) tax paid by JCI in the six months relates to the operations of the group's subsidiaries.

He said the increase in the interim dividend was intended to reduce the difference between the levels of the interim and final dividends.

JCI's investment in SA Breweries is now held through its stake in the Premier group which pays out more at the interim stage compared with the final dividend than SA Breweries used to.

"I believe that JCI's earnings for the year to end-June will show a modest improvement on those of the previous year but not as much as the 15,2 percent of the first half.

### Final dividend

"I cannot say at this stage whether the final dividend will be maintained, but we are looking for second half results to be better than those of the second-half of the 1983 financial year," he said.

JCI's net asset value at December 31 was R253 a share compared with R213 at June 30 and R180 on December 31, 1982.

**Comment:** A repeat of last year's second half for JCI would yield earnings of 739c to make a total of 1 505c for the year to end-June, seven percent up on the previous year's 1 405c.

Given this outlook and the expectation that JCI could do better, the maintained final looks a safe bet with a chance of some improvement to the final depending on the gold price and the platinum market.

GF Props  
lifts  
profits

# Randfontein hoists profits to R86,280m

Own Correspondent

**JOHANNESBURG** — Gold Fields Property's profit on township and property sales soared to R1,558m in the six months to end-December from R93 000 in the previous comparable six months.

Taxed profit for the six months was R2,947m (previously R1,747m) equivalent to earnings of 28,8c a share (17,1c a share).

GF Props declares an annual dividend which will be considered in August this year.

The company paid a dividend of 20c a share from earnings of 41,1c a share in the year ended June 1983.

GF Props income from rents for the six months rose to R1,707m (R1,174m) while investment income rose to R574 000 (R444 000).

On pre-tax profits of R3,827m (R3,021m) the provision for tax dropped to R880 000 (R1,274m).

**JOHANNESBURG** — Gold hedging and forward currency deals made important contributions to the results of JCI's Randfontein Estates and Western Areas gold mines in the December quarter.

The group's mines are benefitting from the changes made by the Reserve Bank in September last year when it started paying the gold mines in dollars and also allowed them to take forward cover on their dollar receipts.

## Mining houses

JCI's policy is to take views on the rand/dollar exchange rate and take advantage of the currency freedom granted by the Reserve Bank depending on how the house reads the circumstances.

Other mining houses, such as Gold Fields of South Africa (GFSA),

have opted for no change in their operations, and are not dealing in the currency markets other than to repatriate their dollar earnings to South Africa immediately.

What this can do to revenue is shown clearly in the December quarter results. While the average gold price received by GFSA's mines dropped to R14 705/kg in December from R14 984/kg in September, Randfontein's price rose to R15 001/kg in December from R14 866/kg in September.

The average London gold price converted at average ruling exchange rates dropped to R14 647/kg in December from R14 848/kg in September.

Randfontein's increase is due to currency hedging transactions by JCI on behalf of the mine as Randfontein does not sell gold forward.

Western Area's gold price received rose to R16 721/kg in December from R15 050/kg in September as the mine's policy of selling forward the bulk of its production finally paid off.

The price received could reflect the benefits of both a higher dollar price contracted in advance and also successful forward dealing on the rand/dollar exchange rates.

JCI publishes minimal information on forward gold sales by Western Areas. The house does not plan to follow the

lead set by Rand Mines in disclosing fuller details of forward gold sales contracts.

It also indicates that JCI's view of future gold prices is more bullish than that held by Rand Mines whose marginal producers started hedging seriously this year.

Randfontein Estates had yet another superb quarter ending December and broke a number of quarterly records.

These included tonnage milled at 1,543m tons (previous quarter and record 1 530m), gold production at 7 714 kg (previous quarter and record 7 650 kg) and taxed profit at R86,280m (previous quarter record R41,413m, previous record R67,906 in December 1982).

The mine's impressive cost control performance continued with unit costs being reduced for the third successive quarter to R27.8 (previous quarter R28,27).

Randfontein's total costs dropped to R42,895m (R43,257m). Costs have been reduced in spite of reductions in tonnage milled off surface dumps, which is cheaper to treat, as production builds up from underground.

The Millsite plant which can treat about 200 000 tons of sand and slime material a month will only be able to handle about 120 000 tons of underground ore a month.

The mine packed in huge amounts of capex in the December quarter, the last of its financial year, and capex soared to R82,313m (R10,868m).

The annual figures show the mine has retained nothing of its R223,241m taxed profit after paying capex of R137,998m, dividends of R73,363m and a loan repayment of R12m.

Western Areas will start to equip the No. 3 sub-vertical shaft this year.

Uranium sales volumes are expected to be about 30 percent higher in 1984 than 1983 but lower uranium prices mean the mine's uranium revenue will not benefit to the same extent.

**Picardi Gardens Hotel**  
Union Street, Gardens. Telephone 24 1460  
—★TYYY—  
**POOLSIDE BUFFET AT KIRISLAM RESTAURANT**  
**COLD MEAT BUFFET** (eat as much as you like) **R4,75**  
**CURRIES AT R3,75**  
**CHEESE PLATTER R3,50**  
**ALL CULEMBORG WINES R2,75 PER BOTTLE OR 45c PER GLASS**  
GST INCL

**PICARDI HOTELS**  
A BUDDING REPUTATION

Before you get the wrong computer, get the right advice. Free.

**Business Computer Centre.**  
Distributors of  
**Canon DEC SHARP hp HEWLETT PACKARD**

**BUSINESS COMPUTER CENTRE**

Address: 47 Ruetbeek Street  
Cape Town 8001 P O Box 218C  
Claremont 7740

Phone Jennie Rahman, or  
Anders Buchwald for more details  
Tel (021) 25 1556

Mo  
JOH/  
The I  
terday  
offerin  
chase  
ruary  
marke  
BAS:  
two m  
months  
NCB  
19,65; t  
three r  
months  
17,70.  
Disco  
17,25.  
Treasi  
Reuter

The most exclusive number plate is...



# Anglovaal mines hit <sup>Cape Times 18/1/84</sup> by lower gold revenue

By ADAM PAYNE <sup>(214) 79</sup>

**JOHANNESBURG.** — Anglovaal's Loraine gold mine in the Free State showed a working loss of R1,050m in the December quarter compared with a working profit of R4,526m in the September quarter.

The mine's final results were partly saved by a provision for State aid that resulted in a net profit, which was considerably lower than in the September quarter.

This was a depressing result in Anglovaal's December quarterly reports, which were not inspiring because of lower gold revenue — except at ET Cons — and lower yields.

Unit costs were higher at ET Cons and Loraine but lower at Harties.

ET Cons reported marginally lower grade and considerably higher unit costs, resulting in a slightly lower net profit than in September and no earnings after capital spending. In September earnings were 24c a share.

**Hartebeestfontein:** Costs were well contained and, combined with a higher tonnage milled, brought about a decrease in unit working costs at R71,86 (R72,45) a ton.

However, this was insufficient to offset the

lower gold price and led to a drop in working profit to R56,617m (R61,157m)

Profit from uranium oxide sales was marginally higher but non-mining income was down while net royalty payments rose to R2,684m (R1,302m) because more ore was drawn from the Vaal Reefs lease area.

Pre-tax profit dropped to R60,394m (R67,402m). Lower capital spending resulted in tax being little changed — in spite of the lower profit — leaving the final taxed profit after capital spending lower at R19,752m (R20,424m) or 176c a share (182c).

Development values for gold were 1307 cm g/t (1502 cm g/t).

**Loraine:** Mill throughput was lower and the grade decreased to 5 g/t (5,7 g/t) because of temporary underground difficulties which reduced the tonnage mined.

To fill the mill, the mine drew ore from the surface stockpile on a provisional basis.

Unit costs were higher

at R76,91 (R75,73) a ton. This increase, combined with lower revenue, led to the working loss of R1,050m.

The mine claimed State aid of R2,641m on the basis that there has been no amendment to the Gold Mines Assistance Act.

Because capital spending ranking for aid has not yet been determined by the Government Mining Engineer, no allowance was made for any of this expenditure in the sum claimed.

Profit (no tax) declined to R1,773m (R3,665m).

Development results improved. The average on all reefs was 675 cm g/t (528 cm g/t).

**ET Cons:** Although grade and gold production were lower, unit revenue rose following receipts relating to September quarter deliveries.

This was insufficient to offset a big rise in unit working costs, caused mainly by a build-up in the labour strength at Sheba mine.

The working profit dropped only marginally to R5,719m (R5,989m), and final results were aided by a tax credit of R5 000 (R77 000 charge) largely brought about by the lower working profit and increased capital spending.

In spite of the fact that there was no provision for tax, net profit fell slightly and there was a loss after capital spending of R237 000 compared with a profit of R1,020m in the previous quarter.

**Village Main Reef:** Sands treated increased to 185 000 tons with an average yield of 0,60 g/t (0,62 g/t). Because of the higher tonnage, costs decreased by 7c a ton to R7,83 but the lower gold price caused unit revenue to fall to R8,88 (R9,30) a ton and working profit to decline to R193 000 (R240 000).

After adding sundry income of R80 000 (R51 000) and deducting tax of R82 000 (R104 000), after-tax profit was raised to R191 000 (R187 000).

## GF Props lifts profits

**JOHANNESBURG.** — Gold Fields Property's profit on township and property sales soared to R1,558m in the six months to end-December from R93 000 in the previous comparable six months.

Taxed profit for the six months was R2,947m (previously R1,747m) equivalent to earnings of 28,8c a share (17,1c a share).

GF Props declares an annual dividend which will be considered in August this year.

The company paid a dividend of 20c a share from earnings of 41,1c a share in the year ended June 1983.

## Randfontein hoists profits to R86,280m <sup>Cape Times 18/1/84 (214) 79</sup>

Own Correspondent

**JOHANNESBURG.** — Gold hedging and forward currency deals made important contributions to the results of JCI's Randfontein Estates and Western Areas gold mines in the December quarter.

The group's mines are benefitting from the changes made by the Reserve Bank in September last year when it started paying the gold mines in dollars and also allowed them to take forward cover on their dollar receipts.

### Mining houses

JCI's policy is to take

have opted for no change in their operations, and are not dealing in the currency markets other than to repatriate their dollar earnings to South Africa immediately.

What this can do to revenue is shown clearly in the December quarter results. While the average gold price received by GFSA's mines dropped to R14 705/kg in December from R14 984/kg in September, Randfontein's price rose to R15 001/kg in December from R14 866/kg in September.

The average London

lead set by Rand Mines in disclosing fuller details of forward gold sales contracts.

It also indicates that JCI's view of future gold prices is more bullish than that held by Rand Mines whose marginal producers started hedging seriously this year.

Randfontein Estates had yet another superb quarter ending December and broke a number of quarterly records.

These included tonnage milled at 1,543m tons (previous quarter and record 1 530m), gold production at 7 714 kg (previous quarter and record 7 650 kg) and

JOH Gold stoc. mode bulli recov the cline He.

# Gencor gold mines show fall in profits

CRS Times 19/1/84

By BRENDAN RYAN

79 ~~24/1/84~~

**JOHANNESBURG.** — West Rand Consolidated Mines' working loss worsened in the December quarter in spite of forward gold sales which increased its gold price received.

The gold price received by the other mines in the Gencor stable dropped in the December quarter except for Marievale which also hedged successfully.

W R Cons increased its gold price received to R15 102/kg (previous quarter R15 001/kg) but the mine's working loss rose to R2,733m

(R2,487m). The mine's tonnage milled dropped to 554 500 tons (566 800 tons) while grade remained unchanged at 1,7 g/t.

The Krugersdorp marginal producer has battled with the gradual slide in the gold price over the last six months. W R Cons' taxed loss for the December quar-

ter improved to R375 000 (R827 000 loss) mainly because the mine paid tax of only R6 000 (R657 000).

The dividends paid by the mine have been extremely generous with W R Cons dipping into its reserves for R609 000 to pay dividends totalling R3,4m as well as fund capex of R1,446m.

Grootvlei appears to have overcome the problems with its new treatment plant which knocked production in the September quarter to 429 000 tons milled from 481 000 tons in the June quarter.

December milled production is up to 505 000 and the resulting jump in gold production to 1 919 kg (1 631 kg) offset the drop in the gold price received and pushed working revenue up to R28,092m (R24,515m).

Distributable earnings rose to 34,8c a share (23,2c) while the annual figures indicate yet another generous dividend payout.

Grootvlei took R151 000 from reserves to pay dividends totalling R14,413m after funding capex of R7,686m from taxed profits of R21,948m.

Leslie put in one of the best cost performances of Gencor's mines reducing unit costs to R41,2 a ton (R42,8 a ton) and total working costs to R11,957m (R12,628m).

The mine also pushed its grade up to 3,4 g/t (3,2 g/t) but is not yet back to 3,5 g/t of the June quarter.

Buffelsfontein's results include details of operations from the Beatrix

section for the first time as the Beatrix metallurgical plant has been commissioned and the first gold was poured from development ore on December 21.

Buffels' tax profit for the September quarter has been restated to R45,085m from the previously announced R27,567m but the capex figure has also been revised to leave the distributable earnings for the September quarter unchanged at R15,937m.

Stilfontein's grade dropped to 6,4 g/t (6,9 g/t) as the mine's operations are moving into more restricted stoping areas and there is not a lot it can do to improve grade.

The mine pushed up tonnage milled to 473 000 (445 000) and the R4,8m dividend from Chemwes helped it increase distributable earnings for the quarter to 81,8c a share (51,5c).

St Helena's grade also dropped to 5,8 g/t (6,0 g/t). The mine's stoping operations are moving steadily south into lower grade areas after the depletion of the remaining high-grade reserves in the north of the mine's lease.

Marievale pushed its gold price received up to R14 812/kg from the September quarter's R14 788/kg through gold hedging operations.

Unisel also showed lower grade in the quarter which on maintained tonnage milled meant gold production dropped to 2 310kg (2 376kg).

Kinross has been ceded the right to prospect in the immediate vicinity of the mine from Gencor which to date has spent R2,198m on prospecting which has been partly financed by a long-term loan.

Winkelhaak was affected by higher costs and lower gold revenue and distributable earnings dipped to 85,6c a share (106,7c a share).

Bracken also showed a dip in grade to 3,5 g/t (3,6 g/t) and development work on the Kimberley reef exposed lower average values of 11,8 g/t compared with 19,4 g/t in the September quarter.

# GST to rise 1pc next month

Cape Times  
24/1/84

Staff Reporter

**THE government would increase the general sales tax by one percent to seven percent from February 1, the Minister of Finance, Mr Owen Horwood, announced last night.**

Mr Horwood put the blame for the increase on the world-wide economic downswing, the inability of South Africa's trading partners to register an early and meaningful economic recovery, and the recent drought in South Africa.

He said the rapidly-declining gold price and a consequent weakening of the rand-dollar exchange rate, and the

higher-than-budgeted expenditure on essential services, also contributed to the need for the increase in GST.

"No tax increase is without sacrifice, and in view of price and cost increases evident elsewhere in the economy, the government would have preferred to avoid any increase in taxation, especially at this point in time. Unfortu-

nately this is just not possible," Mr Horwood said.

An advantage of general sales tax, however, was that it was levied on almost all final purchases.

"As a consequence, the community as a whole contributes to the financing of public expenditure, which in turn is incurred for the benefit of the whole community," he said.

The government's most important and unavoidable expenses were on drought relief, defence and the servicing of the public debt. Other expenses were on food and transport subsidies.

"On the other hand, the growth of the country's sources of income is limited by the present economic downswing and is insufficient to cover a growing deficit, due primarily to declining profits in the business sector and a decrease in net customs and excise revenue," Mr Horwood said.

Pointing out positive steps, Mr Horwood said significant progress had been made in the fight against inflation. A positive turn-about in the balance of payments had been continued and consolidated. South Africa's credit-worthiness internationally stood at a very high level.

"In addition, it seems as if the economic downswing has reached its lowest ebb, or very nearly so.

"All in all, I am optimistic that South Africa will soon benefit from the long-awaited improved international economic climate and during 1984 experience the commencement of a prolonged and healthy export-led economic upswing."

● Poor people hardest hit, page 6

FINANCIAL BRIEF

# Gold weakness related to dollar's strength

CAFE TURT  
11/2/84  
79

By PAUL DOLD  
Financial Editor

IN one of several outstanding speeches at the conference, Mr Sherman R Lewis, vice-chairman of Shearson-American Express, forecast that the dollar would remain strong for most of 1984.

Not only will high interest rates bolster the currency but important geopolitical considerations were influencing investors.

"As long as our bond markets offer a seven percent inflation adjusted return to foreign investors and short-term money markets as much as five percent, money will continue to flow in large quantity to the United States."

Mr Lewis also warned that too much should not be read into short-term fluctuation in United States interest rates.

"We do not expect a consistent trend in interest rates to emerge prior to the November elections. Fluctuations around the present rates, created mostly by the Federal financing pattern, will continue. People who will try to trade our markets on these very short-term swings will have to be very skilled or lucky to come out ahead."

While Mr Lewis did not refer directly to gold, he gave an excellent insight into the United States economy and factors which influence the gold price.

## Inflation rate

The bull points emerging for the metal include a rise in the United States inflation rate and a lower interest rate pattern. Mr Lewis predicts that United States inflation will rise.

"Though we do not see any sign that our economy will return to double digit inflation, acceleration to the 5.5 percent range by late 1984 appears to be a strong probability."

The upward impetus will be provided by wages, plant bottlenecks and increased food prices — particularly meat.

The United States authorities are no doubt very aware that the

A strong dollar is likely to depress the gold price for most of this year but looking further ahead several factors are emerging which should lead to a new bull trend early in 1985.

At this week's Simpson, Frankel, Kruger investment conference attention was sharply focused on the dollar as gold weakness is directly related to the strength of the United States currency, which in turn flows from high American interest rates.

While fundamentally the dollar is overvalued, investors would be unwise to anticipate an early weakening.

"This is not likely to be ignored by Washington. It can have most serious consequences for our employment picture and for our growing indebtedness abroad.

"Wherever foreign capital flow to the United States, in fact, the United States borrows from the rest of the world, and this debt has to be serviced in future years."

The huge Federal Budget deficit will ultimately lead to tax increases and lower interest rates to be followed by a weakening of the dollar.

## Natural markets

With accelerating demand for credit from the corporate and housing sectors making it difficult for the Budget shortfall to be financed in the natural markets, the probability of unpopular measures would grow.

Mr Lewis predicted that "early 1985 should bring some soul searching".

Repeating our 1981 policies of combining monetary restraint with fiscal stimulation would create severe unwanted side effects. True, it would cool the economy

and contain inflation.

However, by pushing interest rates higher, it would cause a further rise in the value of the dollar. Thus, a decline in demand for imported goods, typical of a cooling economy, would be wiped out by making these imports cheaper than they already are.

"The American business community looks with concern at the possibility of another tight money recession sequence. It has experienced the ravages of such policies in four instances since 1966. Many Americans would regard a tax increase as the lesser evil with which we could extricate ourselves from growing inflationary pressures."

## Fiscal measures

United States rates would decline sharply once financial markets believed the necessary fiscal measures would be introduced.

At the conference Simpson, Frankel, Kruger's gold mining analyst, Mr K W Goode, said that the gold price was expected to improve this year from a forecast first quarter average of \$372 to \$390

in the second quarter, \$415 dollars in the third quarter and to \$432 in the final quarter.

Due to the expected lacklustre gold share market, he advised investors to buy quality gold such as Randfontein, Kloof, Southvaal, Buffels and Harties.

The outlook for industrials is far from encouraging with SFK industrial analyst, Ms L M Ward, recommending fixed interest stocks.

She forecasts that interest rate patterns this year will provide capital growth in gilts, while both the income return and capital appreciation will diminish on industrials.

"The best value for 1984 is to be had in the capital market, provided institutions do not push the market against fundamentals."

Listing guidelines for selecting industrials she said excellent companies had ... strong strategic planning ... were entrepreneurial ... were close to the consumer ... had a bias for action ... were willing to experiment and take risks showing aggressive opportunism.

## Performances

"Single business firms (which grow by the expansion of a product line which comprises more than 95 percent of sales) and related product firms (where the major product line accounts between 50 and 70 percent of sales) have in the United States, the UK and South Africa shown better value performances than the diversified conglomerates and dominant product firms (where no one product line accounts form more than 70 percent of sales).

"Diversification is easier and cheaper for the shareholder than for the corporation."

Examining overall trends in industrial investment she said corporate performance would stagnate this year. Institutions would have to look to the second string, the smaller, the up-and-coming business and banish traditional worries such as dominant holdings and liquidity.

Investors should beware of the inactive gi-

Club is looking for bride-  
ch is badly needed for their

□ □ □ □ □

month home they lived a high  
liquor and beautiful woman

## Shares spurt in heavy demand

# Gold breaches \$406-level

CAPL TINKS  
6/3/84  
79

By PAUL DOLD, Financial Editor

**THE** gold price breached the \$406 level yesterday as the dollar weakened against most major currencies and gold shares showed sharp gains both in Johannesburg and London. The rand spurted in the wake of the higher gold price.



Mr Derek Carstens has been appointed managing director of Rightford Searle-Tripp Makin (Tvl).

Fears of renewed United States inflation and concern over mounting deficits pushed the dollar down.

Gold was fixed in the morning at \$406,85 which was nearly a \$10 rise on Friday's closing levels.

Dealers in London said gold appeared "comfortable" at the current levels and several were confident that gold would continue its upward trend.

However, some reports indicate that trading volume was only moderate and confined to professional dealing.

Gold continued to firm throughout the day. At midday the metal stood at \$406,50

— \$407 a rise of \$2,25 on the morning's opening. The late fix was \$405,85 and the metal closed lower at \$405,25.

Strong local and overseas buying lifted gold shares sharply higher with gains among the heavies ranging to nine percent. Marginal Vlaks showed one of the largest gains on the gold board rising 11,5 percent. Loraine added 6,7 percent and South Roodes eight percent.

The trend was continued in mining financials were Anglos spurted 90c.

De Beers added 40c.

Industrials firmed as well with the majority closing higher, gains

included Sasol's 25c and Clicks' 30c.

The heavy institutional demand for gold shares is reflected in the turnovers of shares such as Southvaal and Harties which notched some R1m with Elsberg and Vaal Reef's just below this level. Turnovers of some R500 000 and above were shown by the top 20 traded shares yesterday and most were golds.

Gilt rates dipped reflecting the gold price with the 9,25 percent Escom falling from 14,46 to 14,30 percent and the 10 percent stock to 13,84 from 13,95. The falls were less marked in RSA's but the 14 percent stock was off seven points at 13,70.

The key three months' bankers acceptance rate shaded five points to 18 percent but money market rates were overall little changed. The shortage eased slightly to R1,66 billion (R1,7 billion).

The Kruger rand rose R8 to R555 yesterday.

ARGUS 19/4/84 79

FIN

# Gold jumps on new fears of inflation

Financial Editor

THE New York gold market suddenly came alive last night. The gold price, after dropping \$3 to \$377,50 an ounce in early trading, spurted \$10 to close at \$387,50 an ounce.

This was the highest the spot gold price had been for almost three weeks.

In London today gold held much of its gains, opening at \$384,50. It closed in London yesterday at \$378,50.

Dealers in New York attributed the sharp rise in the gold price to technical factors, reports Reuter.

They said the market focused on the key reversal in the June delivery after it snapped through Tuesday's high of \$386.

Traders rushed to cover short positions as stop-loss levels were breached, and the spot price rose as high as \$391 at one point.

### RUMOURS DENIED

Also significant was that the recovery in the gold price coincided with rumours — later denied — that the tough chairman of the United States Federal Reserve, Mr Paul Volcker, was to resign. Mr Volcker is credited with keeping American money tight and US inflation low.

The prospect of his departure from the Federal

Reserve would not be well received by Americans fearful of inflation.

It is likely it would trigger fears that the fight against inflation might not in future be waged with the same determination that he has shown.

### MAJOR BOOM

Meanwhile, evidence that the United States economy is experiencing a major boom continues to mount.

The car manufacturer Chrysler, which was saved from collapse by a Government loan, reported last night first quarter earnings greater than its entire 1983 profit.

Earnings for the March quarter were \$705,8-million. This was four times the \$172,1-million earned in the first quarter of last year and compares with 1983's profit of \$700,9-million.

London gold fixings yesterday were:

	Dollars an ounce	Rands a kg
10.30 am	380,85	15 267,92
3.00 pm	380,525	15 254,69

CAPL TIMES 27/4/84 ~~19~~ ~~153~~ 79

# Control of inflation does not augur well for gold

MAJOR industrial nations are reviving from the worst recession since the 1930s. This recovery which has been in progress for more than a year, is different from the sporadic upswings which occurred in the past decade. For the first time since the 50s and early 60s, the United States and other Western economies are experiencing economic growth with minimal inflation.

These developments have created problems for South Africa.

In a disinflationary world it is difficult for the country to make a fortune out of the gold price.

Following hardship and record unemployment in the early 80s, conservative economic policies are beginning to reap rewards.

## Institutes

West Germany's five leading economic research institutes, predict that the United States economy will grow by five percent this year, Japan by four percent, West Germany by three percent, Britain by 2.5 percent, Italy two percent and France by one percent.

While economies have slowly improved, inflation of the 24 member nations organization for economic co-operation and development, fell from an average of 10 percent between 1973 and 1982 to five percent last year.

Progress of some individual states was more notable. Britain's average inflation rate was

**Business Report's European financial editor, Mr Neil Behrmann, recently visited South Africa. In a series of three articles, he discusses international economic trends, their impact on the South African economy, and the political situation. The first article covers economic developments of South Africa's major trading partners. This is of vital importance to the performance of South African exports, the balance of payments and the internal economy.**

nearly 14 percent between 1973 and 1982. It is currently five percent.

From a nine percent average, United States inflation fell to three percent, although it rose above four percent recently.

The success against inflation has not encouraged policy makers to return to "growth at all costs".

The British electorate backed the Conservative government's anti-inflation aims, even though unemployment rose above 3m.

## Confidence

Such is his confidence in the present gentle recovery that the Chancellor of the Exchequer, Mr Nigel Lawson, recently stated that he preferred zero inflation.

Most forecasters expected easy money policies ahead of an American election year.

Instead the Federal Reserve Bank has tightened credit and raised interest rates fearing that brisk economic growth will soon lead to higher inflation.

This change in international economic policies has already affected the movement of South Africa's exports.

The slow international industrial revival is beginning to boost export volumes and prices of non-ferrous and ferrous metals ranging from chrome, manganese, vanadium, antimony to zinc, nickel and copper.

But the disinflationary world economic environment has hindered demand for precious metals and quality diamonds. Platinum is an exception because it is widely used in rapidly expanding industries.

## Chart

A long-term chart of precious metals dealers J Aron illustrates gold's problems

With the exception of a brief collapse to \$300 in mid-1982 and a spurt to \$500 early 1983, gold has been locked between \$360 and \$430 for well over two years.

Excitement has gone out of the gold market and speculators and investors are trading between a 20 percent

band. Physical demand improves when gold falls to around \$380 and then abates when it rises above \$400.

Besides the lethargic investment interest the metal is suffering from another aspect of disinflation. Huge price increases in the late and early 70s encouraged fabricators to use smaller quantities of gold in jewellery. They are still doing so.

Since supplies continue to outpace fabrication demand, the price finds it difficult to make headway. The diamond industry is experiencing similar problems. Small cheap diamonds are popular while expensive stones are unfashionable.

## Economists

Most South African economists are predicting a precious metals and diamonds revival ahead of the election. Their forecast is based on a weak dollar.

This prediction is really a bet on Federal Reserve Board chairman Mr Paul Volcker. Will he or won't he ease money ahead of the election?

History indicates that he probably will.

But unless a Democrat becomes president any ease in credit will be temporary.

In these circumstances, it is hardly surprising that the Reserve Bank is presently raising interest rates, hoping that the country will bite the bullet.

If the gold price remains between \$360 to \$430 South Africans will have to do so.

# Low rand, higher sales tax mark end of gold boom

W/E AUGUS 19/5/84

38  
47  
79  
220

By **DEREK TOMMEY**  
Financial Editor

**THE** fall in the value of the rand this week to a new low of \$0,762 and the proposed increase in general sales tax to 10 percent have served to bring home the fact that South Africa's gold boom has collapsed.

The message on the temperance billboard that used to be at Woodstock station and was known to tens of thousands of train travellers is as apt for gold as for alcohol: First it lifts you up, then it lets you down.

Gold has let South Africa down badly, although that fact has been concealed to some ex-

tent by changes in the value of the rand against the dollar.

Measured in rands, the value of South Africa's gold output looks reasonably stable. According to the Reserve Bank, gold output in recent years has been worth:

1977.....	R2,8-billion
1978.....	R3,9-billion
1979.....	R6,0-billion
1980.....	R10,1-billion
1981.....	R8,3-billion
1982.....	R8,6-billion
1983.....	R9,9-billion
1984.....	R9,9-billion (est).

These figures suggest that the country's gold income, after peaking in 1980, has been comfortably maintained.

However, the rands in which these gold output figures are given has been steadily devalued against the dollar.

In 1980 a rand would buy \$1,28. But in 1981 it would buy only \$1,15, in 1982 92 US cents, in 1983 89,7 US cents and at present it buys only 77 US cents.

If the country's gold revenue is converted into dollars at these rates a different and a far less satisfactory picture emerges.

It shows that South Africa's dollar earnings from gold in recent years have been:

1977.....	\$3,2-billion
1978.....	\$4,4-billion
1979.....	\$7,1-billion
1980.....	\$13,0-billion

1981.....	\$9,6-billion
1982.....	\$8,0-billion
1983.....	\$8,9-billion
1984.....	\$7,9-billion (est)

It can be seen that South Africa's real income from gold has been declining since the peak in 1980.

It is also evident that even if the gold price remains at its current levels the country's dollar income from gold this year will be at its lowest level for several years.

The consequences of this decline in dollar earnings are far-reaching. South Africa needs dollars to pay its foreign debts. Without dollars or other foreign currencies it will have to cut back on its foreign purchases.

This is what the Government is trying to do. Its actions have been given added urgency by the news that in the first three months of this year the country was going into debt at the rate of R3-billion a year.

The main way of cutting imports is to reduce consumer spending and the Government is aiming to achieve this by raising income tax and levying higher indirect taxes — which will be increasingly felt as the year rolls on.

So, after the high life of the early 1980s, South Africans are now having to tighten their belts, trim their living standards and reduce their expectations.

They will also have to listen to Cabinet ministers and businessmen accusing them of living beyond their means — though the irony is that it is the Government that has been the worst culprit.



# Gold spurts to close at \$394<sup>79</sup>

LONDON. — The price of gold rose to \$394 yesterday as the dollar slid on world currency markets.

Gold was fixed in London yesterday morning at \$389,40, nearly \$5 up from Thursday's \$384,50 and the highest since late March. It stood at \$391,50 at midday and rose further to \$393,75 at the late fixing.

The morning's strength was reinforced yesterday afternoon as the dollar lost further ground.

## Buying interest

The advance was underpinned by the emergence of buying interest as funds flowed from the dollar.

Concern over the Iran and Iraq's war as well as over the health of the United States banking system were additional factors which discouraged sellers and so reinforced gold's strength, dealers said.

Steady demand for bullion from the Middle East, boosted by reports of fighting between Iran and Iraq, was a major factor.

The dollar's decline was attributable to signs of slowing economic growth in the United States, and continued alarm about Latin America's debt, dealers said.

## Closing gold prices

(In \$ an ounce)

LONDON:

393,75-394,25

Fixing am: 389,40

Fixing pm: 393,75

ZURICH:

391,00-394,00

— Reuter

Data published in the United States on Wednesday, including a 3,6 percent drop in factory orders, undermined the dollar.

The feeling was strengthened by persistent disquiet about the state of the United States banking system following the run on Continental Illinois, two weeks ago.

Markets are also worried that Bolivia's decision this week to temporarily suspend repayments to banks — many of them American — could trigger similar action by larger debtors. Brazil, which owes \$92 billion, has called for a meeting of indebted Latin American nations later this month when a common strategy might be mapped out.

The dollar's decline against the mark was reflected in trading against other currencies.

The dollar fell sharply to close near its lowest levels of the day on European exchanges, with markets concerned about stability of the United States banking system and no longer expecting higher United States interest rates in the short term, dealers said.

The dollar closed in London at 2,6835/50 marks, down from an opening 2,7120/30 and Thursday's 2,7310/20 finish. It was London's lowest close since April 25.

The London market was active as traders unloaded dollars ahead of the weekend, some leaving with short positions. Frankfurt saw nervous and thin trading, dealers there said.

Various influences weighed against the dollar and encouraging economic data could only briefly stem the tide.

Paramount was the belief that the Federal Reserve will not be able to pursue a tight money policy to combat inflationary pressures because of problems this could cause for the short-term liquidity needs of some United States banks.

Dealers were wary however, of predicting a general downward trend. "Sentiment is always changing," one said. — Reuter

GOLD

# Just another commodity

79 FM 22/4/84

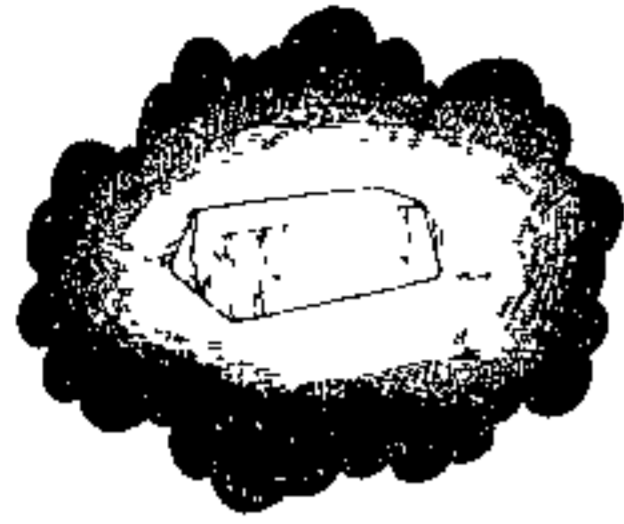

Is gold dead? Or has it merely lost its mystique? From the early Seventies, when Americans were first permitted to buy and hold bullion, until about two years ago, the metal amply displayed the almost divine qualities ascribed to it by General Charles de Gaulle: in the face of a seemingly crumbling world it remained "immutable, indestructible, eternal."

Lately, however, it has been behaving more like Lord Keynes's "barbarous relic." Gold was once a barometer of just about any imaginable crisis — social, political or economic. From the time it was "freed" by Richard Nixon in 1971 from its \$35/oz bondage, to the breaking of the \$200 barrier in 1974 in the wake of the oil crisis, and its quantum leap to \$850 in 1980 when the Soviets invaded Afghanistan, the dollar price of gold reflected a knee-jerk response to the market's perceptions of what constituted a dangerous situation.

And before the onset of monetarism, when ultra-inflation chewed up the interest on government bonds even before it was paid, bullion hoarding was a reasonably safe bet. Gold consistently out-performed currency speculation as central bankers, enslaved by fixed exchange rates, clamoured for another Bretton Woods.

But even after the international monetary system adopted a regime of floating rates in the mid-Seventies, gold continued

Just what will it take to shift the gold price out of its flat trend? In recent months the death of Soviet President Yuri Andropov, heightened East-West tensions, the shooting down of a civilian airliner by the Soviets, riots in India, and even a shooting war in the Persian Gulf threatening the Strait of Hormuz have been unable to shift investors' funds into the metal in significant amounts. The real question is whether gold can ever come back. SA's economic planners should rethink strategies.

to reward speculators who had a good sense of timing. The sound of cannon, or another twist in the spiral of international settlements problems, could be relied upon to send the price upwards.

What has changed? Why cannot gold regain and hold its glitter — despite a daily catalogue of dangerous international and domestic events, of war and financial crisis?

There may be two answers, both of which relate to changes in the world in which gold has to compete for a place as an appreciating asset. The first could be the market's acceptance that, regardless of rhetoric, the Soviet Union and the US have decided they would rather live dangerously with one another than die together. Nuclear Mutually Assured Destruction (MAD) saw to that.

The second answer seems to be that

trends in the world economy have conspired against the metal. Low inflation, high real interest rates, and a strong dollar are its worst enemies.

Louise du Boulay, author of *Consgold's Gold 1984*, writes: "At the heart of the matter lie US interest rates and the dollar... If rising inflation and a weaker dollar begin to appear inevitable then gold will once again be regarded as a possible alternative investment."

As long as investors in US securities are convinced that a stable, or rising, dollar will protect returns as high as 14% on bonds, there is no reason for them to rush into gold. On the other hand, there is consolation for non-US gold bugs: while the dollar price of gold seems unable, even on the most dire developments, to get back to \$400, the downslide of most other currencies against the dollar has brought gains for investors who paid in weak money. Thus the rand realisation of SA gold currently sold is pretty close to R500.

Right now the downside potential of the metal looks strong once again. The prospect that the US might remove its 30% withholding tax on government bonds may be a red herring. But it was enough to put another short-term lid on the gold price, writes our London editor.

The US inflation rate may be projected to rise later this year, but for the time being the trend is flat and the demand for high-yielding dollar securities rolls on, enhancing the "safe haven" status it usurped from gold. Barring catastrophe of much wider proportions than the Gulf war, or the

## GOLD'S LEADEN TRACK

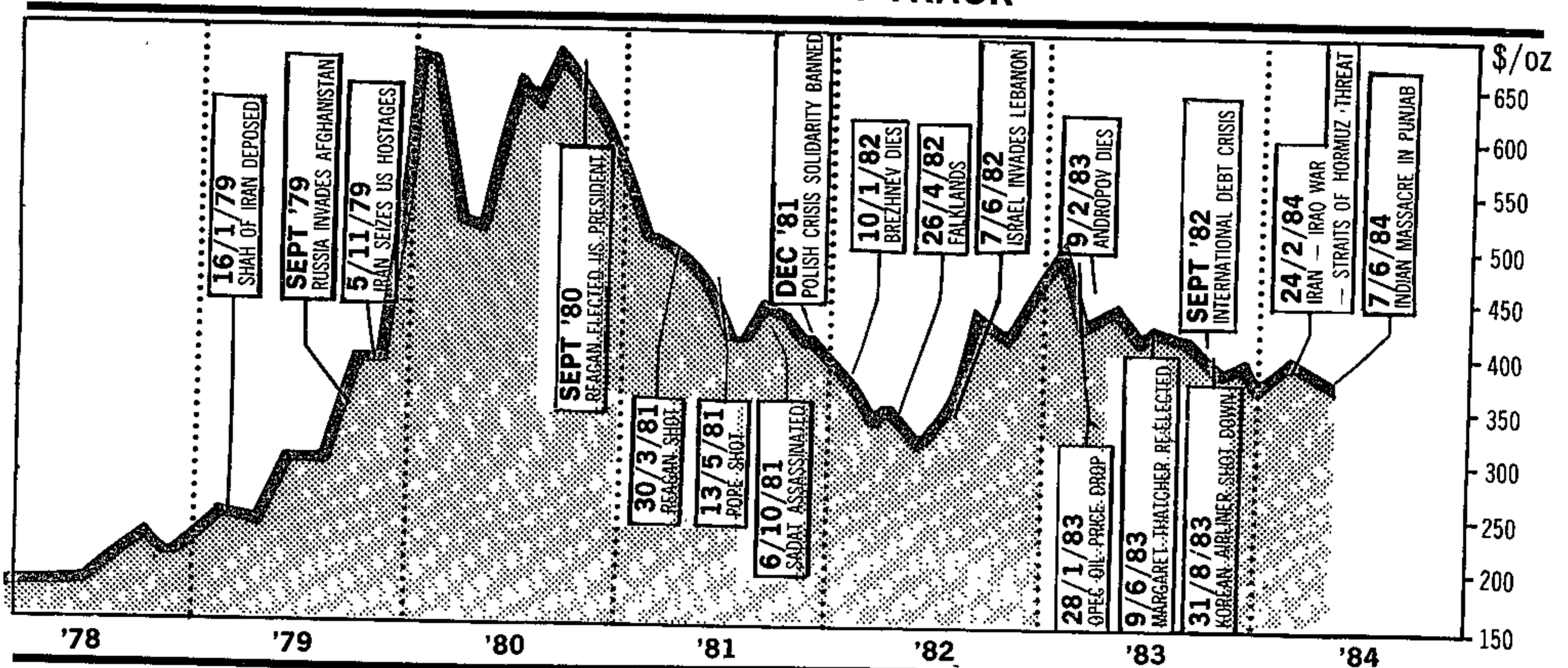

74



President Reagan ... the inauguration of gold's demise

failure of Ronald Reagan to win in November, the medium outlook for gold is dull.

The latest Organisation for Economic Co-operation and Development (OECD) view of the world economic outlook to end-1985 indicates a sharp slowing in growth (from 4,25% to 2,75%). And while inflation seems set to rise in the US (from 4% to 5,25%), declines elsewhere will leave the OECD average unchanged on 1984 at 5,25%, just below the 1983 level of 5,5%.

Looking further ahead, a new study by National Westminster Bank (the UK's second largest) postulates five years of relatively low growth, ranging from 2,3% to 2,5% in the main industrial countries. Inflation is estimated at an average 6,9%.

While the combination will allow nominal and real interest rates to be reduced, the Natwest study nevertheless sees them offering positive returns. For example, it forecasts that 20-year US government bond yields will fall to an average of 10,5% during 1985-1989 — from over 13%, thus halving the inflation-adjusted return. But it will still be a "real" 4%; and with other economies following suit, the fall in the dollar exchange rate may not be as precipitate as some have forecast.

"Although previous fears of a sharp increase in American interest rates have receded somewhat, US rates will remain sufficiently high to contain any serious pressure against the dollar in the near future," says the Natwest. It suggests a weakening of the dollar of between 8% and 14% by the end of 1985 against the yen, the Swiss franc and the D-Mark, but a much slower decline (4%-6%) against the trio in the four years to 1989.

Against this background it expects a gold price recovery of 7,7% to a 1985 average of \$420 (assuming this year's mean is \$390). But after that it does not expect gold to do

much better than match OECD inflation. The Natwest's forecasts give gold and crude oil identical rates of price appreciation over the 1985-1989 period — 6,1% a year — to hoist bullion to \$525 and the average spot price of all crudes at \$39/barrel.

In the process, Natwest predicts the rand will erode by nearly 25% to US 60c.

Across the Atlantic the US market for gold — despite the apparent contradiction of having the strongest gold demand this year since 1980 — is the coolest it has been in the 10 years Americans have legally been able to hold bullion and gold coins privately, writes our Washington correspondent.

#### Use and production

There are easy and ready explanations for the two situations to exist together. The US economy is indeed absorbing gold at its highest rate — 2,7m oz in the first quarter of 1984 — in four years. With the economy expanding at an annualised 6% it could scarcely have done less.

Yet despite the boom in industrial demand, US gold production (mainly secondary recovery) is nearly 20% off its strong 1983 levels of 1,8m oz/year. This is due to the still stagnant level of the main ores produced in those mines. As a result US gold bullion imports remain high. In April imports of 1,1m oz pushed the four-month total to nearly 3m oz. In the same month, gold coin imports of 445 000 oz hoisted their four-month total to 1,7m oz.

In other words, the US imported nearly as much gold in the first four months of the year as it did in 1983.

Yet prospects for bullion in the remainder of 1984 are not good. US economic expansion has begun to slow down. Business inventory build-up, low earlier this year, is now comfortably high. This prompts the

view that a rapid decline in bullion imports is imminent.

Gold coins provide the most graphic evidence of the metal's vulnerability. The Los Angeles Olympics were expected to boost medallion sales. Indeed sales of Olympic coins have been reasonably satisfactory until now; but at a significant ratio of 250 000 gold coins to 2,5m silver. Analysts expect the ratio to be maintained until the end of January.

"Coin collectors, unlike coin investors, are interested in the number of coins they can get for their dollar, the design, whether the event being honoured is unique — and only lastly do they consider the intrinsic worth of the metal used," a dealer explained.

The proof of that observation came a fortnight ago when the US Treasury braved congressional catcalls and abandoned its effort to sell gold "medallions" commemorating a number of jazz greats, painters and deceased authors.

The government released gold dealer J Aron & Co from its contract to buy 3m oz of the medallions at a 2% mark-up over the current bullion price when it was discovered that the public would not even buy the bullion-quality coins at below market price.

J Aron officials told the *FM* they took delivery of 1m oz of the medallions, but could only sell 150 000 oz. In order to break the contract the firm had to pay the government \$1,3m to cover the cost of coins minted.

Thus the Treasury is keeping in its vaults 2m oz that had been intended for the market this year. A spokesman for J Aron explained ruefully: "The days are over when Americans would buy anything with a yellow glitter to it. The medallions themselves were not that attractive, the topic was vague and there are too many other competitive alternatives for their dollar these days."

Gold may, in fact, never come back. Not only is the dollar stronger than it has been for a long time; but in the intervening five years since the end of the Jimmy Carter administration, Wall Street has devised a whole new range of sophisticated financial vehicles — money market funds, NOW accounts, and Euromarket trading accounts — to yield improved returns at much lower market risk.

Nor was gold's reputation enhanced six months ago when more than 50 000 investors lost \$100m in the collapse of two large gold depository houses. The investors ostensibly took certificates from firms which claimed to have bought bullion which was being warehoused on the investors' behalf for a fixed fee plus commission on the gold sale. But when the International Gold Bullion Exchange and the Bullion Reserve of North America collapsed, gold depositories were tarred with their brush. In both cases the firms bought very little bullion and simply squandered investors' fees.

More than anything else, the relegation

of gold to something less than a safe haven is largely due to the economic policies of the Reagan administration, US analysts believe. For the first time since August 1974 Americans feel good about their country and about themselves. Consequently there is no incentive to hoard in the basement a metal that does not pay dividends or

interest.

Gold's popularity in the US will, as it has most times, be more for its ability to convert to products that make dollars, and less as a refuge against impending doom.

SA's economic decision-makers should heed these warning signals. Current and future gold revenues should be spent on

broadening the country's industrial base, on education and other long-term investments that will soften the impact of living with a commodity that has lost its lustre. Government spokesmen should avoid statements of seemingly mindless optimism predicting that another (gold) export-led recovery is just around the corner.

# As the rand sinks so <sup>25/7/84 Star</sup> the gold mines profit 79

By Duncan Collings  
Deputy Financial Editor

Despite the weak gold price, only two gold mines, both in the Rand Mines stable — ERPM and Durban Deep — are producing at a loss.

The average break even point of the industry rose only 2,25 percent in the June quarter to R272 an ounce from R266 in the previous quarter.

The picture is better still now with the rand/US dollar rate having declined to the point where the international gold price in rand terms stands at just over R500.

At this level the two mines — ERPM and Durban Deep — are operating at a production cost below the current international rand price of bullion. ERPM has a break even point of R567 and Durban Deep of R533.

But this picture would not be complete without considering capital expenditure.

This totalled about R380 million for the industry in the June quarter and is set to accelerate in the third and fourth quarters — rising to between R400 million and R420 million in the three months to September and even higher in the December quarter.

As a fair proportion of the capex content is imported, the weak rand/dollar rate will push the cost of capex even higher if it persists and this will affect the industry's net profitability.

With the effects of black and white wage increases yet to fully impact on costs, the industry cannot be too sanguine about the rest of the year.

Although costs increases were held to between two and three percent in the June quarter, these are bound to accelerate through the second half of

the year, watchers of the industry believe.

They look to around four percent for the September quarter and perhaps a little higher in fourth quarter.

For the industry, this will probably mean fairly static profits and dividends for 1984 with only exceptional cases — such as new production being brought on line — able to show much of an improvement.

As for the stock market, industry analysts say that there is still considerable downside potential — particularly if the slump in the gold price continues.

They say that the shake-out of the past few weeks, which has seen gold shares declining by an average 18 to 19 percent, has resulted in golds coming off their very overpriced levels to a more realistic situation.

They feel that until the declining trend of the gold price is halted, gold shares prices will continue to fall.

Yields on gold shares have risen from a low of around six percent last year, to closer to eight percent now. But this is nowhere near the highs of 12 percent seen at the height of the last bear market in 1981.

And they add that while the dollar remains a haven for international finance — and there is nothing on the horizon for at least six months to alter this situation, the international bullion price will remain under pressure.

In the more distant future US inflationary fears and the large US current account and balance of payments deficits could bring about a re-rating of the dollar to gold's benefit.

Until the gold price improves, gold shares will be a dull and listless market, drifting lower on small volume, the analysts say.

## Break-point

The following are the break-even points of the various South African gold mines for the June quarter (in R/oz with the previous quarter in brackets):

Elandsfontein.....	294(296)
Ergo.....	381(303)
Freguls.....	374(397)
PresBrand.....	379(280)
PresSteyn.....	293(278)
VaalReefs.....	233(249)
Sovaal.....	157(149)
WestDeep.....	220(224)
WestHolds.....	334(334)
ETCons.....	220(254)
Harties.....	232(227)
Loraine.....	422(452)
Blyvoors.....	296(267)
DurbanDeep.....	533(491)
ERPM.....	567(532)
Harmony.....	400(389)
Bracken.....	376(354)
Buffels.....	281(274)
Grootvlei.....	338(354)
Kinros.....	232(239)
Leslie.....	339(350)
Marievale.....	464(386)
St Helena.....	280(260)
Stilfontein.....	405(375)
Unisel.....	202(196)
WRCons.....	487(483)
Winkelhaak.....	208(195)
Deelkraal.....	365(359)
Doornfontein.....	334(313)
Driefontein.....	432(141)
Kloof.....	148(145)
Libanon.....	345(320)
Venterpost.....	454(437)
Vlaktefontein.....	308(308)
Randfontein.....	196(179)
WestAreas.....	432(410)

# SA pays for ignoring early '80s gold price

~~SA~~

~~SA~~

79

15/9/84 Star

The Star Bureau

LONDON — South Africa is now paying for its failure to abolish exchange controls in 1980-81 when a runaway world gold price provided a fine opportunity, according to *The Economist*

Referring to the recent Barlow Rand-Bibby deal, it says most of South Africa's big busi-

ness groups would like to have more of their interests abroad, caught up as they are in worsening recession at home.

Barlow, it adds, is ahead of the pack in this respect. But "there are a host of problems for other South African companies wanting to follow in its traces. A battery of exchange controls still impede corporations and individuals resident in

South Africa."

Even if these were reduced, the depreciation of the rand (down by 35 percent against the dollar in the past two years) is now a deterrent to exporting capital.

*The Economist* predicts the Government may become worried about money flowing out and other governments may be even more worried about money flowing in "from such a source".

"Businessmen think the SA authorities made a bad mistake by not dismantling or at least selectively waiving exchange controls during the 1980-81 gold boom. There would still have been obstacles to overseas investment, but almost any South African company that had invested abroad then would be showing a handsome profit now."

# SA gold mines are getting record rand prices for <sup>79</sup>bullion <sup>17/07 84</sup>

By Duncan Collings  
Deputy Financial Editor

Although the rand sawed wildly yesterday against a rampant US dollar, touching one new low after another, gold held up surprisingly well on world markets with the result that South African gold mines are receiving their highest rand price yet for their production.

The lowest point touched by the rand against the dollar yesterday was 55,70/77 US cents, while gold traded little changed at around the \$340 mark — as indeed it has done for quite a number of trading sessions now. This morning the rand traded lower again at 55,25c.

Based on this combination the country's gold producers will receive about R610 an ounce on gold sold overseas — the first time the rand gold price has exceeded R600.

Not even in the halcyon days of 1980, when the world gold price touched \$800, did the gold mines receive such a high income — because the rand against the US dollar was then in the 1,35 range, giving the mines only R595 for their production.

## VERY GOOD TAX PAYMENTS

By all indications the dollar has not yet run out of steam, although it dipped fractionally overnight in the US. Thus South Africa can look to a bonanza year in bullion production.

In practical terms this means the Government will receive extremely good tax payments from the industry, while its own outlay in terms of assistance to marginal mines — there is not a single gold producer running at a loss at the current rand gold price — will be extremely low.

This more-than-welcome bonanza will help the authorities to balance their books and keep off the pressure for another rise in South Africa's tax rates.

It is not only the gold mining industry that is benefiting from the low rand/dollar exchange rate. All the country's mineral exporters — such

as the chrome mines, manganese producers, the coal, antimony, iron ore and other industries — have generally had their contracts written in dollar terms.

Should the current agricultural season benefit from normal weather and production recover to average levels, the country will not only benefit from the exports that will result but also from being able to avoid costly imports of essential foods such as those in the past two seasons.

Thus, while the domestic economy may be in for a battering with business confidence generally extremely low, industries and companies which rely heavily on exports for their existence are in for a good year.

The devaluation of the rand should have also given South Africa's manufacturers an edge in world markets. Regrettably, this has not been the case.

South Africa's inflation — running at a rate at least double that of major trading partners — has eroded any price edge that may have resulted from the low rand rate, while the country's abysmally low productivity, too, has not helped the manufacturing sector on world markets.

Inflation and low productivity remain two of the major stumbling blocks the country must tackle before any progress can be made in terms of getting the economy moving again.

Last night the Finance Minister, Mr Barend du Plessis, told the 25th anniversary dinner of the Association of General Banks that the authorities were determined to win the battle against these twin evils.

He said that recent, somewhat draconian, measures adopted by the authorities would remain in place until the battle against inflation was won or at least was a long way down the road to having been won.

His message was clear. The country will have to bite the bullet now in expectation of better times ahead.

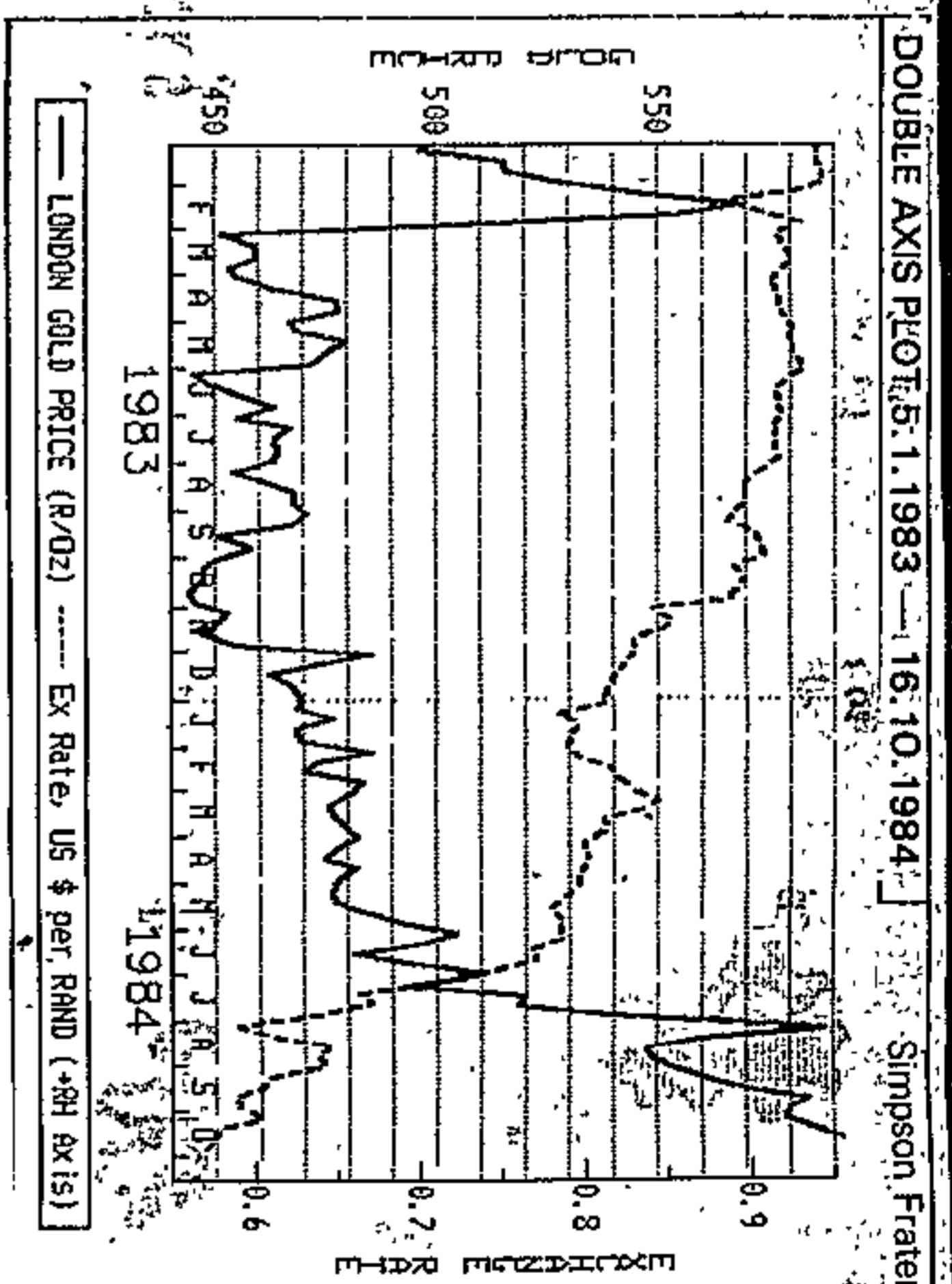

DAVID REES

# Factors affecting gold

79



David Rees is a senior lecturer in economics at the Graduate School of Business, University of Cape Town.

To a significant extent SA's real wealth depends on the very variable and unpredictable price of gold. It is sensible for us to pay close attention to the performance of the gold market and to adjust our personal spending and corporate business strategy accordingly.

Equally it is correct that we should speculate, at least in the intellectual sense, about the likely behaviour of the gold price in the future. Gold has been described as performing the Indian rope trick. It is wanted because it is valuable: it is valuable because it is wanted.

This, perhaps, is a rather mystical view of the gold price but our attitude to it sometimes approaches the semi-religious. We hope against hope that the gold price will rise, that it will do for SA what oil does for Kuwait; and that we may get a free ride out of our oppressive political and economic problems.

This attitude is in marked contrast to the atmosphere prevailing in the Fifties and Sixties. Then, the one stable factor in the economy was the gold price, which was fixed at US \$35/oz and remained there year after year. But the Seventies brought a breakdown in the international currency system. The ambiguous advantage of a stable gold price has now been removed. South Africans must instead learn to live with the new uncertainties inherent in the international gold market.

The gold market is efficient in the sense that there are no statistical regularities or seasonalities which enable us to play the market — gold is the real gamble. And whether we like it or not, in SA we are all to a substantial extent taking a position on gold. When the gold price rises so, too, do our real incomes. When the gold price falls, so do our incomes and, in addition, tax rates rise.

In other words, our incomes are procyclical with the gold price. Not content with this, many South Africans purchase gold coins or gold shares, gearing their portfolios even more to a single commodity of extremely volatile performance. Added to this, when the gold price falls, so does the value of the rand,

and again South Africans are poorer and spend less abroad.

Government tax revenues fall as personal incomes and expenditures fall. To maintain revenues it is necessary to increase gst, thus further emphasising the fall in real incomes experienced in SA. The experience of the last few months is too recent to require further emphasis.

South Africans who hold gold are putting all their eggs in one basket. Gambling is naturally a matter of personal preference against which no criticism can be launched. The peculiar thing, though, is that South Africans often believe that holding gold is a move in the direction of wealth stability.

It is worth noting that the gold market is a market in stocks, not flows. People don't throw gold away: they look after it. A proportion is used in industry but this is small compared to the world gold stock. So, too, is SA's contribution of new gold to this gold stock. This means that the influence which SA can exert on the world gold price is minimal, even in the short term.

Even though the gold market is efficient (and thus devoid of buy/sell signals and other chartists paraphernalia) there is something we can say about it. At the margin (where prices are established) gold must offer a return competitive to other investments. An investor in the US has the choice of investing his US \$350 in the bank for say 12%/year or of purchasing another Krugerrand. But he will only purchase the Krugerrand if he anticipates that the price of gold will rise by at least 12%/year, otherwise the bank account is the better investment.

If he purchases the Krugerrand he will buy it from a seller who has made the reverse calculation. On the balance of probabilities, therefore, the gold price must rise at the interest rate, say 12%. Currently the gold price is lower compared with a year ago but interest rates prevailing in the US are high. The prospect is for the gold price to rise from current levels fairly rapidly, giving a price of, say, \$400 in 12 months' time. This is, however, definitely not a forecast. It is a deduction based on established economic principles. Also, of course, you can't make any money on it. A savings account would be as good an investment.

Numerous factors at various times have been presumed to affect the situation but frequently do not. The current tension in the Middle East, for example, or the Lebanese conflict and the Falk-

lands War — all seem to have done little for the gold price. Inflation in the US, combined with taxation arrangements whereby capital gains are preferred to income, probably account for the major share of the gold price rise in recent years.

In addition, there appears to be a negative relationship between the gold price and real interest rates in the US; that is, interest rates net of the inflation rate. Real interest rates have reached record levels in the US over the last few years and as long as they remain high the prospects for gold do not look encouraging.

If South Africans have yet to learn to live with a fluctuating gold price, so too have the SA monetary authorities. Our system of exchange control has to an unknown, but possibly substantial extent exacerbated the effect of a fluctuating gold price on the economy. Consider the position of a South African who, in defiance of exchange control, kept a proportion of his portfolio in Zurich, London or New York. A fall in the gold price would be far less traumatic than for his more patriotic cousin who, let us say, kept his entire portfolio in gold in SA. For the diversified investor, a fall in the gold price may be amply compensated for by an increase in the value of his dollars.

## Tax revenue

His contribution to SA tax revenue via income tax or gst remains likewise unaffected and generally he exerts a stabilising influence on the SA economy. He may even repatriate funds from overseas to finance this, thus supporting the exchange rate.

Exchange control makes South Africans more like the second individual than the first. The second investor, in response to a fall in the gold price sensibly reduces his expenditure immediately and substantially. From private choice as well as through official policy we have become a society highly geared to a single variable.

The lesson of the last few years, and more emphatically of the last few weeks, is that a strategy on a private and corporate basis must be carefully considered. It is dangerously wrong to assume that in the future the gold price will not fluctuate and in so doing influence both the exchange rate and domestic interest rates.

To assume that the gold price will rise faster than prevailing interest rates in the future is simply wishful thinking.



# Gold spurts over \$350 with heavy share buying

CAPE TOWN 14/11/84  
79

By PAUL DOLD  
Financial editor

THE South African economy received its best news in weeks yesterday, with gold spurting to above the \$350 level and the rand firming.

Today's excellent results from Amcoal also show that export industries' particularly mineral exporters have been benefitting heavily from

the weaker rand.

The rand closed at 57,90 United States cents after touching 58,20 at one stage with the stronger performance reflecting both the improved gold price and the weaker dollar.

Gold rose to \$350,45 at the late fix yesterday and closed at \$350,45, well up on the previous close of \$346,75.

United States futures markets opened strongly with the key Comex market rising \$3 to \$3,50 an ounce in moderately active trade.

The December contract was \$3 up at \$352,20 an ounce after touching a peak of \$352,40.

Gold is rising due to continuing expectations that the United States Federal Reserve will soon announce a cut in interest rates. The dollar has been weakening in foreign exchange mar-

kets amid speculation of a cut in the Fed's discount rate.

United States analysts say that the stable US inflation rate — the producer price index fell by 0,2% in October — has given the Fed ample room to allow rates to ease.

This will lead to a lower dollar and a higher gold price.

Investors, sensing that interest rates may be heading lower, bought gold shares heavily yesterday and the gold board led a broad advance across the market.

Turnover in the top 10 gold shares traded were all well over the R300 000 mark with Vaal Reefs touching R781 000.

The marginal mines which stand to benefit most from a higher gold price showed the heaviest gains on the gold board.

## Traders fear a new run against bullion

# Gold falls below key \$330 support level

STAR 28/11/84

329

By Duncan Collings  
and Associated Press

Gold slipped below its psychological \$330 support level overnight in the US and this morning on other world markets, prompting fears among many dealers of a new run against the metal.

It has generally been agreed that should gold drop below \$330 there would be very little to stop it sliding to \$300 and even below.

Bullion's current weakness comes in the face of persistent strength of the dollar, despite generally declining interest rates in the US.

In New York, bullion and currency dealers said that the dollar staged a late rebound overnight, wiping out most of its earlier losses, and the price of gold continued a retreat that has pushed it to a 28-month low.

### CHANGING PERCEPTIONS

Republic National Bank in New York said gold bullion was bid at \$328 in late trading, down \$3,75 from the late bid on Monday.

Mr Gary Dorsch, a foreign exchange analyst at Oppenheimer Rouse Futures in Chicago, linked the dollar's rise and gold's fall to changing perceptions among traders on the outlook for economic growth and the price of oil.

Mr Dorsch said currency traders had resumed their pursuit of the dollar out of concern that an economic slowdown in the United States could have an even more pronounced effect on countries that rely heavily on sales of goods to US markets, such as Japan and West Germany.

He said that the decline in world oil prices has raised worries about prospects for sales of precious metals by Middle East investors seeking to convert their holdings into high-yielding United States Government securities.

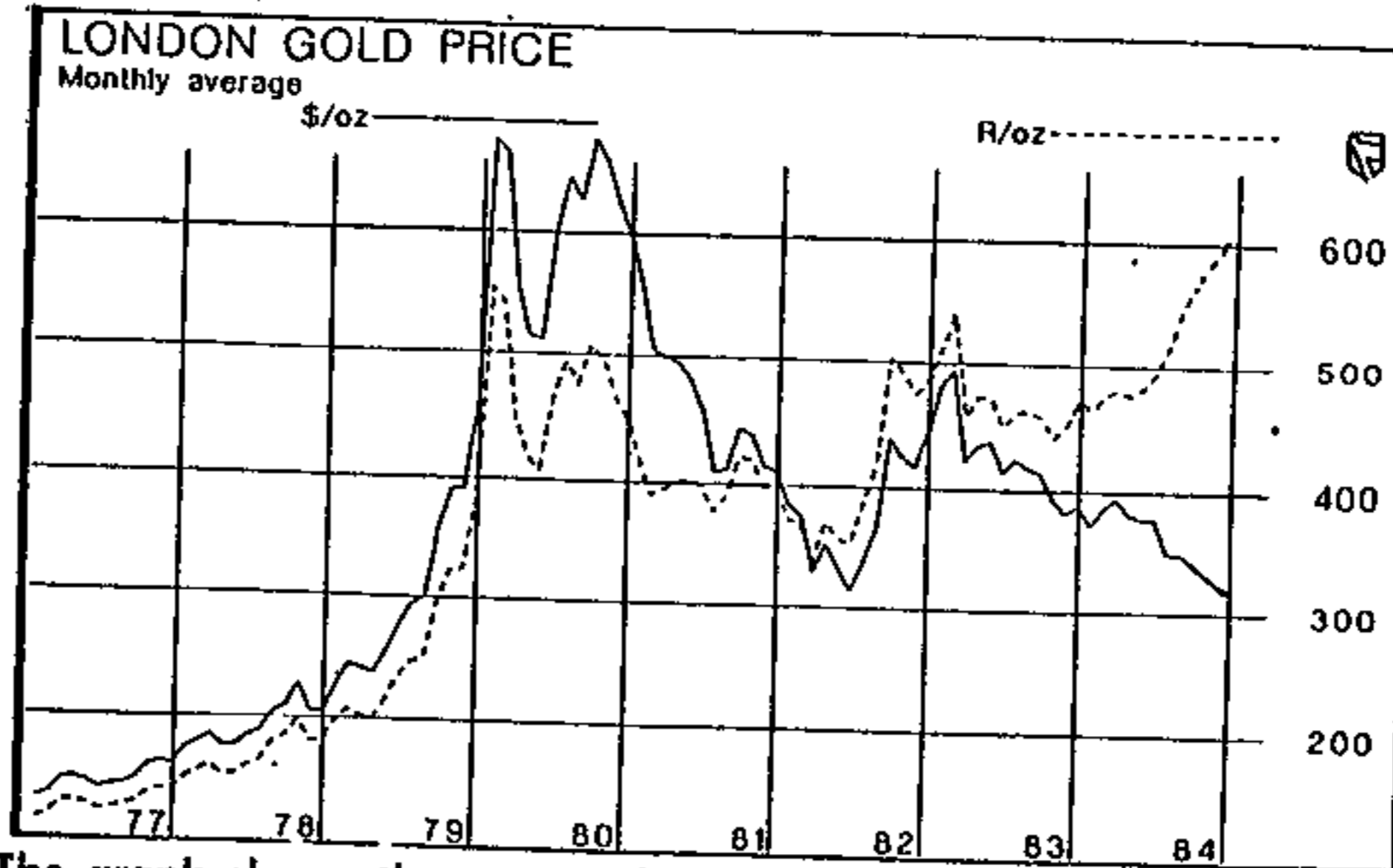

The graph shows the ever widening gap between the dollar and rand prices of gold. Compare today's situation with that of 1980 when the roles of the rand and the dollar were reversed.

curities.

Analysts said there was no significant impact as a result of Chase Manhattan Bank's move to undercut its leading competitors and lower its prime lending rate to 11,25 percent from 11,75 percent.

The prime rate at other large US banks ranges from 11,5 percent to 12 percent.

Mr William Orsini, a foreign exchange analyst at the New York branch of the Bank of Montreal, said traders were shrugging off the latest declines in United States interest rates because they believe rates will resume climbing next year because of the growing US deficit.

He said that even though rates had been falling in the US, recent declines in interest rates in Canada, Britain and West Germany had kept returns attractive on dollar-denominated investments.

In New York, the British pound slipped to \$1,20125 from \$1,2036 late on Monday.

On the New York Commodity Exchange, gold bullion for current delivery fell \$3,90 to close at \$327,30 an ounce. That is the lowest finish since the \$322,60 of July 8, 1982.

And on European markets this morning and in Hong Kong

gold traded at around the US closing level.

However, as gold has fallen with the rising dollar, so the rand has weakened further this week dropping below 55 US cents again, to close yesterday at 54,50c.

This morning it weakened further dropping below 54c to around 53,80c in early trading.

### TRADING NERVOUS

At this level the gold mines are still receiving over R600 an ounce for their production — the highest income since 1980 — and for this reason gold shares on the Johannesburg Stock Exchange have been largely unmoved by gold's latest falls.

Gold shares are trading at generally steady levels, although trading is extremely nervous.

One dealer said that in practical terms gold shares remain a good buy at present gold prices, but investors are inevitably psychologically affected by the falling dollar price of gold.

And any strengthening of the rand — possibly as a result of South Africa's steadily improving balance of payments situation — would immediately make gold shares look highly overpriced.

# IN-THE-NEWS: new bid to get ban in US

By Gerald L'Ange,  
The Star Bureau

WASHINGTON — Battlegrounds are being drawn on Capitol Hill for another fight over South Africa's biggest export to America — Krugerrands.

When Congress convenes next month, new legislation to bar the sale of Krugerrands is expected to be introduced by the Congressmen who failed earlier this year with similar efforts.

And the lobbies who helped defeat the attempted ban will again spring to the defence of Americans' right to own Krugerrands.

About R900 million in Krugerrands were bought by Americans last year, making them the biggest single American import from South Africa.

Krugerrands sales exceeded in value even America's imports of chrome, platinum or uranium.

Partly because of the high volume of the sales, but also because they make convenient symbols of South Africa and its racial policies, anti-apartheid activists have concentrated their banning efforts on the Krugerrands in preference to other South African imports into America.

"They're a symbol of South Africa," said Democratic Congressman Stephen Solarz. He sees a Krugerrand ban as a creative way to put pressure on South Africa.

## NEW TACTIC

Earlier this year the proposed ban was attached to the Export Administration Act in an unsuccessful attempt to ride it through Congress.

What tactic will be used this year is still uncertain. Whatever it is, it will be opposed by the Free the Eagle lobbying group which mounted an intensive campaign against the earlier banning bid.

Headed by Mr Howard Ruff, a California conservative activist known as a "Gold Bug", the lobbying group includes precious metal dealers and investment counsellors.

Mr Ruff helped defeat the proposed ban with a computerised campaign that flooded Capitol Hill with telegrams from Krugerrand owners.

Mr Neal Blair, Washington lobbyist for Mr Ruff's organisation, argues: "If they can ban the Krugerrand they can start restricting our freedom to invest in other ways."

Supporters of the ban ignore the fact that Krugerrand profits, unlike gold bullion, do not go to the South African Government but to the Chamber of Mines, says Mr Michael Vigil, deputy chief executive officer in New York of the chamber's offshoot, International Gold.

"The irony of this," says Mr Vigil, "is that the sale of the Krugerrand benefits private industry, while the sale of gold bullion benefits the Government."

"So, if anything were to stop the sale of the Krugerrand, the South African Government would just sell more bullion."

Dealers selling Krugerrands have become a target of the anti-apartheid demonstrations which started outside the South African Embassy in Washington last month and have spread to other cities.

Demonstrations have been held outside the Boston premises of a coin and metals company, and other protests have been threatened.

Attempts to ban Krugerrand sales or impose any other form of economic sanction have been rejected as unrealistic by Dr Chester Crocker, US Assistant Secretary of State for African Affairs.

"It would perhaps produce a one percent discount in South Africa's gold export prices, because some other country would buy South Africa's gold and mint their own coins," he said. "It's not going to have any measurable impact on South Africa's behaviour or decision making."

*Gold hits 182*

# low as prime rate goes up

*CMT Tracks 18/12/84 28 79*

Own Correspondent

**JOHANNESBURG.** — The reeling South African economy received another two body blows yesterday from events on the local and international markets.

In London the gold price fell to below \$315 an ounce at one stage which is the lowest level recorded since July 1982, while at home the prime interest rate was increased by one percent to 24 percent.

Indications are that things could get worse with gold analysts expecting gold to drop to levels around \$300 an ounce while bankers believe the prime interest rate could again hit 25 percent.

### Heavy slumps

The increase in the prime interest rate indicates there will be no early let-up of the austerity measures aimed at forcing South African consumers to live within their means and curb the country's high rate of inflation.

The high interest rates have caused heavy slumps in sales of furniture, cars and durable goods such as refrigerators and have brought protests from business-

men who claim they are being forced out of business by the measures.

Insurance giant Sanlam believes the poor business conditions will continue until late 1985 and the months ahead will make great demands of both businessman and consumer.

Sanlam believes, however, that the stringent restrictive measures are an essential adjustment to the economy and should not be relaxed too rapidly.

"If this were to happen, South Africa would once again merely experience a premature and short-lived upswing," the group says in its latest economic review.

### Political move?

The overdraft rate has now changed three times in four weeks. These erratic moves within a very short space of time have resulted in businessmen questioning whether the prime rate should have come down in November in the first place.

When the Standard Bank cut the prime rate in November, some observers held that the adjustment in the rates had been politically inspired to strengthen the government's hand in the Primrose election — particularly as the Reserve Bank had responded with such alacrity by cutting its re-discount rates by 1 percent.

But political motivation has been strenuously denied by people in banking and by the authorities.

### Rand slips

The immediate effect of yesterday's slide in the gold price was a drop in the value of the rand to US\$0.5265 from Friday's closing level of US\$0.5330.

The low rand has benefited many exporters who are earning more rands for their products sold overseas, but it poses major problems for South Africa's inflation rate which remains at levels twice that of the

United States and the United Kingdom.

A persistent high rate of inflation has serious economic consequences for South Africa. Conversely, lack of inflation overseas is keeping the gold price low because the gold price is closely linked to international inflation.

### Disinflation

Unlike South Africa, the major Western nations have experienced disinflation for several years and this trend is likely to continue. Despite high unemployment, governments from the UK to the United States are intent on controlling inflation.

The international oil market is also helping reduce inflation. Oil prices are weakening because of excess supplies. Lower oil prices are negative for gold because they reduce international inflation and the buying power of sheikhs and other Middle Eastern citizens.

Middle Eastern deposits in the Eurodollar market also decline, so international money supply shrinks. There is less money around to buy an asset such as gold which does not produce income.

### 'Hangover'

"Gold's two-year hangover shows little sign of ending; without the return of inflation the gold price won't pull out of its dive," comments Euro-money, the international banking magazine.

Even though jewellers' demand for gold improved this year, it cannot absorb all the supplies. Investors and possibly central banks must buy the rest. This demand, however, is weak.



Hansel and Gretel of these sweet-tooths resist this 230 kilogram City hotel and made The visitors from Jo Lara I

## Three

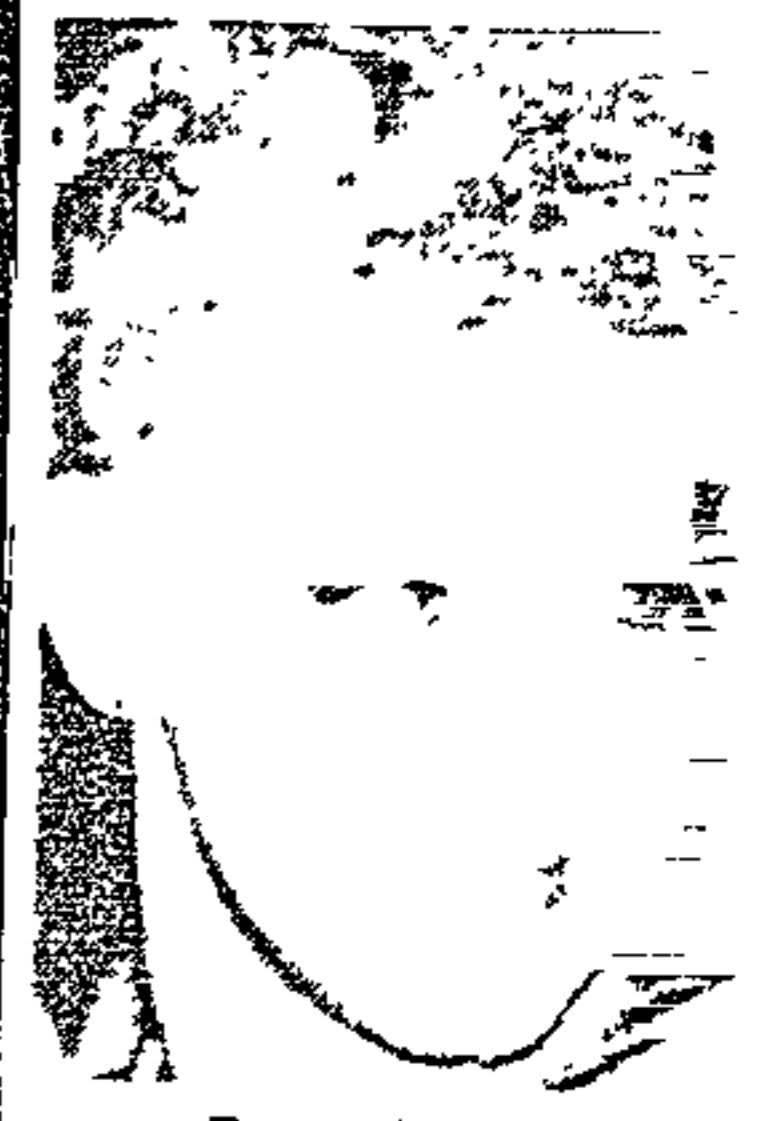

Bette Midler

## Bette

Own Correspondent

**NEW YORK.** — Bette Midler's ten outrageous sing caught everyone by surprise over the weekend when she had announced she had got married. On Saturday evening she was in Las Vegas, where she had quickie weddings, the

**ROMENS SIZZLING SUMMER SELL OUT NOW ON**

**crack of dawn**

"I hope the security police posted early for Christmas. Just in case they sent their Christmas cards to the wrong address."

**crack of dawn**

"I hope the security police posted early for Christmas. Just in case they sent their Christmas cards to the wrong address."

By Duncan Collings

Gold continued its relentless downward slide on world markets this morning as selling pressure from a number of quarters built up, and the metal is expected to fall below the \$300 level soon.

In Europe there is talk of bullion falling rapidly to \$250 before any strong resistance is felt.

The metal quickly dropped to about \$306,50 on the key European markets this morning — down about \$9 from last night's closing levels — before steady- ing at about \$307,50.

And on the local foreign exchange market, the rand was forced lower dropping to 51,50 US cents at midday — down about 1,5c from overnight levels. The local currency is now hovering very close to its record low level of 50c.

At today's rand/dollar rate the rand price of gold of R595 remains close to R600 an ounce — a level at which it has stood for some time now.

#### LONG POSITIONS

Thus the latest fall, as far as the gold mines are concerned, will have little effect on South Africa's revenue received from gold.

In Zurich, some bullion dealers said the sell-out this morning and yesterday was triggered by liquidation of long positions by major operators, including the Soviet Foreign Trade Bank.

Others did not exclude the

# Gold is expected to fall below \$300 soon

STAR 18/12/84 79

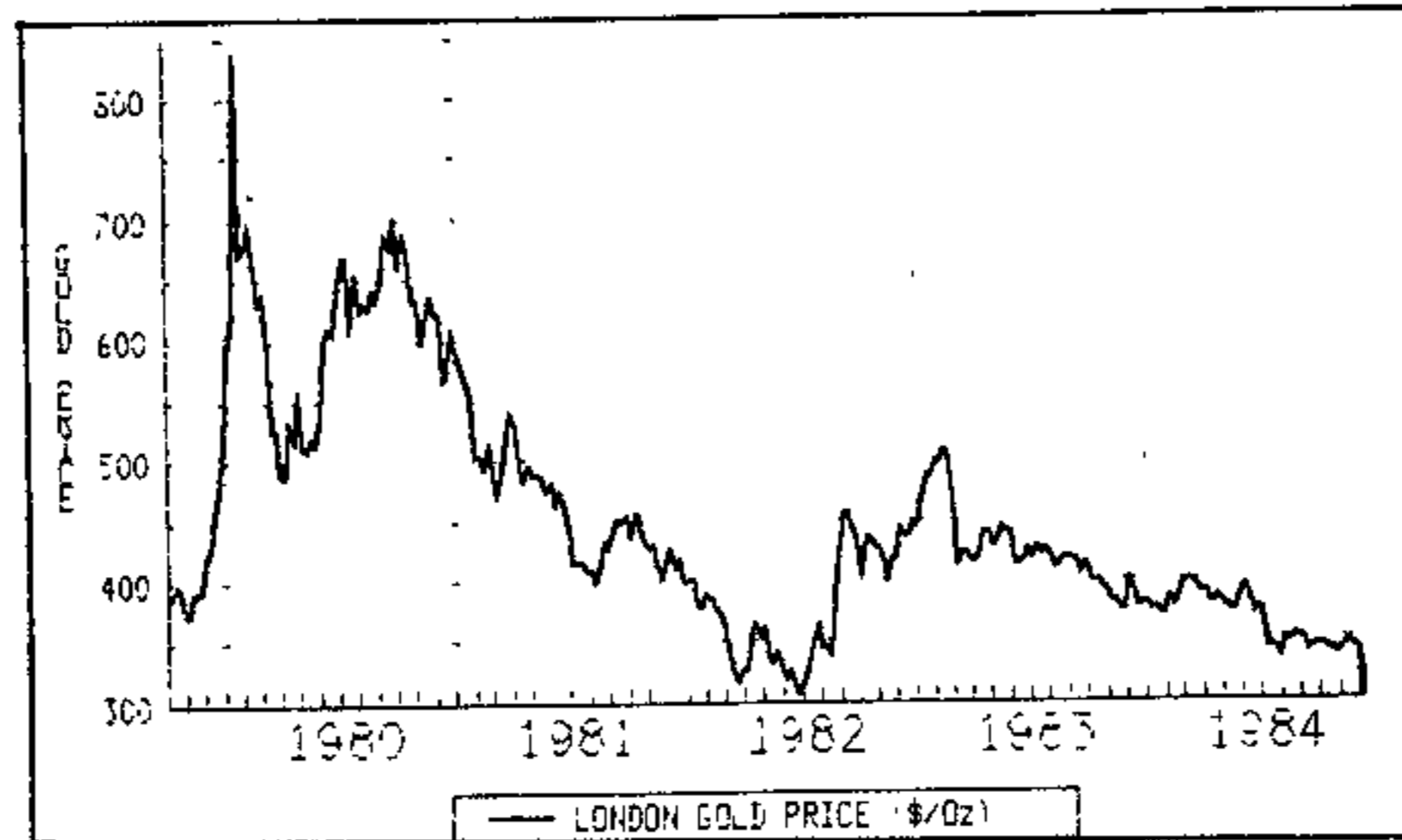

possibility that some selling was speculative. All said liquidation of long positions seemed the main reason.

But they said that later today the price was not likely to come under further pressure, although they felt that after the opening of US markets stop-loss selling and commission house selling could take the price even lower. Later this week the price was likely to fall towards or below \$300, they said.

Volume was fairly thin. In the absence of demand from customers and with thin industrial demand the price was vulnerable to falls on relatively few

major sell orders, they said.

The metal fell through the \$320 an ounce resistance level yesterday, closing in the US and Europe at about \$315. It traded down so quickly towards and through the next bench mark of \$310 that there is every chance of it slipping through \$300 soon.

Some bullion traders said the latest gold price decline came despite a lower dollar and easier US interest rates, factors that usually tend to boost demand for precious metals.

Throughout 1984, the gold bullion market has been depressed by the strength of the dollar and a belief that the world economy has been weaned off inflation at least for the moment.

Mr David Nelson, a precious metals analyst at investment firm Dean Witter Reynolds Inc, New York, said gold fell because traders were "looking at the Opec meeting this week as being unsuccessful in stemming the fall in world crude oil prices".

Gold's dull performance this year saw investors abandon the metal for more attractive investments. "No-one wants gold," a senior Zurich trader said.

Another trader predicted the price could fall as low as \$250 an ounce. "There are just no buyers around. The next resistance point for gold is around \$290 an ounce. After that it could go as low as \$250."

The *Financial Times* Lex column today says that it is not easy to construct a convincing case for buying gold. In almost any currency other than the dollar the price has remained remarkably stable this year.

Expressed in sterling terms the price was the same last night as at the beginning of January.

The rapid depreciation of the rand has ensured a steady supply from South Africa, which shows no sign of abating, while the progressive lowering of inflationary expectations in developed economies has made gold practically redundant as a hedging instrument.

If low inflation is accompanied next year by a falling rate of growth in OECD countries the rise in industrial demand could fail to keep pace with supply.

The strength of physical demand from Japan and Hong Kong has been about the only positive feature of the gold bullion market this year.

So for unrepentant enthusiasts of the metal, the Far Eastern origins of yesterday's sell-off must have been especially galling. But there are precious few enthusiasts left, says the *FT*.

# 'Now's the time to buy oversold gold' for quick profit

STAR  
21/12/84  
79

## Financial Staff

Holcom, South Africa's leading commodity broking firm, after having advised clients on October 29 to sell gold forward in the face of an expected crack below the then current price of \$337 is now recommending the purchase of the metal.

The firm says: "While not an-

icipating a major turnaround in sentiment, we recognise that the recent sharp decline has put the market into a considerable oversold position."

The decline in gold values through the \$330 level had induced a wave of investor liquidation over the last fortnight.

Lower oil prices, continued

deflationary policies in the Western economies and the relentless strong dollar had prompted this dis-hoarding.

Holcom says it appears potential new buyers are standing by for the present, and the market currently lacks an area of support.

"However having maintained a bearish stance throughout much of this period we are now of the opinion that buying opportunities are on the horizon".

Having witnessed activity of this nature (oversold) in the past, such signs usually lead to a significant bounce which could constitute a rally up to the last break point of \$330.

"Of course, fundamentally the picture does not look healthy for gold, but one should consider that the current level of \$305 has already discounted a lower oil price, a lower inflation rate and lower US interest rates."

A major part of the local mining houses hedge selling has already been done, and overseas central government activity is unlikely to encourage additional sales at current low levels.

So perhaps in the short term, with the major present fundamentals accounted for, a temporary turnaround is in the offing.

Rallies are often fast and furious in these circumstances, especially on the evidence of sizeable short positions now being held within the futures market.

If values hold the psychological \$300 support level then those in short might be keen to cover, fuelling a sharp advance.

From the technical point of view, major cyclical lows are anticipated now, and the present price levels may not be seen again throughout 1985.

Holcom says it recommends taking profits on all short (sold) positions and accumulating (long) bought positions in the \$260 to \$300 range.

## Opec's wrangle boosts the dollar

NEW YORK — The American dollar rose against most major currencies in worldwide trading yesterday, with the British pound tumbling to a record low in London for the second straight day.

Gold prices edged closer to the \$300 an ounce level. Republic National Bank in New York quoted gold at \$307.50 a troy ounce, down 80 cents from Wednesday's late bid.

In Hong Kong this morning gold opened at \$307.60 and at \$307.25/80 in Zurich.

The pound is under pressure from fears that world oil prices will keep falling, eroding Britain's revenue from its North Sea oil holdings. But the dollar is drawing its present support because lower oil prices would help limit US inflation.

### UPTURN IN RATE

"The underlying strength in the dollar emanates from weakness in the oil market and fears that Opec Ministers will be unable to come up with an agreement that will ensure stability in oil," said Mr Gary Dorsch, currency analyst with Oppenheimer Rouse Futures in Chicago.

Mr Dorsch said the dollar also was bolstered by an upturn in the Federal Reserve Board's

funds rate, a closely watched rate charged on overnight loans between banks.

The rate climbed to 8% per cent from below 7 percent late Tuesday. And as United States interest rates rise, so do yields of dollar-denominated investments.

In London, the pound hit \$1,1635 in early trading before recovering to close at 1,1640. Both prices were lower than the previous trading low of \$1,1715 and the previous closing low of 1,1735, both set on Wednesday.

But the pound managed to inched higher in late US trading to \$1,1700 from \$1,1690 late Wednesday.

The dollar also rose against the West German mark despite open-market sales of \$50 million to \$100 million by the West German central bank, the Bundesbank, dealers said.

In United States activity, the dollar rose to 3,1250 D-marks from 3,10725.

Gold prices fell to their lowest in 30 months as the prospect of lower oil prices made the metal less attractive as an inflation hedge.

On the Commodity Exchange in New York, gold for current delivery lost \$1.40, to \$307.30. — AP.

# Gloomy outlook as gold, rand slide

CAPG

Times

4/11/85

79

BY PAUL DOLD  
Financial Editor

**GOLD cracked below the \$300 level for the first time in 2½ years yesterday while the rand plummeted to less than half a dollar, reflecting the gloomy outlook for the South African economy this year.**

The gold price was set at \$299.50 in London yesterday morning and remains weak although it recovered slightly to \$302.30 in the afternoon, closing at \$303.

The rand tumbled to 48.95 United States cents at one stage in spite of Reserve Bank support, ending the day at 49.05 cents.

The lower gold price may lead to higher taxes in the March Budget unless government spending is curbed with the economy likely to show

no growth in 1985.

There is also persistent speculation among businessmen that the authorities, faced with a diving rand and high inflation, may reintroduce direct controls over the economy.

Last night Mr Raymond Parsons, chief executive of Assocom, warned that the time had come for South Africa to put its economic house in order, adding that the growth in both State spending and the money supply had to be slowed.

"The coming months will undoubtedly be a test of nerves for policy-makers and businessmen in South Africa. There is no room for wishful thinking in the wake of the most recent developments.

"Given the unfolding economic scenario both externally and internally, decision-makers in the private and public sectors are possibly facing the most serious year of stagflation (no growth combined with high inflation) in 20 years.

## Margin for error

"The policy options are limited and the Reserve Bank cannot be expected to support the rand indefinitely. The rand will remain volatile and the overall situation also suggests that the margin for error in 1985 is now small. The Budget arithmetic has to be correct this time round."

Gold shares on the Johannesburg Stock Exchange have been steadily retreating in the wake of the low gold price and more than 40 points have been pared from the gold-share index which measures the market's performance in recent days.

Most leading bullion dealers are pessimistic on the metal's short-term prospects, taking the view that the price will remain weak for some time.

## Market decline

The soaring dollar, prospects of higher interest rates and low oil prices have wiped billions off the market value of shares in Wall Street and in the London stock market. The British market tumbled yesterday in the wake of Wall Street's decline, with share prices falling 2-billion pounds. British investors fear that the Bank of England will raise interest rates sharply to defend sterling which is falling sharply as the dollar soars. Low oil prices are also placing pressure on sterling.

The key Financial Times index fell nearly 17 points at one stage, bringing the two-day loss to 28 points.

● The Reagan administration estimates new project deficits of \$217-billion in financial 1986, \$233-billion in 1987 and \$228-billion in 1988.

● White House raises deficit projections, page 12

● How the rand has tumbled, page 12

# Gold profits soar as dollar pushes rand to new lows

ARGUS 16/1/88  
By TOM HOOD  
Financial Staff

MANY South African gold mines are reaping record profits as a result of the United States dollar pulling the rand down to its worst level.

More mines today reported huge increases in profits for the December quarter — when their income from gold was far below today's rand price of gold.

They will now get about R700 an ounce for their gold — 52 percent more than a year ago when the rand price of gold was R464.

The rand has dropped 46 percent, from 80 cents on January 16 last year to about 43 cents.

## LOWER-GRADE ORE

Some mines are taking advantage of the high price and switching to lower-grade ore that was previously unprofitable.

The giant Randfontein mine's profits jumped 64 percent to R75-million after tax for the December quarter.

Other mining profits reported are Western Areas, up 12 percent to R18-million; Hartbeestfontein, up 15 percent to R30,4-million; Loraine, R11,8-million, up 55 percent; Prieska Copper, R10,2-million, up 30 percent; Consolidated Murchison, up 62 percent and Harmony, R33,8-million, up 34 percent.

The rand, meanwhile, rose to

## Gold at \$302,45

GOLD was fixed at \$302,45 in London today, up on the New York close of \$301,65 last night.

The rand was quoted at 43,55 US cents in Johannesburg, up from last night's 42,95 cents and the record low of 42,85 cents yesterday.

between 45 and 48 US cents in New York last night after speculation that South Africa might bring back foreign exchange controls in a bid to check the rand's plunge against the dollar.

## "MOUSETRAP"

After falling to a record low of 42,30 cents in Johannesburg yesterday, the rand was quoted at 43,55 cents today.

However, the governor of the Reserve Bank, Dr Gerhard de Kock, responding to the New York speculation, said today the bank had no intention of reintroducing foreign exchange controls on non-residents.

"South Africa does not want to change the rand into a mousetrap currency, something that one can get into but not out of," he said.

The rumours centred on the possible reintroduction of the financial rand and a possible limitation on the speculative positions of the foreign branches of South African banks.

● See Page 15.

C  
a  
t  
a  
C  
o  
p  
r  
w  
C  
pr  
ua  
pr  
io  
th  
th  
pr  
m  
pr  
wo  
me  
por  
a la  
cos  
...  
tha  
the  
the  
said  
Sh  
DU  
ban  
afte  
the  
10.30  
spon



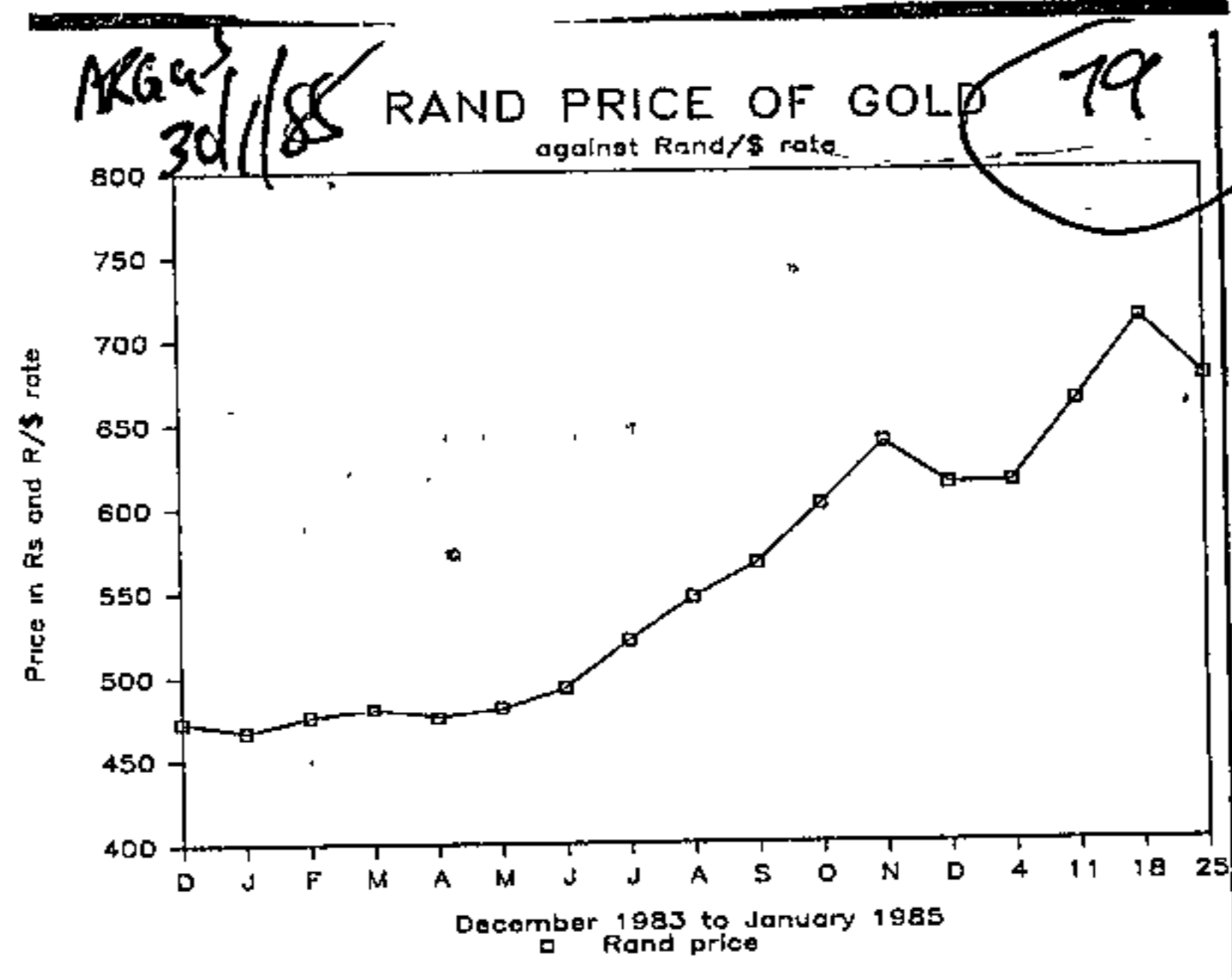

The gold mines have been enjoying a bonanza in the past few months as the weakness of the rand caused the local gold price to soar. It rose from about R480 an ounce a year ago to almost R720 an ounce two weeks ago. However, the strong recovery of the rand in the past few days has seen the local gold price drop back sharply to below R620 an ounce at last night's closing exchange rates.

## Gold at \$303

GOLD was fixed at \$303 (R601,19) an ounce in London today, up on the New York close of \$302,05 and yesterday's London close of \$302,65, Reuter reports.

The rand was traded at \$0,5175, dropping later to \$0,5040 in Johannesburg today, sharply up from last night's close \$0,4895, and the highest figure since before Christmas. It has gained about 18 percent since its record low of \$0,4195 on January 18.

The stronger rand has also knocked R135 off the rand price of gold from its record R736 on January 18.

### CENTRAL BANK DOLLAR SALES

The gold price was virtually sidelined as dealers awaited news of another possible drop in Opec oil prices.

The dollar turned higher in late trading in New York, reversing earlier losses. The prospect of central bank dollar sales kept the US currency from rising.

Traders were worried about intervention in concert with the Bank of England to defend the pound, which stabilised at \$1,1175 after falling to a record European low of \$1,067 on Monday. Today the pound edged up to \$1,1183 in London.

The improvement followed a 2 percent rise in banks' base lending rates. The London Financial Times estimated real interest rates in Britain were now at their highest level for at least 150 years.

The 14 percent base rates set by the commercial banks contrasted with a current inflation rate of 5 percent.

London gold fixings were:

	Dollars an ounce	Rands a kg
Today 10.30 am	303	19 328,87
Yesterday 3.00 pm	303,25	19 917,86

(79)  
**R1m off  
profits (49)  
for every  
cent rise**  
5 times  
17/2/85

By Roy Bennetts

ABOUT R1-million is knocked off gold-mine profits every time the rand rises by one US cent.

The rand's rally has already taken nearly R100-million from the mines' potential yearly pre-tax profits.

The rand's movement has had a greater effect on profits than the dollar price of gold which has remained steady for the past few months.

South Africa produces 680 metric tons of gold a year, the Rand Refinery smelting 90 000oz a day. Gold is sold for dollars and the mining houses are paid out by the Reserve Bank.

Although the mines are allowed to retain some of their dollars, they must eventually change them into rands.

### Offset

At a gold price of \$300 and the rand buying 43 US cents, the 90 000oz fetch \$27-million, or R62,8-million.

At the same gold price in dollars but at an exchange rate at 51 US cents the value falls to R52,9-million, resulting in a drop of R10-million in pre-tax profits to the mines.

If the gold price were to rise \$50 and a rand bought 51 US cents, the value of the daily smelt would rise by \$4,5-million, or R8,8-million.

To offset a 10 US cent increase in the value of the rand, the dollar price of gold must increase by \$73 an ounce.

As there is no chance of production costs dropping, the mines must hope for either a weak rand or a jump in the gold price to equal their profits of the past six months.

# Gold drops to 5½-year low as dollar surges

79

By PAUL DOLD  
Financial Editor

CAPE Times  
26/2/85

**THE dollar surged to new highs against leading currencies yesterday pushing gold down to a 5½-year low while the rand weakened.**

Unfettered by any action by the Federal Reserve to stem its climb the dollar rose to a 13½-year high of 3,45 marks at one stage in Europe although it came off the top at the opening of American markets to 3,43 marks.

There was chaotic trading on foreign exchange markets as the rampant dollar pushed sterling down to \$1,06 and left the Swiss and French francs sharply lower.

## Marked down

The dollar was reacting to indications by Mr Paul Volcker, Federal Reserve Board chairman, that United States interest rates might rise and President Reagan's statement that the United States would not intervene to stem the currency's advance.

Gold was marked down at the start of trading. After opening at \$295,85 it slipped to a fix of \$290

and then at one stage touched \$282,75. The metal was fixed at \$284,25 yesterday afternoon and closed unchanged at \$284,25.

Heavy North American selling on technical chart signals triggered gold's dive.

## Money market

Although gold shares eased, falls were limited and volume was low. Egoli with an eight percent decline was the largest fall of the day followed by Genbel's, Doorns' and Brackens' six percent.

The gold index fell only 15,5 points from Friday's close of 871,1

One feature of yesterday's market were several rises on the industrial board. Peggro added 40c, Pick 'n Pay which has been very firm 50c, Remgro 50c, Score 5c and Waltons 5c.

Tedelex which has been a weak spot rose 30c or 15 percent for the top

LONDON. — The following table shows how the world's major currencies have depreciated against the dollar since the start of 1984:

	Percent Change			Change Change	
	start of 84	start of 85	Midday y'day	start of 84	start of 85
Mark	2,7213	3,1420	3,4375	-20,8	- 8,6
Swiss fr	2,1795	2,5925	2,8950	-24,7	-10,5
French fr	8,3150	9,6150	10,5075	-20,9	- 8,5
Yen	231,60	250,53	262,88	-11,9	- 4,7
Sterling	1,4515	1,1635	1,0630	-26,8	- 8,6
Lira	1656,5	1923,5	2142,5	-22,7	-10,2

The rates are national currencies to the dollar, except for sterling which is quoted in US dollars. — Sapa-Reuter

gain of the day.

The rand performed reasonably well given the weak gold price. Although the currency touched a low of \$0,4590 in early trading after the \$0,4850 close on Friday it came off the bottom and closed at \$0,4685.

Money market rates hardened in the wake of gold's fall with the 90-day bankers' acceptance

closing at 22,5 percent from last week's 22,35 percent.

The shortage rose to just over the R1 billion mark and dealers expect it to increase further up to the month-end.

Gilts surged higher on the bearish gold price with Escom's 154 touching 18 percent as against Friday's close of 17,67 percent.

Bullion hits highest price in eight weeks, as rand rises to 51 US cents

# GOLD SOARS: \$307

AKGAS 19/3/85 (79)

By TOM HOOD, Financial Staff

GOLD took on a new lustre today as the price soared over the \$300 barrier by nearly \$13 in a day to hit \$307 an ounce in London.

This is its highest price for eight weeks. Benefits to South African mines, however, are offset by a rising rand which values gold at R614 an ounce against R736 on January 18.

The rand bounced over the 50 US cents level to 51,85c in the Johannesburg foreign exchange market today after 49,80c last night, bringing hopes of a slight lowering of inflation. Later the rand was quoted at 51,15c.

In three months the value of the rand has risen by nearly 10c or about 22 percent against the dollar.

Gold reached \$303,15 in New York last night and rose again to \$307,25 at the morning price fixing in London. Gold was as low as \$294 at one stage yesterday.

### Refuge for funds

Gold took its lead from a sharp retreat by the American dollar as traders on world markets turned to gold as a refuge for funds.

The dollar fell in New York last night as the extended closure of 70 Ohio savings and loan associations fanned worries about the American banking system.

Among currencies to shoot higher against the dollar were the British pound, which climbed more than three cents, and the West German mark, which spurted nearly seven pfennigs.

Cloudy prospects for the United States' economic growth are causing international investors to reassess the real returns available on other currencies, especially the British pound.

### Dollar's decline

The dollar's decline was a carry-over from a decision by Ohio's governor last Friday to close 70 state-chartered savings organisations following a run by depositors.

When that order was extended this week, traders viewed the problem as more complicated.

By the end of the trading day in the United States, the dollar had fallen to 259,35 yen from 261,05 yen late on Friday.

The British pound leapt to \$1,1160 from \$1,0845. Other dollar rates in New York, compared with late rates on Friday, included 3,31625 West German marks, down from 3,3855; 2,8235 Swiss francs, down from 2,8885; 10,1350 French francs, down from 10,3400 and 1,3805 Canadian dollars, down from 1,3875.

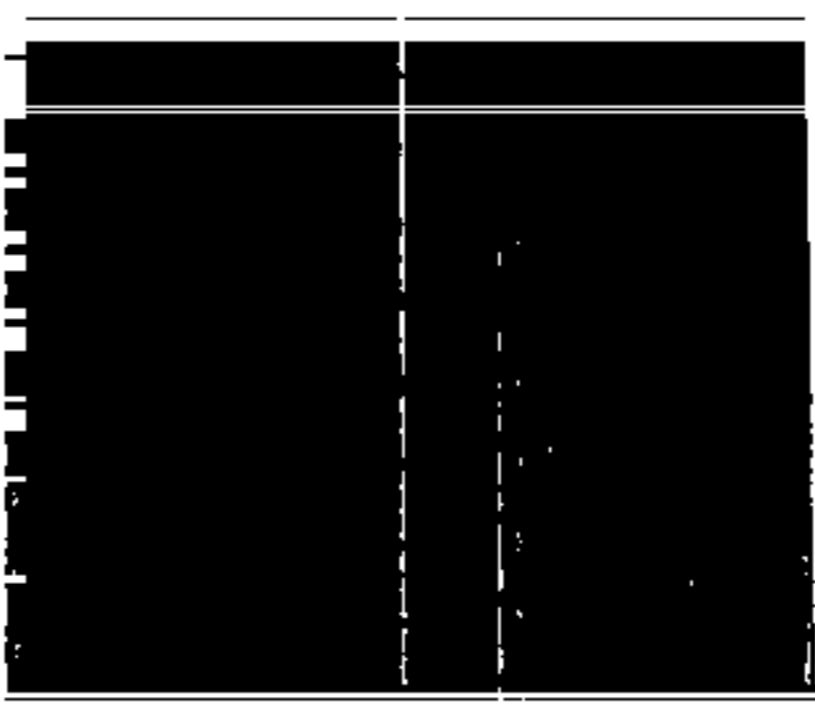

20/3/85  
Rush for gold  
(79) amid US crisis

By PAUL DOLD

A NEW American banking crisis has led to United States investors seeking refuge in bullion and gold shares and has sent the dollar sharply lower.

Gold shares rose strongly yesterday following the closing of 70 Ohio savings and loan associations after a run on the institutions by depositors.

American investors fearing more defaults by institutions hedged into bullion and gold shares.

Bullion surged to \$316,75 as the dollar tum-

bled for the second day and there was fairly heavy buying on the Johannesburg Stock Exchange with gold shares showing gains of up to 14 percent.

More than R500 000 trading was seen in several shares with Randfontein topping the R1-million mark.

The rand rose above the previous day's 50c to close at 52,05 United States cents yesterday.

The Ohio crisis which triggered heavy buying of gold comes at a time when the dollar is vulnerable to a temporary setback after its record climb of the past month.

The British pound rose strongly yesterday to close at \$1,1360.

● Gold closes at \$316,75, page 10

# Gold rock in biggest one-day leap for decade

Financial Staff

THE rush to buy gold sent the price up to \$337 an ounce today, a rise of about \$36 since yesterday morning and the biggest daily gain in more than a decade.

It was fuelled by the plunge of the American dollar on world foreign exchanges yesterday — the biggest one-day slide in at least 14 years.

The dollar recovered slightly in Tokyo foreign exchange markets today but the price of gold was steady in Far East markets.

After trading at \$337 in Hong Kong this morning, gold steadied later at \$332.

The rand is also benefiting and was quoted at 54 US cents in Johannesburg today — up from 52.05 cents last night and 49.80 cents on Monday.

The rush boosted gold mining shares on the Johannesburg Stock Exchange and R30-million of shares changed hands yesterday, treble Monday's business and the highest figure since February 1983.

Economists believe yesterday's gold rush may have marked a significant turn of market psychology against the dollar and toward precious metals.

They caution, however, that this sudden one-day rise could lead to profit-taking which could depress the price.

Among the currencies gaining sharply against the dollar was the British pound, which also has been helped by the recent rebound in oil prices, which raises the value of the United Kingdom's vast North Sea oil reserves.

The full effect of a banking crisis in Ohio began to be felt on the international markets yesterday.

On Friday 71 Ohio savings banks were closed following a surge of withdrawals sparked by the failure of the state's biggest savings and loan bank a week earlier.

## TRIGGERED

Dealers said worries deepened yesterday when the Financial Corp of America, parent company of the biggest US savings bank, American Savings and Loan in California, disclosed depositors had withdrawn \$286-million since March 8.

The rise in gold triggered sharp price increases too for platinum and silver. The London free market platinum price gained \$15 to reach \$270.25 an ounce.

MAGUS 20/3/85 (79)

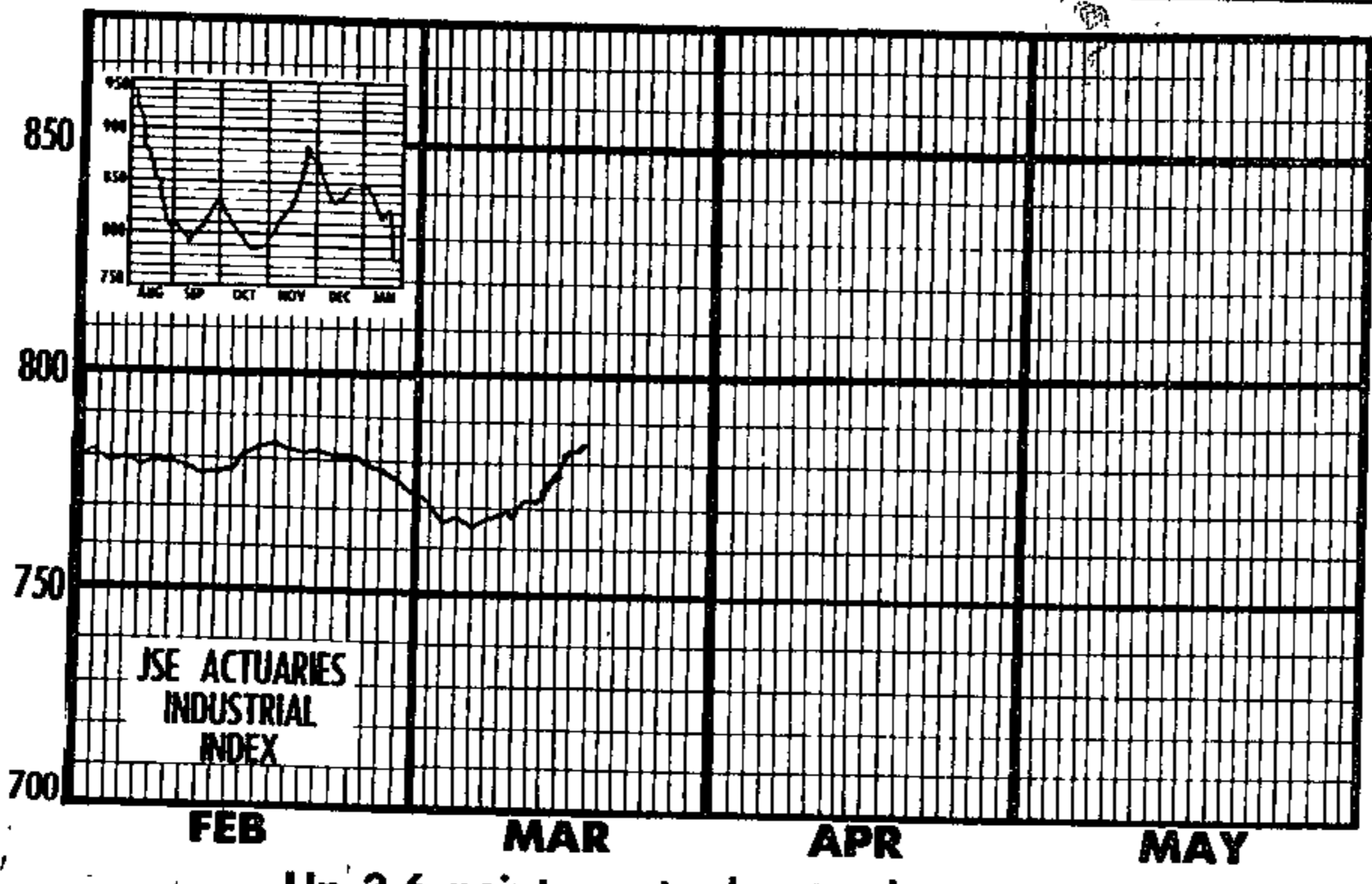

JSE ACTUARIES INDUSTRIAL INDEX

Up 3,6 points yesterday to close at 784,2.

# Gold at \$332,50

GOLD traded at \$332,50 (R619,20) an ounce in Hong Kong today after earlier prices around \$337, up from the London close of \$316,75, reports Reuter.

The rise was fuelled by fears that the United States banking system was in trouble and the plunge of the dollar on world foreign exchanges yesterday, which staged its biggest one-day slide in at least 14 years.

The rand was quoted at \$0,5370 in Johannesburg today, up from \$0,5205 yesterday and \$0,4980 on Monday.

The value of gold shares traded on the Johannesburg Stock Exchange yesterday was R30-million, the highest figure since February 1983.

London gold fixings yesterday were:

	Dollars	Rands
10.30 am	307,25	18 978,66
3 00 pm	316,75	19 565m47

# Gold fever grips the stockmarket

CAM Turk  
24/3/85  
79

By PAUL DOLD  
Financial Editor

AMERICAN and Continental investors bought millions of rands of South African gold shares yesterday, with bullion reaching \$347 amid the Ohio banking crisis but falling back again in late trading.

There was heavy buying of gold shares in Johannesburg as gold fever gripped the stockmarket for the second day.

Millions of rands' turnover were seen in individual shares: De Beers alone came close to the R3m-mark while the world's largest gold mine, Vaal Reefs, had trading of R1.5m, and mining house Anglo American ended the day with turnover of more than R1.25m.

There was heavy dealing in Driefontein, South Vaal and Loraine.

## Industrials

The buying spilled over into industrial shares. Blue chips such as Barlows, Foschini and Clicks were bid higher.

Although gold shares surged in the morning as the metal approached \$347, the shares came off the top later in the day on indications that some of the 71 Ohio savings asso-

ciations would reopen today.

Bullion fell back to \$324.00 at the late London fixing with markets losing some interest in Ohio.

Gains in gold shares were limited to five to 15 percent by the rand which rose to 55.15c at one stage.

The one-ounce Kruger rand added R27 to R622.

Last night the chairman of the Federal Reserve, Mr Paul Volcker, pledged aid to the savings associations.

"We are prepared to lend to them until they are deemed strong enough to reopen."

## Fall of dollar

While the plight of the Ohio institutions held the attention of stockmarkets, far more significant was the fall by the dollar — the steepest one-day decline in 14 years.

This suggests that the gold price may be reaching a turning point even though the temporary strength due to the Ohio problems could be short-lived. Mr Volcker told the National Cattlemen's Association that the United States Budget deficit was increasing the risk of depressing the dollar and boosting inflationary pressures.

• The volume of shares traded on the JSE yesterday was 6 690 574 valued at R40 084 824 compared with 7 530 414 valued at R30 262 582 on Tuesday.

• More reports, page 17

## BUSINESS BRIEF

Gold (close)	\$322.50
Rand	\$0.5220/40
FT index (close)	1 001.90
RDM 100	869.90
Dow Jones	1 265.24

aid in  
e con  
e bus  
es wh  
riate  
ei by  
"but  
her wit  
nia Ma  
fewer th  
includ  
d Ms Cil  
pm the C  
earing c  
tice J J F  
th Mr J J B  
ren as ass  
oster app  
Mr R Ta  
awalsky



# Gold fever grips the stockmarket

CMT-Tank  
21/3/85  
79

By PAUL DOLD  
Financial Editor

AMERICAN and Continental investors bought millions of rands of South African gold shares yesterday, with bullion reaching \$347 amid the Ohio banking crisis but falling back again in late trading.

There was heavy buying of gold shares in Johannesburg as gold fever gripped the stockmarket for the second day.

Millions of rands' turnover were seen in individual shares: De Beers alone came close to the R3m-mark while the world's largest gold mine, Vaal Reefs, had trading of R1.5m, and mining house Anglo American ended the day with turnover of more than R1.25m.

There was heavy dealing in Driefontein, South Vaal and Loraine.

## Industrials

The buying spilled over into industrial shares. Blue chips such as Barlows, Foschini and Clicks were bid higher.

Although gold shares surged in the morning as the metal approached \$347, the shares came off the top later in the day on indications that some of the 71 Ohio savings asso-

ciations would reopen today.

Bullion fell back to \$324.00 at the late London fixing with markets losing some interest in Ohio.

Gains in gold shares were limited to five to 15 percent by the rand which rose to 55,15c at one stage.

The one-ounce Kruger rand added R27 to R622.

Last night the chairman of the Federal Reserve, Mr Paul Volcker, pledged aid to the savings associations.

"We are prepared to lend to them until they are deemed strong enough to reopen."

## Fall of dollar

While the plight of the Ohio institutions held the attention of stockmarkets, far more significant was the fall by the dollar — the steepest one-day decline in 14 years.

This suggests that the gold price may be reaching a turning point even though the temporary strength due to the Ohio problems could be short-lived. Mr Volcker told the National Cattlemen's Association that the United States Budget deficit was increasing the risk of depressing the dollar and boosting inflationary pressures.

● The volume of shares traded on the JSE yesterday was 6,690,574 valued at R40,084,824 compared with 7,530,414 valued at R30,262,582 on Tuesday.

● More reports, page 17

GOLD

# Ready for a rise?

59

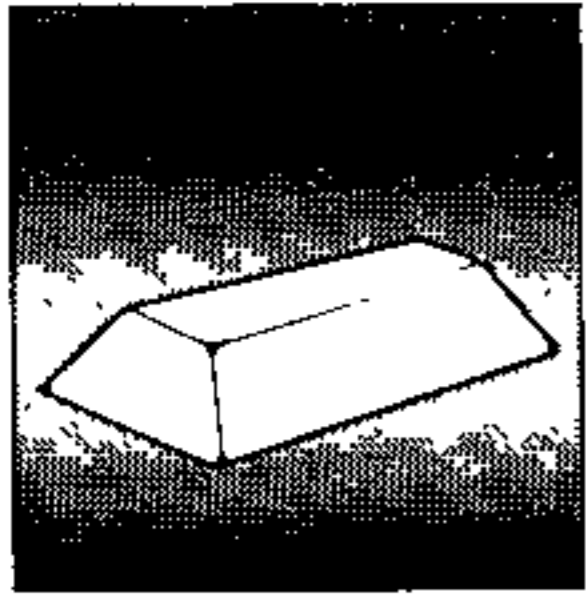

Gold is back on the international investment agenda. That much at least is certain after the tumult and violence on the foreign exchanges of the last six weeks which have seen a

sharp corrective crack in the dollar. So far gold, along with a host of other non-dollar financial assets, has simply reacted to this.

The physical demand which provided a safety net when bullion was "cheap" in the area around \$285/ounce and the dollar was rampaging to 12-year peaks or records against the major currencies, is now less evident. Nor has gold performed significantly better or worse than other dancers to the dollar's changing tune. From the low point reached on the New York Commodity Exchange (Comex), the April contract for gold had risen 18% by the end of last week.

Other, more highly-g geared metals, in terms of bear positions or trading volume, climbed faster. Platinum was 25% above its recent nadir while silver registered a 24% recovery on the Chicago Board of Trade. Sterling has roughly matched gold against the dollar but the metal has shown some "real" gains against other currencies. The yen price lifted by nearly 10%, having dropped 16% from the end-1983 level. In terms of D-marks, gold, which has for the last 15 months held at a consistent price marginally either side of DM1 000/ounce, put on 2,7%. (And, of course, the rand's recovery has knocked some 13% off the South African peak price attained in January).

Thus largely shorn of the old investment imperatives of inflation or international crisis, gold has, in a broad sense, behaved like a currency, or a non-interest bearing financial asset, rather than a commodity. Why then switch out of dollars into bullion rather than D-mark bonds? While the long-term downtrend of the last five years has yet to be broken, gold is building positive chart patterns which are exciting some technical analysts. In London, Anne Whitby of

In recent weeks gold has begun to look just a little more lively. Our European editor finds the outlook encouraging.



Henry Jarecki says gold is riding on credit market problems

Chart Analysis, says: "Gold is about to break up again (from \$329) to \$360-\$370/ounce in weeks rather than months." From Cambridge, John Cunningham at Investment Research says the failure of heavy selling to materialise during the ascent to above \$320

puts the market "in a new phase, with \$400 a distinct possibility this year."

Others are more wary. Alan Baker at the bullion house of Sharps Pixley told the *FM* that the physical offtake which provided gold with resilience when the dollar was soaring is slowing down. "We have seen no real evidence yet of additional interest in gold other than reaction to the dollar. And until the downward trend is broken at between \$350-\$360 there is a danger of a retreat to \$300. Yet I think we are seeing the beginning of a new movement. I feel the dollar's troubles are mounting in the US banking sector and the chances of a pull-back to \$300 look remote. We are friendly towards gold and are looking for a steady recovery."

By the same token the charts and forecasts look equally positive for currencies such as the D-mark and the yen. Emboldened by the US economic slowdown, weakening interest rates and the daily confidence-pricking reports of loan write-offs, bankruptcy and fraud from banks, savings institutions and government securities dealers, the weight of opinion has swung against the dollar. In spite of having been proved wrong by the market for nearly two years, there is no shortage of forecasters looking for the dollar to weaken to Dm2,80-Dm2,60 in the coming 18 months.

That does not rule out rallies in the short run. Roger Nightingale, chief economist at London brokers Hoare Govett, says: "The dollar's recent drop was primarily a response to the action of the Federal Reserve in turn-

ing on the money taps to restore confidence in the banking system after the Ohio savings and loan banks' crisis. In the past, the Fed has tightened up once the crisis is over. We believe, however, that a lot of US banks are in much worse shape than is realised and the economy is not growing as fast. The Fed may not have as much room to manoeuvre as last year after the rescue of Continental Illinois. By the third quarter when the US economy is moving towards a mild recession, we think the Fed will be under pressure to ease credit and the dollar will relapse."

David Morrison, currency economist at Simon and Coates,

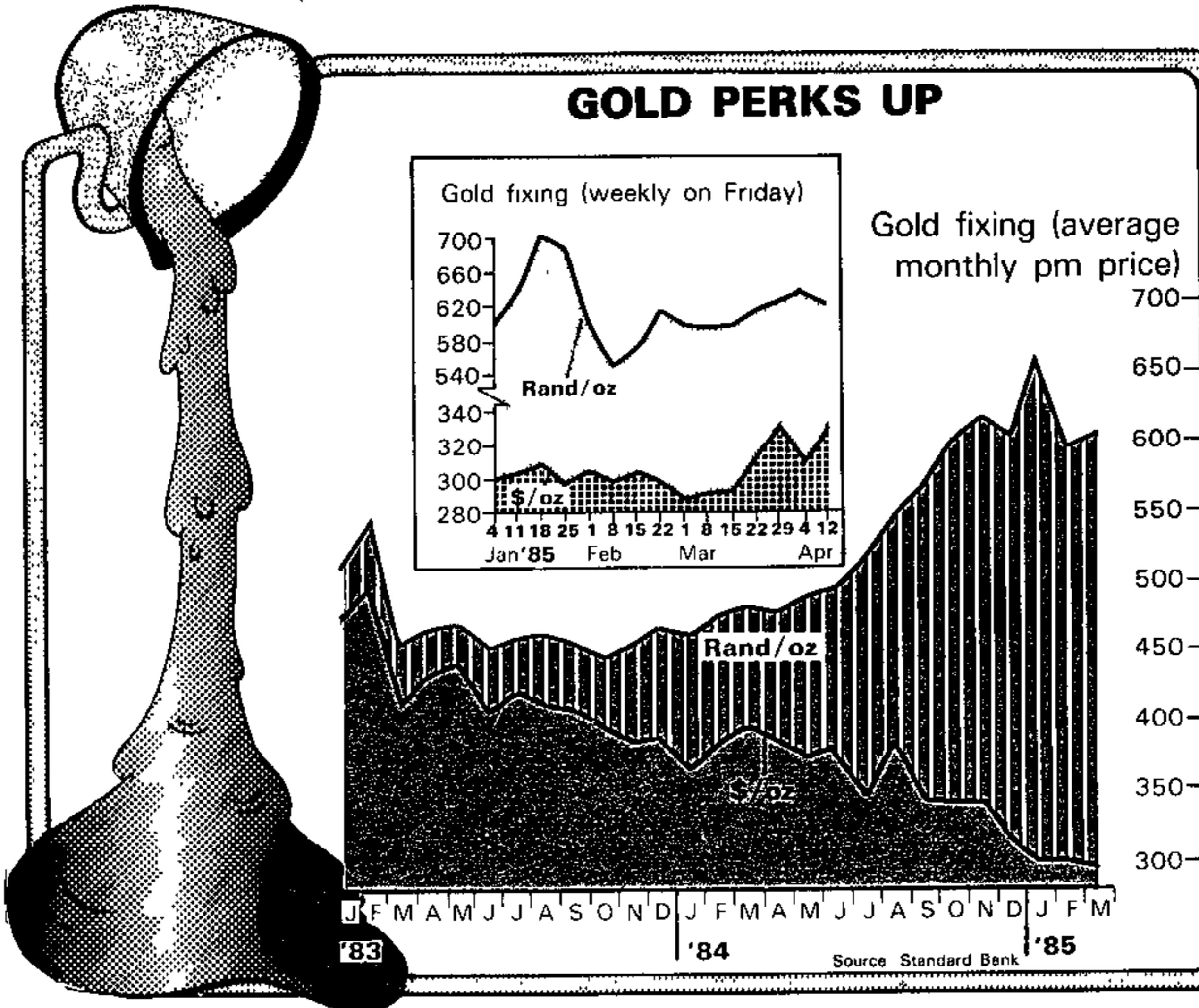

(74)  
 concurs, adding that "the gap between European economic growth and interests rates and those of the US will narrow. In addition, the Fed is paying more attention to complaints from US exporters about the dollar's exchange rate. The pace of the decline may slow but the dollar can easily come down another 15% against the D-mark."

If these predictions are borne out and if a notional "real" price for gold of around DM 1 000/ounce is accepted, bullion will have no difficulty in scaling what some see as a barrier at \$350.

Voices of caution about stale bull selling and a sharp increase in supply from newly opened mines in South America, Canada, the US and Australia do exist. The Gold Institute in Washington has forecast a 13% rise in production, or 192 t, to 1 633 t by 1987. Dr Fred Collender, precious metals consultant at Strauss Turnbull, however, says 150 of this will be seen this year. This may dampen the market although in the recent surge, according to London Metal exchange dealers, the Russians made a brief return as sellers — shifting 1,5m ounces in one day, which was absorbed. Collender thinks supply could dampen price rises but he also expects Japanese offtake, for example, to carry on upwards — imports increased 33% to 251 t last year. "Japan could

## GOLDS CLIMB

JSE Actuaries All-Gold index  
 — weekly close

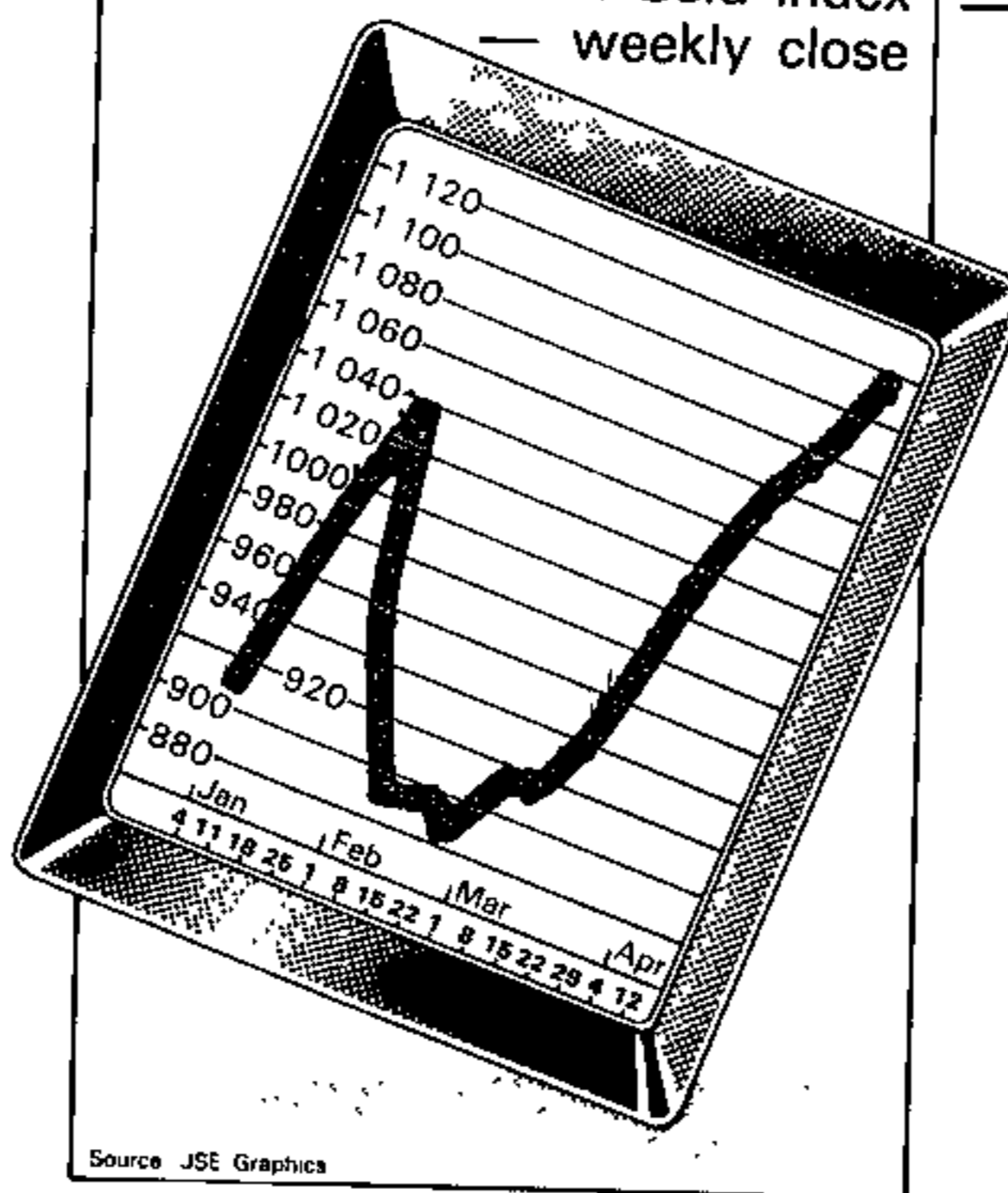

take around 340 t this year, nearly half South Africa's output," Collender tells the *FM*. "So gold might stay with the currencies in its dollar price before it starts to run away next year when new supply will be lower and American investors start anticipating the end of President Reagan's term in office."

Meanwhile, however, argument about what will shift the "real" price of gold, rather than simply adjust it to currency

changes, rests with the US investor. American investment analysts and bankers have become divided on the outlook for inflation. Some claim a fall in the dollar will inhibit imports and so remove some of the competition which has held down domestic prices. They fear the rate of inflation will climb to 6% (against the 1984 average of 4,3%) and point to the first quarter level of 5,4%, double that of the preceding three months.

In addition, Henry Jarecki, head of Moccatta Metals in New York, told the *FM*: "The increased interest we have seen in gold — helped by a substantial short position in silver — has mostly to do with the problems of the credit market. The whole question of bank loans to farmers is a problem-in-waiting. A lot more could come out of the woodwork. And if those things happen people are going to prefer real assets. I don't think there is any way to really tell whether we are moving into a bull market for gold but things could turn around quickly."

A new analysis of the gold market, however, offers the confident assertion that factors which will push bullion to \$400 in the next 12 to 18 months are beginning to gel. *Forecasting the Gold Price: The Critical Role of Investors* (published by Commodities Research Unit, London, Price \$17 500) concludes that the metal's function as a finan-

## BULLISH VIEWS ON DIAGONAL STREET

Gold shares stopped being depressed by the low gold price more than a year ago — but it seems the converse doesn't apply.

Since gold rebounded firmly above \$320 last month, JSE investors have returned enthusiastically to the market, mopping up shares almost across the gold boards and pushing some to new 12-month highs. Led by strong demand for quality counters, the All Gold index climbed from 849 on February 11 to close at 1 140,5 on Monday.

Overseas investors, particularly the US gold funds, have supported the market for months. Harold Shapiro, a partner at leading JSE arbitrage broker Max Pollak and Freemantle, estimates that foreign buyers have accumulated SA golds worth way over R1 billion since November 1983, and their interest has quickened this month.

"When gold went below \$300 people said they would sell and that would drag the market down. That didn't happen," he says. "But local institutions kept off-loading their shares into overseas demand. Now the institutions have run their gold holdings down to low levels and we are left with a shortage of stock." Martin's Winston Floquet notes: "We've got overseas buying orders here as long as your arm which we have had difficulty in executing."

For nearly a year, the rand has made gold shares cheap for US investors, while giving the mines a high effective gold price — \$630 this week — and boosting cash flows and dividends. Present share prices discount a price of about R650/oz. But much depends on your perspective. It is arguable that on a two-year view, the shares are still attractive.

Certainly, Diagonal Street is generally bullish on bullion. As Simpson Frater's Dixie Strong notes, the US's huge federal deficit will eventually swing the gold market. "The Americans will have to choose. They can finance the deficit from an inflow of foreign capital, which would send interest rates soaring and undermine the recovery. Or they can finance it internally, which would lift inflation off again. Either way, the idea of the dollar as a safe haven is finished."

Already some institutions have turned tentative buyers of the shares. Given the scrip shortage, now more severe than ever, a full-scale re-entry could push prices sharply upwards. Even individuals entered the market last week, giving analysts still more confidence that we are in a new bull market. Private buying was concentrated on the traditionally lightweight stocks, including Villages, Rand Leases, Vlaktefontein, Egoli, and Simmers.

Not that the market is suddenly all optimism — some say they turned decid-

edly nervous last week, pointing out that the shares have simply sprinted too far ahead of the gold price.

Since the low point in February, the All Gold index has risen 34%. But apart from its one-day move to \$340, the gold price has gained little more than 10%-12%. For the next week, the approach from professionals may be cautious. The general view is that it would not be at all surprising to see a short-term correction in the shares.

Any weakness in gold would quickly trigger profit-taking. "Charts show short-term weakness in the gold price and the shares," says McKie's chartist Hannes Boshoff, "although it looks more and more like we might be in a new bull market." As Floquet points out, however, the worrying factor is that this bull market would be starting when the shares already stand at all-time highs.

But provided that gold continues to consolidate around \$325-\$330, or better still, moves higher, any set-back could well be temporary. Indeed, local analysts say they would buy into any price weakness. Right now, the bulls are supported by several arguments — their expectation that the gold price will go up, positive technical indications from chartists, the scrip shortage and the more favourable sentiment that in recent weeks has visibly brightened JSE trading.

Andrew McNulty

(19) FM 19/4/85

## THE US VIEW

As readers can note elsewhere in this issue of *FM*, the collapse of the American government securities market and the schism between the Federal Reserve and the US Treasury makes for uncertainty in already uncertain times.

Small wonder, then, that gold has reacted so vigorously to world market beliefs that the American central bank has moved to a more expansionary monetary policy, with at least one objective being the reduction of key dollar exchange rates among the leading US trade partners.

But is this a watershed? Is this the turning point that marks gold's long comeback after a four-year exile in the wilderness?

The answer insofar as leading US gold experts are concerned is clearly no. Wall Street is rejoicing in gold's renewed vigour, but no one is rushing to unload dollar positions just yet.

Take Jeff Christian, who heads Goldman Sachs's precious-metals desk. "The

Ohio S and L crisis said something about how rapidly the market can turn and how worried international investors with heavy dollar positions are, but the US economic recovery still has a way to go. Recent statistics show that low inflation, rising income and other indicators point to at least a moderate growth by mid-year," he told the *FM*.

The bottom line for gold and the dollar?

"We don't think the dollar's upward move is over. From our long-term perspective, we think that the overriding fundamentals have not changed for gold either."

Washington-based gold and Fed-watcher Thomas Wolfe is a bit more optimistic about gold. "The jump in gold and drop in the dollar of the past weeks cannot yet be considered as indicators of basic directional changes. The fundamentals that have moved gold and the dollar over the past couple of years are still

there. The surprisingly volatile recent market reactions, however, strongly suggest that when the turn comes, for gold in particular, it will be a vigorous one," the ex-Treasury official told the *FM*.

But while the fundamentals have remained the same, one thing has changed dramatically: Wall Street these days is recommending gold as an investment after a very long hiatus indeed.

"Many people who participate in precious-metals markets, both dealers and investors, had been writing obituaries for gold and the metal as an investment vehicle and practically had given up the ghost," says Jeffrey Nichols, head of Precious Metals Advisory Inc, a leading Wall Street service. "But last week the cadaver got up and walked around and a major reassessment of market attitude occurred.

"The resulting shift in the gold price was of far greater impact than the actual events which sparked the rise."

cial asset, and alternative investment, still overrides fundamentals of supply and demand.

Its author, Mike Lenhoff, tells the *FM*: "It is investors' perceptions of the future that really matter." Lenhoff says the key factors now beginning to work through are: a depreciating dollar; an upturn in inflation ("6% in the US is not unrealistic;") a weakening

equity market on Wall Street as American economic activity slips; and a gradual rise in interest rates. "You won't have to get inflation up very much to see investors moving out of dollar assets as their real returns decline.

While institutions and sophisticated investors will look to hedge their portfolio values through currencies and non-dollar paper,

Lenhoff says: "There is a large and powerful group of private US investors who have now accepted the concept of gold, especially the Kruggerrand, as an alternative." Not even divestment can alter that.

Forecasts are forecasts and nothing more. But it does seem clear that after a long cold night, the climate and the sentiment towards gold is warming. ■

## FARM PRODUCE PRICES

# A system out of control

(3) Control boards  
~~(3) Marketing~~

SA's agricultural marketing system has largely failed. It is characterised by price spirals that outstrip many other consumer price-increases, entrenched rigidity, and a vast array of rent-seekers who depend on the weakness of the system.

Given that the total value of capital investment in farming amounts to nearly 40% of gdp, this is a serious situation indeed.

Production of the country's most vital consumables — red meat, maize, dairy products, wheat and sugar — is given protection of a nature that verges on Iron Curtain socialism: fixed or minimum prices (regardless of the level of production or demand), regular price increases (argued not on the basis of yield but of farm input cost inflator, or import parity when the rand is weak) and one-channel marketing systems.

There are few direct rewards for efficiency, innovation, flexibility or entrepreneurship — nor do market forces impact freely to force prices down in cases of surplus production or falling demand. Probably the worst

**Like most countries, SA's agricultural system consists of farmer-politicians, ever-rising prices, mountains of surpluses (or costly shortages) and never-ending appeals for financial help. The fundamental problem is the administration of some control boards under the Marketing Act, and the guaranteed prices it offers for most agricultural produce.**

example of how a farm price mechanism can be manipulated is the current discussion on the maize price increase. After red meat, maize is SA's most valuable farming commodity.

Last season's maize price increase of 30% to R220/t was justified on the grounds of "exceptional" drought disaster and the severe debt predicament of many farmers. Now government is considering a request by

maize producer body Nampo, and the Maize Board, to hoist the price another 23% to R270/t — based on "production cost increases."

It appears that last season's "official" cost-of-production figure of R277/t, calculated by the Department of Agricultural Economics and Marketing (DAEM), was based on information supplied by Nampo itself. An informed source tells the *FM* this figure was calculated on crop assessments for specific agro-economic areas in the maize belt. This patently lacks the stamp of scientific authority.

The DAEM's annual "weighted" assessment of increases in maize production costs, based on a 15-year index-plus average for the whole maize belt, gives a figure of only R221/t for the current season. And if the requested hike to R270/t is granted, the cost of maize will have increased by 77% over the past three years.

Meanwhile, sugar and wheat growers are producing crops that will far exceed domes-

# What good is gold?

79

for Sowetan

13/5/85

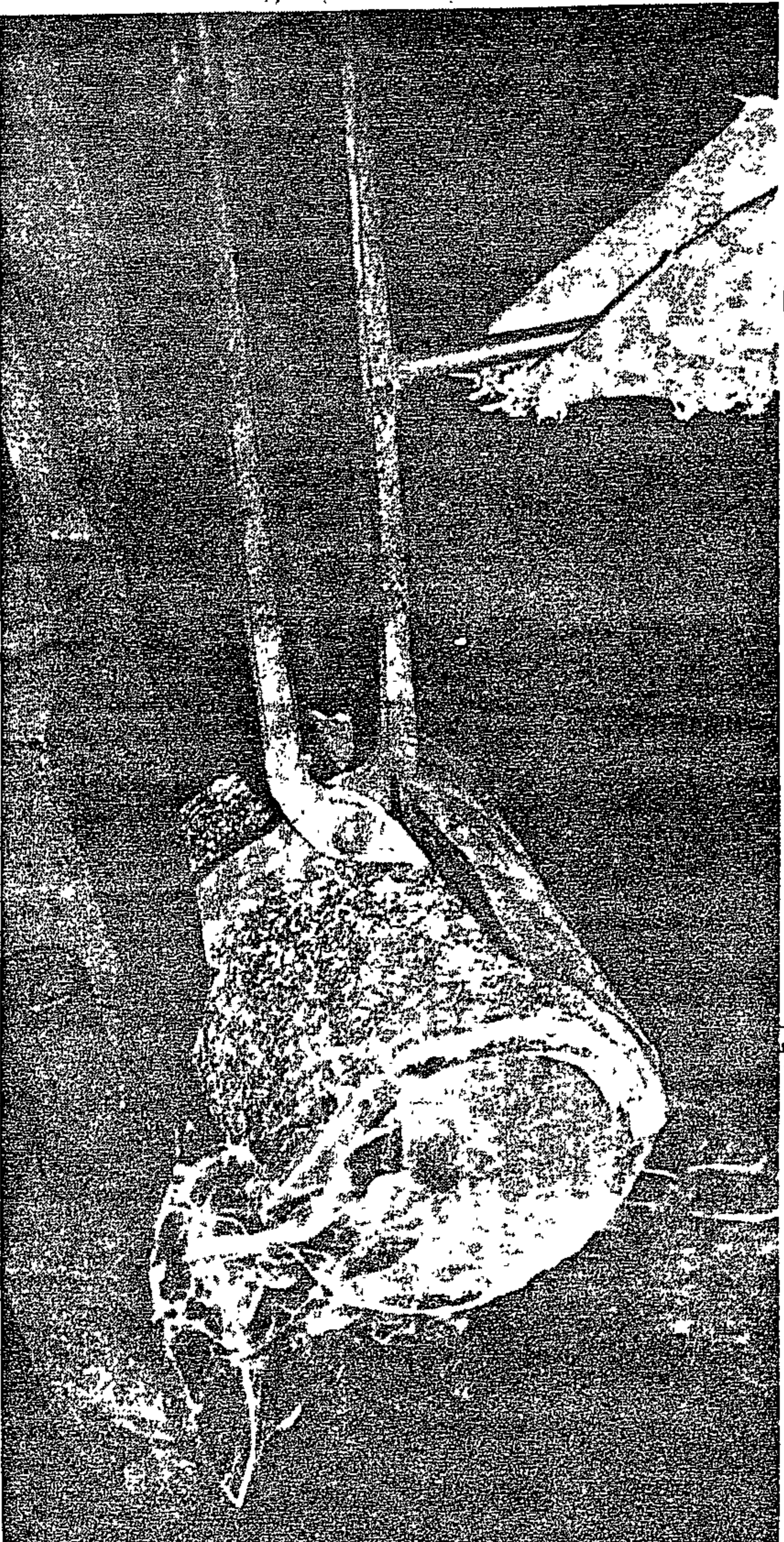

POUR: A crucible of molten gold is being poured into a slipper mould at a refinery in the Transvaal.

EVERY day in South Africa and all over the world there are people carefully watching the gold price. And every day on the inside pages of newspapers all over the world details of the gold price and gold share prices are given. Only when there is a very sharp movement in the gold price, do editors think it is necessary to put this information on the front page. But for South Africa, gold is the most important single commodity and the quality of life of all of us depends in one way or another on its price.

Most economists agree that gold is not as important as it was, say, 30 years ago. Our whole mining industry makes up only about 10 percent of total economic activity, compared to 20 percent in 1960. And this includes their products. Timber products, exports are crucial to the country.

Gold is the biggest earner of foreign revenue in South Africa and its industry - the mining industry - among the largest employers in the country. Graham Bell group economist for Gold Field of South Africa, takes a look at the mineral and tells us what makes this metal tick!

humans ever since the year dot. Because of its colour and special qualities (soft, non-rusting) it has a special value which has driven men to extreme acts. Since gold was first discovered thousands of years ago no more than

9 cents per ounce against R620 per ounce for gold. The first recorded gold production in South Africa was in 1884 when 74 kilograms was mined. The amount increased steadily over the next 80 years until 1970 when peak produc-

tion produces about 60 percent of the total gold mined in non-communist countries. Communist production is dominated by Russia which mines 200 to 300 tons per year. What is this magical metal used for? The most common use of gold is in jewel-

ry sales in Turkey were about equal to France's (17 tons) while sales in the Philippines were equal to those in Iran (3 tons). Another important use is in electronics. In this industry gold is used in very small quantities for switches, connec-

coal, platinum and diamonds which are also big.

**Jobs**

But gold mines still employ over half-a-million people, 90 percent of whom are blacks. The number of jobs in gold mining has risen by over 3 percent per year since 1975, much more than in the private manufacturing sector. Salaries and wages in gold mining now amount to nearly R3 000 million per year. Many manufacturing companies are dependent on gold mines for sales of

heavy engineering goods, transport equipment are all used in large quantities. Escom provides a tremendous amount of electricity to gold mines. All the companies providing these goods also employ large numbers of workers. If the gold industry was to stop working tomorrow the industrial heart of South Africa would beat very weakly.

There is one area where gold is still as important as ever. Today gold accounts for about 40 percent of total exports from South Africa. And strong

**Price**

In the past few years the gold price has fallen sharply which has helped to put severe strain on the economy. An obvious effect has been the very high level of interest rates. One of the most important influences on interest rates is the flow of money in foreign currencies (the dollar, pound etc) into South Africa.

If this flow is weak interest rates rise because there is less money around. With the fall in the gold price less foreign money has come in. However, over the next year or so there is a good chance that the gold price will rise a bit and this will help to lower interest rates again.

Gold is a strong commodity which has fired the hearts of

100 000 tons have been mined. Compare this to copper, for example, where 7 million tons are mined every year. The difference is that copper sells for

ton of 1 000 tons was mined. Since then there has been a decline to just under 700 tons last year. Despite this decline, South Africa still

of gold is in jewelry manufacture. Gold jewellery is very popular all over the world—in both developed and developing countries. For example, in 1983 gold jewel-

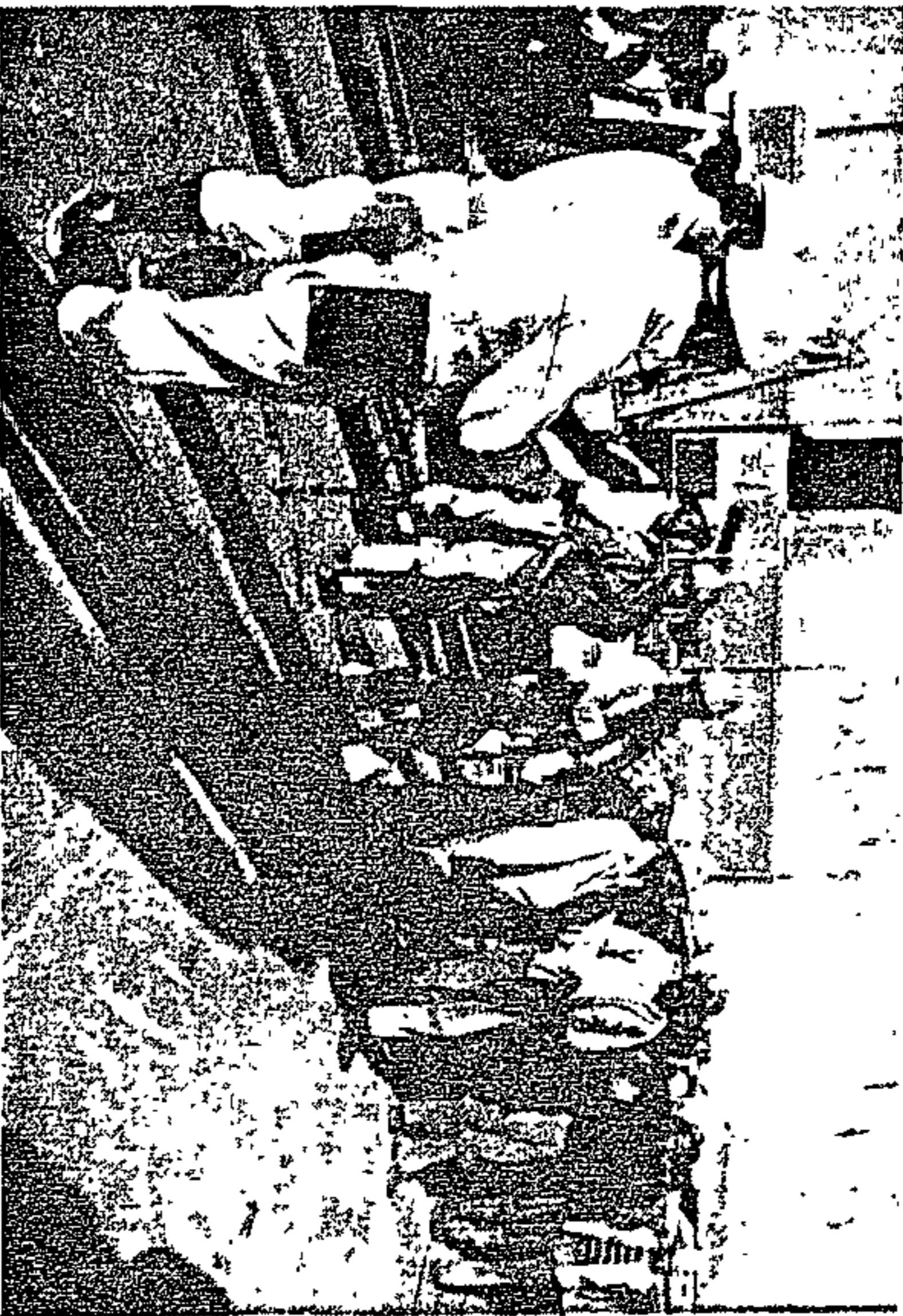

**UNDERGROUND:** Miners prepare to go underground at one of the mines on the Witwatersrand.

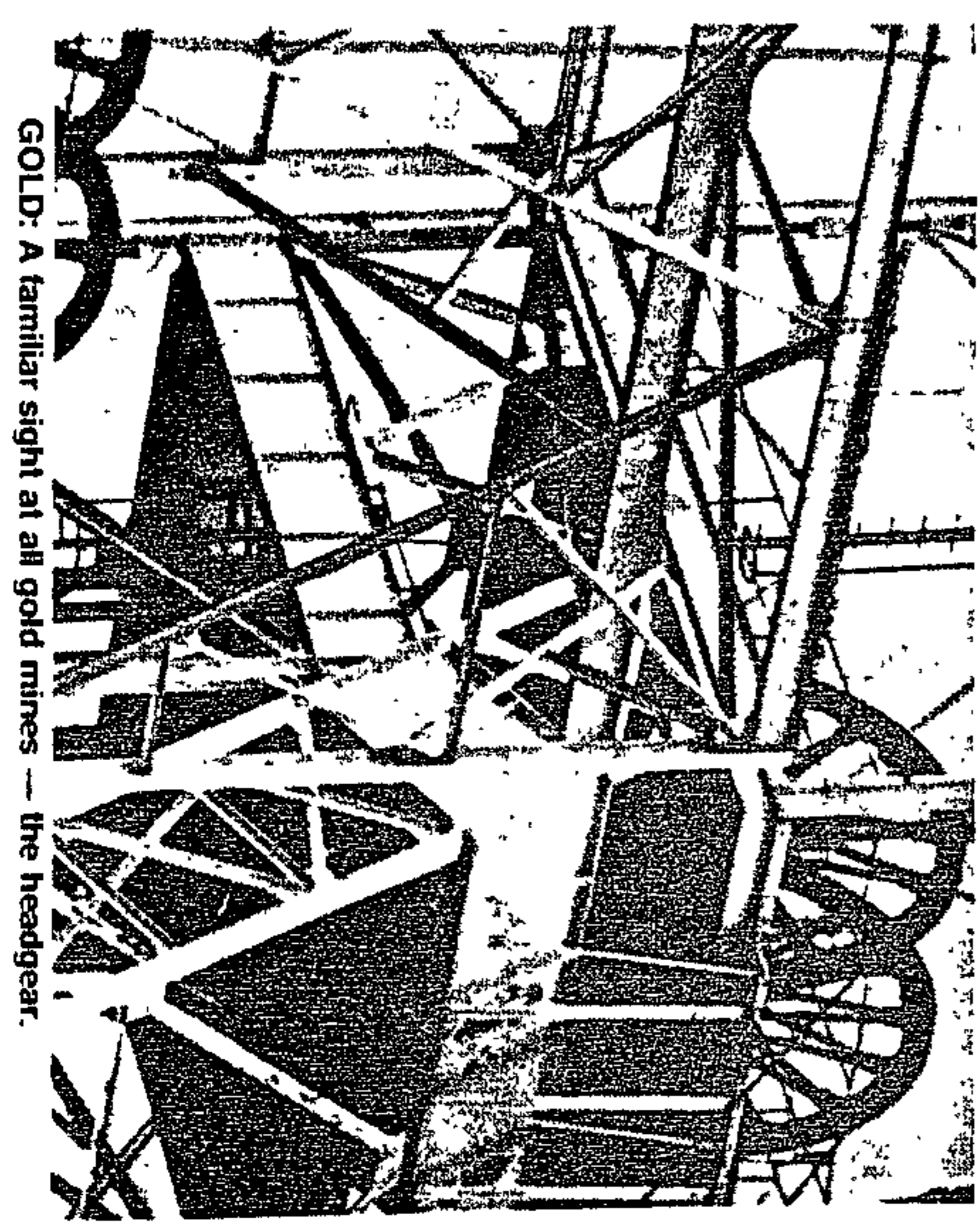

**GOLD:** A familiar sight at all gold mines—the headgear.

**Wadeville Toyota**

**THIS MONTH'S SPECIAL**

**Hi Ace 2000 18R Motor**

- Clutch Plate: ..... R52.00
- Pressure Plate: ..... R76.00
- Thrust Bearing: ..... R10.00

**Genuine Toyota Parts.**

Cut out this advertisement and bring it with you to obtain these reduced prices.



**Wadeville Toyota**  
The family business

Osborn Road, Wadeville, Tel: 827-5524 827-5675  
Delema Road, Wadeville, Tel: 827-0349

**TOYOTA**

35001

switches, connectors and solders. There is gold in computers and video recorders which are selling in very large quantities all over the world. Japan is very big in electronics and uses more gold in this industry than even the United States.

Every year about 50 tons of gold is used by dentists to fix teeth. This is particularly popular in Germany where about 16 tons were used in 1983. Gold is also used for decorative purposes on glass and ceramics. The final use of gold is very important. Every year investors all over the world put some of their money into gold. They buy gold bars or coins and hope that the price will go up and make them richer.

Gold is traditionally a way of protecting yourself from rising inflation. When inflation is high the value of paper money falls, but the gold price is usually strong.

These days in the major economies inflation is quite low (only three percent in the US, Japan and Germany) so the need to invest in gold is low. However, there are always some people who buy gold just in case.

**JOHANNESBURG—ANXIOUS investors and gold dealers reacted with shock in Johannesburg and London last night hours after South Africa's biggest Krugerrand and gold coin dealer was voluntarily placed under provisional judicial management.**

In an urgent application to the Rand Supreme Court, the South African Gold Coin Exchange applied to be put under provisional judicial management in order to take pressure off the business and solve its cash flow problems.

There was an immediate stampede late yesterday by clients of the company, and those of other gold dealers whose metal dealings were channelled through the exchange and who are 'exposed' by the possibility that the exchange could be put into liquidation.

The order was granted to Mr Elias Levine's coin exchange to stave off provisional liquidation by anxious clients.

In papers before the Supreme Court, the exchange was said to be solvent but facing liquidity problems.

Mr Levine said in his application that any move to provisionally liquidate the exchange would 'be destructive to the orderly marketplace in which the exchange has 20 percent in ordinary Krugerrands and 70 percent of proof Krugerrands'. It would have interrupted the evaluation of proofs, he added.

Mr Levine said he believed that given the opportunity to carry on with its operations under a provisional judicial manager, the exchange would be able to overcome its present problems.

The Court papers emphasised that 'proof Krugerrands of customers of the exchange, which have been lodged with the exchange for whatever purpose, are presently all in the possession of the exchange in safe keeping, as was intended at the time of the lodging of the coins with the applicants'.

**Main source**

One concerned gold dealer said last night 'My clients are telephoning every five minutes to find out the situation and we've got no clarity on just what it means'.

Within hours the news had spread to London gold dealers who said they had heard the exchange was in difficulty and that it had been their main source of proof Krugerrands in which it's chairman, Mr Levine, specialised.

The coins are so rare in London at the moment that they are trading at around R140 above the normal market rate.

Rumours about the financial position of the exchange have recently been spreading, said Mr Levine, and might have led to an application for its provisional liquidation.

# Order gives jitter gold

Handwritten scribble

Handwritten scribble

Handwritten scribble

NM 18/5/85

Mercury Correspondent

T A SOLUTION  
N YOUR CRITIC

PART  
FULL  
ARE Y  
TICK

Yesterday's application to court was brought by the directors of the company. They include Mr Levine's son, Leo, Miss Adele Levine, Mr Carlot Ferreira and Miss Lynette Rice.

The return day of the rule nisi is June 25 when it will be decided whether to place the exchange under final judicial management.

NO YES

BOX

# Bullion likely to maintain \$300-level, Consgold says

LONDON. — Gold prices will continue to be dominated by the dollar's trends but exaggerated price movements are unlikely and bullion should not fall below \$300 an ounce, Consolidated Gold Fields says in its annual gold market review.

The forecast is based partly on 1984 trends, when the market experienced an "excellent year in terms of the physical demand for gold".

The emphasis for price determination had shifted away from investment potential and toward the supply-demand outlook.

Controlled inflation and low oil prices, reinforced by a strengthening dollar, overwhelmed resurgent physical demand last year and gold slumped, ending \$75 down on the year.

Fresh gold supplies in 1984 reached 1 439 tons, up 7 percent from 1983's revised total of 1 347 tons.

Non-communist mine production rose to 1 149 tons from 1 112 tons in 1983. Sales from the communist sector rose sharply to 205 tons from 93 previously, but official sales declined to 85 tons from 142 in 1983.

But with new gold supply lagging fabrication and hoarding by 115 tons in 1984, the supply-demand relationship should dictate market direction, given weak investor sentiment.

Although mine production had risen steadily since 1980, the rate of increase was slower in 1984 than 1983.

## INFLATION

South African output continued to dominate total world production but at 683 tons against 680 was below 60 percent, Consgold said.

In spite of a higher rand gold price in 1984, the South African industry faced difficulties, with costs in rand terms outpacing

the inflation rate. Inflation was expected to rise further this year and this had already led to higher wage demands.

But with some mining areas being developed, offsetting the closure of older operations, production would be maintained at current or slightly higher levels, the review said.

Canadian gold output rose to 81 tons from 73 in 1983. If prices improved the trend was likely to continue and output may reach 100 tons by 1987.

Preliminary figures indicated US production in 1984 at almost 72 tons, up 11 tons.

Since 1980 US output had risen from 30 tons, a rise of 137 percent.

Brazilian production fell to an estimated 55 tons from 59 tons. The Brazilian gold rush had encouraged many companies, few with mining experience, to enter the gold sector though many may soon become discouraged.—Reuter.



# The gold price impasse

79

S. Day

5/6/85

Mike Brown is Economic Consultant at Davis Borkum Hare & Co Inc.

## WORLD GOLD MARKET 1970-1984

	1969	1970	1971	1972	1973	1974	1975	1976	1977	1978	1979	1980	1981	1982	1983	1984*	1985*
<b>Primary Gold Supplies</b>																	
1) Western World	1252	1274	1236	1177	1111	996	946	964	962	972	959	952	973	1023	1088	1135	1200
2) Communist Bloc	-15	-3	54	213	275	220	149	412	401	410	199	90	280	202	92	120	120
Total	1237	1271	1290	1390	1386	1216	1095	1376	1363	1382	1158	1042	1253	1225	1180	1255	1320
<b>Industrial Gold Consumption</b>																	
1) Jewellery	907	1066	1064	999	508	216	516	937	1004	1004	728	126	595	715	598	807	920
2) Other (Including Coins)	293	310	324	345	337	508	458	447	422	591	589	418	438	358	404	385	405
Total	1200	1376	1388	1344	845	724	974	1384	1426	1595	1317	544	1033	1073	1002	1185	1325
% Industrial Consumption/ Primary Gold Supplies	97	108	107	97	61	60	89	101	105	115	114	52	82	88	85	95	101
Average Gold Prices \$/oz	41,09	35,95	40,80	58,13	97,20	159,14	161,06	124,80	147,72	193,38	307,14	612,76	459,89	375,89	423,68	360,58	

Source: Consolidated Gold Fields

\* Estimated

**T**HE DISMAL performance of gold during the early years of this decade has opened a chasm of doubt amongst the international investment community. Was the golden decade of the Seventies something of a flash in the pan?

Gold's demise over the past few years stems from the impressive strength of the US dollar in world currency markets and the generally low level of inflation in the major international economies. A contributory factor has been the poor performance of all commodity prices. In this connection, there is little doubt that the sobering influence of potential raw material blackmail by Opec in the Seventies has hardened the attitude of the major economies to dependence on minerals as an intermediate product in vital production processes.

It is perhaps of more relevance to regard the previous decade, and its soaring commodity prices, as an aberration. After some 25 years of more or less stable currencies, with the fixed dollar/gold relationship as the fulcrum, it was probably inevitable that the subsequent currency realignment would cause many investors to choose gold and other hard currencies as an alternative to the dollar. Equally un-

avoidable was the fact that there were, of course, many other factors behind rising US inflation in the Seventies.

The Opec-inspired oil price rises of 1973 and 1979 not only sparked off a supply scare explosion of most mineral prices, but also created the uncertain economic conditions in the Western world that encouraged the demand for gold as a hedge against potential catastrophe.

**T**he turbulent period of economic adjustment subsequent to the breakdown of the Bretton Woods Agreement created abnormal conditions for gold price appreciation and the more settled economic scenario of the present decade has not unreasonably forced a major correction in the gold price.

In conjunction with the broad picture outlined all too briefly above, certain specific factors have contributed to the weaker gold price performance.

During the fixed price of gold era, the gold price was more or less similar in most currencies around the world and subject to little change. This stable currency framework naturally inspired industrial consumption of gold (as the gold price fell in real terms), but inhibited gold production and made investment in gold unattractive, except in anticipation of an eventual demise or adjustment in the fixed gold price/US dollar parity.

Subsequent to the suspension of convertibility of the dollar into gold in 1971, and the ensuing regime of floating exchange rates, the gold price has showed considerable diversity in various currencies. Accordingly, the attraction of gold, for both investment or industrial consumption purposes, tends to vary considerably depending on the currency in which it is being transacted.

For instance, since January 1983 the gold price has declined by some 30% in Japanese yen but has fallen by only 15% in the deutsche mark. Accordingly, the industrial demand for gold which exhibits strong price elasticity — i.e., demand increases as the price falls and vice versa — has grown far more in Japan than in West Germany.

The strong dollar has ensured a

low gold price in dollars but a high price in most other currencies where regional consumption of gold has been strong in the past, thereby adversely affecting the global industrial offtake for gold.

Equally, the relative volatility of currency movements — mirrored by the price of gold reflected in such currencies — has destroyed much of the reputation of gold earned over previous decades as a "stable store of value".

The currency turmoil of much of the early Seventies, plus the oil price shocks and the evidence of structural weakness in the banking and financial system — i.e., the Herstatt banking problems — induced sufficient volatility in the gold price to attract the attention of speculators as opposed to the longer-term investor.

Speculators in their turn promoted even more fluctuation in the gold price. Trading orientated mechanisms were introduced in the gold market, such as futures markets, geared trading positions, metal accounts and electronic trading, which facilitated a significantly different gold market to that of previous decades.

Inevitably, speculators bid up gold prices in 1973, 1974 and 1980 to levels where physical consumers — i.e., the industrial market and the "traditional" investment offtake — were forced off the market to a significant extent. The long bear trends in the gold price (1975/1976 and 1981-1985) had their roots in the need for gold to adjust to a level where industrial offtake and long-term investment position takers were able to absorb the available supplies of gold reaching the market from primary sources.

A number of studies have been undertaken into the price-elastic behaviour of gold, all of which have confirmed gold's elasticity, but no consistent elasticity function has yet been determined.

**A** broad conclusion can, however, be drawn from admittedly somewhat sparse statistics on the supply and demand for gold. The significant rise in gold prices during the Seventies — from \$35 per ounce on average in 1970 to more than \$600 per ounce in 1980 — a 16-fold increase — has caused a severe lag in the market's advance as it struggles to adjust to the price

elastic induced reduction in demand for the physical metal and the rise in supplies encouraged by the higher gold price.

In this respect the gold market has much in common with the oil price, and the early years of this decade have been characterised by declining prices for both commodities in response to supply overhangs.

The table above shows the relationship between the physical consumption of gold (industrial users plus coin fabrication) and the primary supplies of gold from world production. All investment transactions have been excluded.

The statistics indicate that bull markets in gold tend to be associated with a relatively low offtake of physical gold expressed as a percentage of total supplies. Periods when the physical offtake exceeds or closely approximates supply from primary sources tend to be associated with the early years of upward gold price cycles. Cases in point were 1970 and 1976, where the gold price fell from the previous year, but physical demand rose because of the price elasticity of gold's demand function, and these years marked the troughs of the gold price cycle.

**I**n late 1984 and to date in 1985 it would seem that physical supply and demand are increasingly coming into balance and in the process helping form a bottom for the gold price. Gold bullion dealers report that gold is tending to trade on its own fundamentals and less in response to changes in investment variables.

This is, of course, good news and raises hopes that, after the traumatic years subsequent to the last gold price peak in 1980, gold may now be in a base-forming phase. After the inflationary aberrations of the previous decade, the demand for gold may now finally have adjusted to prevailing economic circumstances, thereby, holding the promise of more stable price conditions ahead.

The improving fundamental supply and demand picture, at best, will provide only a lower support level for gold. Further enhancement of the gold price from current levels will depend on the underlying investment climate for

the yellow market. The foremost factors in the investment market for gold are the external value of the US dollar and the not unrelated trends in US inflation and real interest rates.

The weakness of the US economy in the third quarter of 1984 and the first quarter of this year stemmed predominantly from rising US demand for imports. This brake on US activity will continue as long as the dollar sustains current levels, and it seems not unlikely that a fall (probably in the region of some 20%) will be required to both promote US exports and to reduce the competitiveness of foreign products.

Although the US dollar is in a long-term bull trend, which could continue for the rest of this decade, a major correction is required to offset the trade imbalance which could become structural if not treated soon.

**A**ccordingly, it is probable that a correction phase is already underway following the February decline in the US dollar, and this correction phase could last some six months to a year.

The downward adjustment in the dollar to a level which would ensure a more comfortable competitive position for US domestic producers will, in turn, provide an "investment window" for an improvement in the gold price as part of the general currency realignment that should take place. Inflation in the US may also be given a push by the acceleration in US money supply over the past eight months, the potential for a lower dollar and relatively full employment, which will boost wage demands.

In assessing this scenario, it must be emphasised that neither a major downward slide in the US dollar nor a lasting rise in US inflation is foreseen. At most, a short-term correction in the present strong dollar/deflationary bias in the US economy is anticipated. These factors, taken in conjunction with the improved fundamental position, indicate that the outlook for the gold market looks more promising at present than has been the case for some time. The gold impasse may, therefore, not turn out to be a dead end.

# SA gold shares decline on world markets

From NEIL BEHRMANN

**LONDON.** — South African gold shares have been falling on international markets because of the United States disinvestment campaign, the threat of a miners' strike, sporadic riots and disappointment over the gold price.

Since the end of May, the Financial Times index of gold shares in dollar terms fell 11 percent to 549 points.

But with the pound appreciating sharply against the dollar, the fall in sterling terms has been much greater.

The Financial Times index of gold shares tumbled 18 percent to 398 points. This poor performance has been in the face of a steady gold price which has traded between \$310 and \$320.

American brokers who refused to be quoted on record said that there were large offerings of shares from United States funds. The fund managers were selling in anticipation of redemptions, say the brokers.

They also believe that there have already been redemptions by the public because some people fear that Congress will interfere with their right to hold South African shares.

The funds which were massive buyers of stock in 1983 and 1984 were not dumping shares. But if they found buyers they would willingly part with them.

The shares were being absorbed by South African institutions.

Gold shares in Johannesburg, however, have also been relatively weak.

With gilt yields tumbling from a February

peak of 17.8 percent to 15.2 percent, the action has been in fixed income securities and industrial shares.

Mr David Ridley, partner at brokers Williams de Broe Hill Chaplin, contends that there were less sales than were rumoured.

Mr Ridley believes that some American brokers took advantage of the United States disinvestment campaign to generate business.

The institutions phoned up various United States funds, believes Mr Ridley and offered to place lines of shares for them.

Rumours multiplied when inquiries were made on the Johannesburg Stock Exchange.

Other brokers say that large lines of gold, and platinum shares were sold.

This, they say, is reflected in the Business Day gold share index which has slid six percent since the end of May.

There were also sales from disenchanted United Kingdom fund managers who were disappointed with the performance of gold at a time of considerable

dollar weakness.

The sharp appreciation of sterling pulled the FT Gold Index to the lowest levels since 1982.

Mr Norman Kessel, head of mining research at brokers Vickers da Costa, recalls that United States funds were behind the dramatic increase in gold shares in the past few years.

He says it is "significant" that the funds have stopped buying but with continual reports of violence emanating from Johannesburg and the vocal disinvestment campaign in the United States, he is "hardly surprised".

The strength of currencies against the dollar hardly helped European stockmarkets either.

The Financial Times Industrial Index has dropped by nine percent, from its peak, although a cut in interest rates yesterday pulled the market up from its lows.

In the past three days, Germany's share averages have tumbled by seven percent, partly because shares were overbought but also on worries that exports would decline.

Carl Timp  
12/7/85  
79

# Gold spurts to \$322,25

By PAUL DOLD  
Financial Editor

FEARS over President Reagan's health pushed the gold price to \$321,75 at the late fix in London yesterday, which could signal a new rally for the depressed gold share market. The morning fix was \$316,80.

In Zurich where gold closed at \$322,25 dealers said that short covering in the United States led to the rally which took bullion through two important chart points.

Gold came off again at the close in London and Zurich suggesting the firmer trend may not be maintained.

In London gold shares eased again in spite of the higher bullion price.

The rand could firm further today if gold's rally is sustained. The currency closed at \$0,5265 yesterday.

The stockmarket ended the day quietly before the spurt in the gold price but there were several significant features.

Welgedacht soared 230c to 710c after the Witbank offer and Rusplat continued to climb adding 60c on earnings expectations.

D & H which has been a firm spot in recent weeks put on another 40c. Kanhym rose 40c to reach the R3-mark, while other shares which firmed included Aurochs, Highveld, Malbak and Trust Bank.

Lastly note that a premium arising on consolidation will represent an application of funds, while a reserve constitutes a source. When partly owned subsidiaries are acquired, the minority interest at the date of acquisition will also represent a source of funds.

Gold, rand  
shine in <sup>AREUS</sup>  
the gloom <sup>23/7/85</sup>

Financial Editor <sup>(18)</sup>  
<sup>(79)</sup>

DEVELOPMENTS in the bul-  
lion and currency markets to-  
day should help to sweeten for  
many South Africans the sour  
taste left by the declaration of  
the state of emergency at the  
weekend.

In early trading in London  
today the gold price jumped  
\$4.75 to reach \$323,00 an ounce.  
The metal is now at one of its  
highest points since early June.

The rise in the gold price fol-  
lows a sharp drop in the dollar  
last night on fears about the  
outlook for the United States  
economy.

#### IMPROVEMENT

The weaker dollar and high-  
er gold price led to an im-  
provement in the exchange  
rate of the rand.

It jumped by just over one  
US cent at the start of trading  
today to reach \$0,5330. This is  
about four US cents above its  
year's low and restored it to  
the levels prevailing in March.

On the Johannesburg Stock  
Exchange gold shares began to  
recover some of yesterday's  
losses, brokers said.

Industrial shares were also  
slightly firmer.

Cape Times 25/7/85 (79) 80710027X

# Foreign investors sell gold shares

By PAUL DOLD  
Financial Editor

SOUTH AFRICAN gold shares fell on the London and Johannesburg stock exchanges yesterday as foreign investors sold gold shares in reaction to a slightly weaker gold price and the state of emergency.

While the decline in the Johannesburg gold index was not large — probably around five percent — the easier trend was marked by the market's blue chip gold mining shares (favourites among foreign investors) falling across a broad front.

The easier trend continued in after-hours trading last night with

selling reported from both London and New York.

Official volume again did not appear heavy — overall turnover at R37,4m was little changed from the previous day.

Vaal Reefs, Harties, Kloof and Randfontein all closed lower but industrials held up reasonably well although the market index was down on the day.

Gold closes at \$327,25<sup>79</sup>

CMR Tanks 30/7/63



LONDON. — Gold closed at \$327,00-\$327,50, up from the day's opening of \$322,10-\$322,60 and Friday's closing \$318,25-\$318,75.

But the market ended below its highest levels since mid-April reached earlier in the day at \$329,75-\$330,25, possibly due to profit-taking, dealers said.

Dealers said the metal gained initially on the dollar's weakness and some follow-through buying interest from Friday.

A further rise on the New York market, on technical factors, provided additional strength.

Gold was fixed in the afternoon at \$326,50 after a morning fixing of \$323,00.

In Zurich, gold closed at a three-month high, benefiting from the diversification out of the dollar by international investors, dealers said.

The metal finished at \$326,50-\$327,00 and rose further in after hours trading to touch \$330.

Dealers said much of the trading remained professional, with quotes being adjusted to compensate for the falling dollar.

But turnover picked up after a quiet morning, and gold rose even in Swiss francs, in spite of the franc's gain against nearly all currencies yesterday.

The price for a kg gained 200 francs to 24 000-24 300 francs and added 50 francs more after hours — Reuter

In London, sterling was again the high flyer on currency markets yesterday in spite of a fall in British interest rates, and dealers said it seemed set for more gains this week, especially against a soft-looking dollar.

The news that British commercial banks were again cutting their key base lending rates by half a percentage point had been widely expected after the Bank of England last week signalled that it would welcome lower costs for credit.

"But even with base rates at 11 1/2 percent, sterling still offers a very pretty return," one dealer noted

Closing gold prices

(In \$ an ounce)

LONDON:  
327,00-327,50  
Fixing am: 323,00  
Fixing pm: 326,50

ZURICH:  
325,00-328,00  
— Reuter

SEAFRESH FISH



1195	John Cenene b/m Port Elizabeth
1196	Pumzile Mbonda b/m Port Elizabeth
1197	Melville Mkofo b/m Port Elizabeth
1198	Gladman Nhanhaha b/m Port Elizabeth
1199	Vuyi Dusi b/m Port Elizabeth
1200	Jeery Sambokwe b/m Port Elizabeth
1201	Anthony Heers c/m Port Elizabeth
1202	Liman Saki b/m Jansenville
1203	Bennet Mdima b/m Jansenville
1204	Mayville Dlamini b/m Benoni
1205	Joseph Motokeng b/m Benoni
1206	Petrus Nyama b/m Benoni
1207	Steven Khumalo b/m Benoni
1208	Thomas Maleke b/m Benoni
1209	Job Sehlaré b/m Vanderbijlpark
1210	Abraham Dabi b/m Vereeniging
1211	Suleman Khota b/m Vereeniging
1212	Nazira Yamed a/m Vereeniging
1213	Maknobane Letsatsi b/m Vereeniging
1214	Graham Joseph c/m Steytler
1215	Collin Nappies c/m Steytler

The name of the person is their race, sex and the magistrate in which they were arrested.

COCO  
Tel. 451311 at the de Waal Sun.  
With dressing from Ouma's range  
All in all an excellent light  
tasteful, low in calories and  
price.

Kenilworth PHONE 71  
TOTTILLS  
ape Town ONE 21 2421

ARGUS 6/8/85

~~77~~ ~~78~~ ~~79~~ ~~80~~

# Miners' strike threat unsettles gold market

Argus Foreign Service

LONDON. — Gold dealers are nervously watching events in South Africa to see whether the strike threat by black miners will give the gold market the fillip they have so long awaited.

For months gold has been a poor investment. Even sales of the Kruger rand have suffered so much that marketing agents have stopped publishing monthly sales figures.

While gold rose a little in London yesterday to \$323,50 an ounce, Kruger rands of one ounce were only one pound higher on Friday's price at £239,88.

The apparent indifference of the market largely reflects the view that a strike, if it comes, will not last long.

## HIGHER YIELD

Dealers point out that a strike would have to be prolonged before it affected supplies enough to move the price.

What worries the market is the political conditions which the miners appear to be attaching to their claim for a 22 percent pay increase.

Ironically, bad news could be good news for investors. Lower share prices mean that the yield — the percentage a dividend is of the share price — will rise. Political worries could so depress share prices as to make the shares attractive again.

In Zurich Swiss bankers see little chance of an immediate price boom because of the planned strike, reports Reuter.

Gold dealers and economist said there was scope for a price rise in the medium term, but only as deterrents to investment — low inflation and high real interest rates — recede.

They saw good chances for a revival of the currently quiet market once investment in stocks and bonds became less financially attractive.

"After the strike news I had expected to have some orders. But there is just no interest," a dealer at a major Swiss bank said.

ARGUS 16/85  
**Rand  
wavers,  
but gold  
up \$6**

Finance Editor

THE rand tumbled more than six US cents to a new low of \$0,3900 in confused trading when the foreign exchange markets opened today, but it quickly recovered much of its loss and by mid-morning was at \$0,4325.

Dealers said the amount of business transacted at \$0,3900 was probably small. They attributed the low rate to buyers holding back to see what effect President Botha's speech would have on the market.

The speech was seen as a let-down but a \$6 spurt in the gold price on the weak dollar to \$336 an ounce — its highest point since last November — helped to reduce negative reaction.

#### UNCERTAINTY

On the international markets the dollar has fallen against most major currencies. This, with the higher gold price and the improvement in the balance of payments, should have led to the rand rising to around %0,55. That this has not happened can be blamed entirely on political uncertainties.

● The rand dropped 10 per cent against the British pound today to a new low

At noon Barclays Bank was buying pounds at R3,41 and selling at R3,52

Yesterday its rate was R3,08/R3,17.

● The Argus Political Staff report from Durban that the Minister of Finance, Mr Bar-end du Plessis, said today that the drop in the rand was temporary.

In an interview Mr du Plessis said the reaction was "emotional, caused by the great expectations that were created about the President's speech".



ARGUS 20/8/85 79

## Gold at \$335.50,

GOLD was fixed at \$335.50 (R811.36) an ounce in London today, down from yesterday's London close of \$338.75, Reuter reports.

The rand was quoted at \$0.4135 in Johannesburg today, after closing at \$0.4175 yesterday.

The bullion price has increased steadily since the beginning of July and it was mostly higher on world markets yesterday. On the New York Commodity Exchange last night, gold inched up 20 US cents to close at \$338.10.

Mr Jeffrey Nichols, president of American Precious Metals Advisers Inc in New York, said one factor in gold's recent rebound was fears that unrest in South Africa would disrupt world supplies.

But a more important factor was a decline in the dollar, which has made gold a more attractive alternative, he said.

The American dollar turned in a mixed performance in quiet, trendless activity yesterday, drifting in a narrow range as traders awaited further evidence on the course of interest rates and the economy in the United States.

Investors were waiting for a government report today revising earlier estimates of overall US economic growth in the second quarter.

Only a sharp revision, either up or down, from last month's estimate of 1.7 percent growth would be viewed as important.

By the end of the trading day in the United States, the dollar was quoted at 236.675 Japanese yen against 236.66 yen late on Friday. The British pound sterling nudged up to 1.4020 dollars from 1.39925 late on Friday.

● In London the free market price of platinum pulled level with gold for the first time since mid-1984, continuing its sharp rally on concern over unrest in South Africa.

Platinum jumped nearly \$20 by early afternoon to be quoted at \$340.50 an ounce, level with gold. It closed at \$321 on Friday when gold ended at \$339.15. In early July platinum traded at more than \$50 an ounce below gold.

Dealers said a wave of buying in Europe, including large investor demand, sent prices higher in volatile trading.

Platinum has risen more sharply than gold in recent weeks because it is more susceptible to fears of disruptions to South African supplies.

South Africa mines up to 90 percent of the non-communist world's platinum but only around 60 percent of its gold.

# UK gold study disputed

CLAIMS by a London stockbroking firm, that the gold production of Canada, America, Australia and other western mines would almost match the South African output by the early 1990s, have been firmly rejected by the president of the SA Chamber of Mines.

The brokers, Laing & Cruikshank, forecast in an extensive report that gold production in South Africa would stagnate in the next five years, regardless of any possible strikes on the mines.

"Western gold output, other than South African, will rise from 384 tons last year to 477 tons in 1987 and should reach 568 tons around 1991," said Ian Wright, author of the study and mining consultant at Laing & Cruikshank. He estimated that South African production would decline slightly from its present level of about 625 tons and that production in Canada would rise from 71 tons last year to well over 114 tons by 1989. There would be sharp production increases in Australia, the US, South America, and Papua/New Guinea, he predicted.

## FASHION

"We believe that gold and gold-related assets are about to return to fashion," Wright said, but western production would increase to his estimates, even if the gold price stabilised between \$320 and \$375.

South African gold production fell from a peak of 1 173 tons in 1965 to 625 tons last year, said Wright. But with other producers mining more gold, western world production could rise from 1 006 tons in 1984 to 1 108 tons in

NEIL BEHRMANN  
and ROY BENNETTS

1987 and jump to about 1 193 tons in the early 1990s.

The report estimated that the Soviet Union would sell about 99 tons a year.

Wright said that SA gold shares' potential dividend yields were better than in the aftermath of the Soweto riots. His calculations were based on regression analysis.

Wright favoured quality producers such as Hartebeestfontein, Buffelsfontein, Southvaal and President Steyn.

## SCEPTICAL

Chamber of Mines president Clive Knobbs regarded the overseas gold production claims sceptically.

Knobbs said that a gold mine was often claimed overseas, based only on sufficient deposits, to warrant the start of production, but that research into the ore reserves generally left much to be desired.

Canadian, American and Australian gold mines tended to be of a small scale, and with minimum starting-up costs, said Knobbs.

This had the effect of producing over-optimistic calculations, and it must be remembered that they did not have uniform reefs like South Africa, but recovered their gold from smallish, low-grade and erratic deposits.

Prospecting for commercial gold in most overseas countries was very different from the requirements in South Africa, and tended to project a

rather distorted picture, said Knobbs.

Figures released by the Department of Mineral and Energy Affairs, showed that in 1983 this country produced nearly 48% of the world's gold, with the USSR claiming almost 19%, Canada 5%, China 4%, the US 3.5% and Australia 2.3%.

The Department stated that last year South Africa produced 681 tons, the highest figure since 1979, with Vaal Reefs gold mine alone recovering 81 tons compared to Canada's total production of 70 tons.

In this period the West Wits Goldfield alone produced nearly 20% of the free world's gold.

South Africa also led the world in gold ore reserves with 20 000 tons, or 51% of total, with Russia second at 7 776 tons and the US at 3 110 tons.

## Henkel goes public

BONN — Henkel, the family-owned West German chemicals group best known for Persil washing powder, said yesterday it would offer shares to the public for the first time in its 109-year history.

The country's fourth-biggest chemicals producer will sell 1.5-million shares on German stock exchanges in early October. Banking sources estimate the issue could raise almost DM400-million in new capital.

The long-rumoured flotation, decided at a secret weekend meeting of family shareholders, makes Henkel the latest in an illustrious line of family-owned West German companies to recently allow in outside investors. — Sapa-Reuter.

World's most popular gold coin hangs on

# Rivals mount bid to topple Krugerrand

LONDON. — Angels, Eagles, Maple Leafs and Pandas have one thing in common — all are potential rivals to the Krugerrand and hoping to cash in on attempts to restrict sales of the popular South African gold coin.

They might well soon be joined by an Australian contender (perhaps to be known as the Kangarand?).

## Biggest

The Angel is the name of the new gold coin from the Isle of Man and the Eagle is the proposed American coin. The Maple Leaf comes from Canada and the Panda from China.

So far, the Krugerrand remains by far the biggest seller, accounting last year for an estimated 2.6-million ounces out of world sales of 4.2-million coins. It has been a hugely successful way of selling extra SA gold, at a premium, since it was introduced in 1970.

More than 50-million ounces (about 1 200 tons) of gold have been sold. Krugerrands account for 15% of SA gold production, and have enlarged the market by making it possible for investors with limited resources to buy gold

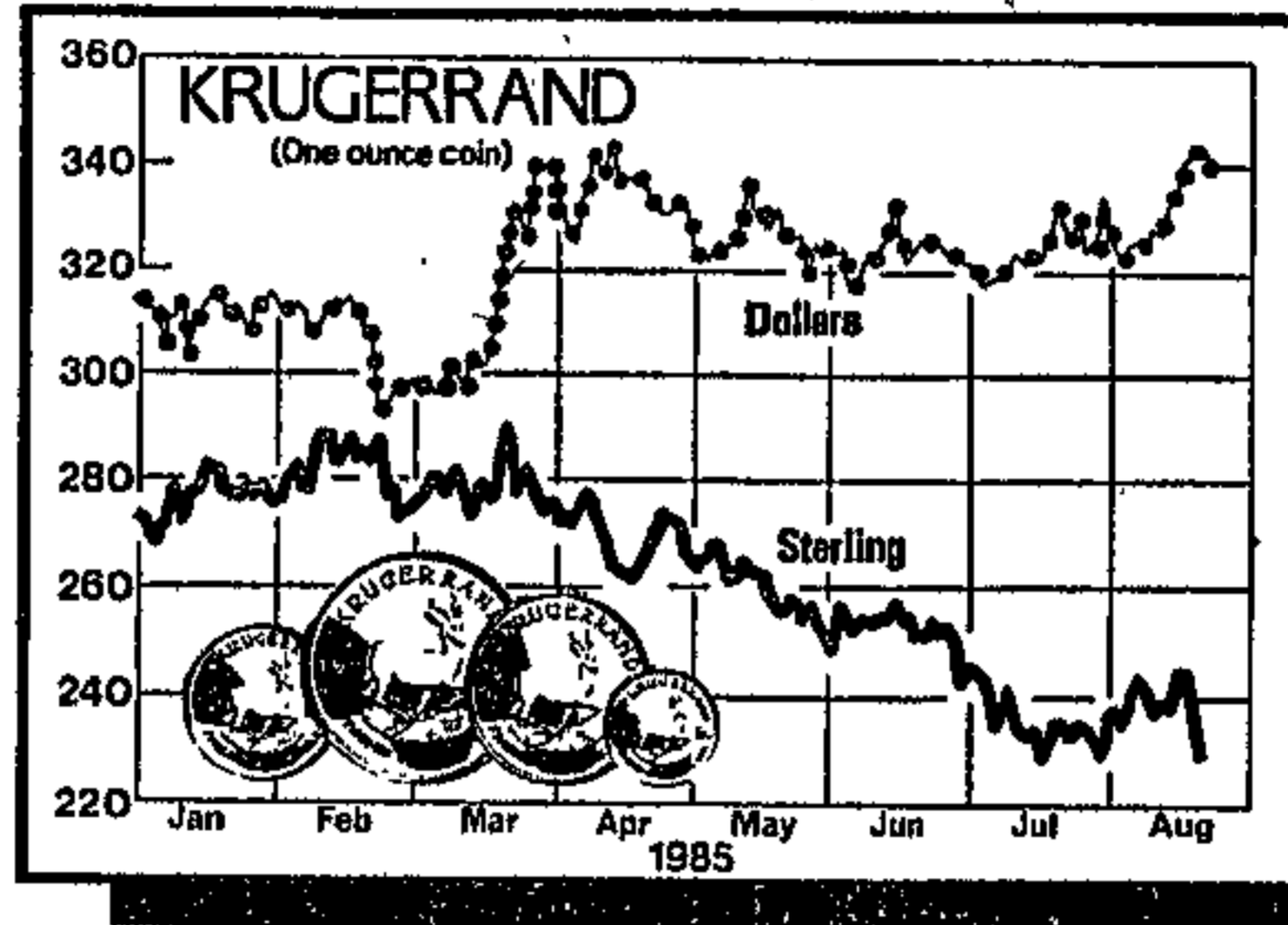

in small quantities in an easy and convenient way.

This success story might, however, be coming to an end because of the threat of a US ban on importing Krugerrands and the Australian Government's decision to do so.

## Depressed

The International Gold Corporation, marketing arm of the Chamber of Mines, stopped issuing monthly sales figures for Krugerrands in May, so it is hard to say how badly they have been hit.

Sales were already well down by May, reflecting the depressed state of the gold market generally. But it is known that the Maple Leaf

has been making tremendous inroads in the US.

The Royal Canadian Mint hopes Maple Leaf sales will top 1.5-million ounces this year compared with 1-million ounces in 1984. It plans to boost sales in the Far East and Europe.

In Britain, according to dealers, there has been no great rush from the Krugerrand into other coins, although there has been some selling pressure from institutions. They are worried that the coin's premium over the gold price, charged to marketing, will shrink as a result of surplus coins becoming available from the drop in American sales.

## Schemes

British dealers on the retail end, selling to the public, say there has been little change in buying habits, partly because the overall market has been so dull. According to Gold Investments in London, the imposition in 1982 of value added tax (VAT) on gold coin sales in the UK virtually killed the market and wiped out many smaller dealers.

Although there were perfectly legal schemes to avoid paying VAT, in places like the Channel Islands or Gibraltar, and never actually taking possession, buyers were not satisfied with merely a piece of paper to prove their holdings. Most small in-

vestors like to have something to show and hold themselves, says Gold Investments.

Sharps Pixley, the London bullion broker, agrees that investors normally want possession of the coin, which is "portable and anonymous". Offshore storage schemes are viewed as being cumbersome and unsuitable for investors not wishing to become involved in paperwork.

## Strengths

Peter Shaw, of Cavendish Shaw, says there has been no dramatic decline in Krugerrand sales and he doubts whether there will be. However, demand is better for some other coins, such as the Maple Leaf.

His company has started selling the Panda — an attraction of which, at one-20th of an ounce, is its suitability for the jewellery trade in making earrings.

Mr Shaw is confident that in spite of the VAT problem, demand for coins will rise when the gold market picks up — which is only a matter of time.

## Assurance

One of the great strengths of the Krugerrand is that it is easy to buy and sell at known prices from a wide network of outlets, ranging from the clearing banks to brokers and specialist dealers.

Intergold says this vital two-way market will remain intact, whatever the US Government decides to do and that the Krugerrand will continue to have a strong future outside the US.

However, the entry of a host of rival coins can be expected to intensify competition in a market showing signs of recovering as inflation fears start to revive.

If the gold price does take off as the pundits predict, hoarding of coins might well return to favour even though it is a sterile investment, providing no interest or dividends. — Financial Times.



SA may  
SWOP  
gold for  
currency

BY PAUL DOLY  
Financial Editor

SOUTH AFRICA may swop gold for foreign currency, the Reserve Bank Governor, Dr Gerhard de Kock, said in New York last night.

"We're aware that we could easily swop all our gold if we wanted to," he told a press conference.

Dr De Kock said he had visited a number of major New York banks to explain the technical implications of a standstill declared last weekend on repayment of South Africa's foreign debt.

He had been very courteously received, but declined to comment when asked whether the banks had indicated a willingness to reschedule.

Meanwhile, the rand slid to below 40 United States cents again yesterday amid little Reserve Bank support for the currency.

At one stage the rand

To Page 12



From page 79  
fell to nearly 37c but later recovered to 42c only to come off to below 40c in late trading.

The rand's fall has been partly caused by the sudden resurgence of the dollar and there was a shortage of dollars in the local foreign exchange market yesterday.

The renewed weakening of the rand came as a shock to financial markets as investors had anticipated the Reserve Bank would mount a strong support role following the reopening of the foreign exchange market.

Speculation swept the market following Nedbank's failure to gain permission from the Reserve Bank to repay foreign investors who had deposited funds with the group's overseas branches.

Nedbank said in a statement yesterday that it would have had no problem in meeting foreign obligations if the Central Bank had allowed it to do so.

"Nedbank is not in trouble. We would have no problem in meeting our obligations if it weren't for the freeze," a spokesman said.

There was also speculation in Europe that the Reserve Bank planned to once again close the foreign exchange markets following the rand's renewed fall. This was later denied by the Reserve Bank.

London dealers said yesterday that there had been an over-reaction.

"I see no reason for the South African authorities to panic and I see no reason for the rand to fall much more," one dealer said.

79

ARGUS 18/8/85 (79)

## Gold at \$326,25

THE rand recovered strongly after Wednesday's nosedive, and climbed to \$0,3870 in Johannesburg today.

The American dollar fell in New York as currency dealers mulled over the meaning of new reports on US economic activity.

Gold held steady, and was fixed at \$326,25 an ounce in London today, slightly down from last night's London close of \$326,50.

Dollar selling was prompted by figures showing America's GNP grew at a 3,3 percent annual rate in the third quarter.

London gold fixings were:

	Dollars an ounce	Rands a kg
10.30 am	324,60	27 248,60
3.00 pm	325,50	27 324,15

CAPE TIMES 26/11/85

# Gold surges through \$330

From NEIL  
BEHRMANN

LONDON. — Gold surged through \$330 because of dollar weakness and fears that United States inflation will accelerate.

In morning trading the dollar dropped below 200 yen for the first time in five years, but recovered above the crucial barrier in later trading.

The United States currency weakened against the Deutsche mark, Swiss franc and British pound.

But the commercial rand remained weak because there was still uncertainty about South Africa's foreign borrowings.

Foreign exchange traders say that the market is very thin. The dollar fell without any central bank intervention, because the banks have decided to push it lower, said a foreign exchange trader.

The yen was particularly strong because the Bank of Japan has been pushing up interest rates.

The yen has appreciated by 21 percent against the dollar since the Group of Five central banks began intervening late September.

Dealers believe that the dollar will continue to weaken. But they are not betting on a collapse.

They said that central banks have been very successful in curbing dollar appreciation, so there is no reason why they should not be able to support the dollar if necessary.

The United States wants to see a lower dollar, but with the Deutsche mark down by 26 percent from its February peak and the yen 25 percent lower, the central banks have achieved their objectives.

After falling sharply in the past two months, United States interest rates are expected to stabilize.

Inflation is accelerating slightly in the United States and dealers believe that the Federal Reserve Bank will become very cautious about the growth in money supply.

8:50 AM 3/12/85  
**US coin to compete  
with the Krugerrand**

WASHINGTON — The US House of Representatives passed, and sent to President Reagan, a Bill authorising the US Treasury to mint gold bullion coins in competition with the Krugerrand.

The Bill authorises the minting of gold coins in four sizes, including a one-ounce coin with a face value of \$50, a half-ounce coin valued at \$25, a one-quarter-ounce coin valued at \$10 and a one-tenth-ounce coin valued at \$5. — Reuter.



**Gold shares <sup>BUS DAY</sup> tumble  
in uncertain market**

(79) Mervyn Harris 3/12/85

**GOLD** shares tumbled on the JSE yesterday as selling pressure mounted in a market racked by uncertainty and nervousness.

The JSE all-gold index plunged almost 50 points to 1 136,3. The index has shed more than 10% since reaching an all-time peak at the beginning of last week.

Dealers attribute the softer undertone of the market to profit-taking and investor concerns over the failure of gold to respond to the much weaker US dollar.

● See Page 13

# Gold and shares plummet as battered rand hits new lows

The embattled rand continues to set new lows against major currencies with the situation exacerbated by a minor recovery in the dollar on world foreign exchanges.

The rand is quoted against the dollar at 36,20 US cents, against sterling at R4,16 and at 73,50 to the yen.

A slight recovery by the dollar after weeks of easing sent the gold price tumbling yesterday and the metal lost nearly \$3 to around its current \$323 level.

These factors combined to put added pressure on the already weak rand.

On the stock market investors took fright and virtually all sectors plummeted with golds and other minerals particularly hard hit. The all market JSE index lost 27,9 points yesterday to 1275,5.

● See Page 26.

# Congress says yes to US gold coins

STAR 3/12/55  
79  
285

WASHINGTON — Congress yesterday passed and sent to President Ronald Reagan a bill allowing the Treasury to mint its first gold bullion coins in more than 50 years, in competition with the Krugerrand.

The Bill authorises minting of gold coins in four sizes: a one-ounce coin with a face value of \$50; a half-ounce coin valued at \$25; a one-quarter ounce coin valued at \$10; and a one-tenth ounce coin valued at \$5.

Final action came when the House of Representatives passed the Senate Bill on gold coins by voice vote.

Mr Reagan banned imports of Krugerrands on October 1 as part of a series of US economic sanctions against South Africa to protest against apartheid. The order did not affect the sale of Krugerrands already in the United States.

South Africa said on November 13 it was stopping production of Krugerrands.

Supporters of the bill said it

would give coin collectors a choice and a chance to show their opposition to apartheid.

"This bill will let Americans and others vote with their pocketbooks for a gold coin symbolising liberty and democracy," Ohio Republican Mr Chalmers Wylie said.

Last year, Americans bought about \$600 million worth of Krugerrands and another \$400 million of gold coins from other countries, including Canada and Mexico.

## GOLD STANDARD

The coins would be available for sale by 1987. They would be the first US gold coins minted since 1934, when the United States abandoned the gold standard.

Supporters of the bill said it should not be seen as a step towards returning to the gold standard. Gold for the coins would come from domestic mines and would be purchased at the world price. — Reuter.

# Business Day

THE NATIONAL NEWSPAPER FOR DECISION MAKERS

**SALES & SERVICE**

**JOHANNESBURG**  
**CRISTO CORP**

Auckland Park • Brackenford • City (Cargomul)  
 Illovo • Kew • Northdelf • Norwood • Resebank

DMAM J7208/1e

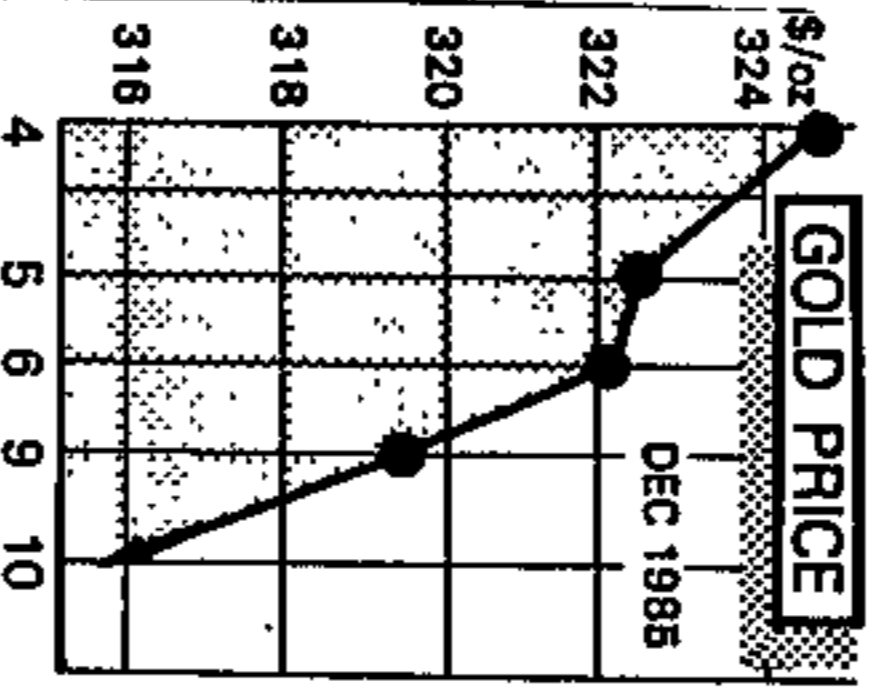

## Oil has gold and silver over a barrel

Bus Day 11/12/85

**LONDON** — Falling oil prices continued to undermine gold and silver in London and New York yesterday — although the rate of decline in the precious metals slowed.

The exception was platinum which steadied at \$324/oz after a selling deluge on the New York Mercantile Exchange hammered the price down by \$21.30/oz. Gold, however, slipped another \$1.50 to \$316.25/oz in London while in early trading on New York's Commodity Exchange

**Business Day Correspondent**

futures prices were a further 70c off. The February contract stood at \$319.10.

Silver's slide went on after its slump through \$6/oz.

In London, spot silver fell 15.5c to \$5.81/oz, the New York price for March delivery was another 5c lower at \$5.88. The cause of the precious metals woes

— oil prices — fell again. North Sea Brent blend crude for January delivery hit \$25.50/barrel, a fall of more than \$2 since the Organisation of Petroleum Exporting Countries revealed it was no longer prepared to keep cutting output to support crude prices.

This completely reversed a five month rally which had lifted prices as refiners rebuilt depleted stocks for the winter. London bullion dealers said gold trading was quiet. Les Edger, of Sharps Pix-

ley, said: "We think \$316 may be a benchmark for gold but there has been only very moderate two-way business. Nobody is rushing to buy and investor interest is dead."

Few analysts were prepared to make short-term forecasts for the gold price.

An economist at stockbrokers Laurie Milbank said: "If crude goes to \$20 a barrel, we are looking at a 30% fall. That will completely destroy any incentive to invest in gold."

## COMPANIES

79 27/12/85 BUS-DAY

WITH two important mining developments on the cards in the Evander area, investors should consider the merits of Winkelhaak.

Although not an exciting share, it is a long-life mine with low costs, so it ranks as one of the better quality gold-mining investments.

The two possible developments are:

□ The Poplar gold project in the Leandra district, near Winkelhaak and Kinross mines, is expected to be announced next year. Feasibility studies have shown that the mine would be viable provided suitable financial arrangements are made concerning tax and mining rights.

The projected mine would mill 90 000 tons a month at a grade of 5,5g/t over a life of 20 years, with estimated capex of R500m. There is speculation that either Winkelhaak or Kinross could be used as a tax umbrella.

□ The Evander mines are likely to amalgamate for the same reasons as Anglo's Free State mines — rationalisation of control, with savings in costs; cohesive mining and local control, providing speedy policy decisions; and centralised services, resulting in greater efficiencies and cost advantages.

The opening of the Poplar mine could benefit Bracken if its mill is used, and Winkelhaak could also benefit if it is linked with the new mine on the financial side.

However, the Winkelhaak and Poplar areas are not next to each other, which could be an impediment.

In an amalgamation of mines, Winkelhaak is the largest and most profitable mine in the area,

# Winkelhaak an attractive share prospect

ADAM PAYNE

with major expansion under way.

The Winkelhaak board announced in October it had decided to go ahead with a twin-shaft system to the east of the existing lease area in the so-called fold-fault area.

The capital cost of the project is estimated at R259m in 1985 terms and R432m in inflated terms. The project is due to be completed in 1992, which suggests that the greater part of the work will be done in the latter part of the period.

The new No 6 shaft system is to be sunk with a main shaft 1 515m deep to exploit the eastern area. Although this area is disturbed geologically, some of the borehole values have been good, particularly towards the north-east in the fold-fault area.

The twin-shaft system should be in production by 1992 and will increase the total mill throughput from 200 000 tons per month to 225 000 tpm.

The R259m cost will be financed from retained earnings and production revenue earned from an early start of stoping from the shallower ventilation shaft (475m).

The impact on dividends is not expected to exceed R25m over the six-year construction period.

Phase 1 of the project — the immediate start of

sinking the ventilation shaft to the start of production — could be completed in the year to September 1987.

Mill throughput is expected to average 225 000 tpm from the beginning of the 1987/88 financial year.

London stockbroker James Capel expects total mill throughput to increase above the announced 225 000 tpm when production from the main shaft starts in 1992.

Capel's forecast for the next five years are:

Tons milled: rising from 2,43-million in the year to September 1986 to 2,5-million tons in 1987 and 2,7-million tons in 1988 through to 1990.

Grade: 5,7g/t in 1986 rising to 5,8g/t in 1987 and 5,9g/t in 1988/90.

Gold price in R/kg: R26 000 in 1986 and R22 500 in 1987 through to 1990.

Capex: R35m in 1986 and R45m in 1987, rising to R65m in 1988/90.

Available earnings a share (which have been smoothed): 450c in 1986 and 1987, dropping to 425c in 1988 and 1989.

While Capel considers there are more attractive investments on the gold board, including Randfontein, St Helena, Venterspost, President Brand, Libanon and Buffelsfontein, I consider Winkelhaak worthy of support because it is a quality, low-cost mine.

28/12/85 STAR  
Sweden  
smiles on  
SA gold

The Star's Foreign  
News Service

STOCKHOLM — South African gold has put the bite on Sweden's ban on apartheid imports — triumphing in the dentist's chair.

Swedes will continue to have South African — not Russian — gold in their teeth.

The Swedish Association of Dental Surgeons has forced the socialist government to allow South African gold to be used for filling teeth.

The association has extracted an undertaking from Foreign Trade Ministry officials who have issued special exemptions to gold trade dealers in Stockholm, allowing the import of 1500 kg of South African gold — worth R7,14 million — in 1986.

# Freegold expected to issue composite report

30/12/85 BUS DAY

79

BARRING the unlikely rejection by shareholders of the proposed Anglo American Free State megamine, Anglo's Free State companies have almost certainly issued their last individual annual reports.

In future, shareholders can expect a single report analysing the activities of the giant Freegold conglomerate, with holding companies Ofsil and Welkom mirroring the parent's results.

The pattern has already been set by Peter Gush, chairman of Anglo's Free State mines, in the latest annual reports.

Gush is also chairman of Free State Geduld (FSG), Western Holdings and President Brand, while Guy Young holds that title at Welkom and President Steyn.

Apart from individual items such as operating results and capital expenditure, the chairman's review is the same in each of the annual reports.

A tabulation of the four mines shows that almost R400m was spent on capex during the year to end-September, with another R435m planned for the current year.

Largest drain on revenue was President Brand, with R158m being absorbed by the production expansion programme, and a further R140m to be chalked-up in the current year.

The new 390 000-tons/month run-of-mine gold plant was the single largest project in the programme, absorbing R72,2m during the year.

To-date, this project has cost about R110m, and load commissioning is expected to commence in March next year.

## ROY BENNETTS

An amount of R40,5m was spent on the No 5 Shaft project, which reached its final depth of 2 199-metres in September.

This brings the amount so far spent on this project up to R174m, with commissioning scheduled for April.

During the year an amount of R11,4m was spent on black housing, the bulk of which was allocated to two new hostel blocks at the No 1 Shaft.

Production for 1986 is planned to increase by 2%, at grades similar to last year.

The vast Western Holdings complex spent R120m in capex last year, and plans to advance this to R165m in the current year.

Of last year's total, the Erfdeel project absorbed about R73m, Holding division R39m and Saaiplaas R8m.

A total of R305,6m has already been spent to date on the Erfdeel project and with the No 1 Shaft reaching a final depth of 2 253 metres during the year.

An additional R100m is to be spent on this project during the current year, with production scheduled to begin in the first quarter of 1987.

At the Holding division, the largest single project is the No 1B sub vertical on which R19,7m was spent during the year.

The No 3 Shaft system at Saaiplaas has cost R169m to date.

Gold production at Western Holdings is planned to decrease slightly in the current year, despite a budgeted increase in tons

milled.

Free State Geduld went R6m over budget last year, by spending R63m on its capex programme.

The mine accelerated work on the new No 10 Shaft, spending nearly R20m on this project during the year.

The No 5 Shaft system is now virtually complete, after a total outlay of R300m. Full production of 280 000-tons/month is expected to be reached at this shaft towards the end on-1986.

Capex for the current year at this mine is planned at about R59m. The bulk of this amount, R37m or 62%, is to be spent on the No 10 Shaft project.

FSG will continue with surface prospecting in 1986 to establish the viability of a potential new shaft system to the east of the No 2 Shaft.

In all, exploratory drilling, including prospect drives, is expected to absorb R2,3m during 1986.

President Steyn's capex bill for 1985 reached R57m but is likely to increase to R71m for the current year.

The No 4 sub-vertical shaft system remained the most important project during the year, absorbing R11m to bring the total spent to date on this development to R101m.

Production of ore at Steyn is expected to be increased by around 5,5% for 1986, mainly as a result of improved stoping operations and waste-washing tonnage.

Recovery gold grades are predicted to remain close to current levels.